

\* Refer to parts list on page 18.

In compliance with Federal Regulations, following are reproductions of labels on, or inside the product relating to laser product safety.

KENWOOD-Crop. certifies this equipment conforms to DHHS Regulations No.21 CFR 1040. 10, Chapter 1, Subchapter J.

**DANGER : Laser radiation when open and interlock defeated.  
AVOID DIRECT EXPOSURE TO BEAM.**



## CONTENTS / ACCESSORIES / CAUTIONS

### Contents

CONTENTS / ACCESSORIES / CAUTIONS.....	2	SCHEMATIC DIAGRAM .....	9
CIRCUIT DESCRIPTION .....	3	EXPLODED VIEW .....	16
ADJUSTMENT .....	5	PARTS LIST.....	18
PC BOARD .....	6	SPECIFICATIONS .....	Back cover

### Accessories

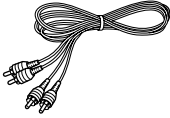
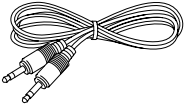
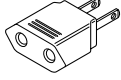
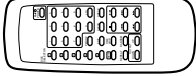
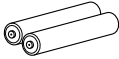
<p>Audio cord (1) (E30-0505-05)</p> 	<p>System control cord (1) (E30-2816-05)</p> 	<p>AC plug adaptor (1) (E03-0115-05)</p> 
<p>Remote control unit (1) (Except for CD-403/DPF-R3030) (A70-1339-05): RC-P0711</p> 	<p>Batteries (R6/AA) (2) (Except for CD-403/DPF-R3030)</p> 	<p>Use to adapt the plug on the power cord to the shape of the wall outlet. (Accessory only for regions where use is necessary.)</p>
<p>Battery cover (A09-0356-08)</p>		

### Cautions

#### Operation to reset

The microcomputer may malfunction (impossibility to operate, erroneous display, etc.) when the connection cords are unplugged while the unit is ON or due to an external factor. In this case, execute the following method to reset the microcomputer and return it to normal condition.

Unplug the power cord from the power socket and plug the power cord into the socket again.

## CIRCUIT DESCRIPTION

### 1. Microprocessor pin description : uPD780206GF059 (X32, IC15)

Pin No.	Pin Name	I/O	Description	ACTIVE	
				H	L
1	VDD	-	Power supply(+5V).		
2	LDC	O	Laser signal output.	LD: ON	
3	STBY-LED	O	STANDBY LED control output.		
4	MON	O	Control terminal of spindle motor(ON/OFF).	ON	
5	SCLK	O	Sense serial data read clock.		
6	SENSE	I	Sense input from CXD2587Q.		
7	CLOCK	O	Serial data clock.		
8	XLAT	O	Latch output to CXD2587Q.		
9	DATA	O	Serial data output to CXD2587Q.		
10	RESET-1	I	Input terminal of system reset .		
11	X2	-	System clock(5MHz).		
12	X1	I	System clock(5MHz).		
13	NC	-	Connected to VSS.		
14	XT2	-	Unused.		
15	GFS	-	Unused.		
16	VDD	-	Power supply(+5V).		
17	SQCK	O	Q data reading clock output.		
18	NC	O	Unused.		
19	SUBQ	I	Q data input.		
20	SYSM	O	System muting control to CXD2587Q.	MUTE ON	
21	CE	O	Chip selector to dot driver.		
22	CLK	I/O	Clock in/out for dot driver.		
23	DATA	O	Data to dot driver.		
24	NC	I/O	Unused.		
25	AVSS	-	Connected to VSS.		
26	RMUTE	O	Analog muting control.		MUTE ON
27	SDA	I/O	EEPROM data input/output.		
28	SCLK	O	EEPROM clock output.		
29	SBUSY	I/O	Serial busy signal output.		
30-32	KEY2-O	I	Key input(key2-0).		
33	TYPE	I	Discrimination of model. 5V: CD-406 0V: CD-403/404		
34	AVDD	-	Power supply(+5V).		
35	AVREF	-	A/D reference power supply.		
36	POWER-K	I	Power key input.		KEY ON
37	S DATA	I/O	Serial data signal input/output.		
38	SCOR	I	Sub code frame sync detection.		
39	REM	I	Remote control signal input.		
40	VSS	-	Connected to VSS.		
41	SCK	O	Clock output to KAN03(IC9).		
42	SGATE	O	Enable output to KAN03(IC9).		
43	SDATA	O	Data output to KAN03(IC9).		
44,45	NC	-	Connected to VSS.		
46	VDD	-	Power supply(+5V).		
47,48	NC	-	Connected to VSS.		
49	OPEN SW	I	Detection input terminal of tray open switch.		TRAY OPEN
50	CLOSE SW	I	Detection input terminal of tray close switch.		TRAY CLOSE
51	UP SW	I	Detection input terminal of mecha. UP switch.		UP
52	DOWN SW	I	Detection input terminal of mecha. DOWN switch.		DOWN
53	SLTSW	I	Detection input terminal of start limit switch.		SW ON
54	CLOSE	O	Tray motor control.	CLOSE	
55	OPEN	O	Tray motor control.	OPEN	
56	RTR	O	Rotary tray motor control.	CW	
57	RTS	O	Rotary tray motor control.		DECELERATION
58	RTL	O	Rotary tray motor control.	CCW	
59	PSENSE	I	Input terminal of mecha.position sensor.		
60	DSENSE	I	Input terminal of mecha disc sensor.		
61	STANDBY	O	ON/STANDBY signal input.		STANDBY
62	RESET-0	O	Reset signal output.		RESET
63-73	NC	-	Connected to VSS.		

## CIRCUIT DESCRIPTION

Pin No.	Pin Name	I/O	Description	ACTIVE	
				H	L
74	LED1/SEG15	O	CD-406: FL indication for DISC1. CD-403/404: FL segment control.	LED ON SEG. LIGHT ON	
75	LED2/SEG14	O	CD-406: FL indication for DISC2. CD-403/404: FL segment control.	LED ON SEG. LIGHT ON	
76	LED3/SEG13	O	CD-406: FL indication for DISC3. CD-403/404: FL segment control.	LED ON SEG. LIGHT ON	
77	LED4/SEG12	O	CD-406: FL indication for DISC4. CD-403/404: FL segment control.	LED ON SEG. LIGHT ON	
78	LED5/SEG11	O	CD-406: FL indication for DISC5. CD-403/404: FL segment control.	LED ON SEG. LIGHT ON	
79	VLOAD	-	Power supply(-35V).		
80-90	SEG10-SEG0	O	FL segment control.		
91-100	GRID9-GRID0	O	FL grid control.		

### 2. Test mode

#### 2-1 How to set up the test mode.

While pressing the REPEAT key, insert the AC plug to the AC wall outlet.

#### 2-2 Contents of the test mode.

KEY	FL INDICATION		DESCRIPTION
	CD-406	CD-403/404	
AC IN with pressing the REPEAT key.	TEST 03 --:--	tEST 03 --:--	The unit is entered to 03 mode if the disc is on the tray, and then the tray opens.
PLAY/PAUSE	05 xx:xx 03 --:--	05 xx:xx 03 --:--	05:F/T SERVO ON → 03:F-SERVO ON and T-SERVO OFF
UP	-	-	FL all light on → *Niagara mode → normal indication *CD-403/404: all light off
FF	FEED OUT	Fed Out	The pick up travels outwards.
FB	FEED IN	Fed In	The pick up travels inwards.
STOP	NG: BLINKING 07 XX:XX 08 XX:XX 09 XX:XX 10 XX:XX Indication value: HEX		Stop the function. Shows the result of self_adjustment. 07 EF/FB 08 TG/FG 09 FE/RF 10 TE/VC Mode changes alternately by the STOP key.
DOWN	-	-	Release the test mode.

#### 2-3 Judgement extent for result of self-adjustment.

ITEMS		JUDGEMENT EXTENT(OK)
EF BALANCE adj.:	EF	NONE
AUTO-GAIN adj.	F- GAIN :FG T-GAIN :TG	0D~7EH 09~7EH
AVERAGE adj.	FE RF TE VC	NONE 80~CDH 3F~C0H 19~E6H

### 3. Initiallizing

KEY	FL INDICATION		DESCRIPTION
	CD-406	CD-403/404	
While pressing the CLEAR key, insert the AC plug to the AC wall outlet.	INIT OK INIT MECH NG INIT EENG	Inl ○ ○ Inl - ○ Inl ○ -	<ul style="list-style-type: none"> <li>• Traverse moves to down- ward.</li> <li>• Initialized EEPROM data.</li> </ul> NORMAL MECHANISM NG EEPROM NG

## ADJUSTMENT

No.	ITEM	INPUT SETTINGS	OUTPUT SETTINGS	PLAYER SETTINGS	ALIGNMENT POINTS	ALIGN FOR	FIG.
<b>Open the tray (Normal mode), then turn the power off.</b>							
1	LASER POWER	-	Apply the sensor section of optical power meter on the pickup lens.	While pressing the REPEAT key, turn the AC ON. (Test mode) Press the PLAY/PAUSE key, then confirm that the display is "03".	-	On the power from 0.08 to 0.15 mW, when the diffraction grating is correctly aligned with the RF level of 1.0 Vp-p or more.	(a)
<b>1. Load a disc on disc 1 tray.                  2. Turn the power off.                  3. While pressing the REPEAT. key, turn the power ON to enter the Test mode.</b>							
1	FOCUS ERROR BIAS	Test disc Type 4	Connect an oscilloscope as follows. CH1:	Press the PLAY/PAUSE key, then confirm that the display is "05".	FE BIAS VR1	Optimum eye pattern	
2	LASER CURRENT CHECK	Test disc Type 4	Connect the DC voltmeter to CN3(pin3 and 4) on X32.	Press the PLAY/PAUSE key, then confirm that the display is 03 or 05.	-	0.5±0.2V	

Note:  
 Type 4 disc : SONY YEDS-18 Test Disc or equivalent.  
 LPF: Around 47 kΩ+ 390 pF or so.  
 Step 1~4 are in Test Mode.

### (a) Laser power

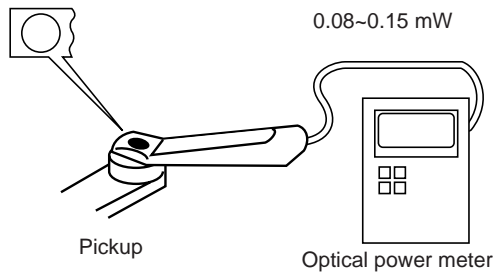

# PC BOARD (Component side view)

1  
2  
3  
4  
5  
6  
7

X25 C/3

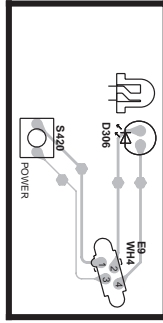

X25-6310-10 A/3 (J70-1379-01)

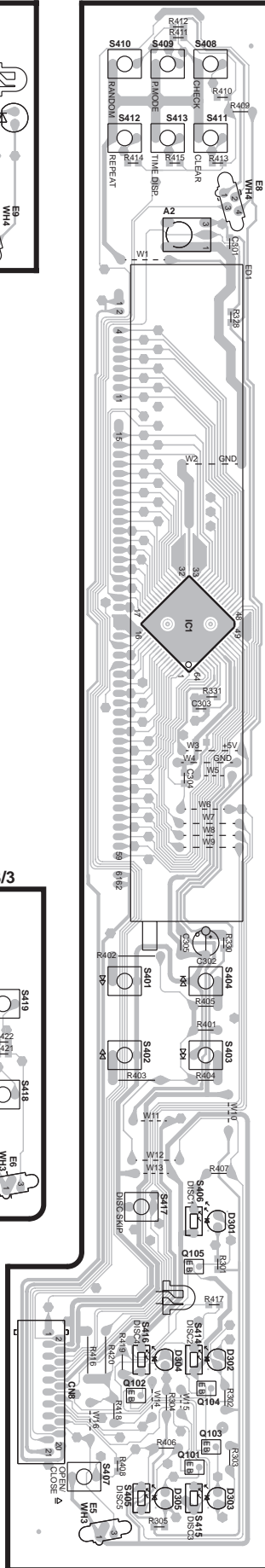

X25 B/3

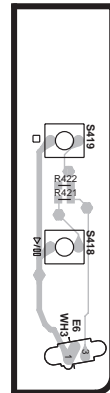

Refer to the schematic diagram for the value of resistors and capacitors.







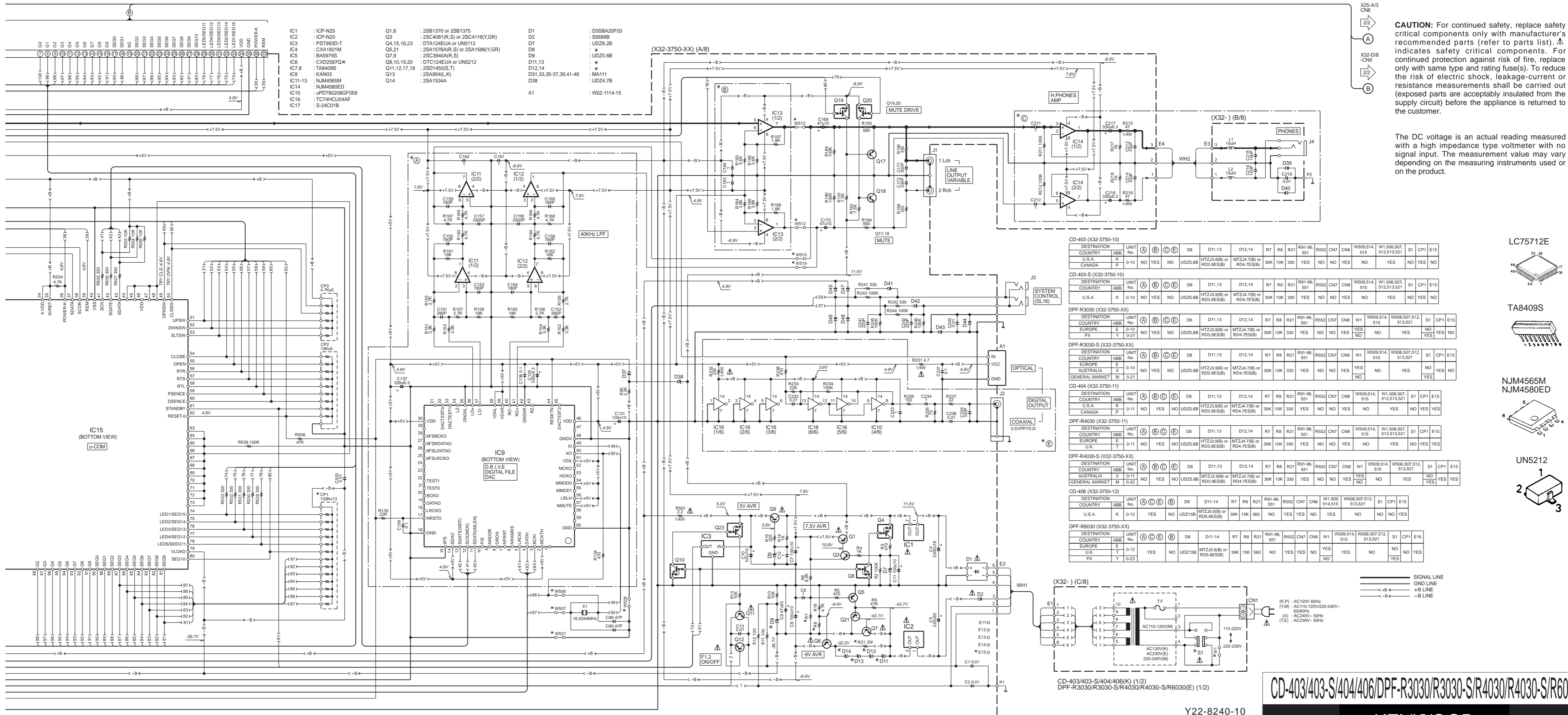

**CAUTION:** For continued safety, replace safety critical components only with manufacturer's recommended parts (refer to parts list).  $\Delta$  indicates safety critical components. For continued protection against risk of fire, replace only with same type and rating fuse(s). To reduce the risk of electric shock, leakage-current or resistance measurements shall be carried out (exposed parts are acceptably insulated from the supply circuit) before the appliance is returned to the customer.

The DC voltage is an actual reading measured with a high impedance type voltmeter with no signal input. The measurement value may vary depending on the measuring instruments used or on the product.

**CD-403 (X32-3750-10)**

DESTINATION	UNIT No.	A	B	C	E	D8	D11,13	D12,14	R7	R8	R21	R91-96,551	R552	CN7	CN8	W1	W509,514,515	W1,506,507,512,513,521	S1	CP1	E15	
U.S.A.	K	0-10	NO	YES	NO	UDZ5.6B	HTZJ3.9(B) or RD3.9E(S)(B)	MTZJ4.7(B) or RD4.7E(S)(B)	30K	10K	330	YES	NO	NO	NO	NO	NO	NO	NO	NO	NO	NO
CANADA	P	0-10	NO	YES	NO	UDZ5.6B	HTZJ3.9(B) or RD3.9E(S)(B)	MTZJ4.7(B) or RD4.7E(S)(B)	30K	10K	330	YES	NO	NO	NO	NO	NO	NO	NO	NO	NO	NO

**CD-403-S (X32-3750-10)**

DESTINATION	UNIT No.	A	B	C	E	D8	D11,13	D12,14	R7	R8	R21	R91-96,551	R552	CN7	CN8	W1	W509,514,515	W1,506,507,512,513,521	S1	CP1	E15	
U.S.A.	K	0-10	NO	YES	NO	UDZ5.6B	HTZJ3.9(B) or RD3.9E(S)(B)	MTZJ4.7(B) or RD4.7E(S)(B)	30K	10K	330	YES	NO	NO	NO	NO	NO	NO	NO	NO	NO	NO
CANADA	P	0-10	NO	YES	NO	UDZ5.6B	HTZJ3.9(B) or RD3.9E(S)(B)	MTZJ4.7(B) or RD4.7E(S)(B)	30K	10K	330	YES	NO	NO	NO	NO	NO	NO	NO	NO	NO	NO

**DPF-R3030 (X32-3750-XX)**

DESTINATION	UNIT No.	A	B	C	E	D8	D11,13	D12,14	R7	R8	R21	R91-96,551	R552	CN7	CN8	W1	W509,514,515	W1,506,507,512,513,521	S1	CP1	E15	
U.S.A.	K	0-10	NO	YES	NO	UDZ5.6B	HTZJ3.9(B) or RD3.9E(S)(B)	MTZJ4.7(B) or RD4.7E(S)(B)	30K	10K	330	YES	NO	NO	NO	NO	NO	NO	NO	NO	NO	NO
EUROPE	E	0-10	NO	YES	NO	UDZ5.6B	HTZJ3.9(B) or RD3.9E(S)(B)	MTZJ4.7(B) or RD4.7E(S)(B)	30K	10K	330	YES	NO	NO	NO	NO	NO	NO	NO	NO	NO	NO
GENERAL MARKET	PX	0-21	NO	YES	NO	UDZ5.6B	HTZJ3.9(B) or RD3.9E(S)(B)	MTZJ4.7(B) or RD4.7E(S)(B)	30K	10K	330	YES	NO	NO	NO	NO	NO	NO	NO	NO	NO	NO

**DPF-R3030-S (X32-3750-XX)**

DESTINATION	UNIT No.	A	B	C	E	D8	D11,13	D12,14	R7	R8	R21	R91-96,551	R552	CN7	CN8	W1	W509,514,515	W1,506,507,512,513,521	S1	CP1	E15	
U.S.A.	K	0-10	NO	YES	NO	UDZ5.6B	HTZJ3.9(B) or RD3.9E(S)(B)	MTZJ4.7(B) or RD4.7E(S)(B)	30K	10K	330	YES	NO	NO	NO	NO	NO	NO	NO	NO	NO	NO
EUROPE	E	0-10	NO	YES	NO	UDZ5.6B	HTZJ3.9(B) or RD3.9E(S)(B)	MTZJ4.7(B) or RD4.7E(S)(B)	30K	10K	330	YES	NO	NO	NO	NO	NO	NO	NO	NO	NO	NO
GENERAL MARKET	M	0-21	NO	YES	NO	UDZ5.6B	HTZJ3.9(B) or RD3.9E(S)(B)	MTZJ4.7(B) or RD4.7E(S)(B)	30K	10K	330	YES	NO	NO	NO	NO	NO	NO	NO	NO	NO	NO

**CD-404 (X32-3750-11)**

DESTINATION	UNIT No.	A	B	C	E	D8	D11,13	D12,14	R7	R8	R21	R91-96,551	R552	CN7	CN8	W1	W509,514,515	W1,506,507,512,513,521	S1	CP1	E15	
U.S.A.	K	0-11	NO	YES	NO	UDZ5.6B	HTZJ3.9(B) or RD3.9E(S)(B)	MTZJ4.7(B) or RD4.7E(S)(B)	30K	10K	330	YES	NO	NO	NO	NO	NO	NO	NO	NO	NO	NO
EUROPE	E	0-11	NO	YES	NO	UDZ5.6B	HTZJ3.9(B) or RD3.9E(S)(B)	MTZJ4.7(B) or RD4.7E(S)(B)	30K	10K	330	YES	NO	NO	NO	NO	NO	NO	NO	NO	NO	NO
CANADA	P	0-11	NO	YES	NO	UDZ5.6B	HTZJ3.9(B) or RD3.9E(S)(B)	MTZJ4.7(B) or RD4.7E(S)(B)	30K	10K	330	YES	NO	NO	NO	NO	NO	NO	NO	NO	NO	NO

**DPF-R4030 (X32-3750-11)**

DESTINATION	UNIT No.	A	B	C	E	D8	D11,13	D12,14	R7	R8	R21	R91-96,551	R552	CN7	CN8	W1	W509,514,515	W1,506,507,512,513,521	S1	CP1	E15	
U.S.A.	K	0-11	NO	YES	NO	UDZ5.6B	HTZJ3.9(B) or RD3.9E(S)(B)	MTZJ4.7(B) or RD4.7E(S)(B)	30K	10K	330	YES	NO	NO	NO	NO	NO	NO	NO	NO	NO	NO
EUROPE	E	0-11	NO	YES	NO	UDZ5.6B	HTZJ3.9(B) or RD3.9E(S)(B)	MTZJ4.7(B) or RD4.7E(S)(B)	30K	10K	330	YES	NO	NO	NO	NO	NO	NO	NO	NO	NO	NO
U.K.	T	0-11	NO	YES	NO	UDZ5.6B	HTZJ3.9(B) or RD3.9E(S)(B)	MTZJ4.7(B) or RD4.7E(S)(B)	30K	10K	330	YES	NO	NO	NO	NO	NO	NO	NO	NO	NO	NO

**DPF-R4030-S (X32-3750-XX)**

DESTINATION	UNIT No.	A	B	C	E	D8	D11,13	D12,14	R7	R8	R21	R91-96,551	R552	CN7	CN8	W1	W509,514,515	W1,506,507,512,513,521	S1	CP1	E15	
U.S.A.	K	0-11	NO	YES	NO	UDZ5.6B	HTZJ3.9(B) or RD3.9E(S)(B)	MTZJ4.7(B) or RD4.7E(S)(B)	30K	10K	330	YES	NO	NO	NO	NO	NO	NO	NO	NO	NO	NO
EUROPE	E	0-11	NO	YES	NO	UDZ5.6B	HTZJ3.9(B) or RD3.9E(S)(B)	MTZJ4.7(B) or RD4.7E(S)(B)	30K	10K	330	YES	NO	NO	NO	NO	NO	NO	NO	NO	NO	NO
GENERAL MARKET	M	0-22	NO	YES	NO	UDZ5.6B	HTZJ3.9(B) or RD3.9E(S)(B)	MTZJ4.7(B) or RD4.7E(S)(B)	30K	10K	330	YES	NO	NO	NO	NO	NO	NO	NO	NO	NO	NO

**CD-406 (X32-3750-12)**

DESTINATION	UNIT No.	A	B	C	E	D8	D11-14	R7	R8	R21	R91-96,551	R552	CN7	CN8	W1	W509,514,515	W1,506,507,512,513,521	S1	CP1	E15		
U.S.A.	K	0-12	YES	NO	NO	UDZ15B	MTZJ5.6(B) or RD5.6E(S)(B)	39K	15K	560	NO	YES	YES	NO	NO	NO	NO	NO	NO	NO	NO	NO

**DPF-R6030 (X32-3750-XX)**

DESTINATION	UNIT No.	A	B	C	E	D8	D11-14	R7	R8	R21	R91-96,551	R552	CN7	CN8	W1	W509,514,515	W1,506,507,512,513,521	S1	CP1	E15		
U.S.A.	K	0-12	YES	NO	NO	UDZ15B	MTZJ5.6(B) or RD5.6E(S)(B)	39K	15K	560	NO	YES	YES	NO	NO	NO	NO	NO	NO	NO	NO	NO
EUROPE	E	0-12	YES	NO	NO	UDZ15B	MTZJ5.6(B) or RD5.6E(S)(B)	39K	15K	560	NO	YES	YES	NO	NO	NO	NO	NO	NO	NO	NO	NO
U.K.	T	0-12	YES	NO	NO	UDZ15B	MTZJ5.6(B) or RD5.6E(S)(B)	39K	15K	560	NO	YES	YES	NO	NO	NO	NO	NO	NO	NO	NO	NO
GENERAL MARKET	PX	0-23	YES	NO	NO	UDZ15B	MTZJ5.6(B) or RD5.6E(S)(B)	39K	15K	560	NO	YES	YES	NO	NO	NO	NO	NO	NO	NO	NO	NO

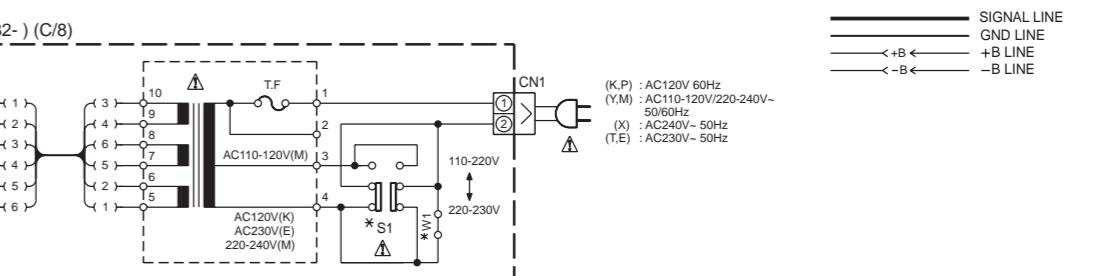

CD-403/403-S/404/406/DPF-R3030/R3030-S/R4030/R4030-S/R6030 (E) (1/2)

LC75712E

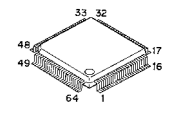

TA8409S

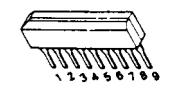

NJM4565M  
NJM4580ED

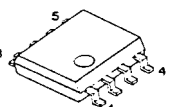

UN5212

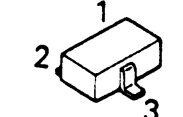

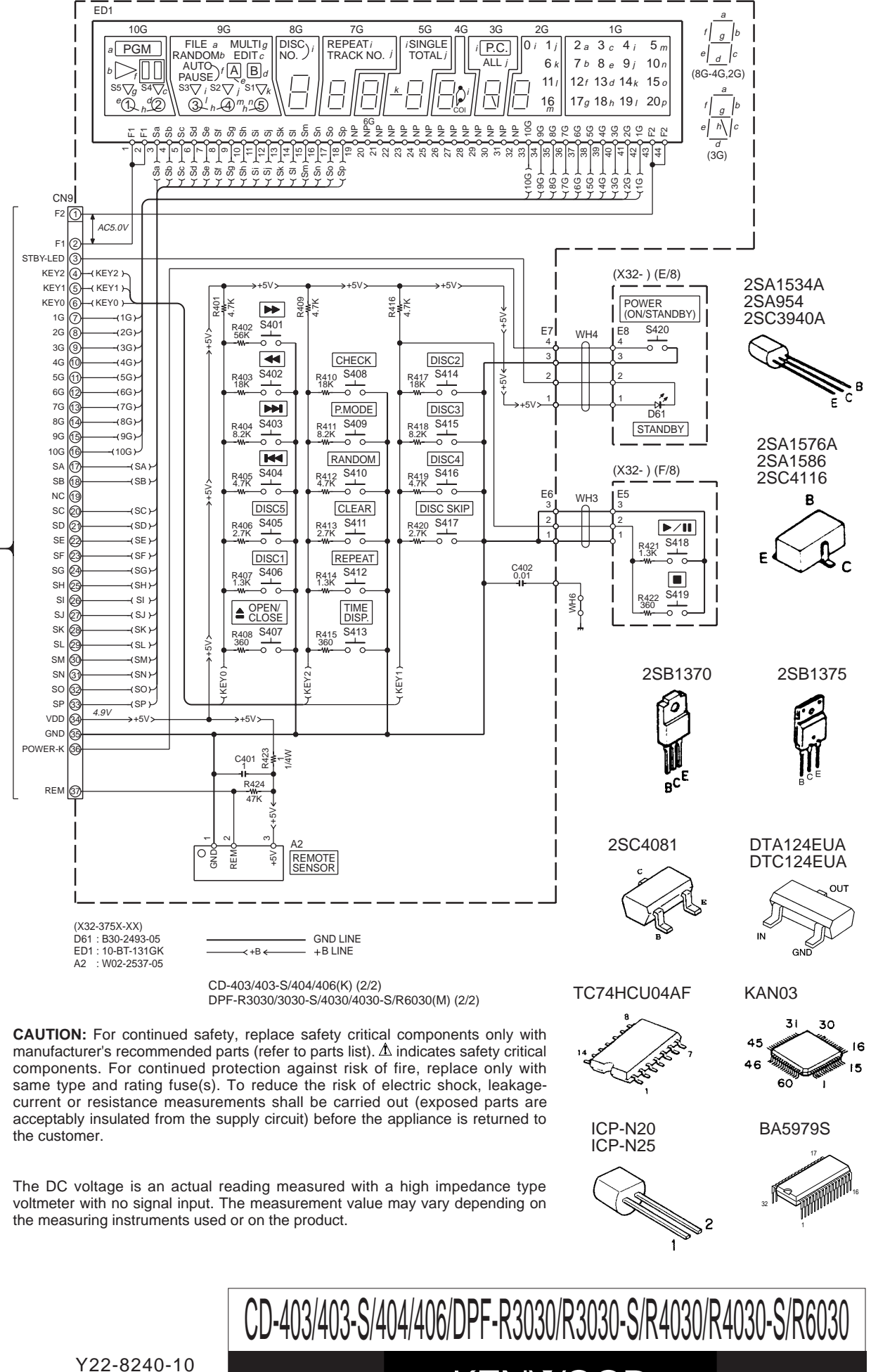
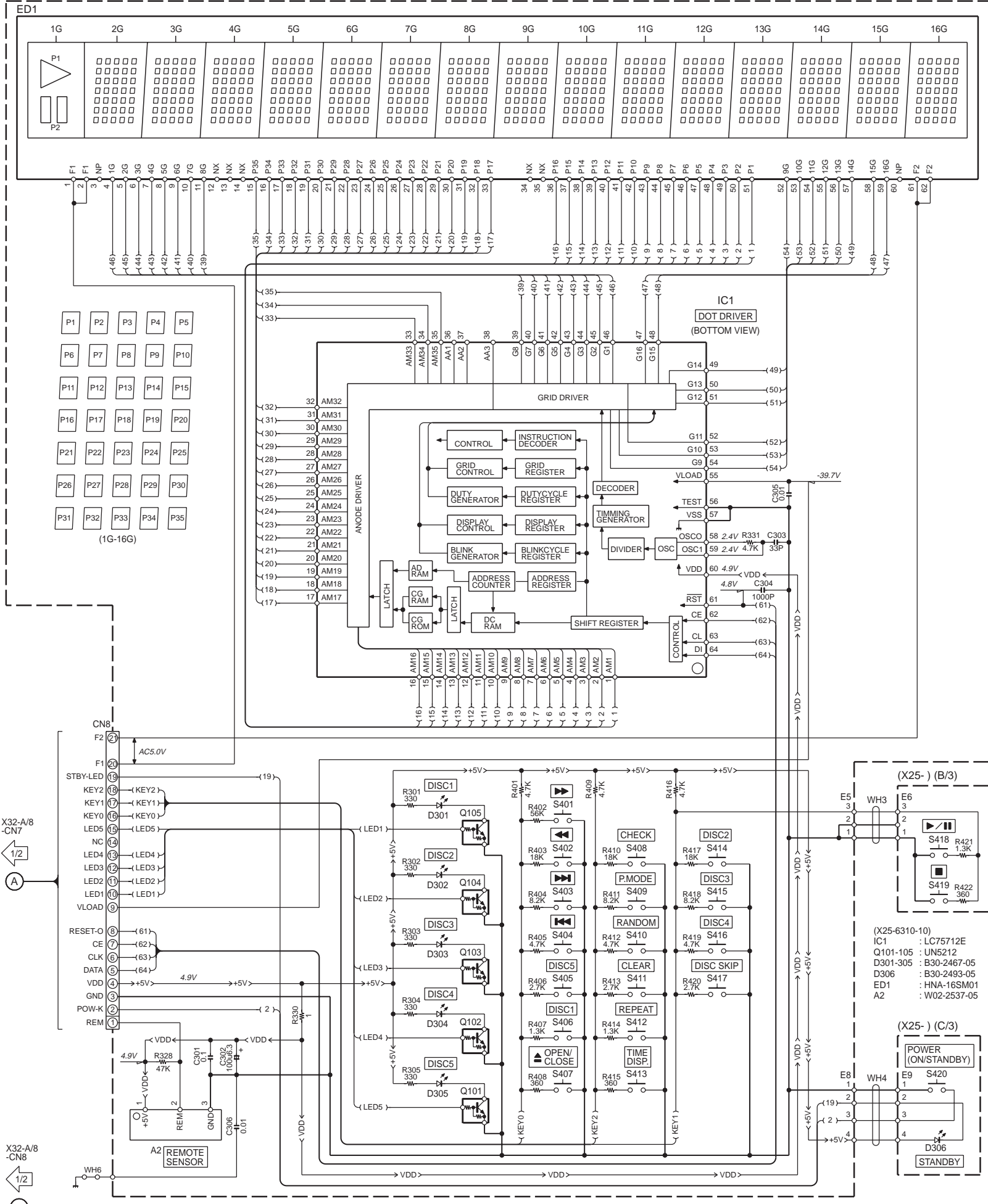

**CAUTION:** For continued safety, replace safety critical components only with manufacturer's recommended parts (refer to parts list).  $\Delta$  indicates safety critical components. For continued protection against risk of fire, replace only with same type and rating fuse(s). To reduce the risk of electric shock, leakage-current or resistance measurements shall be carried out (exposed parts are acceptably insulated from the supply circuit) before the appliance is returned to the customer.

The DC voltage is an actual reading measured with a high impedance type voltmeter with no signal input. The measurement value may vary depending on the measuring instruments used or on the product.

CD-403/403-S/404/406/DPF-R3030/R3030-S/R4030/R4030-S/R6030



# CD-403/403-S/404/406/DPF-R3030/R3030-S/R4030/R4030-S/R6030 EXPLODED VIEW (UNIT)

Parts with exploded numbers larger than 700 are not supplied.

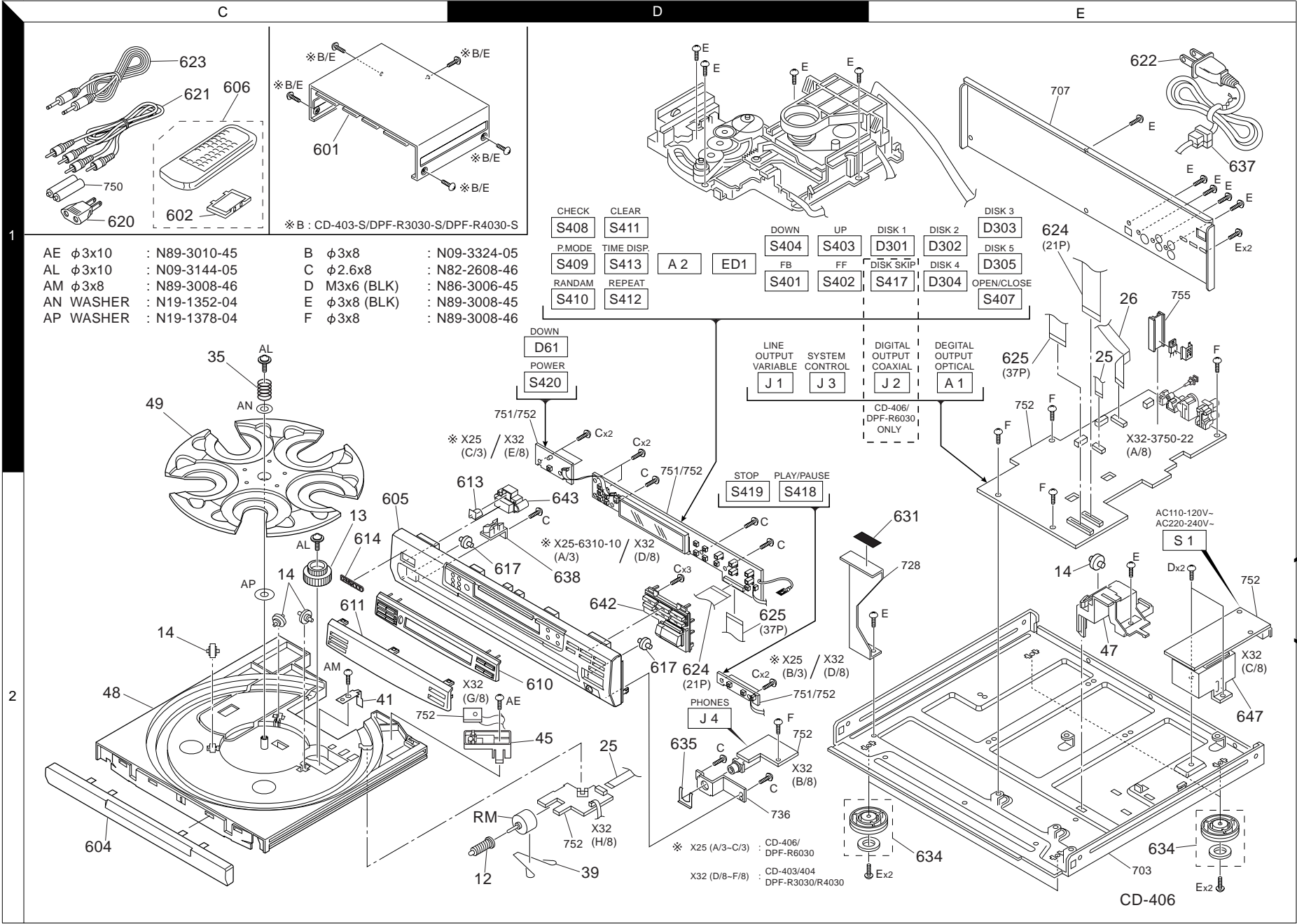

\* New Parts

Parts without **Parts No.** are not supplied.  
Les articles non mentionnés dans le **Parts No.** ne sont pas fournis.  
Teile ohne **Parts No.** werden nicht geliefert.

①

Ref. No	Add-ress	New Parts	Parts No.	Description	Desti-nation	Re-marks
<b>CD-403/403-S/DPF-R3030/R3030-S</b>						
601	1C	*	A01-3705-01	METALLIC CABINET	E1	
601	1C	*	A01-3705-01	METALLIC CABINET	KP1Y1	
601	1C	*	A01-3706-01	METALLIC CABINET	E2	
601	1C	*	A01-3706-01	METALLIC CABINET	K1M1X1	
604	2C	*	A29-1064-02	PANEL	E1	
604	2C	*	A29-1064-02	PANEL	KP1Y1	
604	2C	*	A29-1065-02	PANEL	E2	
604	2C	*	A29-1065-02	PANEL	K1M1X1	
605	2C	*	A60-1710-01	PANEL	KP1	
605	2C	*	A60-1711-01	PANEL	K1	
605	2C	*	A60-1712-01	PANEL	M1X1E2	
605	2C	*	A60-1713-01	PANEL	Y1E1	
610	2D	*	B07-2471-02	ESCUTCHEON		
611	2C	*	B10-3518-03	FRONT GLASS		
613	2D	*	B12-0382-04	INDICATOR		
614	2C	*	B43-0302-04	KENWOOD BADGE		
-	-	-	B46-0096-53	WARRANTY CARD	X1	
-	-	-	B46-0197-00	QUESTIONNAIRE CARD	KK1	
-	-	-	B46-0310-03	WARRANTY CARD	E1E2	
-	-	-	B46-0328-03	WARRANTY CARD	KK1Y1	
-	-	-	B46-0347-03	WARRANTY CARD	P1	
-	-	-	B58-0513-04	CAUTION CARD (PRESET220-240)	Y1	
-	-	-	B58-0964-13	CAUTION CARD (UL)	KK1Y1	
-	-	-	B58-0965-13	CAUTION CARD (T,XtypePL)	X1	
-	-	-	B58-0966-13	CAUTION CARD (ELMtypePL)	M1E1E2	
-	-	*	B58-0967-03	CAUTION CARD (PtypePL)	P1	
-	-	-	B59-1104-00	SERVICE DIRECTORY	Y1	
-	-	*	B60-4404-00	INSTRUCTION MANUAL (EN)	KK1P1	
-	-	*	B60-4404-00	INSTRUCTION MANUAL (EN)	Y1M1X1	
-	-	*	B60-4405-00	INSTRUCTION MANUAL (FR)	P1E1E2	
-	-	*	B60-4406-00	INSTRUCTION MANUAL (GE/NE/IT)	E1E2	
-	-	*	B60-4407-00	INSTRUCTION MANUAL (ES)	M1E1E2	
-	-	*	B60-4408-00	INSTRUCTION MANUAL (TC)	M1	
617	2D		D14-0389-04	ROLLER		
△ 620	1C		E03-0115-05	AC PLUG ADAPTER	M1	
621	1C		E30-0505-05	AUDIO CORD		
△ 622	1E		E30-2789-05	AC POWER CORD	Y1	
△ 622	1E		E30-2790-05	AC POWER CORD	X1	
△ 622	1E		E30-2842-05	AC POWER CORD	M1E1E2	
△ 622	1E		E30-2909-05	AC POWER CORD	KK1P1	
623	1C		E30-2816-05	CORD WITH PLUG		
625	1E		E35-2059-05	FLAT CABLE (37P)		
631	2E		G11-2404-04	CUSHION		
-	-	*	H10-7606-02	POLYSTYRENE FOAMED FIXTURE		
-	-	*	H10-7607-02	POLYSTYRENE FOAMED FIXTURE		
-	-	*	H12-2487-04	PACKING FIXTURE		
-	-		H20-0568-04	PROTECTION COVER	M1	
-	-		H21-0303-04	PROTECTION SHEET		
-	-		H25-0232-04	PROTECTION BAG (235X350X0.03)		
-	-		H25-0661-04	PROTECTION BAG	E2	

L : Scandinavia K : USA P : Canada R : Mexico C : China I : Malaysia

Y : PX(Far East,Hawaii) T : England E : Europe G : Germany V : China(Shanghai)

Y : AAFES(Europe) X : Australia Q : Russia H : Korea M : Other Areas △ indicates safety critical components .

3: CD-403/403-S/DPF-R3030/R3030-S 4: CD-404/DPF-R4030/R4030-S 6: CD-406/DPF-R6030

\* New Parts

Parts without **Parts No.** are not supplied.

Les articles non mentionnés dans le **Parts No.** ne sont pas fournis.  
Teile ohne **Parts No.** werden nicht geliefert.

②

Ref. No	Add-ress	New Parts	Parts No.	Description	Desti-nation	Re-marks
-	-		H25-0661-04	PROTECTION BAG	KK1P1	
-	-	*	H25-0661-04	PROTECTION BAG	Y1X1E1	
-	-	*	H50-3488-04	ITEM CARTON CASE	KP1	
-	-	*	H50-3489-04	ITEM CARTON CASE	M1	
-	-	*	H50-3490-04	ITEM CARTON CASE	Y1E1	
-	-	*	H50-3491-04	ITEM CARTON CASE	X1E2	
-	-	*	H50-3492-04	ITEM CARTON CASE	K1	
634	2E	*	J02-1473-03	FOOT		
△ 637	1E		J42-0083-05	POWER CORD BUSHING		
638	2D		J90-0811-04	GUIDE		
-	-		J61-0307-05	WIRE BAND	E1E2	
-	-		J61-0307-05	WIRE BAND	Y1M1X1	
642	2D	*	K29-7611-02	KNOB	E1	
642	2D	*	K29-7611-02	KNOB	KP1Y1	
642	2D	*	K29-7612-02	KNOB	E2	
642	2D	*	K29-7612-02	KNOB	K1M1X1	
643	2D	*	K29-7762-02	KNOB	E1	
643	2D	*	K29-7762-02	KNOB	KP1Y1	
643	2D	*	K29-7763-02	KNOB	E2	
643	2D	*	K29-7763-02	KNOB	K1M1X1	
△ 647	2E	*	L07-2784-05	POWER TRANSFORMER	KK1P1	
△ 647	2E	*	L07-2785-05	POWER TRANSFORMER	Y1M1	
△ 647	2E	*	L07-2786-05	POWER TRANSFORMER	X1E1E2	
<b>CD-404/DPF-R4030/R4030-S</b>						
601	1C	*	A01-3705-01	METALLIC CABINET	E1	
601	1C	*	A01-3705-01	METALLIC CABINET	KP1T1	
601	1C	*	A01-3706-01	METALLIC CABINET	M1X1	
602	1C	*	A09-0356-08	BATTERY COVER		
604	2C	*	A29-1064-02	PANEL	E1	
604	2C	*	A29-1064-02	PANEL	KP1T1	
604	2C	*	A29-1065-02	PANEL	M1X1	
605	2C	*	A60-1706-01	PANEL	KP1	
605	2C	*	A60-1708-01	PANEL	M1X1	
605	2C	*	A60-1709-01	PANEL	T1E1	
606	1C	*	A70-1339-05	REMOTE CONTROLLER ASSY		
610	2D	*	B07-2471-02	ESCUTCHEON		
611	2C	*	B10-3518-03	FRONT GLASS		
613	2D	*	B12-0382-04	INDICATOR		
614	2C	*	B43-0302-04	KENWOOD BADGE		
-	-	-	B46-0096-53	WARRANTY CARD	X1	
-	-	-	B46-0197-00	QUESTIONNAIRE CARD	K	
-	-	-	B46-0310-03	WARRANTY CARD	T1E1	
-	-	-	B46-0328-03	WARRANTY CARD	K	
-	-	-	B46-0347-03	WARRANTY CARD	P1	
-	-	-	B58-0945-03	CAUTION CARD	T1	
-	-	-	B58-0964-13	CAUTION CARD (UL)	K	
-	-	-	B58-0965-13	CAUTION CARD (T,XtypePL)	X1T1	
-	-	-	B58-0966-13	CAUTION CARD (ELMtypePL)	M1E1	
-	-	*	B58-0967-03	CAUTION CARD (PtypePL)	P1	
-	-	*	B60-4404-00	INSTRUCTION MANUAL (EN)	KP1M1	
-	-	*	B60-4404-00	INSTRUCTION MANUAL (EN)	X1T1	
-	-	*	B60-4405-00	INSTRUCTION MANUAL (FR)	P1E1	
-	-	*	B60-4406-00	INSTRUCTION MANUAL (GE/NE/IT)	E1	

L : Scandinavia K : USA P : Canada R : Mexico C : China I : Malaysia

Y : PX(Far East,Hawaii) T : England E : Europe G : Germany V : China(Shanghai)

Y : AAFES(Europe) X : Australia Q : Russia H : Korea M : Other Areas △ indicates safety critical components .

3: CD-403/403-S/DPF-R3030/R3030-S

4: CD-404/DPF-R4030/R4030-S

6: CD-406/DPF-R6030

\* New Parts

Parts without **Parts No.** are not supplied.  
Les articles non mentionnés dans le **Parts No.** ne sont pas fournis.  
Teile ohne **Parts No.** werden nicht geliefert.

3

Ref. No	Address	New Parts	Parts No.	Description	Destination	Remarks
-	-	*	B60-4407-00	INSTRUCTION MANUAL (ES)	M1E1	
-	-	*	B60-4408-00	INSTRUCTION MANUAL (TC)	M1	
617	2D		D14-0389-04	ROLLER		
△ 620	1C		E03-0115-05	AC PLUG ADAPTER	M1	
△ 621	1C		E30-0505-05	AUDIO CORD		
△ 622	1E		E30-2790-05	AC POWER CORD	X1	
△ 622	1E		E30-2791-05	AC POWER CORD	T1	
△ 622	1E		E30-2842-05	AC POWER CORD	M1E1	
△ 622	1E		E30-2909-05	AC POWER CORD	KP1	
623	1C		E30-2816-05	CORD WITH PLUG		
625	1E		E35-2059-05	FLAT CABLE (37P)		
631	2E		G11-2404-04	CUSHION		
-	-	*	H10-7606-02	POLYSTYRENE FOAMED FIXTURE		
-	-	*	H10-7607-02	POLYSTYRENE FOAMED FIXTURE		
-	-	*	H12-2487-04	PACKING FIXTURE		
-	-	*	H20-0568-04	PROTECTION COVER	M1	
-	-	*	H21-0303-04	PROTECTION SHEET		
-	-		H25-0232-04	PROTECTION BAG (235X350X0.03)	KP1M1	
-	-		H25-0232-04	PROTECTION BAG (235X350X0.03)	X1E1	
-	-		H25-0651-04	PROTECTION BAG (0232 PRINT)	T1	
-	-		H25-0661-04	PROTECTION BAG	KP1X1	
-	-		H25-0661-04	PROTECTION BAG	T1E1	
-	-	*	H50-3483-04	ITEM CARTON CASE	KP1	
-	-	*	H50-3485-04	ITEM CARTON CASE	M1X1	
-	-	*	H50-3486-04	ITEM CARTON CASE	T1E1	
634	2E	*	J02-1473-03	FOOT		
635	1E	*	J21-3326-05	JACK MOUNTING HARDWARE		
△ 637	1E		J42-0083-05	POWER CORD BUSHING		
638	2D		J90-0851-04	GUIDE		
-	-		J61-0307-05	WIRE BAND	E1	
-	-		J61-0307-05	WIRE BAND	M1X1T1	
642	2D	*	K29-7611-02	KNOB	E1	
642	2D	*	K29-7611-02	KNOB	KP1T1	
642	2D	*	K29-7612-02	KNOB	M1X1	
643	2D	*	K29-7762-02	KNOB	E1	
643	2D	*	K29-7762-02	KNOB	KP1T1	
643	2D	*	K29-7763-02	KNOB	M1X1	
△ 647	2E	*	L07-2784-05	POWER TRANSFORMER	KP1	
△ 647	2E	*	L07-2785-05	POWER TRANSFORMER	M1	
△ 647	2E	*	L07-2786-05	POWER TRANSFORMER	X1T1E1	
<b>CD-406/DPF-R6030</b>						
601	1C	*	A01-3705-01	METALLIC CABINET		
602	1C	*	A09-0356-08	BATTERY COVER		
604	2C	*	A29-1064-02	PANEL		
605	2C	*	A60-1714-01	PANEL	K	
605	2C	*	A60-1716-01	PANEL	Y1T1E1	
606	1C	*	A70-1339-05	REMOTE CONTROLLER ASSY		
610	2D	*	B07-2471-02	ESCUTCHEON		
611	2C	*	B10-3518-03	FRONT GLASS		
613	2D	*	B12-0382-04	INDICATOR		

L : Scandinavia K : USA P : Canada R : Mexico C : China I : Malaysia

Y : PX(Far East,Hawaii) T : England

E : Europe G : Germany V : China(Shanghai)

X : Australia Q : Russia

H : Korea M : Other Areas

△ indicates safety critical components.

3: CD-403/403-S/DPF-R3030/R3030-S

4: CD-404/DPF-R4030/R4030-S

6: CD-406/DPF-R6030

\* New Parts

Parts without **Parts No.** are not supplied.  
Les articles non mentionnés dans le **Parts No.** ne sont pas fournis.  
Teile ohne **Parts No.** werden nicht geliefert.

4

Ref. No	Address	New Parts	Parts No.	Description	Destination	Remarks
614	2C		B43-0302-04	KENWOOD BADGE		
-	-		B46-0197-00	QUESTIONNAIRE CARD		
-	-		B46-0310-03	WARRANTY CARD	K	
-	-		B46-0328-03	WARRANTY CARD	T1E1	
-	-		B58-0513-04	CAUTION CARD (PRESET220-240)	KY1	
-	-		B58-0945-03	CAUTION CARD	Y1	
-	-		B58-0964-13	CAUTION CARD (ULtype)	T1	
-	-		B58-0965-13	CAUTION CARD (ULtypePL)	KY1	
-	-		B58-0966-13	CAUTION CARD (ELMtypePL)	T1	
-	-		B59-1104-00	SERVICE DIRECTORY	E1	
-	-	*	B60-4404-00	INSTRUCTION MANUAL (EN)	Y1	
-	-	*	B60-4405-00	INSTRUCTION MANUAL (FR)	KY1T1	
-	-	*	B60-4406-00	INSTRUCTION MANUAL (GE/NE/IT)	E1	
-	-	*	B60-4407-00	INSTRUCTION MANUAL (ES)	E1	
617	2D		D14-0389-04	ROLLER		
△ 621	1C		E30-0505-05	AUDIO CORD		
△ 622	1E		E30-2789-05	AC POWER CORD	Y1	
△ 622	1E		E30-2791-05	AC POWER CORD	T1	
△ 622	1E		E30-2842-05	AC POWER CORD	E1	
△ 622	1E		E30-2909-05	AC POWER CORD	K	
623	1C		E30-2816-05	CORD WITH PLUG		
624	1E,2D		E35-0148-05	WIRING HARNESS(FLAT CABLE)21P		
631	2E		G11-2404-04	CUSHION		
-	-	*	H10-7606-02	POLYSTYRENE FOAMED FIXTURE		
-	-	*	H10-7607-02	POLYSTYRENE FOAMED FIXTURE		
-	-	*	H12-2487-04	PACKING FIXTURE		
-	-	*	H21-0303-04	PROTECTION SHEET		
-	-	*	H25-0232-04	PROTECTION BAG (235X350X0.03)	KY1E1	
-	-	*	H25-0651-04	PROTECTION BAG (0232 PRINT)	T1	
-	-	*	H25-0661-04	PROTECTION BAG		
-	-	*	H50-3493-04	ITEM CARTON CASE	K	
-	-	*	H50-3494-04	ITEM CARTON CASE	Y1T1E1	
634	2E	*	J02-1473-03	FOOT		
635	2D	*	J21-3326-05	JACK MOUNTING HARDWARE		
△ 637	1E		J42-0083-05	POWER CORD BUSHING		
638	2D		J90-0851-04	GUIDE		
-	-		J61-0307-05	WIRE BAND		
642	2D	*	K29-7614-04	KNOB ASSY		
643	2D	*	K29-7762-02	KNOB		
△ 647	2E	*	L07-2827-05	POWER TRANSFORMER	K	
△ 647	2E	*	L07-2828-05	POWER TRANSFORMER	Y1	
△ 647	2E	*	L07-2829-05	POWER TRANSFORMER	T1E1	
<b>DISPLAY UNIT (X25-6310-10) CD-406/DPF-R6030 only</b>						
D301-305			B30-2467-05	LED		
D306			B30-2493-05	LED		
C301		*	CK73FB1C104K	CHIP C	0.10UF	K
C302		*	CE04RW0J101M	ELECTRO	100UF	6.3WV
C303		*	CC73FSL1H330J	CHIP C	33PF	J
C304		*	CK73FB1H102K	CHIP C	1000PF	K
C305		*	CK45FF1H103Z	CERAMIC	0.010UF	Z
C306		*	CK73FB1H103K	CHIP C	0.010UF	K

L : Scandinavia K : USA P : Canada R : Mexico C : China I : Malaysia

Y : PX(Far East,Hawaii) T : England

E : Europe G : Germany V : China(Shanghai)

X : Australia Q : Russia

H : Korea M : Other Areas

△ indicates safety critical components.

3: CD-403/403-S/DPF-R3030/R3030-S

4: CD-404/DPF-R4030/R4030-S

6: CD-406/DPF-R6030

CD-403/403-S/404/406/DPF-R3030/R3030-S/R4030/R4030-S/R6030  
PARTS LIST

\* New Parts

Parts without **Parts No.** are not supplied.  
 Les articles non mentionnés dans le **Parts No.** ne sont pas fournis.  
 Teile ohne **Parts No.** werden nicht geliefert.

5

Ref. No	Add-ress	New Parts	Parts No.	Description	Desti-nation	Re-marks
CN8			E40-4946-05	FLAT CABLE CONNECTOR		
-		*	J19-5789-14	HOLDER		
R301			RK73FB2A331J	CHIP R	330	J 1/10W
R305			RK73FB2A331J	CHIP R	330	J 1/10W
R328			RK73FB2A473J	CHIP R	47K	J 1/10W
R330			RK73FB2A1R0J	CHIP R	1.0	J 1/10W
R331			RK73FB2A472J	CHIP R	4.7K	J 1/10W
R408			RK73FB2A361J	CHIP R	360	J 1/10W
R410			RK73FB2A183J	CHIP R	18K	J 1/10W
R411			RK73FB2A822J	CHIP R	8.2K	J 1/10W
R412			RK73FB2A472J	CHIP R	4.7K	J 1/10W
R413			RK73FB2A272J	CHIP R	2.7K	J 1/10W
R414			RK73FB2A132J	CHIP R	1.3K	J 1/10W
R415			RK73FB2A361J	CHIP R	360	J 1/10W
R417			RK73FB2A183J	CHIP R	18K	J 1/10W
R421			RK73FB2A132J	CHIP R	1.3K	J 1/10W
R422			RK73FB2A361J	CHIP R	360	J 1/10W
S401-404			S70-0031-05	TACT SWITCH		
S405,406			S70-0802-05	TACT SWITCH		
S407-413			S70-0031-05	TACT SWITCH		
S414-416			S70-0802-05	TACT SWITCH		
S417-420			S70-0031-05	TACT SWITCH		
ED1		*	HNA-16SM01	FLUORESCENT INDICATOR TUBE		
IC1			LC75712E	MOS-IC		
Q101-105			UN5212	DIGITAL TRANSISTOR		
A2			W02-2537-05	ELECTRIC CIRCUIT MODULE		
<b>CD PLAYER UNIT (X32-375X-XX)</b>						
D61			B30-2493-05	LED		34
C1 ,2			CK45FF1H103Z	CERAMIC	0.010UF	Z
C4			CE04KW1C332M	ELECTRO	3300UF	16WV
C5			CE04KW1J221M	ELECTRO	220UF	63WV
C6			CK73FF1C105Z	CHIP C	1.0UF	Z
C7 ,8			CE04KW1A101M	ELECTRO	100UF	10WV
C9			CE04KW1H470M	ELECTRO	47UF	50WV
C10 ,11			CE04KW1A101M	ELECTRO	100UF	10WV
C12			CK73FF1C105Z	CHIP C	1.0UF	Z
C13			CK73FB1H103K	CHIP C	0.010UF	K
C31			CK73FF1E104Z	CHIP C	0.10UF	Z
C32 -34			CE04KW1A101M	ELECTRO	100UF	10WV
C35			CC73FCH1H180J	CHIP C	18PF	J
C36			CK73FF1C105Z	CHIP C	1.0UF	Z
C42 ,43			CE04KW1A101M	ELECTRO	100UF	10WV
C44			CK73FB1H183K	CHIP C	0.018UF	K
C71			CC73FSL1H221J	CHIP C	220PF	J
C72			CK73FB1H223K	CHIP C	0.022UF	K
C73			CC73FSL1H471J	CHIP C	470PF	J
C74			CK73FF1C105Z	CHIP C	1.0UF	Z
C75			CK73FF1C474Z	CHIP C	0.47UF	Z
C76			CK73FF1E104Z	CHIP C	0.10UF	Z
C77			CK73FB1H332K	CHIP C	3300PF	K
C78			CK73FB1H103K	CHIP C	0.010UF	K
C79			CK73FB1H152K	CHIP C	1500PF	K

L : Scandinavia K : USA P : Canada R : Mexico C : China I : Malaysia

Y : PX(Far East,Hawaii) T : England E : Europe G : Germany V : China(Shanghai)

Y : AAFES(Europe) X : Australia Q : Russia H : Korea M : Other Areas  $\Delta$  indicates safety critical components.

3: CD-403/403-S/DPF-R3030/R3030-S 4: CD-404/DPF-R4030/R4030-S 6: CD-406/DPF-R6030

\* New Parts

Parts without **Parts No.** are not supplied.  
 Les articles non mentionnés dans le **Parts No.** ne sont pas fournis.  
 Teile ohne **Parts No.** werden nicht geliefert.

6

Ref. No	Add-ress	New Parts	Parts No.	Description	Desti-nation	Re-marks
C80			CK73FB1H473K	CHIP C	0.047UF	K
C81			CK73FF1C105Z	CHIP C	1.0UF	Z
C82			CE04KW1A101M	ELECTRO	100UF	10WV
C83			CE04KW0J471M	ELECTRO	470UF	6.3WV
C84			CK73FF1E104Z	CHIP C	0.10UF	Z
C85 ,86			CC73FCH1H470J	CHIP C	47PF	J
C87			CC73FSL1H102J	CHIP C	1000PF	J
C91 ,92			CC73FSL1H151J	CHIP C	150PF	J
C93 ,94			CC73FSL1H821J	CHIP C	820PF	J
C95			CK73FB1H472K	CHIP C	4700PF	K
C111,112			CK73FF1E104Z	CHIP C	0.10UF	Z
C131			CE04KW1A101M	ELECTRO	100UF	10WV
C135			CE04KW0J331M	ELECTRO	330UF	6.3WV
C136			CK73FF1E104Z	CHIP C	0.10UF	Z
C137			CE04KW0J331M	ELECTRO	330UF	6.3WV
C139			CK73FF1E104Z	CHIP C	0.10UF	Z
C151,152			CC73FSL1H391J	CHIP C	390PF	J
C153-156			CC73FSL1H181J	CHIP C	180PF	J
C157,158			CK73FB1H332K	CHIP C	3300PF	K
C159,160			CC73FSL1H181J	CHIP C	180PF	J
C161,162			CK73FF1C105Z	CHIP C	1.0UF	Z
C163,164			CK73FF1C105Z	CHIP C	1.0UF	Z
C169,170			CE04KW1A470M	ELECTRO	47UF	10WV
C171,172			CC73FSL1H331J	CHIP C	330PF	J
C211,212			CK73FF1C105Z	CHIP C	1.0UF	Z
C213-216			CC73FSL1H101J	CHIP C	100PF	J
C217,218			CE04KW0J331M	ELECTRO	330UF	6.3WV
C219			CK73FB1H103K	CHIP C	0.010UF	K
C231			CK73FF1E104Z	CHIP C	0.10UF	Z
C232			CK73FB1H103K	CHIP C	0.010UF	K
C233,234			CK73FF1C105Z	CHIP C	1.0UF	Z
C235			CC73FSL1H101J	CHIP C	100PF	J
C236			CK73FB1H103K	CHIP C	0.010UF	K
C241,242			CC73FSL1H221J	CHIP C	220PF	J
C243			CK73FB1H103K	CHIP C	0.010UF	K
C401			CK73FF1C105Z	CHIP C	1.0UF	Z
C402			CK73FB1H103K	CHIP C	0.010UF	K
C501			CE04KW1A101M	ELECTRO	100UF	10WV
C502			CK73FF1C105Z	CHIP C	1.0UF	Z
C503			CK45FF1H103Z	CERAMIC	0.010UF	Z
C504			CK73FB1H103K	CHIP C	0.010UF	K
C505			CK73FB1H472K	CHIP C	4700PF	K
$\Delta$ CN1			E40-4245-05	PIN ASSY		
CN2			E40-3250-05	PIN ASSY		
CN3			E40-3248-05	PIN ASSY		
CN4			E40-8037-05	FLAT CABLE CONNECTOR		
CN5			E40-4932-05	FLAT CABLE CONNECTOR		
CN6			E40-3252-05	PIN ASSY		
CN7			E40-4908-05	FLAT CABLE CONNECTOR		6
CN8			E40-4924-05	FLAT CABLE CONNECTOR		34
CN9			E40-4962-05	FLAT CABLE CONNECTOR		34
CN10			E40-4932-05	FLAT CABLE CONNECTOR		
J1			E63-0122-05	PIN JACK		
J2			E63-0199-05	PIN JACK		6

L : Scandinavia K : USA P : Canada R : Mexico C : China I : Malaysia

Y : PX(Far East,Hawaii) T : England E : Europe G : Germany V : China(Shanghai)

Y : AAFES(Europe) X : Australia Q : Russia H : Korea M : Other Areas  $\Delta$  indicates safety critical components.

3: CD-403/403-S/DPF-R3030/R3030-S 4: CD-404/DPF-R4030/R4030-S 6: CD-406/DPF-R6030

\* New Parts

Parts without **Parts No.** are not supplied.  
 Les articles non mentionnés dans le **Parts No.** ne sont pas fournis.  
 Teile ohne **Parts No.** werden nicht geliefert.

7

Ref. No	Add-ress	New Parts	Parts No.	Description	Desti-nation	Re-marks
J3			E11-0347-05	MINIATURE PHONE JACK(2P)		
J4			E11-0127-05	PHONE JACK (3P)		
-			J19-3647-14	HOLDER		
E11 -14			J11-0808-05	WIRE CLAMPER		
E15			J11-0808-05	WIRE CLAMPER		
L1 ,2			L40-1001-82	SMALL FIXED INDUCTOR(10UH)		
L3			L40-1001-82	SMALL FIXED INDUCTOR(10UH)		
X1			L77-2190-05	CRYSTAL RESONATOR(16.9344MHZ)		
X2			L78-0284-05	RESONATOR (5MHZ)		
CP1			R90-0483-05	MULTI-COMP 100KX13	J 1/6W	34
CP2			R90-0895-05	MULTI-COMP 10KX9		
CP3			R90-0892-05	MULTI-COMP 4.7KX5		
R2			RK73FB2A104J	CHIP R 100K	J 1/10W	
R3			RK73FB2A471J	CHIP R 470	J 1/10W	
R4			RK73FB2A102J	CHIP R 1.0K	J 1/10W	
R5			RK73FB2A471J	CHIP R 470	J 1/10W	
R6			RK73FB2A822J	CHIP R 8.2K	J 1/10W	
R7			RK73FB2A303J	CHIP R 30K	J 1/10W	34
R7			RK73FB2A393J	CHIP R 39K	J 1/10W	6
R8			RK73FB2A103J	CHIP R 10K	J 1/10W	34
R8			RK73FB2A153J	CHIP R 15K	J 1/10W	6
R9			RK73FB2A473J	CHIP R 47K	J 1/10W	
R10			RK73FB2A103J	CHIP R 10K	J 1/10W	
R11 ,12			RK73FB2A101J	CHIP R 100	J 1/10W	
R13			RK73FB2A103J	CHIP R 10K	J 1/10W	
R14			RK73FB2A102J	CHIP R 1.0K	J 1/10W	
R15			RK73FB2A221J	CHIP R 220	J 1/10W	
R18			RK73FB2A472J	CHIP R 4.7K	J 1/10W	
R21			RS14KB3D331J	FL-PROOF RS 330	J 2W	34
R21			RS14KB3D561J	FL-PROOF RS 560	J 2W	6
R31			RK73FB2A102J	CHIP R 1.0K	J 1/10W	
R32			RK73FB2A224J	CHIP R 220K	J 1/10W	
R33 -36			RK73FB2A1R0J	CHIP R 1.0	J 1/10W	
R37			RK73FB2A224J	CHIP R 220K	J 1/10W	
R38			RK73FB2A100J	CHIP R 10	J 1/10W	
R39			RK73FB2A473J	CHIP R 47K	J 1/10W	
R42			RK73FB2A273J	CHIP R 27K	J 1/10W	
R43			RK73FB2A153J	CHIP R 15K	J 1/10W	
R44 ,45			RK73FB2A101J	CHIP R 100	J 1/10W	
R47			RK73FB2A473J	CHIP R 47K	J 1/10W	
R48			RK73FB2A472J	CHIP R 4.7K	J 1/10W	
R49 -50			RK73FB2A103J	CHIP R 10K	J 1/10W	
R51			RK73FB2A364J	CHIP R 360K	J 1/10W	
R52			RK73FB2A474J	CHIP R 470K	J 1/10W	
R54			RK73FB2A224J	CHIP R 220K	J 1/10W	
R55			RK73FB2A912J	CHIP R 9.1K	J 1/10W	
R56			RK73FB2A473J	CHIP R 47K	J 1/10W	
R71			RK73FB2A153J	CHIP R 15K	J 1/10W	
R72			RK73FB2A104J	CHIP R 100K	J 1/10W	
R73			RK73FB2A153J	CHIP R 15K	J 1/10W	
R74			RK73FB2A472J	CHIP R 4.7K	J 1/10W	
R76			RK73FB2A333J	CHIP R 33K	J 1/10W	
R77			RK73FB2A104J	CHIP R 100K	J 1/10W	
R78			RK73FB2A105J	CHIP R 1.0M	J 1/10W	

L : Scandinavia K : USA P : Canada R : Mexico C : China I : Malaysia  
 Y : PX(Far East,Hawaii) T : England E : Europe G : Germany V : China(Shanghai)  
 Y : AAFES(Europe) X : Australia Q : Russia H : Korea M : Other Areas  $\Delta$  indicates safety critical components .

3: CD-403/403-S/DPF-R3030/R3030-S 4: CD-404/DPF-R4030/R4030-S 6: CD-406/DPF-R6030

\* New Parts

Parts without **Parts No.** are not supplied.  
 Les articles non mentionnés dans le **Parts No.** ne sont pas fournis.  
 Teile ohne **Parts No.** werden nicht geliefert.

8

Ref. No	Add-ress	New Parts	Parts No.	Description	Desti-nation	Re-marks
R79			RK73FB2A103J	CHIP R 10K	J 1/10W	
R80 ,81			RK73FB2A332J	CHIP R 3.3K	J 1/10W	
R82			RK73FB2A471J	CHIP R 470	J 1/10W	
R84			RD14NB2E100J	RD 10	J 1/4W	
R87 ,88			RK73FB2A472J	CHIP R 4.7K	J 1/10W	
R89			RK73FB2A473J	CHIP R 47K	J 1/10W	
R90			RK73FB2A222J	CHIP R 2.2K	J 1/10W	
R91 -96			RK73FB2A103J	CHIP R 10K	J 1/10W	34
R111,112			RK73FB2A103J	CHIP R 10K	J 1/10W	
R113			RK73FB2A133J	CHIP R 13K	J 1/10W	
R114			RK73FB2A332J	CHIP R 3.3K	J 1/10W	
R115,116			RK73FB2A181J	CHIP R 180	J 1/10W	
R117			RK73FB2A332J	CHIP R 3.3K	J 1/10W	
R134			RK73FB2A471J	CHIP R 470	J 1/10W	6
R135			RK73FB2A223J	CHIP R 22K	J 1/10W	6
R151-154			RK73FB2A332J	CHIP R 3.3K	J 1/10W	6
R155-158			RK73FB2A272J	CHIP R 2.7K	J 1/10W	6
R159-162			RK73FB2A183J	CHIP R 18K	J 1/10W	6
R163-168			RK73FB2A472J	CHIP R 4.7K	J 1/10W	6
R183-186			RK73FB2A362J	CHIP R 3.6K	J 1/10W	34
R187,188			RK73FB2A182J	CHIP R 1.8K	J 1/10W	34
R189,190			RK73FB2A104J	CHIP R 100K	J 1/10W	
R191,192			RK73FB2A752J	CHIP R 7.5K	J 1/10W	
R193,194			RK73FB2A561J	CHIP R 560	J 1/10W	
R195,196			RK73FB2A331J	CHIP R 330	J 1/10W	
R211,212			RK73FB2A104J	CHIP R 100K	J 1/10W	46
R215,216			RD14NB2E470J	RD 47	J 1/4W	46
R217,218			RK73FB2A102J	CHIP R 1.0K	J 1/10W	46
R231			RD14NB2E4R7J	RD 4.7	J 1/4W	
R232			RD14NB2E331J	RD 330	J 1/4W	6
R233			RK73FB2A223J	CHIP R 22K	J 1/10W	6
R234			RK73FB2A104J	CHIP R 100K	J 1/10W	6
R235			RK73FB2A151J	CHIP R 150	J 1/10W	6
R236			RK73FB2A750J	CHIP R 75	J 1/10W	6
R237			RK73FB2A220J	CHIP R 22	J 1/10W	6
R238			RK73FB2A471J	CHIP R 470	J 1/10W	6
R241,242			RK73FB2A331J	CHIP R 330	J 1/10W	
R243-246			RK73FB2A104J	CHIP R 100K	J 1/10W	
R401			RK73FB2A472J	CHIP R 4.7K	J 1/10W	34
R402			RK73FB2A563J	CHIP R 56K	J 1/10W	34
R403			RK73FB2A183J	CHIP R 18K	J 1/10W	34
R404			RK73FB2A822J	CHIP R 8.2K	J 1/10W	34
R405			RK73FB2A472J	CHIP R 4.7K	J 1/10W	34
R406			RK73FB2A272J	CHIP R 2.7K	J 1/10W	34
R407			RK73FB2A132J	CHIP R 1.3K	J 1/10W	34
R408			RK73FB2A361J	CHIP R 360	J 1/10W	34
R409			RK73FB2A472J	CHIP R 4.7K	J 1/10W	34
R410			RK73FB2A183J	CHIP R 18K	J 1/10W	34
R411			RK73FB2A822J	CHIP R 8.2K	J 1/10W	34
R412			RK73FB2A472J	CHIP R 4.7K	J 1/10W	34
R413			RK73FB2A272J	CHIP R 2.7K	J 1/10W	34
R414			RK73FB2A132J	CHIP R 1.3K	J 1/10W	34
R415			RK73FB2A361J	CHIP R 360	J 1/10W	34
R416			RK73FB2A472J	CHIP R 4.7K	J 1/10W	34
R417			RK73FB2A183J	CHIP R 18K	J 1/10W	34

L : Scandinavia K : USA P : Canada R : Mexico C : China I : Malaysia  
 Y : PX(Far East,Hawaii) T : England E : Europe G : Germany V : China(Shanghai)  
 Y : AAFES(Europe) X : Australia Q : Russia H : Korea M : Other Areas  $\Delta$  indicates safety critical components .

3: CD-403/403-S/DPF-R3030/R3030-S 4: CD-404/DPF-R4030/R4030-S 6: CD-406/DPF-R6030

CD-403/403-S/404/406/DPF-R3030/R3030-S/R4030/R4030-S/R6030  
 PARTS LIST



\* New Parts

Parts without **Parts No.** are not supplied.Les articles non mentionnés dans le **Parts No.** ne sont pas fournis.Teile ohne **Parts No.** werden nicht geliefert.

9

Ref. No	Add-ress	New Parts	Parts No.	Description	Desti-nation	Re-marks
R418			RK73FB2A822J	CHIP R 8.2K J 1/10W		34
R419			RK73FB2A472J	CHIP R 4.7K J 1/10W		34
R420			RK73FB2A272J	CHIP R 2.7K J 1/10W		34
R421			RK73FB2A132J	CHIP R 1.3K J 1/10W		34
R422			RK73FB2A361J	CHIP R 360 J 1/10W		34
R423			RD14NB2E1R0J	RD 1.0 J 1/4W		34
R424			RK73FB2A473J	CHIP R 47K J 1/10W		34
R501			RD14NB2E2R2J	RD 2.2 J 1/4W		
R502-507			RK73FB2A331J	CHIP R 330 J 1/10W		
R508			RK73FB2A473J	CHIP R 47K J 1/10W		
R529-533			RK73FB2A331J	CHIP R 330 J 1/10W		
R534			RK73FB2A472J	CHIP R 4.7K J 1/10W		
R538			RK73FB2A102J	CHIP R 1.0K J 1/10W		
R539			RK73FB2A104J	CHIP R 100K J 1/10W		
R540			RK73FB2A331J	CHIP R 330 J 1/10W		
R551			RK73FB2A102J	CHIP R 1.0K J 1/10W		34
R552			RK73FB2A102J	CHIP R 1.0K J 1/10W		6
R553-555			RK73FB2A103J	CHIP R 10K J 1/10W		
VR1			R32-0038-05	SEMI FIXED VARIABLE RESISTOR		
W501-505			R92-0670-05	CHIP R 0 OHM		
W508-511			R92-0670-05	CHIP R 0 OHM		
W514-520			R92-0670-05	CHIP R 0 OHM		
W522-530			R92-0670-05	CHIP R 0 OHM		
S1			S31-2131-05	SLIDE SWITCH (POWER TYPE)	Y1M1	
S401-420			S70-0031-05	TACT SWITCH		34
PH1			T95-0145-05	OPTO ISOLATOR		
D1			D3SBA20F03	DIODE		
D2			S5688B	DIODE		
D7			UDZ8.2B	ZENER DIODE		6
D8			UDZ15B	ZENER DIODE		34
D8			UDZ5.6B	ZENER DIODE		
D9			UDZ5.6B	ZENER DIODE		
D11			MTZJ3.9(B)	ZENER DIODE		34
D11			RD3.9ES(B)	ZENER DIODE		34
D11 -14			MTZJ5.6(B)	ZENER DIODE		6
D11 -14			RD5.6ES(B)	ZENER DIODE		6
D12			MTZJ4.7(B)	ZENER DIODE		34
D12			RD4.7ES(B)	ZENER DIODE		34
D13			MTZJ3.9(B)	ZENER DIODE		34
D13			RD3.9ES(B)	ZENER DIODE		34
D14			MTZJ4.7(B)	ZENER DIODE		34
D14			RD4.7ES(B)	ZENER DIODE		34
D31			MA111	DIODE		
D33			MA111	DIODE		
D35 -37			MA111	DIODE		
D38			UDZ4.7B	ZENER DIODE		
D39 ,40			MA111	DIODE		34
D41 -48			MA111	DIODE		
D62		*	SIR-34ST3F	INFRARED LED		
ED1			10-BT-131GK	FLUORESCENT INDICATOR TUBE		34
IC1			ICP-N25	ANALOGUE IC		
IC2			ICP-N20	ANALOGUE IC		
IC3			PST993D-T	ANALOGUE IC		

L : Scandinavia K : USA P : Canada R : Mexico C : China I : Malaysia

Y : PX(Far East,Hawaii) T : England E : Europe G : Germany V : China(Shanghai)

Y : AAFES(Europe) X : Australia Q : Russia H : Korea M : Other Areas  $\Delta$  indicates safety critical components .

3: CD-403/403-S/DPF-R3030/R3030-S 4: CD-404/DPF-R4030/R4030-S 6: CD-406/DPF-R6030

\* New Parts

Parts without **Parts No.** are not supplied.Les articles non mentionnés dans le **Parts No.** ne sont pas fournis.Teile ohne **Parts No.** werden nicht geliefert.

10

Ref. No	Add-ress	New Parts	Parts No.	Description	Desti-nation	Re-marks
IC4			CXA1821M	ANALOGUE IC		
IC5			BA5979S	ANALOGUE IC		
IC6			CXD2587Q*	MOS-IC		
IC7 ,8			TA8409S	MOS-IC		
IC9			KAN03	CUSTOM IC		6
IC11,12			NJM4565M	ANALOGUE IC		6
IC13			NJM4565M	ANALOGUE IC		34
IC14			NJM4580ED	ANALOGUE IC		46
IC15		*	UPD780206GF059	MI-COM IC		
IC16			TC74HCU04AF	IC(HEX INVERTER SMD)		6
IC17		*	S-24C01BFJ	MEMORY IC		
PH2			RPT-38PT3F	PHOTO TRANSISTOR		
Q1			2SB1370	TRANSISTOR		
Q1			2SB1375	TRANSISTOR		
Q3			2SC4081(R,S)	TRANSISTOR		
Q3			2SC4116(Y,GR)	TRANSISTOR		
Q4			DTA124EUA	DIGITAL TRANSISTOR		
Q4			UN5112	DIGITAL TRANSISTOR		
Q5			2SA1576A(R,S)	TRANSISTOR		
Q5			2SA1586(Y,GR)	TRANSISTOR		
Q6			2SB1370	TRANSISTOR		
Q6			2SB1375	TRANSISTOR		
Q7			2SC3940A(R,S)	TRANSISTOR		
Q8			DTC124EUA	DIGITAL TRANSISTOR		
Q8			UN5212	DIGITAL TRANSISTOR		
Q9			2SC3940A(R,S)	TRANSISTOR		
Q10			DTC124EUA	DIGITAL TRANSISTOR		
Q10			UN5212	DIGITAL TRANSISTOR		
Q11 ,12			2SD1450(S,T)	TRANSISTOR		
Q13			2SA954(L,K)	TRANSISTOR		
Q14			2SA1534A	TRANSISTOR		
Q15 ,16			DTA124EUA	DIGITAL TRANSISTOR		
Q15 ,16			UN5112	DIGITAL TRANSISTOR		
Q17 ,18			2SD1450(S,T)	TRANSISTOR		
Q19 ,20			DTC124EUA	DIGITAL TRANSISTOR		
Q19 ,20			UN5212	DIGITAL TRANSISTOR		
Q21			2SA1576A(R,S)	TRANSISTOR		
Q21			2SA1586(Y,GR)	TRANSISTOR		
Q23			DTA124EUA	DIGITAL TRANSISTOR		
Q23			UN5112	DIGITAL TRANSISTOR		
A1			W02-1114-15	OSCILLATING MODULE		
A2			W02-2537-05	ELECTRIC CIRCUIT MODULE		34
<b>MECHANISM ASSY (X92-2150-10/X92-2160-21)</b>						
1	3B		A10-3360-01	CHASSIS		
2	1A		A11-1126-02	SUB CHASSIS		
3	1A		A11-1127-12	SUB CHASSIS		
5	2B		B09-0255-04	CAP		
7	2A		D10-3740-13	ARM		
8	2B		D10-3741-02	SLIDER		
9	1A		D13-1829-04	GEAR		
10	2A		D13-1830-14	GEAR		
11	2A		D13-1831-04	GEAR		
12	2D		D13-1833-04	WORM		
13	2C		D13-1832-04	GEAR		

L : Scandinavia K : USA P : Canada R : Mexico C : China I : Malaysia

Y : PX(Far East,Hawaii) T : England E : Europe G : Germany V : China(Shanghai)

Y : AAFES(Europe) X : Australia Q : Russia H : Korea M : Other Areas  $\Delta$  indicates safety critical components .

3: CD-403/403-S/DPF-R3030/R3030-S 4: CD-404/DPF-R4030/R4030-S 6: CD-406/DPF-R6030

\* New Parts

Parts without **Parts No.** are not supplied.

Les articles non mentionnés dans le **Parts No.** ne sont pas fournis.

Teile ohne **Parts No.** werden nicht geliefert.



Ref. No	Add-ress	New Parts	Parts No.	Description	Desti-nation	Re-marks
14	2A,2C		D14-0389-04	ROLLER		
16	3A		D15-0407-04	MOTOR PULLEY		
17	1A		D16-0355-03	BELT		
18	2A		D21-1763-14	SHAFT		
19	1B		D10-3606-08	RDD (TRAVERSE)		
20	1B		D13-1720-08	GEAR (TRAVERSE)		
25	1E,2D		E35-0747-25	FLAT CABLE (16P)		
26	1B,1E	*	E35-2538-05	FLAT CABLE		
28	2B		E40-3264-05	PIN ASSY (TRAVERSE)		
35	1C		G01-4130-04	COMPRESSION SPRING		
36	2B		G01-3753-04	COMPRESSION SPRING		
37	2B		G01-4124-04	COMPRESSION SPRING		
38	3A		G02-1049-04	FLAT SPRING		
39	2D		G09-0634-04	WIRE SPRING		
41	2C		G02-1631-04	FLAT SPRING		
43	2B	*	J02-1462-04	INSULATOR		
44	1A		J11-0835-04	CLAMPER ASSY		
45	2D		J19-5818-04	HOLDER		
46	2A		J90-0851-04	GUIDE		
47	2E		J90-0852-02	GUIDE		
48	2C		J99-0801-01	TRAY		
49	1C		J99-0596-01	TRAY		
55	2A		S33-2061-05	LEVER SWITCH		
56	2B		S74-0038-08	LEAF SWITCH (TRAVERSE)		
64	1A		T99-0544-15	MAGNET		
-			D40-1515-05	MECHA ASSY (TRAVERSE)		
-			G10-0489-04	NON-WOVEN FABRIC		
AA			N09-1522-05	SET SCREW (3X8)		
AB			N82-2608-46	BINDING HEAD TAPTITE SCREW		
AC			N89-2610-46	BINDING HEAD TAPTITE SCREW		
AE			N89-3010-46	BINDING HEAD TAPTITE SCREW		
AG			N89-3008-46	BINDING HEAD TAPTITE SCREW		
AJ			N19-0891-04	FLAT WASHER		
AL			N09-3144-05	SET SCREW (3X10,+,10)		
AN			N19-1352-04	FLAT WASHER		
AP			N19-1378-04	FLAT WASHER		
DM	1B		A11-1082-18	DISC MOTOR ASSY (TRAVERSE)		
FM	2B		T42-0817-08	FEED MOTOR (TRAVERSE)		
LM	3A		T42-0524-05	DC MOTOR		
PU	1B		T25-0061-08	PICKUP (KSS-213C)(TRAVERSE)		
RM	2D		T42-0670-15	DC MOTOR		

L : Scandinavia K : USA P : Canada R : Mexico C : China I : Malaysia

Y : PX(Far East,Hawaii) T : England E : Europe G : Germany V : China(Shanghai)

Y : AAFES(Europe) X : Australia Q : Russia H : Korea M : Other Areas

Δ Indicates safety critical components.

3: CD-403/403-S/DPF-R3030/R3030-S

4: CD-404/DPF-R4030/R4030-S

6: CD-406/DPF-R6030

#### HOW TO READ THE PARTS LIST

#### ABBREVIATION OF MODEL AND MASS PRODUCTION'S DESTINATIONS

MODEL	ABB.	Australia	Canada	China	England	Europe	Germany	Korea	Malaysia
CD-403	3	-	-	P1	-	-	-	-	-
CD-403-S	3	-	-	-	-	-	-	-	-
DPF-R3030	3	-	-	-	-	E1	-	-	-
DPF-R3030-S	3	X1	-	-	-	E2	-	-	-
CD-404	4	-	-	P1	-	-	-	-	-
DPF-R4030	4	-	-	-	T1	E1	-	-	-
DPF-R4030-S	4	X1	-	-	-	-	-	-	-
CD-406	6	-	-	-	-	-	-	-	-
DPF-R6030	6	-	-	-	T1	E1	-	-	-
MODEL	ABB.	Mexico	PX/AAFES	Russia	Scandinavia	Shanghai	USA	Other area	
CD-403	3	-	-	-	-	-	K	-	-
CD-403-S	3	-	-	-	-	-	K1	-	-
DPF-R3030	3	-	Y1	-	-	-	-	-	-
DPF-R3030-S	3	-	-	-	-	-	-	M1	-
CD-404	4	-	-	-	-	-	K	-	-
DPF-R4030	4	-	-	-	-	-	-	-	-
DPF-R4030-S	4	-	-	-	-	-	-	M1	-
CD-406	6	-	-	-	-	-	K	-	-
DPF-R6030	6	-	Y1	-	-	-	-	-	-

**CD-403/403-S/404/406/DPF-R3030/R3030-S/R4030/R4030-S/R6030**  
**PARTS LIST**

# CD-403/403-S/404/406/DPF-R3030/R3030-S/R4030/R4030-S/R6030

## SPECIFICATIONS

### CD-406/DPF-R6030

#### [ Format ]

System ..... Compact disc digital audio system  
Laser ..... Semiconductor laser

#### [ D/A Convertors ]

D/A Conversion ..... 1 Bit (D.R.I.V.E.)  
Oversampling ..... 8 fs (352.8 kHz)

#### [ Audio ]

Frequency response ..... 4 Hz ~ 20 kHz,  $\pm 0.5$  dB  
Signal to noise ratio ..... More than 105 dB  
Dynamic range ..... More than 95 dB  
Total harmonic distortion + noise  
..... Less than 0.005% (at 1 kHz)  
Wow & flutter ..... Unmeasurable Limit  
Output level/impedance  
Variable ..... (Max.) 2 V/1  $\Omega$   
Digital output  
Coaxial ..... 0.5 V p-p / 75 $\Omega$   
Optical ..... -15 dBm ~ -21 dBm  
(Wave length 660 nm)  
Headphone output ..... (Max.) 20 mW (32 $\Omega$ )

#### [ Laser ]

Wave length ..... 760 nm ~ 800 nm  
Laser power class ..... Class 1 (IEC)

#### [ General ]

Power consumption ..... 14 W  
Dimensions ..... W : 440 mm (17-5/16")  
H : 124.5 mm (4-15/16")  
D : 398 mm (15-5/8")  
Weight (Net) ..... 5.1 kg (11.2 lb)

### CD-404/403/DPF-R4030/3030

#### [ Format ]

System ..... Compact disc digital audio system  
Laser ..... Semiconductor laser

#### [ D/A Convertors ]

D/A Conversion ..... 1 Bit  
Oversampling ..... 8 fs (352.8 kHz)

#### [ Audio ]

Frequency response ..... 4 Hz ~ 20 kHz,  $\pm 0.5$  dB  
Signal to noise ratio ..... More than 100 dB  
Dynamic range ..... More than 93 dB  
Total harmonic distortion + noise  
..... Less than 0.005% (at 1 kHz)  
Wow & flutter ..... Unmeasurable Limit  
Output level/impedance  
Fixed (CD-403/DPF-R3030) ..... 2 V/1  $\Omega$   
Variable (CD-404/DPF-R4030) ..... (Max.) 2 V/1  $\Omega$   
Headphone output (Max.)  
(CD-404/DPF-R4030 only) ..... 20 mW (32 $\Omega$ )

#### [ Laser ]

Wave length ..... 760 nm ~ 800 nm  
Laser power class ..... Class 1 (IEC)

#### [ General ]

Power consumption ..... 14 W  
Dimensions ..... W : 440 mm (17-5/16")  
H : 124.5 mm (4-15/16")  
D : 398 mm (15-5/8")  
Weight (Net) ..... 5.1 kg (11.2 lb)



1. KENWOOD follows a policy of continuous advancements in development. For this reason specifications may be changed without notice.
2. The full performance may not be exhibited in an extremely cold location (under a water-freezing temperature).

#### Note:

Component and circuit are subject to modification to insure best operation under differing local conditions. This manual is based on Europe (E) standard, and provides information on regional circuit modification through use of alternate schematic diagrams, and information on regional component variations through use of parts list.

## KENWOOD CORPORATION

14-6, Dogenzaka 1-chome, Shibuya-ku, Tokyo, 150-8501 Japan

### KENWOOD SERVICE CORPORATION

P.O. BOX 22745, 2201 East Dominguez St., Long Beach, CA 90801-5745, U.S.A.

### KENWOOD ELECTRONICS CANADA INC.

6070 Kestrel Road, Mississauga, Ontario, Canada L5T 1S8

### KENWOOD ELECTRONICS LATIN AMERICA S.A.

P.O. BOX 55-2791, Piso 6 plaza Chase, Cl. 47 y Aquilino de la Guardia Panama, Republic de Panama

### KENWOOD ELECTRONICS BRASIL LTDA.

Av. Moema, 170-17, Andar-Cobertura "B", Ed. Maximum Service Center, 04077-020 Moema, São Paulo-SP-Brasil

### KENWOOD ELECTRONICS U.K. LIMITED

KENWOOD House, Dwight Road, Watford, Herts., WD1 8EB., United Kingdom

### KENWOOD ELECTRONICS BELGIUM N.V.

Meachelsesteenweg 418, B-1930 Zaventem, Belgium

### KENWOOD ELECTRONICS DEUTSCHLAND GMBH

Rembrücker Str. 15, 63150 Heusenstamm, Germany

### KENWOOD ELECTRONICS FRANCE S.A.

13 Boulevard Ney, 75018 Paris, France

### KENWOOD ELECTRONICS ITALIA S.p.A.

Via G. Sirtori, 7/9 20129, Milano, Italy

### KENWOOD IBÉRICA S.A.

Bolivia, 239-08020 Barcelona, Spain

### KENWOOD ELECTRONICS AUSTRALIA PTY. LTD.

(A.C.N. 001 499 074)  
16 Giffnock Avenue, North Ryde, N.S.W. 2113, Australia

### KENWOOD ELECTRONICS (HONG KONG) LTD.

Unit 3712-3724, Level 37, Tower 1, Metroplaza, 223 Hing Fong Road, Kwai Fong N.T., Hong Kong

### KENWOOD ELECTRONICS GULF FZE

P.O. Box 61318, Jebel Ali, Dubai, U.A.E.

### KENWOOD ELECTRONICS SINGAPORE PTE LTD.

No. 1 Genting Lane #02-02, KENWOOD Building, Singapore, 349544

### KENWOOD ELECTRONICS (MALAYSIA) SDN BHD.

#4.01 Level 4, Wisma Academy Lot 4A, Jalan 19/1 46300 Petaling Jaya Selangor Darul Ehsan Malaysia

### KENWOOD ELECTRONICS (THAILAND) CO., LTD.

2019 New Pechburi Road, Bangkok, Huaykwang, Bangkok, 10320 Thailand