

MULTIPLE COMPACT DISC PLAYER
DP-R5080/R6080/R8080V
SERVICE MANUAL

KENWOOD

© 1996-3/B51-5154-00 (K/K) 3838

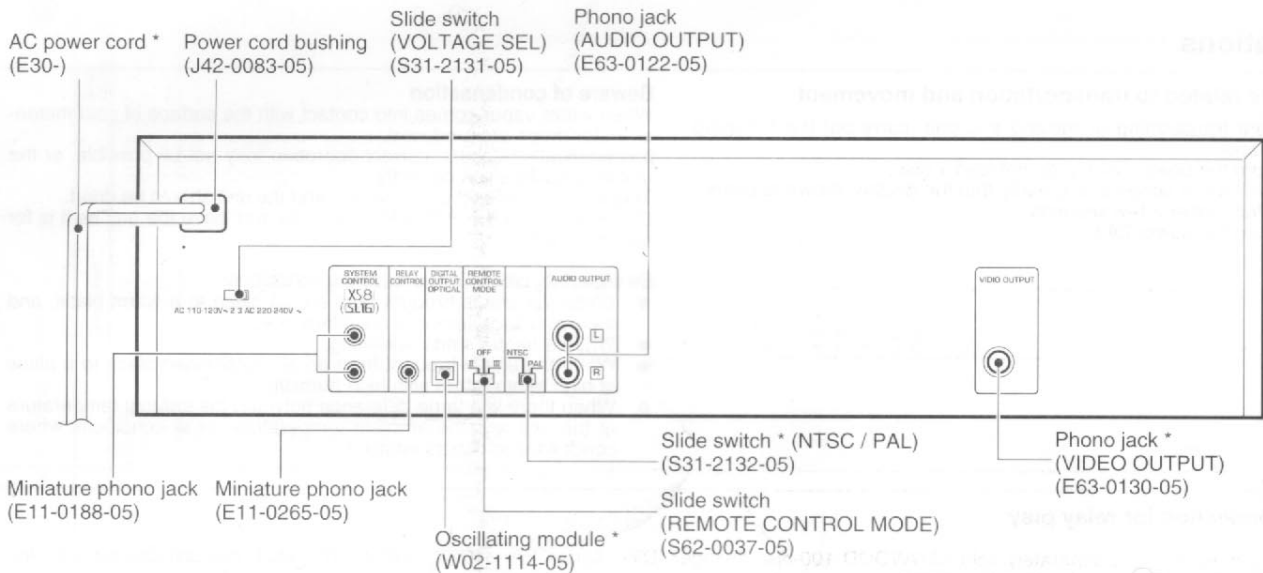
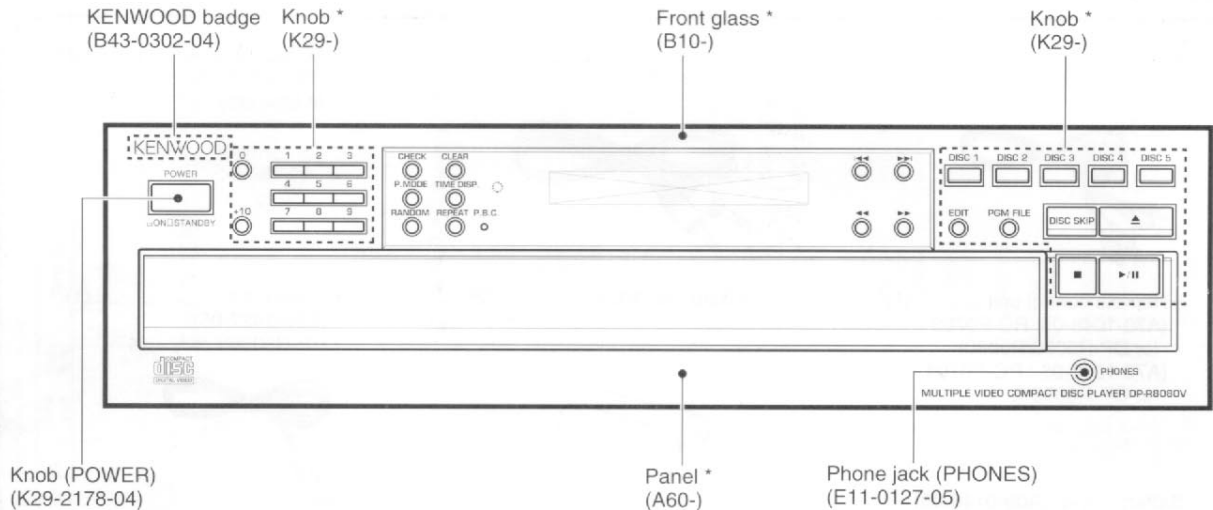

Illustration is DP-R8080V.

*** Refer to parts list on page 30.**

KENWOOD-Corp. certifies this equipment conforms to DHHS Regulations No. 21 CFR 1040. 10, Chapter 1, Subchapter J.

DANGER : Laser radiation when open and interlock defeated. AVOID DIRECT EXPOSURE TO BEAM.

In compliance with Federal Regulations, following are reproductions of labels on, or inside the product relating to laser product safety.



BLOCK DIAGRAM

DP-R5080/R6080/R8080V

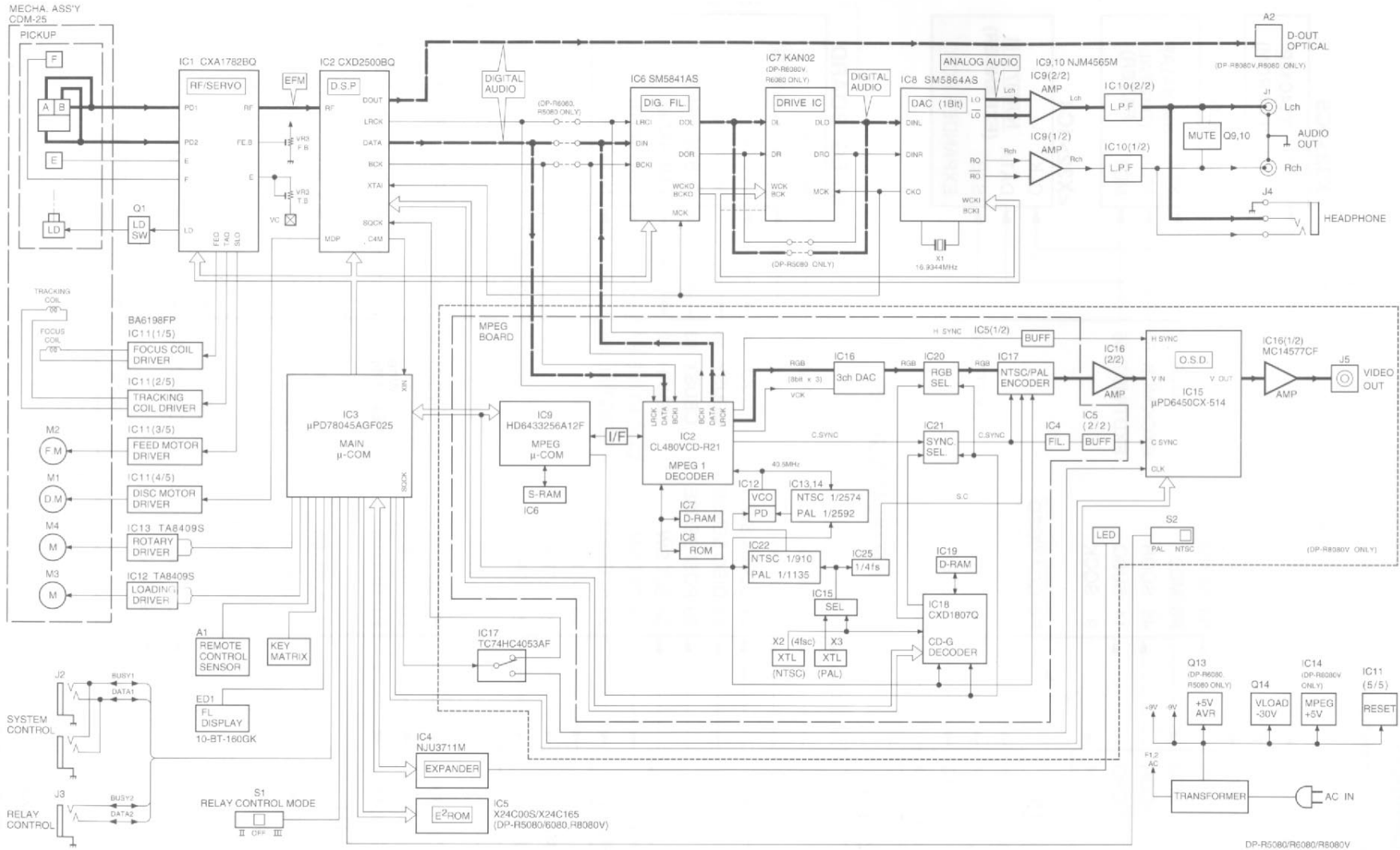

DP-R5080/R6080/R8080V

DP-R5080/R6080/R8080V

ADJUSTMENT

No.	ITEM	INPUT SETTINGS	OUTPUT SETTINGS	PLAYER SETTINGS	ALIGNMENT POINTS	ALIGN FOR	FIG.
Open the tray (Normal mode), then turn the power off.							
1	LASER POWER	-	Apply the sensor section of optical power meter on the pickup lens.	While pressing the TIME DISP. key, turn the AC ON. (Test mode) Press the PLAY/PAUSE key, then confirm that the display is "03".	-	On the power from 0.08 to 0.15 mW, when the diffraction grating is correctly aligned with the RF level of 1.0 Vp-p or more.	(a)
1. Press the STOP key. 2. Press the OPEN key. 3. Load a disc, then press the CLOSE key. 4. Press the PLAY key. 5. Press the OPEN key to open the tray. 6. Turn the power off. (Player stops as the tray is opened while the disc clumped.) 7. While pressing the TIME DISP. key, turn the power ON to enter the Test mode.							
2	TRACKING ERROR BALANCE	Test disc Type 4	Connect an oscilloscope as follows. CH1:RF (CN2 pin 1) CH2:TE (CN2 pin 6)	Press the PLAY/PAUSE key, then confirm that the display is "03".	TE BALANCE VR1 (X32-)	Symmetry between upper and lower patterns	(c)
3	FOCUS ERROR BALANCE	Test disc Type 4	Connect an oscilloscope as follows. CH1:RF (CN2 pin 1) CH2:TE (CN2 pin 6)	Press the PLAY/PAUSE key, then confirm that the display is "05".	FE BALANCE VR3 (X32-)	Optimum eye pattern	(b) or (d)
4	TRACKING GAIN	Test disc Type 4 Apply signal of 1.2 kHz, 50mVrms to CN2 pin 5-6.	Connect a LPF to CN2 pin 5-6 to which you connect an oscilloscope or AC voltmeters.	Press the PLAY/PAUSE key, then confirm that the display is "05".	TRACKING GAIN VR2 (X32-)	Two VTVMs should read the same value.	(e)
5	NTSC 4 fsc	POWER ON	Connect a frequency counter to check land (14M) of IC 18 pin 18.	STOP	TC1 (X35-)	14.31818MHz \pm 50Hz	
6	PAL 4 fsc	POWER ON	Connect a frequency counter to check land (17M) of IC18 pin 20.	STOP	TC2 (X35-)	17.73447 MHz \pm 50Hz	

Note:

Type 4 disc : SONY YEDS-18 Test Disc or equivalent.
 LPF: Around 47 k Ω + 390 pF or so.
 Step 1~6 are in Test Mode.
 Step 5,6 are in DP-R8080V.

(a) Laser power

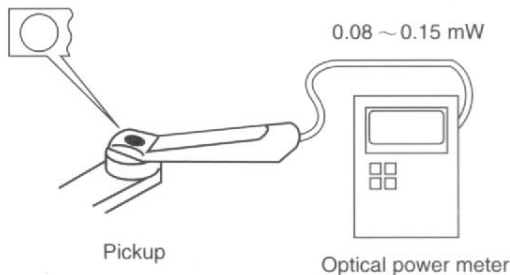

(e) Tracking gain

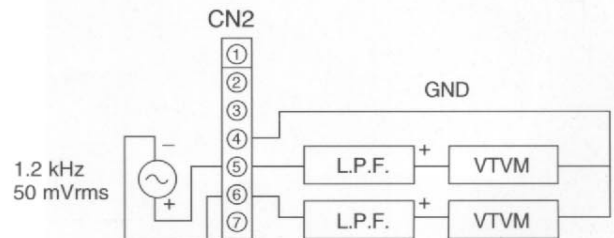

DP-R5080/R6080/R8080V

ADJUSTMENT

FIG. (b)

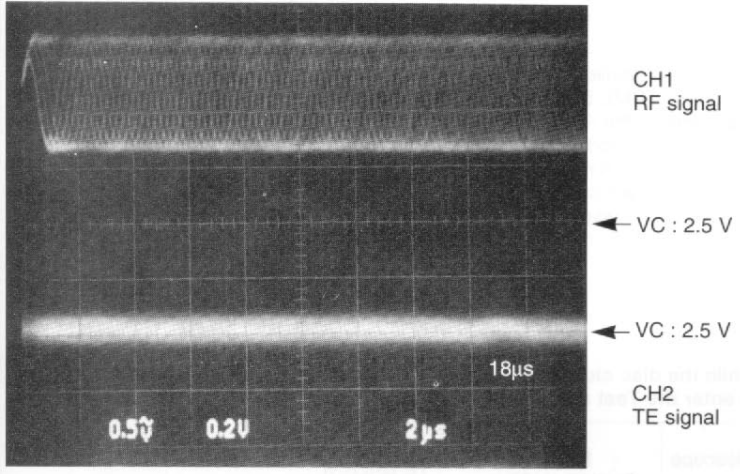

- RF signal and TE signal in test mode (PLAY).
- If the diffraction grating has been adjusted correctly, the influence of triggering is observed on the TE waveform of approx. 18µs from RF signal trigger point, in the form of a projection.

FIG. (c)

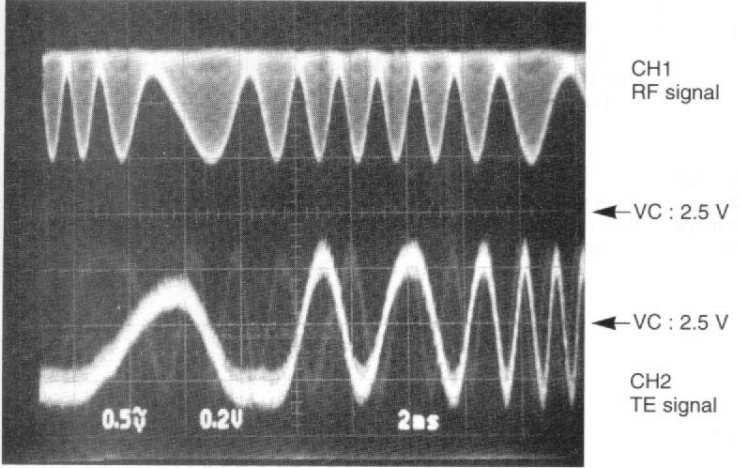

- RF signal and TE signal in test mode (Focusing servo ON / Tracking servo OFF). (Disc Type 4)
- Adjust TE signal so that the waveform is symmetrical in relation to VC. (TE BALANCE)

FIG. (d)

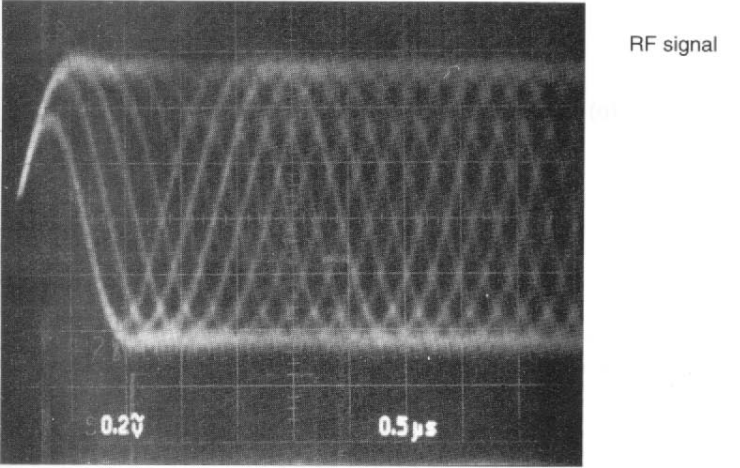

- RF signal in test mode (PLAY).
- Perform the tangential and focusing offset are focused into one point on the display. The crossing points above and below the center shall also be looked clearly. (FE BALANCE)

PC BOARD (Component side view)

CD player unit (X32-3080-XX)

10 : DP-R5080 K

22 : DP-R6080 Y

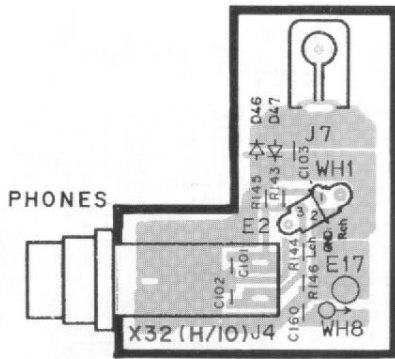

TEST MODE STEP 8

- (c) Tracking error balance : Symmetry between upper patterns.
- (b or d) Focus error balance : Optimum eye pattern.

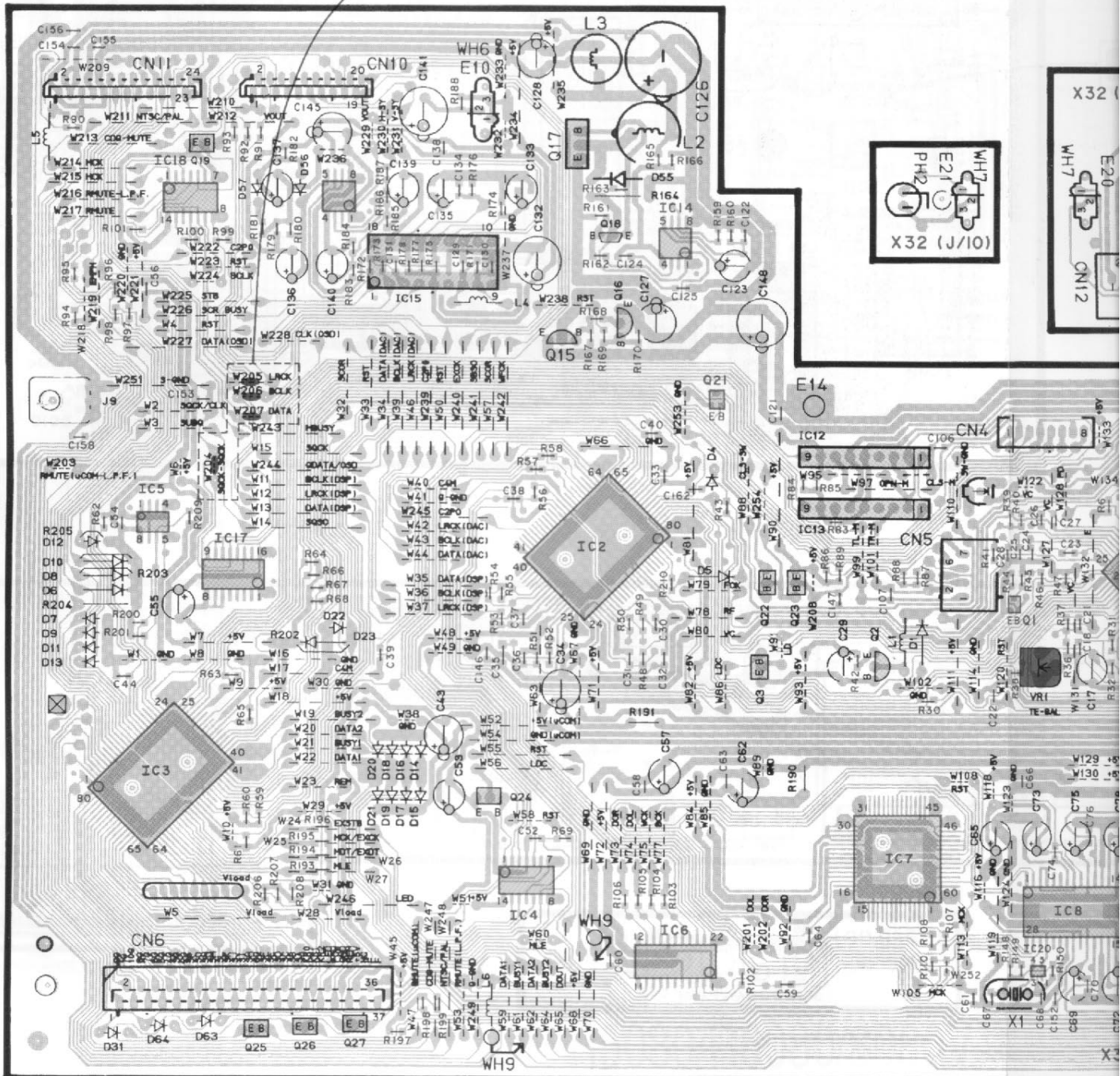
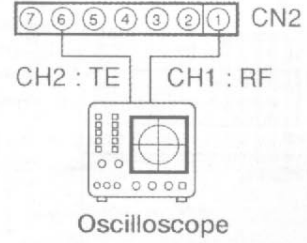

Refer to the schematic diagram for the values of resistors and capacitors.

XX) 10 : DP-R5080 K,P,X
 22 : DP-R6080 Y,M

21 : DP-R5080 M
 12 : DP-R8080 T,E,C

11 : DP-R6080 K,P,X,T,E
 23 : DP-R8080 M

Symmetry between

(e) Tracking gain :
 Two VTVMs should read the same value.

: Optimum eye pattern.

CN2

RF

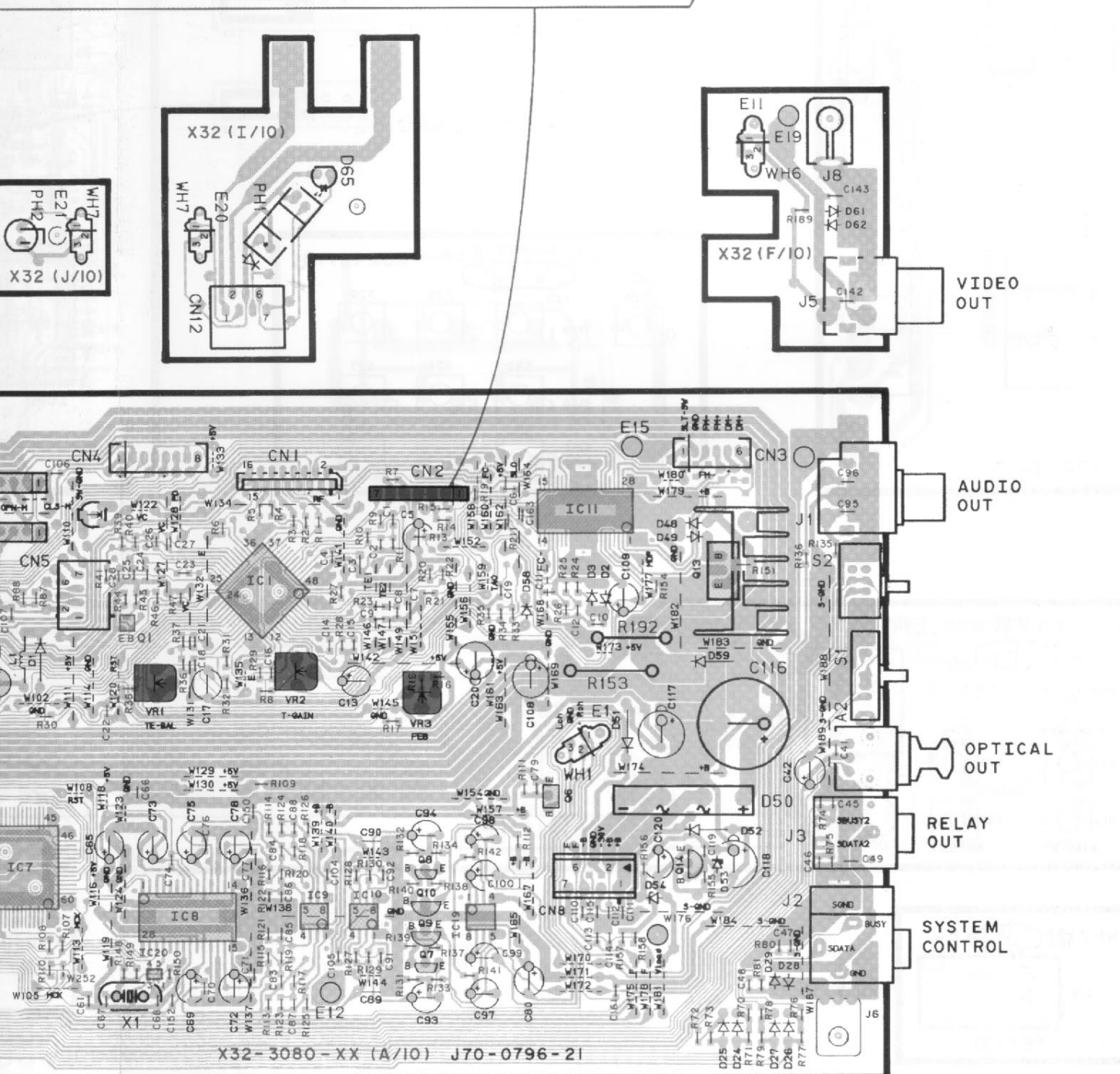
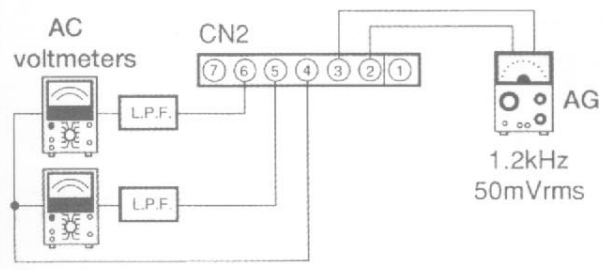

X32-3080-XX (A/10) J70-0796-21

PC BOARD (Component side view)

VIDEO unit (X35-2160-20) : DP-R8080V or

110-120V ↔ 220-240V

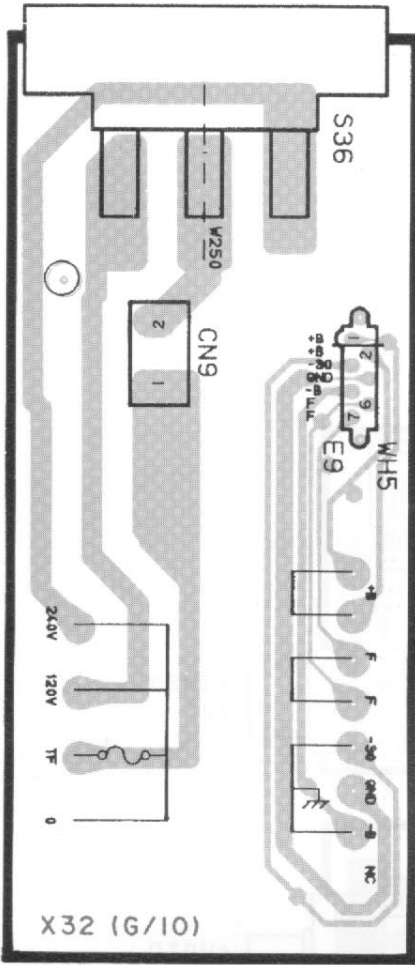

NTSC CROMA f :
3.579545MHz ± 50Hz

PAL 4fsc :
17.73447MHz ± 50Hz

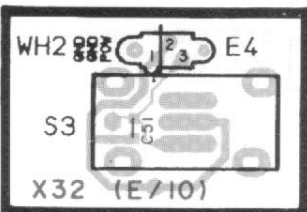
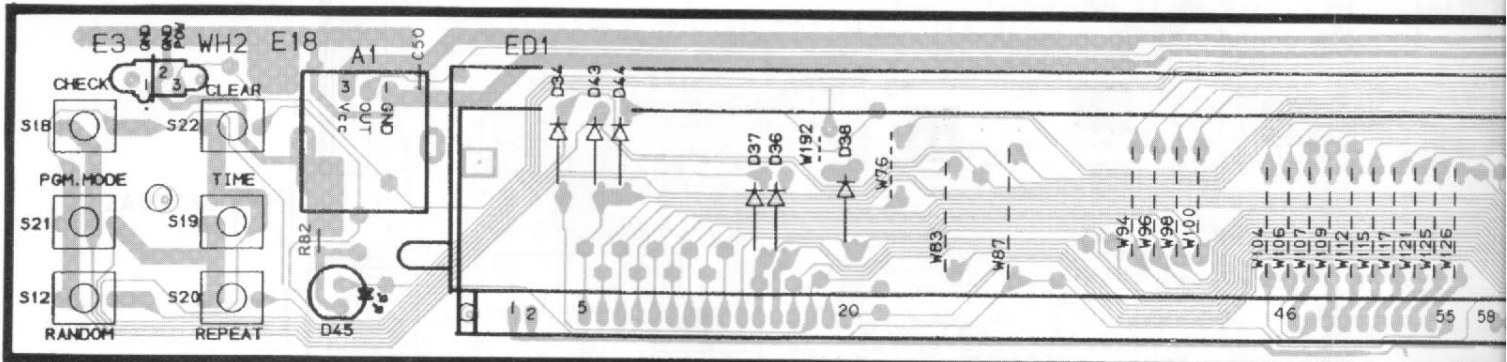
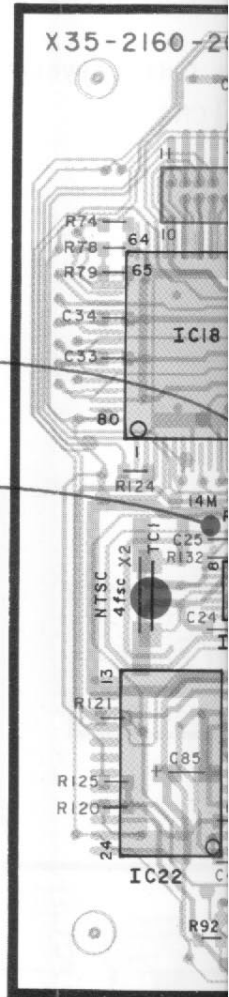
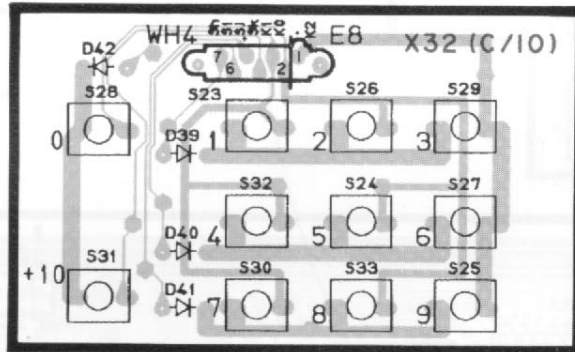

POWER



0) : DP-R8080V only

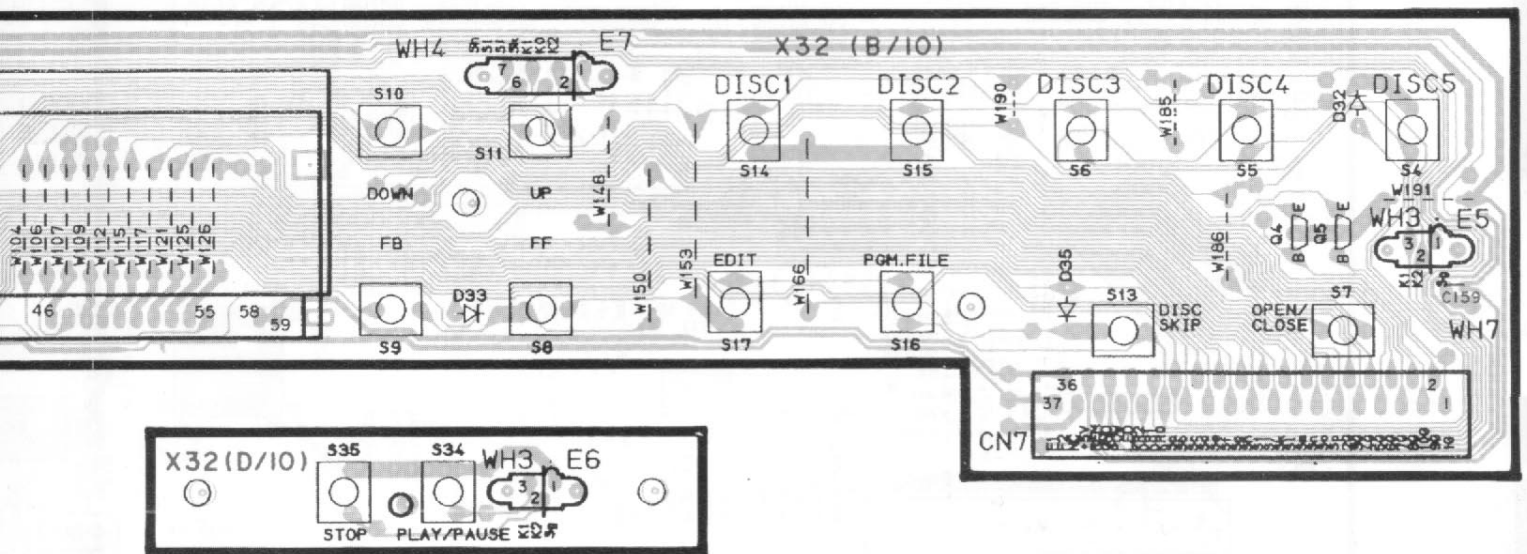
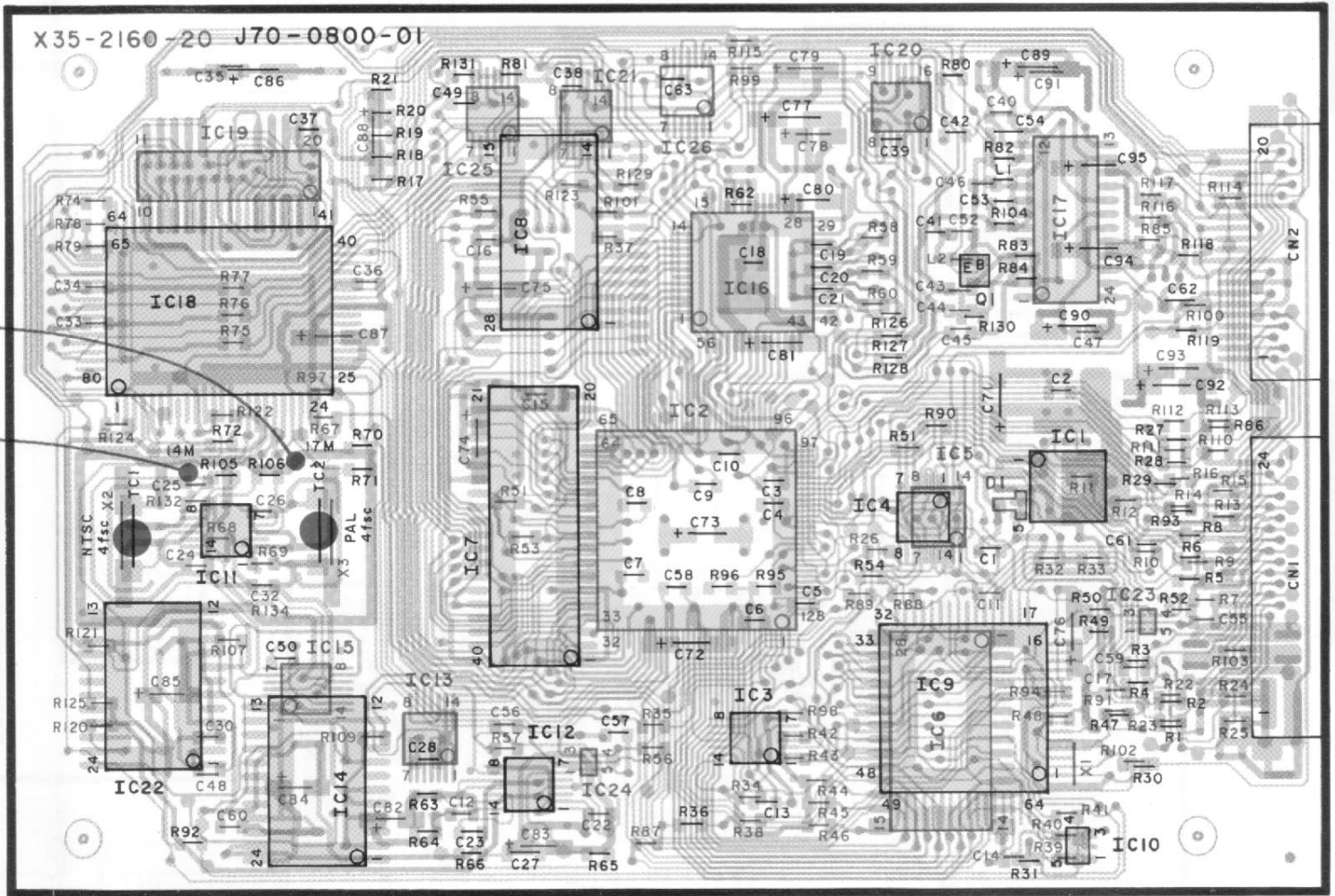

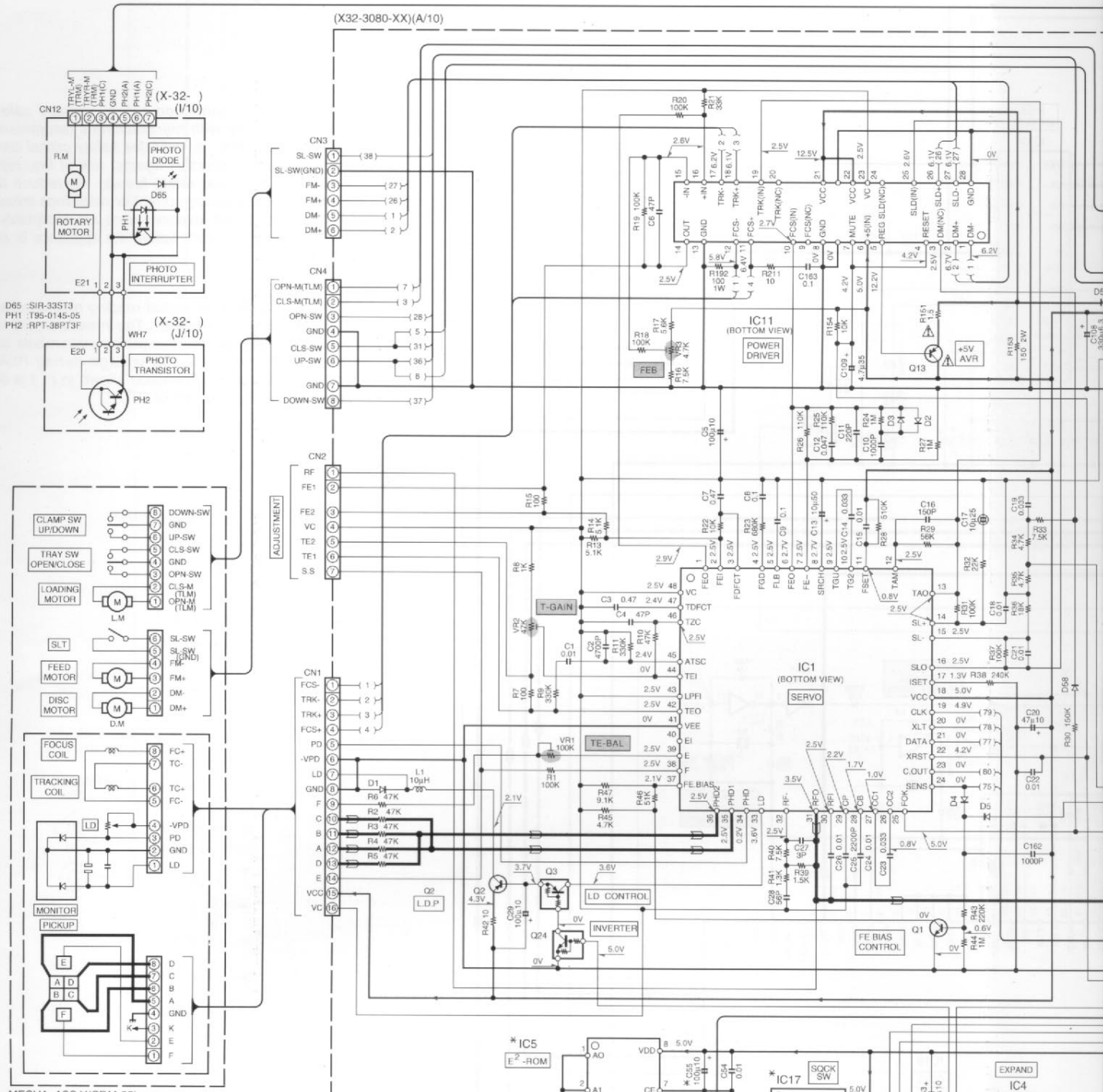

MECHA. ASS Y(CDM-25)
(X92-1930-10/X92-1960-461)

MODEL NAME	DESTINATION COUNTRY	ABB	UNIT No.	(A) (B) (C) (D)	IC5	IC7	IC17	D6-13 22,23	A2	S36	WH-8	WH-9	W250	C41, 42	C55,61, 158,160	C62-64	R58,200, 201	R107,108, 146,190	R202-205	W84,85,86, 92,113	W201, 202	W203-208	
DP-R5080	U.S.A.	K	X32-3080-10		X24C00S	NO	NO	NO	NO	NO	YES	YES	YES	NO	NO	NO	NO	NO	YES	NO	YES	YES	
	CANADA	P	X32-3080-21							YES													
DP-R6080	U.S.A.	K	X32-3080-11		X24C16S	YES	NO	NO	NO	NO	NO	NO	YES	YES	NO	YES	YES	YES	YES	YES	NO	YES	
	CANADA	P	X32-3080-22							YES													
	EUROPE	E	X32-3080-12			NO	YES	YES	YES	NO	YES	NO	YES	YES	YES	NO	NO	NO	NO	NO	YES	NO	
DP-R8080V	U.K.	T	X32-3080-23																				
	GENERAL MARKET	M	X32-3080-23																				

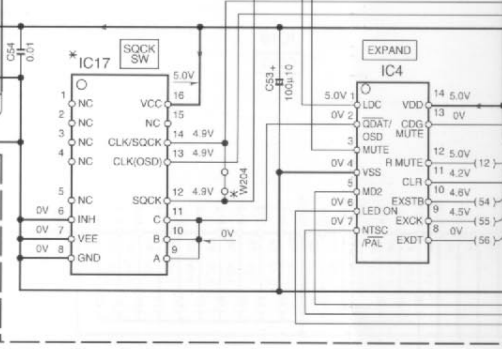

1
2
3
4
5
6
7

V08080806R

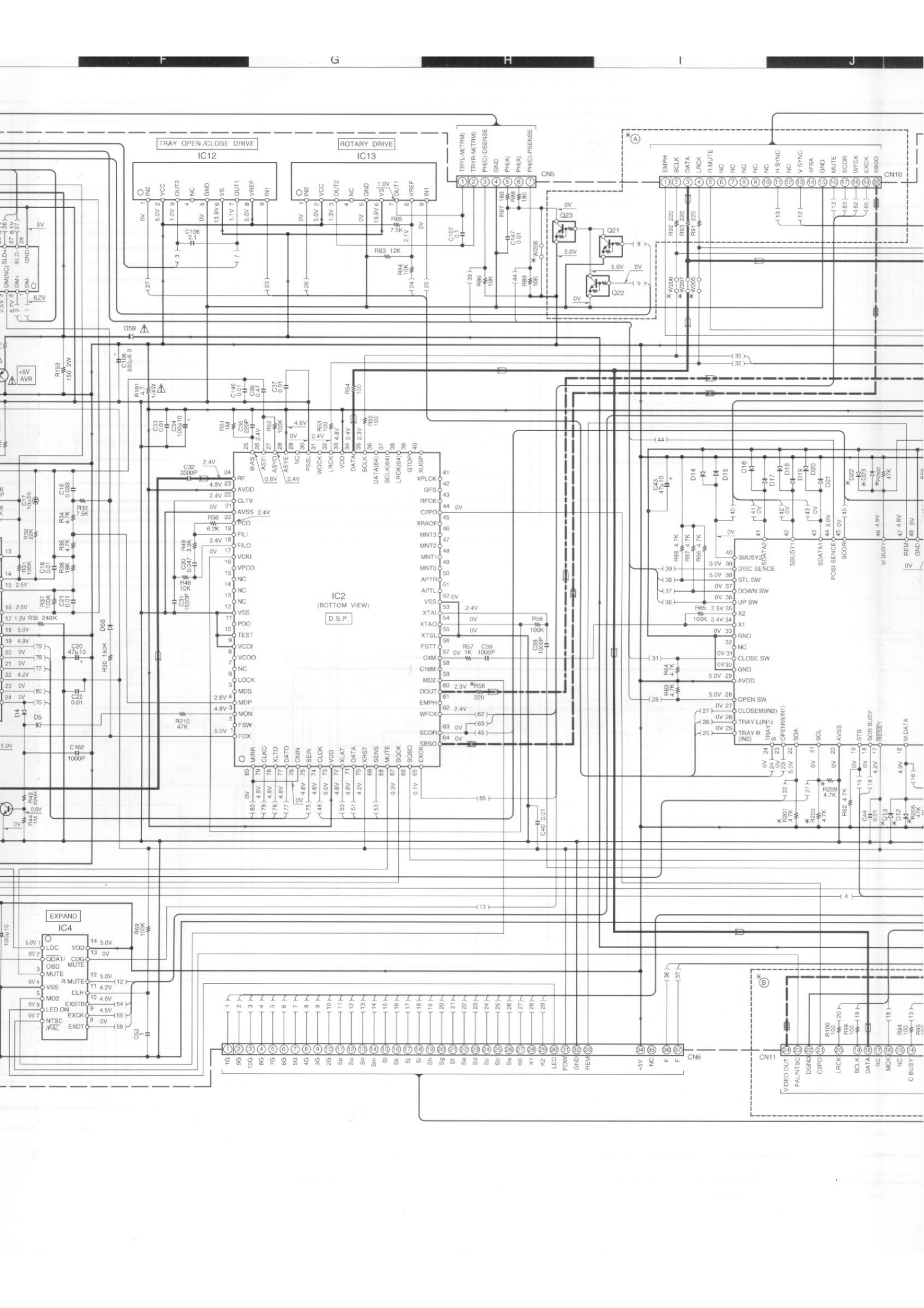

TRAY OPEN/CLOSE DRIVE

ROTARY DRIVE

IC12

IC13

IC2 (BOTTOM VIEW)

D.S.P.

EXPAND

IC4

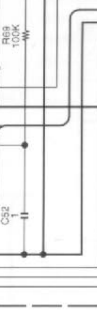
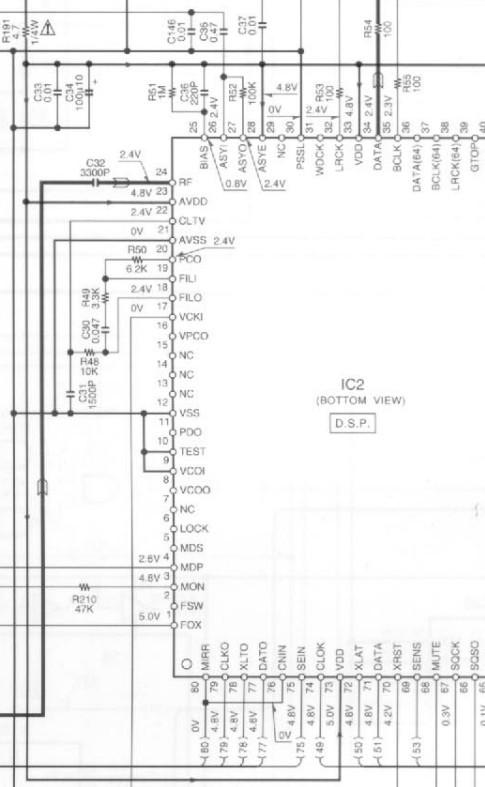
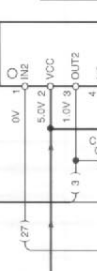

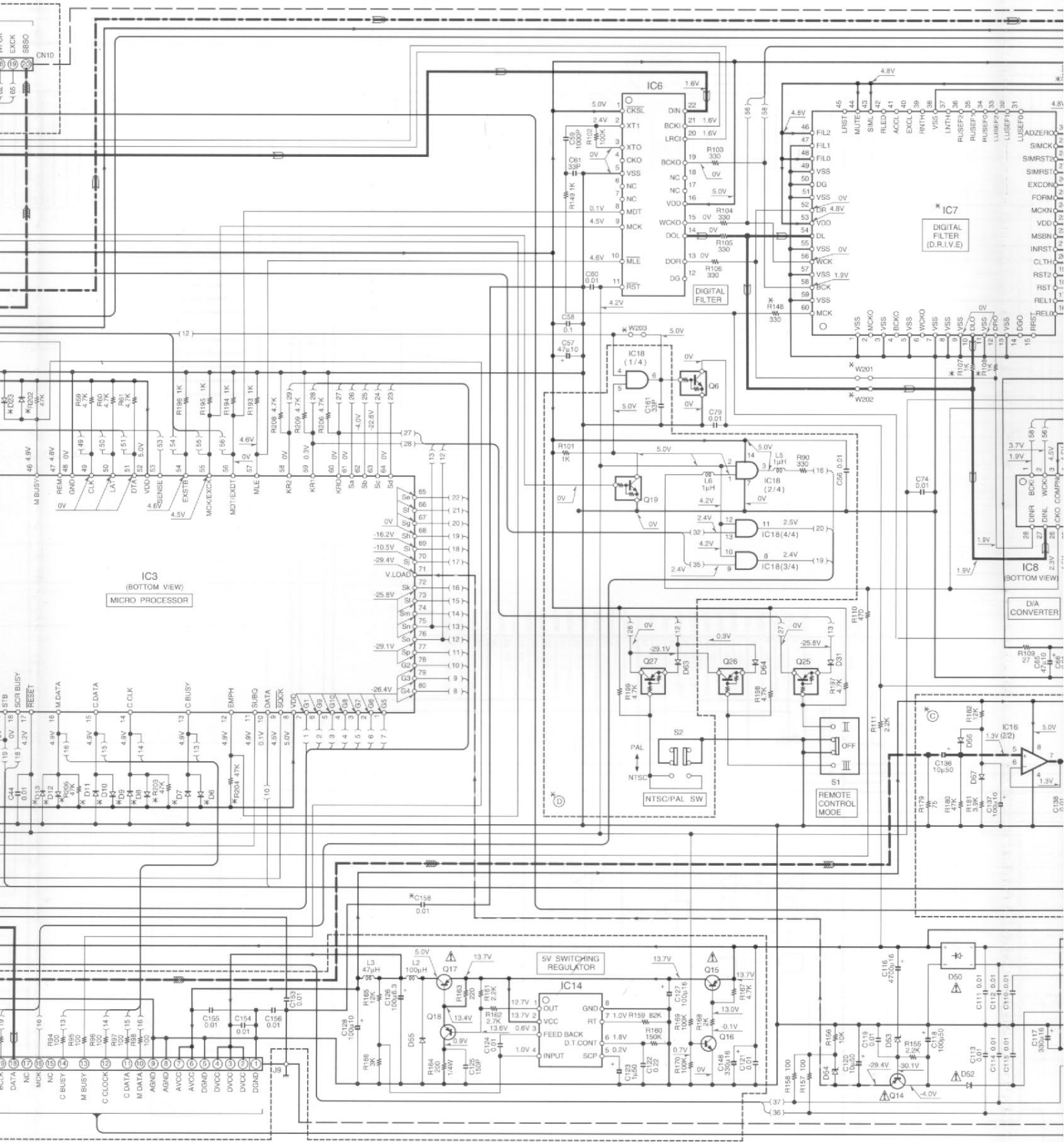

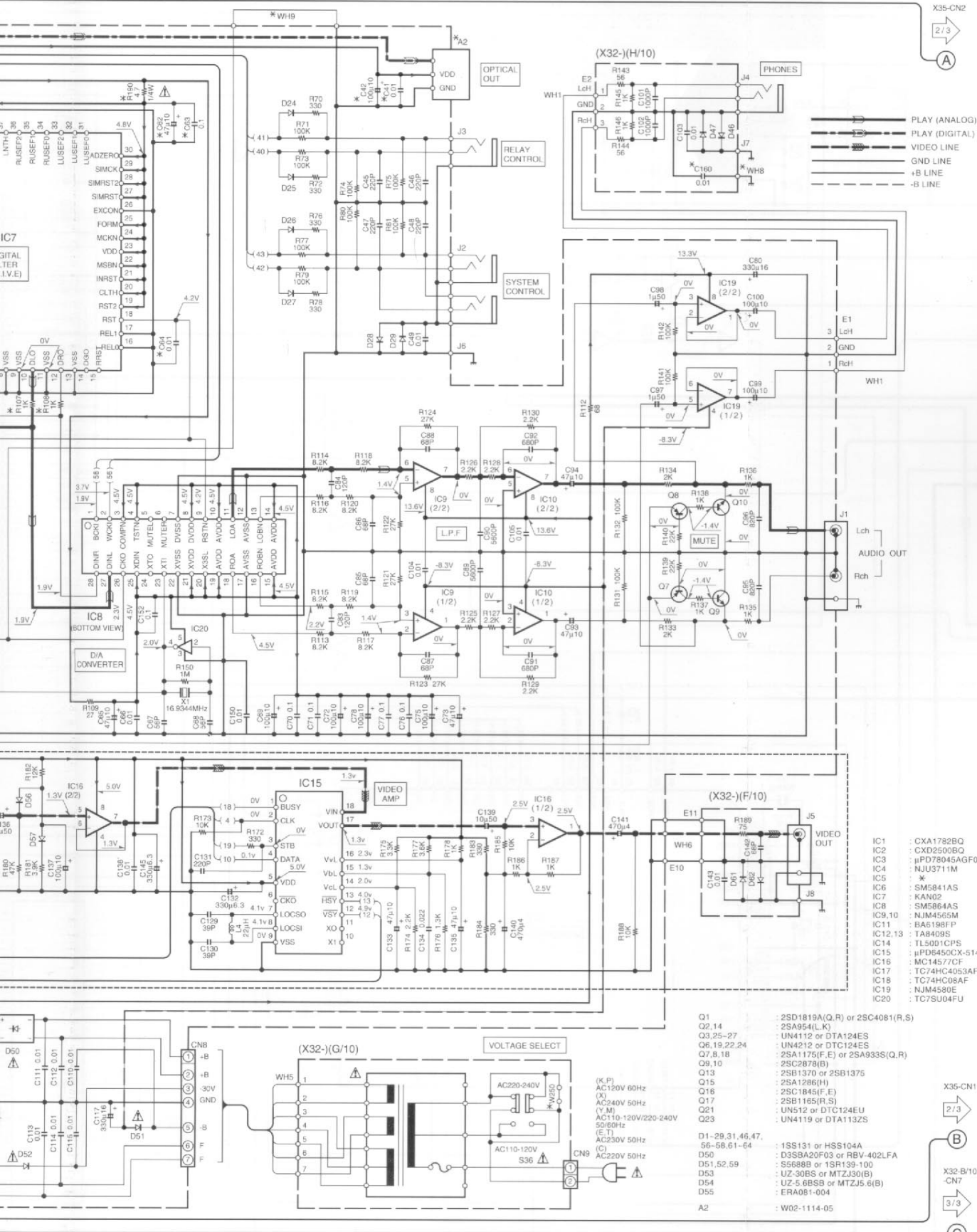

CAUTION: For continued protection of components only with the same type and rating. For continued protection with same type and rating, electric shock, leakage shall be carried out (except from the supply circuit) to the customer.

The DC voltage is an impedance type voltage, vary depending on the product. Refer to otherwise specified; The measured at the moment.

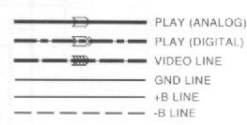

- IC1 : CXA1782BQ
- IC2 : CXD2500BQ
- IC3 : μPD78045AGF025
- IC4 : NJU5711M
- IC5 : *
- IC6 : SM5841AS
- IC7 : KAN02
- IC8 : SM5864AS
- IC9,10 : NJM4555M
- IC11 : BA6198P
- IC12,13 : TAB4095
- IC14 : TL5001CPS
- IC15 : μPD6450CX-514
- IC16 : MC14570F
- IC17 : TC74HC4053AF
- IC18 : TC74HC08AF
- IC19 : NJM4580E
- IC20 : TC7SU04FU

- Q1 : 2SD1819A(Q,R) or 2SC4081(R,S)
- Q2,14 : 2SA954(L,K)
- Q3,25-27 : UN4112 or DTA124ES
- Q6,19,22,24 : UN4212 or DTC124ES
- Q7,8,18 : 2SA1175(F,E) or 2SA933S(Q,R)
- Q9,10 : 2SC2878(B)
- Q13 : 2SB1370 or 2SB1375
- Q15 : 2SA1286(H)
- Q16 : 2SC1845(F,E)
- Q17 : 2SB1165(F,S)
- Q21 : UN512 or DTC124EU
- Q23 : UN4119 or DTA113ZS
- D1-29,31,46,47,56-58,61-64 : 1SS131 or HSS104A
- D50 : D3SSA20F03 or RBY-402LFA
- D51,52,59 : S5688 or 1SR139-100
- D53 : UZ-30BS or MTZJ30(B)
- D54 : UZ-5.6BSB or MTZJ5.6(B)
- D55 : ERA081-004
- A2 : W02-1114-05

DP-R5080/R6080/R8080V(K)(1/3)



DP-R5080
Y22-4420-10
KEN

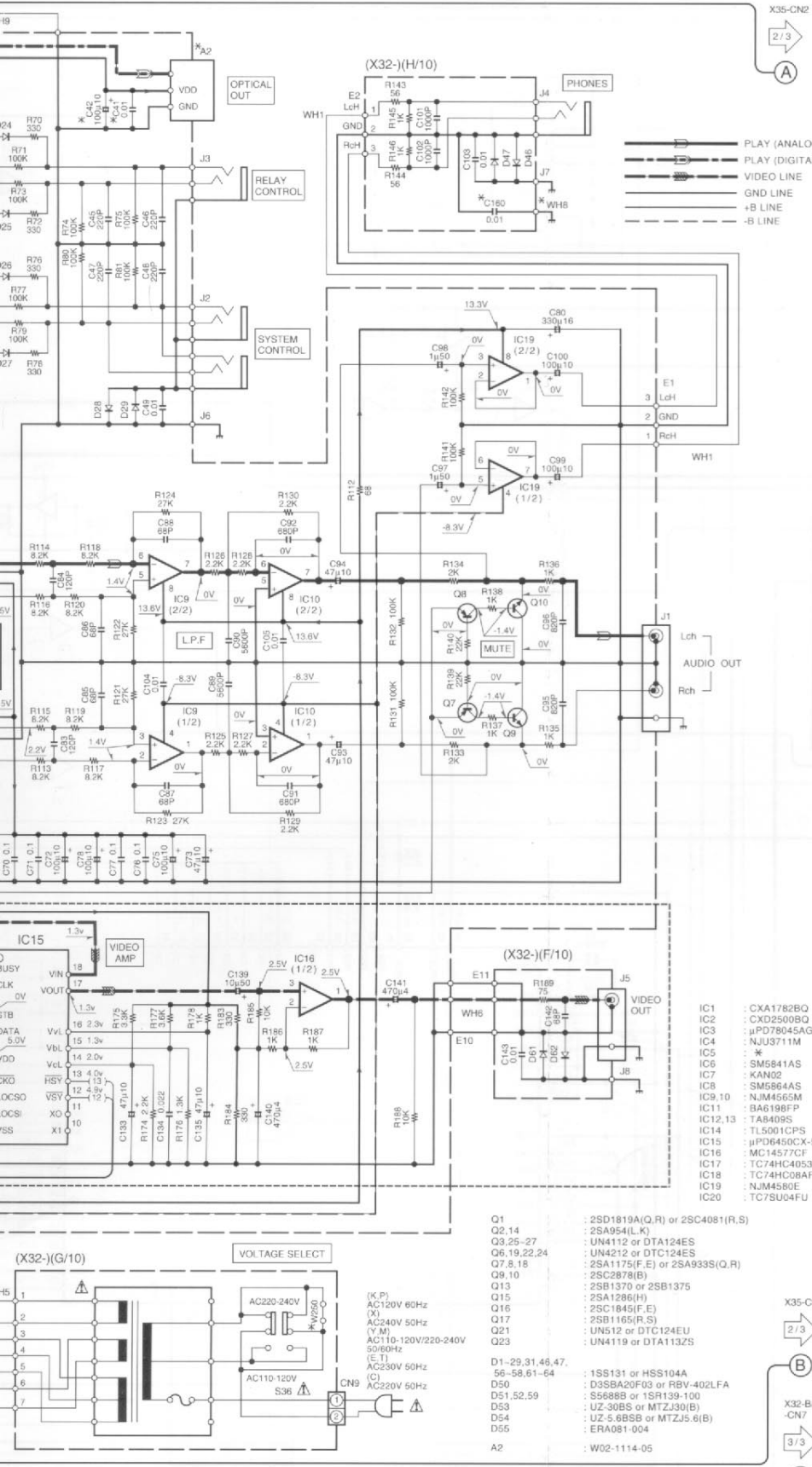

CAUTION: For continued safety, replace safety critical components only with manufacturer's recommended parts (refer to parts list). ⚠ indicates safety critical components. For continued protection against risk of fire, replace only with same type and rating fuse(s). To reduce the risk of electric shock, leakage-current or resistance measurements shall be carried out (exposed parts are acceptably insulated from the supply circuit) before the appliance is returned to the customer.

The DC voltage is an actual reading measured with a high impedance type voltmeter. The measurement value may vary depending on the measuring instruments used or on the product. Refer to the voltage during PLAY unless otherwise specified; The value shown in () is the voltage measured at the moment of STOP.

- IC1 : CXA1782BQ
- IC2 : CXD2500BQ
- IC3 : μ PD78045AGF025
- IC4 : NJU3711M
- IC5 : *
- IC6 : SM5841AS
- IC7 : KAN02
- IC8 : SM5864AS
- IC9,10 : NJM4555M
- IC11 : BA6198FP
- IC12,13 : TA8409S
- IC14 : TL5001CPS
- IC15 : μ PD6450CX-514
- IC16 : MC14577CF
- IC17 : TC74HC4053AF
- IC18 : TC74HC08AF
- IC19 : NJM4580E
- IC20 : TC7SU04FU

- Q1 : 2SD1819A(Q,R) or 2SC4081(R,S)
- Q2,14 : 2SA954(L,K)
- Q3,25-27 : UN4112 or DTA124ES
- Q6,19,22,24 : UN4212 or DTC124ES
- Q7,8,18 : 2SA1175(F,E) or 2SA933S(Q,R)
- Q9,10 : 2SC2878(B)
- Q13 : 2SB1370 or 2SB1375
- Q15 : 2SA1286(H)
- Q16 : 2SC1845(F,E)
- Q17 : 2SB1165(R,S)
- Q21 : UN512 or DTC124EU
- Q23 : UN4119 or DTA113ZS
- D1-29,31,46,47,56-58,61-64 : 1SB131 or HSS104A
- D50 : D3SBA20F03 or RBV-402LFA
- D51,52,59 : S5688B or 1SR139-100
- D53 : UZ-30BS or MTJ30(B)
- D54 : UZ-5.6BSB or MTJ5.6(B)
- D55 : ERA081-004
- A2 : W02-1114-05

DP-R5080/R6080/R8080V(K)(1/3)

DP-R5080/R6080/8080V

Y22-4420-10

KENWOOD

(X35-2160-20) (DP-R8080V ONLY)

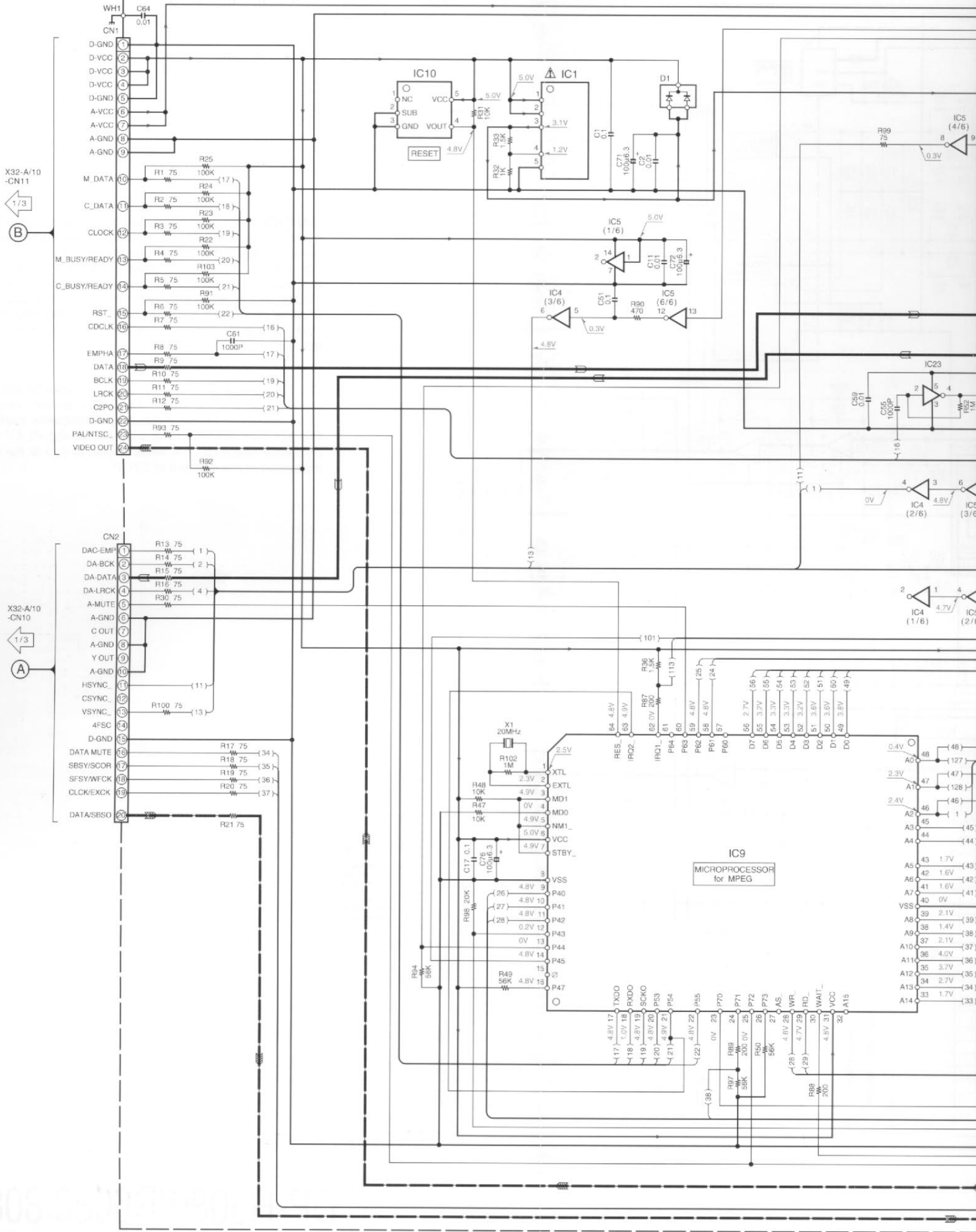

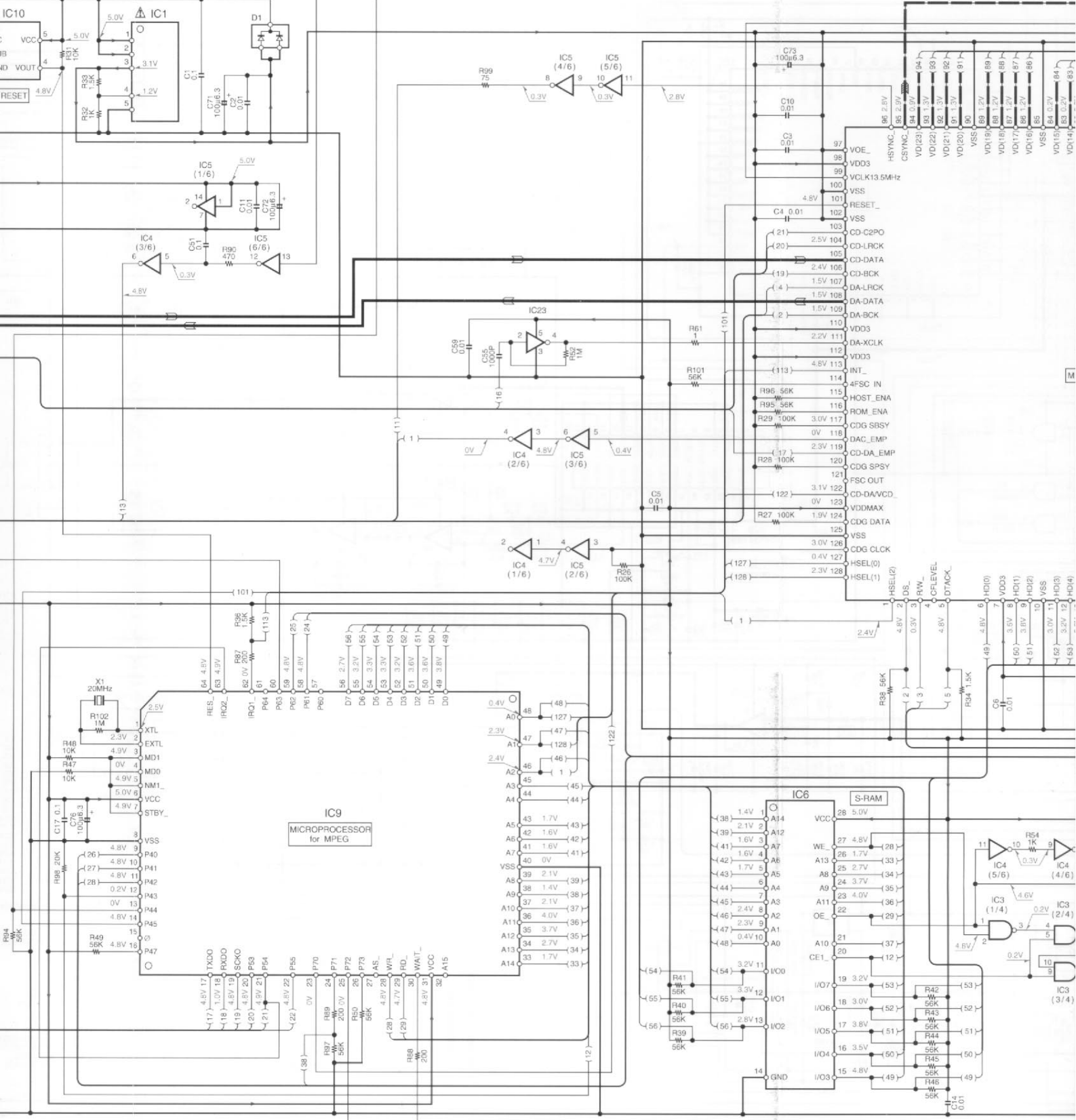

IC9
MICROPROCESSOR
for MPEG

IC6
S-RAM

IC10

IC1

IC23

IC4 (3/6)

IC4 (2/6)

IC5 (4/6)

IC5 (5/6)

IC5 (1/6)

IC3 (1/4)

IC3 (2/4)

IC3 (3/4)

IC3 (4/4)

IC3 (5/4)

IC3 (6/4)

IC3 (7/4)

IC3 (8/4)

IC3 (9/4)

IC3 (10/4)

IC3 (11/4)

IC3 (12/4)

IC3 (13/4)

IC3 (14/4)

IC3 (15/4)

IC3 (16/4)

IC3 (17/4)

IC3 (18/4)

IC3 (19/4)

IC3 (20/4)

IC3 (21/4)

IC3 (22/4)

IC3 (23/4)

IC3 (24/4)

IC3 (25/4)

IC3 (26/4)

IC3 (27/4)

IC3 (28/4)

IC3 (29/4)

IC3 (30/4)

IC3 (31/4)

IC3 (32/4)

IC3 (33/4)

IC3 (34/4)

IC3 (35/4)

IC3 (36/4)

IC3 (37/4)

IC3 (38/4)

IC3 (39/4)

IC3 (40/4)

IC3 (41/4)

IC3 (42/4)

IC3 (43/4)

IC3 (44/4)

IC3 (45/4)

IC3 (46/4)

IC3 (47/4)

IC3 (48/4)

IC3 (49/4)

IC3 (50/4)

IC3 (51/4)

IC3 (52/4)

IC3 (53/4)

IC3 (54/4)

IC3 (55/4)

IC3 (56/4)

IC3 (57/4)

IC3 (58/4)

IC3 (59/4)

IC3 (60/4)

IC3 (61/4)

IC3 (62/4)

IC3 (63/4)

IC3 (64/4)

IC3 (65/4)

IC3 (66/4)

IC3 (67/4)

IC3 (68/4)

IC3 (69/4)

IC3 (70/4)

IC3 (71/4)

IC3 (72/4)

IC3 (73/4)

IC3 (74/4)

IC3 (75/4)

IC3 (76/4)

IC3 (77/4)

IC3 (78/4)

IC3 (79/4)

IC3 (80/4)

IC3 (81/4)

IC3 (82/4)

IC3 (83/4)

IC3 (84/4)

IC3 (85/4)

IC3 (86/4)

IC3 (87/4)

IC3 (88/4)

IC3 (89/4)

IC3 (90/4)

IC3 (91/4)

IC3 (92/4)

IC3 (93/4)

IC3 (94/4)

IC3 (95/4)

IC3 (96/4)

IC3 (97/4)

IC3 (98/4)

IC3 (99/4)

IC3 (100/4)

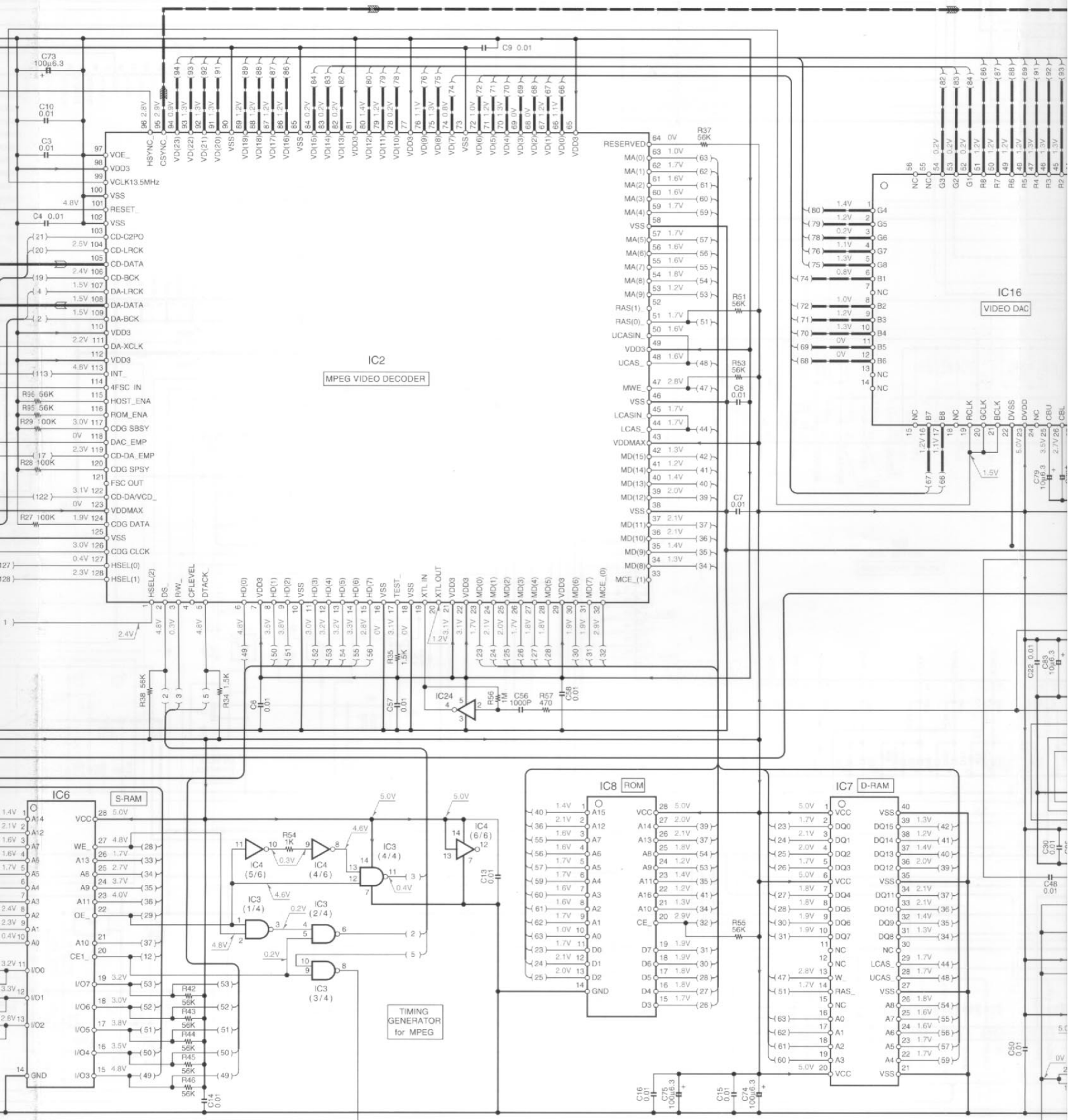

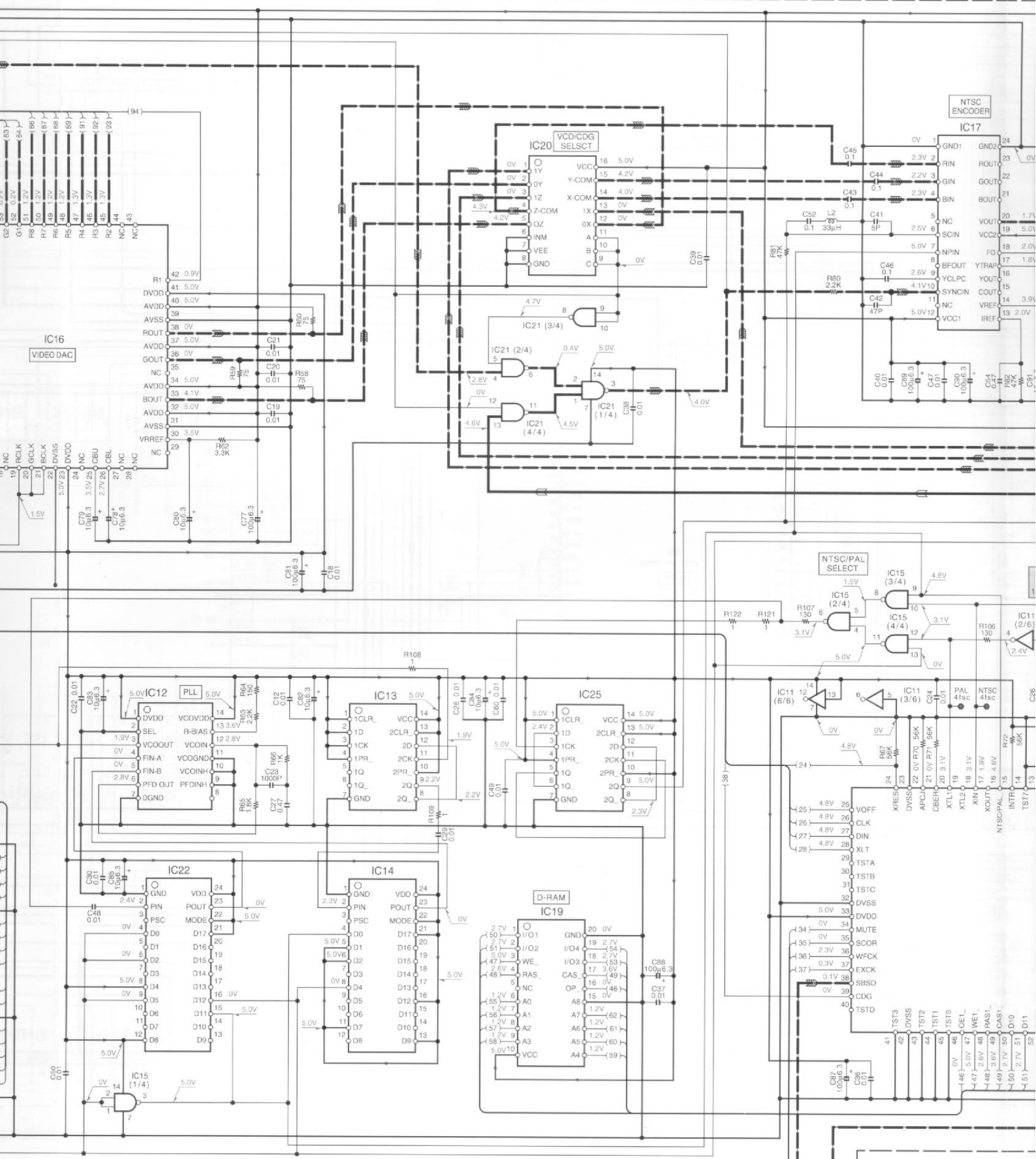

IC16
VIDEO DAC

IC20
VCD/CDG
SELSCT

NTSC ENCODER
IC17

NTSC/PAL
SELECT
IC15

D-RAM
IC19

IC12
PLL

IC13

IC25

IC14

IC22

IC15
(1/4)

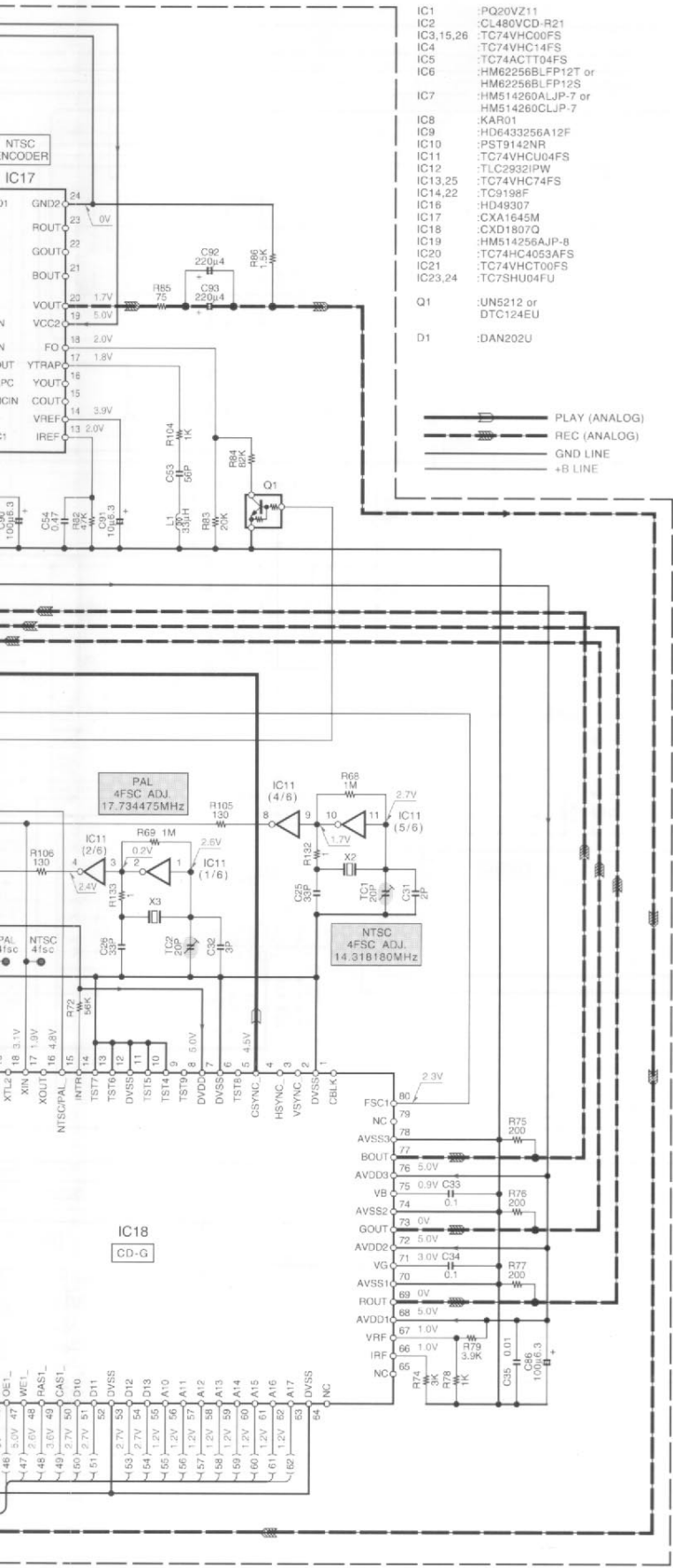

- IC1 :PQ20VZ11
- IC2 :CL480VCD-R21
- IC3,15,26 :TC74VHC00FS
- IC4 :TC74VHC14FS
- IC5 :TC74ACTT04FS
- IC6 :HM62256BLFP12T or HM62256BLFP12S
- IC7 :HM514260ALJP-7 or HM514260CLJP-7
- IC8 :KAR01
- IC9 :HD6433256A12F
- IC10 :PST9142NR
- IC11 :TC74VHCU04FS
- IC12 :TLC2932IPW
- IC13,25 :TC74VHC74FS
- IC14,22 :TC9198F
- IC16 :HD48307
- IC17 :CXA1645M
- IC18 :CXD1807Q
- IC19 :HM514256AJP-8
- IC20 :TC74HC4053AFS
- IC21 :TC74VHC00FS
- IC23,24 :TC75HU04FU
- Q1 :UN5212 or DTC124EU
- D1 :DAN202U

PLAY (ANALOG)
 REC (ANALOG)
 GND LINE
 +B LINE

CAUTION: For continued safety, replace safety critical components only with manufacturer's recommended parts (refer to parts list). ⚠ indicates safety critical components. For continued protection against risk of fire, replace only with same type and rating fuse(s). To reduce the risk of electric shock, leakage-current or resistance measurements shall be carried out (exposed parts are acceptably insulated from the supply circuit) before the appliance is returned to the customer.

The DC voltage is an actual reading measured with a high impedance type voltmeter. The measurement value may vary depending on the measuring instruments used or on the product. Refer to the voltage during PLAY unless otherwise specified; The value shown in () is the voltage measured at the moment of STOP.

DP-R8080V(K)(2/3)

DP-R5080/R6080/8080V
KENWOOD

Y22-4420-10

(X32-3080-XX) (B/10)

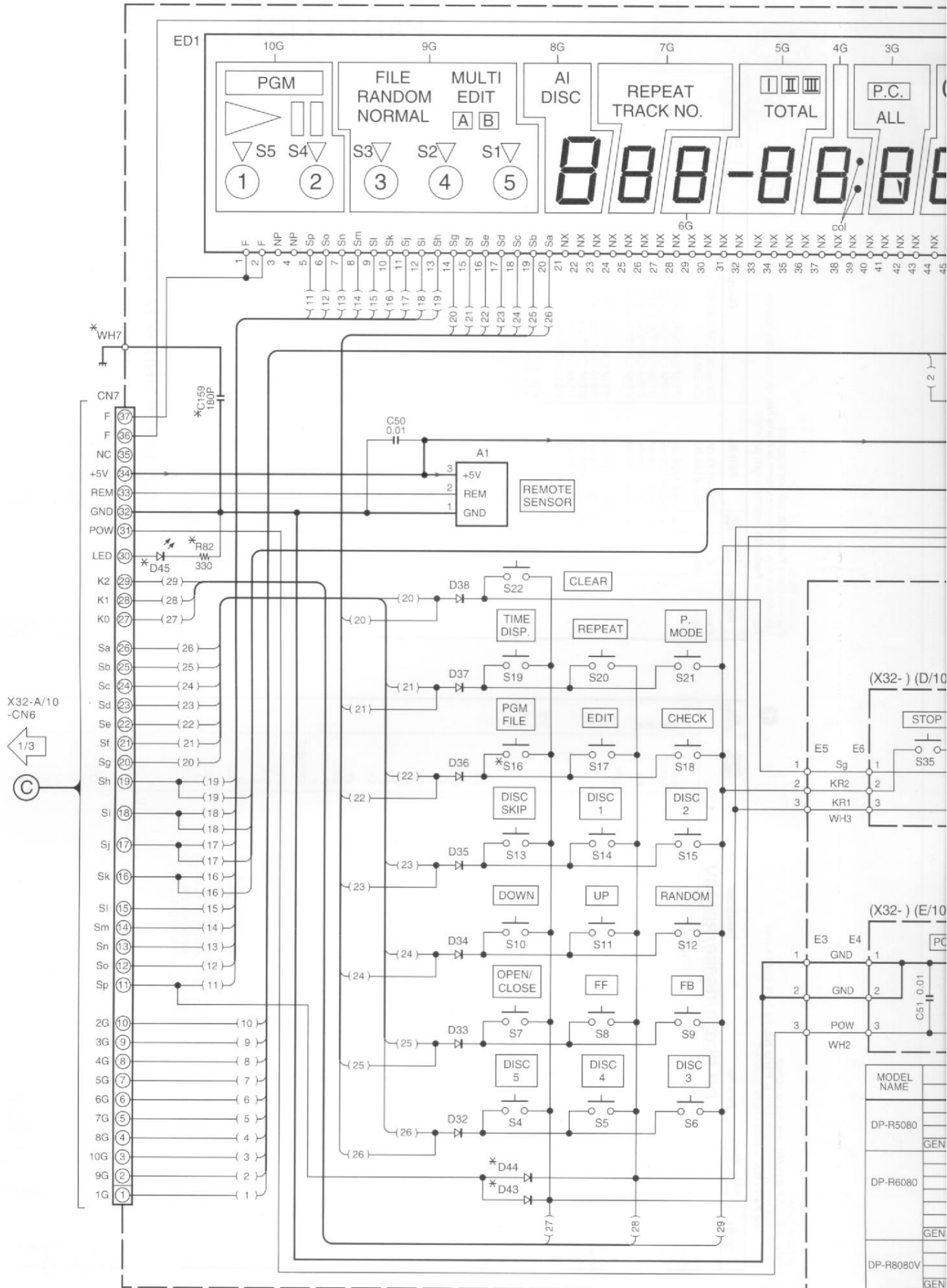

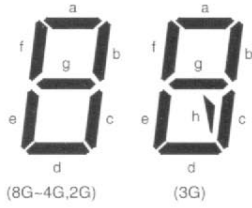
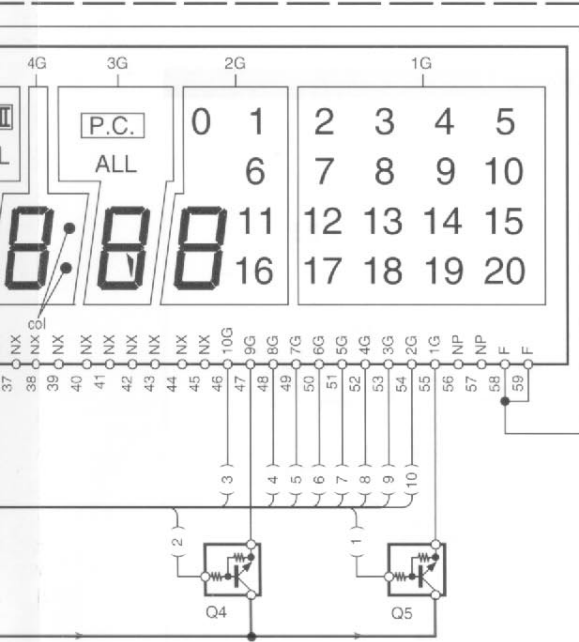

ANODE CONNECTION

	10G	9G	8G	7G	6G	5G	4G	3G	2G	1G
Sa	PGM	FILE	a	a	a	a	a	a	a	2
Sb	RANDOM	b	b	b	b	b	b	b	b	7
Sc	NORMAL	f	f	f	f	f	f	f	f	12
Sd	S5	MULTI	g	g	g	g	g	g	g	17
Se	S4	EDIT	c	c	c	c	c	c	c	3
Sf	(A)	e	e	e	e	e	e	e	e	8
Sg	(B)	d	d	d	d	d	d	d	d	13
Sh	1 2	3 4 5	-	-	-	-	-	-	h	18
Si	-	S3	AI	REPEAT	-	col	P.C.	0	4	
Sj	-	S2	DISC	TRACK NO	-	-	ALL	1	9	
Sk	-	S1	-	-	-	-	-	6	14	
Sl	-	(C)	-	-	-	TOTAL	-	11	19	
Sm	-	(4)	-	-	-	-	-	16	5	
Sn	-	(D)	-	-	-	-	-	-	10	
So	-	-	-	-	-	-	-	-	15	
Sp	-	-	-	-	-	-	-	-	20	

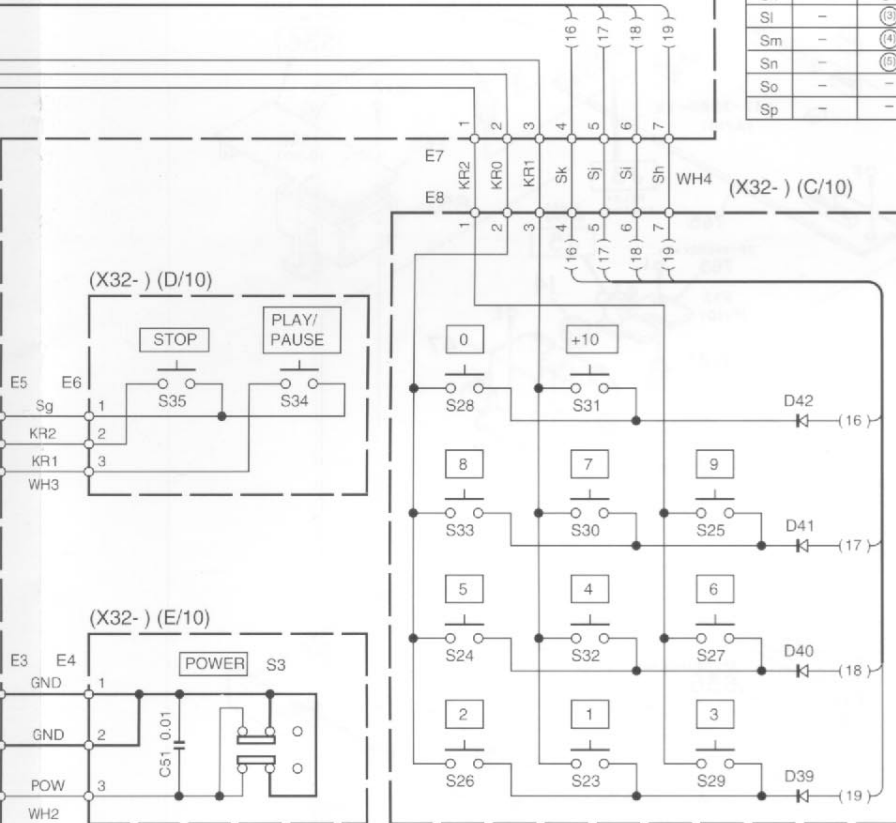

MODEL NAME	DESTINATION		UNIT No.	D43, 45	D44	S16	R82	C159	WH7
	COUNTRY	ABB.							
DP-R5080	U.S.A.	K	X32-3080-10		NO	NO			
	CANADA	P							
	AUSTRALIA	X							
	GENERAL MARKET	M							
DP-R6080	U.S.A.	K	X32-3080-11	NO	YES	YES			NO
	CANADA	P							
	AUSTRALIA	X							
	U.K.	T							
	EUROPE	E							
DP-R8080V	PX	Y	X32-3080-22						
	GENERAL MARKET	M							
	U.K.	T							
	EUROPE	E							
DP-R8080V	EUROPE	E	X32-3080-12	YES	NO	YES	YES	YES	YES
	CHINA	C							
	GENERAL MARKET	M							
DP-R8080V	EUROPE	E	X32-3080-23						
	CHINA	C							
	GENERAL MARKET	M							

- Q4,5 : UN4219 or DTC113ZS
- D32-44 : 1SS131 or HSS104A
- D45 : B30-0431-05
- A1 : W02-1046-05
- ED1 : 10-BT-160GK

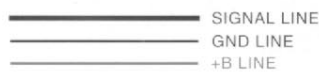

DP-R5080/R6080/R8080V(K)(3/3)

CAUTION: For continued safety, replace safety critical components only with manufacturer's recommended parts (refer to parts list). ⚠ indicates safety critical components. For continued protection against risk of fire, replace only with same type and rating fuse(s). To reduce the risk of electric shock, leakage-current or resistance measurements shall be carried out (exposed parts are acceptably insulated from the supply circuit) before the appliance is returned to the customer.

The DC voltage is an actual reading measured with a high impedance type voltmeter. The measurement value may vary depending on the measuring instruments used or on the product. Refer to the voltage during PLAY unless otherwise specified; The value shown in () is the voltage measured at the moment of STOP.

2SA1286
2SA954
2SC1845
2SC2878

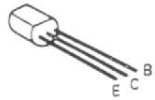

2SA1175

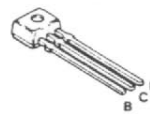

DTA124ES
DTC124ES
UN4112
2SA933S

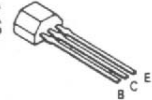

DTC124EU
2SC4081
2SD1819A

UN4212
UN4219

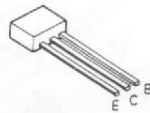

2SB1375



NJM4580E

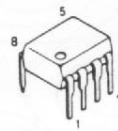

TA8409S

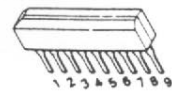

MC14577CF
NJM4565M
TL5001CPS

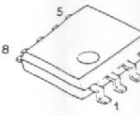

UN5212



HM62256BLFP12S
HM62256BLFP12T

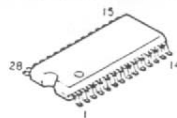

TC74HC4053AFS

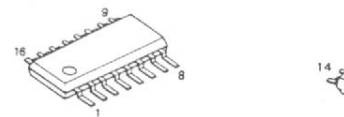

TC74HC08AF

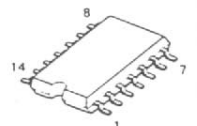

TC9198F

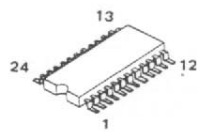

CXD1807Q
CXD2500BQ

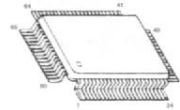

CXA1782BQ

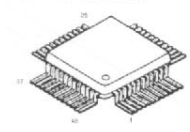

KAR01

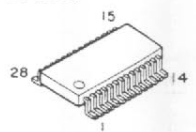

BA6198FP

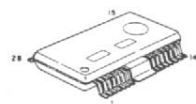

PST9142NR



TC7SHU04FU
TC7SU04FU

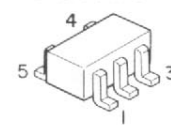

PQ20VZ11

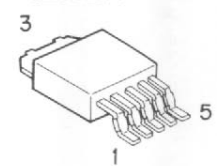

DTC124EU
2SC4081
2SD1819A



2SB1370



MC14577CF
NJM4565M
TL5001CPS

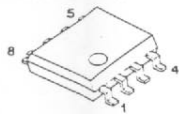

DAN202U



C08AF



NJU3711M
TC74VHCT00FS
TC74VHCU04FS
TC74VHC00FS
TC74VHC14FS
TC74VHC74FS
TLC2932IPW

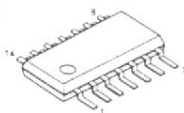

CXA1645M

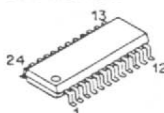

R01

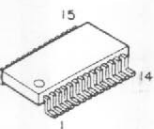

KAN02

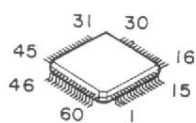

HD6433256A12F

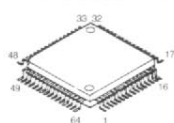

Q20VZ11

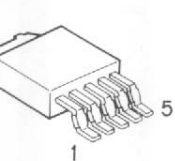

DP-R5080/R6080/R8080V

EXPLODED VIEW (MECHANISM)

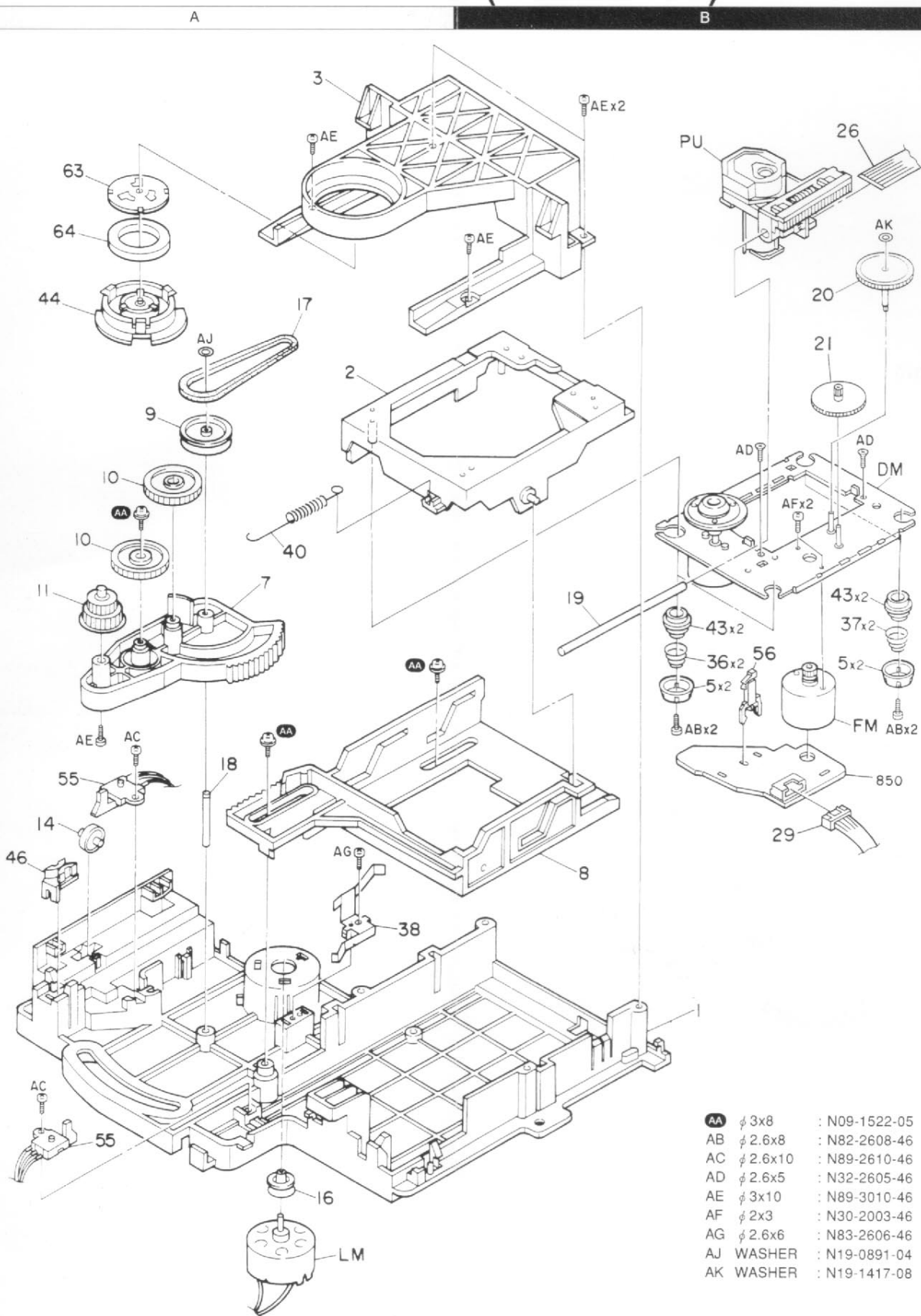

CDM-25

Parts with the exploded numbers larger than 700 are not supplied.

DP-R5080/R6080/R8080V

EXPLODED VIEW

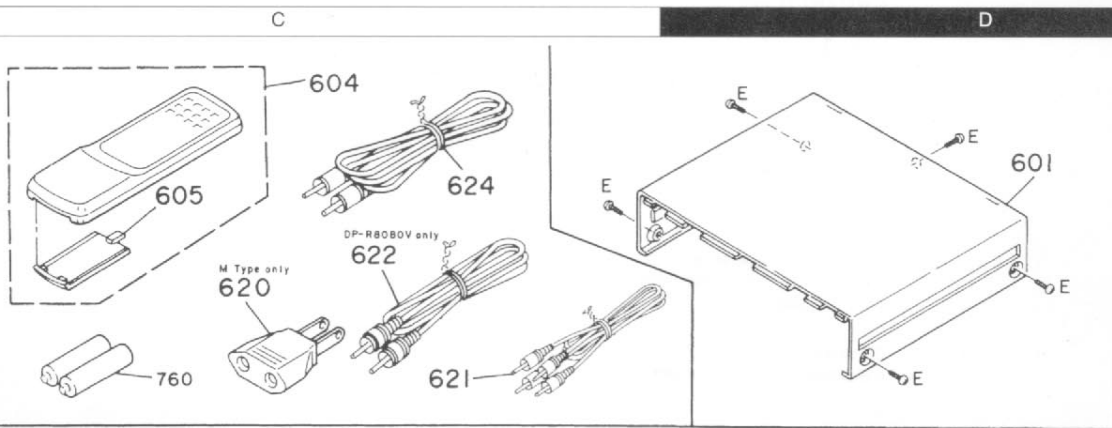

- A ϕ 3x8 : N09-1445-05(K,P,Y only)
- B ϕ 3x6(BLK) : N09-1561-05
- C M3x6 : N35-3006-46
- D ϕ 2.6x8 : N82-2608-46
- E ϕ 3x8(BLK) : N89-3008-45
- F ϕ 3x8 : N89-3008-46
- G ϕ 2.6x8 : N09-2769-05
- L ϕ 3x18 : N89-3018-46
(DP-R8080V only)
- AE ϕ 3x10 : N89-3010-46
- AL ϕ 3x10 : N09-3144-05
- AM ϕ 3x8 : N89-3008-46
- AN WASHER : N19-1352-04
- AP WASHER : N19-1378-04

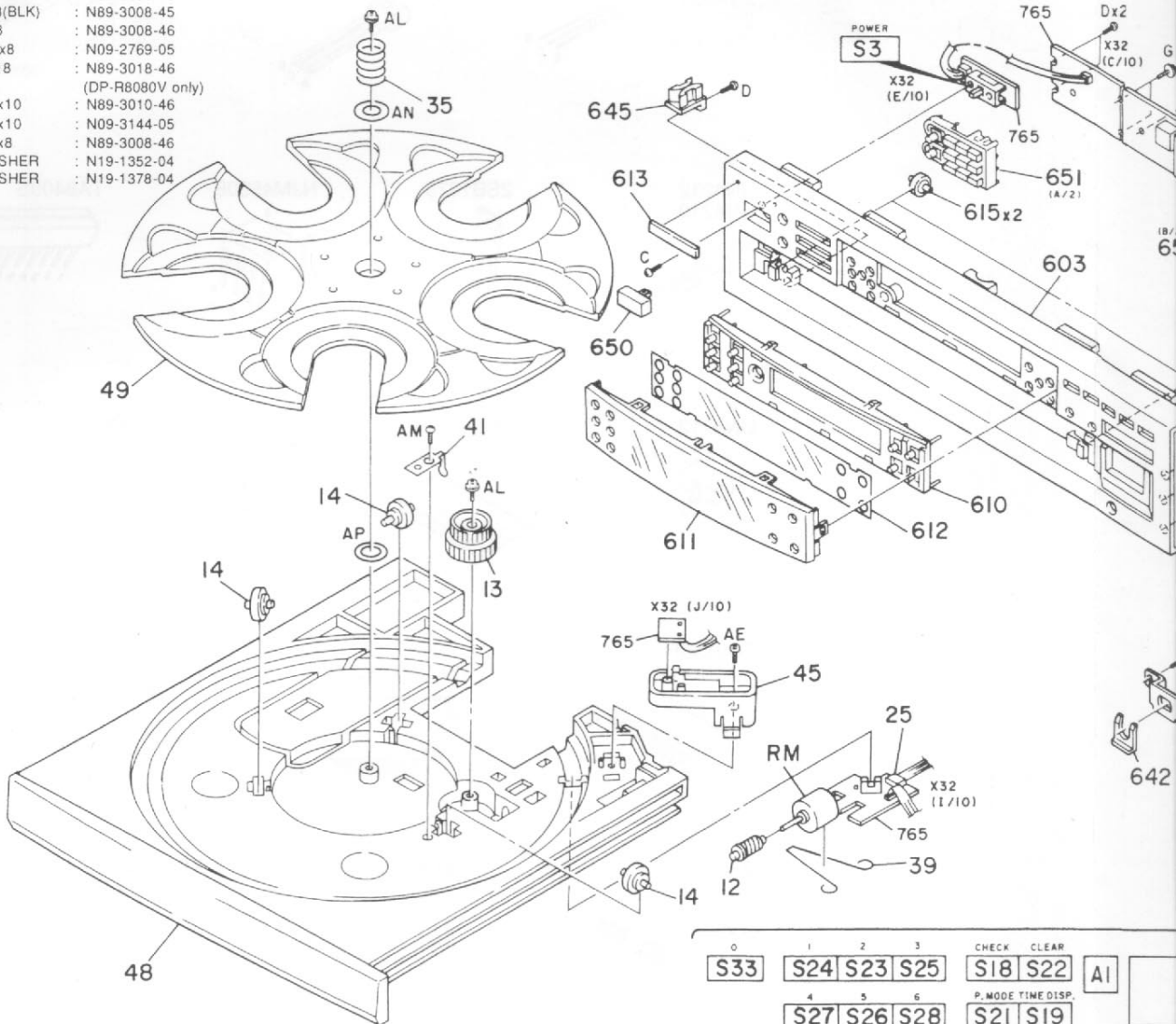

0	S33	S24	S23	S25	CHECK	CLEAR		AI
1		S27	S26	S28	S18	S22		
2					S21	S19		
3								
4								
5								
6								
7								
8								
9								
+10	S32	S30	S29	S31	S12	S20		

DP-R5080/R6080/R8080V

EXPLODED VIEW (UNIT)

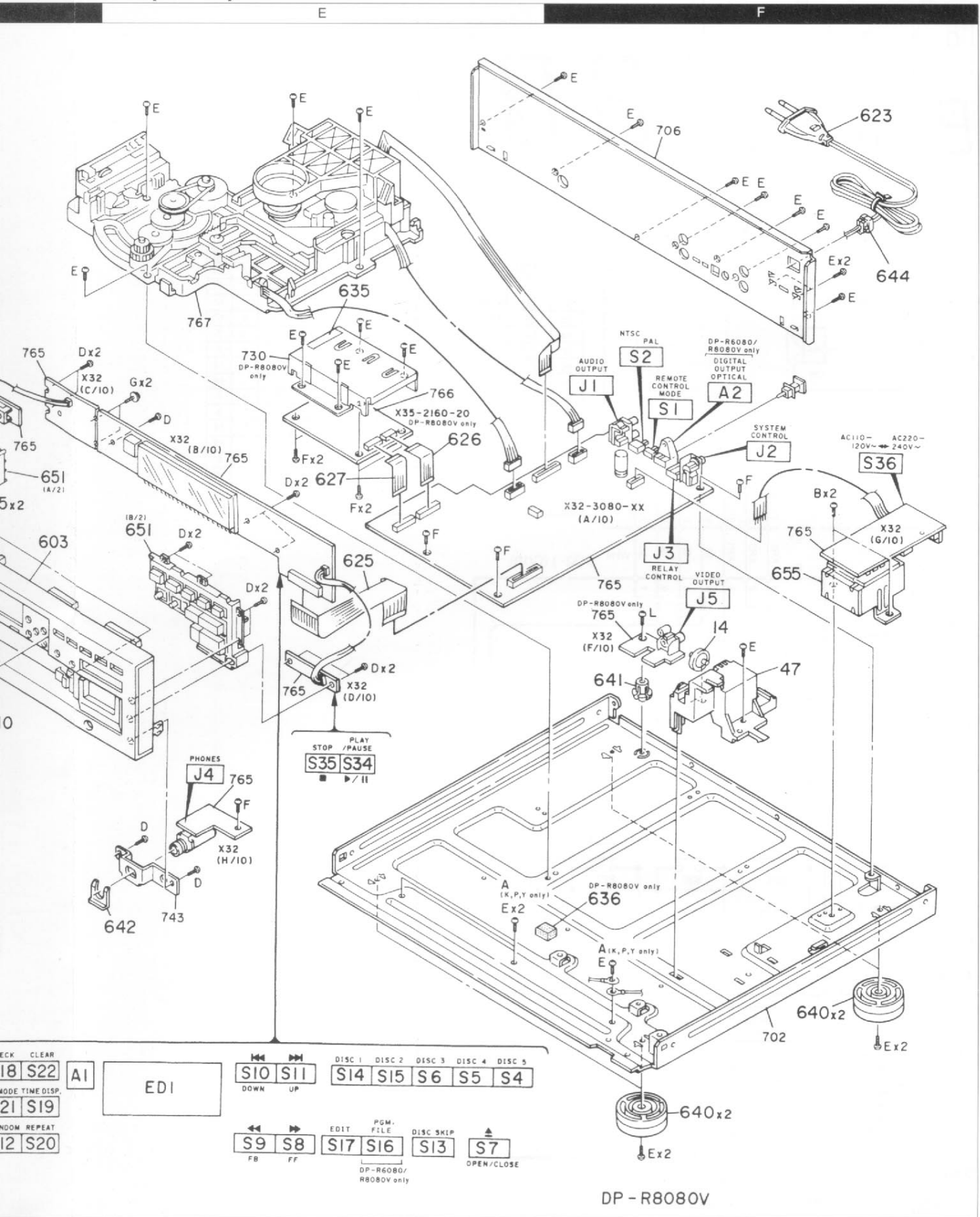

DP-R8080V

Parts with the exploded numbers larger than 700 are not supplied.

DP-R5080/R6080/R8080V

SPECIFICATIONS

[Format]

SystemCompact disc digital audio system
(DP-R5080 / R6080)
.....Video CD player system (DP-R8080V)
LaserSemiconductor laser

[D/A converters]

D/A conversion1 Bit
Oversampling8 fs (352.8 kHz)

[Audio]

Frequency response4 Hz ~ 20 kHz, ± 1.0 dB
Signal to noise ratio
.....More than 100 dB (DP-R5080 / R8080V)
.....More than 102 dB (DP-R6080)
Dynamic rangeMore than 94 dB
Total harmonic distortion + noise
.....Less than 0.005% (at 1kHz)(DP-R5080 / R8080V)
.....Less than 0.004% (at 1kHz)(DP-R6080)

Channel separationMore than 90 dB (at 1kHz)
Wow flutterUnmeasurable limit
Output level / impedance
Fixed2.0 V / 3.0 k Ω
Headphone output (max.)20 mW / 32 Ω
Digital output (DP-R6080/R8080V only)
Optical-15 dBm ~ - 21 dBm (Wave length 660 nm)
Video output format (DP-R8080V only)NTSC / PAL
Video output level (DP-R8080V only)1 Vp-p (75 Ω)

[General]

Power consumption14W
DimensionsW : 440 mm (17-5 / 16")
H : 123 mm (4-13 / 16")
D : 398 mm (15-11 / 16")
Weight (Net)5.0 kg (11.0 lb) (DP-R5080/R6080)
.....5.2 kg (11.7 lb) (DP-R8080V)

Note:

KENWOOD follows a policy of continuous advancements in development. For this reason specifications may be changed without notice.

Note:

Component and circuitry are subject to modification to insure best operation under differing local conditions. This manual is based on the General market(M) standard, and provides information on regional circuit modification through use of alternate schematic diagrams, and information on regional component variations through use of parts list.

KENWOOD CORPORATION

14-6, Dogenzaka 1-chome, Shibuya-ku, Tokyo, 150 Japan

KENWOOD SERVICE CORPORATION

P.O BOX 22745, 2201 East Dominguez St., Long Beach, CA 90801-5745, U.S.A.

KENWOOD ELECTRONICS CANADA INC.

6070 Kestrel Road, Mississauga, Ontario, Canada L5T 1S8

KENWOOD ELECTRONICS LATIN AMERICA S.A.

P.O BOX 55-2791, Piso 6 plaza Chase, Cl. 47 y Aquilino de la Guardia Panama, Republic de Panama

TRIO-KENWOOD U.K. LIMITED

KENWOOD House, Dwight Road, Watford, Herts., WD1 8EB., United Kingdom

KENWOOD ELECTRONICS BENELUX N.V.

Meachelsesteenweg 418, B-1930 Zaventem, Belgium

KENWOOD ELECTRONICS DEUTSCHLAND GMBH

Pembrücker Str. 15, 63150 Heusenstamm, Germany

TRIO-KENWOOD FRANCE S.A.

13 Boulevard Ney, 75018 Paris, France

KENWOOD ELECTRONICS ITALIA S.p.A.

Via G. Sirtori, 7/9 20129, Milano, Italy

KENWOOD IBÉRICA S.A.

Bolivia, 239-08020 Barcelona, Spain

KENWOOD ELECTRONICS AUSTRALIA PTY. LTD. (A.C.N. 001499 074)

P.O Box 504, 8 Figtree Drive, Australia Centre, Homebush, N.S.W. 2140, Australia

KENWOOD & LEE ELECTRONICS, LTD.

Unit 3712-3724, Level 37, Tower 1, Metroplaza, 223 Hing Fong Road, Kwai Fong N.T., Hong Kong

KENWOOD ELECTRONICS SINGAPORE PTE LTD.

No. 1 Genting Lane # 07-00, KENWOOD Building, Singapore, 349544

KENWOOD ELECTRONICS (MALAYSIA) SDN BHD

10th Floor, Block B, Wisma Semantan, No. 12 Janian Gelenggang, Bukit Damansara, 50490 Kuala Lumpur, Malaysia