

# KA-1010

## SERVICE MANUAL

©1989-3 PRINTED IN JAPAN  
B51-3868-00(T)1649

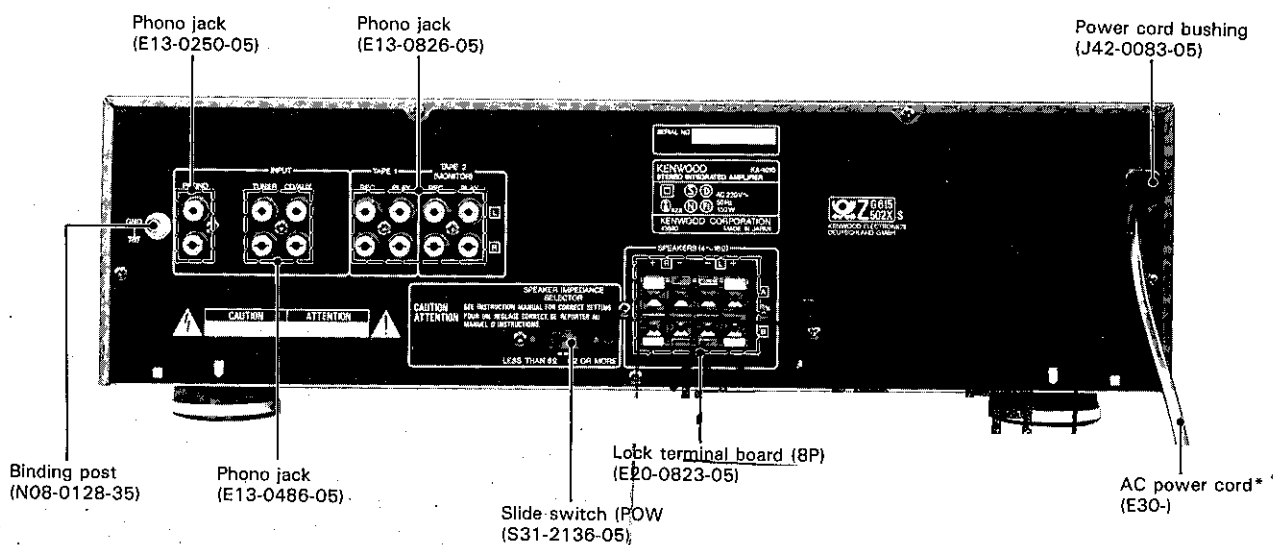
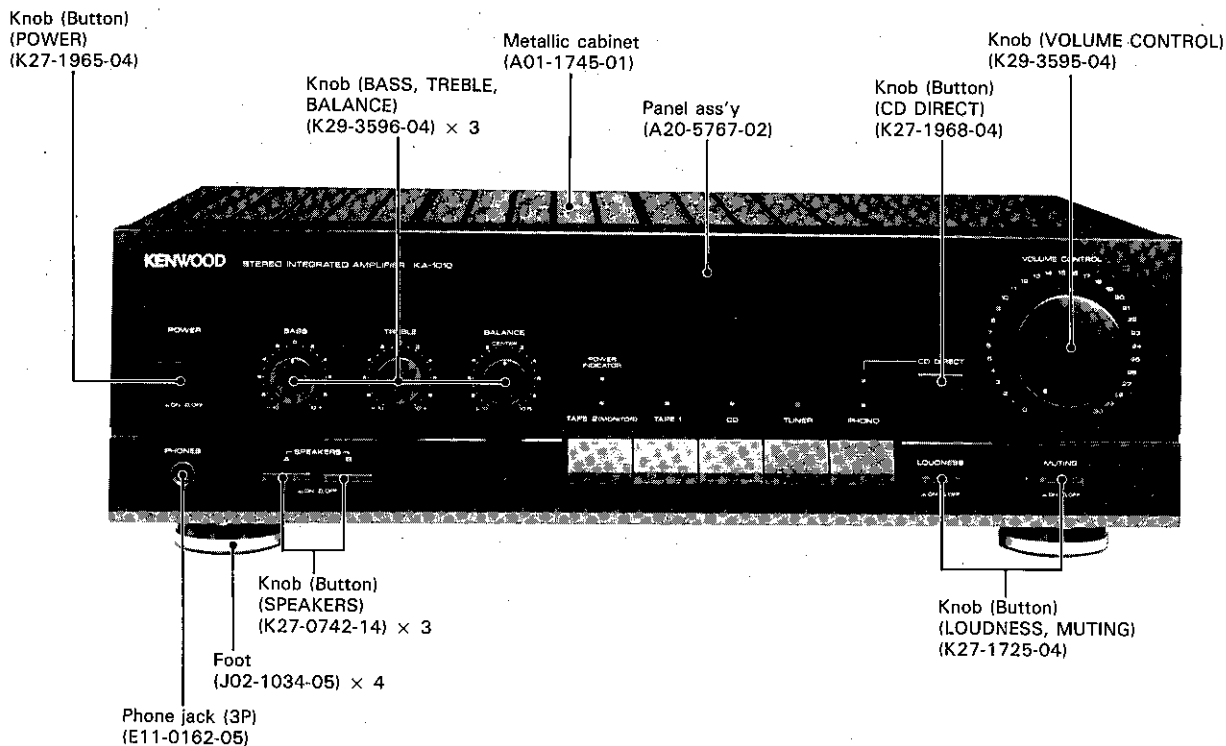

\*Refer to parts list on page 20.

# KA-1010

## CONTROLS AND INDICATORS

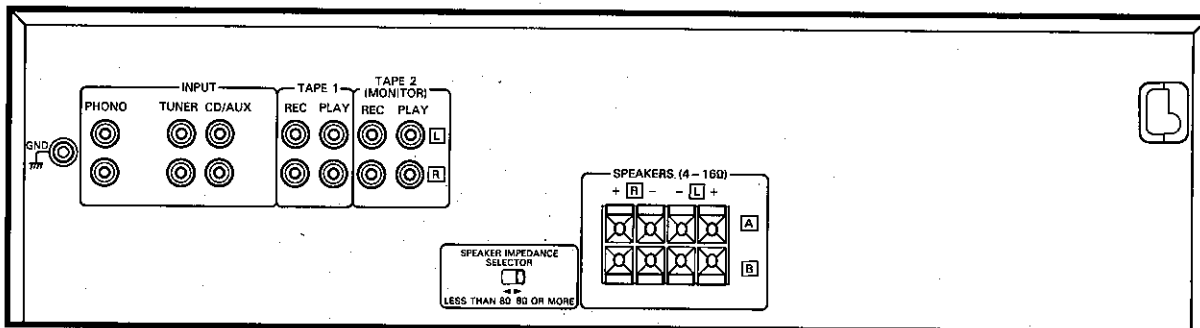
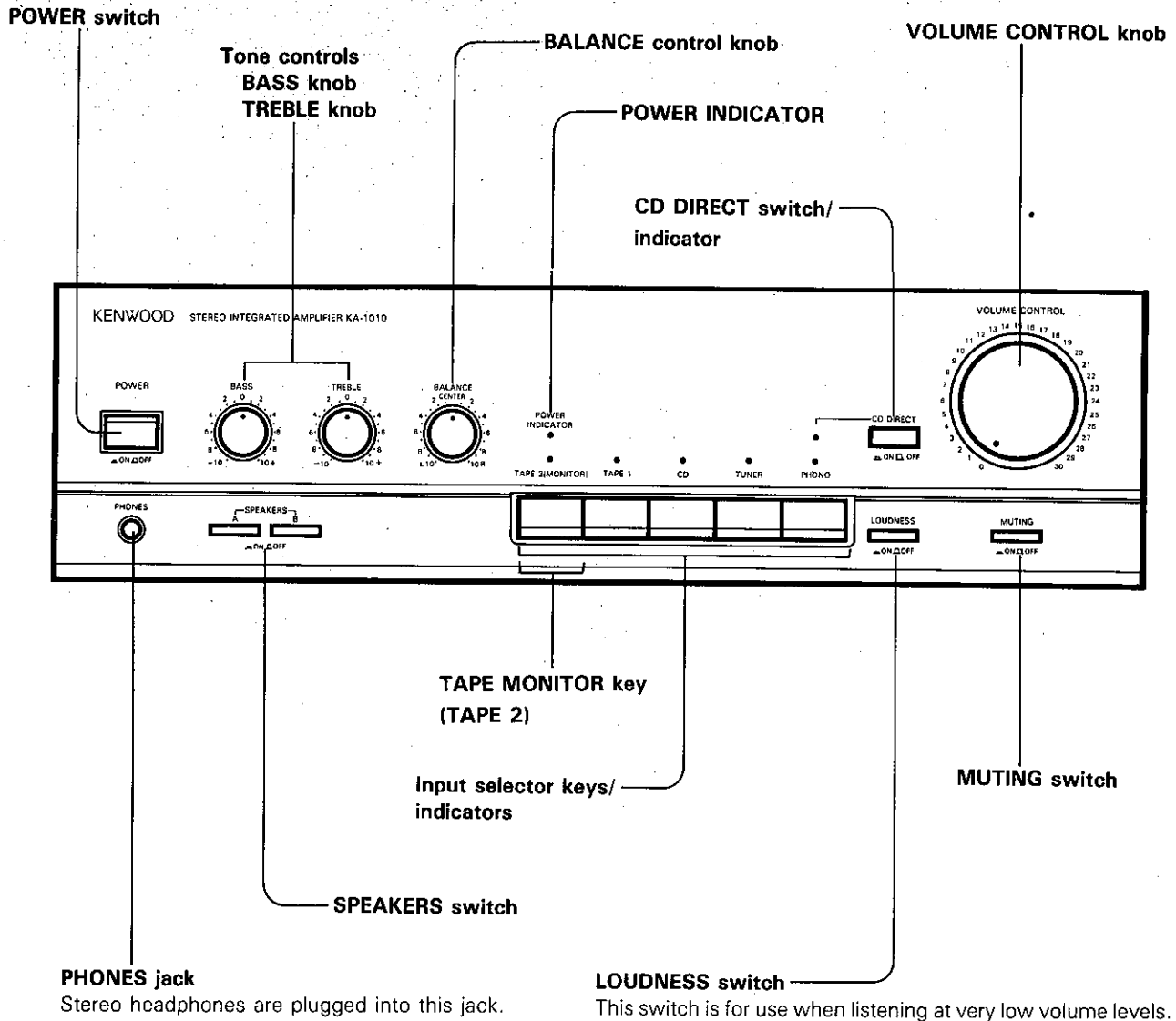

## BLOCK & LEVEL DIAGRAM

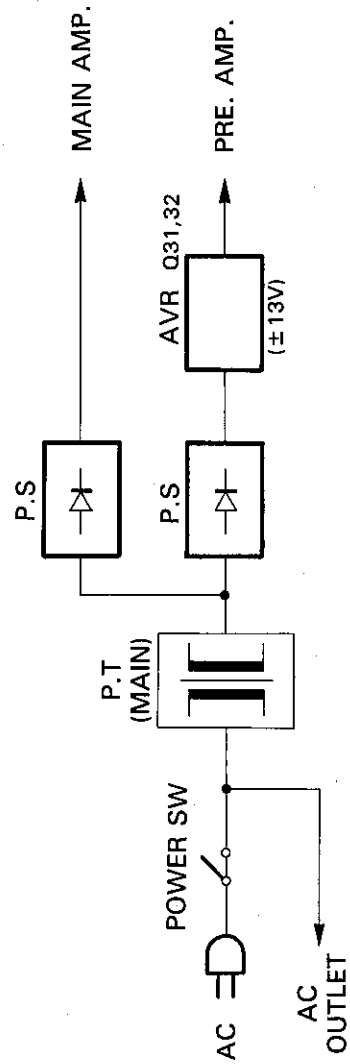
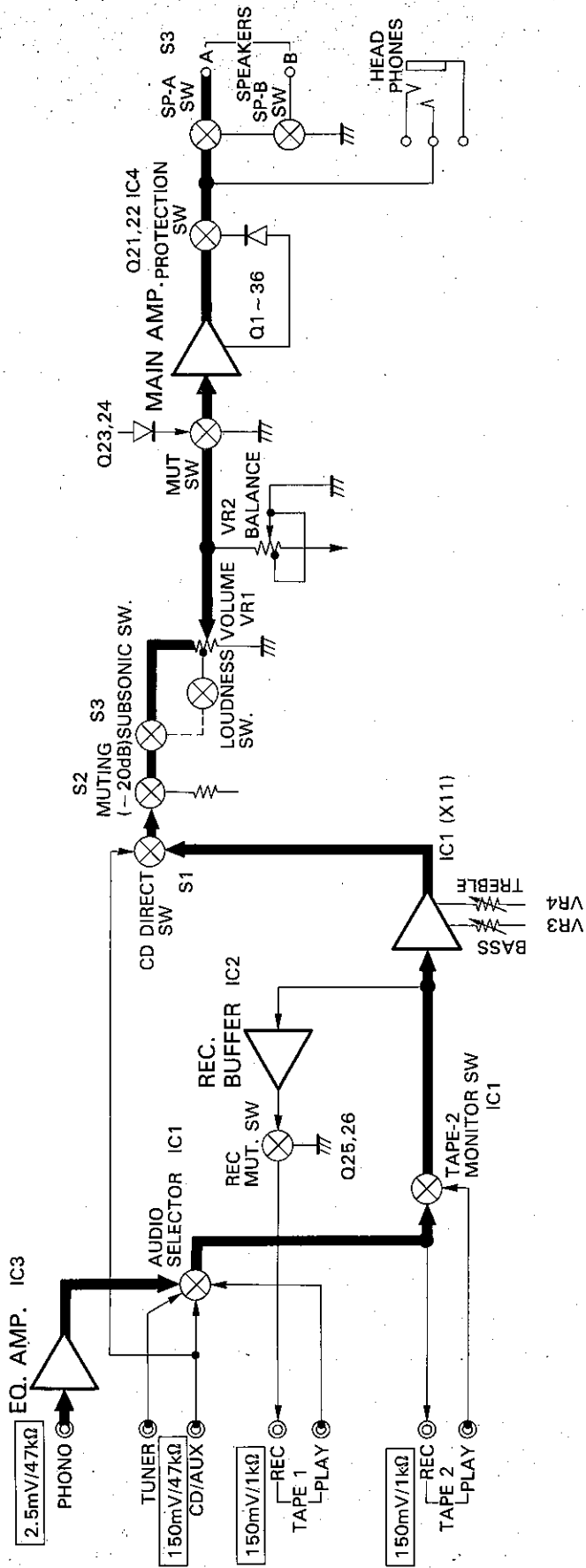

## CIRCUIT DESCRIPTION

## TONE CONTROL UNIT (X11-262X-XX)

Ref.No.	Name	Use and Function	Operation/Condition/Compatibility
IC1	$\mu$ PC4570C-A	2-device OP amp	For tone control, one device is used for one channel.

## AUDIO UNIT (X09-284X-XX)

Ref.No.	Name	Use and Function	Operation/Condition/Compatibility
IC1	LC7818	Input selector	C-MOS $\pm 13V$
IC2	$\mu$ PC4570C-A	TAPE-1 REC OUT buffer	
IC3	$\mu$ PC4570C-A	PHONO EQ amp.	
IC4	$\mu$ PC1237HA	Protection	Reset type
Q1~4	2SC1845(F,E)	Class A first stage amp	
Q5~8	2SA992(F,E)	Class A second stage amp	
Q9,10	2SC2632(Q,R,S)	A class amp.	
Q11~14	2SC2632(Q,R,S)	Third stage amp	
Q15,16	2SA1124(Q,R,S)	Current mirror	
Q17~20	2SA1535(Q,R,S) 2SC3944(Q,R,S)	Driver	
Q21,22	2SA733(A) 2SA933S	Over current protection	
Q23~26	2SC2878(B)	Mutting	HI:ON
Q27~30	2SA733(A) 2SA933S 2SC1740S 2SC945(A)	Mutting driver	
Q31	2SD882	+ 13 V regulated voltage	
Q32	2SA954(L,K)	- 13 V regulated voltage	
Q39	DTA124EN	For IC1 initialize spec.	Making pin MIN "L" when the + 13 V regulated voltage becomes 10 V.

## Device of main body part that does not belong to X09 unit.

Ref.No.	Name	Use and Function	Operation/Condition/Compatibility
Q33~36	2SB1162 2SB1163 2SD1717 2SD1718	Final stage	
Q37,38	2SC4137(V,W)	Bias transistors	HI:hfe

## ADJUSTMENT/REGLAGES/ABGLEICH

## ADJUSTMENT

No.	ITEM	INPUT SETTINGS	OUTPUT SETTINGS	AMPLIFIER SETTING	ALIGNMENT POINTS	ALIGN FOR	FIG.
Unless otherwise specified, set the respective switches as follows: POWER: ON SPEAKER: B REC OUT: OFF SELECTOR: PHONO							
1	IDLE CURRENT	-	Connect a DC voltmeter across CP1 (L) CP2 (R) (X09-)	VOLUME: 0	VR1 (L) VR2 (R) (X09-)	18mV	(a)

## REGLAGES

N°	ITEM	REGLAGE DE L'ENTREE	REGLAGE DE LA SORTIE	REGLAGE DE L'AMPLIFICATEUR	POINTS DE L'ALIGNMENT	ALIGNER POUR	FIG.
Sauf indication contraire, régler comme suit les commandes respectives: POWER: ON SPEAKER: B REC OUT: OFF SELECTOR: PHONO							
1	COURANT DE POLARISATION	-	Connecter un voltmètre de CC SUR CP1 (G) CP2 (D) (X09-)	VOLUME: 0	VR1 (G) VR2 (D) (X09-)	18mV	(a)

## ABGLEICH

NR.	GEGENSTAND	EINGANGS-EINSTELLUNG	AUSANG-EINSTELLUNG	VORSTÄRKER-EINSTELLUNG	ABGLEICHE-PUNKTE	ABGLEICHEN FÜR	ABB.
Wenn nicht anders angegeben, die einzelnen Schalter wie folgt einstellen: POWER: ON SPEAKER: B REC OUT: OFF SELECTOR: PHONO							
1	LEERLAUFSTROM	-	Einen Gleichspannungsmesser über CP1 (L) CP2 (R) anschließen. (X09-)	VOLUME: 0	VR1 (L) VR2 (R) (X09-)	18mV	(a)

## ADJUSTMENT/REGLAGES/ABGLEICH

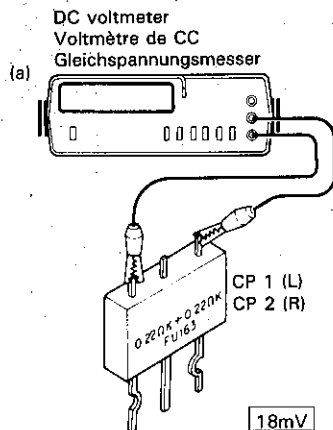

## VOLTAGE TABLES

### AUDIO UNIT (X09-284X-XX)

IC1

9	-13V
22	13V

IC2

1,2	0V
4	-13V
6,7	0V
8	13V

IC3

1	0V
4	-13V
7	0V
8	13V

IC4

4	2.8V
6	0.7V
7	2.2V
8	3.4V

Q1~4

E	-0.6V
C	64.1V
B	0V

Q5~8

E	64.8V
C	-
B	64.1V

Q9,10

E	-0.6V
C	-
B	0V

Q11, 12

E	-63V
C	-0.6V
B	-62.4V

Q13, 14

E	-63V
C	-1.2V
B	-62.4V

Q15, 16

E	62V
C	1.2V
B	61.4V

Q17, 18

E	-0.6V
C	-66.5V
B	-1.2V

Q19,20

E	0.6V
C	66.5V
B	1.2V

Q27, 30

E	13V
C	-
B	-

Q31

E	12.5V
C	-
B	-

Q32

E	-12.5V
C	-
B	-

Q33, 34

E	-
C	-66.5V
B	-0.6V

Q35, 36

E	-
C	66.5V
B	-

Q37, 38

E	-1.2V
C	1.2V
B	-0.6V

Q39

E	13V
C	-
B	-

### TONE UNIT (X11-262X-XX)

IC1

1	0V
4	-13V
7	0V
8	13V

# PC BOARD (Component side view)

## 1 TONE UNIT (X11-262X-XX) (A/3)

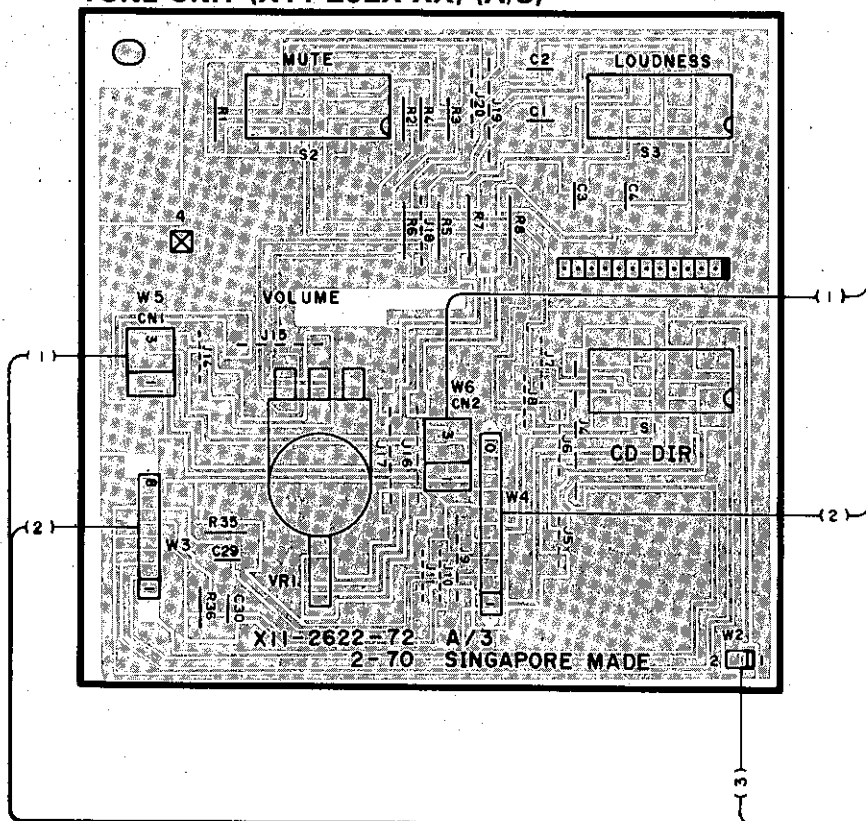

## 2 TONE UNIT (X11-262X-XX)

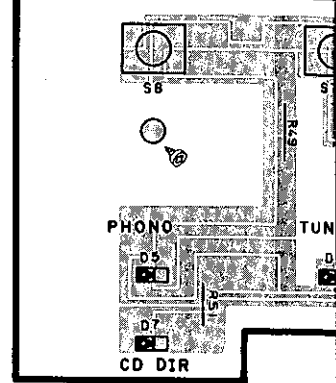

## 3 AUDIO UNIT (X09-28XX-XX) (B/6)

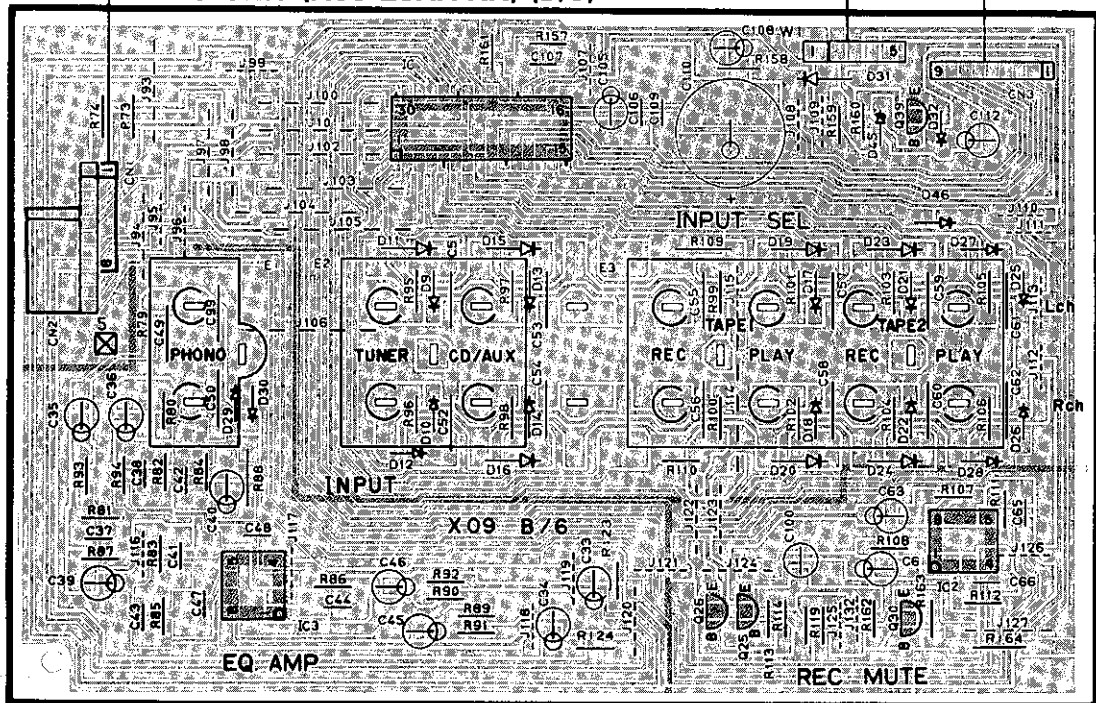

AUDIC

32X-XX) (C/3)

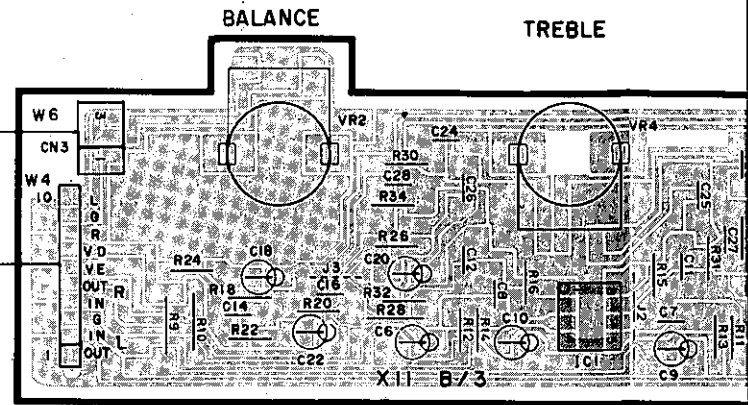
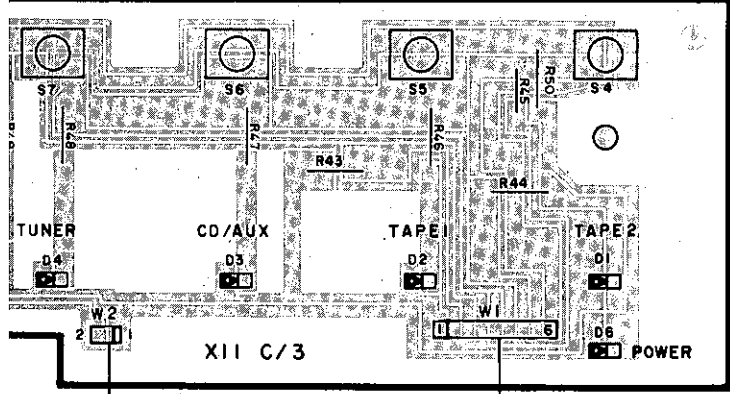

TONE UNIT (X11-262X-XX) (B/3)

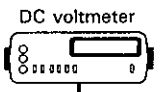

(a) IDLE CURRENT 18mV

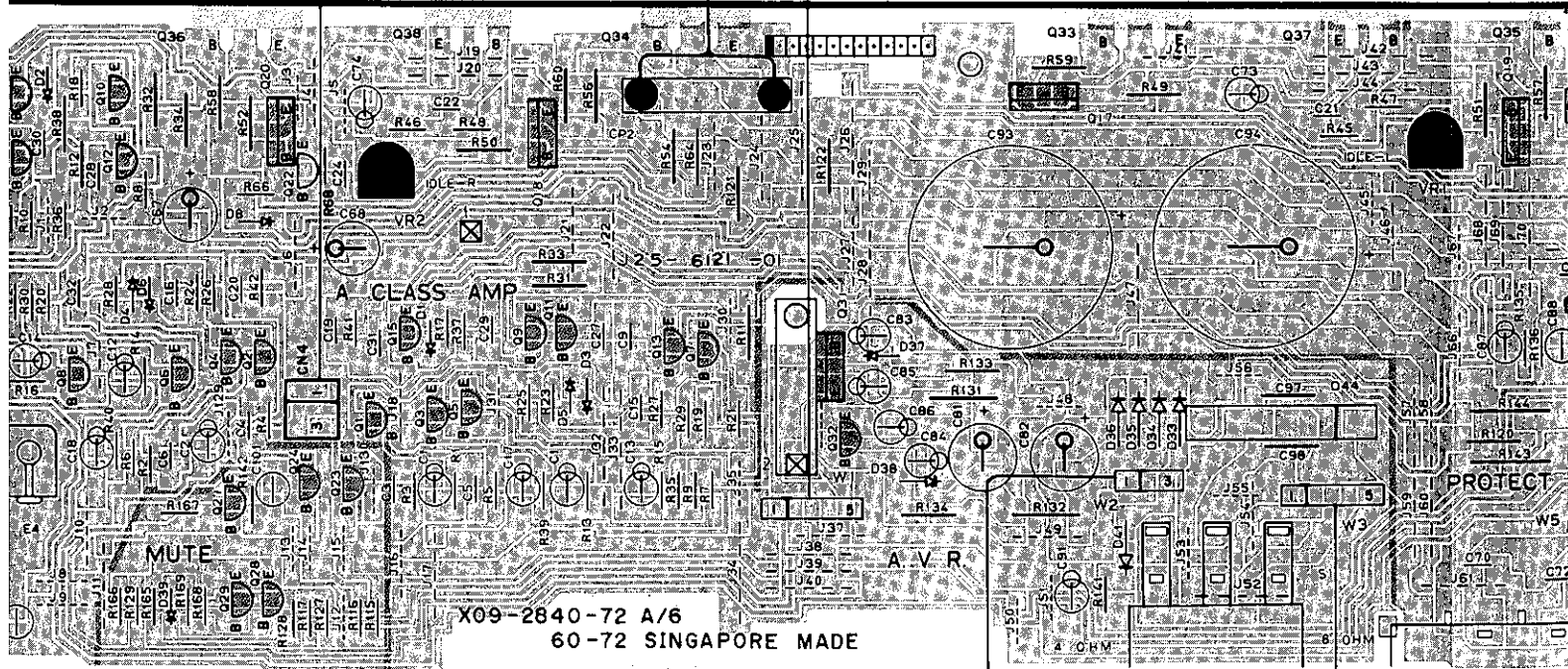

RADIO UNIT (X09-28XX-XX) (A/6)

LESS THAN 8Ω ← 8Ω or MORE

Rich SPEAKER



BASS

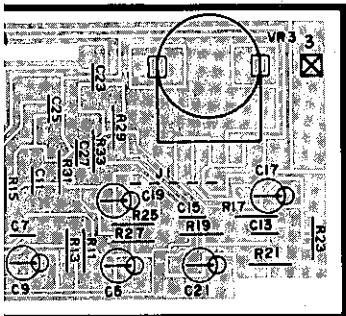

SPEAKERS

PHONES

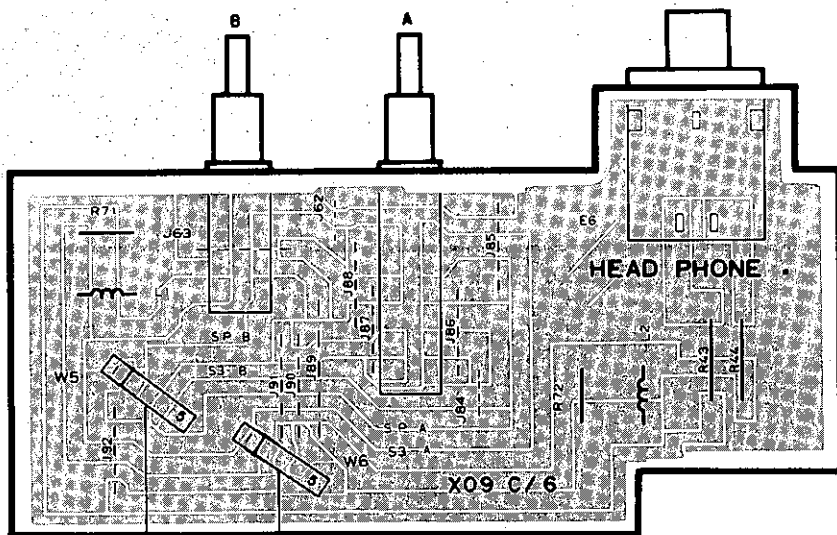

POWER

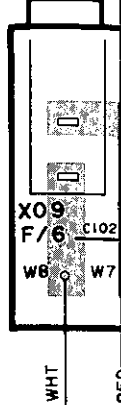

AUDIO UNIT (X09-28XX-XX) (C/6)

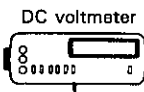

(a) IDLE CURRENT 18mV

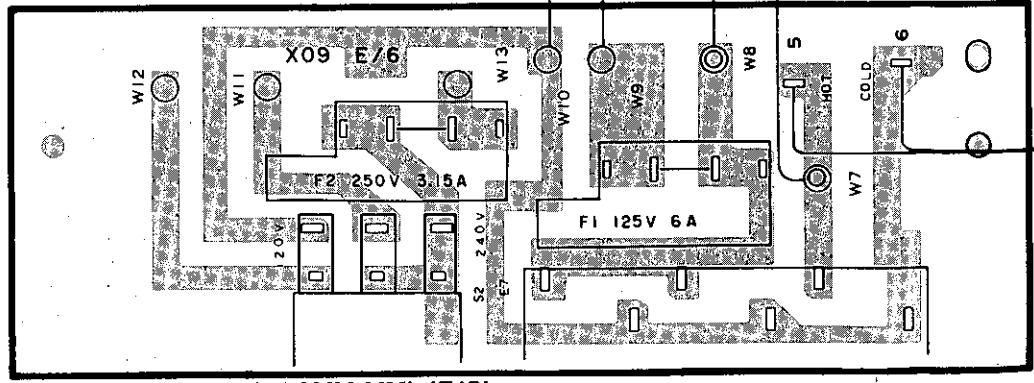
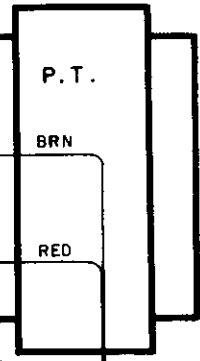
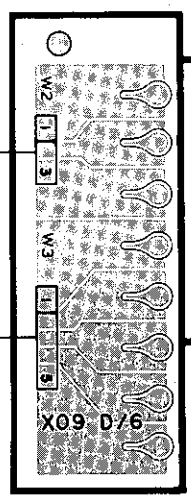
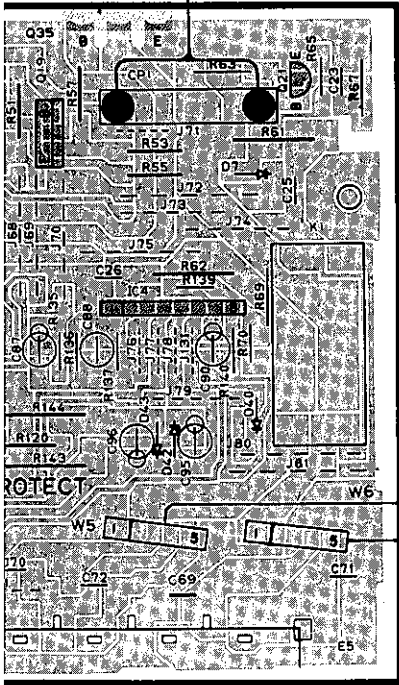

AUDIO UNIT (X09-28XX-XX) (E/6)

Reh Lch SPEAKERS (8~16Ω)

AC

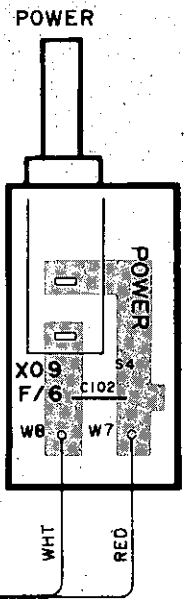

**AUDIO UNIT (X09-28XX-XX)**

Ref. No.		Address
IC	Q	
	1	6F
	2	5F
	3	6G
	4	5F
	5	6G
	6	6F
	7	5G
	8	5E
	9	5G
	10	5F
	11	5G
	12	5F
	13	5G
	14	5E
	15	5G
	16	5E
	17	5I
	18	5G
	19	5J
	20	5F
	21	4K
	22	5F
	23	6F
	24	6F
	25	6D
	26	6D
	27	6F
	28	6F
	29	6F
	30	6D
	31	5H
	32	6H
	33	4I
	34	4G
	35	4J
	36	4F
	37	4J
	38	4G
	39	4D
1		5C
2		6D
3		6B
4		5J

**TONE UNIT (X11-262X-XX)**

Ref. No.		Address
IC	Q	
1		2J

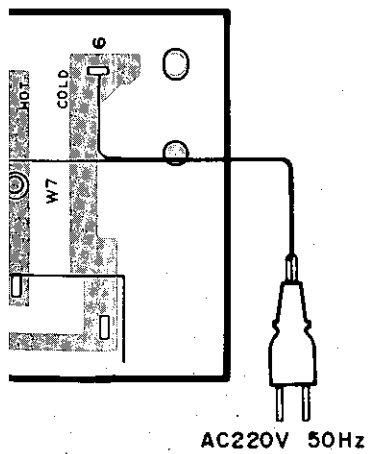

**KA-1010 (E)**

Refer to the schematic diagram for the values of resistors and capacitors.

# PC BOARD (Foil side view)

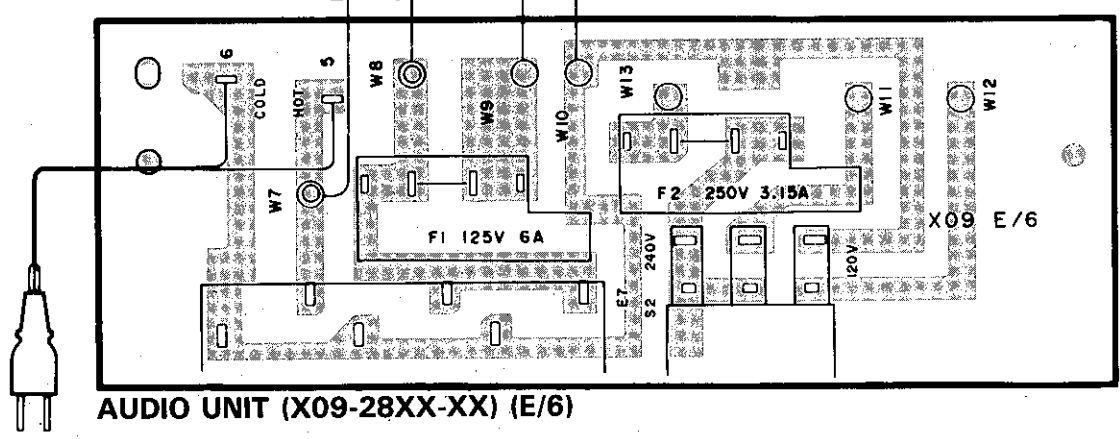
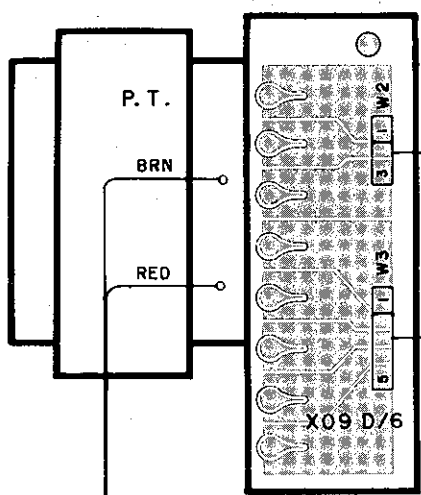
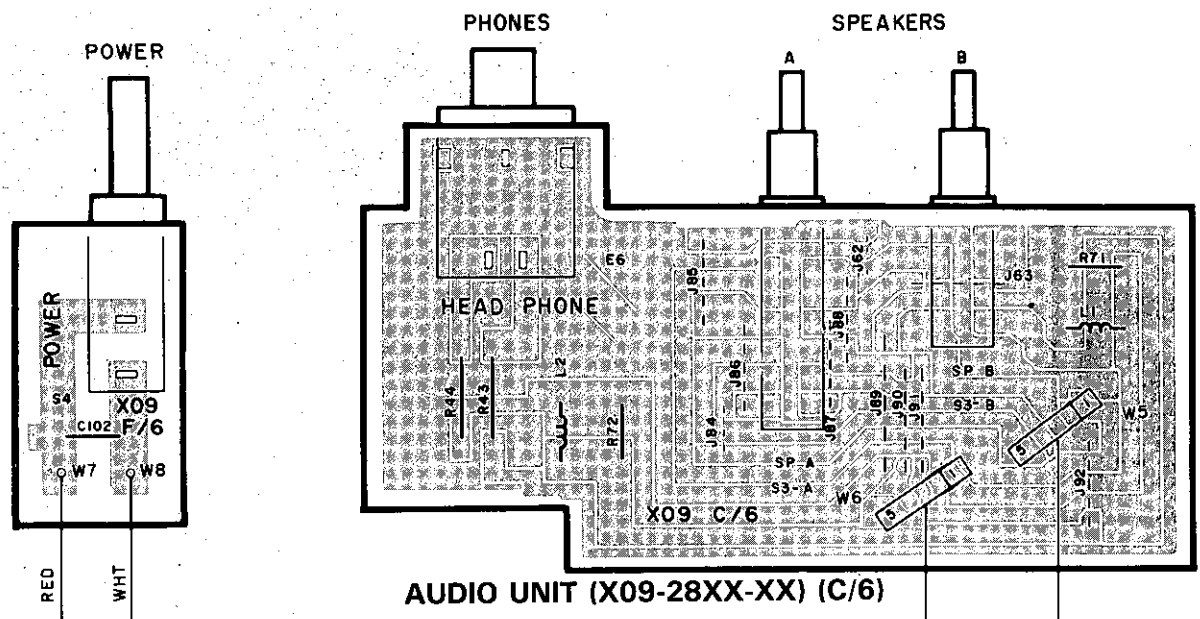

**AUDIO UNIT (X09-28XX-XX) (E/6)**

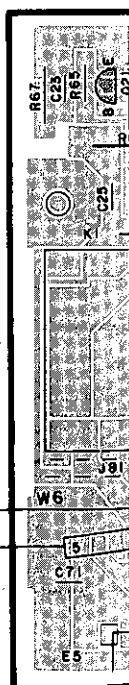

BASS

TREBLE

BALANCE

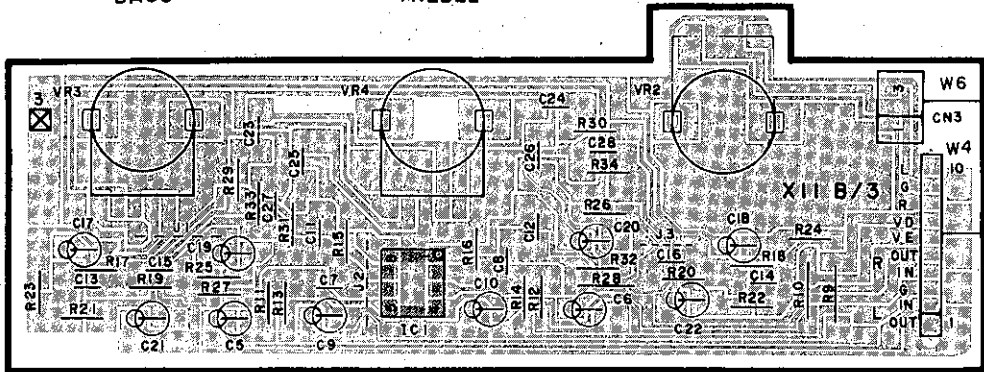

TONE UNIT (X11-262X-XX) (B/3)

TONE UNIT (X11-262X-XX) (C/3)

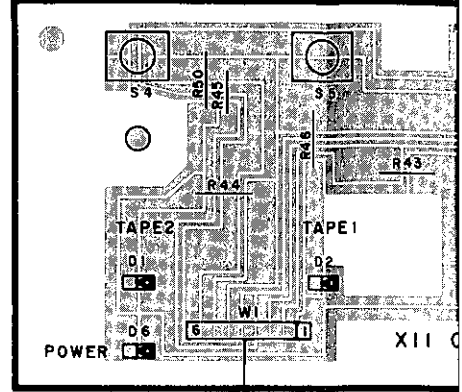

DC voltmeter

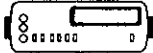

(a) IDLE CURRENT 18mV

DC voltmeter

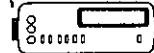

(a) IDLE CURRENT 18mV

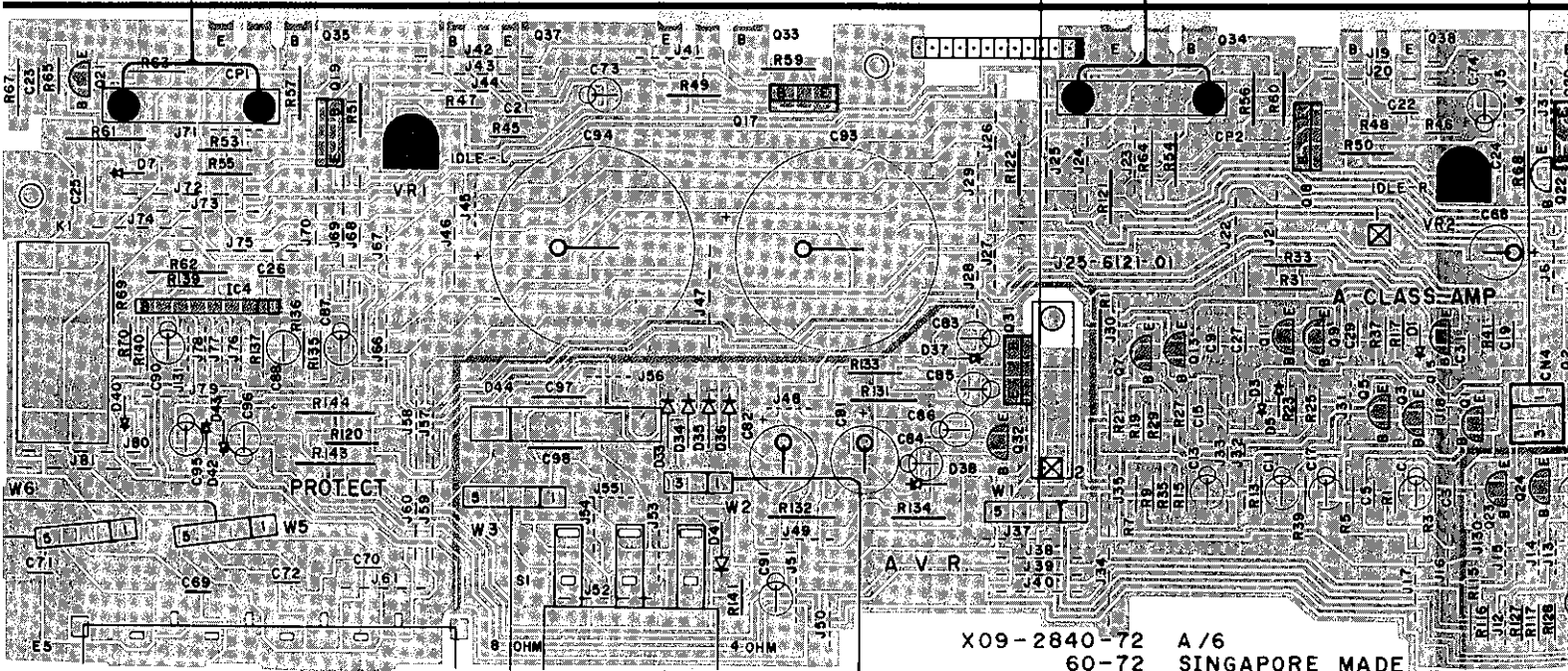

X09-2840-72 A/6  
60-72 SINGAPORE MADE

AUDIO UNIT (X09-28XX-XX) (A/6)

Lch - - - - - Rch  
SPEAKERS (8~16Ω)

8Ω or MORE ← LESSTHAN 8Ω



(X) (C/3)

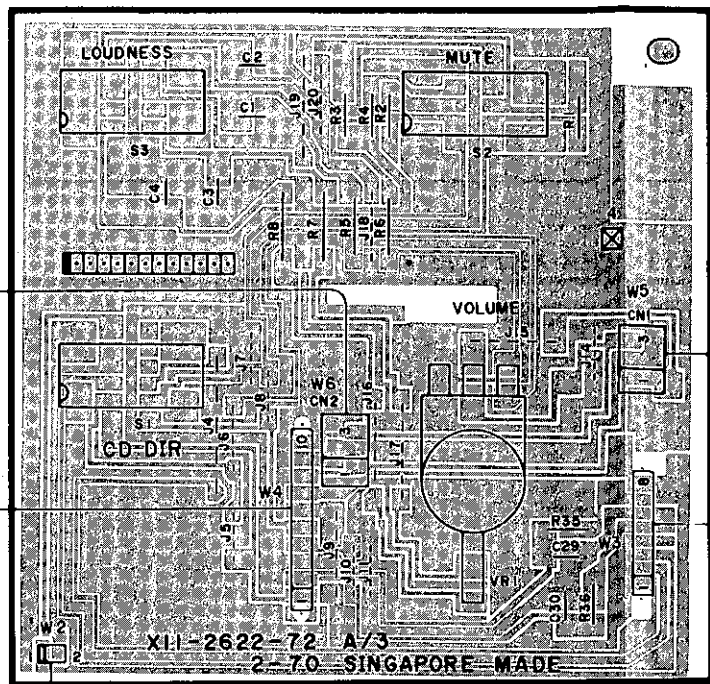
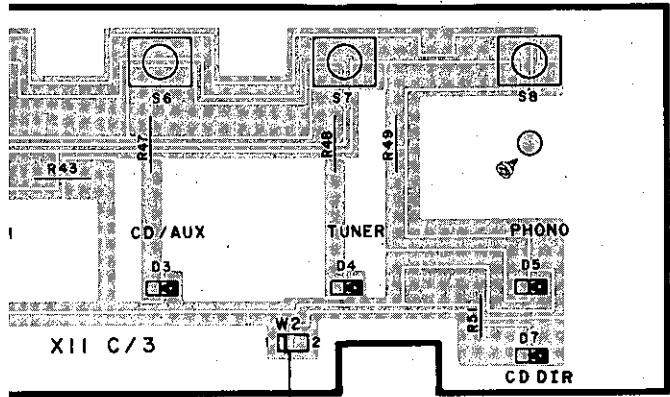

TONE UNIT (X11-262X-XX) (A/3)

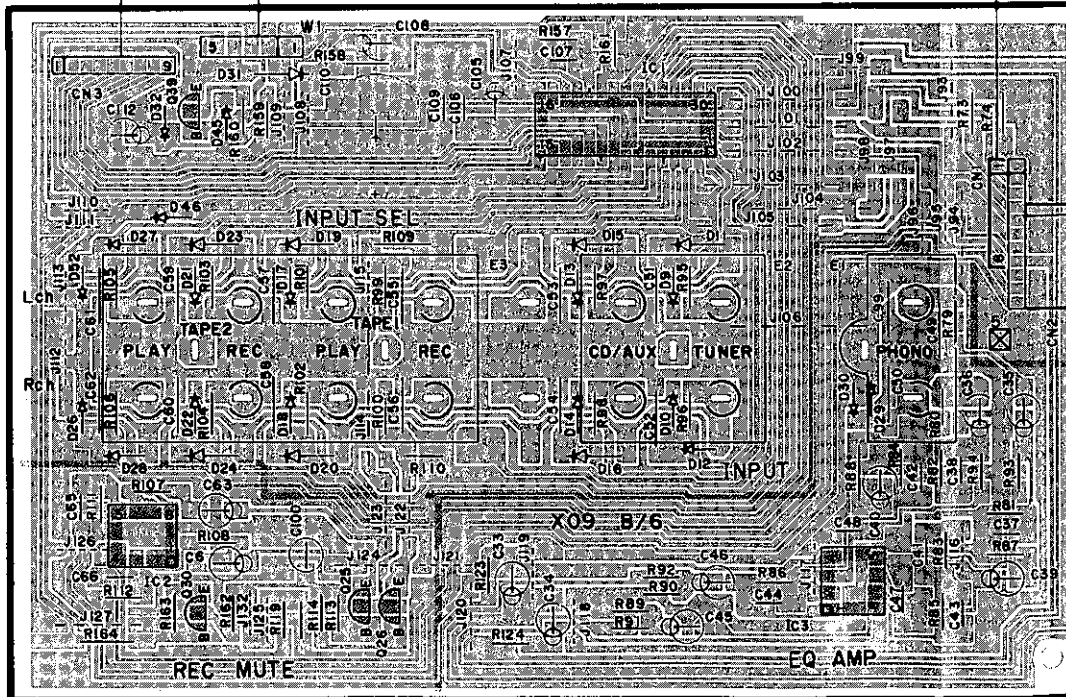
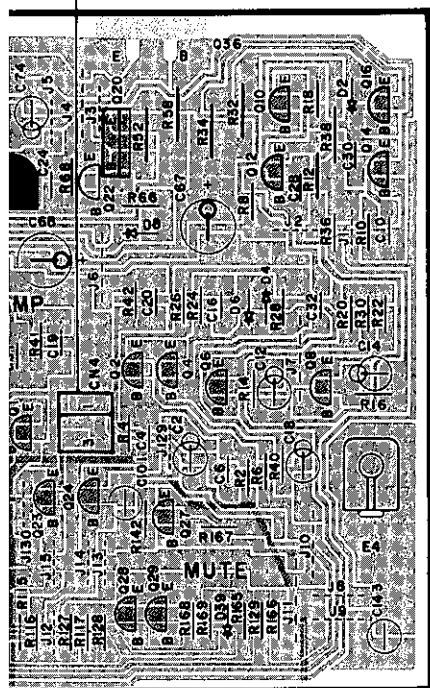

AUDIO UNIT (X09-28XX-XX) (B/6)

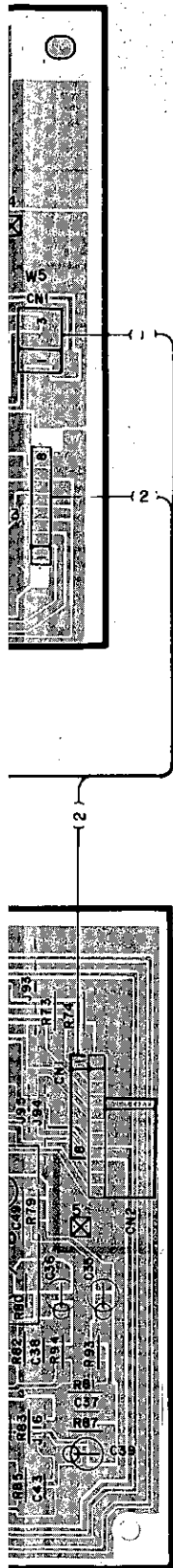

KA-1010(E)

**AUDIO UNIT (X09-28XX-XX)**

Ref. No.		Address
IC	Q	
	1	6AC
	2	6AC
	3	6AC
	4	6AD
	5	6AC
	6	6AD
	7	5AB
	8	6AD
	9	5AC
	10	5AD
	11	5AB
	12	5AD
	13	5AB
	14	5AD
	15	5AC
	16	5AD
	17	5AA
	18	5AB
	19	5Y
	20	5AC
	21	5Y
	22	5AC
	23	6AC
	24	6AC
	25	6AF
	26	6AF
	27	6AD
	28	6AC
	29	6AD
	30	6AE
	31	5AB
	32	6AB
	33	4AA
	34	4AB
	35	4Y
	36	4AD
	37	4Z
	38	4AC
	39	5AC
1		5AG
2		6AE
3		6AH
4		5Y

**TONE UNIT (X11-262X-XX)**

Ref. No.		Address
IC	Q	
1		3Z

Refer to the schematic diagram for the values of resistors and capacitors.

(X09-2842-72) (B/6) JAPAN MADE  
 (X09-2862-72) (B/6) SINGAPORE MADE

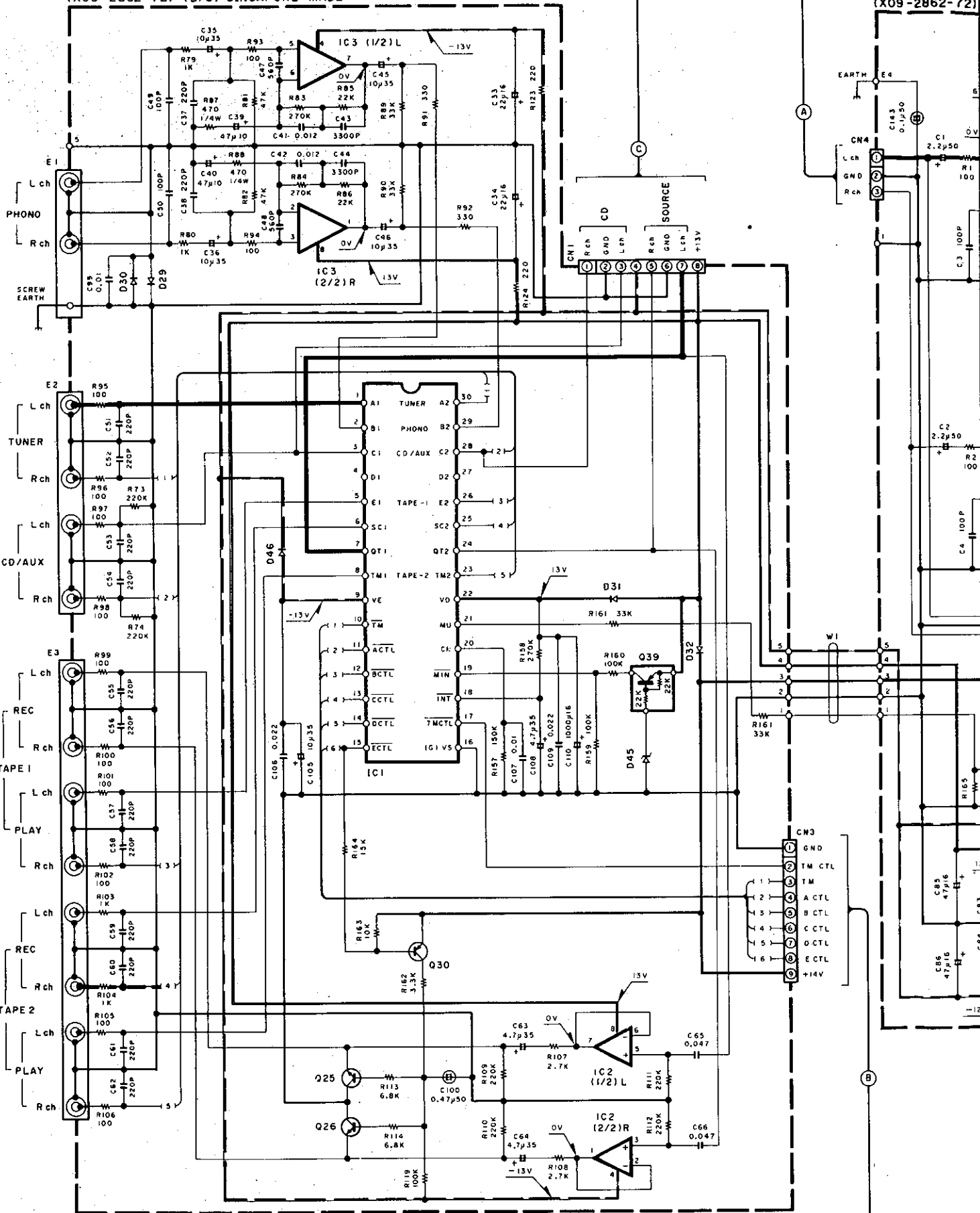

DTA124EN

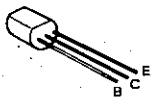

2SA1124 2SC2632  
 2SA1284 2SC2878  
 2SA733(A) 2SC3244  
 2SA954 2SC945(A)  
 2SC1845

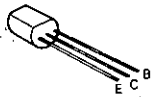

2SD882

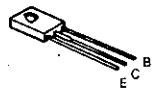

2SA1694\*5  
 2SC4467\*5

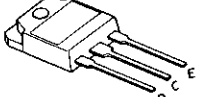

2SA93C

2SC174

1  
2  
3  
4  
5  
6  
7

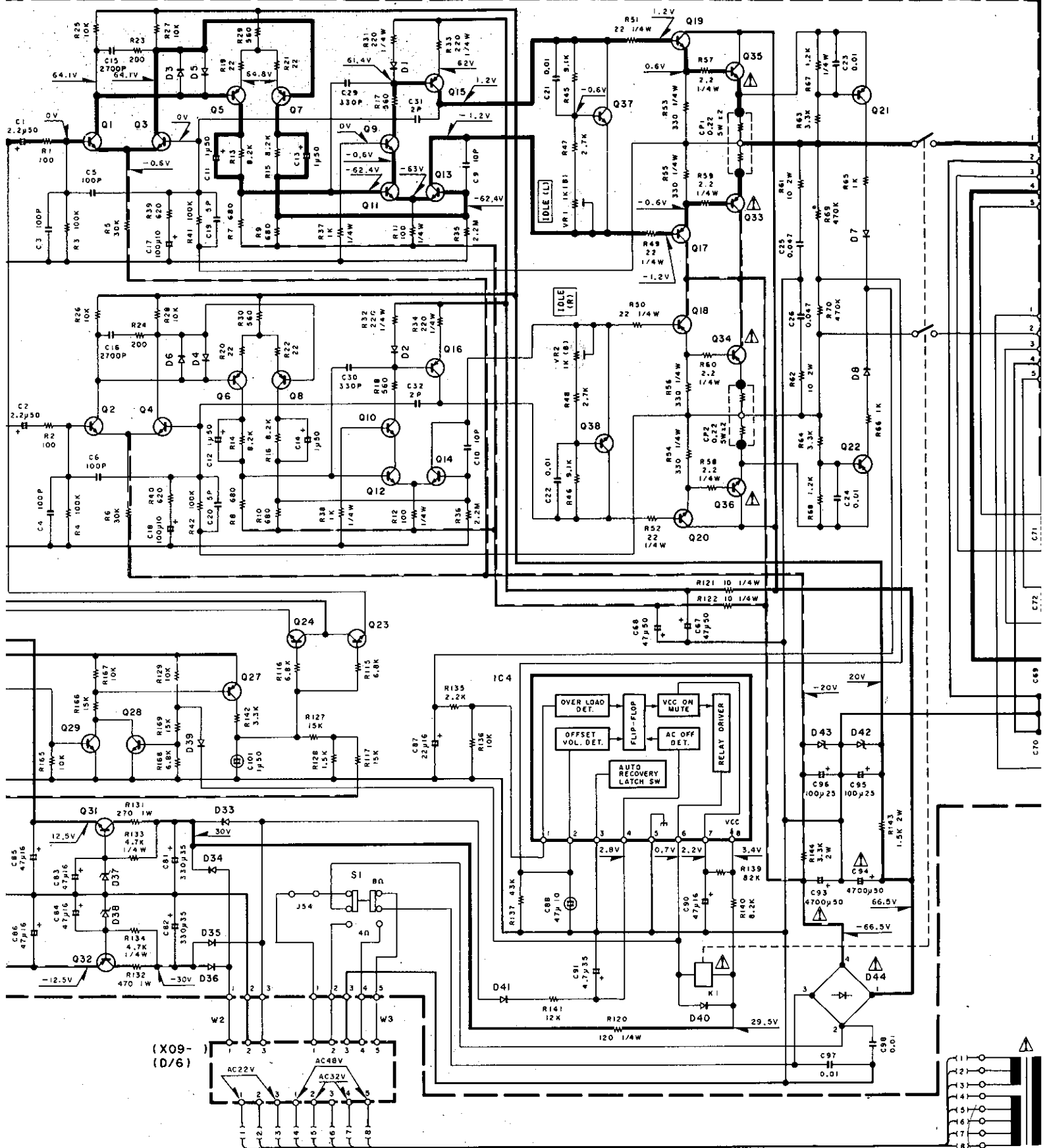

2SA933S  
 2SC1740S

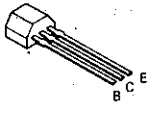

2SC4137



μPC4570C-A

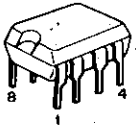

μPC1237HA

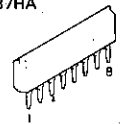

LC7818

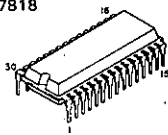



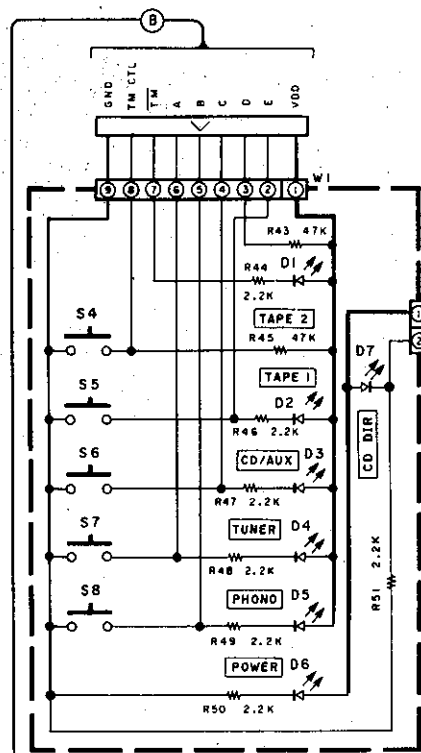
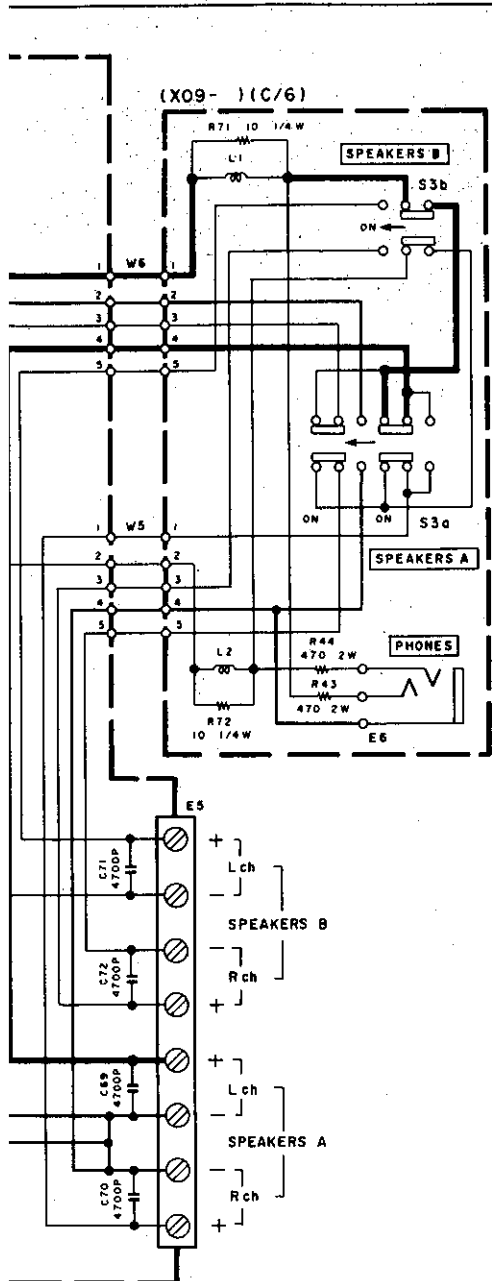

(X11-)(C/3) 01~7: B30-1223-05

- (X09-2842-72)
- (X09-2862-72)
- IC1 : LC7818
- IC2,3 : μPC4570C-A
- IC4 : μPCI237HA
- Q1~4 : 2SC1845(F, E)
- Q5~8, 21, 22, 27, 30 : 2SA733(A)(Q, P) or 2SA933(Q, R)
- Q9~14 : 2SC2632(Q, R, S)
- Q15, 16 : 2SA1124(Q, R, S)
- Q17, 18 : 2SA1284(D, E)
- Q19, 20 : 2SC3244(D, E)
- Q23~26 : 2SC2878(B)
- Q28, 29 : 2SC945(A)(Q, P) or 2SC1740S(Q, R)
- Q31 : 2SD882
- Q32 : 2SA954(L, K)
- Q33, 34 : 2SA1491
- Q35, 36 : 2SC3855
- Q37, 38 : 2SC4137(V, W)
- Q39 : DTA124EN

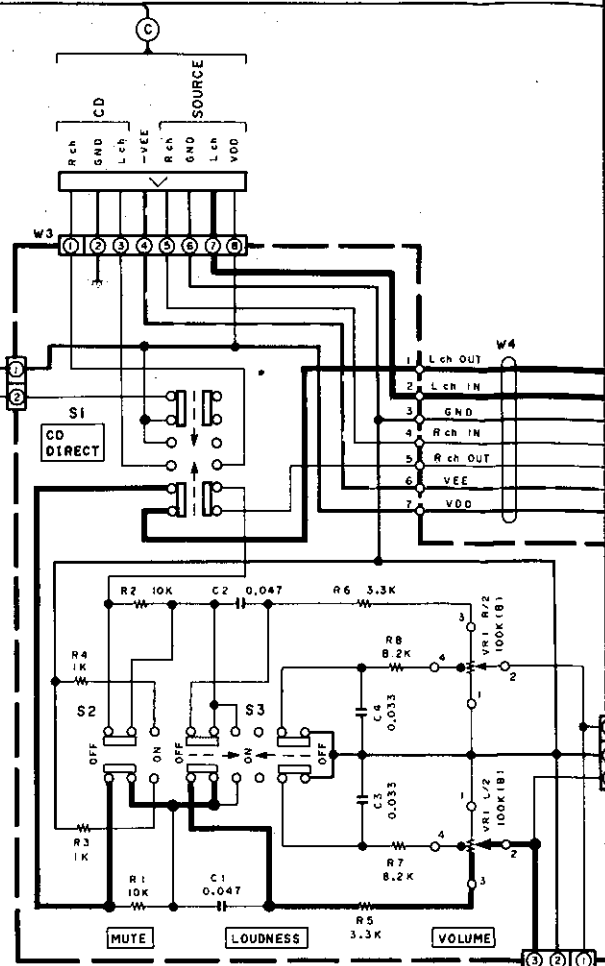

(X11-)(A/3)

- D1~8, 29~32, 39, 40, 46 : ISS133 or ISS104
- D33~36, 41 : S5566B
- D37, 38 : RD13ES(B2) or HZS13M(B2)
- D42, 43 : RD20ES(B) or HZS20N(B)
- D44 : RBV-402LFA
- D45 : RD10ES(B) or HZSION(B)

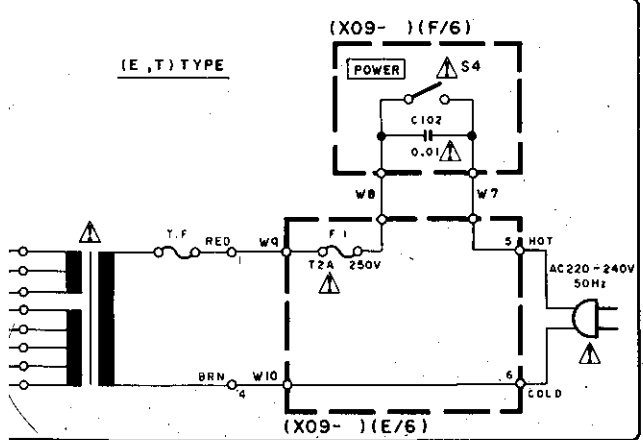

(X09-)(E/6)

DC voltages are as measured with a high impedance voltmeter with no signal input. Values may vary slightly due to variations between individual instruments or/and units.

Les tensions c.c. doivent être mesurées avec un voltmètre à haute impédance sans signal d'entrée. Les valeurs peuvent différer légèrement du fait des variations inhérentes aux appareils et aux instruments de mesure individuels.

Die angege-  
einem hoch-  
signal gem-  
aufgrund v  
Instrumenten

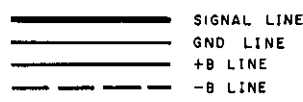
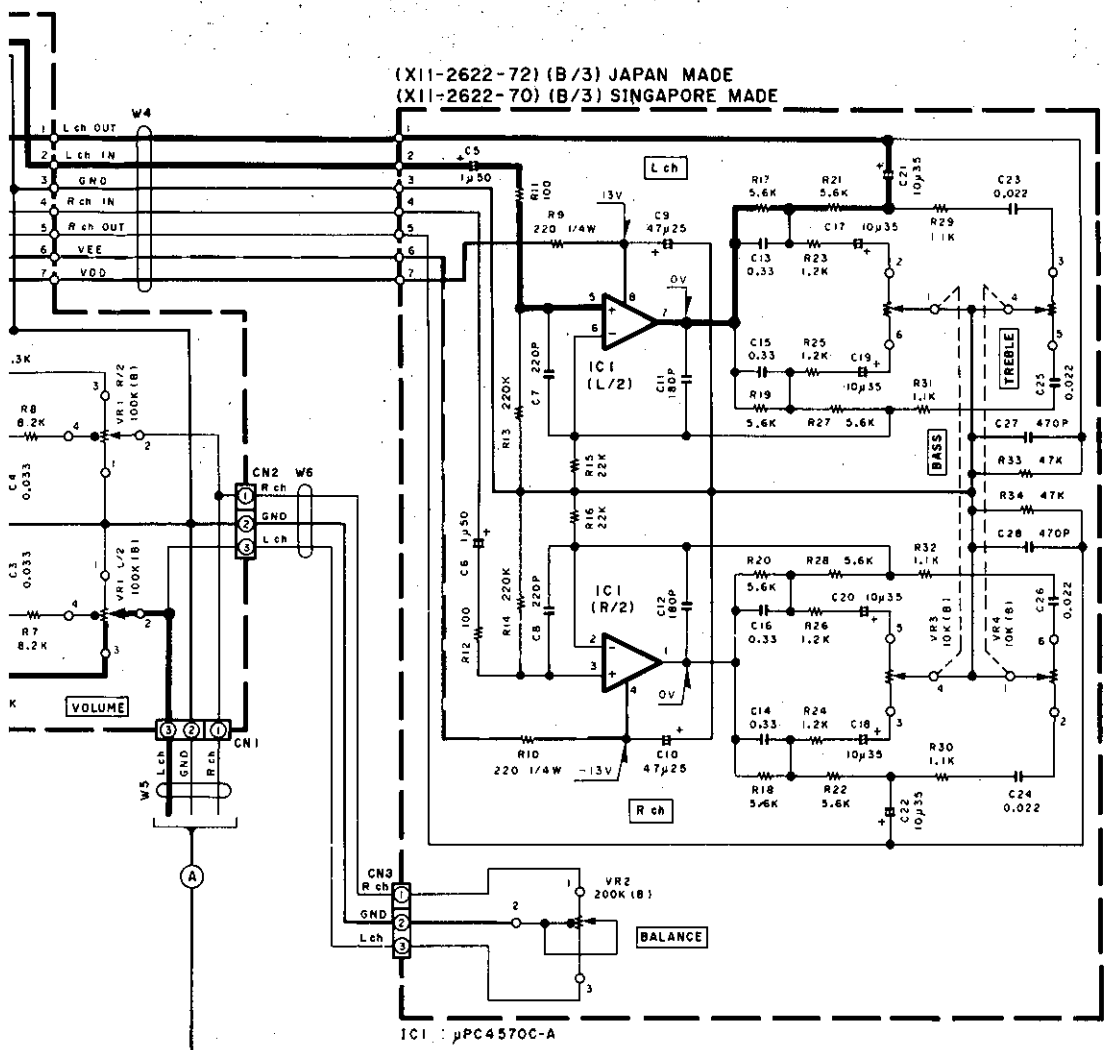

KA-1010(E)

**CAUTION:** For continued safety, replace safety critical components only with manufacturer's recommended parts (refer to parts list).  Indicates safety critical components. To reduce the risk of electric shock, leakage-current or resistance measurements shall be carried out (exposed parts are acceptably insulated from the supply circuit) before the appliance is returned to the customer.

un volt-  
rée. Les  
es varia-  
nts de

Die angegebenen Gleichspannungswerte wurden mit einem hochohmigen Spannungsmesser ohne Eingangssignal gemessen. Dabei schwanden die Meßwerte aufgrund von Unterschieden zwischen einzelnen Instrumenten oder Geräten u.U. geringfügig.

Y08-3702-73



## EXPLODED VIEW

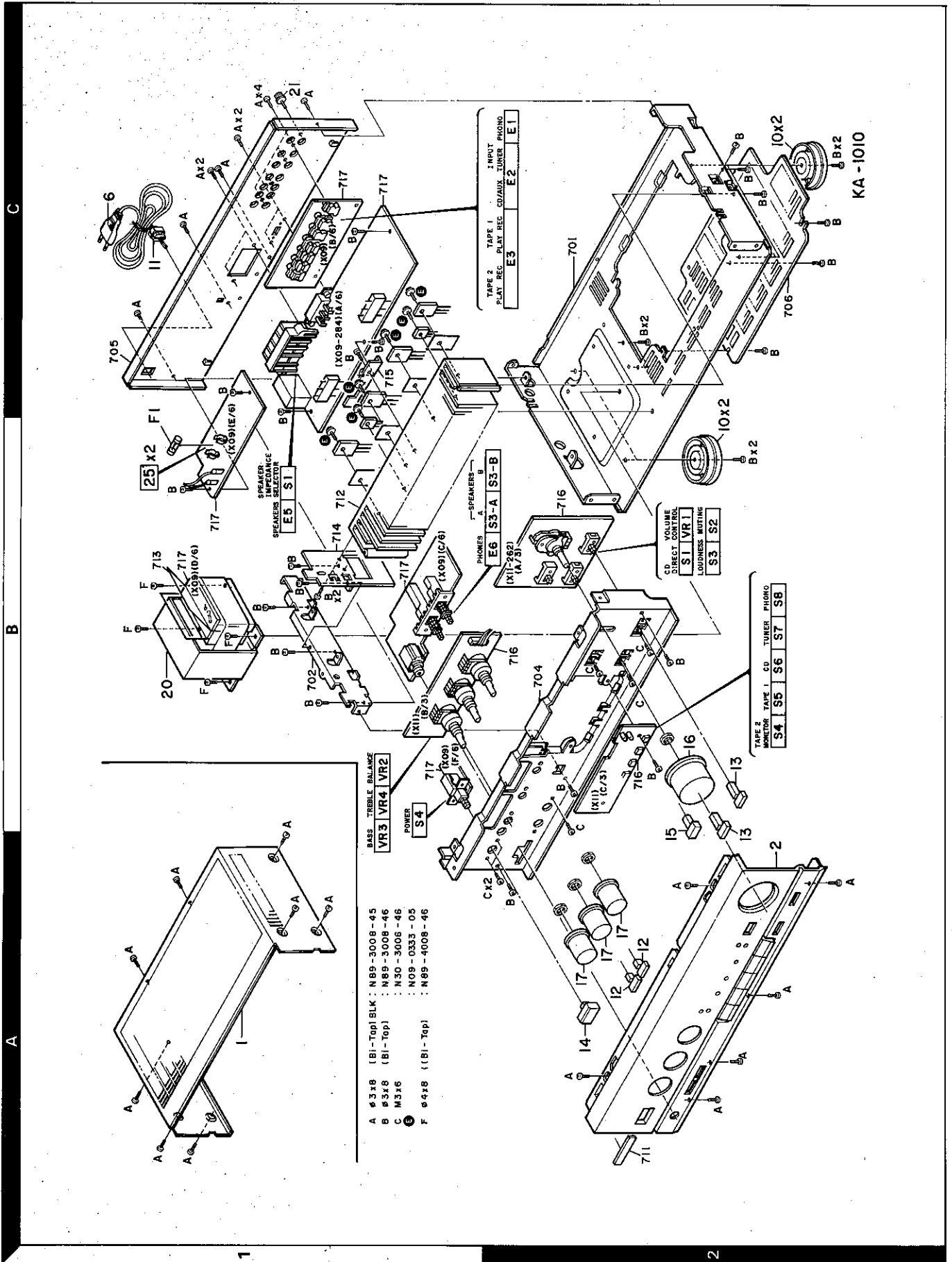

## PARTS LIST

× New Parts

Parts without Parts No. are not supplied.

Les articles non mentionnés dans le Parts No. ne sont pas fournis.

Telle ohne Parts No. werden nicht geliefert.

Ref. No. 参照番号	Address 位置	New Parts 新	Parts No. 部品番号	Description 部品名 / 規格	Desti- nation 仕 向	Re- marks 備考
<b>KA-1010</b>						
1	1A	*	A01-1745-01	METALLIC CABINET		
2	2A	*	A20-5767-02	PANEL ASSY		
-			B46-0122-13	WARRANTY CARD	E	
-			B46-0143-03	WARRANTY CARD	T	
-			B50-9476-00	INSTRUCTION MANUAL (ENG)		J
-		*	B50-9645-00	INSTRUCTION MANUAL (ENG)		J
-		*	B50-9646-00	INSTRUCTION MANUAL (FRE)	E	J
-		*	B50-9659-00	INSTRUCTION MANUAL (ENG)		S
-		*	B50-9660-00	INSTRUCTION MANUAL (FRE)	E	S
-		*	B50-9670-00	INSTRUCTION MANUAL (G/D/I)	E	S
-		*	B50-9671-00	INSTRUCTION MANUAL (G/D/I)	E	S
-		*	B58-0803-13	CAUTION CARD	E	
△ 6	1C		E30-0459-05	AC POWER CORD	E	
△ 6	1C		E30-1416-05	AC POWER CORD	T	
△ F1	1C		F05-1623-05	FUSE (SEMKO) (250V T1.6A)		
-		*	H01-8444-04	ITEM CARTON CASE		J
-		*	H01-8517-04	ITEM CARTON CASE		S
-		*	H10-3845-02	POLYSTYRENE FOAMED FIXTURE		J
-		*	H10-3846-02	POLYSTYRENE FOAMED FIXTURE		J
-		*	H10-3847-02	POLYSTYRENE FOAMED FIXTURE		S
-			H10-3848-02	POLYSTYRENE FOAMED FIXTURE		S
-			H25-0223-04	PROTECTION BAG (750X350XD.03)		
-			H25-0232-04	PROTECTION BAG (235X350XD.03)		
△ 10	2C		J02-1034-05	FOOT		
△ 11	1C		J42-0083-05	POWER CORD BUSHING		
-			J61-0307-05	WIRE BAND		
12	2A		K27-0742-14	KNØB (BUTTON) SPEAKERS		
13	2B		K27-1725-04	KNØB (BUTTON) LOUDNESS, MUTING		
14	2A	*	K27-1965-04	KNØB (BUTTON) POWER		
15	2A	*	K27-1968-04	KNØB (BUTTON) CD DIRECT		
16	2A	*	K29-3595-04	KNØB (VOLUME CONTROL)		
17	2A		K29-3596-04	KNØB (BASS, TREBLE, BALANCE)		
△ 20	1B		L01-5972-05	POWER TRANSFORMER	T	
△ 20	1B		L01-5977-05	POWER TRANSFORMER	E	
21	1C		N08-0128-35	BINDING POST		
A	1A, 1C		N89-3008-45	BINDING HEAD TAPTITE SCREW		
B	1B, 2C		N89-3008-46	BINDING HEAD TAPTITE SCREW		
C	2B		N30-3006-46	PAN HEAD MACHINE SCREW		
E	1C		N09-0333-05	TAPPING SCREW (3X12,+)		
F	1B		N89-4008-46	BINDING HEAD TAPTITE SCREW		
△ Q33, 34			2SA1694*5	TRANSISTOR		
△ Q35, 36			2SC4467*5	TRANSISTOR		
Q37, 38			2SC4137(V,W)	TRANSISTOR		
<b>AUDIO UNIT (X09-28XX-XX) Japan made:42-72 Singapore made:67-72</b>						
C1 ,2			CE04KW1H2R2M	ELECTRO 2.2UF 50WV		J
C1 ,2			CE04LW1H2R2M	ELECTRO 2.2UF 50WV		S
C3 -6			CC45FSL1H101J	CERAMIC 100PF J		
C9 ,10			CC45FSL1H100D	CERAMIC 10PF D		
C11 -14			CE04KW1H010M	ELECTRO 1.0UF 50WV		J

E: Scandinavia & Europe K: USA

P: Canada

J: Japan made

U: PX(Far East, Hawaii)

T: England

M: Other Areas

S: Singapore made

UE: AAFES(Europe)

X: Australia

△ indicates safety critical components.

# PARTS LIST

× New Parts

Parts without Parts No. are not supplied.

Les articles non mentionnés dans le Parts No. ne sont pas fournis.

Telle ohne Parts No. werden nicht geliefert.

Ref. No. 参照番号	Address 位置	New Parts 新	Parts No. 部品番号	Description 部品名 / 規格	Desti- nation 仕向	Re- marks 備考
C11 -14			CE04LW1H010M	ELECTR0 1.0UF 50WV		S
C15 ,16			CF92FV1H272J	MF 2700PF J		J
C17 ,18			CE04KW1A101M	ELECTR0 100UF 10WV		S
C17 ,18			CE04LW1A101M	ELECTR0 100UF 10WV		S
C19 ,20			CC45FSL1H050C	CERAMIC 5.0PF C		
C21 ,22			CK45FF1H103Z	CERAMIC 0.010UF Z		
C23 ,24			CF92FV1H103J	MF 0.010UF J		
C25 ,26			CF92FV1H473J	MF 0.047UF J		
C29 ,30			CC45FSL1H331J	CERAMIC 330PF J		
C31 ,32			CC45FSL1H020C	CERAMIC 2.0PF C		
C33 ,34			CE04KW1C220M	ELECTR0 22UF 16WV		J
C33 ,34			CE04LW1C220M	ELECTR0 22UF 16WV		S
C35 ,36			CE04KW1V100M	ELECTR0 10UF 35WV		J
C35 ,36			CE04LW1V100M	ELECTR0 10UF 35WV		S
C37 ,38			CC45FSL1H221J	CERAMIC 220PF J		
C39 ,40			CE04KW1A470M	ELECTR0 47UF 10WV		J
C39 ,40			CE04LW1A470M	ELECTR0 47UF 10WV		S
C41 ,42			CF92FV1H123J	MF 0.012UF J		
C43 ,44			CF92FV1H332J	MF 3300PF J		
C45 ,46			CE04KW1V100M	ELECTR0 10UF 35WV		J
C45 ,46			CE04LW1V100M	ELECTR0 10UF 35WV		S
C47 ,48			CK45FB1H561K	CERAMIC 560PF K		
C49 ,50			C91-0745-05	CERAMIC 100PF K		
C51 -62			C91-0749-05	CERAMIC 220PF K		
C63 ,64			CE04KW1V4R7M	ELECTR0 4.7UF 35WV		J
C63 ,64			CE04LW1V4R7M	ELECTR0 4.7UF 35WV		S
C65 ,66			CF92FV1H473J	MF 0.047UF J		
C67 ,68			CE04KW1H470M	ELECTR0 47UF 50WV		J
C67 ,68			CE04LW1H470M	ELECTR0 47UF 50WV		S
C69 -72			CF92FV1H472J	MF 4700PF J		
C81 ,82			CE04KW1V331M	ELECTR0 330UF 35WV		J
C81 ,82			CE04LW1V331M	ELECTR0 330UF 35WV		S
C83 -86			CE04KW1C470M	ELECTR0 47UF 16WV		J
C83 -86			CE04LW1C470M	ELECTR0 47UF 16WV		S
C87			CE04KW1C220M	ELECTR0 22UF 16WV		J
C87			CE04LW1C220M	ELECTR0 22UF 16WV		S
C88			C90-1334-05	NP-ELEC 47UF 10WV		
C90			CE04KW1C470M	ELECTR0 47UF 16WV		J
C90			CE04LW1C470M	ELECTR0 47UF 16WV		S
C91			CE04KW1V4R7M	ELECTR0 4.7UF 35WV		J
C91			CE04LW1V4R7M	ELECTR0 4.7UF 35WV		S
△ C93 ,94			C90-1762-05	ELECTRO 4700UF 50WV		
C95 ,96			CE04KW1E101M	ELECTR0 100UF 25WV		J
C95 ,96			CE04LW1E101M	ELECTR0 100UF 25WV		S
C97 ,98			CK45FE2H103P	CERAMIC 0.010UF P		
C99			C91-0769-05	CERAMIC 0.01UF M		
C100			C90-1331-05	NP-ELEC 0.47UF 50WV		
C101			C90-1349-05	NP-ELEC 1UF 50WV		
△ C102			C91-0647-05	CERAMIC 0.01UF P		
C105			CE04KW1V100M	ELECTR0 10UF 35WV		J
C105			CE04LW1V100M	ELECTR0 10UF 35WV		S
C106			CK45FF1H223Z	CERAMIC 0.022UF Z		
C107			CF92FV1H103J	MF 0.010UF J		
C108			CE04KW1V4R7M	ELECTR0 4.7UF 35WV		J
C108			CE04LW1V4R7M	ELECTR0 4.7UF 35WV		S

E: Scandinavia & Europe K: USA P: Canada  
 U: PX(Far East, Hawaii) T: England M: Other Areas  
 UE: AAFES(Europe) X: Australia

J: Japan made

S: Singapore made

△ indicates safety critical components.

## PARTS LIST

× New Parts

Parts without Parts No. are not supplied.

Les articles non mentionnés dans le Parts No. ne sont pas fournis.

Telle ohne Parts No. werden nicht geliefert.

Ref. No. 参照番号	Address 位置	New Parts 新	Parts No. 部品番号	Description 部品名 / 規格	Desti- nation 仕向	Re- marks 備考
C109			CK45FF1H223Z	CERAMIC 0.022UF Z		
C110			C90-1256-05	ELECTRO 1000UF 16WV		
C143			C90-1455-05	NP-ELEC 0.1UF 50WV		
E1	2C	*	E13-0250-05	PHONE JACK		
E2	2C		E13-0486-05	PHONE JACK		
E3	2C	*	E13-0826-05	PHONE JACK		
E5	1B		E20-0823-05	LOCK TERMINAL BOARD(8P)		
E6	2B		E11-0162-05	PHONE JACK (3P)		
25	1B		J13-0054-05	FUSE CLIP		
L1 ,.2			L39-0085-05	PHASE-COMPENSATION COIL		
CP1 ,.2			R90-0187-05	MULTI-COMP 0.22X2 K 5W		
R11 ,.12			RD14GB2E101J	FL-PROOF RD 100 J 1/4W		J
R31			RD14GB2E221J	FL-PROOF RD 220 J 1/4W		S
R31 -34			RD14GB2E221J	FL-PROOF RD 220 J 1/4W		J
R32			RD14AB2E221J	FL-PROOF RD 220 J 1/4W		J
R33			RD14GB2E221J	FL-PROOF RD 220 J 1/4W		J
R34			RD14AB2E221J	FL-PROOF RD 220 J 1/4W		J
R43 ,.44			RS14DB3D471J	FL-PROOF RS 470 J 2W		J
R43 ,.44			RS14KB3D471J	FL-PROOF RS 470 J 2W		S
R49 -52			RD14AB2E220J	FL-PROOF RD 22 J 1/4W		J
R49 -52			RD14GB2E220J	FL-PROOF RD 22 J 1/4W		S
R53 -56			RD14AB2E331J	FL-PROOF RD 330 J 1/4W		J
R53 -56			RD14GB2E331J	FL-PROOF RD 330 J 1/4W		S
R57 -60			RD14AB2E2R2J	FL-PROOF RD 2.2 J 1/4W		J
R57 -60			RD14GB2E2R2J	FL-PROOF RD 2.2 J 1/4W		S
R61			RS14DB3D100J	FL-PROOF RS 10 J 2W		J
R61 ,.62			RS14KB3D100J	FL-PROOF RS 10 J 2W		S
R62			RS14KB3D100J	FL-PROOF RS 10 J 2W		J
R71 ,.72			RD14AB2E100J	FL-PROOF RD 10 J 1/4W		J
R71 ,.72			RD14GB2E100J	FL-PROOF RD 10 J 1/4W		S
R120			RD14AB2E121J	FL-PROOF RD 120 J 1/4W		J
R120			RD14GB2E121J	FL-PROOF RD 120 J 1/4W		S
R121,122			RD14AB2E100J	FL-PROOF RD 10 J 1/4W		J
R121,122			RD14GB2E100J	FL-PROOF RD 10 J 1/4W		S
R131			RS14DB3A271J	FL-PROOF RS 270 J 1W		J
R131			RS14KB3A271J	FL-PROOF RS 270 J 1W		S
R132			RS14DB3A471J	FL-PROOF RS 470 J 1W		J
R132			RS14KB3A471J	FL-PROOF RS 470 J 1W		S
R133,134			RD14AB2E472J	FL-PROOF RD 4.7K J 1/4W		J
R133,134			RD14GB2E472J	FL-PROOF RD 4.7K J 1/4W		S
R143			RS14KB3D152J	FL-PROOF RS 1.5K J 2W		
R144			RS14DB3D332J	FL-PROOF RS 3.3K J 2W		J
R144			RS14KB3D332J	FL-PROOF RS 3.3K J 2W		S
VR1 ,.2			R12-1083-05	TRIMMING POT. (1K)		
△ K1			S51-2078-05	MAGNETIC RELAY		
S1			S31-2136-05	SLIDE SWITCH (IMPEDANCE)		
S3			S42-2153-05	MULTIPLE PUSH SWITCH (SPEAKER)		
△ S4			S40-1073-05	PUSH SWITCH (POWER)		
D1 -8			1SS133	DIODE		
D29 -32			1SS133	DIODE		
D33 -36			SS566B	DIODE		
D37 ,.38			HZS13N(B2)	ZENER DIODE		

E: Scandinavia & Europe K: USA P: Canada  
 U: PX(Far East, Hawaii) T: England M: Other Areas  
 UE: AAFES(Europe) X: Australia

J: Japan made

S: Singapore made

△ indicates safety critical components.

## PARTS LIST

※ New Parts

Parts without Parts No. are not supplied.

Les articles non mentionnés dans le Parts No. ne sont pas fournis.

Teile ohne Parts No. werden nicht geliefert.

Ref. No. 参照番号	Address 位置	New Parts 新	Parts No. 部品番号	Description 部品名 / 規格	Desti- nation 仕 向	Re- marks 備考
D37 ,38 D39 ,40 D41 D42 ,43 D42 ,43			RD13ES(B2) 1SS133 S5S66B HZS20N(B) RD20ES(B)	ZENER DIODE DIODE DIODE ZENER DIODE ZENER DIODE		
△ D44 D45 D45 D46 IC1			RBV-402LFA HZS10N(B) RD10ES(B) 1SS133 LC7818	DIODE ZENER DIODE ZENER DIODE DIODE IC(ELECTRO CONTROL SWITCH (2H)		
IC2 ,3 IC4 Q1 -4 Q5 -8 Q5 -8			UPC4570C-A UPC1237HA 2SC1845(F,E) 2SA733(A)(Q,P) 2SA933S(Q,R)	IC(OP AMP X2) IC(POWER AMP) TRANSISTOR TRANSISTOR TRANSISTOR		
Q9 -14 Q15 ,16 Q17 ,18 Q19 ,20 Q21 ,22			2SC2632(Q,R,S) 2SA1124(Q,R,S) 2SA1284(D,E) 2SC3244(D,E) 2SA733(A)(Q,P)	TRANSISTOR TRANSISTOR TRANSISTOR TRANSISTOR TRANSISTOR		
Q21 ,22 Q23 -26 Q27 Q27 Q28 ,29			2SA933S(Q,R) 2SC2878(B) 2SA733(A)(Q,P) 2SA933S(Q,R) 2SC1740S(Q,R)	TRANSISTOR TRANSISTOR TRANSISTOR TRANSISTOR TRANSISTOR		
Q28 ,29 Q30 Q30 Q31 Q32			2SC945(A)(Q,P) 2SA733(A)(Q,P) 2SA933S(Q,R) 2SD882 2SA954(L,K)	TRANSISTOR TRANSISTOR TRANSISTOR TRANSISTOR TRANSISTOR		
Q39			DTA124EN	DIGITAL TRANSISTOR		
<b>TONE UNIT (X11-262X-XX) Japan made:2-70 Singapore made:2-72</b>						
D1 -7 C1 ,2 C3 ,4 C5 ,6 C5 ,6 C7 ,8			B30-1223-05 CF92FV1H473J CF92FV1H333J CE04KW1H010M CE04LW1H010M CC45FSL1H221J	LED(LN21CPH(V)-C) MF 0.047UF J MF 0.033UF J ELECTRO 1.0UF 50WV ELECTRO 1.0UF 50WV CERAMIC 220PF J		J S
C9 ,10 C9 ,10 C11 ,12 C13 -16 C17 -22			CE04KW1E470M CE04LW1E470M CC45FSL1H181J CF92FV1H334J CE04KW1V100M	ELECTRO 47UF 25WV ELECTRO 47UF 25WV CERAMIC 180PF J MF 0.33UF J ELECTRO 10UF 35WV		J S
C17 -22 C23 -26 C27 ,28			CE04LW1V100M CF92FV1H223J CK45FB1H471K	ELECTRO 10UF 35WV MF 0.022UF J CERAMIC 470PF K		S
VR1 VR2 VR3 ,4			RO6-5176-05 RO1-5056-05 RO6-3061-05	POTENTIOMETER (VOLUME) POTENTIOMETER (BALANCE) POTENTIOMETER (TONE)		
S1 S2 S3 S4 -8			S40-4074-05 S40-2351-05 S40-4074-05 S40-1064-05	PUSH SWITCH (CD DIRECT) PUSH SWITCH (MUTE) PUSH SWITCH (LOUDNESS) PUSH SWITCH (SELECTOR)		

E: Scandinavia & Europe K: USA P: Canada  
U: PX(Far East, Hawaii) T: England M: Other Areas  
UE: AAFES(Europe) X: Australia

J: Japan made

S: Singapore made

△ indicates safety critical components.

## PARTS LIST

× New Parts

Parts without Parts No. are not supplied.

Les articles non mentionnés dans le Parts No. ne sont pas fournis.

Teile ohne Parts No. werden nicht geliefert.

Ref. No. 参照番号	Address 位置	New Parts 新	Parts No. 部品番号	Description 部品名 / 規格	Desti- nation 仕向	Re- marks 備考
IC1			UIC4570C-A	IC (OP AMP X2)		

E: Scandinavia & Europe

K: USA

P: Canada

J: Japan made

U: PX (Far East, Hawaii)

T: England

M: Other Areas

S: Singapore made

UE: AAFES (Europe)

X: Australia

⚠ indicates safety critical components.

## SPECIFICATIONS

### Audio Section Rated Power Output

55 watts per channel minimum RMS, both channels driven, at 8 ohms from 20 Hz to 20,000 Hz with no more than 0.03% total harmonic distortion.

#### Maximum continuous output power

(IEC) from 63 Hz to 12,500 Hz 0.7% T.H.D.

at 8 ohms ..... 65 W + 65 W

(DIN) 1,000 Hz at 8 ohms ..... 65 W + 65 W

#### Total Harmonic Distortion

(20 Hz to 20,000 Hz) ..... 0.03% at rated power into 8 ohms

(1 kHz) ..... 0.004% at 1/2 rated power into 8 ohms

Intermodulation Distortion (60 Hz:7 kHz=4:1) ..... 0.03% at rated power into 8 ohms

Damping Factor ..... 40 (50 Hz at 8 ohms)

Power Bandwidth ..... 10 Hz to 100 kHz at 0.2% T.H.D. 8 ohms

Frequency Response ..... 10 Hz to 60 kHz, +0 dB, -3 dB

#### Input Sensitivity/Impedance

Phono ..... 2.5 mV/47 k ohms

Tuner, Tape play, CD/AUX ..... 150 mV/27 k ohms

#### Signal-to-Noise Ratio (IHF-A)

Phono ..... 75 dB for 2.5 mV input

Tuner, Tape play, CD/AUX ..... 100 dB for 150 mV input

Phono Maximum Input Level ..... 100 mV, T.H.D. 0.05% at 1 kHz

#### Output Level/Impedance

Tape REC (Pin) ..... 150 mV/330 ohms

Phono Frequency Response ..... RIAA standard curve ±0.5 dB (20 Hz to 20,000 Hz)

Loudness Control ..... +8 dB at 100 Hz (at -30 dB VOLUME level)

#### General

Power Consumption ..... 150 W

Dimensions ..... W: 440 mm

H: 133 mm

D: 275 mm

Weight (Net) ..... 6.4 kg (14.1 lb)

Kenwood follows a policy of continuous advancements in development. For this reason specifications may be changed without notice.

Kenwood poursuit une politique de progrès constants en ce qui concerne le développement. Pour cette raison, les spécifications sont sujettes à modifications sans préavis.

Kenwood strebt ständige, Verbesserungen in der Entwicklung an. Daher bleiben Änderungen der technischen Daten jederzeit vorbehalten.

#### Note:

Component and circuitry are subject to modification to insure best operation under differing local conditions. This manual is based on, the Europe (E) standard, and provides information on regional circuit modification through use of alternate schematic diagrams, and information on regional component variations through use of parts list.

## KENWOOD CORPORATION

Shionogi Shibuya Building, 17-5, 2-chome Shibuya, Shibuya-ku, Tokyo 150, Japan

### KENWOOD U.S.A. CORPORATION

2201 East Dominguez Street, Long Beach, CA 90810;  
550 Clark Drive, Mount Olive, NJ 07828, U.S.A.

### KENWOOD ELECTRONICS CANADA INC.

P.O. Box 1075 959 Gana Court, Mississauga, Ontario, Canada L4T 4C2

### KENWOOD ELECTRONICS BENELUX N.V.

Mechelsesteenweg 418 B-1930 Zaventem, Belgium

### KENWOOD ELECTRONICS DEUTSCHLAND GMBH

Rembrucker-Str. 15, 6056 Heusenstamm, West Germany

### TRIO-KENWOOD FRANCE S.A.

Hi-Fi-VIDEO-CAR Hi-Fi  
13, Boulevard Ney, 75018 Paris, France

### TRIO-KENWOOD U.K. LTD.

17 Bristol Road, The Metropolitan Centre, Greenford, Middx. UB6 8UP England

### KENWOOD ELECTRONICS AUSTRALIA PTY. LTD.

4E Woodcock Place, Lane Cove, N.S.W. 2066, Australia

### KENWOOD & LEE ELECTRONICS, LTD.

Wang Kee Building, 4th Floor, 34-37, Connaught Road, Central, Hong Kong