

**KENWOOD**  
HI/FI STEREO COMPONENTS

# SERVICE MANUAL

## KA-405 (KA-4055)

An item of adjustment is written in three languages — English, French and German.

*Un article sur réglages est écrit en trois langues, Anglais, Français et Allemand.*

Ein Artikel der Abgleich wird auf drei Sprachen, Englische, Französisch und Deutsch geschrieben.

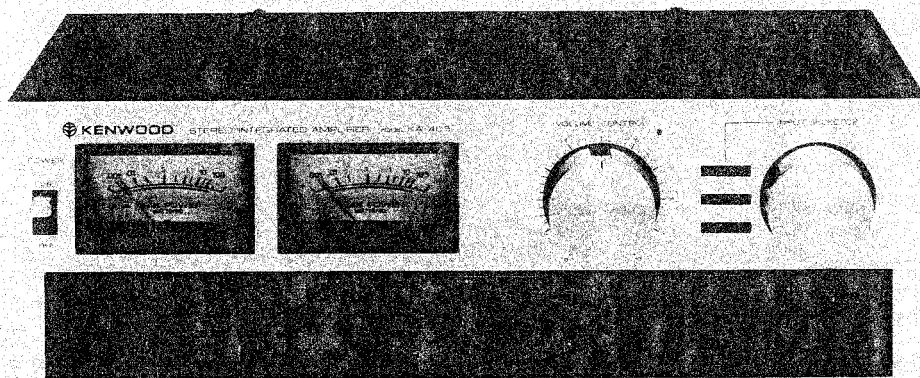

**STEREO INTEGRATED AMPLIFIER**

## CONTENTS

EXTERNAL VIEW .....	3
INTERNAL VIEW .....	4
BLOCK & LEVEL DIAGRAM .....	4
DISASSEMBLY FOR REPAIR .....	5
EXPLODED VIEW .....	6
EXPLODED VIEW PARTS LIST .....	7
<b>ADJUSTMENT</b>	
ADJUSTMENT .....	8
RÉGLAGES .....	8
ABGLEICH .....	8
SEMICONDUCTOR SUBSTITUTIONS .....	9
PC BOARD .....	9
SCHEMATIC DIAGRAM .....	11
SPECIFICATIONS .....	11
PARTS LIST .....	12

**Note:**

Component and circuitry are subject to modification to insure best operation under differing local conditions. This manual is based on the U.S. (K) standard, and provides information on regional circuit modification through use of alternate schematic diagrams, and information on regional component variations through use of parts list.

Region	Code
U.S.A .....	K
Canada .....	P
PX .....	U
Australia .....	X
Europe & Scandinavia (KA-405) .....	E1
Europe & Scandinavia (KA-4055) .....	E2
England (KA-405) .....	T1
England (KA-4055) .....	T2
Other Areas (KA-405) .....	M1
Other Areas (KA-4055) .....	M2
Audio Club (KA-4055) .....	H

**EXTERNAL VIEW**

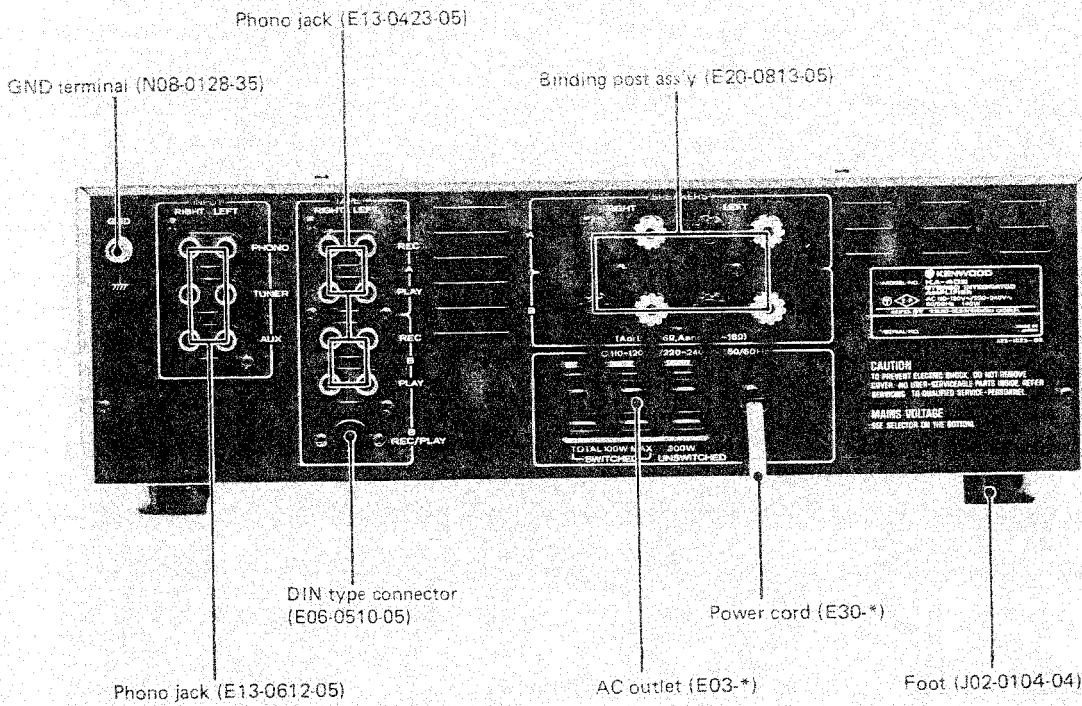
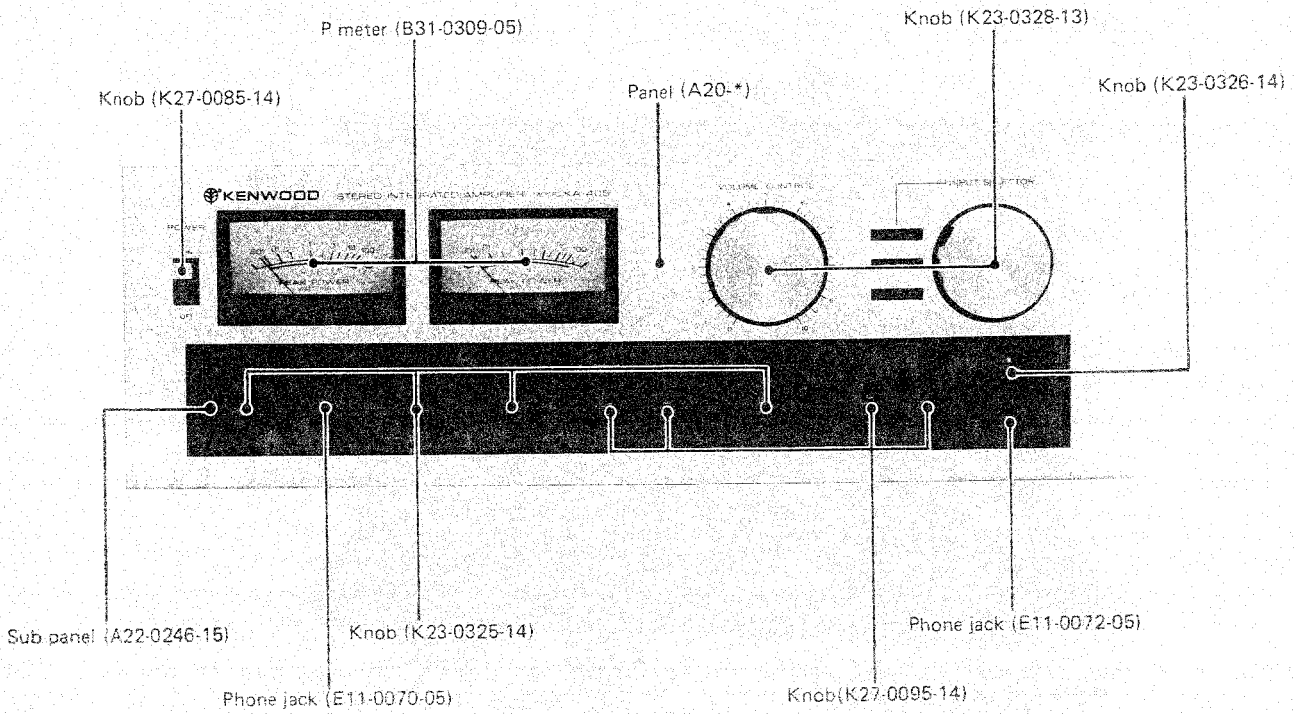

\* Refer to Parts List

**INTERNAL VIEW/BLOCK & LEVEL DIAGRAM**

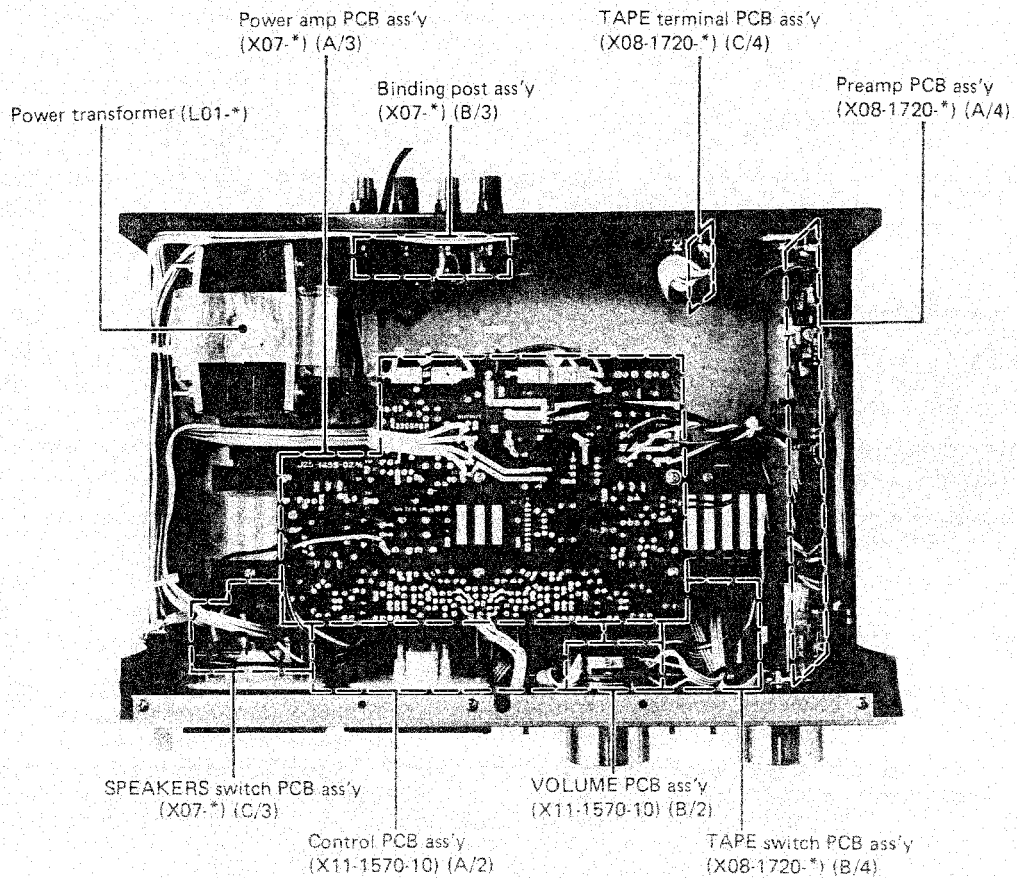

\* Refer to Parts List

**BLOCK & LEVEL DIAGRAM**

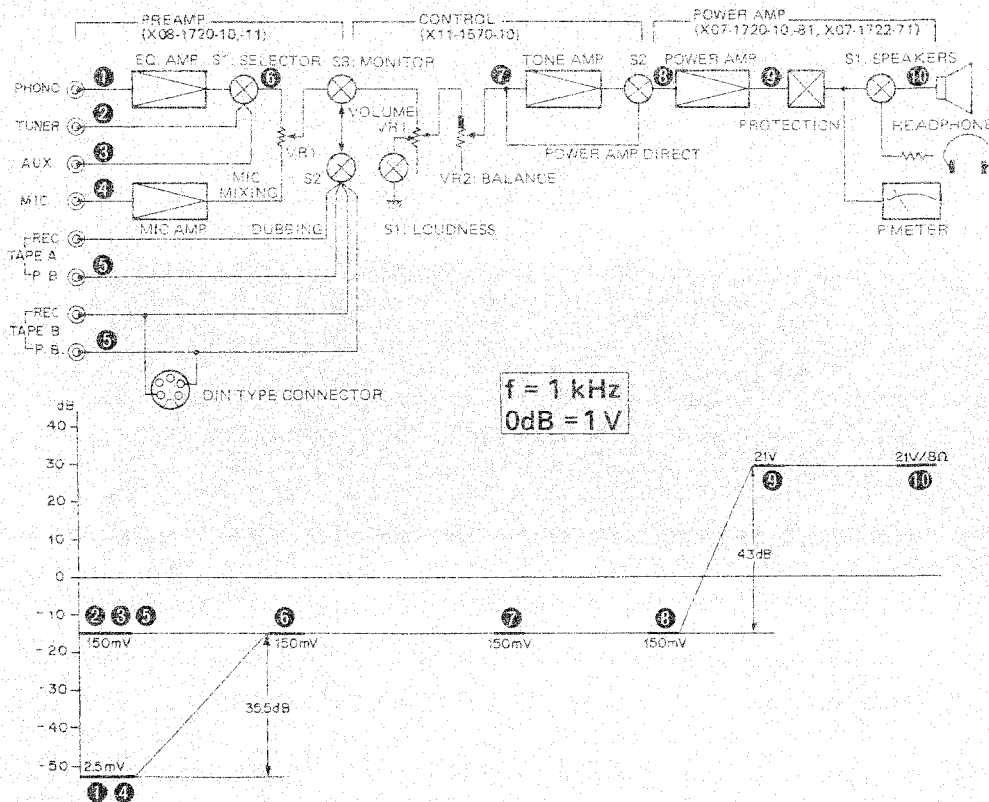

## DISASSEMBLY FOR REPAIR

When removing the case, refer to EXPLODED VIEW.

### POWER AMP

1. Remove the screws fixing the heat sinks to the chassis from bottom plate. Shown as ①.
2. Turn the power amp block (including heat sink) as figure.

### CONTROL AND Switch PCB ass'y

1. Remove the screws fixing the PCB to the chassis. Shown as ②.
2. Pull out the knobs (SELECTOR and MIC MIXING) and remove the nut of INPUT SELECTOR. Shown as ③.
3. Remove the screws fixing panel to chassis. Shown as ④ and ⑤.
4. Turn the panel ass'y up.

### Remove P meter

Push the meter with expanding the projection of sub panel.

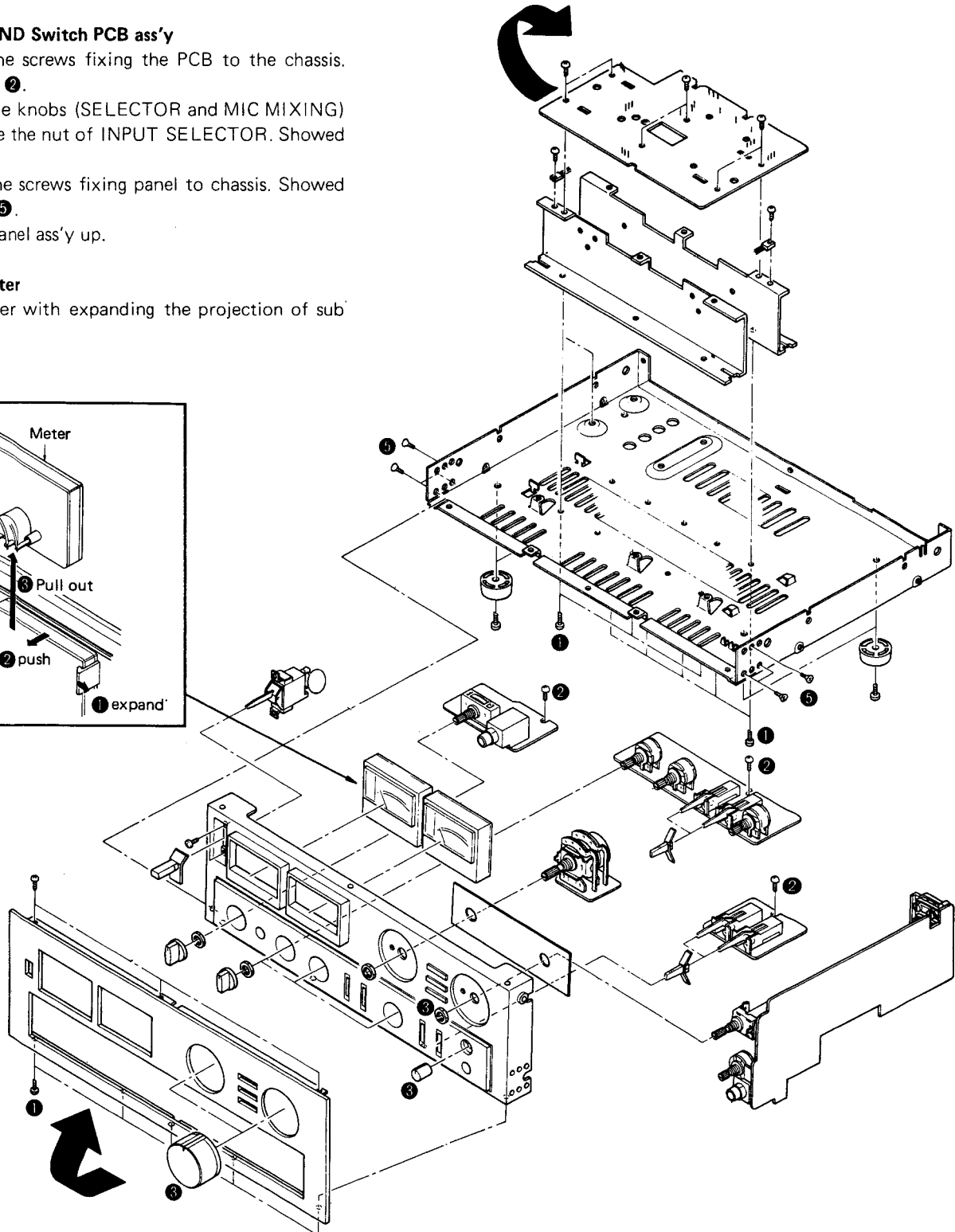
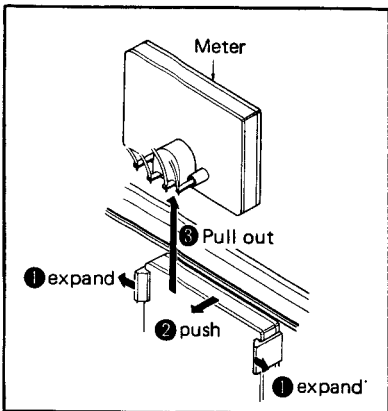



## EXPLODED VIEW PARTS LIST

\*: Refer to Parts List. ☆: New Parts.

Fig. No.	Parts No.	Description	Remarks
1	A01-0355-03	Case	☆ 1B
2	—	Chassis	2B
3	A20-*	Panel	☆ 3A
4	A22-0246-15	Sub panel	3A
5	—	Rear panel	2B
6	B31-0309-05	P meter	☆ 3A
7	E03-*	AC outlet	2B
8	E30-*	Power cord	1B
9	—	Reinforce	3A
10	J02-0049-14	Foot	2B
11	J41-*	Power cord bushing	2B
12	K23-0328-13	Knob (VOLUME, SELECTOR)	☆ 3A
13	K23-0325-14	Knob (TONE, BALANCE, SPEAKERS)	☆ 3A
14	K23-0326-14	Knob (MIC)	☆ 3A
15	K27-0095-14	Knob (Lever)	☆ 3B
16	K27-0085-14	Knob (POWER)	3A
17	L01-*	Power transformer	☆ 1A
18	S33-*	Lever switch (POWER)	2A
19	*	Ceramic cap.	2A, 2B
20	N08-0128-35	GND terminal screw	2B
21	E06-0510-05	DIN type connector	2B
22	E13-0612-05	Phono jack (6P)	3B
23	X08-1720-*	Preamp PCB ass'y	☆ 3B
24	X11-1570-10	Control PCB ass'y	☆ 3B
25	X07-*	Power amp PCB ass'y	☆ 1B, 2A
26	—	Heat sink	2A
27	V11-5100-40	Varistor STV-4H (G)	1A, 2B
28	E20-0813-05	Binding post ass'y	2B
29	E13-0423-05	Phono jack (TAPE)	☆ 2B
30	S29-1120-05	Rotary-slide switch (SPEAKERS)	☆ 3A
31	E11-0072-05	Phone jack (HEADPHONE)	☆ 3A
32	R06-3019-05	Potentiometer 20 k $\Omega$ (B) (TONE)	☆ 3B
33	S33-2055-05	Lever switch (LOUDNESS, POWER AMP DIRECT)	☆ 3B
34	R06-5042-05	Potentiometer 200 k $\Omega$ (MN) (BALANCE)	☆ 3B
35	R08-5043-05	Potentiometer 100 k $\Omega$ (B) (VOLUME)	☆ 3B
36	S33-4024-05	Lever switch (DUBBING)	☆ 3B
37	S33-2054-05	Lever switch (TAPE MONITOR)	☆ 3B
38	S29-1121-05	Rotary-slide switch (SELECTOR)	☆ 3B
39	R06-4040-05	Potentiometer 50 k $\Omega$ (B) (MIC)	3B
40	E11-0070-05	Phone jack (MIC)	3B
41	S31-*	Slide switch (VOLTAGE SELECTOR)	☆ 2B



## ADJUSTMENT/RÉGLAGES/ABGLEICH

### POWER METER LEVEL ADJUSTMENT

1. Connect an AG set to 1 kHz and dummy load to Aux jack and speaker terminal respectively.
2. Connect an AC voltmeter across the dummy load.
3. Adjust the trimming pot VR3 (VR4), when the AC voltmeter indicating,  $21\text{ V}/8\ \Omega$ , for 50 W reading of power meter.

### RÉGLAGE DU VU MÈTRE

1. Relier un AG (générateur de signaux audio) sur les prises Aux et une fausse charge (Resistance) sur les bornes de haut-parleur.
2. Relier un voltmètre aux deux extrémités de la résistance (ou aux borne de sortie + et -).
3. Régler le potentiomètre ajustable VR3 (VR4) en sorte que le VU mètre indique 50 W lorsque le voltmètre indique  $21\text{ V}/8\ \Omega$ .

### PEGELEINSTELLUNG DES STROMMESSERS (POWER METER)

1. Einen AG (NF-Signalgenerator) an die AUX-Buchsen und eine künstliche Last ( $8\ \Omega$ , 100 W oder mehr) an die Lautsprecher-Anschlüsse anschließen.
2. Einen Wechselstrom-Voltmeter über die künstliche Last anschliessen.
3. Den AG auf 1 kHz einstellen.
4. Die Lautstärke regler (oder den AG-Ausgang) so einstellen, daß der Voltmeter 21 V anzeigt.
5. Das Trimm-Potentiometer VR3 (VR4) so einstellen, das der Strommesser 50 W anzeigt.

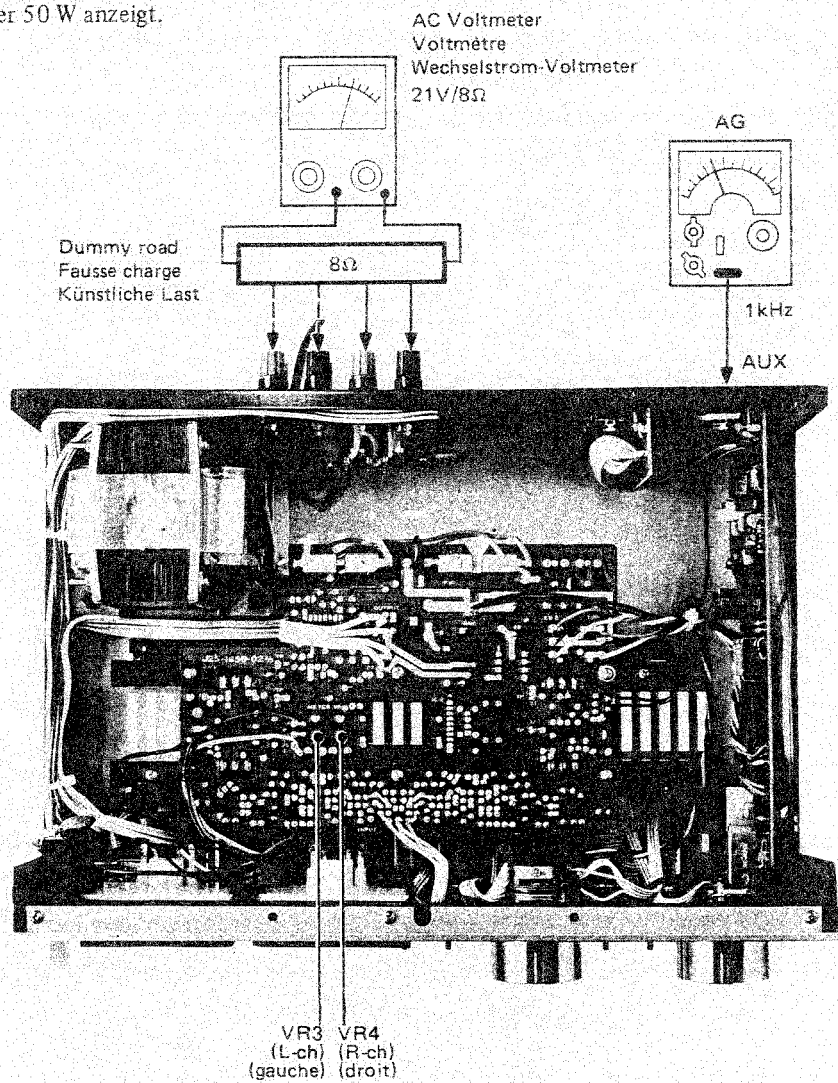



PC BOARD

▼POWER AMP PCB(X07-1720-10)  
Foil Side View

Q1~4	: 2SA872(E)	IC1	: HA12002
Q5~8	: 2SA733A(Q,P)	IC2	: TA7318P
Q9,10,23,24	: 2SC945(Q,P)	D1,2,15,16	: WZ-140
Q11,12	: 2SC1775	D5,6	: STV-4H(G)
	or 2SC1845(E,U)	D7,8	: 1S2076
Q13,14	: 2SC1904(B,V)		or 1S1555
Q15,16	: 2SC1567(Q,R,S)	D9,10	: 1S2076A
Q17,18	: 2SA794(Q,R,S)	D11~14	: GP25D
Q19,20	: 2SC2580×1		or U05C(S)
Q21,22	: 2SA1105×1		

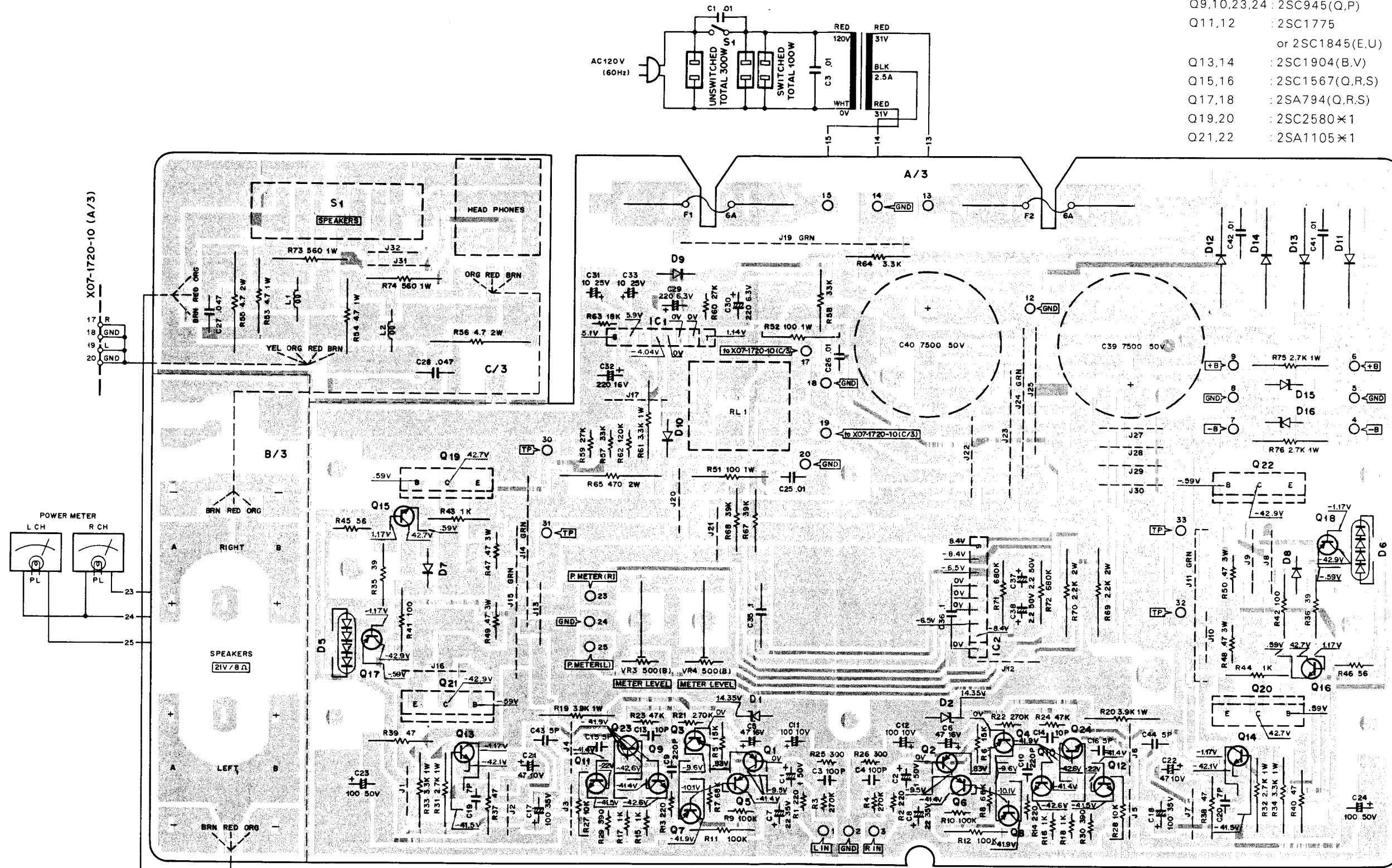



PC BOARD

▼PREAMP PCB (X08-1720-10) (A/4, D/4)  
Foil Side View

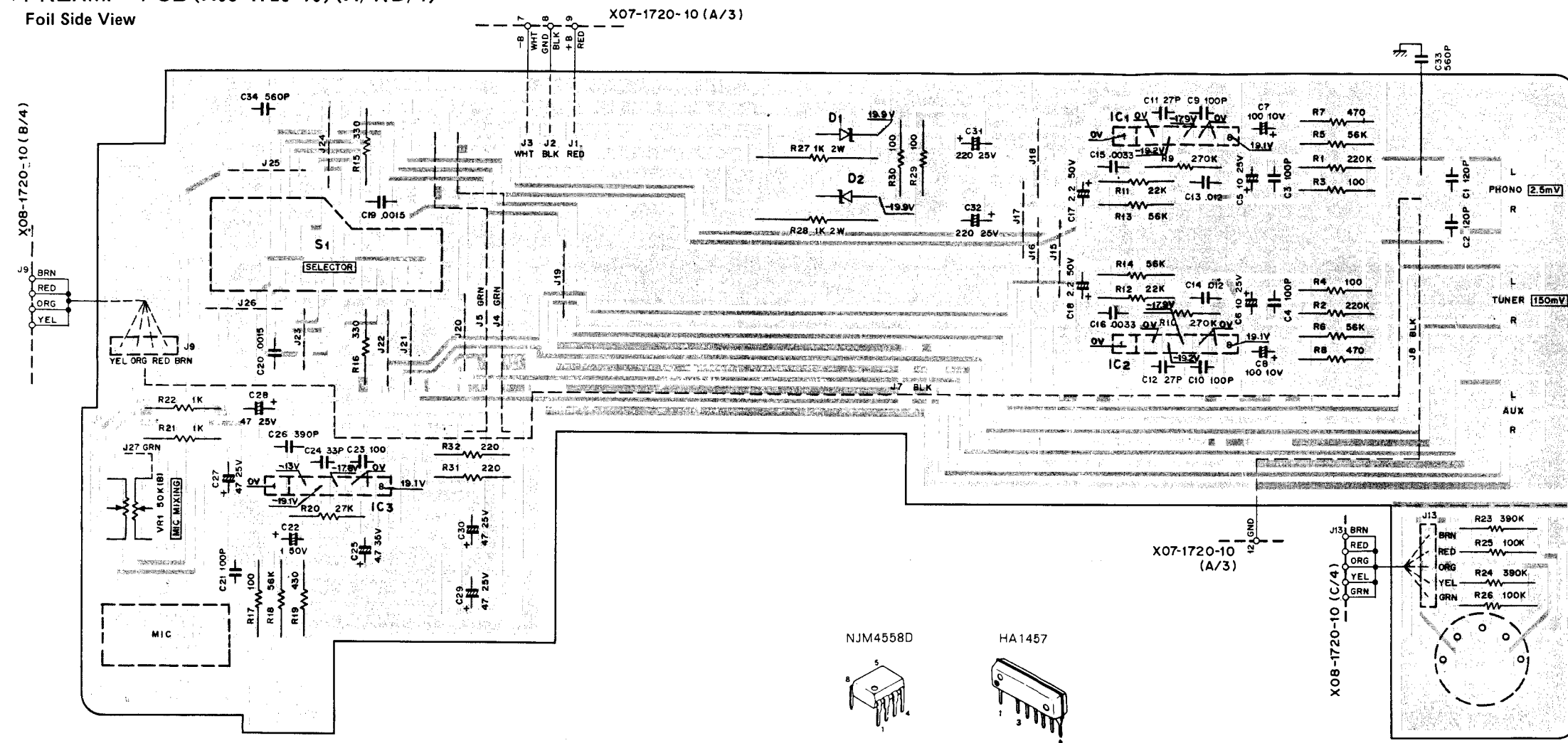

▼PREAMP PCB (X08-1720-10)  
Components Side View (B/4, C/4)

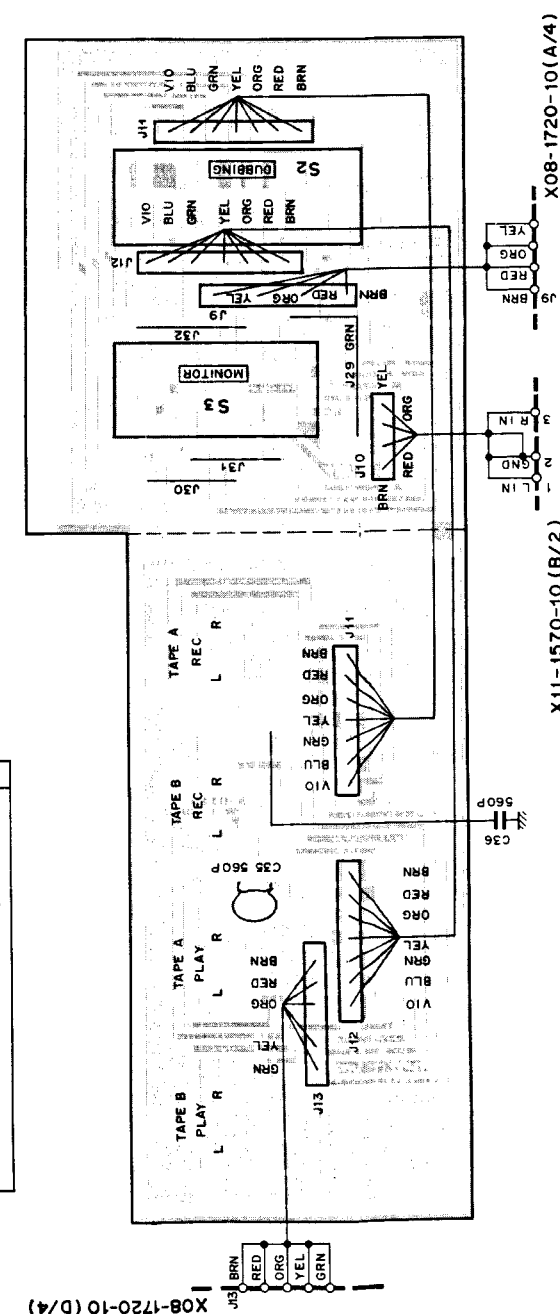

▼CONTROL PCB (X11-1570-10) Components Side View

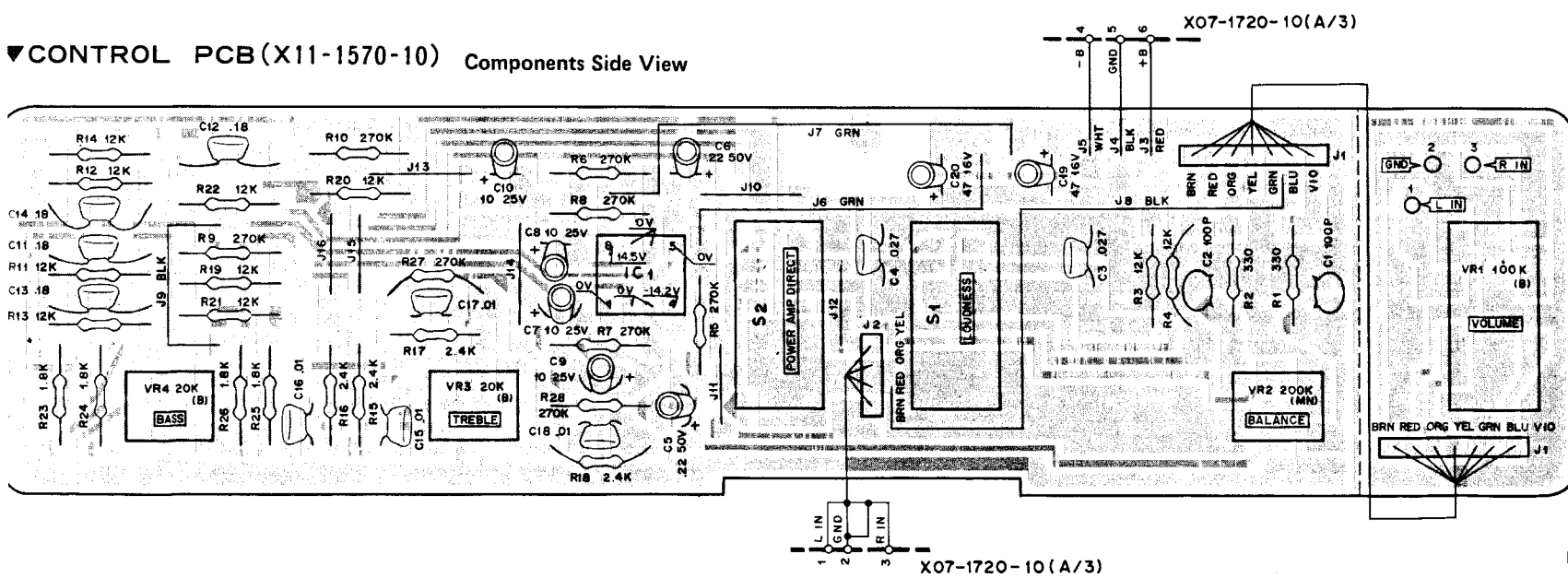

SEMICONDUCTOR SUBSTITUTIONS

SEMICONDUCTOR	SUBSTITUTIONS
X07- 2SA733A(Q,P) 2SA794(Q,R,S) 2SA872(E) 2SC2580×1 2SC945(Q,P) 2SC1567(Q,R,S) 2SC1775 2SC1904(B,V) 2SA1105×1 HA-12002 TA-7318P	2SA640, 2SA750, 2SA872 2SA794A 2SA640, 2SA750 2SC1222, 2SC1400, 2SC1775 2SC1567A 2SC1845(E,U) 2SC1885
X08-1720- HA-1457	-
X11-1570-10 NJM 4558D(A)	RC4558T(A), RC4559D(A) RC4559T(A)

IC1: NJM4558D(A)



PC BOARD

PREAMP PCB (X08-1720-10) (A/4, D/4)  
Foils Side View

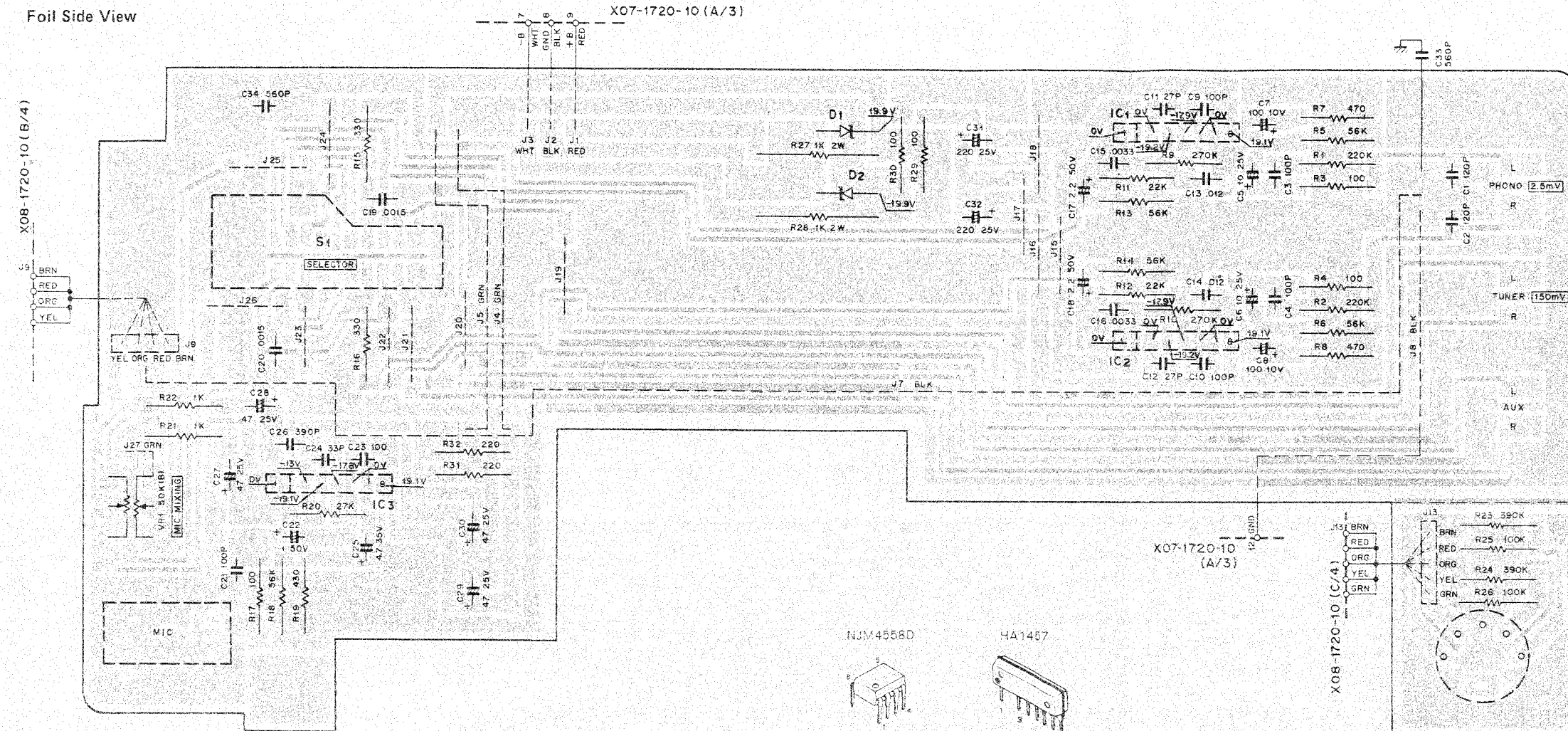

IC1-3 HA1457  
D1,2 C2-200

PREAMP PCB (X08-1720-10)  
Components Side View (B/4, C/4)

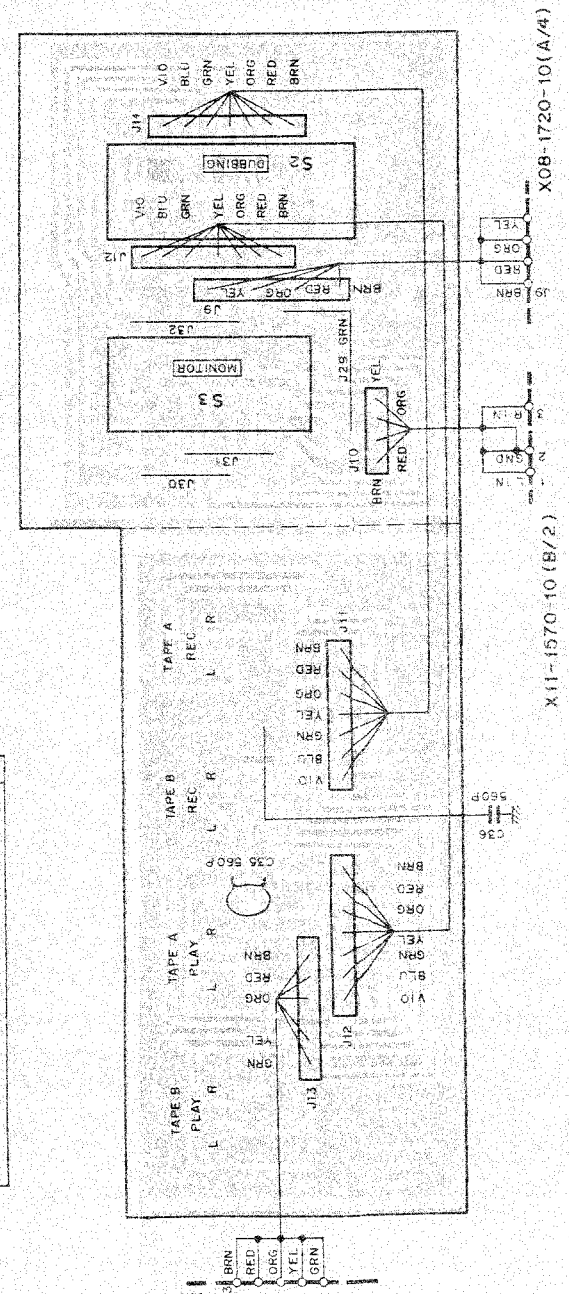

CONTROL PCB (X11-1570-10) Components Side View

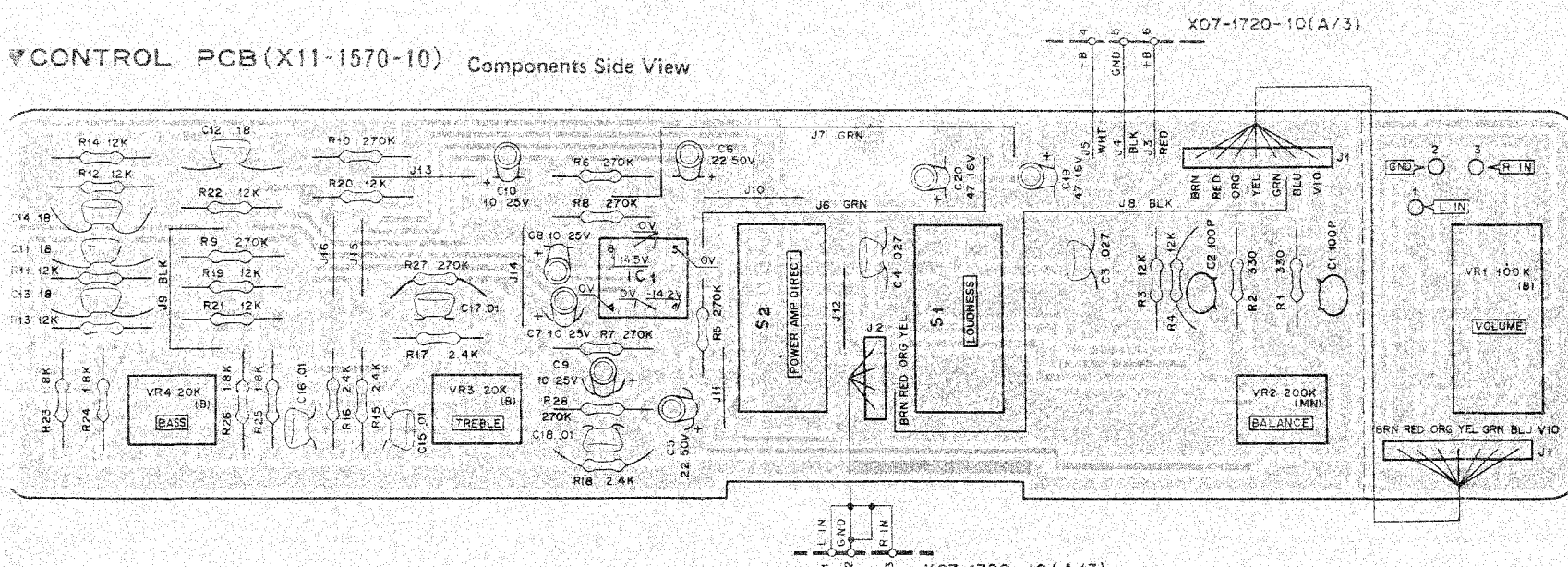

SEMICONDUCTOR SUBSTITUTIONS

SEMICONDUCTOR	SUBSTITUTIONS
X07	
2SA733A(Q,P)	2SA640, 2SA750, 2SA872
2SA794(Q,R,S)	2SA794A
2SA872(E)	2SA640, 2SA750
2SC2580 x 1	-
2SC945(Q,P)	2SC1222, 2SC1400, 2SC1775
2SC1567(Q,R,S)	2SC1567A
2SC1775	2SC1845(E,U)
2SC1904(B,V)	2SC1885
2SA1105 x 1	-
HA-12002	-
TA-7318P	-
X08-1720- HA-1457	-
X11-1570-10 NJM 4558D(A)	RC4558T(A), RC4559D(A), RC4559T(A)

IC1 NJM4558D(A)

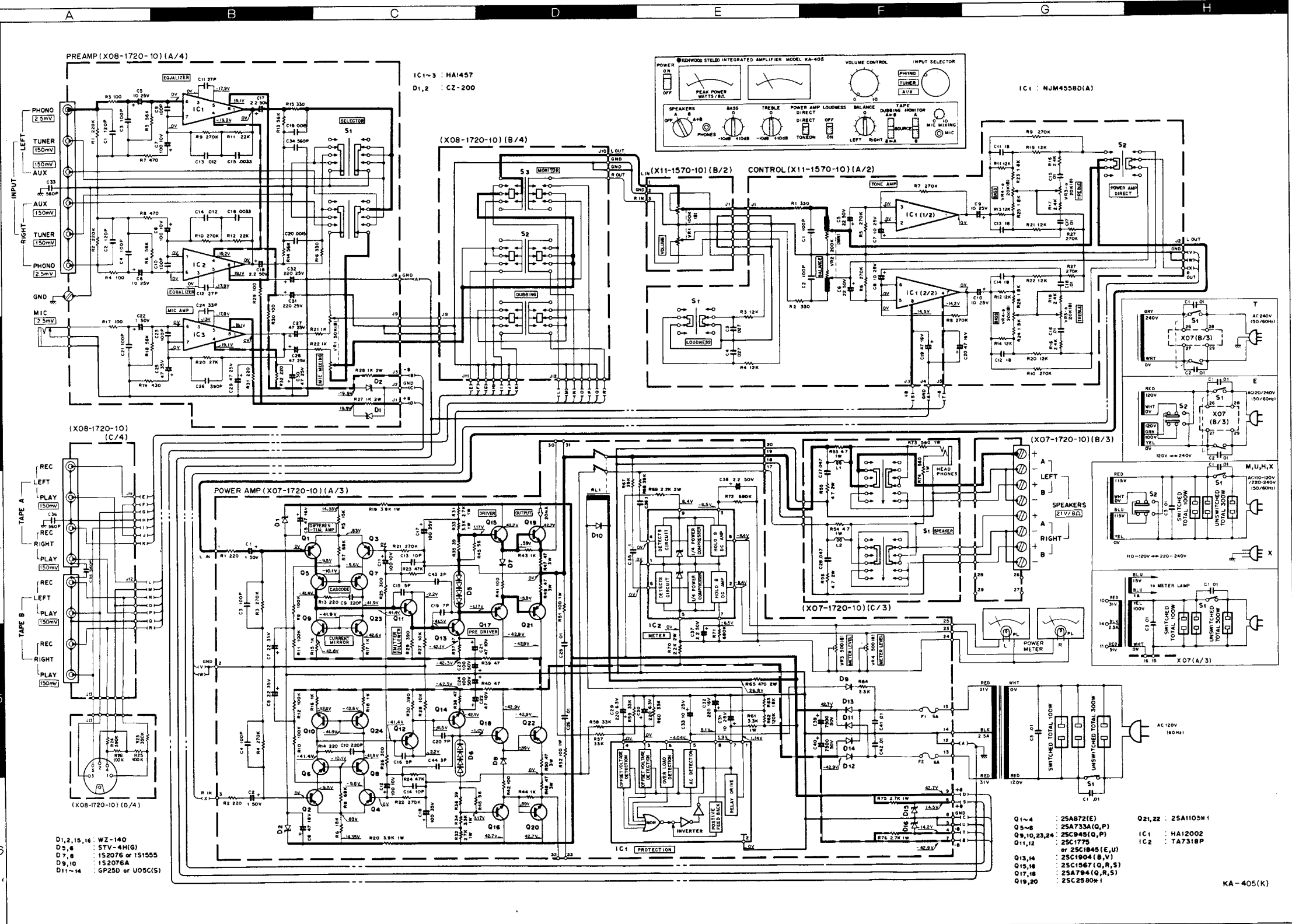
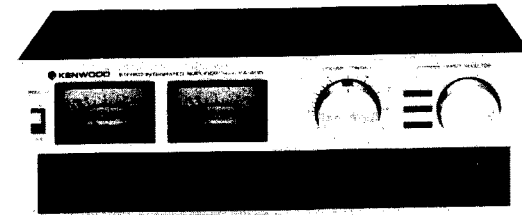

**POWER OUTPUT**  
55 watts\* per channel minimum RMS, both channels driven, at 8 ohms from 20 Hz to 20,000 Hz with no more than 0.05% total harmonic distortion.

Both Channels Driven	60 + 60 watts 8 ohms at 1,000 Hz 70 + 70 watts 4 ohms at 1,000 Hz
Total Harmonic Distortion	
AUX input to SPEAKER output (20 Hz - 20 kHz)	0.05% at rated power into 8 ohms
(1 kHz)	0.006% at rated power into 8 ohms
PHONO input to SPEAKER output (20 Hz - 20 kHz)	0.03% at 1/2 rated power into 8 ohms
(1 kHz)	0.05% at rated power with VOLUME - 20 dB
Intermodulation Distortion (60 Hz - 7 kHz = 4 : 1)	0.008% at rated power into 8 ohms
Damping Factor	45, 20 Hz - 20,000 Hz into 8 ohms
Transient Response	
Rise Time	1.4 μs
Slew Rate	± 70 V/μs
Power Bandwidth	5 Hz to 40,000 Hz at 0.05% T.H.D.
Frequency Response	2 Hz to 250 kHz, -3 dB
Speaker Impedance	Accept 4 ohms to 16 ohms
Input Sensitivity/Impedance	
Phono	2.5 mV/50 kohms
Tuner	150 mV/30 kohms
AUX	150 mV/30 kohms
Tape	150 mV/30 kohms
Mic	2.5 mV/50 kohms
Signal-to-Noise Ratio (IHF, A)	
Phono	77 dB for 2.5 mV input 83 dB for 5.0 mV input 89 dB for 10 mV input
Tuner, AUX, Tape	105 dB for 150 mV input
Mic	73 dB for 2.5 mV input
Maximum Input Level for Phono	210 mV (RMS), T.H.D. 0.05% at 1,000 Hz
Output Level/Impedance	
Tape REC (Pin)	150 mV/220 ohms
(DIN)	30 mV/75 kohms
Frequency Response for Phono	RIAA standard curve ± 0.4 dB (30 Hz to 15,000 Hz)
Tone Control	
Bass	± 10 dB at 100 Hz
Treble	± 10 dB at 10,000 Hz
Loudness Control (at -30 dB VOLUME Level)	+ 8 dB at 100 Hz
<b>GENERAL</b>	
Power Consumption	400 watts at full power
A.C. Outlet	Switched 2, Unswitched 1
Dimensions	W 400 mm (15-8/16") H 139 mm (5-15/32") D 296 mm (11-21/32")
Weight (Net)	7.6 kg (16.8 lbs)

Measured pursuant to Federal Trade Commission's Trade Regulation rule on Power Output Claims for Amplifier in U.S.A.

**Note:** Kenwood follows a policy of continuous advancements in development. For this reason specifications may be changed without notice.

- Q1-4 : 2SA872(E)
- Q5-8 : 2SA733A(O,P)
- Q9,10,23,24 : 2SC945(O,P)
- Q11,12 : 2SC1778
- Q13,14 : 2SC1904(B,V)
- Q15,16 : 2SC1567(O,R,S)
- Q17,18 : 2SA794(O,R,S)
- Q19,20 : 2SC2580K-1
- Q21,22 : 2SA1105K-1
- IC1 : HA1457
- IC2 : TA7318P

- 2SA640
- 2SA733A
- 2SA750
- 2SA872
- 2SC0945
- 2SC1222
- 2SC1845
- 2SC1885
- 2SA794
- 2SA794A
- 2SC1567
- 2SC1567A
- 2SC1904
- 2SA1105K-1
- 2SC2580K-1
- RC4559D
- NJM4558D
- TA7318P
- HA1457
- HA12002
- RC4558T
- RC4559T

DC voltage measured with 20 kΩ/V VOM under no signal.

PARTS LIST

☆: New parts  
 FP: Flame proof  
 RD: Carbon film resistor  
 RC: Carbon composition resistor  
 RW: Wire wound power resistor  
 RN: Metal film resistor  
 RS: Metal oxide film resistor

TOTAL

Ref. No.	Parts No.	Description	Re- marks
-	A01-0355-03	Case	☆
-	A20-1441-02	Panel K,P,U,M1,X,E1	☆
-	A20-1442-02	Panel (black) H,M2,E2	☆
-	A20-1443-02	Panel T1	☆
-	A20-1445-02	Panel (black) T2	☆
-	B30-0194-05	Lamp x 2	☆
-	B31-0309-05	P meter x 2	☆
-	B46-0055-20	Warranty card P	
-	B46-0060-00	Warranty card T1,T2	
-	B46-0061-20	Warranty card K	
-	B46-0062-20	Warranty card U,H	
-	B46-0063-00	Warranty card U	
-	B46-0064-00	Warranty card X	
-	B50-1873-00	Instruction manual K,U	☆
-	B50-1874-00	Instruction manual P,M1,X	☆
-	B50-1875-00	Instruction manual H	☆
-	B50-1876-00	Instruction manual E1	☆
-	B50-1877-00	Instruction manual T1	☆
-	B50-1889-00	Instruction manual M2	☆
-	B50-1890-00	Instruction manual E2	☆
-	B50-1891-00	Instruction manual T2	☆
-	B59-0018-00	KENWOOD service stations'list U	
C1, 2	C54-3310-39	Ceramic 0.01μF 2kV E1,E2,T1,T2	
C1, 2	C90-0145-05	Metal film 0.01μF AC 125V or K	
C1, 2	C91-0001-05	Metal film 0.01μF AC 125V	
C1, 2	C91-0072-05	Metal film 0.01μF AC 125V P	☆
C1, 2	C91-0023-05	Ceramic 0.01μF AC 250V	
-	E03-0007-05	AC outlet K,U,M1,H,M2,X	
-	E03-0009-05	AC outlet P	
-	E30-0181-05	Power cord K,P	
-	E30-0185-05	Power cord X	
-	E30-0545-05	Power cord U,M1,M2	
-	E30-0580-05	Power cord H,E1,E2	
-	E30-0602-05	Power cord T1,T2	
-	H01-3004-04	Carton box K,U,M1	☆
-	H01-3005-04	Carton box P	☆
-	H01-3006-04	Carton box T1	☆
-	H01-3008-04	Carton box H,M2,E2	☆
-	H01-3009-04	Carton box X,E1	☆
-	H01-3010-04	Carton box T2	☆
-	H10-1497-12	Polystyrene foamed fixture	
-	H10-1498-12	Polystyrene foamed fixture	
-	H12-0071-04	Buffer fixture H,M2,X,E1,E2	
-	H20-0417-04	Protection cover M1,M2	
-	H20-0451-04	Protection cover K,P,U,H,X,E1,T1,E2,T2	
-	H25-0078-04	Protection cover	
-	J02-0104-04	Foot x 4	☆
-	J41-0024-15	Power cord bushing X,T1,T2	
-	J41-0033-05	Power cord bushing H,E1,E2	
-	J41-0034-05	Power cord bushing K,P,U,M1,M2	
-	K23-0325-14	Knob (φ17) x 4	☆
-	K23-0326-14	Knob (φ12) MIC MIXING	☆
-	K23-0328-13	Knob (φ44) x 2 VOLUME, SELECTOR	☆
-	K27-0085-14	Knob (lever) POWER	
-	K27-0095-14	Knob (lever) x 4	☆
-	L01-1781-05	Power transformer K	☆

Ref. No.	Parts No.	Description	Re- marks
-	L01-1782-05	Power transformer T1,T2	☆
-	L01-1785-05	Power transformer U,H,X,M1,M2	☆
-	L01-1786-05	Power transformer E1,E2	☆
-	L01-1787-05	Power transformer P	☆
-	N08-0128-35	GND terminal screw	
S1	S33-1006-05	Lever switch POWER K,P	
S1	S33-1007-05	Lever switch POWER U,H,X,M1,M2	
S1	S33-2032-05	Lever switch POWER E1,E2,T1,T2	
S2	S31-2053-05	Slide switch VOLTAGE SELECTOR	☆
-	X07-1720-10	Power amp PCB ass'y K,P	☆
-	X07-1720-81	Power amp PCB ass'y U,H,X,M1,M2	☆
-	X07-1722-71	Power amp PCB ass'y E1,E2,T1,T2	☆
-	X08-1720-10	Preamp PCB ass'y K,P,U,H,X,M1,M2,T1,T2	☆
-	X08-1720-11	Preamp PCB ass'y E1,E2	☆
-	X11-1570-10	Control PCB ass'y	☆

POWER AMP PCB ASS'Y (X07-1720-10, -81, X07-1722-71)

Ref. No.	Parts No.	Description	Re- marks
C1, 2	C25-1710-57	Electrolytic 1μF 50WV	
C3, 4	C71-1710-15	Ceramic 100pF ±5%	
C5, 6	C24-1247-61	Electrolytic 47μF 16WV	
C7, 8	C24-6522-61	Electrolytic 22μF 35WV	
C9, 10	C52-1722-16	Ceramic 220pF ±10%	
C11, 12	C24-1010-71	Electrolytic 100μF 10WV	
C13, 14	C71-1710-02	Ceramic 10pF ±0.5pF	
C15, 16	C71-1705-01	Ceramic 5pF ±0.25pF	
C17, 18	C24-6510-71	Electrolytic 100μF 35WV	
C19, 20	C71-1707-02	Ceramic 7pF ±0.5pF	
C21, 22	C24-1047-61	Electrolytic 47μF 10WV	
C23, 24	C24-1710-71	Electrolytic 100μF 50WV	
C25, 26	C46-1710-37	Mylar 0.01μF ±20%	
C27, 28	C46-1747-37	Mylar 0.047μF ±20%	
C29, 30	C24-0822-71	Electrolytic 220μF 6.3WV	
C31	C24-1410-61	Electrolytic 10μF 25WV	
C32	C24-1222-71	Electrolytic 220μF 16WV	
C33	C24-1410-61	Electrolytic 10μF 25WV	
C34	C54-3310-39	Ceramic 0.01μF 2kV -1722-71	
C35, 36	C46-1710-47	Mylar 0.1μF ±20%	
C37, 38	C24-1722-51	Electrolytic 2.2μF 50WV	
C39, 40	C90-0358-05	Electrolytic 7500μF 50WV	
C41, 42	C54-2710-39	Ceramic 0.01μF 500WV	
C43, 44	C71-1705-01	Ceramic 5pF ±0.25pF	
-	E11-0072-05	Phone jack HEADPHONE	☆
-	E20-0813-05	Binding post (speaker)	
F1, 2	F05-6021-05	Fuse 6A -1720-81	
F1, 2	F05-6024-05	Fuse 6A -1720-10	
F1, 2	F05-6322-05	Fuse 6.3A -1722-71	
-	J13-0041-05	Fuse clip x 4 -1720-10,-81	
-	J13-0054-05	Fuse clip x 4 -1722-71	
L1, 2	L39-0085-05	Phase compensation coil	
VR3, 4	R12-0047-05	Trimming potentiometer 500Ω (B) Meter level	
R19, 20	R47-5439-25	FP-RS 3.9kΩ ±5% 1W	
R27, 28	R43-1210-35	FP-RD 10kΩ ±5% 1/4W	
R31, 32	R47-5427-25	FP-RS 2.7kΩ ±5% 1W	

PARTS LIST

Ref. No.	Parts No.	Description	Re- marks
R33, 34	R47-5433-25	FP-RS 3.3kΩ ±5% 1W	
R35, 36	R43-1239-05	FP-RD 39Ω ±5% 1/4W	
R37~40	R43-1247-05	FP-RD 47Ω ±5% 1/4W	
R41, 42	R43-1210-15	FP-RD 100Ω ±5% 1/4W	
R43, 44	R43-1210-25	FP-RD 1kΩ ±5% 1/4W	
R45, 46	R43-1256-05	FP-RD 56Ω ±5% 1/4W	
R47~50	R92-0111-05	Metal plate 0.47Ω 3W	
R51, 52	R47-5410-15	FP-RS 100Ω ±5% 1W	
R53, 54	R47-5447-95	FP-RS 4.7Ω ±5% 1W	
R55, 56	R47-5547-95	FP-RS 4.7Ω ±5% 2W	
R55, 56	R47-5510-05	FP-RS. 10Ω ±5% 2W	-1720-10, -81 -1722-71
R61	R47-5433-25	FP-RS 3.3kΩ ±5% 1W	
R65	R47-5547-15	FP-RS 470Ω ±5% 2W	
R69, 70	R47-5522-25	FP-RS 2.2kΩ ±5% 2W	
R73, 74	R47-5456-15	FP-RS 560Ω ±5% 1W	
R75, 76	R47-5427-25	FP-RS 2.7kΩ ±5% 1W	
R77, 78	R47-5510-05	FP-RS 10Ω ±5% 2W	
S1	S29-1120-05	Rotary-slide switch (SPEAKERS)	
RL1	S51-2038-05	Relay switch	
Q1 ~ 4	V01-0189-05	Transistor 2SA872 (E)	
Q5 ~ 8	V01-0733-40	Transistor 2SA733A (Q, P)	
Q9, 10	V03-0348-05	Transistor 2SC945 (Q, P)	
Q11, 12	V03-1775-00	Transistor 2SC1775 or 2SC1845	
Q13, 14	V03-0460-20	Transistor 2SC1904 (B, V)	
Q15, 16	V03-0507-05	Transistor 2SC1567 (Q, R, S)	
Q17, 18	V01-0221-05	Transistor 2SA794 (Q, R, S)	
Q19, 20	V03-2580-70	Transistor 2SC2580*1	
Q21, 22	V01-1105-11	Transistor 2SA1105*1	
Q23, 24	V03-0348-05	Transistor 2SC945 (Q, P)	
D1, 2	V11-0344-05	Zener diode WZ-140	
D5, 6	V11-5100-40	Varistor STV-4H (G)	
D7, 8	V11-0271-05	Diode 1S2076 or 1S1555	
D9, 10	V11-0273-05	Diode 1S2076A	
D11~14	V11-0465-05	Diode GP25D or U05C (S)	
D15, 16	V11-0344-05	Zener diode WZ-140	
IC1	V30-0291-10	IC, HA12002	
IC2	V30-0292-10	IC TA7318P	

PREAMP PCB ASS'Y (X08-1720-10, -11)

Ref. No.	Parts No.	Description	Re- marks
C1, 2	C71-1712-15	Ceramic 120pF ±5%	
C3, 4	C71-1710-15	Ceramic 100pF ±5%	
C5, 6	C25-1410-67	Electrolytic 10μF 25WV	
C7, 8	C24-1010-71	Electrolytic 100μF 10WV	
C9, 10	C71-1710-15	Ceramic 100pF ±5%	
C11, 12	C71-1727-05	Ceramic 27pF ±5%	
C13, 14	C46-1712-35	Mylar 0.012μF ±5%	
C15, 16	C46-1733-25	Mylar 0.0033μF ±5%	
C17, 18	C24-1722-51	Electrolytic 2.2μF 50WV	
C19, 20	C46-1715-25	Mylar 0.0015μF ±5%	
C21	C71-1710-15	Ceramic 100pF ±5%	
C22	C25-1710-57	Electrolytic 1μF 50WV	
C23	C71-1710-15	Ceramic 100pF ±5%	
C24	C71-1733-05	Ceramic 33pF ±5%	
C25	C24-6547-51	Electrolytic 4.7μF 35WV	
C26	C52-1739-16	Ceramic 390pF ±10%	
C27~30	C24-1447-61	Electrolytic 47μF 25WV	
C31, 32	C24-1422-71	Electrolytic 220μF 25WV	
C33~36	C52-1756-16	Ceramic 560pF ±10%	

Ref. No.	Parts No.	Description	Re- marks
-	E06-0510-05	DIN type connector	
-	E11-0070-05	Phone jack (MIC)	
-	E13-0423-05	4P phono jack x 2 (TAPE)	
-	E13-0612-05	6P phono jack (input)	
VR1	R06-4040-05	Potentiometer 50kΩ (B) x 2 (MIC)	
R27, 28	R47-5510-25	FP-RS 1KΩ ±5% 2W	
S1	S29-1121-05	Rotary-slide switch (SELECTOR)	
S2	S33-4024-05	Lever switch (DUBBING)	
S3	S33-2054-05	Lever switch (TAPE MONITOR)	
IC1 ~ 3	V30-0264-10	IC HA1457	
D1, 2	V11-4104-70	Zener diode CZ-200	

CONTROL PCB ASS'Y (X11-1570-10)

Ref. No.	Parts No.	Description	Re- marks
C1, 2	C71-1710-15	Ceramic 100pF ±5%	
C3, 4	C46-1727-36	Mylar 0.027μF ±10%	
C5, 6	C25-1722-47	Electrolytic 0.22μF 50WV	
C7 ~ 10	C24-1410-61	Electrolytic 10μF 25WV	
C11~14	C46-1718-46	Mylar 0.18μF ±10%	
C15~18	C46-1710-36	Mylar 0.01μF ±10%	
C19, 20	C24-1247-61	Electrolytic 47μF 16WV	
-	E29-0113-14	Lead plate (for VR2 ~ 4)	
VR1	R08-5043-05	Potentiometer 100kΩ (B) x 2 VOLUME	☆
VR2	R06-5042-05	Potentiometer 200kΩ (MN) x 2 BALANCE	☆
VR3, 4	R06-3019-05	Potentiometer 20kΩ (B) x 2 TONE	☆
S1, 2	S33-2055-05	Lever switch TONE, LOUDNESS	
IC1	V30-0248-10	IC NJM4558D (A)	

A product of TRIO-KENWOOD CORPORATION

Shionogi Shibuya Building, 17-5, 2-chome Shibuya, Shibuya-ku, Tokyo 150 Japan

**KENWOOD ELECTRONICS, INC.**  
 1315 E Watsoncenter Rd. Carson, California 90745, U.S.A.  
 75 Seaview Drive, Secaucus, New Jersey 07094, U.S.A.  
 1098 North Tower Lane, Bensenville, Illinois 60106, U.S.A.

**TRIO-KENWOOD CANADA INC.**  
 1070 Jayson Court Mississauga, Ontario Canada L4W 2V5

**TRIO-KENWOOD ELECTRONICS, N.V.**  
 Leuvensesteenweg 504, B-1930 Zaventem, Belgium

**TRIO-KENWOOD ELECTRONICS, GmbH**  
 Rudolf-Braas-Str. 20, 6056 Heusenstamm, West Germany

**TRIO-KENWOOD FRANCE S.A.**  
 5, Boulevard Ney, 75018 Paris, France

**TRIO-KENWOOD SVENSKA AB**  
 Kemistvagen 10A, 183-21 Taby, Sweden

**TRIO-KENWOOD AG**  
 Unterboesch 6331 Huenenberg/ZUG Switzerland

**TRIO-KENWOOD (AUSTRALIA) PTY. LTD.**  
 30 Whiting St., Artarmon, N.S.W. 2064, Australia

**KENWOOD & LEE ELECTRONICS, LTD.**  
 Wang Kee Building, 5th Floor, 34-37, Connaught Road Central, Hong Kong