

STEREO INTEGRATED AMPLIFIER

KA-5010

SERVICE MANUAL

KENWOOD

©1988-11 PRINTED IN JAPAN
B51-3698-00(T)1852

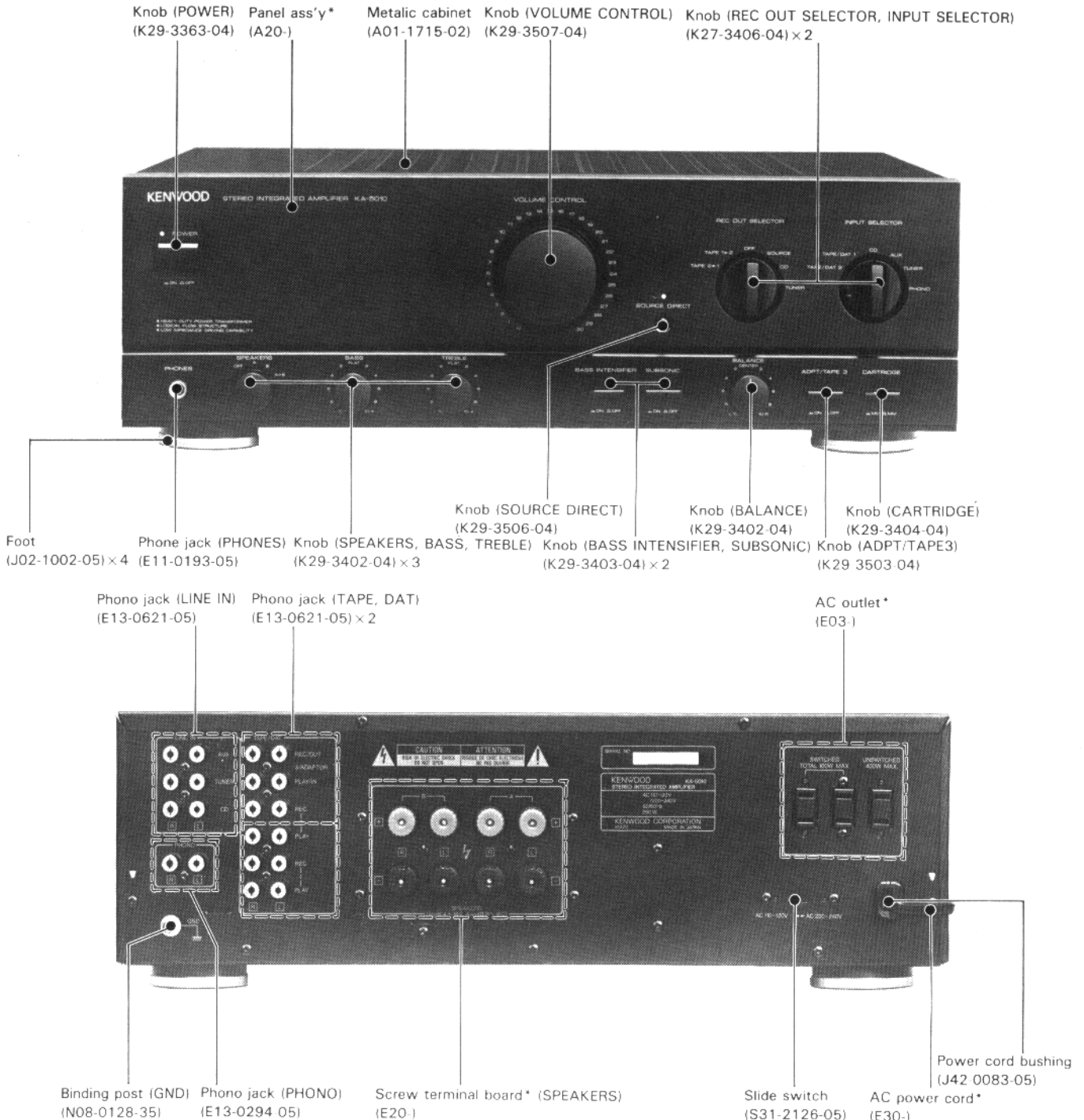

* Refer to parts list on page 21.

ADJUSTMENT/REGLAGES/ABGLEICH

No.	ITEM	INPUT SETTINGS	OUTPUT SETTINGS	AMPLIFIER SETTING	ALIGNMENT POINTS	ALIGN FOR	FIG.
1	IDLE CURRENT	—	Connect a DC voltmeter across CP1 CP2	VOLUME: 0	VR1 (L) VR2 (R) (X09-)	9mV	(a)

N°	ITEM	REGLAGE DE L'ENTREE	REGLAGE DE LA SORTIE	REGLAGE DE L'AMPLIFICATEUR	POINTS DE L'ALIGNMENT	ALIGNER POUR	FIG.
1	COURANT DE POLARISATION	—	Connecter un voltmètre de CC SUR CP1 CP2	VOLUME: 0	VR1 (G) VR2 (D) (X09-)	9mV	(a)

NR.	GENGENSTAND	EINGANGS-EINSTELLUNG	AUSANG-EINSTELLUNG	VORSTÄRKER-EINSTELLUNG	ABGLEICHE-PUNKTE	ABGLEICHEN FÜR	ABB.
1	LEERLAUFSTROM	—	Einen Gleichspannungsmesser über CP1 CP2 anschließen.	VOLUME: 0	VR1 (L) VR2 (R) (X09-)	9mV	(a)

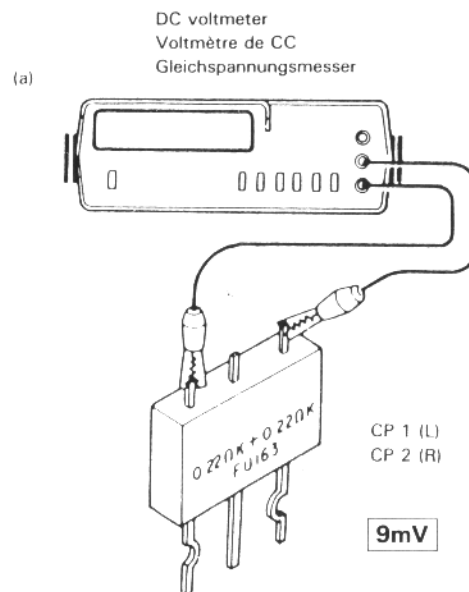

VOLTAGE TABLES

PRE-AMPLIFIER UNIT (X08-227X-XX)

MAIN UNIT (X09-281X-XX)

IC1 (1/2)

1	—
2	—
3	—
4	-20V

IC1 (2/2)

5	6.3V
6	6.3V
7	0V
8	20V

IC2 (1/2)

1	0V
2	0V
3	0V
8	15V

IC2 (2/2)

4	-15V
5	0V
6	0V
7	0V

Q1

E	3V
C	6.3V
B	3.6V

Q2

E	—
C	—
B	—

Q3

E	3V
C	6.3V
B	3.6V

Q4

E	—
C	—
B	—

Q5

D	0.2V
S	3V
G	0V

Q6

D	—
S	—
G	—

Q7

D	3V
S	0.2V
G	0V

Q8

D	—
S	—
G	—

Q11

D	-20.6V
S	-36V
G	-36V

Q12

D	36V
S	20.6V
G	20.6V

Q13

E	-20V
C	-36V
B	-20.6V

Q14

E	20V
C	36V
B	—

Q15

E	—
C	—
B	-0.6V

Q16

E	20V
C	18V
B	19.4V

IC-1

1	0V
2	0V
3	0V
4	2.26V
5	—
6	0.6V
7	2.2V
8	3.3V

Q1

E	0.6V
C	-7.1V
B	0V

Q2

E	—
C	—
B	—

Q3

E	0.6V
C	-7.1V
B	0V

Q4

E	—
C	—
B	—

Q5

E	-7.1V
C	-44.9V
B	-7.7V

Q6

E	—
C	—
B	—

Q7

E	-7.1V
C	-44.9V
B	-7.7V

Q8

E	—
C	—
B	—

Q9

E	-44.5V
C	-44.0V
B	-44.9V

Q10

E	—
C	—
B	—

Q11

E	-45.5V
C	-44.0V
B	-44.9V

Q12

E	—
C	—
B	—

Q13

E	-44.0V
C	-1.8V
B	—

Q14

E	—
C	—
B	—

Q15

E	52V
C	1.8V
B	51.4V

Q16

E	—
C	—
B	—

Q17

E	-44.0V
C	38.9V
B	—

Q18

E	—
C	—
B	—

Q19

E	1.2V
C	55V
B	—

Q20

E	—
C	55V
B	—

Q21

E	-1.2V
C	55V
B	—

Q22

E	—
C	-55V
B	—

Q23

E	0.6V
C	55V
B	1.2V

Q24

E	—
C	55V
B	—

Q25

E	-0.6V
C	-55V
B	-1.2V

Q26

E	—
C	-55V
B	—

Q27

E	—
C	55V
B	0V

Q28

E	—
C	—
B	—

Q29

E	-46.3V
C	-55V
B	-47V

Q30

E	—
C	-55V
B	—

Q31

E	14.8V
C	3.8V
B	14.2V

Q32

E	—
C	—
B	14.2V

Q33

E	0V
C	-1.2V
B	0V

Q34

E	—
C	—
B	—

Q41

E	—
C	2.0V
B	0V

Q42

E	19.8V
C	20.7V
B	20V

Q43

E	55V
C	0V
B	—

(X08-227X-XX)(A/5)

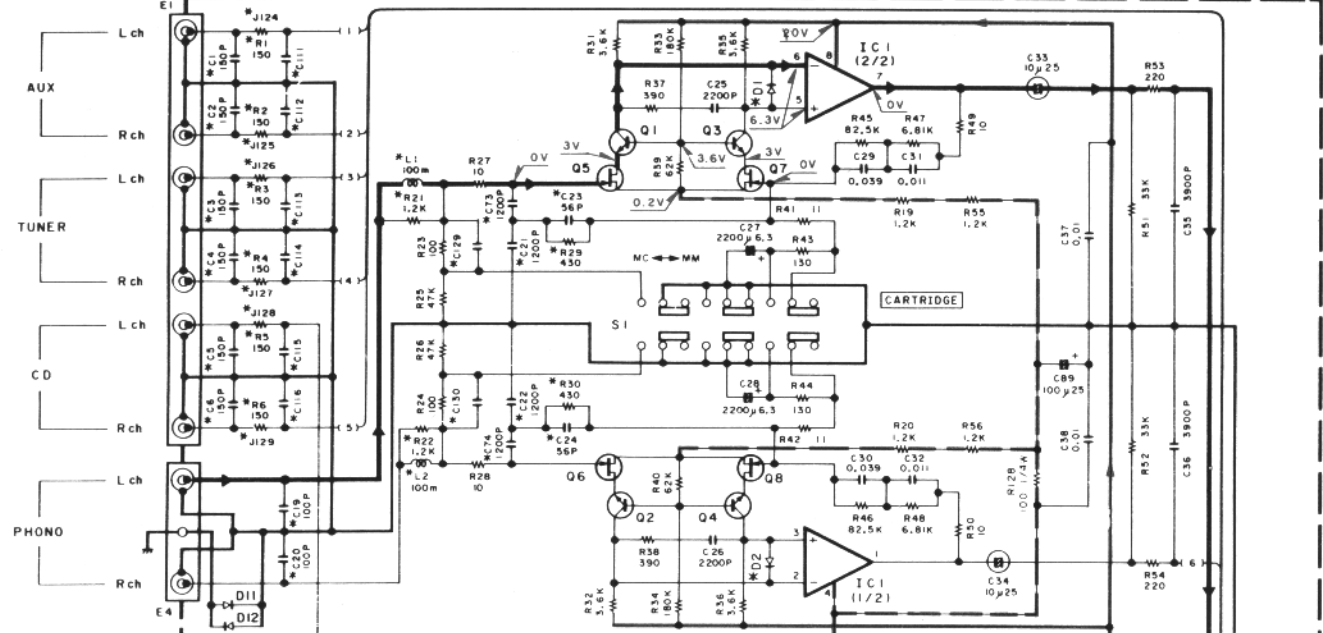

(X08-227X-XX)(C/5)

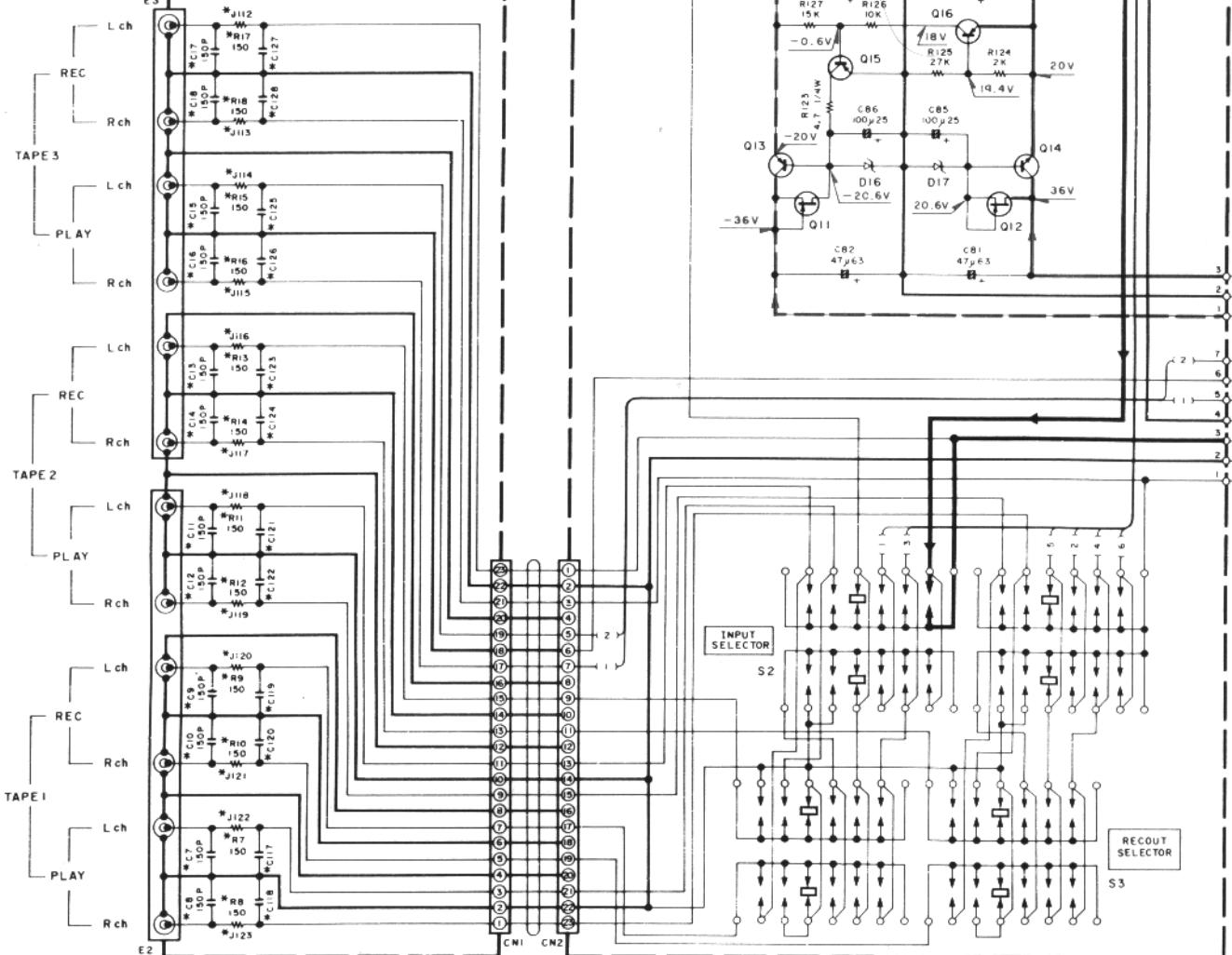

- 2SA1123
- 2SA1124
- 2SA733 (A)
- 2SA992
- 2SC1845
- 2SC2631
- 2SC2632
- 2SC945 (A)

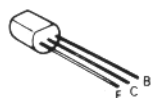

- 2SA1110
- 2SC2590

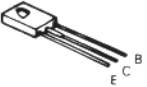

- 2SA933S
- 2SC1740S

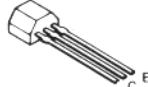

- 2SA1215*5
- 2SC2921*5

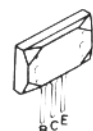

- 2SC4137



- 2SA1535
- 2SC3944

(X08-227X-XX)(D/5)

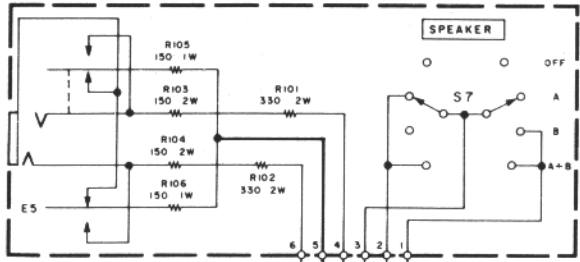

(X08)(E/5)

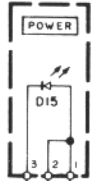

SIGNAL LINE
 GND LINE
 +B LINE
 -B LINE

(X08-227X-XX)(B/5)

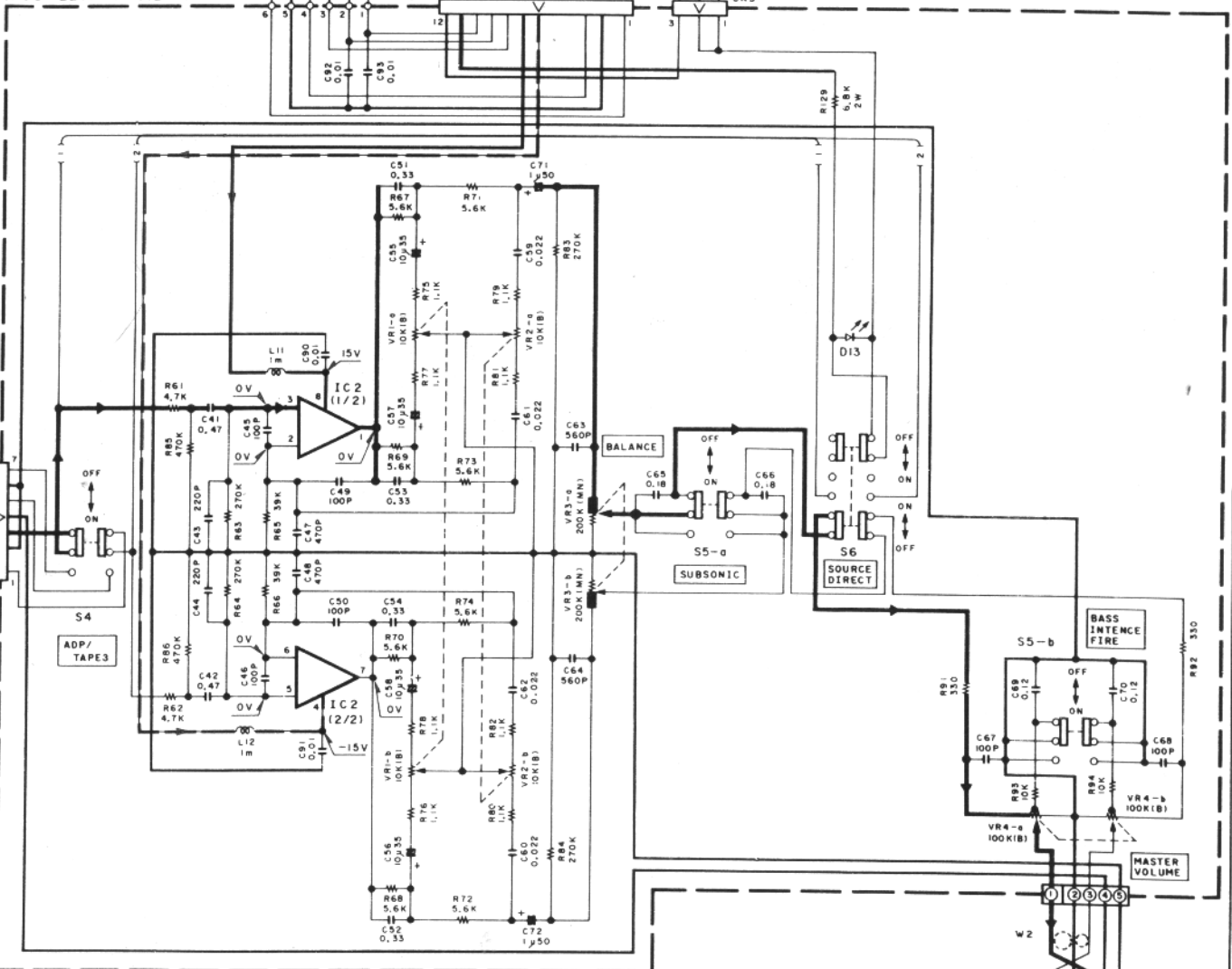

(X08-227X-XX)

DESTINATION	Ref. No.	R1-18	R21	R22	R29,30	C1-18	C19,20	C21,22 73,74	C23,24	C111-128	C129,130	L1,2	D1,2
0-00	P, X, T, L U, M, UE	J112-129	J131	J130	NO	NO	NO	NO	NO	NO	NO	NO	NO
2-71	E	YES	YES	YES	YES	YES	YES	YES	YES	NO	NO	YES	NO

(X09-281X-XX)

DESTINATION	Ref. No.
0-11	P, X, U, M, UE
0-51	T
1-71	L
2-71	E



NJM4560D-N

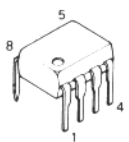

M5218P-A

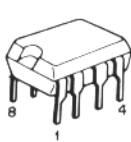

μPC1237HA

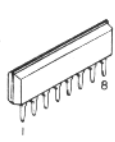

2SK246

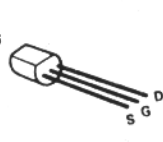

2SK105
2SK170

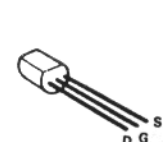

Variable capacitor symbol

(X09-2B1X-XX)(A/3)

(X09)(B/3)

(X09)(C/3)

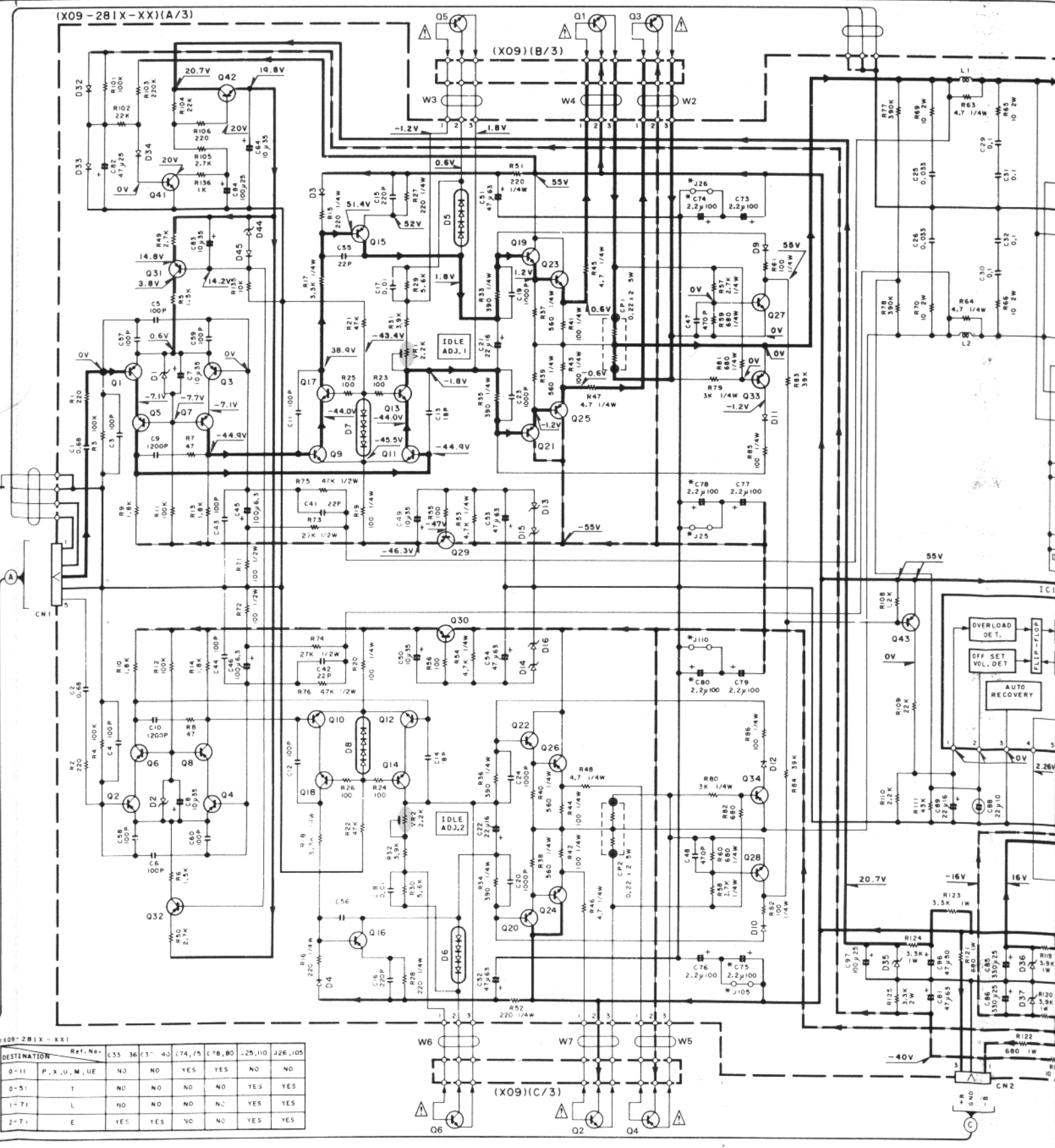

X09-2B1X-XXI

DESTINATION	Ref. No.	C33,36	C1,40	C74,75	C78,80	-25,110	J26,105
0-11	P, X, U, M, UE	NO	NO	YES	YES	NO	NO
0-51	T	NO	NO	NO	NO	YES	YES
1-71	L	NO	NO	NO	NO	YES	YES
2-71	E	YES	YES	NO	NO	YES	YES

DC voltages are as measured with a high impedance voltmeter with no signal input. Values may vary slightly due to variations between individual instruments or/and units.

Les tensions c.c. doivent être mesurées avec un volt-mètre à haute impédance sans signal d'entrée. Les valeurs peuvent différer légèrement du fait des variations inhérentes aux appareils et aux instruments de mesure individuels.

Die angegebene DC-Spannungen sind mit einem hochohmigen Voltmeter ohne Signaleingang gemessen worden. Die Werte können aufgrund von individuellen Messungen abweichen.

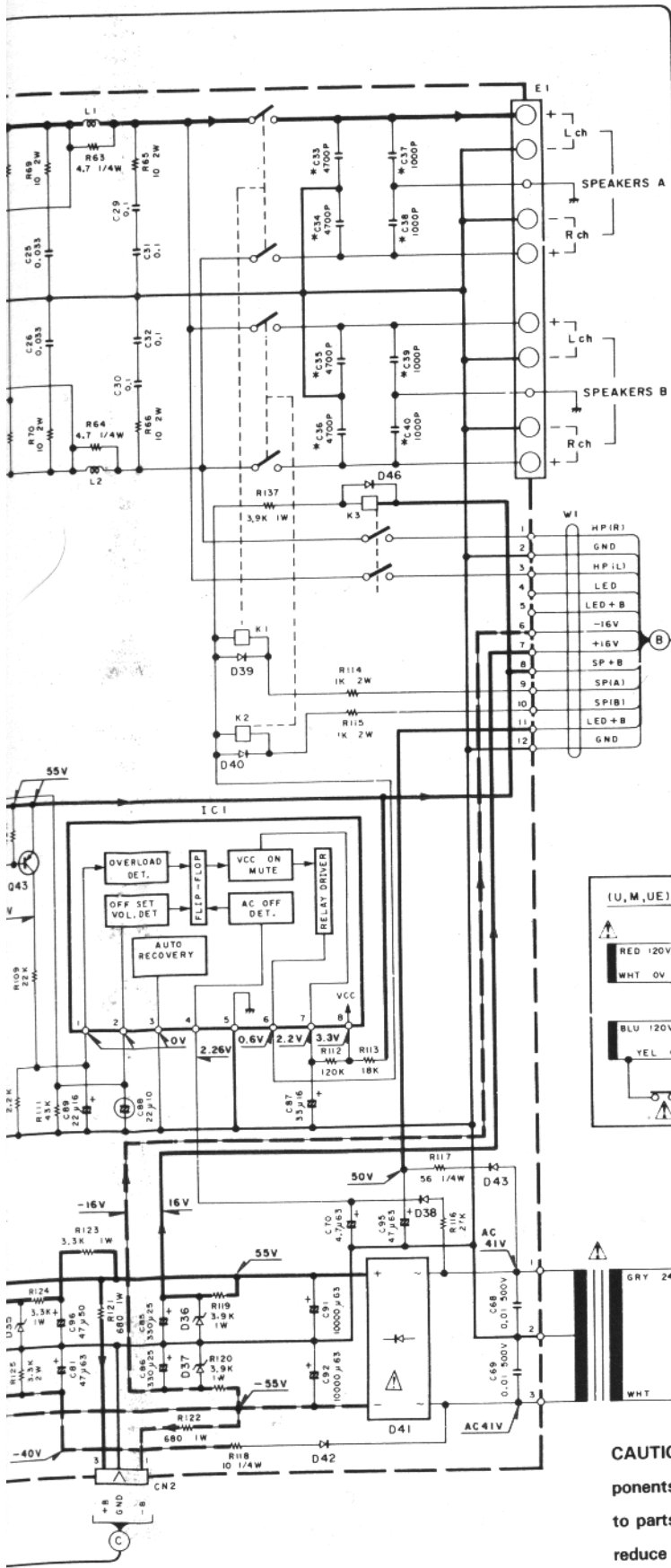

(X08-227X-XX)

- IC 1 : MJM 4560D - N
- IC 2 : M5218P - A
- Q1 ~ 4 : 2SC945(A)(Q,P)
or 2SC1740S(Q,R)
- Q5 ~ 8 : 2SK170(BL,V)
or 2SK105(H)
or 2SK246(GR)
- Q13 : 2SA1110(Q,R)
- Q14 : 2SC2590(Q,R)
- Q15, 16 : 2SA733(A)(Q,P)
or 2SA933S(Q,R)
- D11, 12 : 1SS133 or HSS104
- D13, 15 : B30-0431-05
- D16, 17 : RD20JS(B)
or HZS20S(B)

(Y08-363X-XX)

- Q1,2 : 2SC2921*5
- Q3,4 : 2SA1215*5
- Q5,6 : 2SC4137

(X09-281X-XX)

- IC 1 : μ PCI237HA
- Q1 ~ 8, 33, 34, 43 : 2SA992(F,E)
- Q9 ~ 14, 17, 18 : 2SC2632(R,S)
- Q15, 16 : 2SA1124(R,S)
- Q19, 20 : 2SC2631(R,S)
- Q21, 22 : 2SA1123(R,S)
- Q23, 24 : 2SC3944(R,S)
- Q25, 26 : 2SA1535(R,S)
- Q27, 28, 41, 42 : 2SC1845(F,E)
- Q29, 30 : 2SA1110(R,S)
- Q31, 32 : 2SA733(A)(Q,P)
or 2SA933S(Q,R)

D1, 2 : RD8.2JS(B) or HZS8.2S(B)

- D3, 4, 45 : 1SS133
- D5 ~ 8 : MA27Q(A) or HSS104
- D9 ~ 12, 32 ~ 34, 39, 40, 46 : 1SS131 or HSS104A
- D13 ~ 16, 35 : RD24ES(B) or HZS24N(B)
- D36, 37 : RD16ES(B) or HZS16N(B)
- D38, 42, 43 : GPI0D-5007L
- D41 : D5FB20*1
- D44 : RD5.1JS(B2) or HZS5.1S(B2)

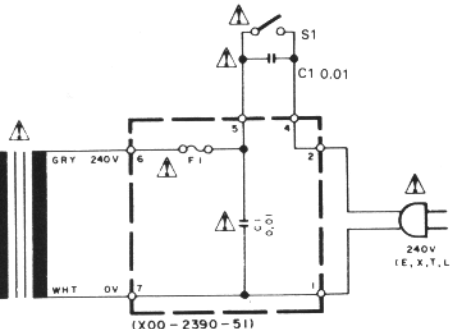
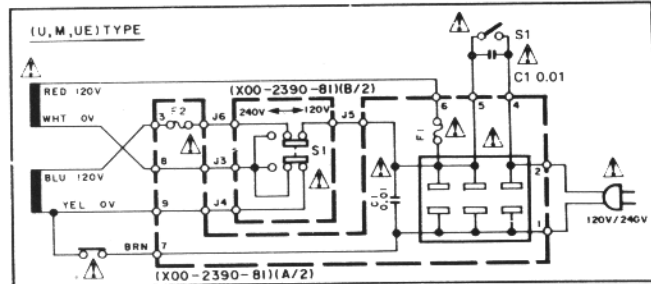
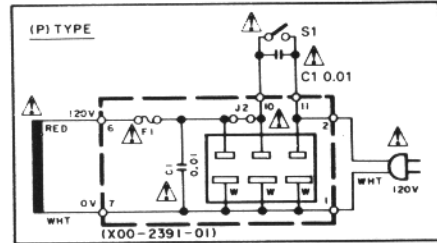

CAUTION: For continued safety, replace safety critical components only with manufacturer's recommended parts (refer to parts list).  Indicates safety critical components. To reduce the risk of electric shock, leakage-current or resistance measurements shall be carried out (exposed parts are acceptably insulated from the supply circuit) before the appliance is returned to the customer.

KA-5010(E)

vec un volt-
entrée. Les
it des varia-
truments de

Die angegebenen Gleichspannungswerte wurden mit einem hochohmigen Spannungsmesser ohne Eingangssignal gemessen. Dabei schwanden die Meßwerte aufgrund von Unterschieden zwischen einzelnen Instrumenten oder Geräten u.U. geringfügig.