

X08- C/6

DC voltages are as measured with a high impedance voltmeter with no signal input. Values may vary slightly due to variations between individual instruments or/and units.

Les tensions c.c. doivent être mesurées avec un voltmètre à haute impédance sans signal d'entrée. Les valeurs peuvent différer légèrement du fait des variations inhérentes aux appareils et aux instruments de mesure individuels.

Die angegebenen Gleichspannungswerte wurden mit einem hochohmigen Spannungsmesser ohne Eingangssignal gemessen. Dabei schwanken die Meßwerte aufgrund von Unterschieden zwischen einzelnen Instrumenten oder Geräten u.

**CAUTION:** For continued safety, replace safety critical components only with manufacturer's recommended parts (refer to parts list). **⚠** Indicates safety critical components. To reduce the risk of electric shock, leakage-current or resistance measurements shall be carried out (exposed parts are acceptably insulated from the supply circuit) before the appliance is returned to the customer.

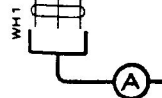

(A)

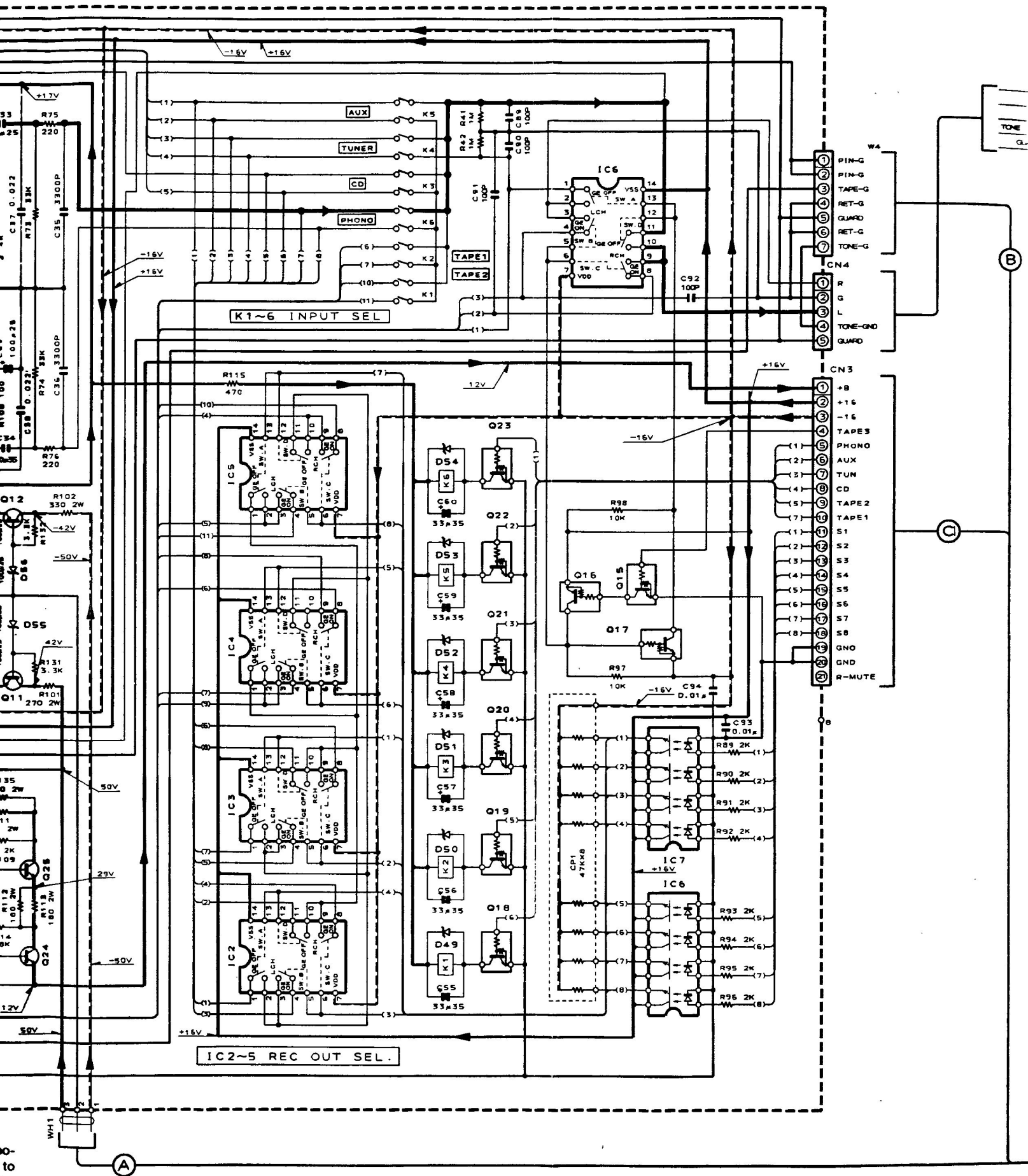

to  
the  
nts  
om  
m-

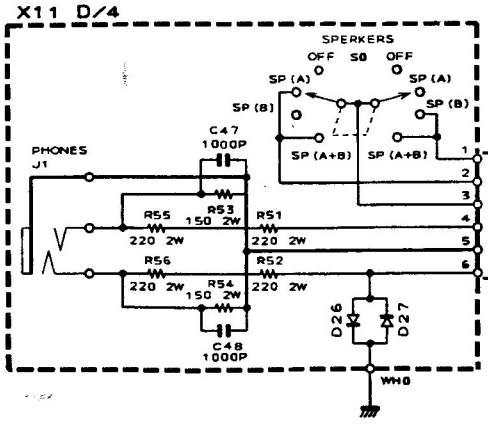
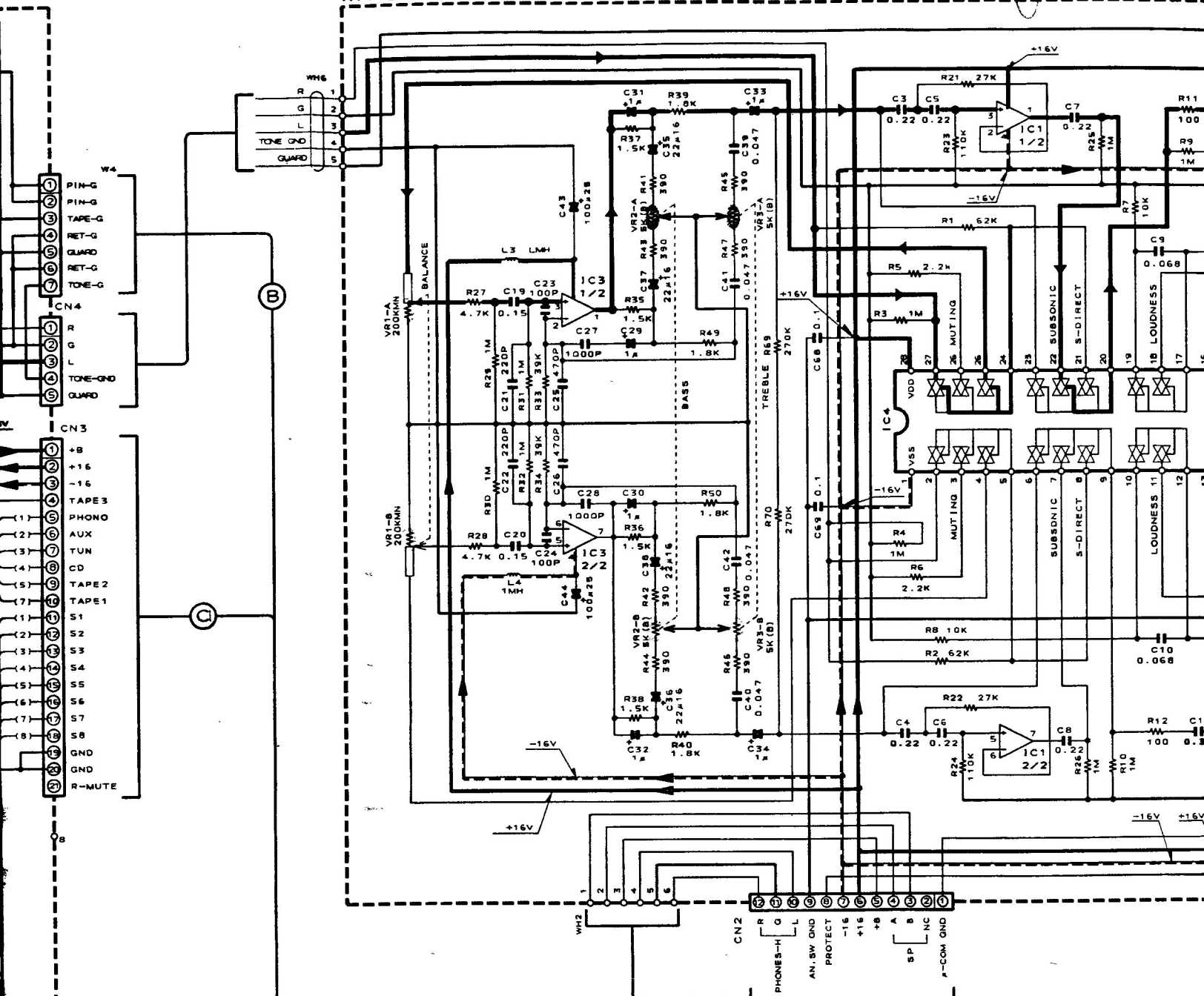

- X08-246X-XX
- IC1
  - IC2~6
  - IC7, 8
  - IC9
  - IC10
  - IC11
  - Q1~4
  - Q5~8
  - Q11, 13, 14
  - Q12
  - Q15, 17~23
  - Q16
  - Q24, 25
  - Q26
  - Q27, 28

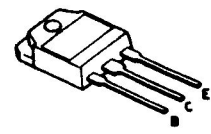
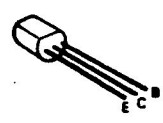

2SA1123 2SA992 2SC2632  
 2SA1124 2SC1845 2SC2878  
 2SA733 (A) 2SC2631

2SA1694LB\*5  
 2SC4467LB\*5

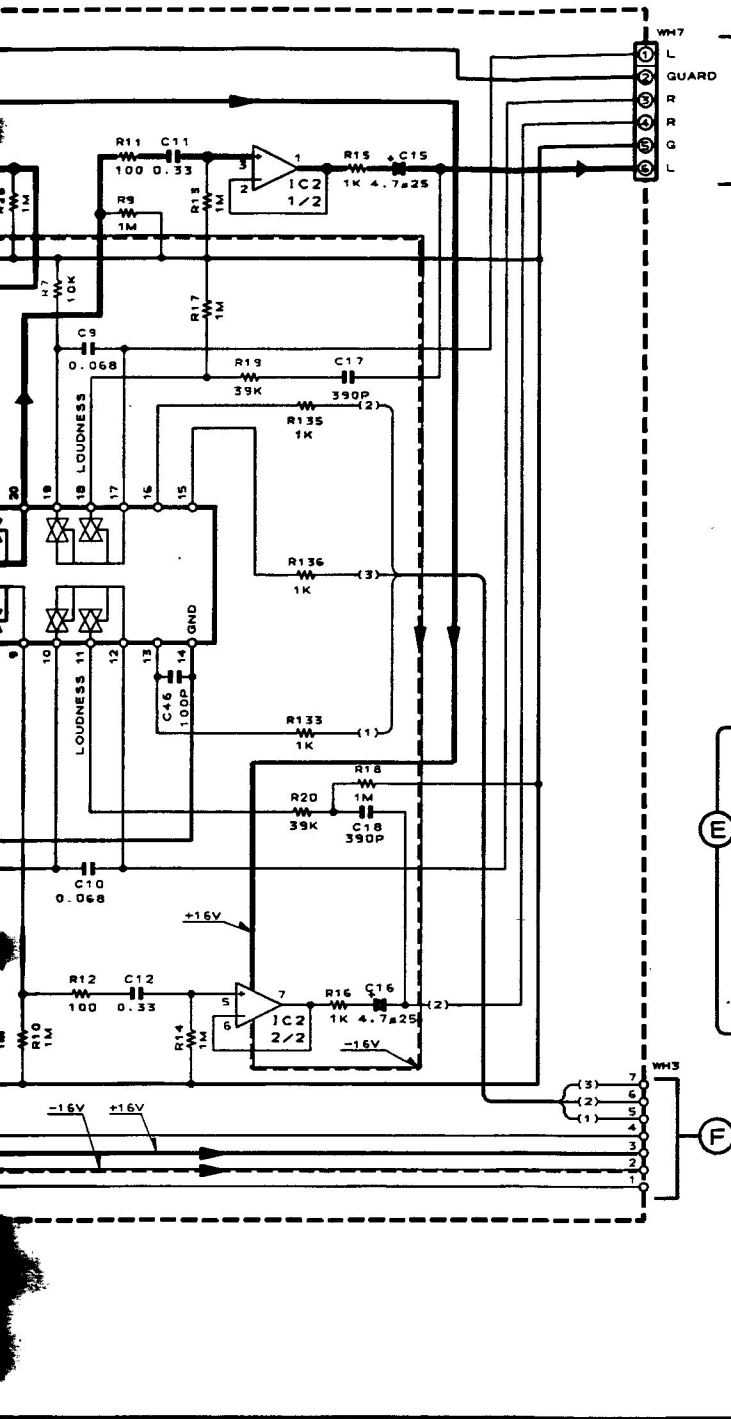

X09-320X-XX

COUNTRY	ABB.	UNIT NAME
EUROPE	E	2-73
EUROPE	Y	
GENERAL MARKET	M	
AUSTRALIA	X	
ENGLAND	T	2-74
NORTHERN EUROPE	L	
CANADA	P	1-02

X08-246X-XX

COUNTRY	ABB.	UNIT NAME
EUROPE	E	2-70
CANADA	P	1-01
EUROPE	Y	2-91
GENERAL MARKET	M	0-21
AUSTRALIA	X	0-71
ENGLAND	T	0-51

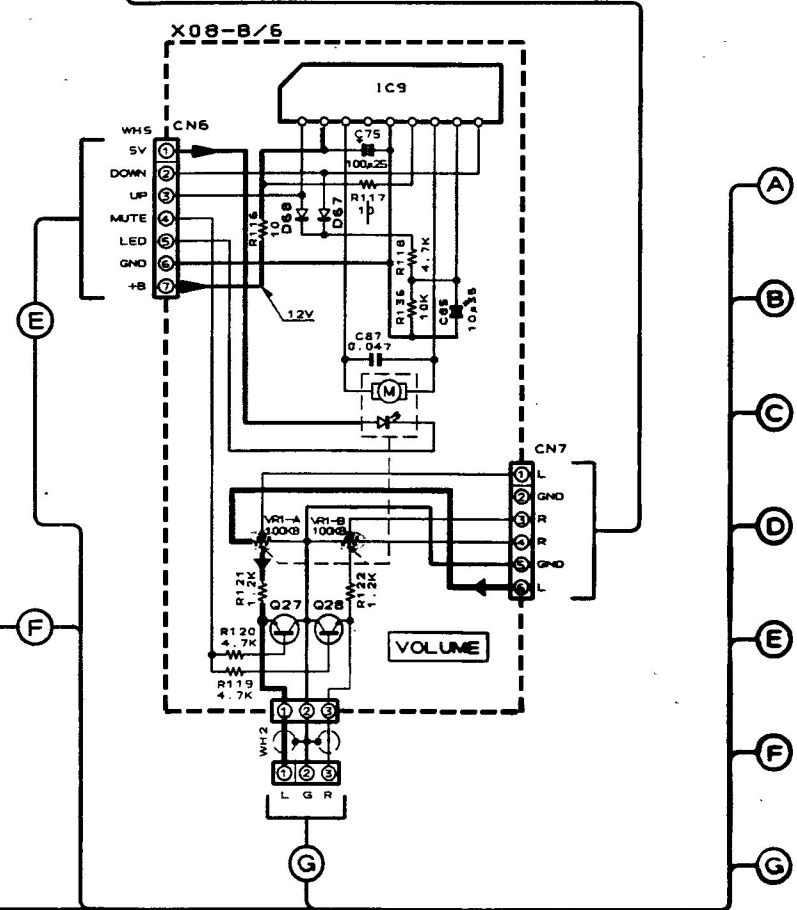

X08-246X-XX

- 1 : NJM4565D-D
- 2-6 : LC4966
- 7, 8 : ON3134
- 9 : TAB409S
- 10 : UPC7805HF or TA7805S
- 11 : NJM4558D
- 12 : 2SC1845 (F, E)
- 13, 14 : 2SK170 (BL) or 2SK170 (V)
- 15 : 2SC2590 (Q, R)
- 16 : 2SA1110 (Q, R)
- 17-23 : DTC124ES or UN4212
- 24 : DTA124ES or UN4112
- 25 : 2SD1266 (Q, P)
- 26 : 2SC1740S (Q, R) or 2SC3311A (Q, R)
- 27, 28 : 2SC287B (B)
- D1 : 1SS131 or HSS104R
- D2-13, 26, 27 : 1SS133 or HSS104
- D13-30 : MA177
- D31 : RD20JS (B) or HZS20S (B)
- D32 : RD5.1JS (B2) or HZS5.1S (B2)
- D33 : RD20JS (B) or HZS20S (B)
- D49-54 : RD11ES (B2) or HZS11N (B2)
- D49-54 : RD11ES (B2) or HZS11N (B2)
- D55, 56, 58 : RD30ES (B) or HZS30N (B)
- D57 : RD13ES (B2) or HZS13N (B2)
- D62 : 1SS131 or HSS104A
- D63-66 : S56888
- D69 : RD3.9ES (B) or HZS3.9N (B)
- X11-311X-XX
- IC1, 3 : NJM4565D-D
- IC2 : NJM4580D-D
- IC4 : TC9163M

——— SIGNAL LINE  
 ——— GND LINE  
 ——— +B LINE  
 - - - -B LINE

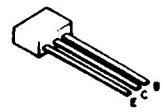

UN4212  
2SC3311A

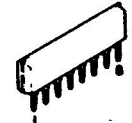

UPC1237HA

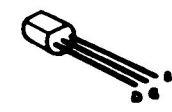

2SK170

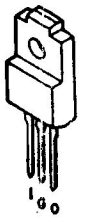

TA7805S

X09-320X-XX

COUNTRY	ABB.	UNIT NAME
EUROPE	E	2-73
EUROPE	Y	
GENERAL MARKET	M	
AUSTRALIA	X	
ENGLAND	T	2-74
NORTHERN EUROPE	L	
CANADA	P	

X08-246X-XX

COUNTRY	ABB.	UNIT NAME
EUROPE	E	2-70
CANADA	P	1-01
EUROPE	Y	2-91
GENERAL MARKET	M	0-21
AUSTRALIA	X	0-71
ENGLAND	T	0-51

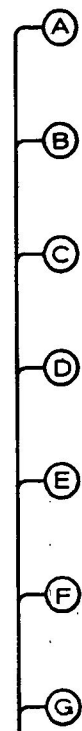
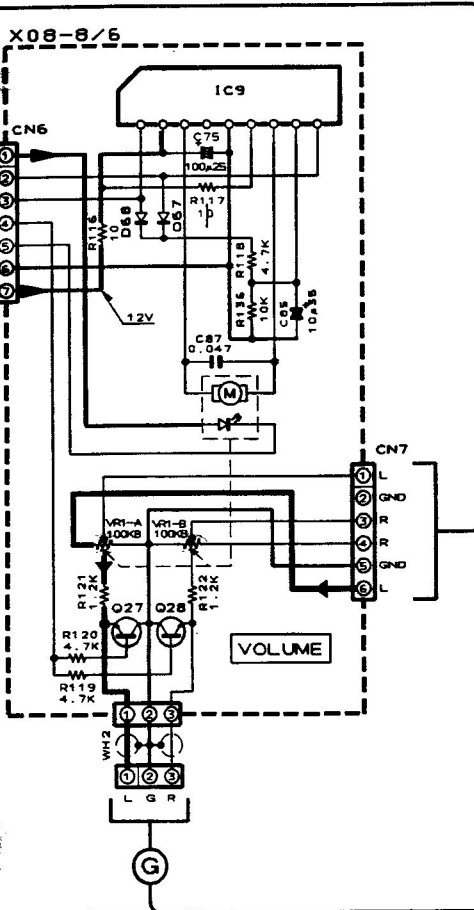

2SA1110  
2SC2590

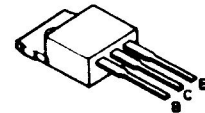

2SD1266

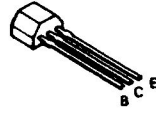

DTA124ES 2SA933S  
DTC124ES 2SC1740S  
UN4112



2SA1535  
2SB941  
2SC3944

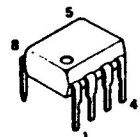

NJM4558D  
NJM4565D  
NJM4565D-D

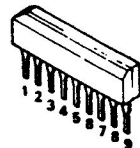

TA8409S

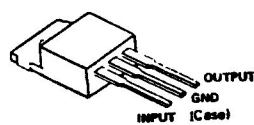

UPC7805HF

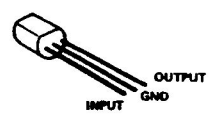

PST529D

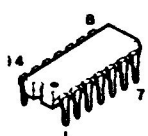

LC4966

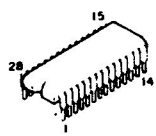

TC9163N

- D62 : 1SS131 or HSS104A
- D63-66 : S56888
- D69 : RD3.9ES (B) or HZS3.9N (B)

- X11-311X-XX
- IC1, 3 : NJM4565D-D
- IC2 : NJM4580D-D
- IC4 : TC9163N

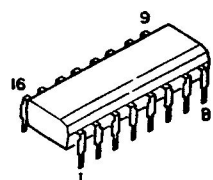
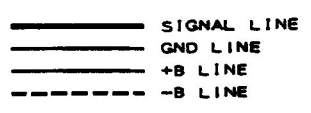

ON3134

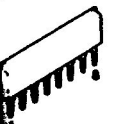

PC1237HA

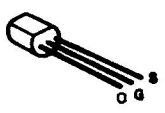

2SK170

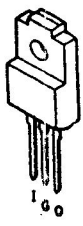

TA7805S

Y08-442-70



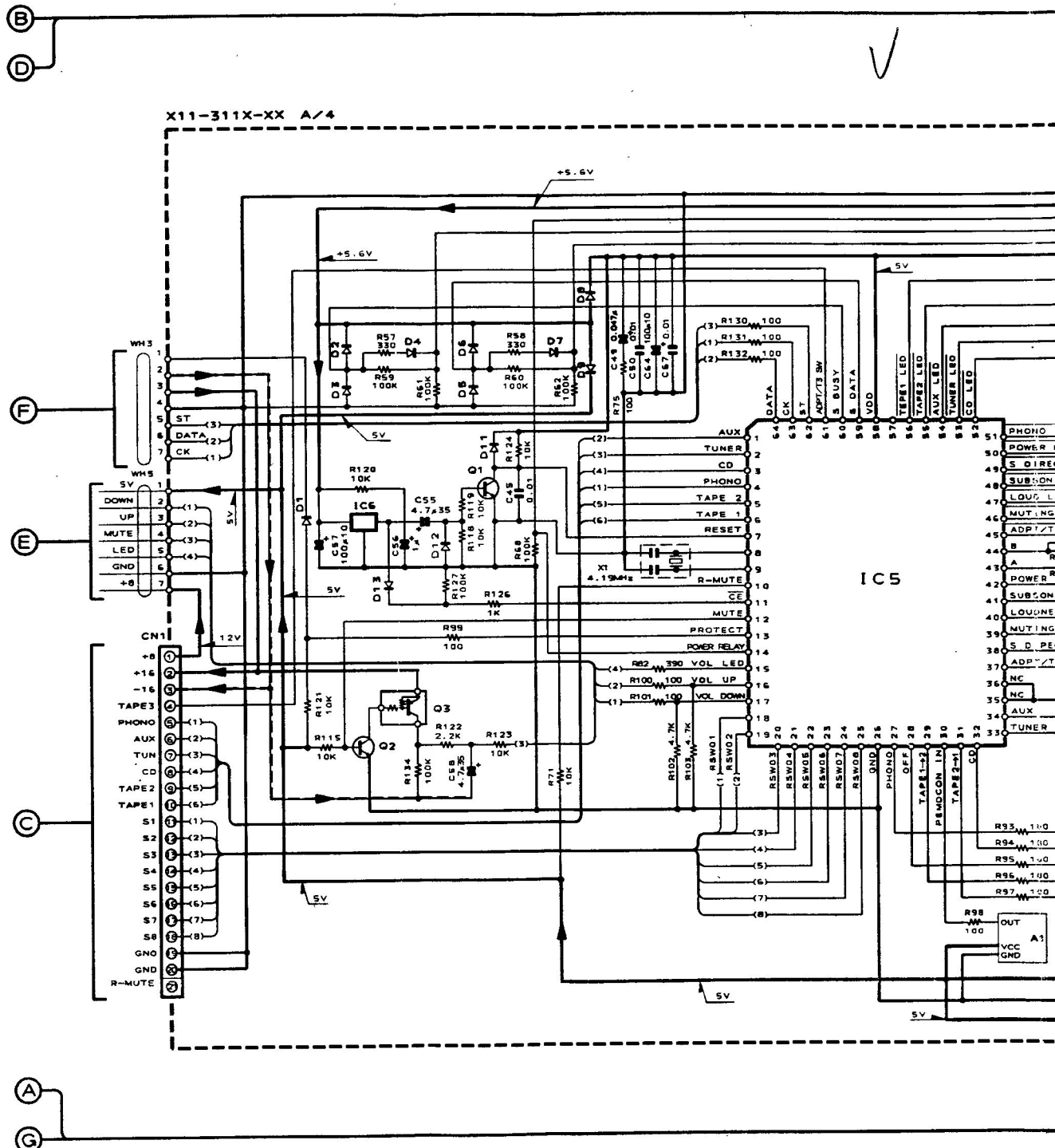

**X11-311X-XX**

- IC5 : PD75104GF-77B
- IC6 : PST529D
- Q1, 2 : 2SC17405 (Q, P)  
or 2SC3311A (Q, R)
- Q3, 4 : DTA124ES OR UN4112
- D1 : 1SS131 or H5S104A
- D2-13, 26, 27 : 1SS133 or H5S104
- D14-25 : B30-1291-05

**X09-320X-XX**

- IC1 : UPC1237HA
- IC2 : NJM4565D

- Q1-8, 31, 32, 55 : 2SA997
- Q9, 10, 54 : 2SA733  
or 2
- Q15-18 : 2SC2632
- Q19, 20 : S12SA11
- Q21, 22 : 2SC2631
- Q23, 24 : 2SA1123
- Q25, 26 : 2SC3944
- Q27, 28 : 2SA1535
- Q29, 30, 52, 53 : 2SC1845
- Q56 : 2SD1266
- Q57 : 2SB941

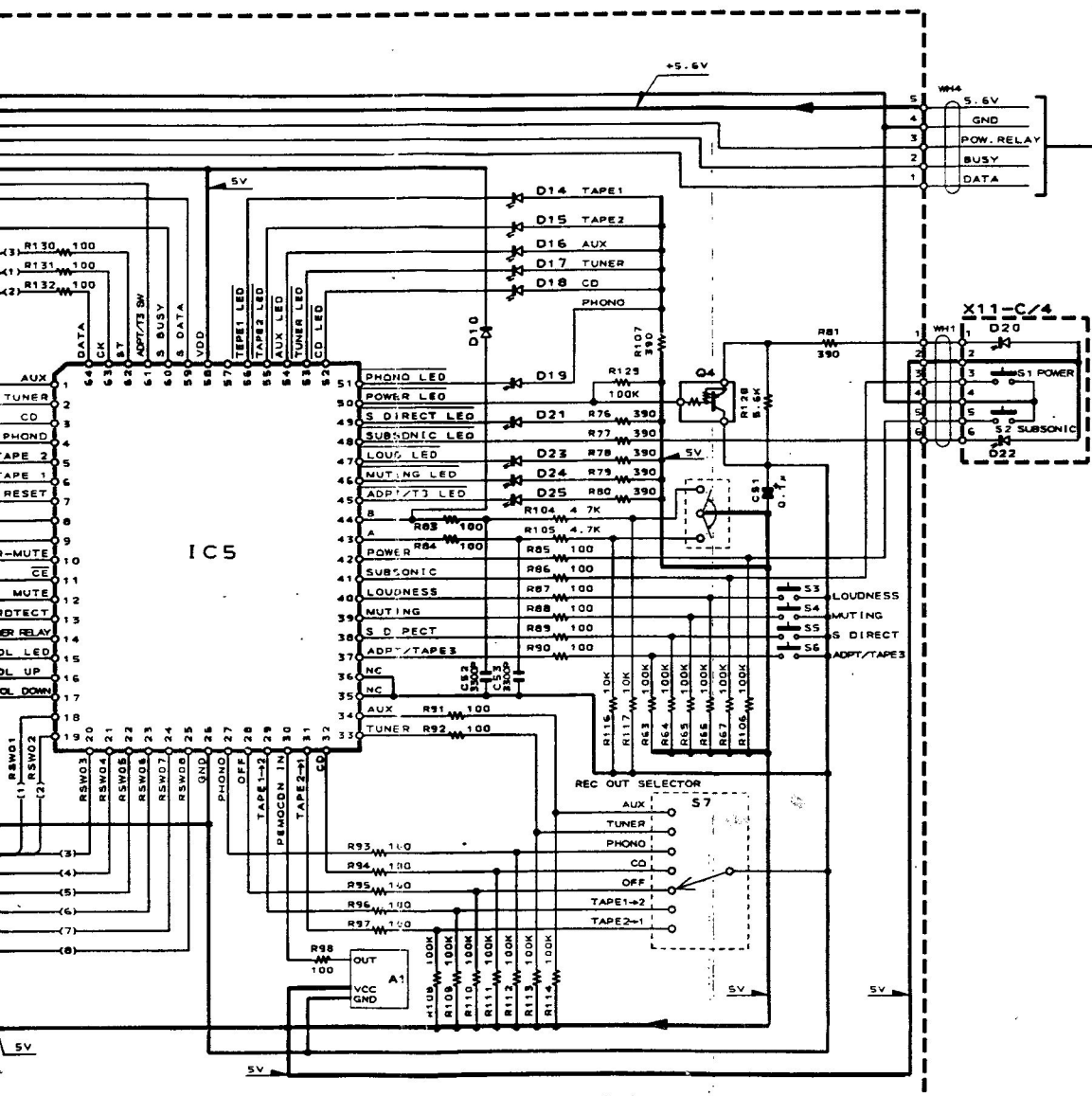

X09-320X-XX

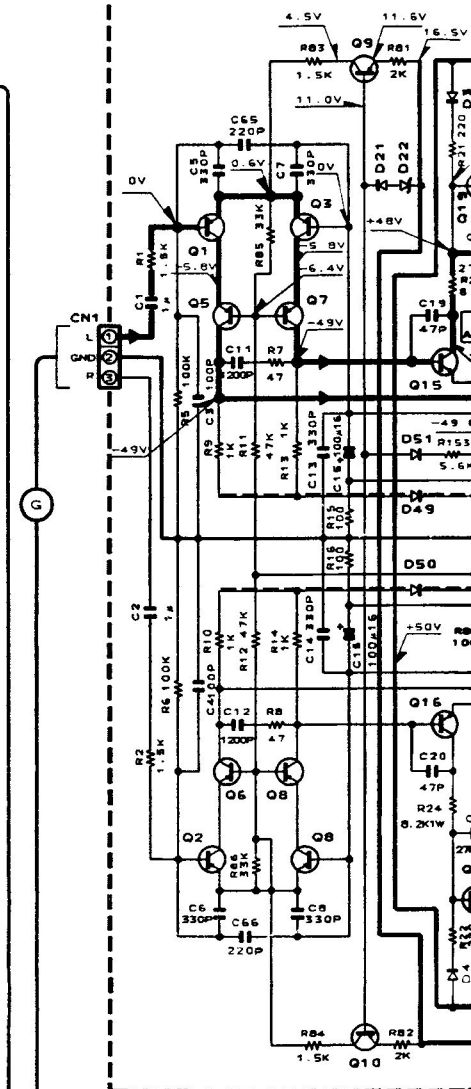

PC1237HA  
JM4565D

- Q1-8, 31, 32, 55 : 2SA593 (F, E)  
 Q9, 10, 54 : 2SA733 (A) (Q, P)  
 or 2SA9335 (Q, R)  
 Q15-18 : 2SC2632 (R, S)  
 Q19, 20 : S125A1124 (R, S)  
 Q21, 22 : 2SC2631 (R, S)  
 Q23, 24 : 2SA1123 (R, S)  
 Q25, 26 : 2SC3944 (R, S)  
 Q27, 28 : 2SA1535 (R, B)  
 Q29, 30, 52, 53 : 2SC1845 (F, E)  
 Q56 : 2SD1266 (Q, P)  
 Q57 : 2SB941 (Q, P)

- D3, 4, 21, 26, 49, 50, 51 : HSS104 or 1SS133  
 D7, 8 : MA270 (A)  
 D9-12, 25, 27, 28 : HSS104A or 1SS131  
 D22, 29 : RD5.1J5 (B2) OR  
 HZ55.15 (B2)  
 D30, 31, 47, 48 : RD6.8E5 (B2) or  
 HZ56.8N (B2)  
 D44 : S5688B  
 D46 : DSF820\*1

X09-320X-XX

COUNTRY	ABB.	UNIT NAME	AREP. NO.
EUROPE	E		C36, 37, 57, 6
EUROPE	Y		
GENERAL MARKET	M	2-73	NO
AUSTRALIA	X		
ENGLAND	T		
NORTHERN EUROPE	L	2-74	
CANADA	P	1-02	2.2#100

X09-320X-XX

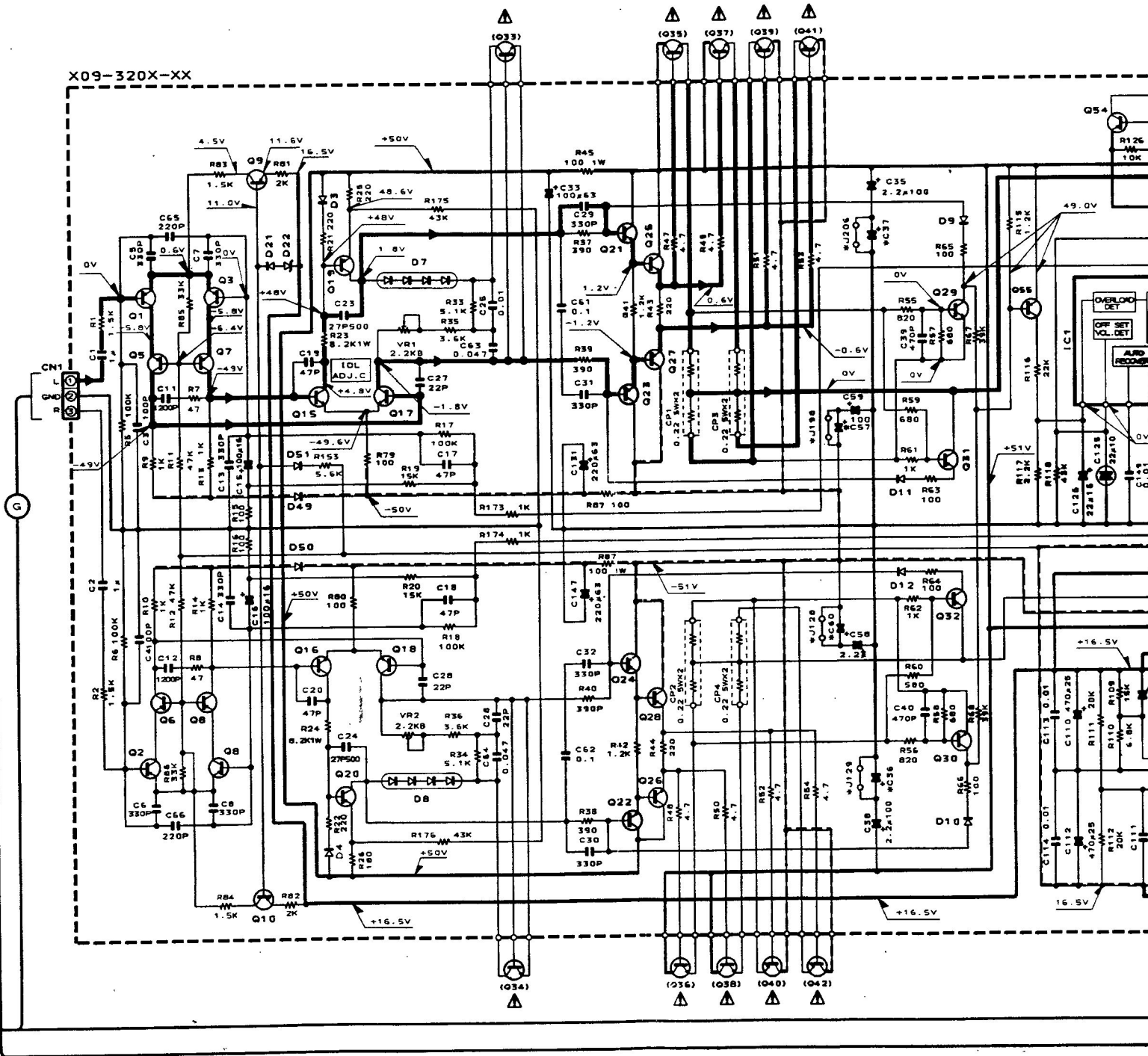

X09-320X-XX

COUNTRY	ABB.	UNIT NAME	AREP. NO	C36, 37, 57, 60	J128, 129, 198, 206
EUROPE	E				
EUROPE	Y				
GENERAL MARKET	M	2-73		NO	YES
AUSTRALIA	X				
ENGLAND	T				
NORTHERN EUROPE	L	2-74			
CANADA	P	1-02		2-2x100	NO

X08-246X-XX

COUNTRY	ABB.	UNIT NAME	AREP. NO	WS3	WS6	WS2	W1 01	J1..	J7	F
EUROPE	E	2-70		YES	NO	NO	NO	E03-0108-05	NO	F05-3 T3-15
CANADA	P	1-01		YES	NO	YES	NO	NO	E03-0111-05	F04-5 SA 1
EUROPE	Y	2-91		NO	NO	YES	YES	NO	E03-0111-05	F05-3 T3-15
GENERAL MARKET	M	0-21		NO	YES	NO	NO	E03-0108-05	NO	F05-3 T3-15
AUSTRALIA	X	0-71		YES	NO	NO	NO	NO	NO	F05-3 T3-15
ENGLAND	T	0-51		YES	YES	NO	NO	E03-0109-05	NO	F05-3 T3-15



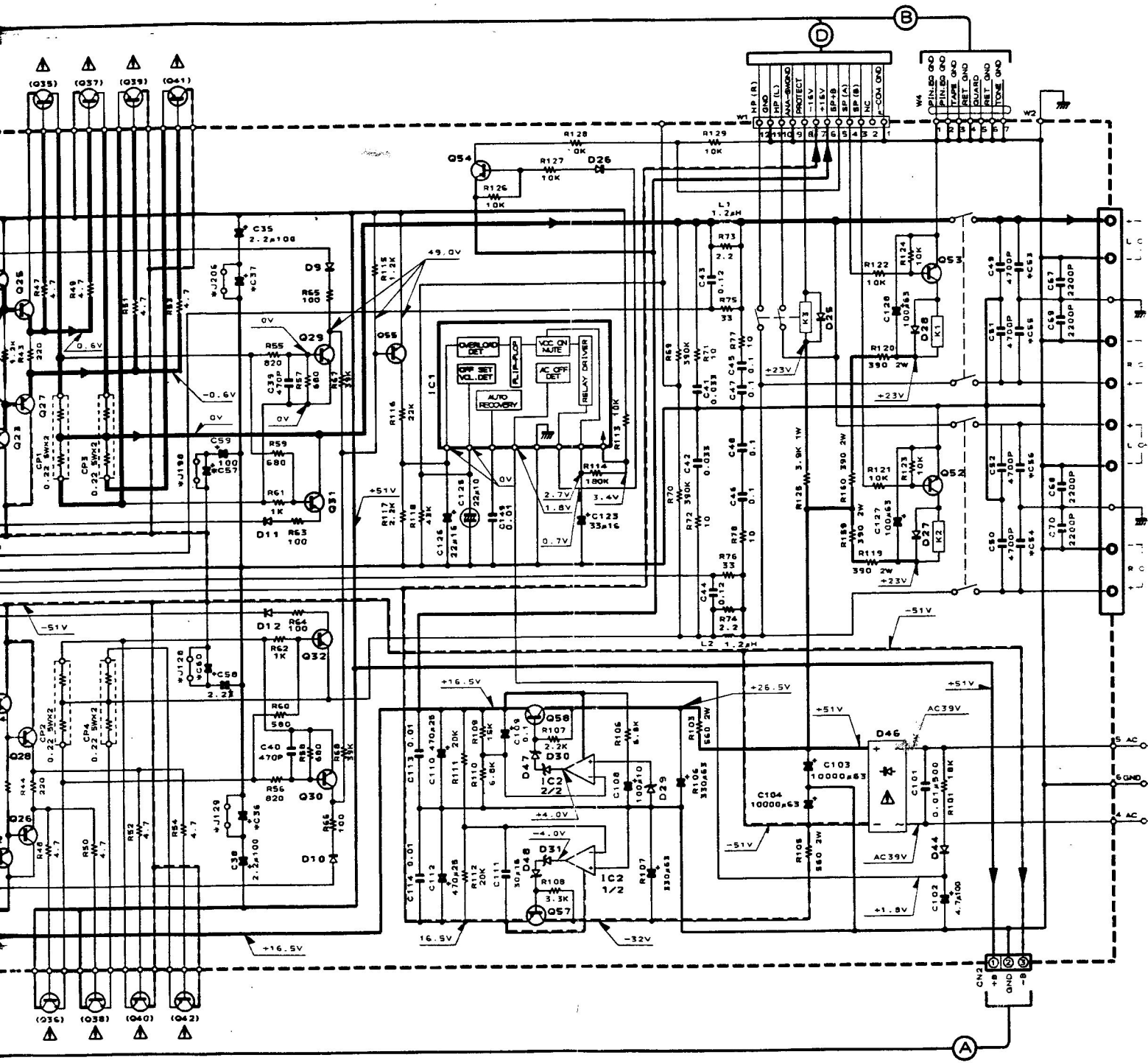

MARKET	ABB.	UNIT NAME	AREP. NO	W53	W56	W62	W1 01	J1..	J7	F1	F2	F3	T1	Q11, 12	Q13, 14	C76, 77	W43-6, 8-10	W47	S2
MARKET	E	2-70		YES	NO	NO	NO	E03-0108-05	NO	F05-3121-05 T3 15A 250V	NO	F05-2525-05 T2.5V 250V	L01-7653-05	NO	YES	C91-1439-05 C91-1443-05	NO	NO	NO
MARKET	P	1-01		YES	NO	YES	NO	NO	E03-0111-05	F04-3092-05 5A 125V	NO	NO	L01-7651-05	NO	NO	C91-0971-05	NO	NO	NO
MARKET	Y	2-91		NO	NO	YES	YES	NO	E03-0111-05	F05-3121-05 T3 15A 250V	F01-3121-05 T3 15A 250V	NO	L01-7653-05	YES	NO	C91-1421-05	YES	NO	C62-0001-05
MARKET	M	0-21		NO	YES	NO	NO	E03-0108-05	NO	F05-3121-05 T3 15A 250V	F01-3121-05 T3 15A 250V	NO	L01-7653-05	YES	NO	C91-1421-05	YES	YES	S31-2322-05
MARKET	X	0-71		YES	NO	NO	NO	NO	NO	F05-3121-05 T3 15A 250V	NO	NO	L01-7657-05	NO	NO	C91-1421-05	NO	NO	NO
MARKET	T	0-51		YES	YES	NO	NO	E03-0109-05	NO	F05-3121-05 T3 15A 250V	NO	NO	L01-7657-05	NO	NO	C91-1421-05	NO	NO	NO

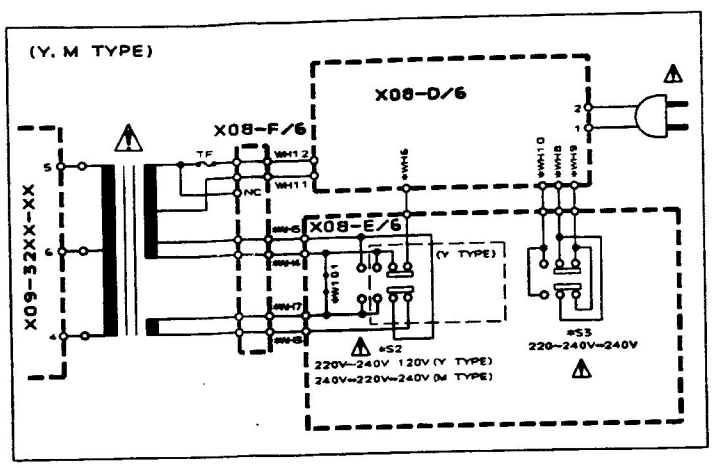
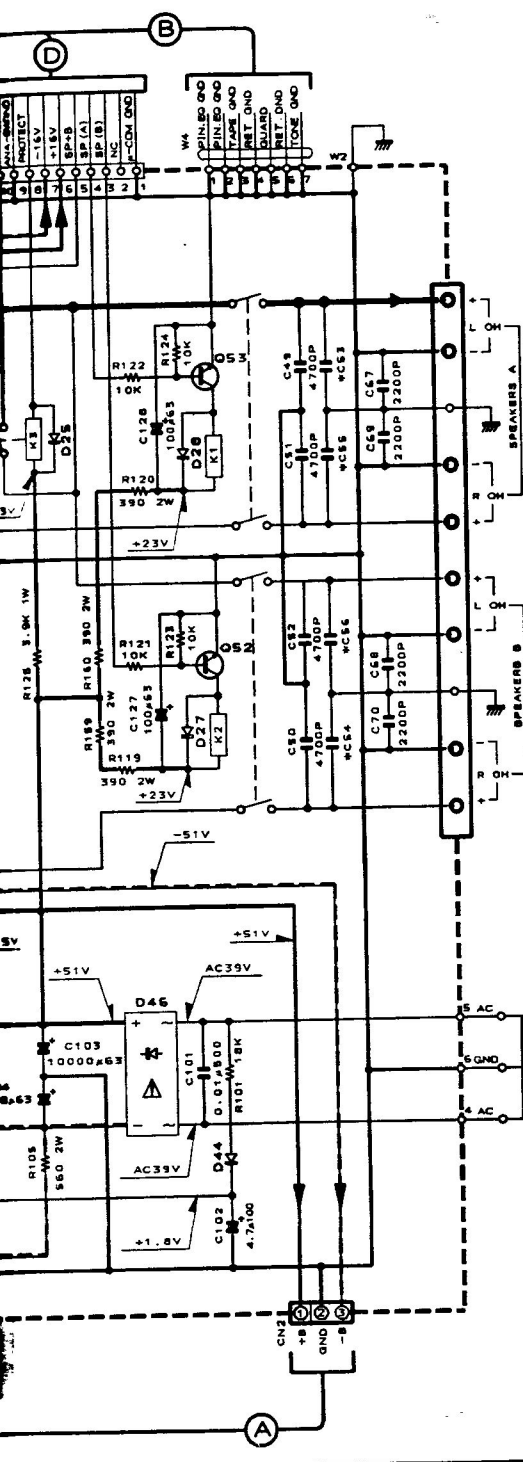

OUT PUT  
25.3V (8Ω)

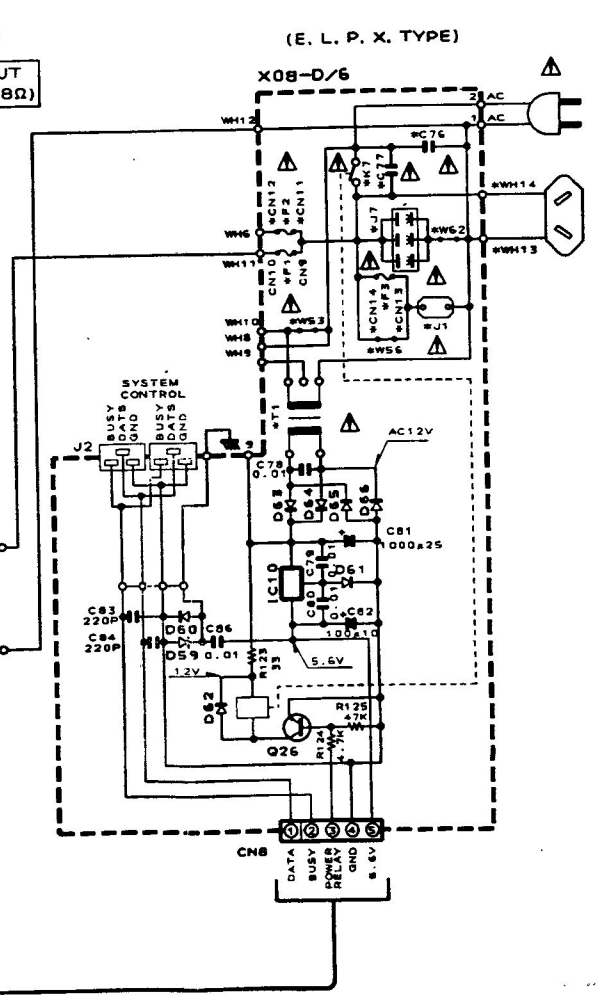

	CN11, 12	CN13, 14	-C76, 77	W3-6, 8-10	W17	S2	S3	K7	X08-E/G, F/G	W13, 14
05	NO	YES	C91-1439-05 C91-1443-05	NO	NO	NO	NO	S51-1052-05	NO	NO
12	NO	NO	C91-0571-05	NO	NO	NO	NO	S76-0002-05	NO	NO
06	YES	NO	C91-1421-05	YES	NO	C62-0001-05	S31-2131-05	S76-0002-05	YES	NO
08	YES	NO	C91-1421-05	YES	YES	S31-2522-05	S31-2131-05	S76-0002-05	YES	NO
09	NO	NO	C91-1421-05	NO	NO	NO	NO	S51-1052-05	NO	YES
08	NO	NO	C91-1421-05	NO	NO	NO	NO	S51-1052-05	NO	NO

SIGNAL LINE  
 GND LINE  
 +B LINE  
 -B LINE

## \* New Parts

Parts without Parts No. are not supplied.

Les articles non mentionnés dans le Parts No. ne sont pas fournis.

Teile ohne Parts No. werden nicht geliefert.

## No. 1

Ref. No. 参照番号	Address 位置	New Parts 新	Parts No. 部品番号	Description 部品名 / 規格	Desti- nation 仕向	Re- marks 備考
<b>KA-5040R</b>						
601	1A	*	A01-2905-01	METALLIC CABINET		
602	2A	*	A60-0101-11	PANEL ASSY		
605	1B	*	X94-1000-00	REMOTE CONTROL ASSY		
606	1B	*	A09-0115-13	BATTERY COVER		
609	3B	*	B01-0482-01	PANEL ESCUTCHEON		
612	2A	*	B43-0287-04	KENWOOD BADGE		
-	-	-	B46-0094-03	WARRANTY CARD	Y	
-	-	-	B46-0095-03	WARRANTY CARD	Y	
-	-	-	B46-0096-23	WARRANTY CARD	X	
-	-	-	B46-0121-03	WARRANTY CARD	P	
-	-	-	B46-0122-13	WARRANTY CARD	EL	
-	-	-	B46-0143-13	WARRANTY CARD	T	
-	-	-	B58-0513-04	CAUTION CARD (PRESET220-240)	T	
-	-	*	B60-0555-00	INSTRUCTION MANUAL (ENGLISH)	Y	
-	-	*	B60-0556-00	INSTRUCTION MANUAL (FRENCH)	EPL	
-	-	*	B60-0557-00	INSTRUCTION MANUAL (CHINESE)	M	
-	-	*	B60-0558-00	INSTRUCTION MANUAL (GE, DU, IT)	EL	
-	-	*	B60-0665-00	INSTRUCTION MANUAL (SPANISH)	M	
613	3C	*	D21-165B-03	EXTENSION SHAFT		
△ 615	1B	*	B03-0115-05	AC PLUG ADAPTER	M	
△ 616	1D	*	E30-0459-05	AC POWER CORD	EML	
△ 616	1D	*	E30-0812-05	AC POWER CORD	Y	
△ 616	1D	*	E30-0974-05	AC POWER CORD	P	
△ 616	1D	*	E30-1341-05	AC POWER CORD	X	
△ 616	1D	*	E30-1416-05	AC POWER CORD	T	
△ 618	3C	*	E35-0147-05	FLAT CABLE (X08CN1-X08CN2) 27P		
△ 619	2B, 3B	*	E35-0148-05	FLAT CABLE (X08CN3-X11CN1) 21P		
-	-	*	E03-0114-05	AC OUTLET	X	
620	2A	*	G11-1372-04	SOFT TAPE		
-	-	*	H50-0126-04	ITEM CARTON CASE		
-	-	*	H10-5166-02	POLYSTYRENE FOAMED FIXTURE (L)		
-	-	*	H10-5167-02	POLYSTYRENE FOAMED FIXTURE (R)		
-	-	*	H25-0225-04	PROTECTION BAG (850X450X0.03)		
-	-	*	H25-0232-04	PROTECTION BAG (235X350X0.03)	EPYMXL BPYMXL	
-	-	*	H25-0651-04	PROTECTION BAG (0232 PRINTED)	T	
-	-	*	H25-0654-04	PROTECTION BAG (0225 PRINTED)	T	
624	3C	*	J02-1072-05	FOOT		
625	2D	*	J19-0581-05	UNIT HOLDER		
626	2B	*	J19-3328-15	UNIT HOLDER		
△ 629	1D	*	J42-0083-05	POWER CORD BUSHING		
-	-	*	J61-0307-05	WIRE BAND		
630	3B	*	K29-3405-04	KNØB CARTRIDGE		
631	2A	*	K29-4210-03	KNØB POWER		
632	3A	*	K29-4213-04	KNØB ASSY MASTER VOLUME		
633	3A	*	K29-4212-04	KNØB INPUT SELECTOR		
634	3A	*	K29-4216-04	KNØB TONE, BAL, RECOUT SBL		
△ 640	1C	*	L07-0360-05	POWER TRANSFORMER	E	
△ 640	1C	*	L07-0361-05	POWER TRANSFORMER	P	
△ 640	1C	*	L07-0363-05	POWER TRANSFORMER	YM	
△ 640	1C	*	L07-0364-05	POWER TRANSFORMER	XT	
640	1C	*	L07-0464-05	POWER TRANSFORMER	L	

L:Scandinavia K:USA P:Canada  
Y:PX(Far East, Hawaii) T:England E:Europe  
Y:AAFES(Europe) X:Australia M:Other Areas

△ indicates safety critical components.

## \* New Parts

Parts without Parts No. are not supplied.

Les articles non mentionnés dans le Parts No. ne sont pas fournis.

Teile ohne Parts No. werden nicht geliefert.

## No. 2

Ref. No. 参照番号	Address 位置	New Parts 新	Parts No. 部品番号	Description 部品名 / 規格	Desti- nation 仕向	Re- marks 備考
645	1D	*	N08-0128-35	BINDING POST (EARTH)		
A	2D	*	N09-0333-05	TAPPING SCREW (3X12)		
B	1D	*	N09-1280-05	TAPTITE SCREW (3X8)		
C	2A, 2B	*	N09-1445-05	SBT SCREW (M3X8)		
D	2C, 1D	*	N09-1777-05	TAPTITE SCREW		
E	1A	*	N09-2768-05	TAPTITE SCREW (4X8)		
F	1C	*	N29-0268-05	PUSH RIVET		
G	1A, 1D	*	N89-3008-45	BINDING HEAD TAPTITE SCREW		
H	2B	*	N89-3008-46	BINDING HEAD TAPTITE SCREW		
J	3C	*	N89-4D10-45	BINDING HEAD TAPTITE SCREW		
Q33, 34	-	*	2SC4137P19(V, W)	TRANSISTOR		
Q35 -38	-	*	2SC4467LB*5	TRANSISTOR		
Q39 -42	-	*	2SA1694LB*5	TRANSISTOR		
<b>PRE-AMPLIFIER UNIT (X08-246X-XX)</b>						
C1 -18	-	*	CF92FV1H181K	MF 150PF	K	
C19, 20	-	*	CF92FV1H101K	MF 100PF	K	
C21, 22	-	*	CF92FV1H122J	MF 1200PF	J	
C23, 24	-	*	CC45FSL1H560J	CERAMIC 56PF	J	
C25, 26	-	*	CF92FV1H472J	MF 4700PF	J	
C27, 28	-	*	C90-1951-05	ALUMINIUM ELECTROLYTIC C.		
C29, 30	-	*	CF92FV1H393J	MF 0.039UF	J	
C31, 32	-	*	CF92FV1H113J	MF 0.011UF	J	
C33, 34	-	*	C90-1920-05	ELECTRO 10UF	25WV	
C35, 36	-	*	CF92FV1H332J	MF 3300PF	J	
C37, 38	-	*	CF92FV1H223J	MF 0.022UF	J	
C55 -60	-	*	CB04KW1V330M	ELECTRO 33UF	35WV	
C61	-	*	CF92FV1H101K	MF 100PF	K	
C63, 64	-	*	CB04KW1B101M	ELECTRO 100UF	25WV	
C65, 66	-	*	CB04KW1B470M	ELECTRO 47UF	25WV	
C67, 68	-	*	CF92FV1H122J	MF 1200PF	J	
C69	-	*	CB04KW1B101M	ELECTRO 100UF	25WV	
C70	-	*	CB04KW1V470M	ELECTRO 47UF	35WV	
C71	-	*	CB04KW1B470M	ELECTRO 47UF	25WV	
C72 -75	-	*	CB04KW1B101M	ELECTRO 100UF	25WV	
△ C76, 77	-	*	C91-0971-05	FILM 0.01UF	250WV	P
△ C76, 77	-	*	C91-1421-05	FILM 0.01UF	250AC	BYMXL
C78 -80	-	*	CK45FF1H103Z	CERAMIC 0.010UF	Z	
C81	-	*	CB04KW1B102M	ELECTRO 1000UF	25WV	
C82	-	*	CB04KW1A101M	ELECTRO 100UF	10WV	
C83, 84	-	*	CC45FSL1H221J	CERAMIC 220PF	J	
C85	-	*	CB04KW1V100M	ELECTRO 10UF	35WV	
C86	-	*	CK45FF1H103Z	CERAMIC 0.010UF	Z	
C87	-	*	CK45FF1H473Z	CERAMIC 0.047UF	Z	
C89 -92	-	*	CF92FV1H101K	MF 100PF	K	
C93, 94	-	*	CF92FV1H103J	MF 0.010UF	J	
△ J1	-	*	B03-0108-05	AC OUTLET	EML	
△ J1	-	*	B03-0109-05	AC OUTLET	T	
J2	-	*	B11-0188-05	MINIATURE PHONE JACK SYSTEM		
J3	-	*	B13-0294-05	PHONE JACK PHONE		
J4 -6	-	*	B13-0634-05	PHONE JACK 1/8 TERMINAL		
△ J7	-	*	B03-0111-05	AC OUTLET	PY	
F1	-	*	FD4-5022-05	FUSE (UL) (125V 5A UL)	P	
F1	-	*	FD5-3121-05	FUSE (SEMKO) (250V T3.15A)	BXTL	

L:Scandinavia K:USA P:Canada  
Y:PX(Far East, Hawaii) T:England E:Europe  
Y:AAFES(Europe) X:Australia M:Other Areas

△ indicates safety critical components.

PARTS LIST

KA-5040R

\* New Parts  
 Parts without Parts No. are not supplied.  
 Les articles non mentionnés dans le Parts No. ne sont pas fournis.  
 Teile ohne Parts No. werden nicht geliefert.

No. 3

Ref. No. 参照番号	Address 位置	New Parts 新	Parts No. 部品番号	Description 部品名 / 規格	Desti- nation 仕向	Re- marks 備考
F1 ,2 F3			F05-3121-05 F05-2525-05	FUSE (SEMKO) (250V T3.15A) FUSE (SEMKO) (250V T2.5A)	YM EL	
CN9 -12 CN9 ,10 CN13,14			J13-0075-05 J13-0075-05 J13-0075-05	FUSE CLIP FUSE CLIP FUSE CLIP	YM EPXTL EL	
L1 ,2 T1 T1			L40-1011-47 L01-7651-05 LD1-7653-05 LD1-7657-05	SMALL FIXED INDUCTOR (IDDUH,K) POWER TRANSFORMER POWER TRANSFORMER POWER TRANSFORMER	P EYML XT	
CP1 R67 ,68 R69 ,70 R101 R102			R90-0804-05 RN14BK2C08252FTS RN14BK2C6811FTS RS14DB3D271JTE RS14DB3D331JTE	MULTI-COMP 47KX8 J 1/4W RN 82.5K F 1/8W RN 6.81K F 1/6W FL-PROOF RS 27D J 2W FL-PROOF RS 33D J 2W		
R108 R109 R110, I11 R112, I13 R114		*	RD14AB2E1D1JTS RD14AB2E822JTS RS14DB3D221JTE RS14DB3D181JTE RD14AB2E682JTS	FL-PROOF RD 100 J 1/4W FL-PROOF RD 8.2K J 1/4W FL-PROOF RS 22D J 2W FL-PROOF RS 180 J 2W FL-PROOF RD 6.8K J 1/4W		
R115 R116, I17 R123 R126 R131, I32			RD14AB2E471JTS RD14AB2E1D0JTS RD14AB2E330JTS RD14AB2E222JTS RD14AB2E332JTS	FL-PROOF RD 47D J 1/4W FL-PROOF RD 1D J 1/4W FL-PROOF RD 33 J 1/4W FL-PROOF RD 2.2K J 1/4W FL-PROOF RD 3.3K J 1/4W		
R133 R134, I35 VR1		*	RD14AB2E471JTS RS14DB3D221JTE R29-5D59-05	FL-PROOF RD 470 J 1/4W FL-PROOF RS 220 J 2W POTENTIOMETER VOLUME CONTROL		
K1 -6 K7 K7 S1 S2			S51-2089-05 S51-1D52-05 S76-DDD2-05 S40-6036-05 S31-2322-05	MAGNETIC RELAY MAGNETIC RELAY MAGNETIC RELAY PUSH SWITCH CARTRIDGE SLIDE SWITCH VOLTAGE SELECT	EXTL PYM M	
S2 S3			S62-0DD1-05 S31-2131-05	SLIDE SWITCH VOLTAGE SELECT SLIDE SWITCH VOLTAGE SELECT	Y YM	
D1 ,2 D1 ,2 D5 -12 D5 -12 D13 -30			HSS104 ISS133 HSS104 ISS133 MA177	DIODE DIODE DIODE DIODE DIODE		
D31 D32 D32 D33			HZS20S(B) RD20JS(B) HZS5.1S(B2) RD5.1JS(B2) HZS20S(B)	ZENER DIODE ZENER DIODE ZENER DIODE ZENER DIODE ZENER DIODE		
D33 D49 -54 D49 -54 D55 ,56 D55 ,56			RD20JS(B) HZS11N(B2) RD11ES(B2) HZS30N(B) RD30ES(B)	ZENER DIODE ZENER DIODE ZENER DIODE ZENER DIODE ZENER DIODE		
D57 D57 D58 D58			HZS13N(B2) RD13ES(B2) HZS30N(B) RD30ES(B)	ZENER DIODE ZENER DIODE ZENER DIODE ZENER DIODE		

\* New Parts  
 Parts without Parts No. are not supplied.  
 Les articles non mentionnés dans le Parts No. ne sont pas fournis.  
 Teile ohne Parts No. werden nicht geliefert.

No. 4

Ref. No. 参照番号	Address 位置	New Parts 新	Parts No. 部品番号	Description 部品名 / 規格	Desti- nation 仕向	Re- marks 備考
D59 -61 D59 -61 D62 D62 D63 -66			HSS104 ISS133 HSS104A ISS131 S5688B	DIODE DIODE DIODE DIODE DIODE		
D67 ,68 D67 ,68 IC1 IC2 -6 IC7 ,8			HSS104 ISS133 NJM4565D-D LC4966 ON3134	DIODE DIODE IC(OP AMP X2) IC(CMOS LOGIC BILATERAL SW) IC(OPTICAL ISOLATOR)		
IC9 IC10 IC10 IC10 IC11 Q1 -4			TA84D9S TA78D5S UPC78D5HF NJM4558D 2SC174DS(Q,R)	IC(MOTOR CONTROL) IC(VOLTAGE REGULATOR / +5V) IC(VOLTAGE REGULATOR / +5V) IC(OP AMP X2) TRANSISTOR		
Q1 -4 Q5 -8 Q5 -8 Q11 Q12			2SC3311A(Q,R) 2SK170(BL) 2SK170(V) 2SC2590(Q,R) 2SA111D(Q,R)	TRANSISTOR FET FET TRANSISTOR TRANSISTOR		
Q13 ,14 Q15 Q15 Q16 Q16			2SC2590(Q,R) DTC124ES UN4212 DTA124ES UN4112	TRANSISTOR DIGITAL TRANSISTOR DIGITAL TRANSISTOR DIGITAL TRANSISTOR DIGITAL TRANSISTOR		
Q17 -23 Q17 -23 Q24 ,25 Q26 Q26			DTC124ES UN4212 2SD1266(Q,P) 2SC174DS(Q,R) 2SC3311A(Q,R)	DIGITAL TRANSISTOR DIGITAL TRANSISTOR TRANSISTOR TRANSISTOR TRANSISTOR		
Q27 ,28			2SC2878(B)	TRANSISTOR		
<b>AUDIO UNIT (X09-320X-XX)</b>						
C1 ,2 C3 ,4 C5 -8 C9 ,10 C11 ,12			CF92FV1H1D5J CF92FV1H1D1K CF92FV1H331K CF92FV1H1D5J CF92FV1H122J	MF 1.0UF J MF 100PF K MF 330PF K MF 1.0UF J MF 1200PF J		
C13 ,14 C15 ,16 C17 -20 C23 ,24 C25 ,26			CF92FV1H331K C90-1917-05 CC45FSL1H47DJ CC45FSL2H27DJ CF92FV1H103J	MF 330PF K ELECTRO 100UF 16WV CERAMIC 47PF J CERAMIC 27PF J MF 0.010UF J		
C27 ,28 C29 -32 C33 C35 C35 -38			CC45FSL1H220J CF92FV1H331K CE04DW1J101M CE04KW2A2R2M CE04KW2A2R2M	CERAMIC 22PF J MF 330PF K ELECTRO 100UF 63WV ELECTRO 2.2UF 100WV ELECTRO 2.2UF 100WV		EYMXTL P
C38 C39 ,40 C41 ,42 C43 ,44 C45 -48			CE04KW2A2R2M CF92FV1H471J CF92FV1H333J CF92FV1H124J CF92FV1H104J	ELECTRO 2.2UF 100WV MF 470PF J MF 0.033UF J MF 0.12UF J MF 0.10UF J		EYMXTL
C49 -52 C53 -56			CF92FV1H472J CF92FV1H561J	MF 4700PF J MF 560PF J		

参照番号	位置	部品番号	部品名/規格	仕向	備考
C57 -60		CE04KW2A2R2M	ELECTRO 2.2UF 100WV	P	
C58 ,59		CE04KW2A2R2M	ELECTRO 2.2UF 100WV	EYMXTL	
C61 ,62		CF92FV1H104J	MF 0.10UF J		
C63 ,64		CF92FV1H473J	MF 0.047UF J		
C65 ,66		CF92FV1H221K	MF 220PF K		
C67 -70		CF92FV1H222J	MF 2200PF J		
C101		CK45FE2H103P	CERAMIC 0.010UF P		
C102		CE04KW2A4R7M	ELECTRO 4.7UF 100WV		
C103,104		C90-1822-05	ELECTRO 10000UF 63WV		
C106,107		CE04KW1J331M	ELECTRO 330UF 63WV		
C108		CE04KW1A101M	ELECTRO 100UF 10WV		
C109		CF92FV1H104J	MF 0.10UF J		
C110		CE04KW1E471M	ELECTRO 470UF 25WV		
C111		CF92FV1H104J	MF 0.10UF J		
C112		CE04KW1E471M	ELECTRO 470UF 25WV		
C113,114		CF92FV1H103J	MF 0.010UF J		
C123		CE04KW1C330M	ELECTRO 33UF 16WV		
C125		C90-1333-05	NP-BLBC 22UF 10WV		
C126		CE04KW1C220M	ELECTRO 22UF 16WV		
C127,128		CE04W1J101M	ELECTRO 100UF 63WV		
C130		CF92FV1H105J	MF 1.0UF J		
C131		CE04KW1J221M	ELECTRO 220UF 63WV		
C147		CE04KW1J221M	ELECTRO 220UF 63WV		
C149		CK45FF1H103Z	CERAMIC 0.010UF Z		
E1		E20-0839-15	SCREW TERMINAL BOARD SPEAKERS	EYMXTL	
E1		E20-0840-15	SCREW TERMINAL BOARD SPEAKERS		
-		J11-0098-05	WIRE CLAMPER		
L1 ,2		L39-0080-15	PHASE-COMPENSATION COIL		
CP1 -4		R90-0187-05	MULTI-COMP 0.22X2 K 5W		
R21 ,22		RD14AB2E221JTS	FL-PROOF RD 220 J 1/4W		
R23 ,24		RS140B3A822JTE	FL-PROOF RS 8.2K J 1W		
R25 ,26		RD14AB2E181JTS	FL-PROOF RD 180 J 1/4W		
R37 -40		RD14AB2E391JTS	FL-PROOF RD 390 J 1/4W		
R41 ,42		RD14AB2E122JTS	FL-PROOF RD 1.2K J 1/4W		
R43 ,44		RD14AB2E221JTS	FL-PROOF RD 220 J 1/4W		
R45		RS14CB3A101JKW	FL-PROOF RS 100 J 1W		
R47 -50		RD14AB2E4R7JTS	FL-PROOF RD 4.7 J 1/4W		
RS1		RD14CB2E4R7JTS	FL-PROOF RD 4.7 J 1/4W		
RS2 -54		RD14AB2E4R7JTS	FL-PROOF RD 4.7 J 1/4W		
RS5 ,56		RD14AB2E821JTS	FL-PROOF RD 820 J 1/4W		
RS7 -60		RD14AB2E681JTS	FL-PROOF RD 680 J 1/4W		
R61 ,62		RD14AB2E102JTS	FL-PROOF RD 1.0K J 1/4W		
R63 -66		RD14AB2E101JTS	FL-PROOF RD 100 J 1/4W		
R71 ,72		RS14CB3A100JKW	FL-PROOF RS 10 J 1W		
R73 ,74		RD14AB2E2R2JTS	FL-PROOF RD 2.2 J 1/4W		
R75 ,76		RD14AB2E330JTS	FL-PROOF RD 33 J 1/4W		
R77 ,78		RS14CB3A100JKW	FL-PROOF RS 10 J 1W		
R79 ,80		RD14AB2E101JTS	FL-PROOF RD 100 J 1/4W		
R87 ,88		RS14CB3A101JKW	FL-PROOF RS 100 J 1W		
R103		RS14DB3D561JTE	FL-PROOF RS 560 J 2W		
R105		RS140B3D561JTE	FL-PROOF RS 560 J 2W		
R119,120		RS14DB3D391JTE	FL-PROOF RS 390 J 2W		
R125		RS14DB3A392JTE	FL-PROOF RS 3.9K J 1W		

L:Scandinavia K:USA P:Canada  
 Y:PX(Far East, Hawaii) T:England E:Europe  
 Y:AAFES(Europe) X:Australia M:Other Areas

△ indicates safety critical components

参照番号	位置	部品番号	部品名/規格	仕向	備考
R159,160		RS14DB3D391JTE	FL-PROOF RS 390 J 2W		
R173,174		RN14BK2E1001FTS	TRIM POT. 1.00K F 1/4W		
VR1 ,2		R12-1085-05	TRIM POT. 2.2K		
K1 ,2		SS1-2096-05	MAGNETIC RELAY		
K3		SS1-2090-05	MICRO SWITCH		
D3 ,4		HSS104	DIODE		
D3 ,4		1SS133	DIODE		
D7 ,8		MA27Q(A)	VARISTOR		
D9 -12		HSS104A	DIODE		
D9 -12		1SS131	DIODE		
D21		HSS104	DIODE		
D21		1SS133	DIODE		
D22		HZS5.1S(B2)	ZENER DIODE		
D22		RD5.1JS(B2)	ZENER DIODE		
D25		HSS104A	DIODE		
D25		1SS131	DIODE		
D26		HSS104	DIODE		
D26		1SS133	DIODE		
D27 ,28		HSS104A	DIODE		
D27 ,28		1SS131	DIODE		
D29		HZS5.1S(B2)	ZENER DIODE		
D29		RD5.1JS(B2)	ZENER DIODE		
D30 ,31		HZS6.8N(B2)	ZENER DIODE		
D30 ,31		RD6.8ES(B2)	ZENER DIODE		
D44		SS6888	DIODE		
D46		DSFB20*1	DIODE		
D47 ,48		HZS6.8N(B2)	ZENER DIODE		
D47 ,48		RD6.8ES(B2)	ZENER DIODE		
D49 -51		HSS104	DIODE		
D49 -51		1SS133	DIODE		
IC1		UPC1237HA	IC(POWER AMP)		
IC2		NJM4565D	IC(OP AMP X2)		
Q1 -8		2SA992(F,E)	TRANSISTOR		
Q9 ,10		2SA733(A)(Q,P)	TRANSISTOR		
Q9 ,10		2SA933S(Q,R)	TRANSISTOR		
Q15 -18		2SC2632(R,S)	TRANSISTOR		
Q19 ,20		2SA1124(R,S)	TRANSISTOR		
Q21 ,22		2SC2631(R,S)	TRANSISTOR		
Q23 ,24		2SA1123(R,S)	TRANSISTOR		
Q25 ,26		2SC3944(R,S)	TRANSISTOR		
Q27 ,28		2SA1535(R,S)	TRANSISTOR		
Q29 ,30		2SC1845(F,E)	TRANSISTOR		
Q31 ,32		2SA992(F,E)	TRANSISTOR		
Q52 ,53		2SC1845(F,E)	TRANSISTOR		
Q54		2SA733(A)(Q,P)	TRANSISTOR		
Q54		2SA933S(Q,R)	TRANSISTOR		
Q55		2SA992(F,E)	TRANSISTOR		
Q56		2SD1266(Q,P)	TRANSISTOR		
Q57		2SB941(Q,P)	TRANSISTOR		
<b>CONTROL UNIT (X11-3112-70)</b>					
D14 -25		B30-1291-05	LED		
C3 -6		CF92FV1H222J	MF 0.22UF J		
C7 ,8		CF92FV1H203J	MF 0.020UF J		

L:Scandinavia K:USA P:Canada  
 Y:PX(Far East, Hawaii) T:England E:Europe  
 Y:AAFES(Europe) X:Australia M:Other Areas

△ indicates safety critical components

PARTS LIST

KA-5040R

## \* New Parts

Parts without Parts No. are not supplied.

Les articles non mentionnés dans le Parts No. ne sont pas fournis.

Teile ohne Parts No. werden nicht geliefert.

No. 7

Ref. No. 参照番号	Address 位置	New Parts 新	Parts No. 部品番号	Description 部品名 / 規格	Desti- nation 向	Re- marks 備考
C9 ,10			CF92FV1H683J	MF 0.068UF J		
C11 ,12			CF92FV1H334J	MF 0.33UF J		
C15 ,16		*	C90-1886-05	ELECTRO 4.7UF 25WV		
C17 ,18			CF92FV1H391K	MF 390PF K		
C19 ,20			CF92FV1H154J	MF 0.15UF J		
C21 ,22			CF92FV1H221K	MF 220PF K		
C23 ,24			CF92FV1H101K	MF 100PF K		
C25 ,26			CF92FV1H471J	MF 470PF J		
C27 ,28			CF92FV1H102J	MF 1000PF J		
C29 -34			CE04KW1H010M	ELECTRO 1.0UF 50WV		
C35 -38			CE04KW1C220M	ELECTRO 22UF 16WV		
C39 -42			CF92FV1H473J	MF 0.047UF J		
C43 ,44			CE04KW1E101M	ELECTRO 100UF 25WV		
C45			CK45FF1H103Z	CERAMIC 0.010UF Z		
C46			CC45FSL1H101J	CERAMIC 100PF J		
C47 ,48			CF92FV1H102J	MF 1000PF J		
C49			C90-1826-05	BACKUP 0.047UF 5.5WV		
C50			CK45FF1H103Z	CERAMIC 0.010UF Z		
C51			CE04KW1H0R1M	ELECTRO 0.1UF 50WV		
C52 ,53			CK45FB1H332K	CERAMIC 3300PF K		
C55			CE04KW1V4R7M	ELECTRO 4.7UF 35WV		
C56			CE04KW1H010M	ELECTRO 1.0UF 50WV		
C57			CE04KW1A101M	ELECTRO 100UF 10WV		
C58			CE04KW1V4R7M	ELECTRO 4.7UF 35WV		
C64			CE04KW1A101M	ELECTRO 100UF 10WV		
C67			CK45FF1H103Z	CERAMIC 0.010UF Z		
C68 ,69			CF92FV1H104J	MF 0.10UF J		
J1		*	E11-0208-05	PHONE JACK HEAD PHONES		
L3 ,4			L40-1021-14	SMALL FIXED INDUCTOR(1.0MH,K)		
X1			L78-0267-05	RESONATOR 4.19MHZ		
R51 ,52			RS140830221JTE	FL-PROOF RS 220 J 2W		
R53 ,54			RS140830151JTE	FL-PROOF RS 150 J 2W		
R55 ,56			RS140830221JTE	FL-PROOF RS 220 J 2W		
VR1		*	R06-5190-05	POTENTIOMETER BALANCE		
VR2 ,3		*	R06-2025-05	POTENTIOMETER BASS, TREBLE		
S1 -6			S40-1064-05	PUSH SWITCH		
S7		*	S60-0010-05	ROTARY SWITCH REC OUT SELECT		
S8			S29-2035-05	ROTARY SWITCH SPEAKERS		
S9		*	T99-0521-05	ROTARY ENCODER INPUT SELECTOR		
D1			HSS104A	DIODE		
D1			1SS131	DIODE		
D2 -13			HSS104	DIODE		
D2 -13			1SS133	DIODE		
D26 ,27			HSS104	DIODE		
D26 ,27			1SS133	DIODE		
IC1			NJM4565D-0	IC(OP AMP X2)		
IC2			NJM4580D-0	IC		
IC3			NJM4565D-0	IC(OP AMP X2)		
IC4			TC9163N	IC(BILATERAL SWITCH X16)		
IC5		*	UPD75104CF-778	IC(MICROPROCESSOR)		
IC6			PST529D	IC(SYSTEM RESET)		
Q1 ,2			2SC1740S(O,R)	TRANSISTOR		

## \* New Parts

Parts without Parts No. are not supplied.

Les articles non mentionnés dans le Parts No. ne sont pas fournis.

Teile ohne Parts No. werden nicht geliefert.

No.8

Ref. No. 参照番号	Address 位置	New Parts 新	Parts No. 部品番号	Description 部品名 / 規格	Desti- nation 向	Re- marks 備考
Q1 ,2			2SC3311A(O,R)	TRANSISTOR		
Q3 ,4			DTA124ES	DIGITAL TRANSISTOR		
Q3 ,4			UN4112	DIGITAL TRANSISTOR		
A1			W02-1046-05	ELECTRIC CIRCUIT MODULE		

KA-5040R

PARTS LIST