

EXTERNAL VIEW/ADJUSTMENT/REGLAGES/ABGLEICH

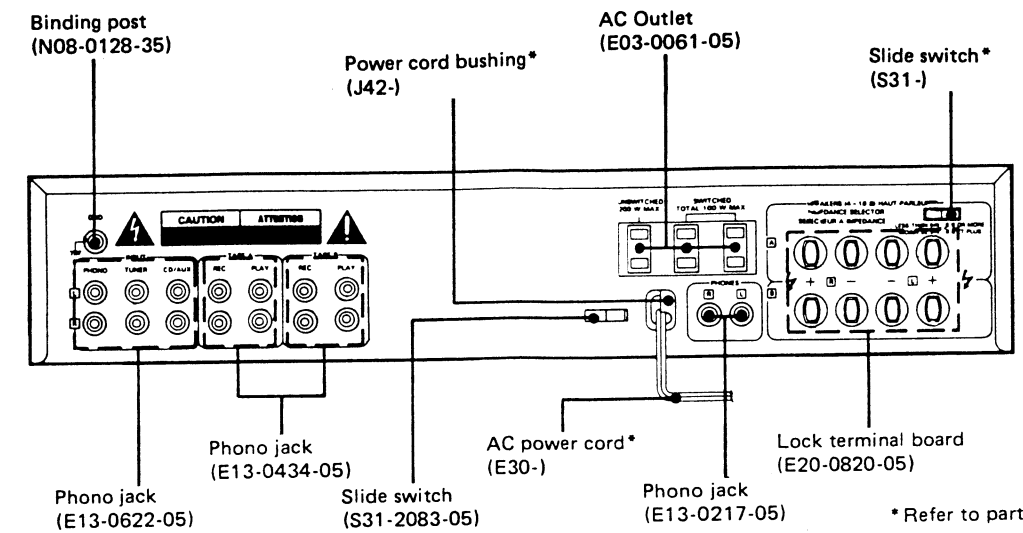

ADJUSTMENT

NO.	ITEM	INPUT SETTINGS	OUTPUT SETTINGS	AMPLIFIER SETTINGS	ALIGNMENT POINTS	ALIGN FOR	FIG.
1	IDLE CURRENT	—	Connect a DC voltmeter across R49 (R50)	VOLUME : 0	VR1 (L) VR2 (R)	15~20mV	(a)

REGLAGES

N°	ITEM	REGLAGE DE L'ENTREE	REGLAGE DE LA SORTIE	REGLAGE DE L'AMPLIFICATEUR	POINTS L'ALIGNMENT	ALIGNER POUR	FIG.
1	REGLAGE DU COURANT DE POLARISATION	—	Connecter un voltmètre CC Sur R49(R50)	VOLUME : 0	VR1 (G) VR2 (D)	15~20mV	(a)

ABGLEICH

NR.	GEGENSTAND	EINGANGS-EINSTELLUNG	AUSGANGS-EINSTELLUNG	VORSTÄRKER EINSTELLUNG	ABGLEICH-PUNKTE	ABGLEICHEN FÜR	ABB.
1	LEERLAUFSTROM	—	Einen Gleichspannungsmesser über R49(R50) anschließen	VOLUME : 0	VR1 (L) VR2 (R)	15~20mV	(a)

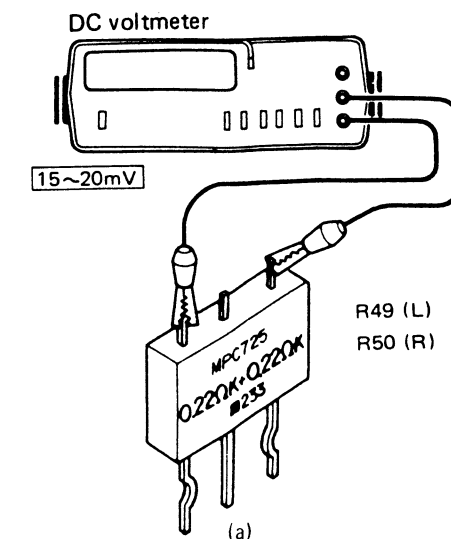

KA-52/72 KA-52/72

PC BOARD

TONE AMP (X11-1930-11) Component side view

() : KA-52

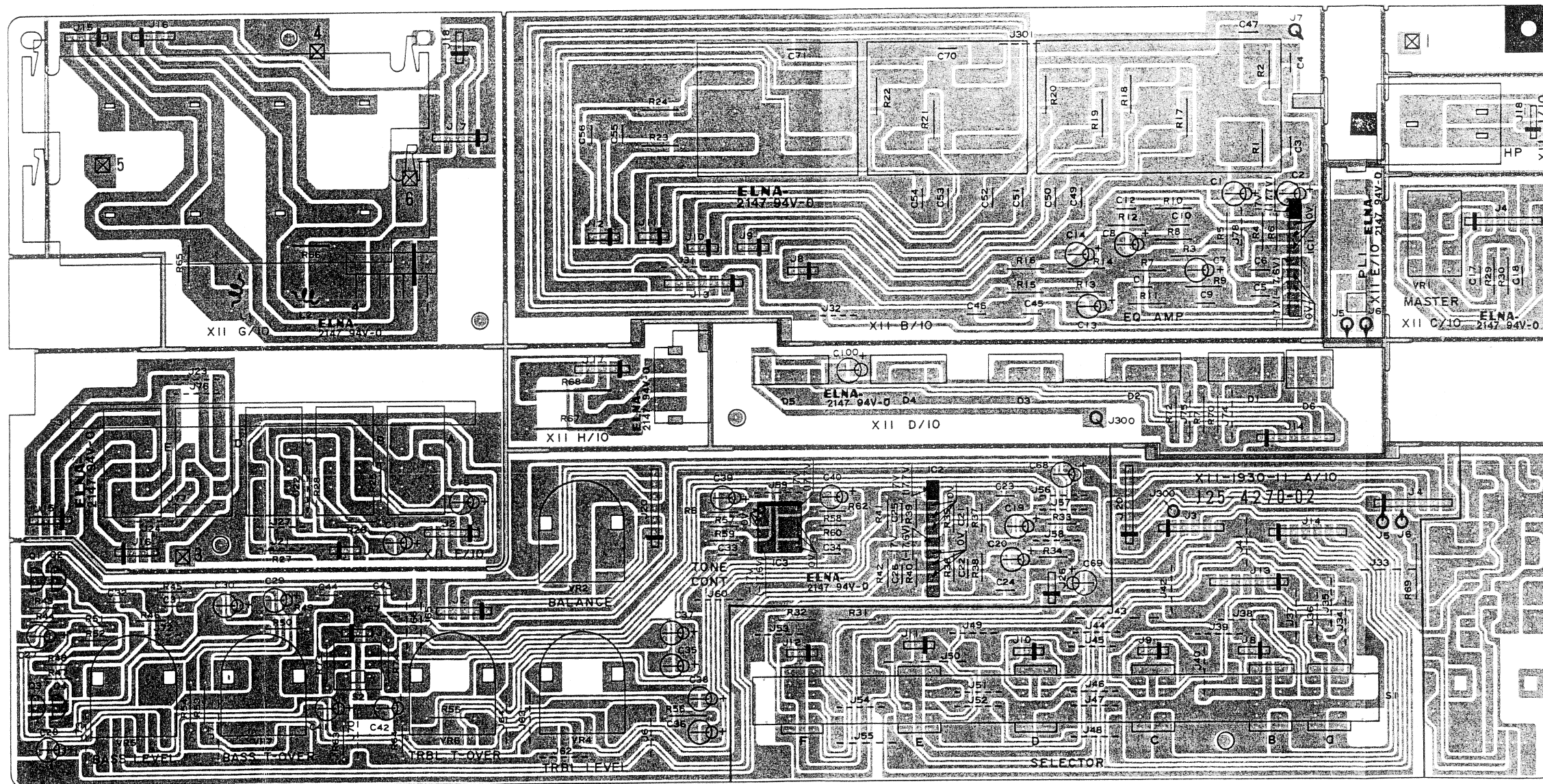

Refer to the schematic diagram for the values of resistors and capacitors.
The PC board drawing is viewing from the side easy to check.

KA-52/72 KA-52/72

PC BOARD

POWER SUPPLY (X13-4340-11)
Component side view

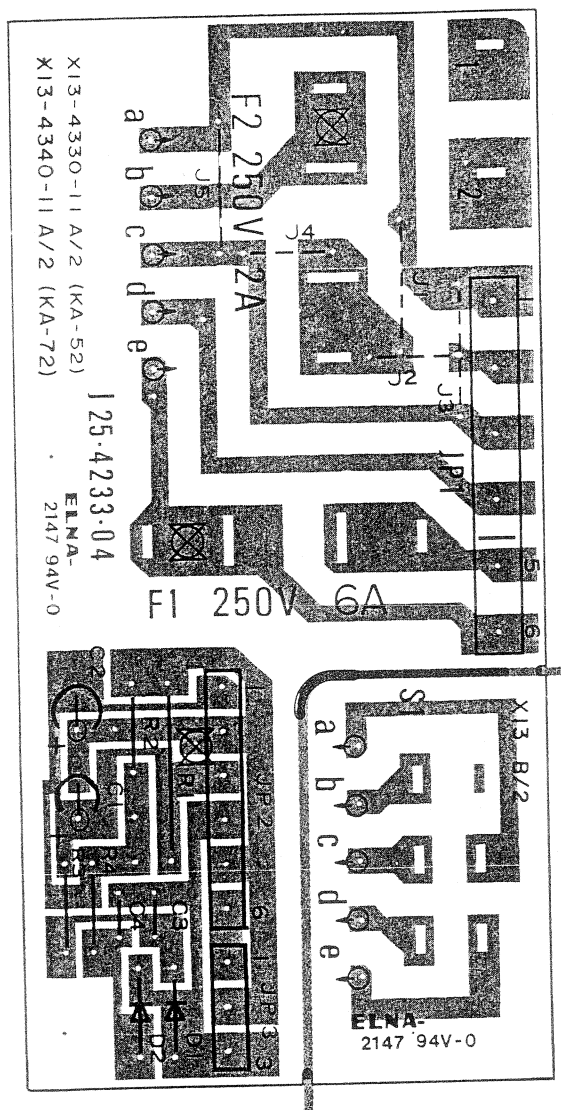

POWER AMP (X07-2090-12) Component side view

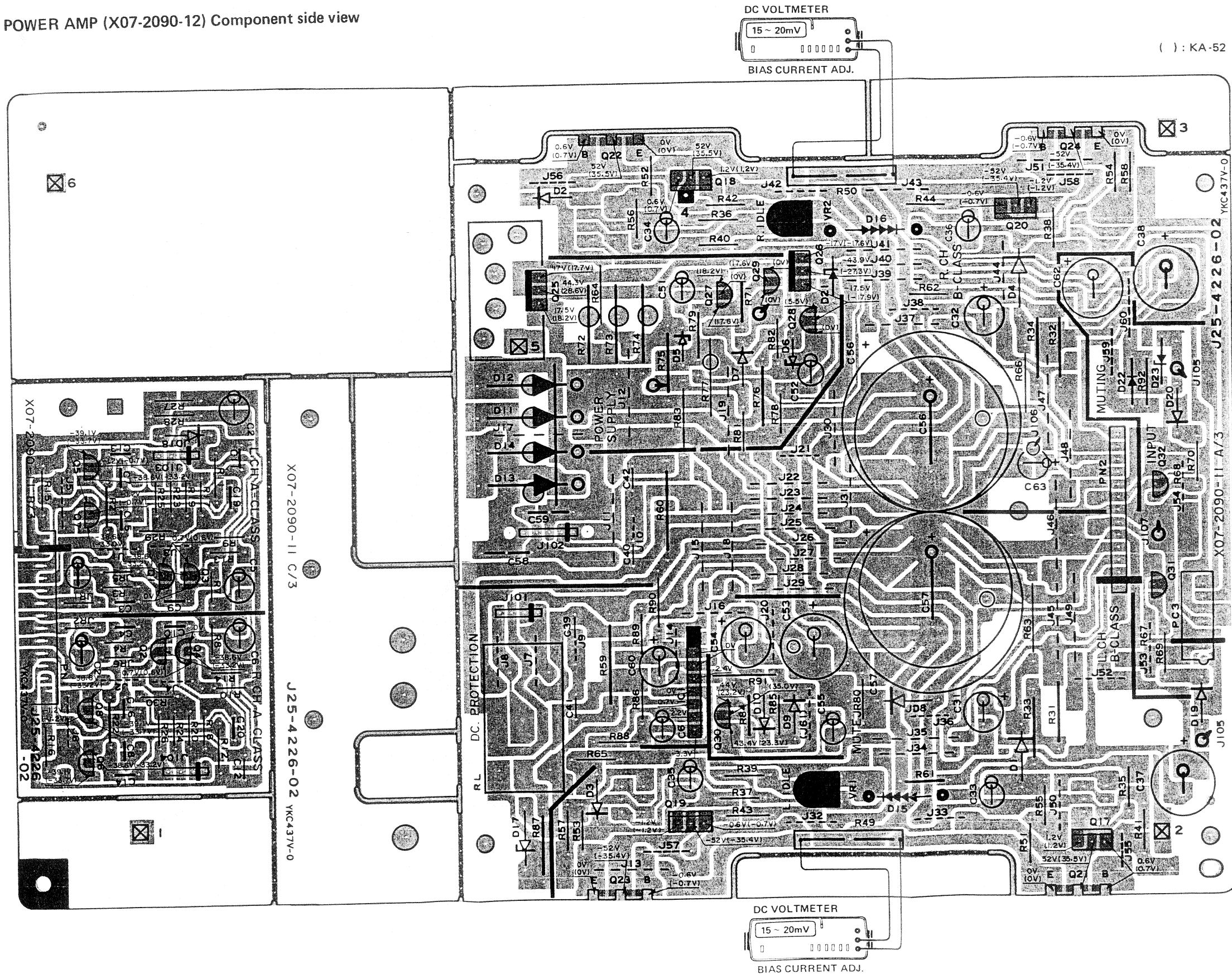

() : KA-52

Refer to the schematic diagram for the values of resistors and capacitors.
The PC board drawing is viewing from the side easy to check.

2SA992
2SA999
2SC1685
2SC1845
2SC2320
2SC945

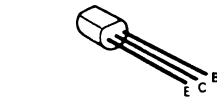

2SA1110
2SC2590



2SA957
2SA2167

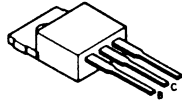

2SA1105*1
2SC2580*1

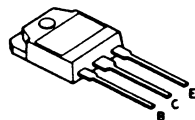

AN6555

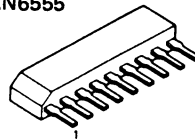

LA6458SS



AN6556

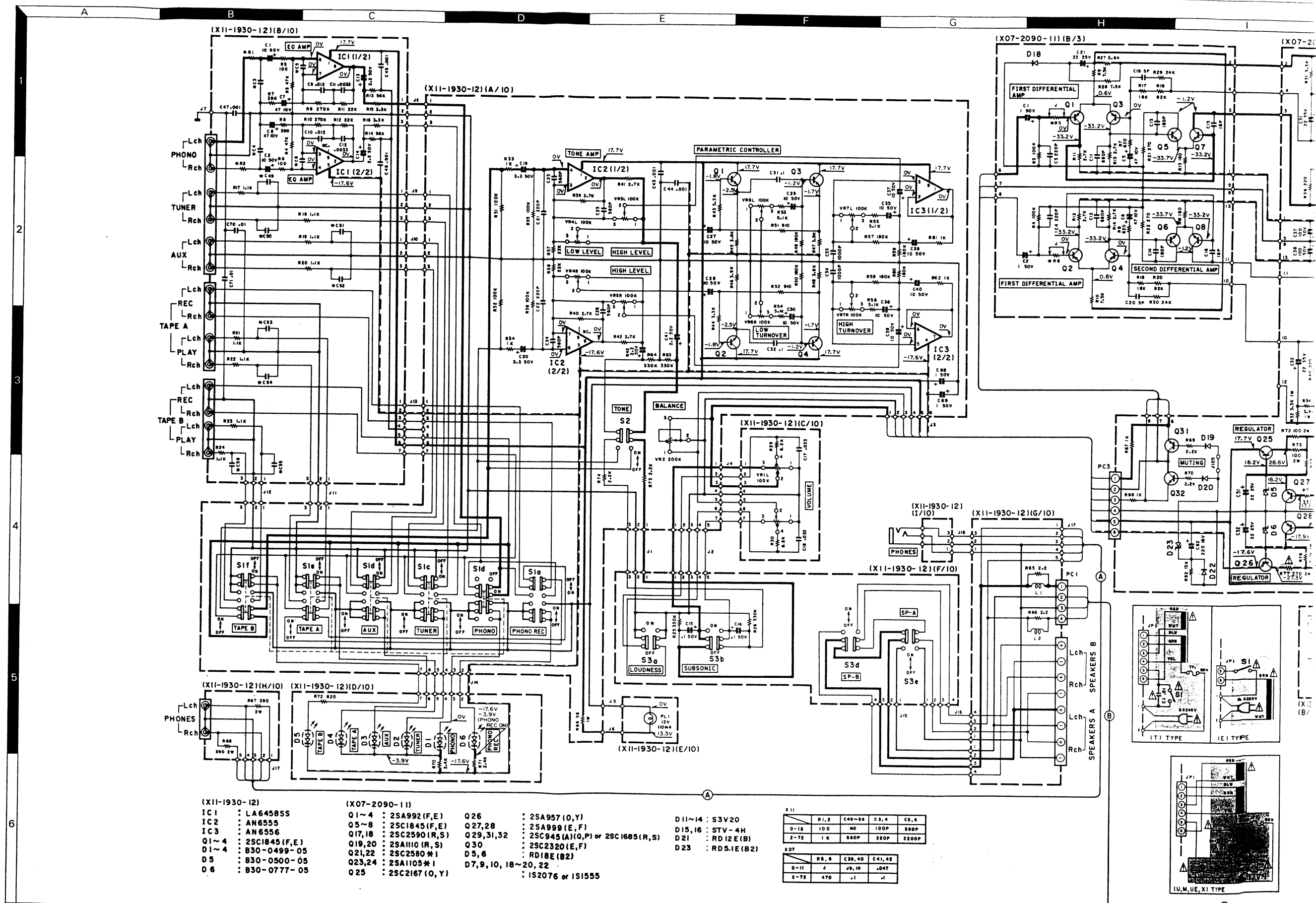
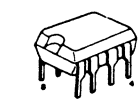

CAUTION: For continued safety, replace safety critical components only with manufacturer's recommended parts (refer to parts list). Δ Indicates safety critical components. To reduce the risk of electric shock, leakage-current or resistance measurement shall be carried out with the power supply disconnected and the components insulated from the supply. Do not return to the customer.

STEREO INTEGRATED AMPLIFIER

KA-52/B



SPECIFICATIONS

Audio Section

Power Output
50 watts* per channel minimum RMS, both channels driven, at 8 ohms from 20 Hz to 20,000 Hz with no more than 0.09% total harmonic distortion.

Both Channels Driven at 8 ohms,
 1 kHz 55 W + 55 W

Dynamic Power Output at
 4 ohms 250 W

Total Harmonic Distortion
TUNER input to SPEAKER output
 (20 Hz to 20,000 Hz) 0.09% at rated power into 8 ohms
 (20 Hz to 20,000 Hz) 0.04% at 1/2 rated power into 8 ohms

PHONO input to SPEAKER output
 output (1 kHz) 0.04% at rated power with VOLUME -20 dB

Intermodulation Distortion 0.02% at rated power (60 Hz:7 kHz = 4:1) into 8 ohms

Damping Factor 20 (1 kHz into 8 ohms)

Power Bandwidth 10 Hz to 75 kHz at 0.2% T.H.D.

Frequency Response 10 Hz to 100 kHz, +0 dB, -3 dB

Input Sensitivity/Impedance
 Phono 2.5 mV/47 k ohms
 Tuner, Tape 150 mV/27 k ohms
Signal-to-Noise Ratio (IHF, A)
 Phono 73 dB for 2.5 mV input
 79 dB for 5.0 mV input
 Tuner, Tape 101 dB for 150 mV input
 Phono Maximum Input Level 150 mV (RMS), T.H.D. 0.05% at 1,000 Hz

Output Level/Impedance
 Tape REC (Pin) 150 mV/3.3 k ohms
Phono Frequency Response RIAA standard curve ± 0.5 dB (30 Hz to 20,000 Hz)

Tone Control
 Bass ± 8 dB at 100 Hz (Turn over 100 Hz ~ 1 kHz)
 Treble ± 8 dB at 10 kHz (Turn over 1 kHz ~ 10 kHz)
Loudness Control +9 dB at 100 Hz (at -30 dB VOLUME Level)

General
Power Requirements 60 Hz 120 V (U.S.A. & Canada models), 50/60 Hz 110 - 120 V/ 220 - 240 V, switchable
Power Consumption 185 W (UL and CSA) 350 W (European countries, U.K., Australia) 170 W (Others)
A.C. Outlet Switched 2, Unswitched 1
Dimensions W 420 mm (16-17/32") H 89 mm (3-1/2") D 279 mm (11")
Weight 6.5 kg (14.3 lb)

* Measured pursuant to Federal Trade Commission's Trade Regulation rule on Power Output Claims for Amplifier in U.S.A.

DC voltages are as measured with a high impedance voltmeter with no signal input. Values may vary slightly due to variations between individual instruments or/and units.

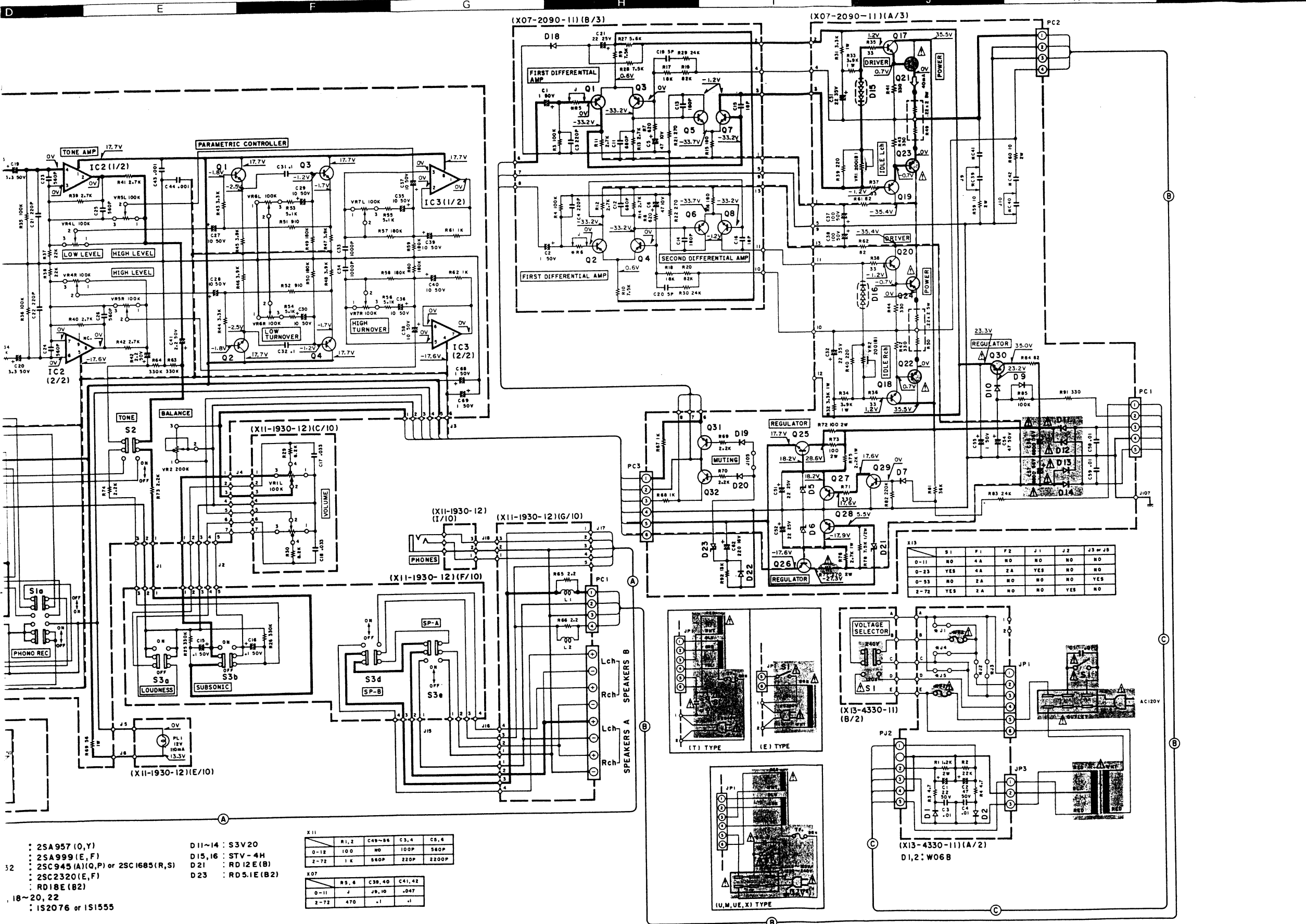

- 2SA957 (O,Y)
- 2SA999 (E,F)
- 2SC945 (A)(Q,P) or 2SC1685 (R,S)
- 2SC2320 (E,F)
- RD18E (B2)
- 18~20, 22
- IS2076 or IS1555

X11			
	R1,2	C49-86	C3,4
0-18	100	NO	100P
2-72	1K	S60P	220P

X07			
	R3,6	C39,40	C41,42
0-11	J	J9,10	.047
2-72	470	.1	.1

CAUTION: For continued safety, replace safety critical components only with manufacturer's recommended parts (refer to parts list). Δ Indicates safety critical components. To reduce the risk of electric shock, leakage-current or resistance

measurements shall be carried out (exposed parts are acceptably insulated from the supply circuit) before the appliance is returned to the customer.

Kenwood follows a policy of continuous advancements in development. For this reason specifications may be changed without notice.

2SA992
2SA999
2SC1845
2SC2003

2SC1827

2SA769

2SA1294
2SC3263

AN6555

LA6458SS

UPC1237H

AN6556

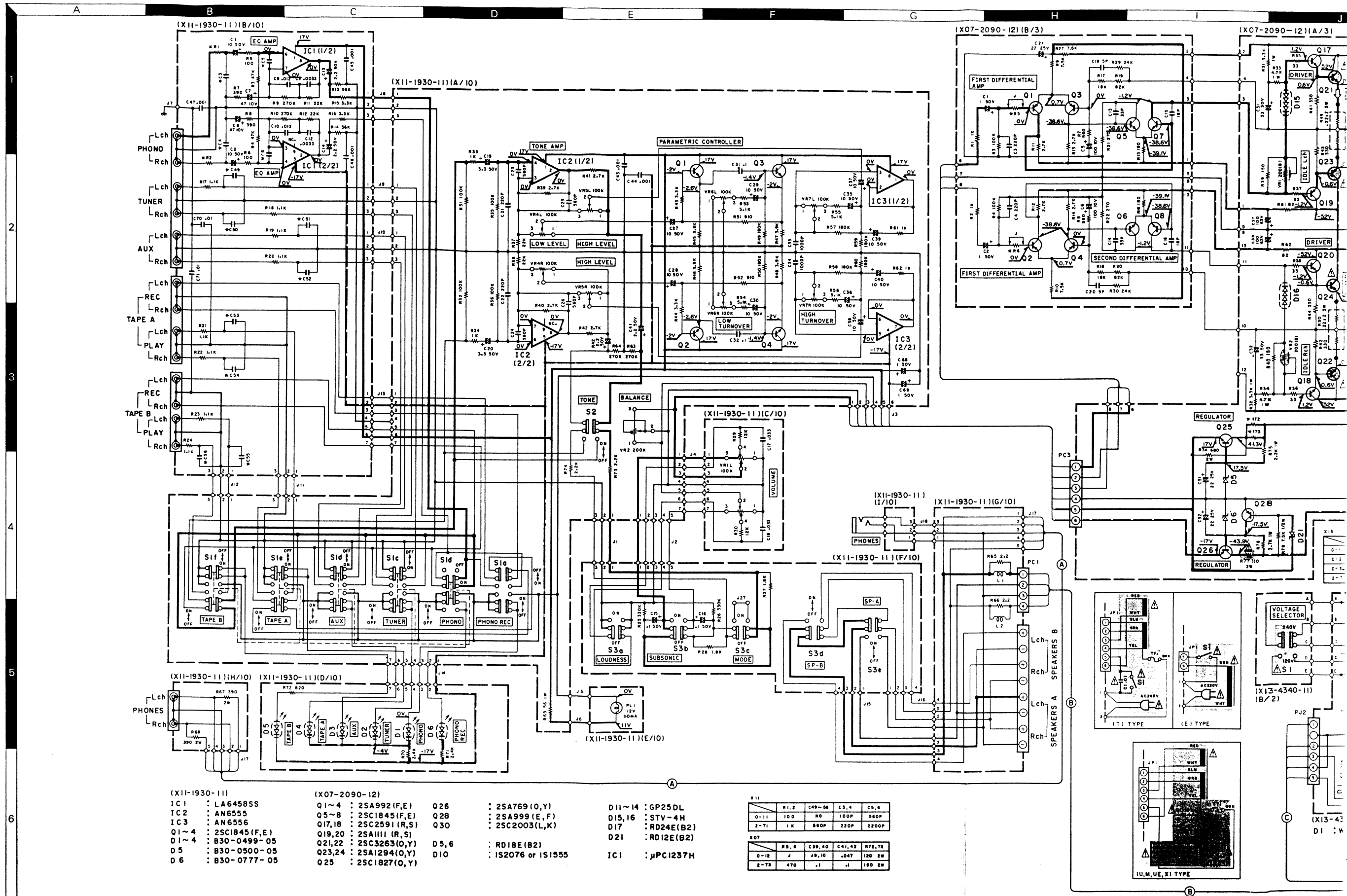

(X11-1930-11)		(X07-2090-12)		D11~14		D15,16		D17		D21	
IC1	: LA6458SS	Q1~4	: 2SA992 (F,E)	Q26	: 2SA769 (O,Y)	GP25DL		STV-4H		RD12E (B2)	
IC2	: AN6555	Q5~8	: 2SC1845 (F,E)	Q28	: 2SA999 (E,F)	RD24E (B2)		RD24E (B2)		RD12E (B2)	
IC3	: AN6556	Q17,18	: 2SC2591 (R,S)	Q30	: 2SC2003 (L,K)						
Q1~4	: 2SC1845 (F,E)	Q19,20	: 2SA1111 (R,S)	D5,6	: RD18E (B2)						
D1~4	: B30-0499-05	Q21,22	: 2SC3263 (O,Y)	D10	: IS2076 or IS1555						
D5	: B30-0500-05	Q23,24	: 2SA1294 (O,Y)								
D6	: B30-0777-05	Q25	: 2SC1827 (O,Y)								

X11	R1,2	C49-56	C3,4	C5,6
0-11	100	50	100P	260P
2-71	1K	500P	220P	2200P

X07	R5,6	C39,40	C41,42	R75,76
0-18	J	.49,10	.047	180 2W
2-78	470	-1	-1	180 2W

CAUTION: For continued safety, replace safety critical components only with manufacturer's recommended parts (refer to parts list). Δ Indicates safety critical components. To reduce the risk of electric shock, leakage-current or resistance measurements shall be carried out (exposed parts insulated from the supply circuit) before returned to the customer.

STEREO INTEGRATED AMPLIFIER

KA-72/B



SPECIFICATIONS

Audio Section

Power Output
70 watts* per channel minimum RMS, both channels driven, at 8 ohms from 20 Hz to 20,000 Hz with no more than 0.05% total harmonic distortion.

Both Channels Driven at 8 ohms,

1 kHz 75 W + 75 W

Dynamic Power Output at

4 ohms 290 W

Total Harmonic Distortion

TUNER input to SPEAKER output

(20 Hz to 20,000 Hz) 0.05% at rated power into 8 ohms

(20 Hz to 20,000 Hz) 0.03% at 1/2 rated power into 8 ohms

PHONO input to SPEAKER

output (1 kHz) 0.03% at rated power with VOLUME - 20 dB

Intermodulation Distortion 0.02% at rated power (60 Hz: 7 kHz = 4:1) into 8 ohms

Damping Factor 20 (1 kHz into 8 ohms)

Power Bandwidth 10 Hz to 80 kHz at 0.2% T.H.D.

Frequency Response 10 Hz to 100 kHz, +0 dB, -3 dB

Input Sensitivity/Impedance

Phono 2.5 mV/47 k ohms

Tuner, Tape 150 mV/25 k ohms

Signal-to-Noise Ratio (IHF, A)

Phono 73 dB for 2.5 mV input

79 dB for 5.0 mV input

Tuner, Tape 101 dB for 150 mV input

Phono Maximum Input Level 150 mV (RMS), T.H.D. 0.05% at 1,000 Hz

Output Level/Impedance

Tape REC (Pin) 150 mV/3.3 k ohms

Phono Frequency Response RIAA standard curve ± 0.3 dB (20 Hz to 20,000 Hz)

Tone Control

Bass ± 8 dB at 100 Hz (Turn over 100 Hz - 1 kHz)

Treble ± 8 dB at 10 kHz (Turn over 1 kHz - 10 kHz)

Subsonic Filter 60 Hz, 6 dB/oct.

Loudness Control +8 dB at 100 Hz (at -30 dB VOLUME Level)

General

Power Requirements 60 Hz 120 V (U.S.A. & Canada models), 50 Hz 240 V (U.K. model) or 50/60 Hz 110 - 120 V/220 - 240 V, switchable

Power Consumption 2.7 A (UL and CSA) 460 W (European countries, U.K., Australia) 230 W (Others)

A.C. Outlet Switched 2, Unswitched 1

Dimensions W 420 mm (16-17/32") H 89 mm (3-1/2") D 279 mm (11")

Weight 6.5 kg (14.3 lb)

* Measured pursuant to Federal Trade Commission's Trade Regulation rule on Power Output Claims for Amplifier in U.S.A.

DC voltages are as measured with a high impedance voltmeter with no signal input. Values may vary slightly due to variations between individual instruments or/and units.

Kenwood follows a policy of continuous advancements in development. For this reason specifications may be changed without notice.

measurements shall be carried out (exposed parts are acceptably insulated from the supply circuit) before the appliance is returned to the customer.

CAUTION: For continued safety, replace safety critical components only with manufacturer's recommended parts (refer to parts list). Δ Indicates safety critical components. To reduce the risk of electric shock, leakage-current or resistance

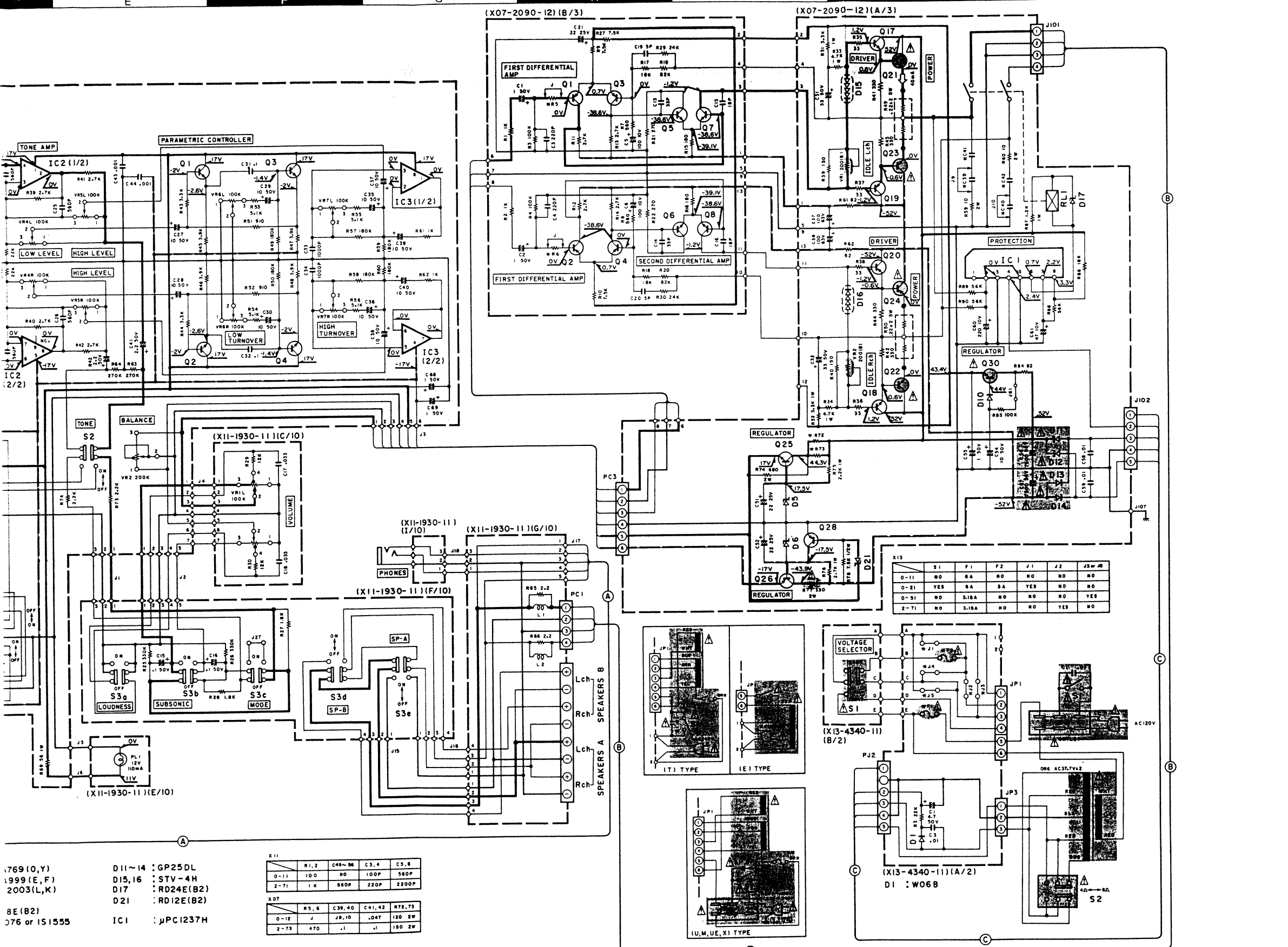

769 (O,Y)	D11~14 : GP25DL
999 (E,F)	D15,16 : STV-4H
2003(L,K)	D17 : RD24E(B2)
	D21 : RD12E(B2)
8E (B2)	IC1 : μ PC1237H
076 or 1S1555	

X11	R1,2	C49-56	C3,4	C5,6
0-11	10.0	NO	100P	560P
2-71	1.8	560P	220P	2200P

X07	R5,6	C39,40	C41,42	R72,73
0-12	J	J9,10	.047	120 2W
2-73	470	.1	.1	180 2W

	S1	F1	F2	J1	J2	J3	J4
0-11	NO	BA	NO	NO	NO	NO	NO
0-21	YES	BA	3A	YES	NO	NO	NO
0-51	NO	3.16A	NO	NO	NO	YES	NO
2-71	NO	3.16A	NO	NO	NO	YES	NO

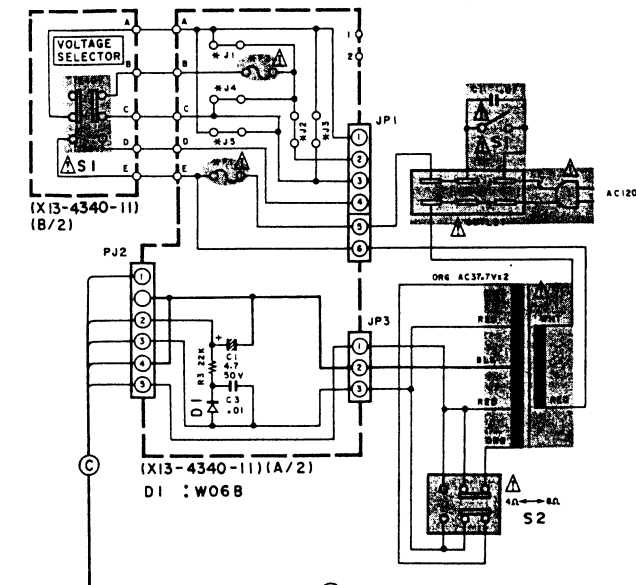
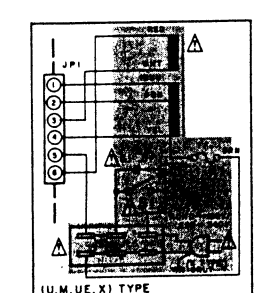
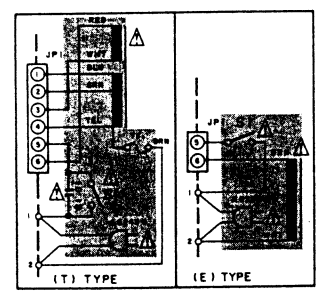

EXPLODED VIEW

Exploded view No. 700~ are not supplied.

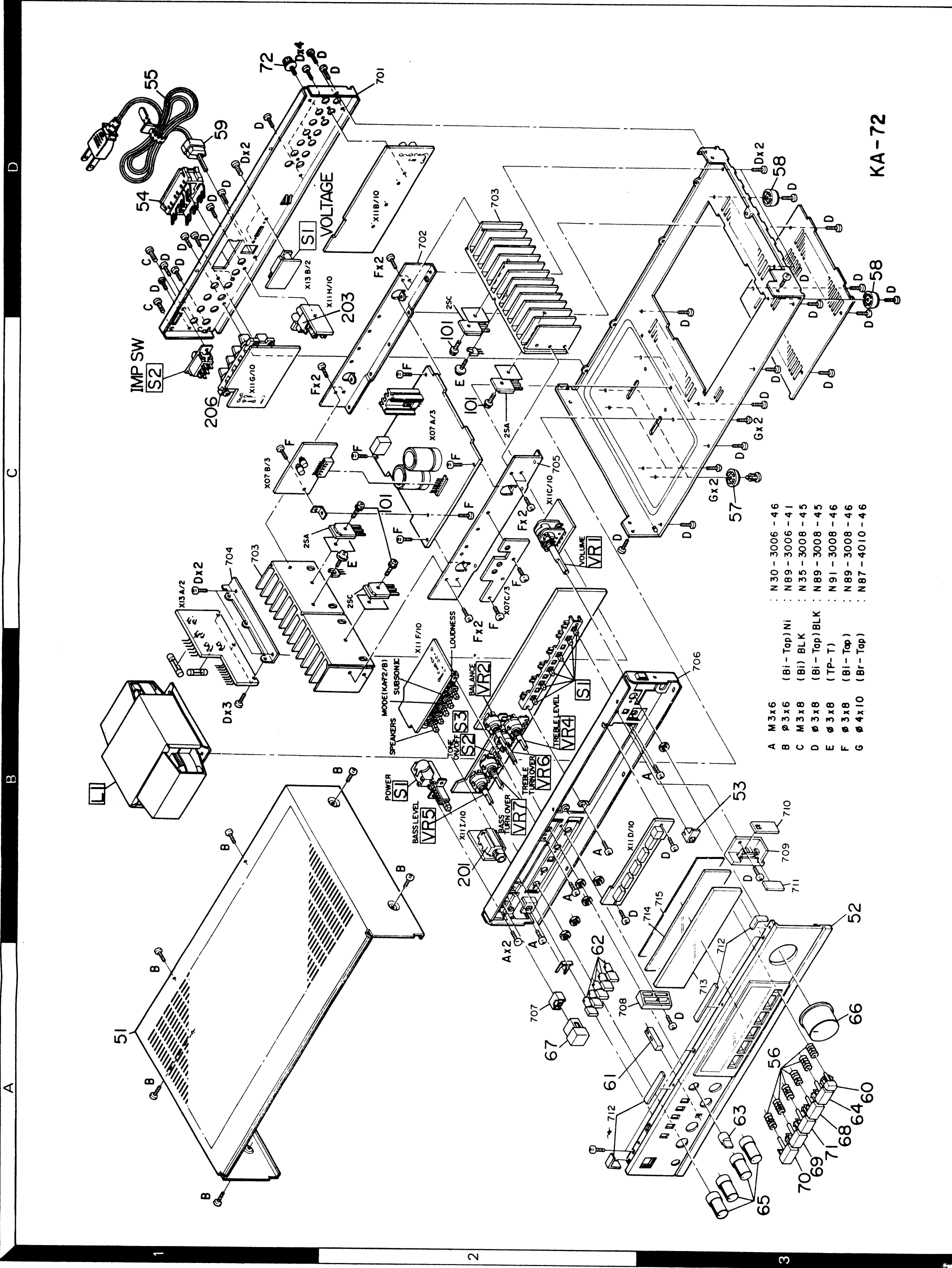

- A M 3x6
 - B φ 3x6
 - C M 3x8
 - D φ 3x8
 - E φ 3x8
 - F φ 3x8
 - G φ 4x10
- : N30 - 3006 - 46
 - : N89 - 3006 - 41
 - : N35 - 3008 - 45
 - : N89 - 3008 - 45
 - : N91 - 3008 - 46
 - : N89 - 3008 - 46
 - : N87 - 4010 - 46
- (Bi - Tap) Ni
 - (Bi) BLK
 - (Bi - Tap) BLK
 - (TP - T)
 - (Bi - Tap)
 - (Br - Tap)

KA-72

PARTS LIST

* New Parts

Parts without Parts No. are not supplied

Les articles non mentionnés dans le Parts No. ne sont pas fournis

Teile ohne Parts No. werden nicht geliefert

Ref. No. 参照番号	Address 位置	New Parts 新	Parts No. 部品番号	Description 部品名 / 規格	Desti- nation 仕向	Re- marks 備考
KA-52						
51	1A		A01-0648-02	METALLIC CABINET	KPUM	
51	1A		A01-0648-02	METALLIC CABINET	UEX	
51	1A		A01-0649-02	METALLIC CABINET	TE	
52	3B	*	A20-3667-03	PANEL ASSY	KPUM	
52	3B	*	A20-3667-03	PANEL ASSY	UEXE	
52	3B	*	A20-3668-03	PANEL ASSY	T	
-			B46-0092-03	WARRANTY CARD	K	
-			B46-0093-03	WARRANTY CARD	P	
-			B46-0094-03	WARRANTY CARD	UEE	
-			B46-0095-03	WARRANTY CARD	UEE	
-			B46-0096-03	WARRANTY CARD	X	
-			B46-0097-03	WARRANTY CARD	T	
-			B46-0098-03	WARRANTY CARD	E	
-			B50-5018-00	INSTRUCTION MANUAL (E)	KPUM	
-			B50-5018-00	INSTRUCTION MANUAL (E)	UE	
-			B50-5019-00	INSTRUCTION MANUAL (F)	PMXE	
-			B50-5020-00	INSTRUCTION MANUAL (E)	T	
-			B50-5021-00	INSTRUCTION MANUAL (G,D,I,SW)	E	
-			B50-5027-00	INSTRUCTION MANUAL (SP,E)	M	
-			B59-0092-00	SERVICE DIRECTORY	UEE	
△ C1			C91-0023-05	CERAMIC	LMUEX	
△ C2			C91-0647-05	CERAMIC	KP	
53	3B		D22-0050-04	SHAFT COUPLING		
△ 54	1D		E03-0061-05	AC OUTLET	KPUM	
△ 54	1D		E03-0061-05	AC OUTLET	UEX	
△ 55	1D		E30-0181-05	AC POWER CORD	K	
△ 55	1D		E30-0459-05	AC POWER CORD	E	
△ 55	1D		E30-0587-05	AC POWER CORD	T	
△ 55	1D		E30-0679-05	AC POWER CORD	X	
△ 55	1D		E30-0720-05	AC POWER CORD	P	
△ 55	1D		E30-0811-05	AC POWER CORD	LMUE	
56	3A		G01-1438-04	COMPRESSION SPRING		
-		*	H01-4971-04	ITEM CARTON CASE	T	
-		*	H01-4972-04	ITEM CARTON CASE	KPUM	
-		*	H01-4972-04	ITEM CARTON CASE	UEXE	
-			H10-1706-02	POLYSTYRENE FOAMED FIXTURE		
-			H25-0078-04	PROTECTION BAG		
57	3C		J02-0109-05	FOOT		
58	3D		J02-0129-05	FOOT		
△ 59	1D		L42-0083-05	POWER CORD BUSHING	KPUM	
△ 59	1D		L42-0083-05	POWER CORD BUSHING	UETE	
△ 59	1D		L42-0083-05	POWER CORD BUSHING	X	
60	3A		K27-1060-04	KNØB (BUTTON) PHØNØ REC		
61	2A		K27-1061-04	KNØB (BUTTON) PUSH		
62	2A		K27-1112-04	KNØB (BUTTON) SPEAKERS		
63	3B		K29-1230-04	KNØB BALANCE		
64	3A		K29-1351-04	KNØB ASSY PHØNØ		
65	3A		K29-1352-04	KNØB TØNE		
66	3A		K29-1354-04	KNØB VØLUME		
67	2A		K29-1446-04	KNØB ASSY PØWER		

E: Scandinavia & Europe H: Audio Club K: USA P: Canada

S: South Africa T: England U: PX(Far East, Hawaii)

UE: AAFES(Europe) X: Australia M: Other Areas

△ indicates safety critical components.

PARTS LIST

* New Parts
 Parts without Parts No. are not supplied
 Les articles non mentionnés dans le Parts No. ne sont pas fournis
 Teile ohne Parts No. werden nicht geliefert

Ref. No. 参照番号	Address 位置	New Parts 新	Parts No. 部品番号	Description 部品名 / 規格	Desti- nation 仕 向	Re- marks 備考
68	3A		K29-1449-04	KNOB ASSY TUNER		
69	3A		K29-1451-04	KNOB ASSY TAPE A		
70	3A		K29-1452-04	KNOB ASSY TAPE B		
71	3A		K29-1487-04	KNOB ASSY AUX		
△ L1	1B	*	L01-3401-05	POWER TRANSFORMER	KP	
△ L1	1B	*	L01-3402-05	POWER TRANSFORMER	E	
△ L1	1B	*	L01-3406-05	POWER TRANSFORMER	UMUEX	
△ L1	1B	*	L01-3406-05	POWER TRANSFORMER	T	
72	1D		N08-0128-35	BINDING POST		
△ S1	2B		S40-1066-05	PUSH SWITCH (POWER TYPE)		
KA-52B						
51	1A		A01-0690-02	METALLIC CABINET		
52	3B	*	A20-3797-03	PANEL ASSY	KPUM	
52	3B	*	A20-3797-03	PANEL ASSY	UEXE	
52	3B	*	A20-3798-03	PANEL ASSY	T	
-			B46-0092-03	WARRANTY CARD	K	
-			B46-0093-03	WARRANTY CARD	P	
-			B46-0094-03	WARRANTY CARD	UUE	
-			B46-0095-03	WARRANTY CARD	UUE	
-			B46-0096-03	WARRANTY CARD	X	
-			B46-0097-03	WARRANTY CARD	T	
-			B46-0098-03	WARRANTY CARD	E	
-			B50-5018-00	INSTRUCTION MANUAL (E)	KPUM	
-			B50-5018-00	INSTRUCTION MANUAL (E)	UE	
-			B50-5019-00	INSTRUCTION MANUAL (F)	PMXE	
-			B50-5020-00	INSTRUCTION MANUAL (E)	T	
-			B50-5021-00	INSTRUCTION MANUAL (G,D,I,SW)	E	
-			B50-5027-00	INSTRUCTION MANUAL (SP,E)	M	
-			B59-0092-00	SERVICE DIRECTORY	UUE	
△ C1			C91-0023-05	CERAMIC 0.01UF AC250V	UMUEX	
△ C1			C91-0647-05	CERAMIC 0.01UF P	KP	
53	3B		D22-0050-04	SHAFT COUPLING		
△ 54	1D		E03-0061-05	AC OUTLET	KPUM	
△ 54	1D		E03-0061-05	AC OUTLET	UEX	
△ 55	1D		E30-0181-05	AC POWER CORD	K	
△ 55	1D		E30-0459-05	AC POWER CORD	E	
△ 55	1D		E30-0587-15	AC POWER CORD	T	
△ 55	1D		E30-0649-05	AC POWER CORD	X	
△ 55	1D		E30-0780-05	AC POWER CORD	P	
△ 55	1D		E30-0812-05	AC POWER CORD	UMUE	
56	3A		G01-1438-04	COMPRESSION SPRING		
-		*	H01-5027-04	ITEM CARTON CASE	KPUM	
-		*	H01-5027-04	ITEM CARTON CASE	UEXE	
-		*	H01-5028-04	ITEM CARTON CASE	T	
-			H10-1706-02	POLYSTYRENE FOAMED FIXTURE		
-			H25-0078-04	PROTECTION BAG		
57	3C		J02-0109-05	FOOT		
58	3D		J02-0129-05	FOOT		
△ 59	1D		J42-0083-05	POWER CORD BUSHING	KPUM	
△ 59	1D		J42-0083-05	POWER CORD BUSHING	UETE	
△ 59	1D		J42-0085-05	POWER CORD BUSHING	X	

E: Scandinavia & Europe H: Audio Club K: USA P: Canada
 S: South Africa T: England U: PX(Far East, Hawaii)
 UE: AAFES(Europe) X: Australia M: Other Areas

△ indicates safety critical components

PARTS LIST

* New Parts

Parts without Parts No. are not supplied

Les articles non mentionnés dans le Parts No. ne sont pas fournis.

Teile ohne Parts No. werden nicht geliefert.

Ref. No. 参照番号	Address 位置	New Parts 新	Parts No. 部品番号	Description 部品名 / 規格	Desti- nation 仕 向	Re- marks 備考
60	3A		K27-1164-04	KNØB (BUTTON) PHØNØ REC		
61	2A	*	K27-1153-04	KNØB (BUTTON) PUSH		
62	2A		K27-0965-04	KNØB (BUTTON) SPEAKERS		
63	3B		K29-1518-04	KNØB BALANCE		
64	3A	*	K29-1511-04	KNØB ASSY PHØNØ		
65	3A	*	K29-1516-04	KNØB TØNE		
66	3A		K29-1517-04	KNØB VØLUME		
67	2A		K29-1446-04	KNØB ASSY PØWER		
68	3A	*	K29-1512-04	KNØB ASSY TUNER		
69	3A	*	K29-1514-04	KNØB ASSY TAPE A		
70	3A	*	K29-1515-04	KNØB ASSY TAPE B		
71	3A	*	K29-1513-04	KNØB ASSY AUX		
△ L1	1B		L01-3401-05	POWER TRANSFORMER	KP	
△ L1	1B		L01-3402-05	POWER TRANSFORMER	E	
△ L1	1B		L01-3403-05	POWER TRANSFORMER	UMUEX	
△ L1	1B		L01-3404-05	POWER TRANSFORMER	T	
72	1D		NØB-0128-35	BINDING PØST		
△ S1	2B		S40-1066-05	PUSH SWITCH (POWER TYPE)		
POWER AMP (XØ7-2Ø90-11)						
C1	.2		CEØ4FW1HØ1ØM	ELECTRØ 1UF 5ØWV		
C3	.4		CC45FSL1H221J	CERAMIC 22ØPF J		
C5	.6		CEØ4FW1A47ØM	ELECTRØ 47UF 1ØWV		
C11	.12		CK45FB1H681K	CERAMIC 68ØPF K		
C13	.14		CC45FSL1H181J	CERAMIC 18ØPF J		
C15	.16		CC45FSL1H18ØJ	CERAMIC 18PF J		
C19	.20		CC45FSL1HØ5ØC	CERAMIC 5.ØPF C		
C21			CEØ4FW1E22ØM	ELECTRØ 22UF 25WV		
C31	.32		CEØ4FW1V22ØM	ELECTRØ 22UF 35WV		
C37	.38		CEØ4FW1H1Ø1M	ELECTRØ 1ØØUF 5ØWV		
C39	-.42		CF92FV1H1Ø4J	MF Ø.1ØUF J	TE	
C41	.42		CF92FV1H473J	MF Ø.Ø47UF J	KPUM	
C41	.42		CF92FV1H473J	MF Ø.Ø47UF J	UEX	
C51	.52		CEØ4FW1E22ØM	ELECTRØ 22UF 25WV		
C54			CEØ4FW1H47ØM	ELECTRØ 47UF 5ØWV		
C55			CEØ4FW1HØ1ØM	ELECTRØ 1UF 5ØWV		
△ C56	.57		CØØ-ØØ1Ø-Ø5	ELECTRØ 1ØØØUF 5ØWV		
C58	.59		CK45E2H1Ø3P	CERAMIC Ø.Ø1UF P		
C62			CEØ4FW1C221M	ELECTRØ 22ØUF 16WV		
1Ø1	2C		NØ9-Ø333-Ø5	TAPPING SCREW		
R15	.16	*	RD14AB2E1Ø1J	FL-PRØØF RD 18Ø J 2E		
R21	.22		RD14GB2E271J	FL-PRØØF RD 27Ø J 2E		
R31	.32		RS14GB3A332J	FL-PRØØF RS 3.3K J 3A		
R33	.34		RS14GB3A392J	FL-PRØØF RS 3.9K J 3A		
R35			RD14GB2E33ØJ	FL-PRØØF RD 33 J 2E		
R36		*	RD14AB2E33ØJ	FL-PRØØF RD 33 J 2E		
R37			RD14GB2E33ØJ	FL-PRØØF RD 33 J 2E		
R38		*	RD14AB2E33ØJ	FL-PRØØF RD 33 J 2E		
R39	.4Ø	*	RD14AB2E221J	FL-PRØØF RD 22Ø J 2E		
R41		*	RD14AB2E331J	FL-PRØØF RD 33Ø J 2E		
R42			RD14GB2E331J	FL-PRØØF RD 33Ø J 2E		
R43	.44	*	RD14AB2E331J	FL-PRØØF RD 33Ø J 2E		
R49	.5Ø		R9Ø-Ø187-Ø5	MULTI-CØMP Ø.22X2 K 3H		

E: Scandinavia & Europe H: Audio Club K: USA

P: Canada

S: South Africa

T: England U: PX(Far East, Hawaii)

UE: AAFES(Europe)

X: Australia M: Other Areas

△ indicates safety critical components

PARTS LIST

* New Parts
 Parts without Parts No. are not supplied.
 Les articles non mentionnes dans le Parts No. ne sont pas fournis.
 Teile ohne Parts No. werden nicht geliefert.

Ref. No. 参照番号	Address 位置	New Parts 新	Parts No. 部品番号	Description 部品名 / 規格	Desti- nation 仕 向	Re- marks 備考
R59 ,60 R61 ,62 R72 ,73 R75 R76		*	RS14GB3D100J RD14AB2E820J RS14GB3D101J RS14GB3A222J RS14GB3A272J	FL-PROOF RS 10 J 3D FL-PROOF RD 82 J 2E FL-PROOF RS 100 J 3D FL-PROOF RS 2.2K J 3A FL-PROOF RS 2.7K J 3A		
△ R77 R78 R84 VR1 ,2 D5 ,6 D7 D7 D9 ,10 D9 ,10		*	RS14GB3D271J RD14GB2H752J RD14AB2E820J R12-0087-05 RD18E(B2) 1S1555 1S2076 1S1555 1S2076	FL-PROOF RS 270 J 3D FL-PROOF RD 7.5K J 2H FL-PROOF RD 82 J 2E TRIMMING POT. 200(B) BIAS ZENER DIODE DIODE DIODE DIODE DIODE		
△ D11 -14 D15 ,16 D18 -20 D18 -20 D21 D22 D22 D23 Q1 -4 Q5 -8 Q17 ,18 Q19 ,20 △ Q21 ,22 △ Q23 ,24 Q25 Q26 Q27 ,28 Q29 Q29 △ Q30 Q31 ,32 Q31 ,32		*	S3V20 STV-4H 1S1555 1S2076 RD12E(B2) 1S1555 1S2076 RD5.1E(B2) 2SA992(F,E) 2SC1845(F,E) 2SC2590(R,S) 2SA1110(R,S) 2SC2580*1 △ 2SA1105*1 * 2SC2167(O,Y) * 2SA957(O,Y) 2SA999(E,F) 2SC1685(R,S) 2SC945(A)(Q,P) 2SC2320(E,F) 2SC1685(R,S) 2SC945(A)(Q,P)	DIODE VARISTOR DIODE DIODE ZENER DIODE DIODE DIODE ZENER DIODE TRANSISTOR (1ST AMP) TRANSISTOR (2ND AMP) TRANSISTOR (DRIVER) TRANSISTOR (DRIVER) TRANSISTOR (POWER) TRANSISTOR (POWER) TRANSISTOR (REGULATOR) TRANSISTOR (REGULATOR) TRANSISTOR (POWER SUPPLY CONT.) TRANSISTOR (MUTE DRIVE) TRANSISTOR (MUTE DRIVE) TRANSISTOR (REGULATOR) TRANSISTOR (MUTING) TRANSISTOR (MUTING)		
△ TONE AMP (X11-1930-12)						
D1 -4 D5 D6 PL1 C1 ,2 C3 ,4 C3 ,4 C3 ,4 C5 ,6 C5 ,6 C5 ,6 C7 ,8 C9 ,10 C11 ,12 C13 ,14 C15 ,16 C17 ,18			B30-0499-05 B30-0500-05 B30-0777-05 B30-0372-05 CE04FW1H100M CC45FSL1H101J CC45FSL1H101J CC45FSL1H221J CK45FB1H222K CK45FB1H561K CK45FB1H561K CE04FW1A470M CF92FV1H123J CF92FV1H332J CE04FW1H2R2M CE04FW1H0R1M CF92FV1H333J	LED (SELECTOR) LED (TAPE B) LED (PHONE REC) LAMP (POWER) 12V 0.11A ELECTRO 10UF 50WV CERAMIC 100PF J CERAMIC 100PF J CERAMIC 220PF J CERAMIC 2200PF K CERAMIC 560PF K CERAMIC 560PF K ELECTRO 47UF 10WV MF 0.012UF J MF 3300PF J ELECTRO 2.2UF 50WV ELECTRO 0.1UF 50WV MF 0.033UF J		KPUM U EX TE TE KPUM U EX

E: Scandinavia & Europe H: Audio Club K: USA P: Canada
 S: South Africa T: England U: PX(Far East, Hawaii)
 UE: AAFES(Europe) X: Australia M: Other Areas

△ indicates safety critical components.

PARTS LIST

* New Parts
 Parts without Parts No. are not supplied
 Les articles non mentionnés dans le Parts No. ne sont pas fournis
 Teile ohne Parts No. werden nicht geliefert

Ref. No. 参照番号	Address 位置	New Parts 新	Parts No. 部品番号	Description 部品名 / 規格	Destination 仕向	Remarks 備考
C19 ,20 C21 ,22 C23 -26 C27 -30 C31 ,32			CE04FW1H3R3M CC45FSL1H221J CK45FB1H561K CE04FW1H100M CF92FV1H104J	ELECTRO 3.3UF 50WV CERAMIC 220PF J CERAMIC 560PF K ELECTRO 10UF 50WV MF 0.10UF J		
C33 ,34 C35 -40 C41 ,42 C43 -47 C49 -56			CK45FB1H102K CE04FW1H100M CE04FW1H2R2M CK45FF1H103Z CK45FB1H561K	CERAMIC 0.001UF K ELECTRO 10UF 50WV ELECTRO 2.2UF 50WV CERAMIC 0.01UF Z CERAMIC 560PF K	TE	
C68 ,69 C70 ,71			CE04FW1H010M CK45FF1H103Z	ELECTRO 1UF 50WV CERAMIC 0.01UF Z		
201 203 206 - -	2B 1C 1C		E11-0135-05 E13-0217-05 E20-0820-05 E13-0434-05 E13-0622-05	PHONE JACK (HEADPHONE) PHONE JACK (2P) LOCK TERMINAL BOARD (SPEAKERS) PHONE JACK (4P) PHONE JACK (6P)		
L1 ,2			L39-0085-05	PHASE-COMPENSATION COIL		
R65 ,66 R67 ,68 R69 VR1 VR2			RD14GB2E2R2J RS14GB3D391J RS14GB3A560J RO6-5087-05 RO1-5041-05	FL-PROOF RD 2.2 J 2E FL-PROOF RS 390 J 3D FL-PROOF RS 56 J 3A POTENTIOMETER 100K(B)VOLUME POTENTIOMETER 200K(W)BALANCE		
VR4 ,5 VR6 ,7		*	RO6-5116-05 RO6-5117-05	POTENTIOMETER 100K TONE POTENTIOMETER 100K TURNOVER		
S1 S2 S3		*	S42-6016-05 S40-2323-05 S42-4035-05	MULTIPLE PUSH SWITCH(SELECTOR) PUSH SWITCH (TONE) PUSH SW. (MODE, SP, LOUD, SUBSONIC)		
IC1 IC2 IC3 Q1 -4			LA6458SS AN6555 AN6556 2SC1845(F,E)	IC (EQ AMP) IC (TONE AMP) IC (TONE AMP) TRANSISTOR (CONTROLLER)		
POWER SUPPLY (X13-4330-11)						
C1 C1 C1 ,2 C2 C2			CE04W1H220M CE04W1H220M CE04W1H470M CE04W1H470M CE04W1H470M	ELECTRO 22UF 50WV ELECTRO 22UF 50WV ELECTRO 47UF 50WV ELECTRO 47UF 50WV ELECTRO 47UF 50WV	KPUM UEXT E KPUM UEXT	
C3 ,4			CK45F1H103Z	CERAMIC 0.01UF Z		
Δ F1 Δ F1 Δ F1 Δ F2 Δ F2			F05-4022-05 F06-2021-05 F06-4024-05 F05-2023-05 F06-2021-05	FUSE FUSE (SEMKG) FUSE (UL) FUSE FUSE (SEMKG)	UMUEX E KP UMUEX T	
- -			J13-0041-05 J13-0055-05	FUSE CLIP FUSE CLIP	UMUEX KPTE	
R1 R3 ,4			RS14GB3D122J RD14GB2E4R7J	FL-PROOF RS 1.2K J 3D FL-PROOF RD 4.7 J 2E		
Δ S1			S31-2083-05	SLIDE SWITCH (POWER VOLTAGE)	UMUEX	
D1 ,2			WD6B	DIODE		

E: Scandinavia & Europe H: Audio Club K: USA P: Canada
 S: South Africa T: England U: PX(Far East, Hawaii)
 UE: AAFES(Europe) X: Australia M: Other Areas

△ indicates safety critical components.

PARTS LIST

* New Parts

Parts without **Parts No.** are not supplied.

Les articles non mentionnés dans le **Parts No.** ne sont pas fournis.

Teile ohne **Parts No.** werden nicht geliefert.

Ref. No. 参照番号	Address 位置	New Parts 新	Parts No. 部品番号	Description 部品名 / 規格	Desti- nation 仕 向	Re- marks 備考
KA-72						
51	1A		A01-0648-02	METALLIC CABINET	KPUM	
51	1A		A01-0648-02	METALLIC CABINET	UEX	
51	1A		A01-0649-02	METALLIC CABINET	TE	
52	3B	*	A20-3662-03	PANEL ASSY	KPUM	
52	3B	*	A20-3662-03	PANEL ASSY	UEXE	
52	3B	*	A20-3663-03	PANEL ASSY	T	
-			B46-0092-03	WARRANTY CARD	K	
-			B46-0093-03	WARRANTY CARD	P	
-			B46-0094-03	WARRANTY CARD	UUE	
-			B46-0095-03	WARRANTY CARD	UUE	
-			B46-0096-03	WARRANTY CARD	X	
-			B46-0097-03	WARRANTY CARD	T	
-			B46-0098-03	WARRANTY CARD	E	
-		*	B50-5018-00	INSTRUCTION MANUAL (E)	KPUM	
-		*	B50-5018-00	INSTRUCTION MANUAL (E)	UE	
-		*	B50-5019-00	INSTRUCTION MANUAL (F)	PMXE	
-		*	B50-5020-00	INSTRUCTION MANUAL (E)	T	
-		*	B50-5021-00	INSTRUCTION MANUAL (G,D,I,SW)	E	
-		*	B50-5027-00	INSTRUCTION MANUAL (SP,E)	M	
-			B59-0092-00	SERVICE DIRECTORY	UUE	
△ C1			C91-0023-05	CERAMIC 0.01UF AC250V	UMUEX	
△ C1			C91-0647-05	CERAMIC 0.01UF P	KP	
53	3B	*	D22-0050-04	SHAFT COUPLING		
△ 54	1D		E03-0061-05	AC OUTLET	KPUM	
△ 54	1D		E03-0061-05	AC OUTLET	UEX	
△ 55	1D		E30-0181-05	AC POWER CORD	K	
△ 55	1D		E30-0459-05	AC POWER CORD	E	
△ 55	1D		E30-0587-15	AC POWER CORD	T	
△ 55	1D		E30-0649-05	AC POWER CORD	X	
△ 55	1D		E30-0780-05	AC POWER CORD	P	
△ 55	1D		E30-0812-05	AC POWER CORD	UMUE	
56	3A	*	G01-1438-04	COMPRESSION SPRING		
-		*	H01-4969-04	ITEM CARTON CASE	T	
-		*	H01-4970-04	ITEM CARTON CASE	KPUM	
-		*	H01-4970-04	ITEM CARTON CASE	UEXE	
-			H10-1706-02	POLYSTYRENE FOAMED FIXTURE		
-			H25-0078-04	PROTECTION BAG		
57	3C		J02-0109-05	FOOT		
58	3D		J02-0129-05	FOOT		
△ 59	1D		J42-0083-05	POWER CORD BUSHING	KPUM	
△ 59	1D		J42-0083-05	POWER CORD BUSHING	UETE	
△ 59	1D		J42-0085-05	POWER CORD BUSHING	X	
60	3A	*	K27-1060-04	KNØB (BUTTON) PHØNØ REC		
61	2A	*	K27-1061-04	KNØB (BUTTON) PUSH		
62	2A		K27-1112-04	KNØB (BUTTON) SPEAKERS		
63	3B		K29-1230-04	KNØB BALANCE		
64	3A	*	K29-1351-04	KNØB ASSY PHØNØ		
65	3A	*	K29-1352-04	KNØB TØNE		
66	3A		K29-1354-04	KNØB VØLUME		
67	2A		K29-1446-04	KNØB ASSY PØWER		

E: Scandinavia & Europe H: Audio Club K: USA

P: Canada

S: South Africa T: England U: PX(Far East, Hawaii)

UE: AAFES(Europe) X: Australia M: Other Areas

△ indicates safety critical components.

PARTS LIST

* New Parts

Parts without Parts No. are not supplied

Les articles non mentionnés dans le Parts No. ne sont pas fournis

Teile ohne Parts No. werden nicht geliefert

Ref. No. 参照番号	Address 位置	New Parts 新	Parts No. 部品番号	Description 部品名 / 規格	Desti- nation 仕 向	Re- marks 備考
68	3A	*	K29-1449-04	KNØB ASSY TUNER		
69	3A	*	K29-1451-04	KNØB ASSY TAPE A		
70	3A	*	K29-1452-04	KNØB ASSY TAPE B		
71	3A	*	K29-1487-04	KNØB ASSY AUX		
Δ L1	1B	*	L01-3391-05	POWER TRANSFORMER	K	
Δ L1	1B	*	L01-3392-05	POWER TRANSFORMER	E	
Δ L1	1B	*	L01-3396-05	POWER TRANSFORMER	UMUEX	
Δ L1	1B	*	L01-3396-05	POWER TRANSFORMER	T	
Δ L1	1B	*	L01-3397-05	POWER TRANSFORMER	P	
72	1D		N08-0128-35	BINDING POST		
Δ S1	2B		S40-1073-05	PUSH SWITCH (POWER)		
Δ S2	1D		S31-2001-05	SLIDE SWITCH (IMP SW)	UMUEX	
Δ S2	1D		S31-2001-05	SLIDE SWITCH (IMP SW)	TE	
Δ S2	1D		S31-2068-05	SLIDE SWITCH (IMP SW)	KP	
KA-72B						
51	1A		A01-0690-02	METALLIC CABINET		
52	3B	*	A20-3801-03	PANEL ASSY	KPUM	
52	3B	*	A20-3801-03	PANEL ASSY	UEXE	
52	3B	*	A20-3802-03	PANEL ASSY	T	
-			B46-0092-03	WARRANTY CARD	K	
-			B46-0093-03	WARRANTY CARD	P	
-			B46-0094-03	WARRANTY CARD	UUE	
-			B46-0095-03	WARRANTY CARD	UUE	
-			B46-0096-03	WARRANTY CARD	X	
-			B46-0097-03	WARRANTY CARD	T	
-			B46-0098-03	WARRANTY CARD	E	
-			B50-5018-00	INSTRUCTION MANUAL (E)	KPUM	
-			B50-5018-00	INSTRUCTION MANUAL (E)	UE	
-			B50-5019-00	INSTRUCTION MANUAL (F)	PMXE	
-			B50-5020-00	INSTRUCTION MANUAL (E)	T	
-			B50-5021-00	INSTRUCTION MANUAL (G,D,I,SW)	E	
-			B50-5027-00	INSTRUCTION MANUAL (SP,E)	M	
-			B59-0092-00	SERVICE DIRECTORY	UUE	
Δ C1			C91-0023-05	CERAMIC D. 01UF AC250V	UMUEX	
Δ C1			C91-0647-05	CERAMIC D. 01UF P.	KP	
53	3B		D22-0050-04	SHAFT COUPLING		
Δ 54	1D		E03-0061-05	AC OUTLET	KPUM	
Δ 54	1D		E03-0061-05	AC OUTLET	UEX	
Δ 55	1D		E30-0181-05	AC POWER CORD	K	
Δ 55	1D		E30-0459-05	AC POWER CORD	E	
Δ 55	1D		E30-0587-15	AC POWER CORD	T	
Δ 55	1D		E30-0649-05	AC POWER CORD	X	
Δ 55	1D		E30-0780-05	AC POWER CORD	P	
Δ 55	1D		E30-0812-05	AC POWER CORD	UMUE	
56	3A		G01-1438-04	COMPRESSION SPRING		
-		*	H01-5029-04	ITEM CARTON CASE	KPUM	
-		*	H01-5029-04	ITEM CARTON CASE	UEXE	
-		*	H01-5030-04	ITEM CARTON CASE	T	
-			H10-1706-02	POLYSTYRENE FOAMED FIXTURE		
-			H25-0078-04	PROTECTION BAG		
57	3C		J02-0109-05	FOOT		

E: Scandinavia & Europe H: Audio Club K: USA P: Canada

S: South Africa T: England U: PX(Far East, Hawaii)

UE: AAFES(Europe) X: Australia M: Other Areas

Δ indicates safety critical components

PARTS LIST

* New Parts
 Parts without Parts No. are not supplied.
 Les articles non mentionnés dans le Parts No. ne sont pas fournis.
 Teile ohne Parts No. werden nicht geliefert.

Ref. No. 参照番号	Address 位置	New Parts	Parts No. 部品番号	Description 部品名 / 規格	Desti- nation 仕 向	Re- marks 備考
58	3D		J02-0129-05	FOOT		
△ 59	1D		J42-0083-05	POWER CORD BUSHING	KPUM	
△ 59	1D		J42-0083-05	POWER CORD BUSHING	UETE	
△ 59	1D		J42-0085-05	POWER CORD BUSHING	X	
-			J21-3326-05	JACK MOUNTING HARDWARE		
60	3A		K27-1060-04	KNØB (BUTTON) PHONO REC		
61	2A		K27-1153-04	KNØB (BUTTON) PUSH		
62	2A		K27-0965-04	KNØB (BUTTON) SPEAKER		
63	3B		K29-1518-04	KNØB BALANCE		
64	3A		K29-1511-04	KNØB ASSY PHONO		
65	3A		K29-1516-04	KNØB TONE		
66	3A		K29-1517-04	KNØB VOLUME		
67	2A		K29-1446-04	KNØB ASSY POWER		
68	3A		K29-1512-04	KNØB ASSY TUNER		
69	3A		K29-1514-04	KNØB ASSY TAPE A		
70	3A		K29-1515-04	KNØB ASSY TAPE B		
71	3A		K29-1513-04	KNØB ASSY AUX		
△ L1	1B		LD1-3391-05	POWER TRANSFORMER	K	
△ L1	1B		LD1-3392-05	POWER TRANSFORMER	E	
△ L1	1B		LD1-3396-05	POWER TRANSFORMER	UMUEX	
△ L1	1B		LD1-3396-05	POWER TRANSFORMER	T	
△ L1	1B		LD1-3397-05	POWER TRANSFORMER	P	
72	1D		N08-0128-35	BINDING POST		
△ S1	2B		S40-1073-05	PUSH SWITCH (POWER)		
△ S2	1D		S31-2001-05	SLIDE SWITCH (IMP SW)	UMUEX	
△ S2	1D		S31-2001-05	SLIDE SWITCH (IMP SW)	TE	
△ S2	1D		S31-2068-05	SLIDE SWITCH (IMP SW)	KP	
POWER AMP (X07-2090-12)						
C1 ,.2			CE04FW1H010M	ELECTRO 1UF 50WV		
C3 ,.4			CC45FSL1H221J	CERAMIC 220PF J		
C5 ,.6			CE04FW1A101M	ELECTRO 100UF 10WV		
C13 ,.14			CC45FSL1H330J	CERAMIC 33PF J		
C15 ,.16			CC45FSL1H180J	CERAMIC 18PF J		
C19 ,.20			CC45FSL1H050C	CERAMIC 5.0PF C		
C21			CE04FW1E220M	ELECTRO 22UF 25WV		
C31 ,.32			CE04FW1H330M	ELECTRO 33UF 50WV		
C37 ,.38			CE04FW1J101M	ELECTRO 100UF 63WV		
C39 -42			CF92FV1H104J	MF 0.10UF J	TE	
C41 ,.42			CF92FV1H473J	MF 0.047UF J	KPUM	
C41 ,.42			CF92FV1H473J	MF 0.047UF J	UEX	
C51 ,.52			CE04FW1E220M	ELECTRO 22UF 25WV		
C54			CE04FW1H100M	ELECTRO 10UF 50WV		
C55			CE04FW1H010M	ELECTRO 1UF 50WV		
△ C56 ,.57			CK45E2H103P	CERAMIC 0.01UF P		
C58 ,.59			CE04FW1A221M	ELECTRO 220UF 10WV		
C60			CE04FW1A470M	ELECTRO 47UF 10WV		
C61			CE04FW1A470M	ELECTRO 47UF 10WV		
101	2C		N09-0333-05	TAPPING SCREW		
R15 ,.16		*	RD14AB2E181J	FL-PROOF RD 180 J 2E		
R21 ,.22			RD14GB2E271J	FL-PROOF RD 270 J 2E		
R31 ,.32			RS14GB3A332J	FL-PROOF RS 3.3K J 3A		
R33 ,.34			RS14GB3A472J	FL-PROOF RS 4.7K J 3A		
R35			RD14GB2E330J	FL-PROOF RD 33 J 2E		

E: Scandinavia & Europe H: Audio Club K: USA P: Canada
 S: South Africa T: England U: PX(Far East, Hawaii)
 UE: AAFES(Europe) X: Australia M: Other Areas

△ indicates safety critical components

PARTS LIST

* New Parts
 Parts without Parts No. are not supplied.
 Les articles non mentionnés dans le Parts No. ne sont pas fournis
 Teile ohne Parts No. werden nicht geliefert

Ref. No. 参照番号	Address 位置	New Parts 新	Parts No. 部品番号	Description 部品名 / 規格	Desti- nation 仕 向	Re- marks 備考
R36		*	RD14AB2E330J	FL-PROOF RD 33 J 2E		
R37			RD14GB2E330J	FL-PROOF RD 33 J 2E		
R38		*	RD14AB2E330J	FL-PROOF RD 33 J 2E		
R39 ,40		*	RD14AB2E151J	FL-PROOF RD 150 J 2E		
R41		*	RD14AB2E331J	FL-PROOF RD 330 J 2E		
R42			RD14GB2E331J	FL-PROOF RD 330 J 2E		
R43 ,44		*	RD14AB2E331J	FL-PROOF RD 330 J 2E		
R49 ,50			R90-0187-05	MULTI-COMP 0.22X2 K 3H		
R59 ,60			RS14GB3D100J	FL-PROOF RS 10 J 3D		
R61 ,62		*	RD14AB2EB20J	FL-PROOF RD 82 J 2E		
R72 ,73			RS14GB3D121J	FL-PROOF RS 120 J 3D	KPUM	
R72 ,73			RS14GB3D121J	FL-PROOF RS 120 J 3D	UEX	
R72 ,73			RS14GB3D151J	FL-PROOF RS 150 J 3D	TE	
R75			RS14GB3A222J	FL-PROOF RS 2.2K J 3A		
R76			RS14GB3A272J	FL-PROOF RS 2.7K J 3A		
△ R77			RS14GB3D331J	FL-PROOF RS 330 J 3D		
R78		*	RD14GB2H752J	FL-PROOF RD 7.5K J 2H		
R84		*	RD14AB2EB20J	FL-PROOF RD 82 J 2E		
R87			RS14GB3A122J	FL-PROOF RS 1.2K J 3A		
VR1 ,2			R12-0087-05	TRIMMING PNT. 200(B) BIAS		
RL1			S51-2060-05	MAGNETIC RELAY (PROTECTION)		
D5 ,6		*	RD18E(B2)	ZENER DIODE		
D10			1S1555	DIODE		
D10			1S2076	DIODE		
△ D11 -14			GP250E	DIODE		
D15 ,16			STV-4H	VARISTOR		
D17			RD24E(B2)	ZENER DIODE		
D21			RD12E(B2)	ZENER DIODE		
IC1			UPC1237H	IC (PROTECTION)		
Q1 -4			2SA992(F,E)	TRANSISTOR (1ST AMP)		
Q5 -8			2SC1845(F,E)	TRANSISTOR (2ND AMP)		
Q17 ,18			2SC2591(R,S)	TRANSISTOR (DRIVER)		
Q19 ,20			2SA1111(R,S)	TRANSISTOR (DRIVER)		
△ Q21 ,22			2SC3263(B,Y)	TRANSISTOR (POWER)		
△ Q23 ,24			2SA1274(B,Y)	TRANSISTOR (POWER)		
Q25			2SC1827(B,Y)	TRANSISTOR (REGULATOR)		
Q26			2SA769(B,Y)	TRANSISTOR (REGULATOR)		
Q28			2SA999(E,F)	TRANSISTOR (POWER SUPPLY CONT.)		
△ Q30			2SC2003(L,K)	TRANSISTOR (REGULATOR)		
TONE AMP (X11-1930-11)						
D1 -4			B30-0499-05	LED (SELECTOR)		
D5			B30-0500-05	LED (TAPE B)		
D6			B30-0777-05	LED (PHONE REC)		
PL1			B30-0372-05	LAMP (POWER) 12V 0.11A		
C1 ,2			CE04FW1H100M	ELECTRO 10UF 50WV		
C3 ,4			CC45FSL1H101J	CERAMIC 100PF J	KPUM	
C3 ,4			CC45FSL1H101J	CERAMIC 100PF J	UEX	
C3 ,4			CC45FSL1H221J	CERAMIC 220PF J	TE	
C5 ,6			CK45FB1H222K	CERAMIC 2200PF K	TE	
C5 ,6			CK45FB1H561K	CERAMIC 560PF K	KPUM	
C5 ,6			CK45FB1H561K	CERAMIC 560PF K	UEX	
C7 ,8			CE04FW1A470M	ELECTRO 47UF 10WV		
C9 ,10			CF92FV1H123J	MF 0.012UF J		
C11 ,12			CF92FV1H332J	MF 3300PF J		

E: Scandinavia & Europe H: Audio Club K: USA P: Canada
 S: South Africa T: England U: PX (Far East, Hawaii)
 UE: AAFES (Europe) X: Australia M: Other Areas

△ indicates safety critical components

PARTS LIST

* New Parts
 Parts without Parts No. are not supplied.
 Les articles non mentionnés dans le Parts No. ne sont pas fournis.
 Teile ohne Parts No. werden nicht geliefert.

Ref. No. 参照番号	Address 位置	New Parts 新	Parts No. 部品番号	Description 部品名 / 規格	Desti- nation 仕 向	Re- marks 備考
C13 ,14 C15 ,16 C17 ,18 C19 ,20 C21 ,22			CE04FW1H2R2M CE04FW1HOR1M CF92FV1H333J CE04FW1H3R3M CC45FSL1H221J	ELECTRO 2.2UF 50WV ELECTRO 0.1UF 50WV MF 0.033UF J ELECTRO 3.3UF 50WV CERAMIC 220PF J		
C23 -26 C27 -30 C31 ,32 C33 ,34 C35 -40			CK45FB1H561K CE04FW1H100M CF92FV1H104J CK45FB1H102K CE04FW1H100M	CERAMIC 560PF K ELECTRO 10UF 50WV MF 0.10UF J CERAMIC 0.001UF K ELECTRO 10UF 50WV		
C41 ,42 C43 -47 C49 -56 C68 ,69 C70 ,71			CE04FW1H2R2M CK45FF1H103Z CK45FB1H561K CE04FW1H010M CK45FF1H103Z	ELECTRO 2.2UF 50WV CERAMIC 0.01UF Z CERAMIC 560PF K ELECTRO 1UF 50WV CERAMIC 0.01UF Z	TE	
201 203 206 - -	2B 1C 1C		E11-0135-05 E13-0217-05 E20-0820-05 E13-0434-05 E13-0622-05	PHONE JACK (HEADPHONE) PHONE JACK (2P) LOCK TERMINAL BOARD (SPEAKERS) PHONE JACK (4P) PHONE JACK (6P)		
L1 ,2			L39-0085-05	PHASE-COMPENSATION COIL		
R65 ,66 R67 ,68 R69 VR1 VR2			RD14GB2E2R2J RS14GB3D391J RS14GB3A560J R06-5087-05 R01-5041-05	FL-PROOF RD 2.2 J 2E FL-PROOF RS 390 J 3D FL-PROOF RS 56 J 3A POTENTIOMETER 100K VOLUME POTENTIOMETER 200K(W) BALANCE		
VR4 ,5 VR6 ,7		*	R06-5116-05 R06-5117-05	POTENTIOMETER 100K TONE POTENTIOMETER 100K TURNOVER		
S1 S2 S3		*	S42-6016-05 S40-2323-05 S42-5037-05	MULTIPLE PUSH SWITCH(SELECTOR) PUSH SWITCH (TONE) PUSH SW(MODE, SP, LOUD, SUBSONIC)		
IC1 IC2 IC3 Q1 -4			LA645BSS AN6555 AN6556 2SC1845(F,E)	IC (EQ AMP) IC (TONE AMP) IC (TONE AMP) TRANSISTOR (CONTROLLER)		
POWER SUPPLY (X13-4340-11)						
C1 C3			CE04FW1H4R7M CK45F1H103Z	ELECTRO 4.7UF 50WV CERAMIC 0.01UF Z		
Δ F1 Δ F1 Δ F1 Δ F2 Δ F2 - -			F05-3121-05 F05-6021-05 F05-6027-05 F05-3022-05 F05-3121-05 J13-0041-05 J13-0055-05	FUSE (SEMKO) FUSE (UL) FUSE (UL) FUSE (SEMKO) FUSE CLIP FUSE CLIP		UMJEX KP UMJEX T UMJEX KPTE
Δ S1 D1			S31-2083-05 W06B	SLIDE SWITCH (POWER VOLTAGE) DIODE		UMJEX

E: Scandinavia & Europe H: Audio Club K: USA P: Canada

S: South Africa T: England U: PX(Far East, Hawaii)

UE: AAFES(Europe) X: Australia M: Other Areas

⚠ indicates safety critical components.