

STEREO INTEGRATED AMPLIFIER

# KA-56

## SERVICE MANUAL

# KENWOOD

©1987-4 PRINTED IN JAPAN  
B51-3200-00(T)1,472

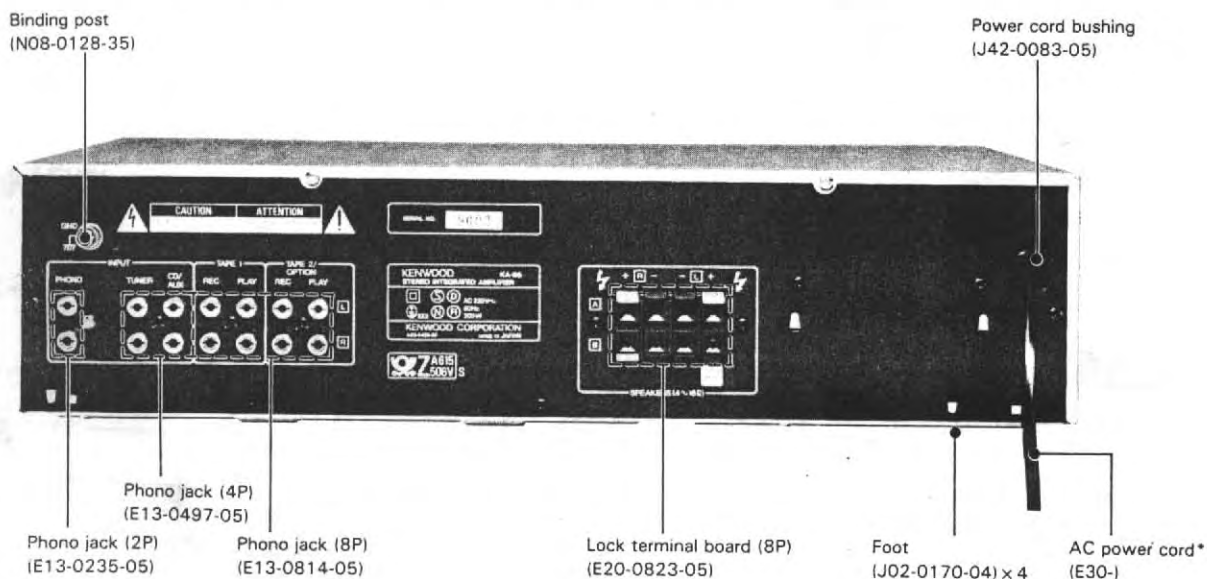
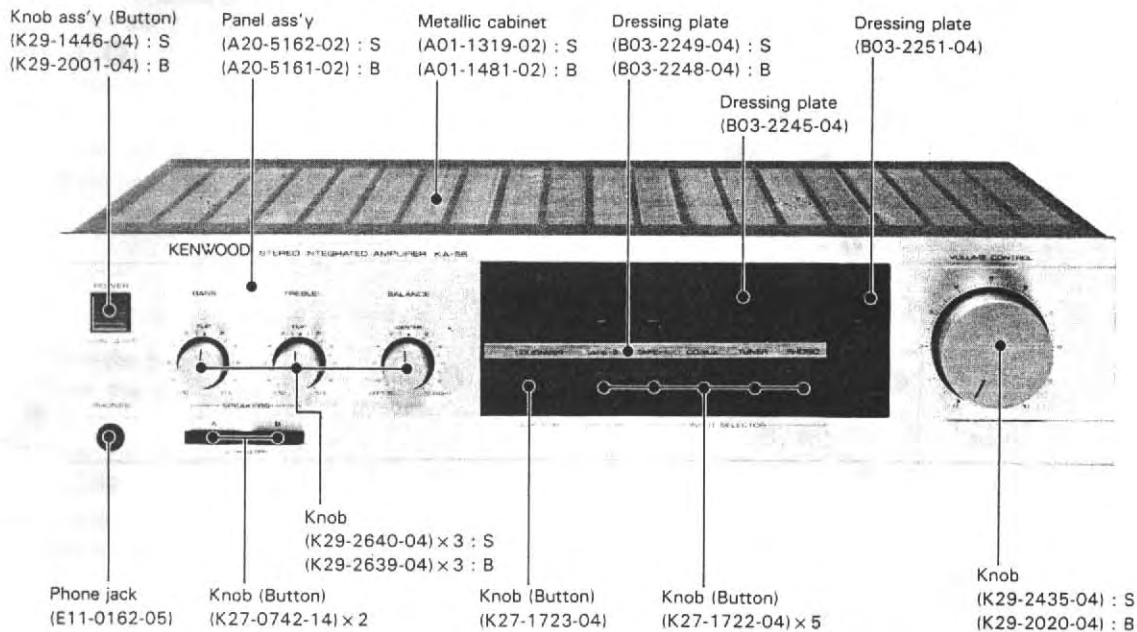

\* Refer to parts list on page 16.  
Photo is KA-56 (Silver version).  
S: Silver version.  
B: Black version.

(X09-2402-72) (A/5)

(X85-1032-72)

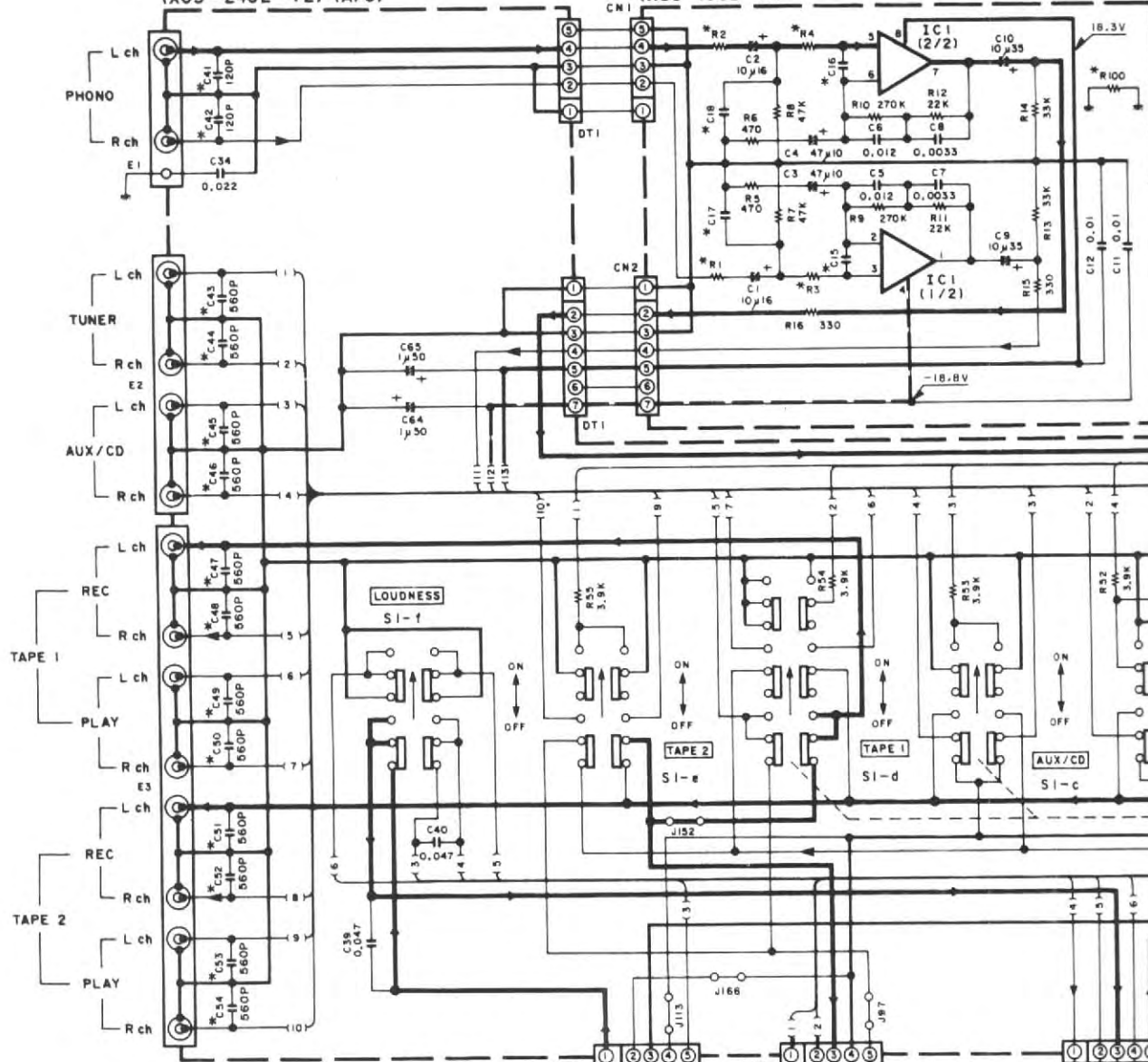

(X11-2382-70) IC1: µPC4570C

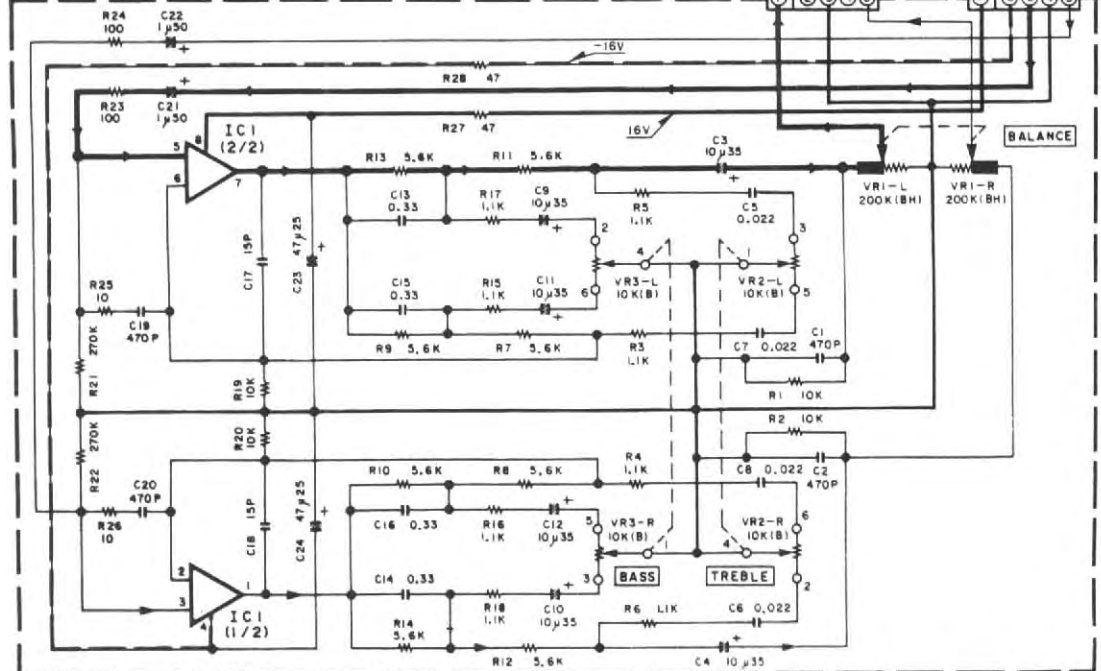

2

3

4

5

6

7

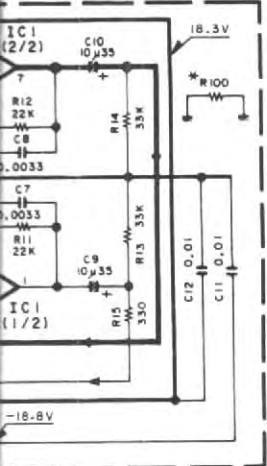

(X85-1032-72)  
 IC1 : AN6556 or M5218P

(X85-1050-12)  
 Q1-4 : 2SC1845(F,E)  
 Q5-8 : 2SA733(A)(Q,P) or 2SA999(E,F)  
 Q9-14 : 2SC2632(Q,R,S)  
 Q15,16 : 2SA1124(Q,R,S)  
 D1-6 : ISS176 or ISS133

(X85-103K-KK)

DESTINATION	No.	R1,2	R3,4	R100	C15,16	C17,18
E	2-72	1K	100	33	2200P	220P
M,X,T,P	0-11	100	J	22	560P	100P

(X85-1050-12)

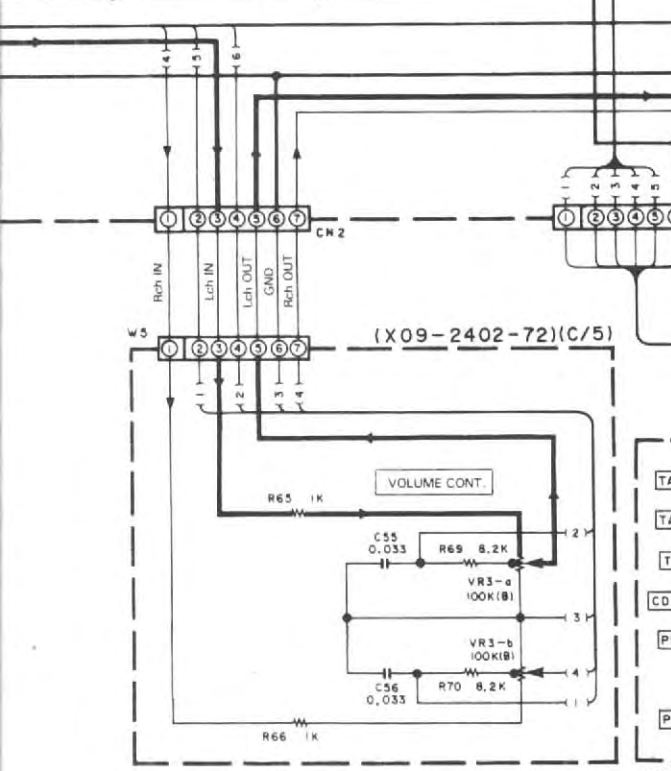
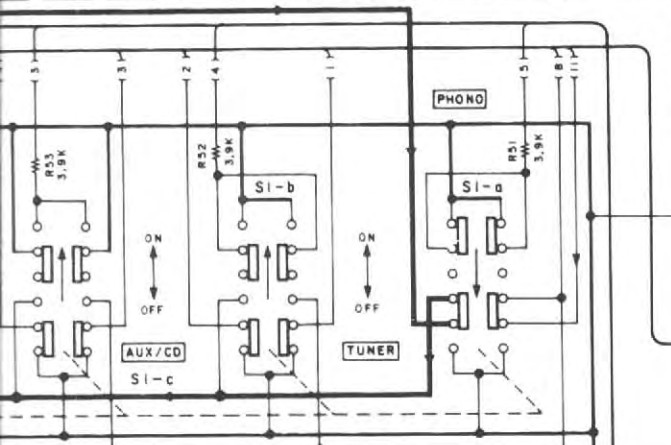
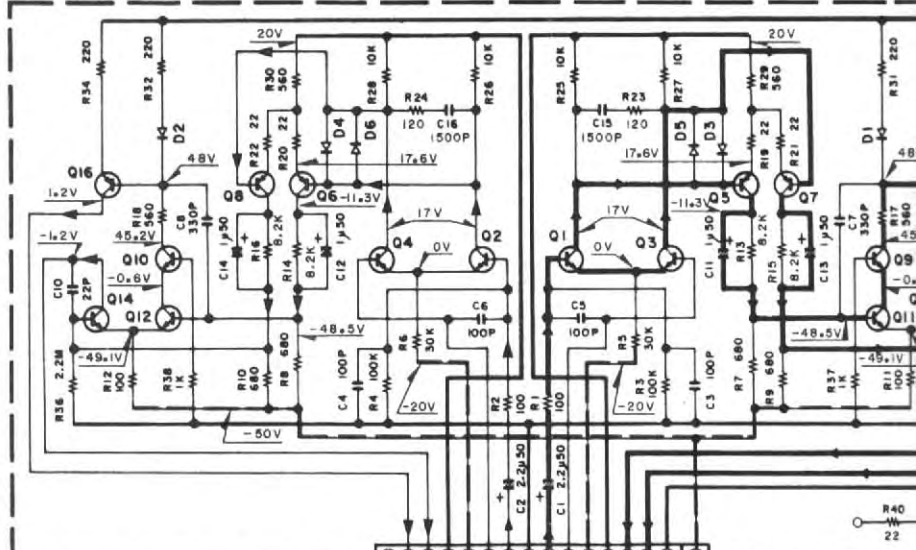

(X09-2402-72)(E/5)

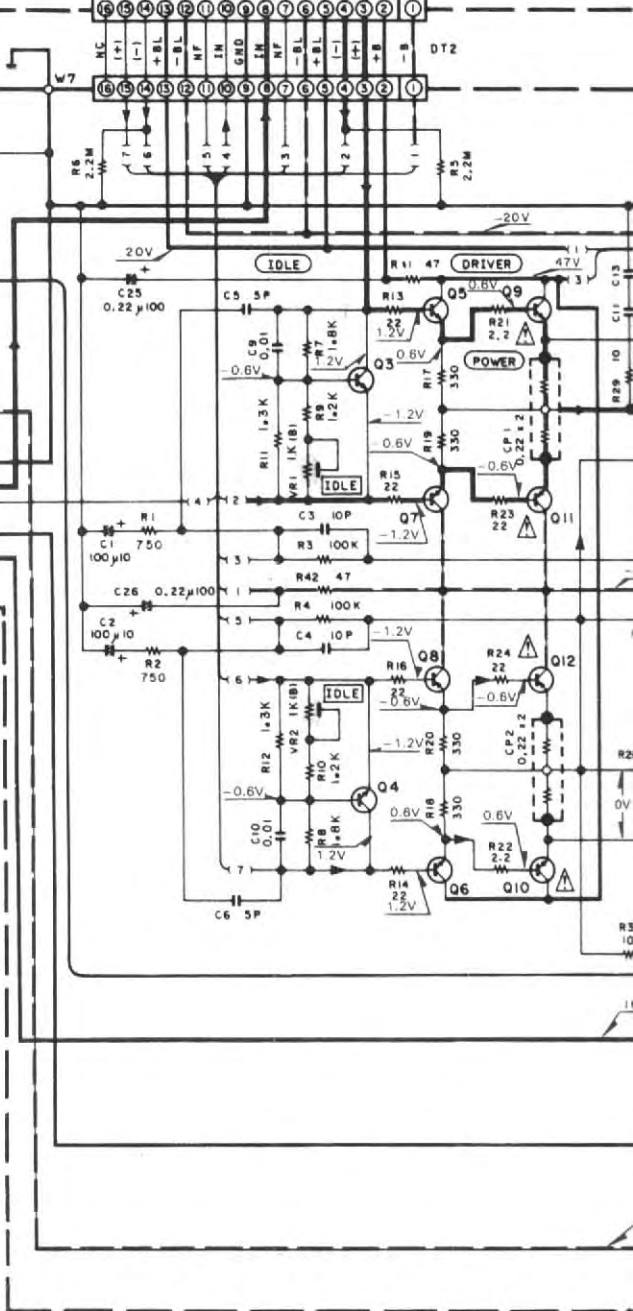

(X09-2402-72)

IC1 :  $\mu$ PC1237HA

(X09-2402-72) (B/5)

- Q3, 4 : 2SC3419(Y)
- Q5, 6 : 2SC3244
- Q7, 8 : 2SA1284
- Q9, 10 : 2SC3855
- Q11, 12 : 2SA1491
- Q13, 14 : 2SA733(A)(Q,P)

- D1, 2 : RD20ES(B) or HZS20S(B)
- D3, 4, 19, 20 : RD16ES(B) or HZS16S(B)
- D7, 8, 28, 29 : ISS133 or ISS176
- D9-12 : DSM1A1
- D21 : RBV-402LFA
- D22-27 : B30-0431-05

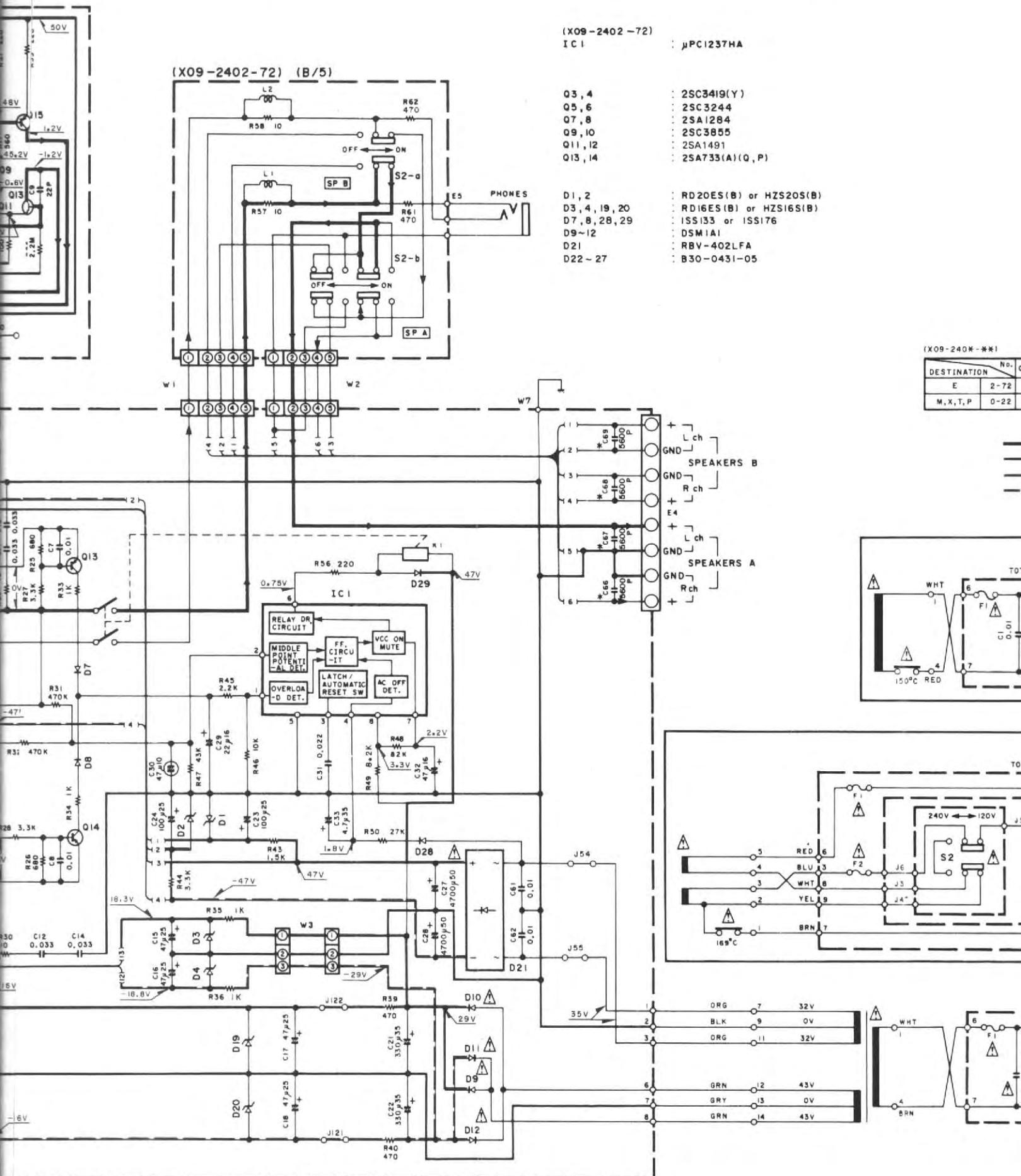

(X09-240K-\*)

DESTINATION	No.
E	2-72
M, X, T, P	0-22

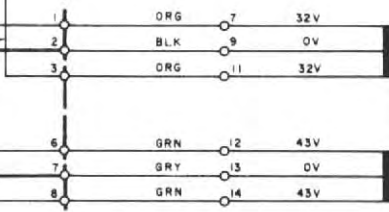
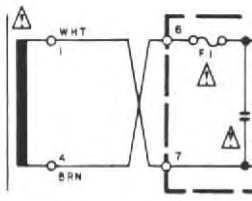
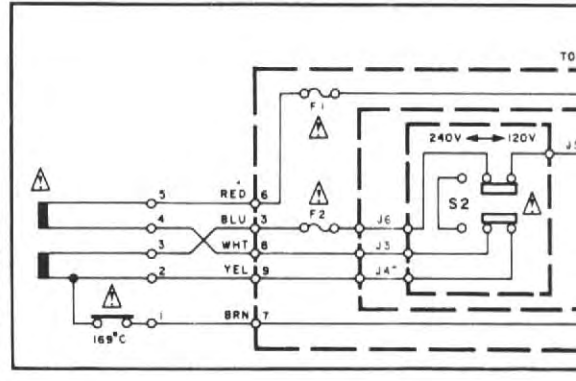
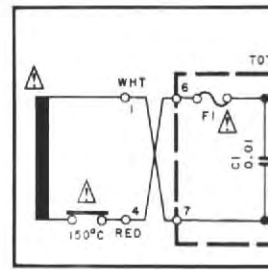

(X09-240X-##)

DESTINATION	No.	C41~54	C66~70
E	2-72	YES	YES
M, X, T, P	0-22	NO	NO



(P) TYPE

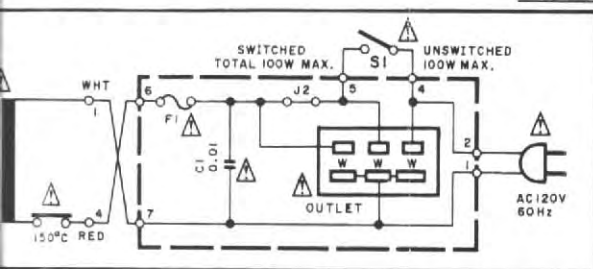

(M) TYPE

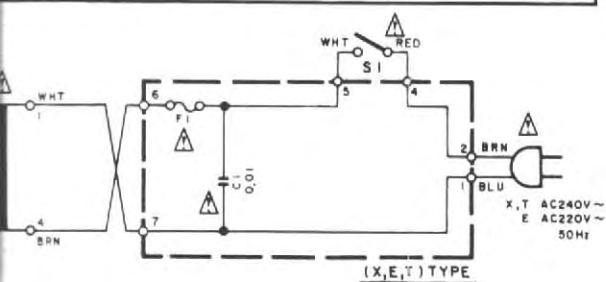
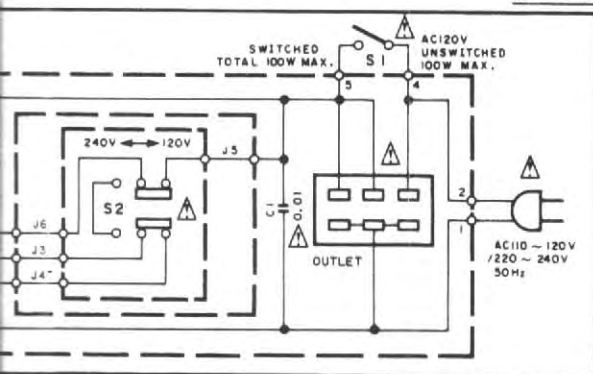

2SA1124  
 2SA1284  
 2SA733(A)  
 2SA999  
 2SC1845  
 2SC2632  
 2SC3244

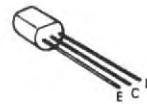

2SA1491  
 2SC3855

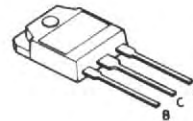

2SC3419



AN6556  
 M5218P  
 μPC4570C



μPC1237HA

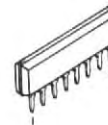

DC voltages are as measured with a high impedance voltmeter with no signal input. Values may vary slightly due to variations between individual instruments or/and units.

Les tensions c.c. doivent être mesurées avec un voltmètre à haute impédance sans signal d'entrée. Les valeurs peuvent différer légèrement du fait des variations inhérentes aux appareils et aux instruments de mesure individuels.

Die angegebenen Gleichspannungswerte wurden mit einem hochohmigen Spannungsmesser ohne Eingangssignal gemessen. Dabei schwanden die Meßwerte aufgrund von Unterschieden zwischen einzelnen Instrumenten oder Geräten u.U. geringfügig.

**CAUTION:** For continued safety, replace safety critical components only with manufacturer's recommended parts (refer to parts list). Indicates safety critical components. To reduce the risk of electric shock, leakage-current or resistance measurements shall be carried out (exposed parts are acceptably insulated from the supply circuit) before the appliance is returned to the customer.

## ADJUSTMENT/REGLAGES/ABGLEICH

### ADJUSTMENT

No.	ITEM	INPUT SETTINGS	OUTPUT SETTINGS	AMPLIFIER SETTINGS	ALIGNMENT POINTS	ALIGN FOR	FIG.
1	IDLE CURRENT	—	Connect a DC voltmeter across CP1 (L) CP2 (R)	VOLUME: 0	VR1 (L) VR2 (R)	3mV	(a)

### REGLAGES

N°	ITEM	REGLAGE DE L'ENTREE	REGLAGE DE LA SORTIE	REGLAGE DE L'AMPLIFICATEUR	POINS L'ALIGNEMENT	ALIGNER POUR	FIG.
1	COURANT DE POLARISATION	—	Connecter un voltmètre de CC sur CP1 (G) CP2 (D)	VOLUME: 0	VR1 (G) VR2 (D)	3mV	(a)

### ABGLEICH

NR.	GEGENSTAND	EINGANGS-EINSTELLUNG	AUSGANGS-EINSTELLUNG	VERSTÄRKER EINSTELLUNG	ABGLEICH-PUNKTE	ABGLEICHEN FÜR	ABB.
1	LEERLAUFSTROM	—	Einem Gleichspannungsmesser ber CP1 (L) CP2 (R) anschließen.	VOLUME: 0	VR1 (L) VR2 (R)	3mV	(a)

