

* 请参见零部件表

维修底板的拆卸

1. 切断处于维修底板上 ❶ 位置的六个部分，将维修底板从主体壳上取下来。

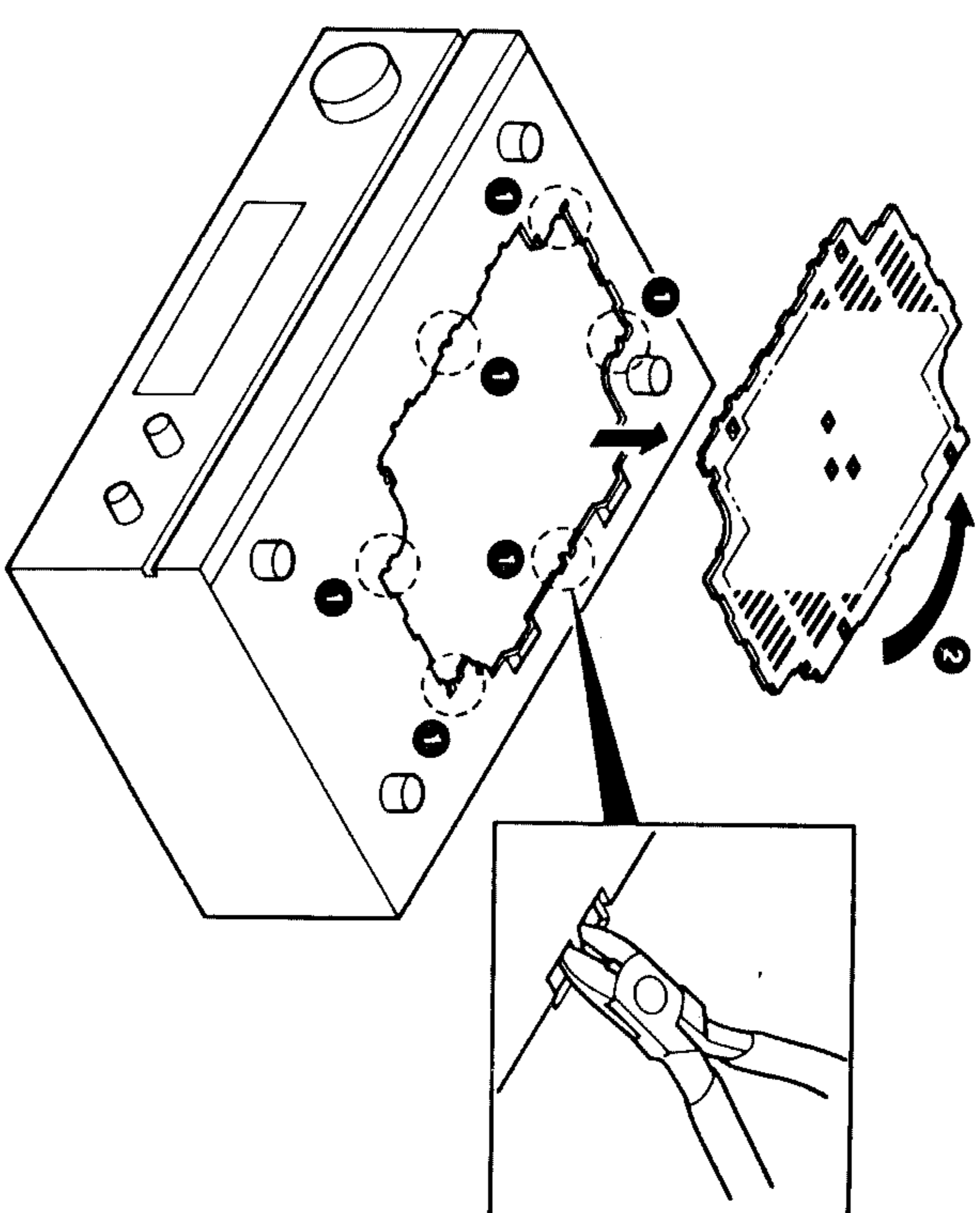

维修完毕之后

2. 将机械组件按照箭头 ❷ 所示方向旋转 180°，将其翻转过来。
3. 将维修底板上的两个卡爪 ❸ 插入主机的凸出槽中
4. 用两个螺钉 (M3×6) ❹ 将维修底盘在主体盘上固定好。

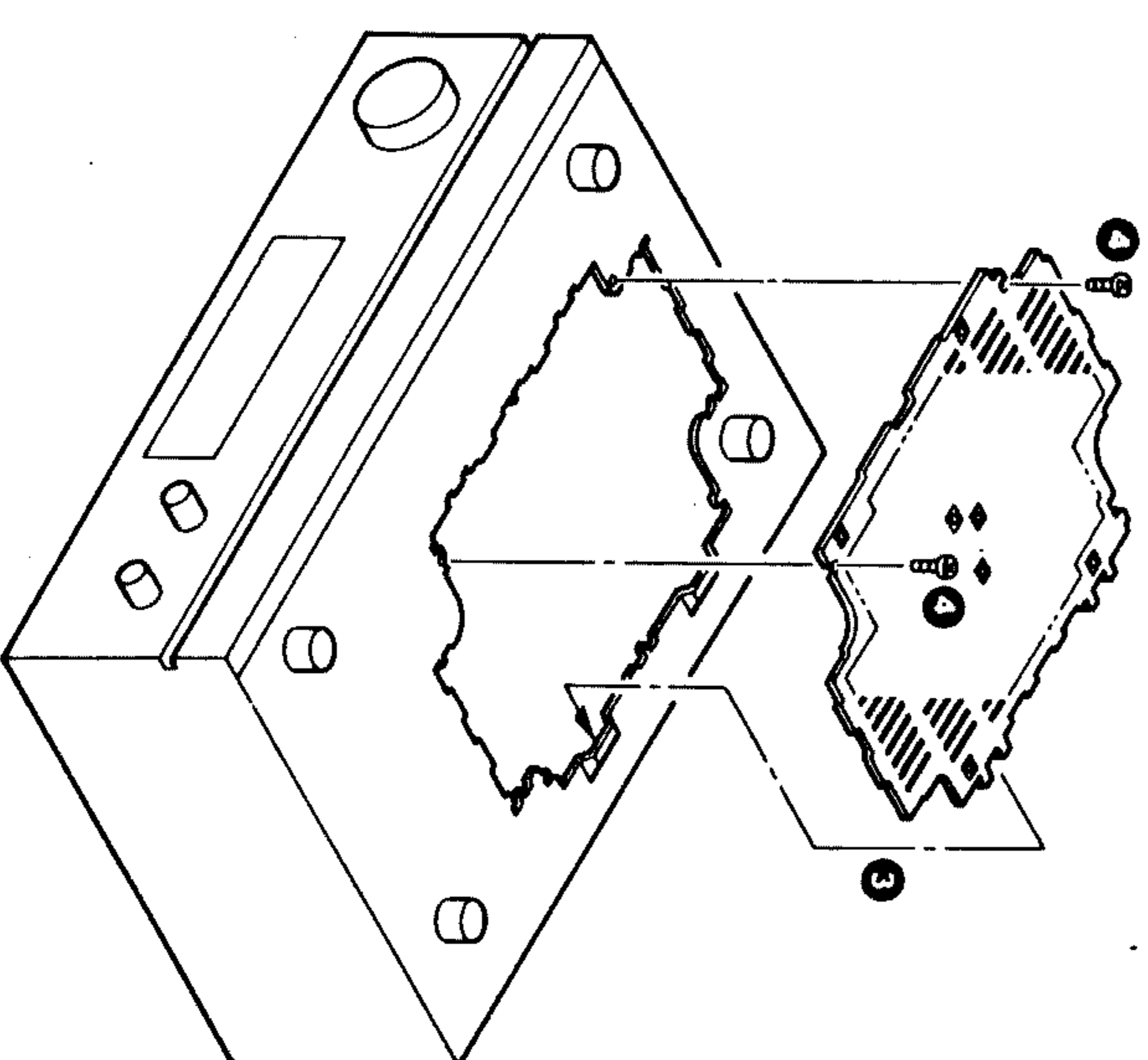

键的功能

No.	元件	输入设定	输出设定	放大器设定	校正点	校正至	图
设定控制部分和开关至: 电源, 开 音箱: B							
1	空载电流	-	通过 CP1 (L) CP2 (R) 连接一个DC电压计	音量: 0	VR1 (L) VR2 (R)	9 mV	(a)

本遥控装置不能用来控制以下所列 CD 唱机的打动搜索功能, 同时也不能作用于数字式功能。(从 1 至 0 以及标有 +10 的按键)

* DP-M97, DP-57, DP-47

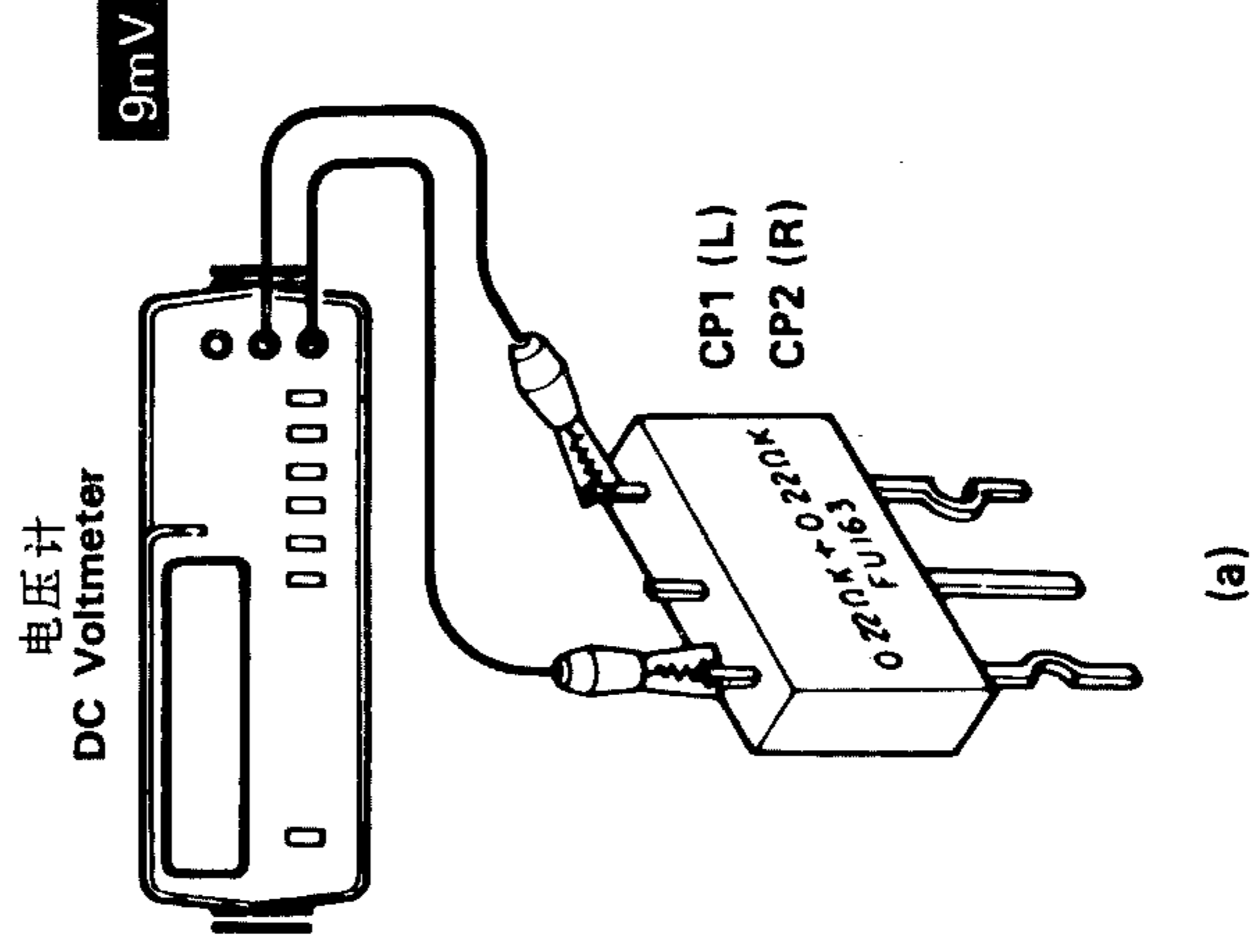
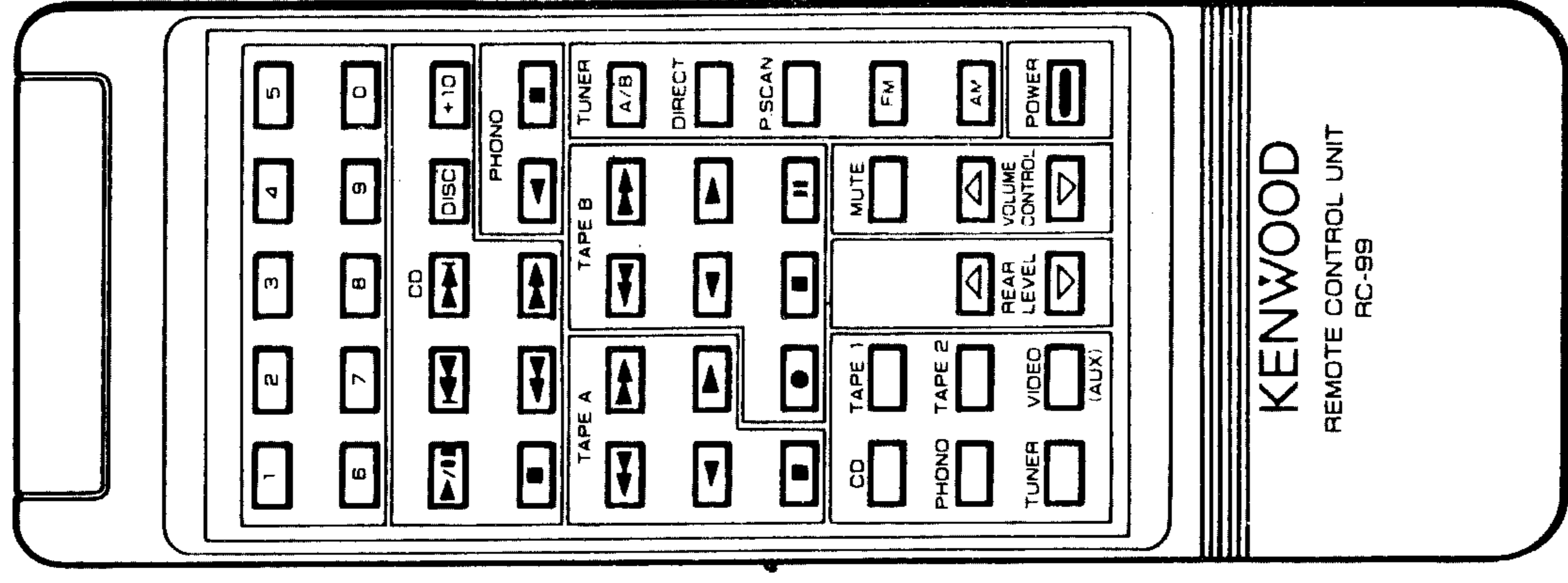

接线图



KA-99, KA-109	X09-308	X11-284
K, P	0-10-(0-11)	0-10 (0-11)
Y	2-91	0-10
M	0-21	0-21
X	0-71	0-10

A B C D E F G H

印刷电路板 (元件一侧图)

AUDIO UNIT

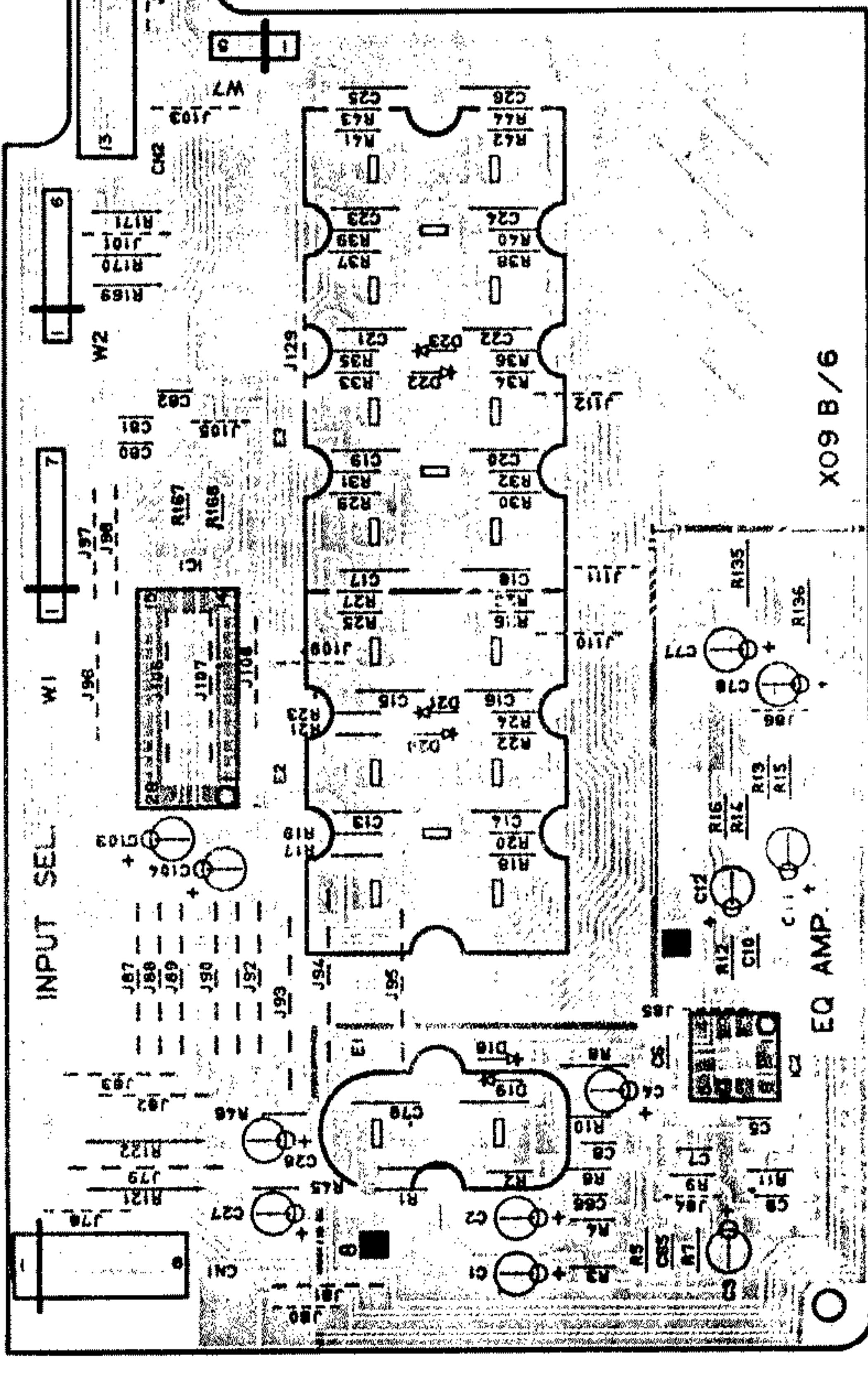
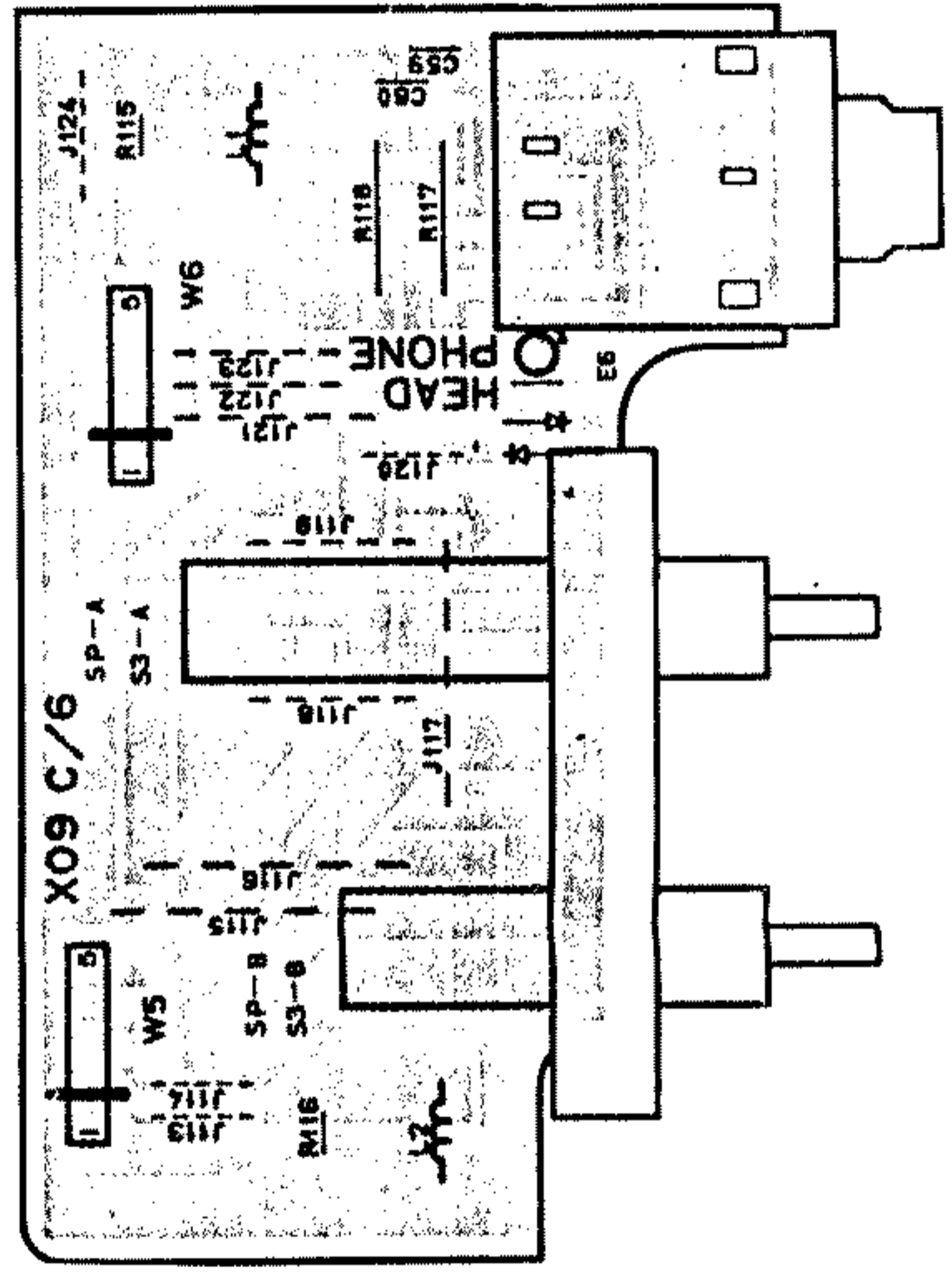
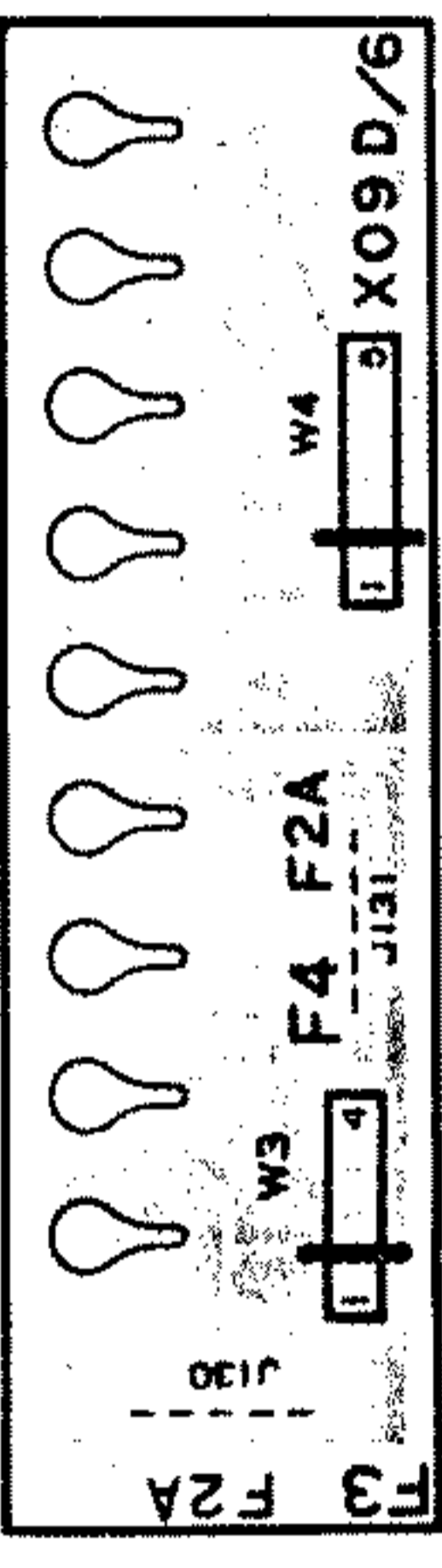
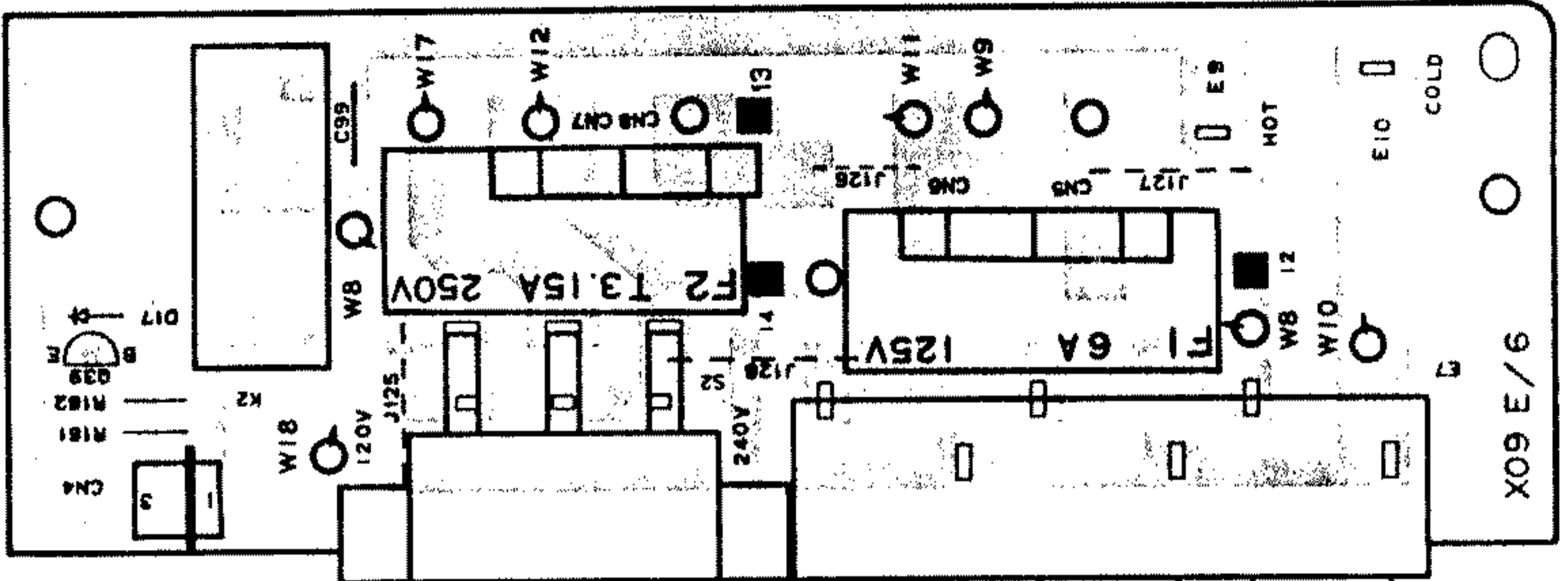
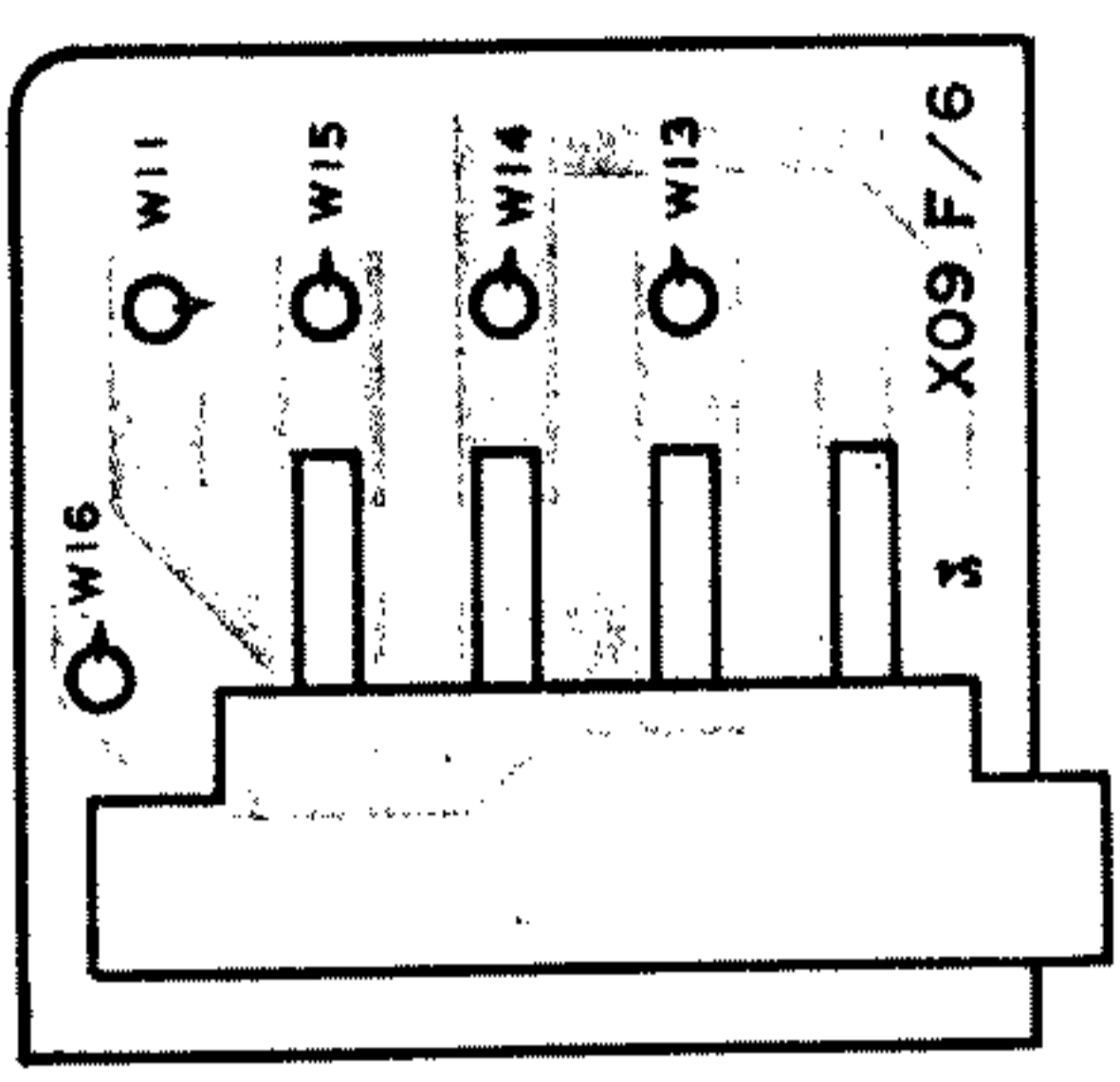
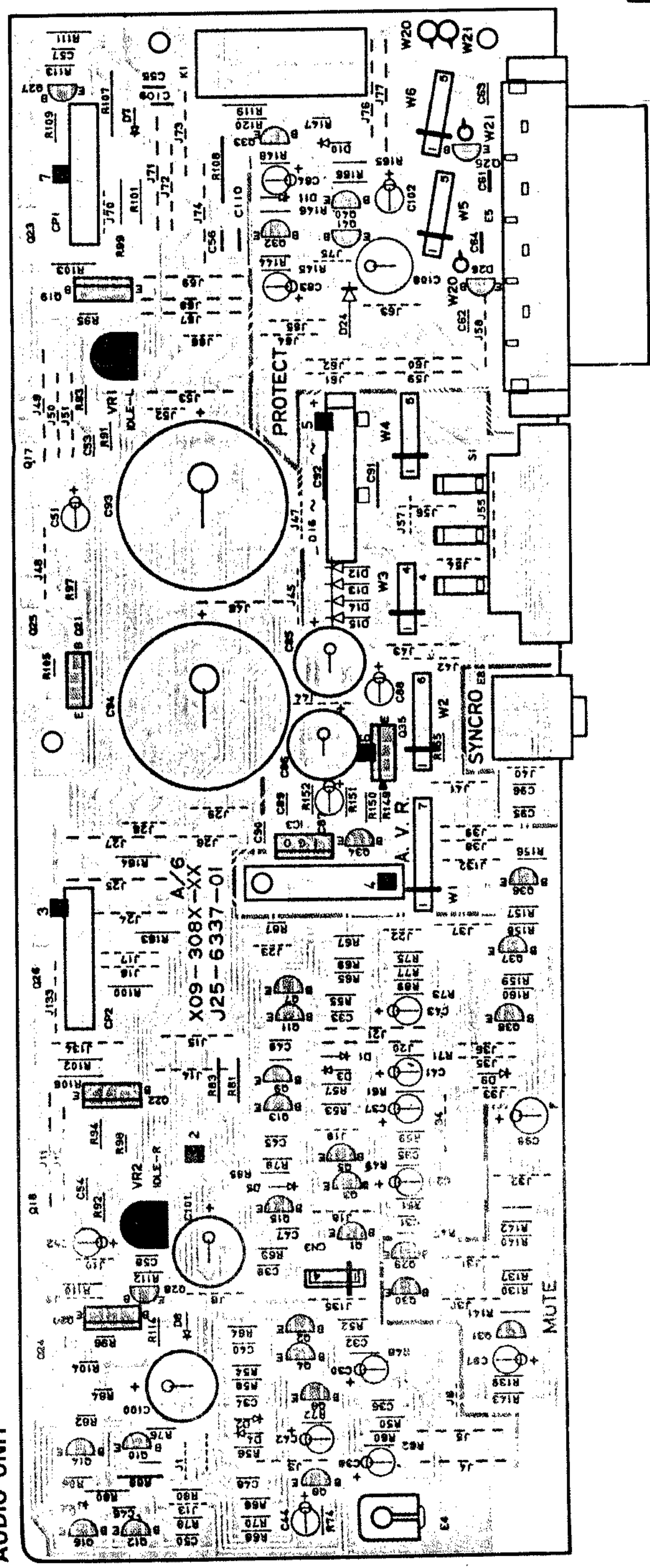

电阻和电容的阻值, 请见电路原理图。

X09-308X-XX

Ref. No.	Address
IC Q	
1	3B
2	3B
3	3B
4	3B
5	3C
6	3B
7	2C
8	3A
9	2C
10	2A
11	2C
12	2A
13	2C
14	2A
15	2B
16	2A
17	
18	
19	2F
20	2B
21	2E
22	2C
23	
24	
25	3G
26	3F
27	2G
28	2B
29	3B
30	3B
31	3B
32	2F
33	2G
34	3D
35	3D
36	3D
37	3C
38	3C
39	3H
40	3G
41	3F
1	5C
2	6B
3	3D

印刷电路板 (元件一侧图)

CONTROL UNIT

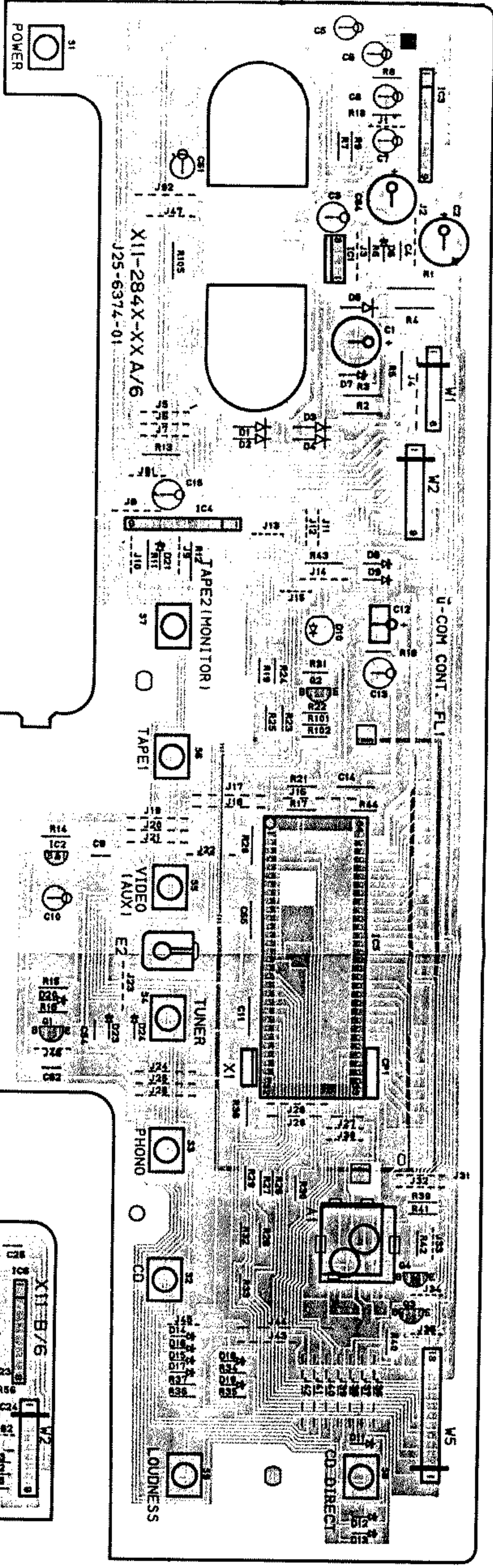

X11-284X-XX

Ref. No.	IC	Q	Address
1		3P	
2		2N	
3		2R	
4		2Q	
5		5R	
6		5R	
7		4L	
8		4L	
1		2L	
2		3Q	
3		2K	
4		3N	
5		2P	
6		3Q	
7		5R	
9		5R	
10		4Q	

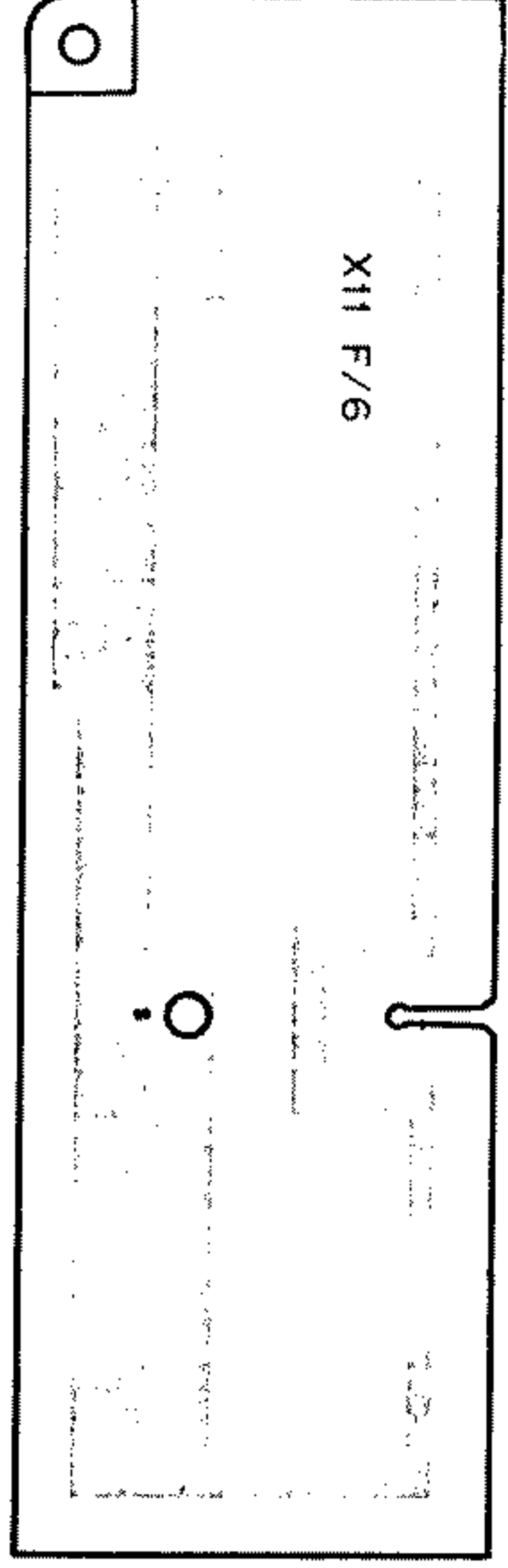
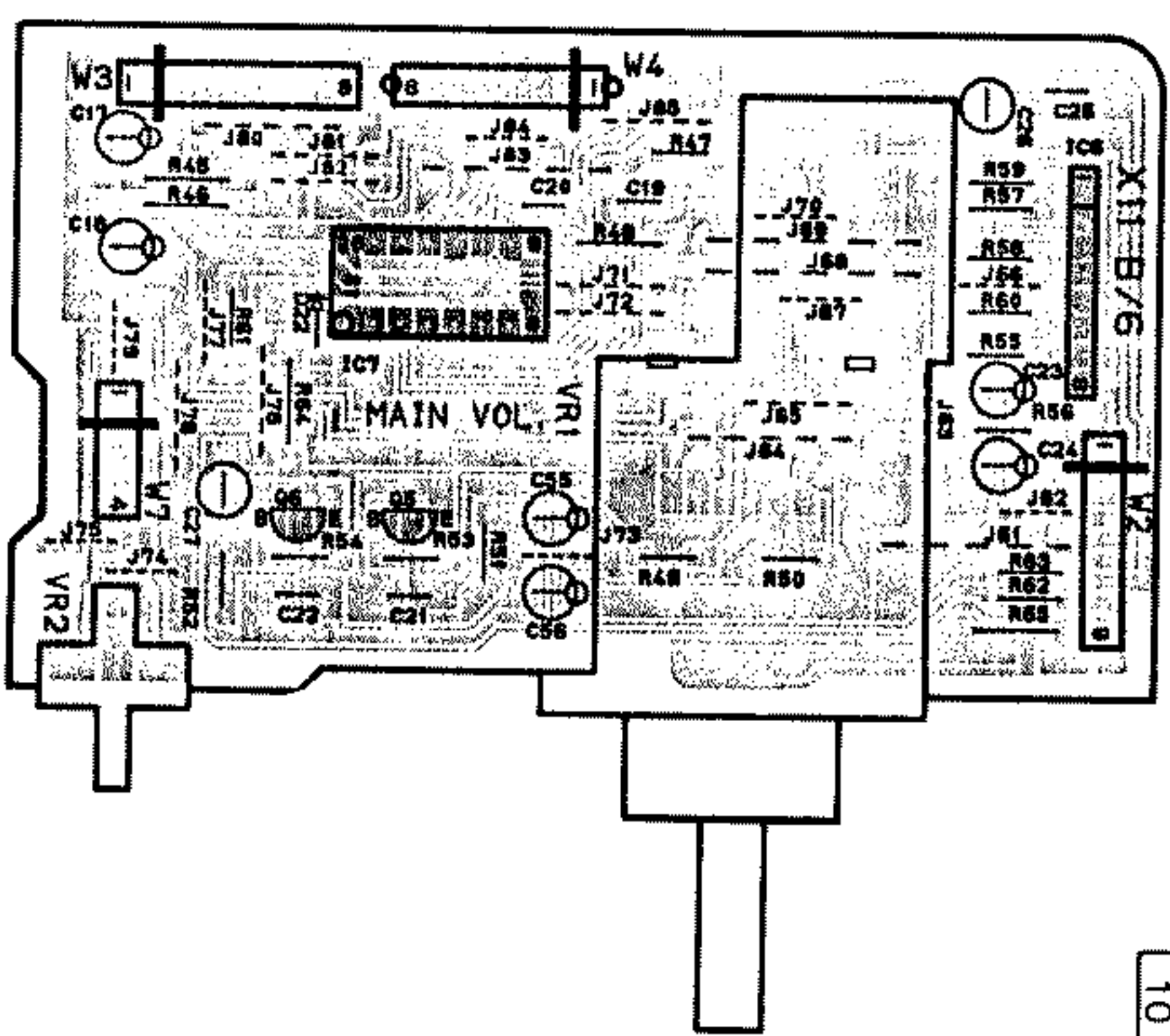
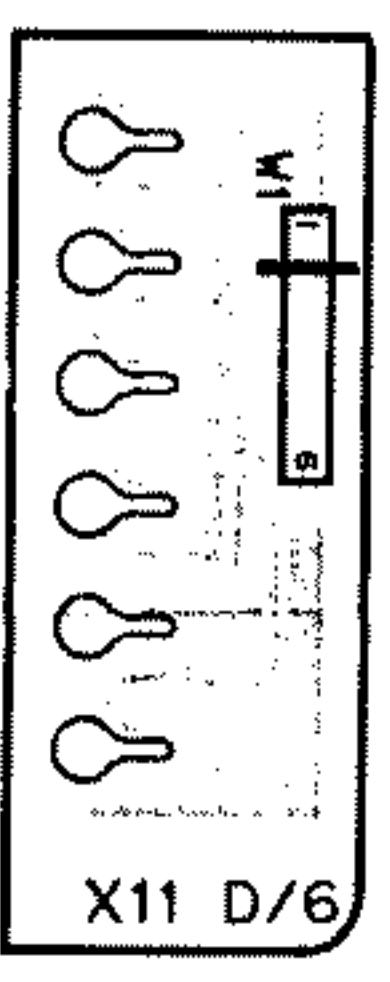
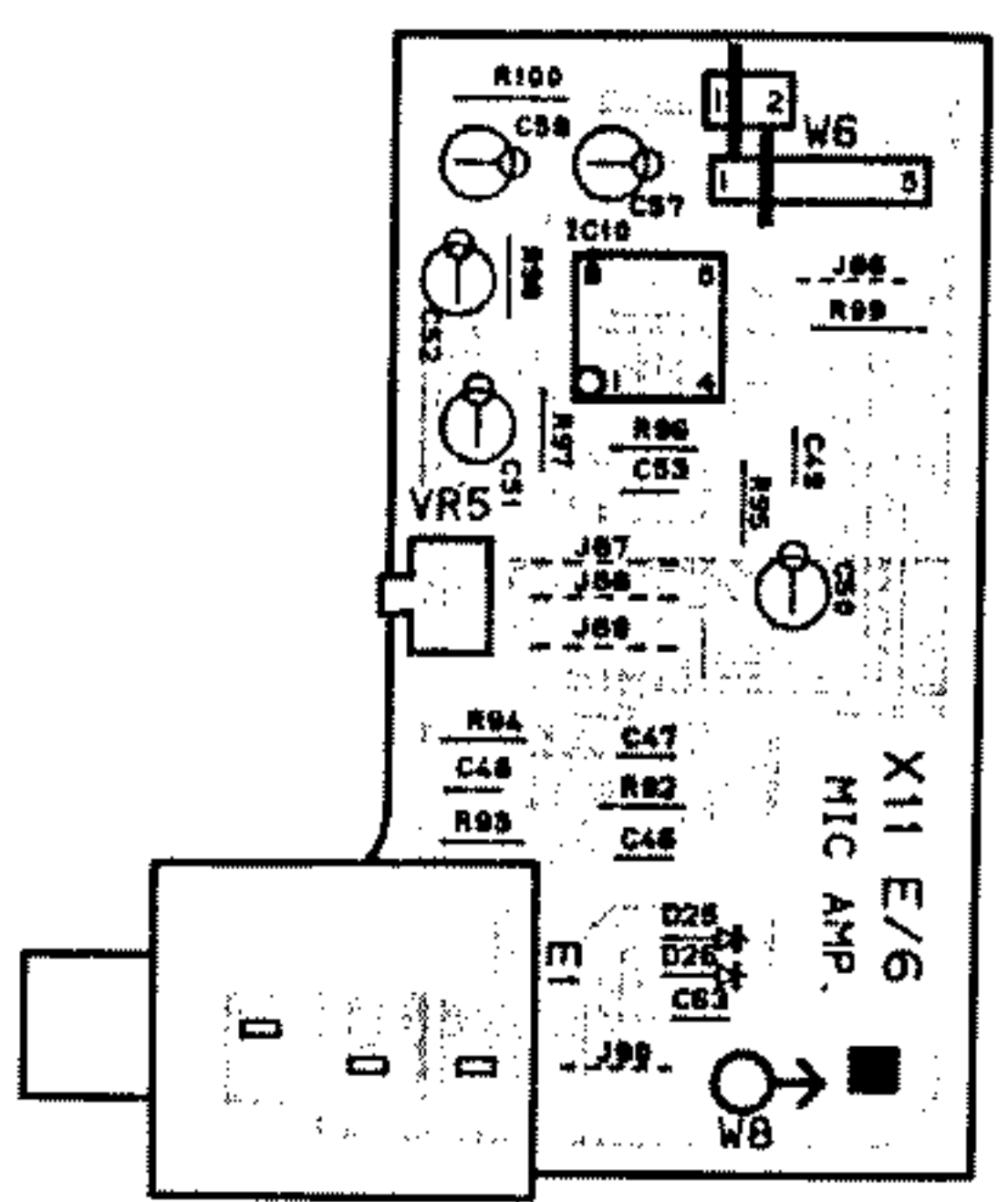
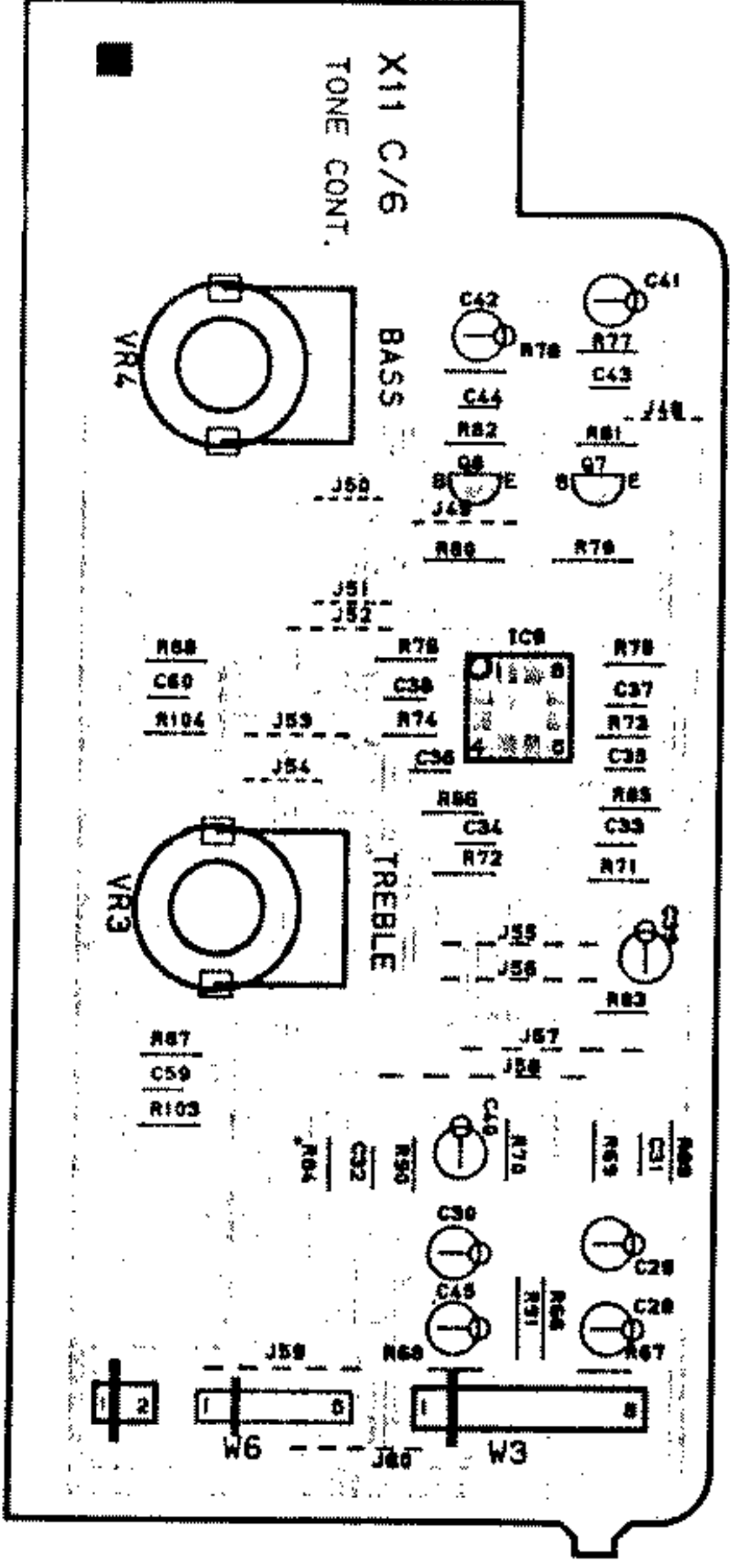

电阻和电容的值，请见电路原理图。

- (X09-3080-10)(A/B)
- IC2 : UPC4870C-A
- IC3 : UPC7812 HF
- Q1~4 : 2SC1845(F,E)
- Q5~8 : 2SA992(F,E)
- Q9~14 : 2SC2632(Q,R,S)
- Q15,16 : 2SA1124(Q,R,S)
- Q17,18 : 2SC4137
- Q19,20 : 2SC3944(Q,R,S)
- Q21,22 : 2SA1555(Q,R,S)
- Q23,24 : 2SC2921
- Q25,26 : 2SA1215
- Q27,28 : 2SC2631(R,S)
- Q29,30 : 2SC2878(B)
- Q32 : 2SA1125(R,S)
- Q33 : 2SA7331(A)(Q,P) or 2SA9335(Q,P)
- Q35 : 2SC2003(L,K)
- Q36 : 2SB941
- Q36,38,40,41 : 2SC9451(A)(Q,P) or 2SC17405(Q,R)
- Q36,38,40,41 : 2SC2631(R,S)
- Q36,38,40,41 : 2SC2878(B)
- D1~10 : 1SS131 or HSS104A
- D11 : P047ES(B) or HZ547(N)(B)
- D12~15,24 : SC565(B)
- D16 : RBY-60PL7A
- D25,26 : MA177

DESTINATION	REP. O-10, O-11	O-21	O-71	O-81	J126	J128	W7-19	W11-18	E7	CNT. 8	S1	S2	S4	F1	F2
SEA-PAK-108	K	NO	NO	NO	NO	NO	NO	NO	NO	NO	NO	NO	NO	NO	NO
KA-88	X	NO	NO	NO	NO	NO	NO	NO	NO	NO	NO	NO	NO	NO	NO
	Y	NO	NO	NO	NO	NO	NO	NO	NO	NO	NO	NO	NO	NO	NO



(X09-308 X-XX)(B/6) JAPAN MADE
(X09-3080-11)(B/6) SINGAPORE MADE

注意：为了有效的安全性，只能按照厂家给出的推荐元件（见零部件表）来更换安全性能要求的元件。表示安全性能要求的元件，为了减少触电的危险，应该在将装置还给用户之前，对元件或电阻进行测量（在露在外部的零部件均与电源电路绝缘的情况下进行测量）。

● 直流电压用高阻电压表来测量。电压值会有轻微的变动，因有测量仪器以及被测部件的变化。



(XII-284X-XX1A/6)

(XII-284X-XX1I/6)

FL1	F1P7AMTR
IC1	UPC7805H
IC2	M31931ASL
IC3	BA6158
IC4	TAB4095
IC5	M50940-1975P
01~4	25C94(A)1Q, P10r 25C17405(Q,R)
D1~5	559668
D6, 8, 9, 11~20, 23, 24	155133 or H59104
D7	R05, 65S1B21 or H255 6N1B21
D21	R03, 95S1B21 or H253 9N1B21
A1	F1P7AMTR

E: 斯堪的那维亚和欧洲
 PX(远东、夏威夷)
 Y: AAFES(欧洲)
 K: 美国
 T: 英国
 X: 澳大利亚
 P: 加拿大
 M: 其他地区(包括中国)

DESTINATION	R# NO	RES	R# NO	RES
KA-99 KA409	4P	0-10	NO	47K
KA-99 KA409	X	0-11	NO	47K
KA-99	M	0-21	100K	47K

(XII-284X-XX1E/6)
 IC6 NUM35L Q 6 25C28781(B)
 IC7 TC9215P D22 15S133 or H59104
 IC8 3082-911E/6
 IC9 UP4570C-A Q7 8 25C18451F(E)
 IC10 UP4370C-A D25 26 15S133 or H59104
 KA 99
 (M) TYPE ONLY

说明

- 2SA1123
- 2SA1124
- 2SA733 (A)
- 2SA992
- 2SA1845
- 2SC2003
- 2SC2631
- 2SC2632
- 2SC2878
- 2SC945 (A)

- 2SA933S
- 2SC1740S

- 2SA1215
- 2SC2921

- 2SC4137

- 2SA1535
- 2SB941
- 2SC3944

- TC9215P

- TA8409S

- BA6138

- μPC4570C-A
- μPC7805H
- μPC7812HF

- M51951ASL

- TC9163N

- NJM4555L

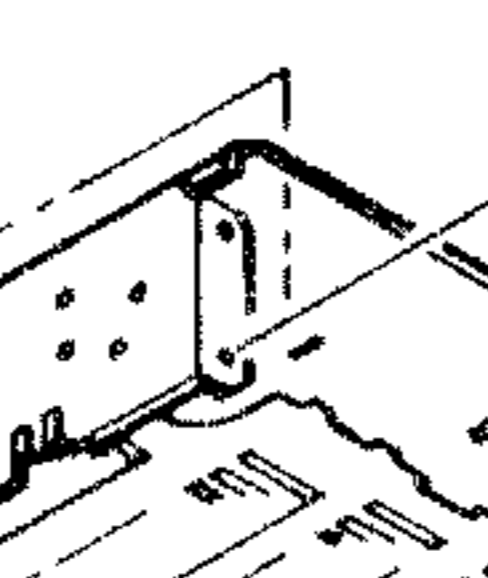
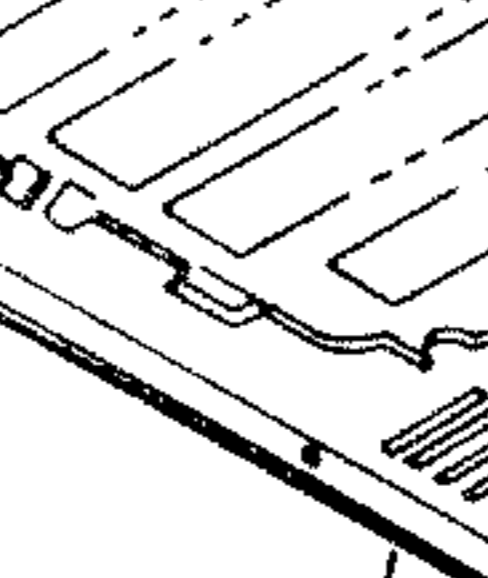
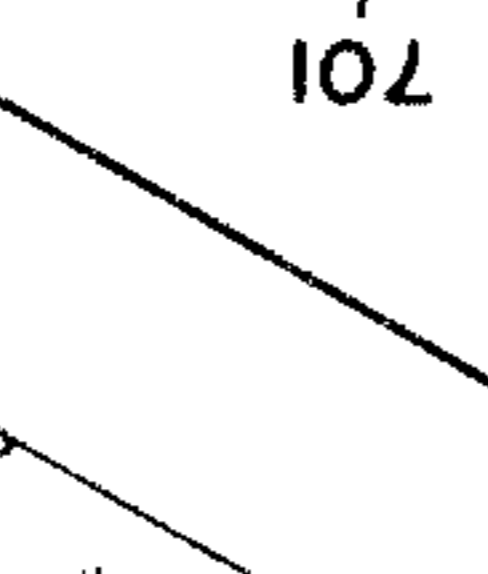
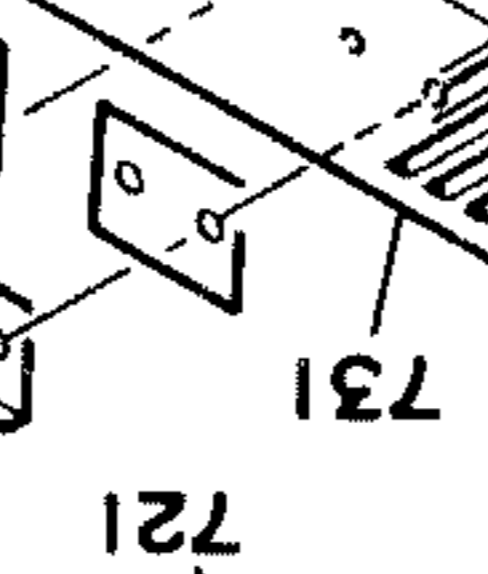
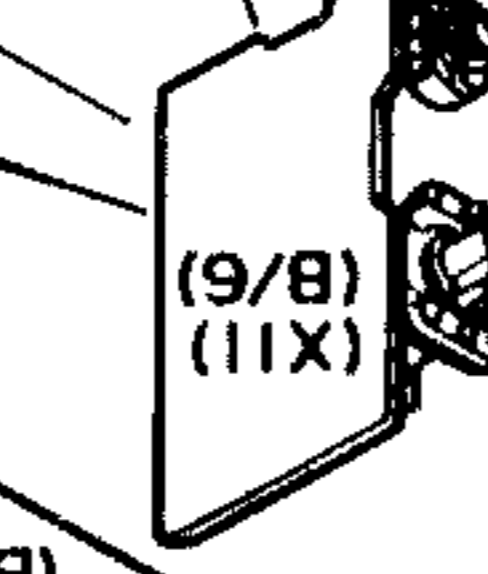
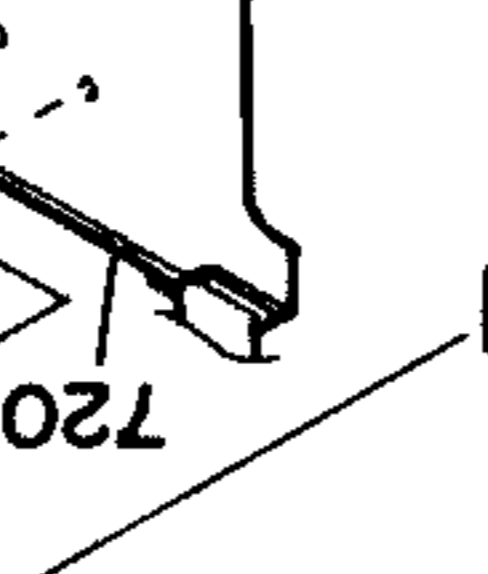
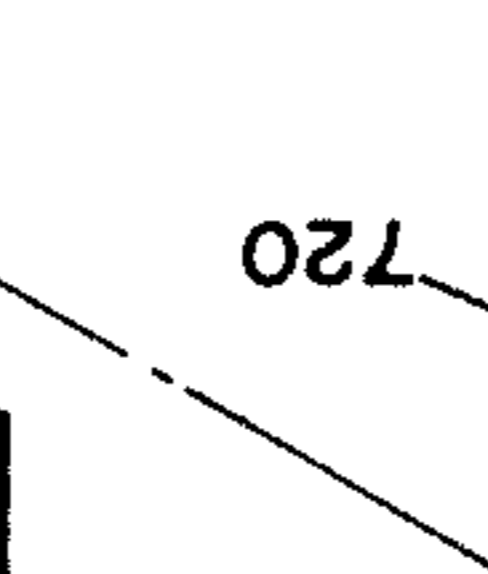
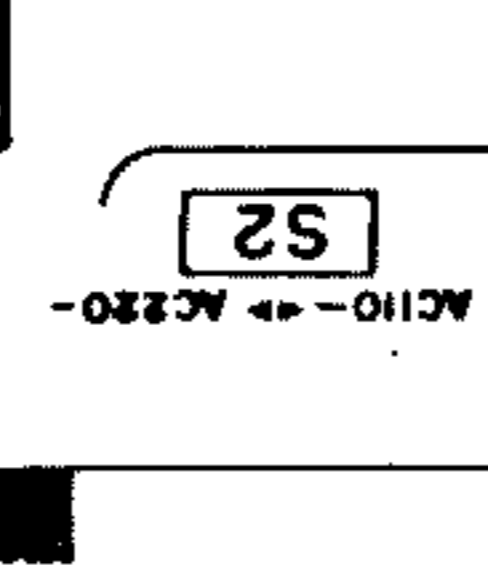
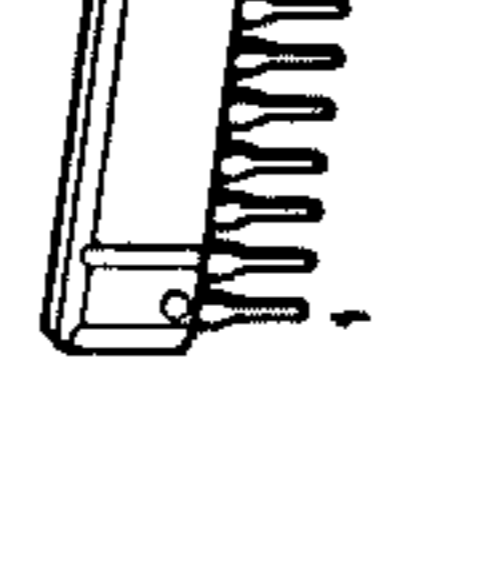
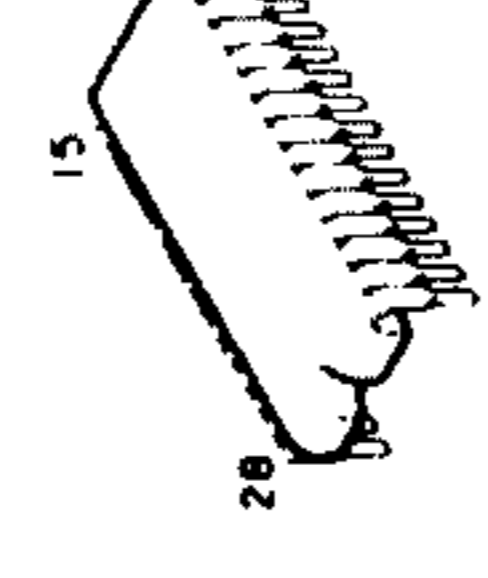
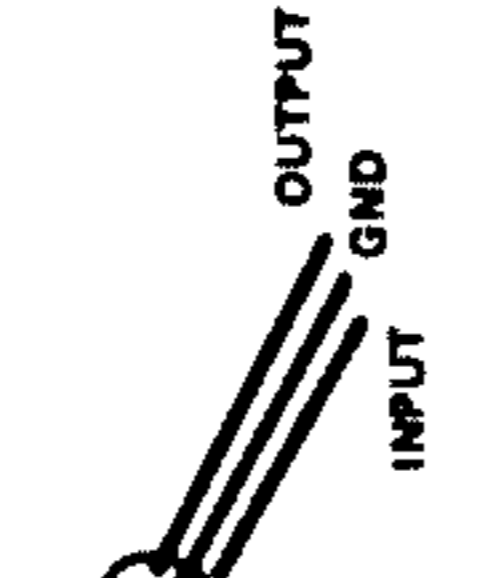
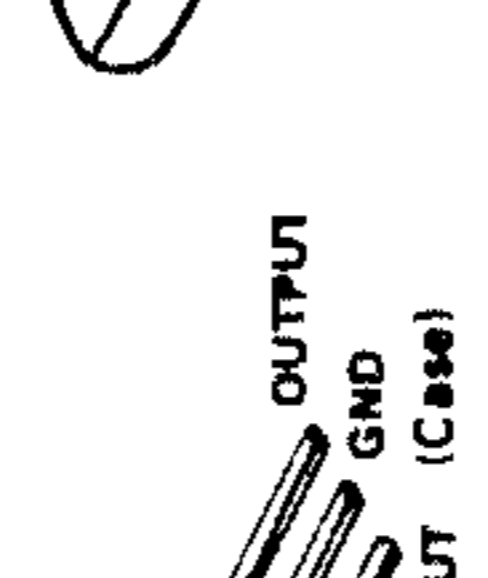
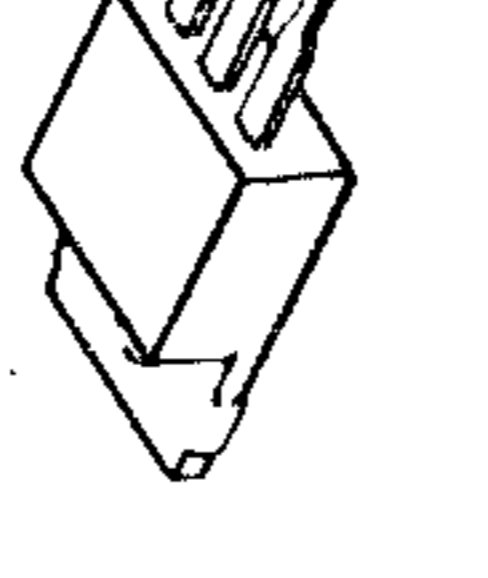
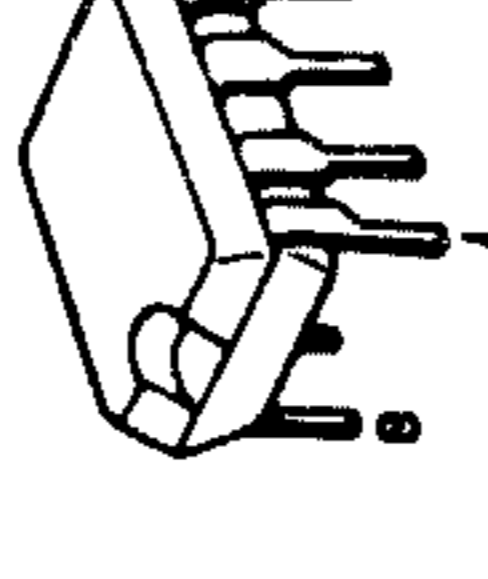
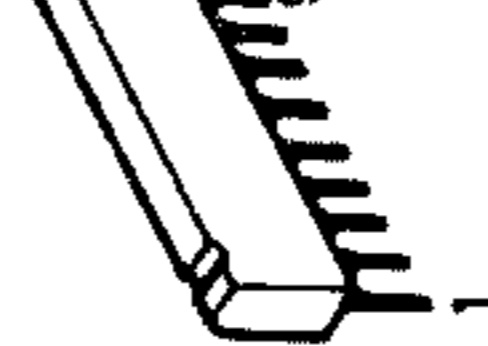
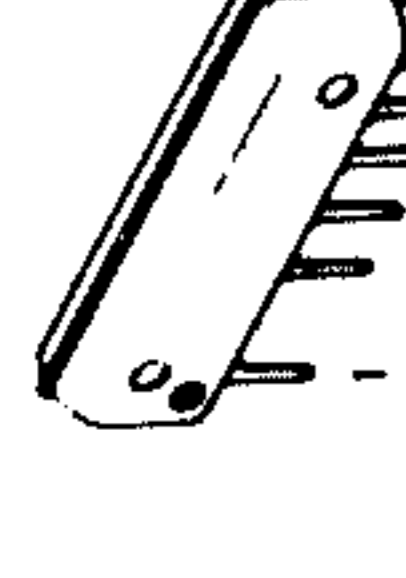
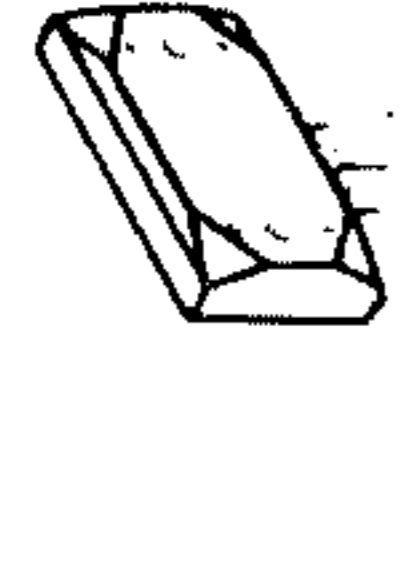
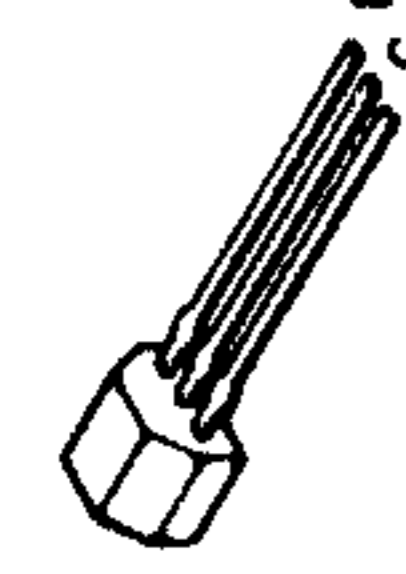
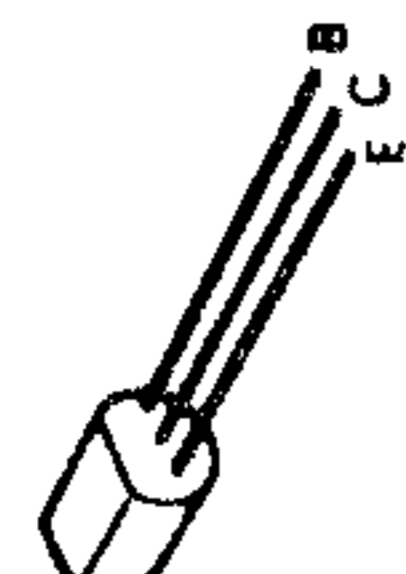

附件

Remote control unit	1		(A70-0343-05)
Battery (AAA or R03)	4		
System control cord	1		(E30-1392-05)
Overlay sheet	1		(A70-0343-05)

分解图

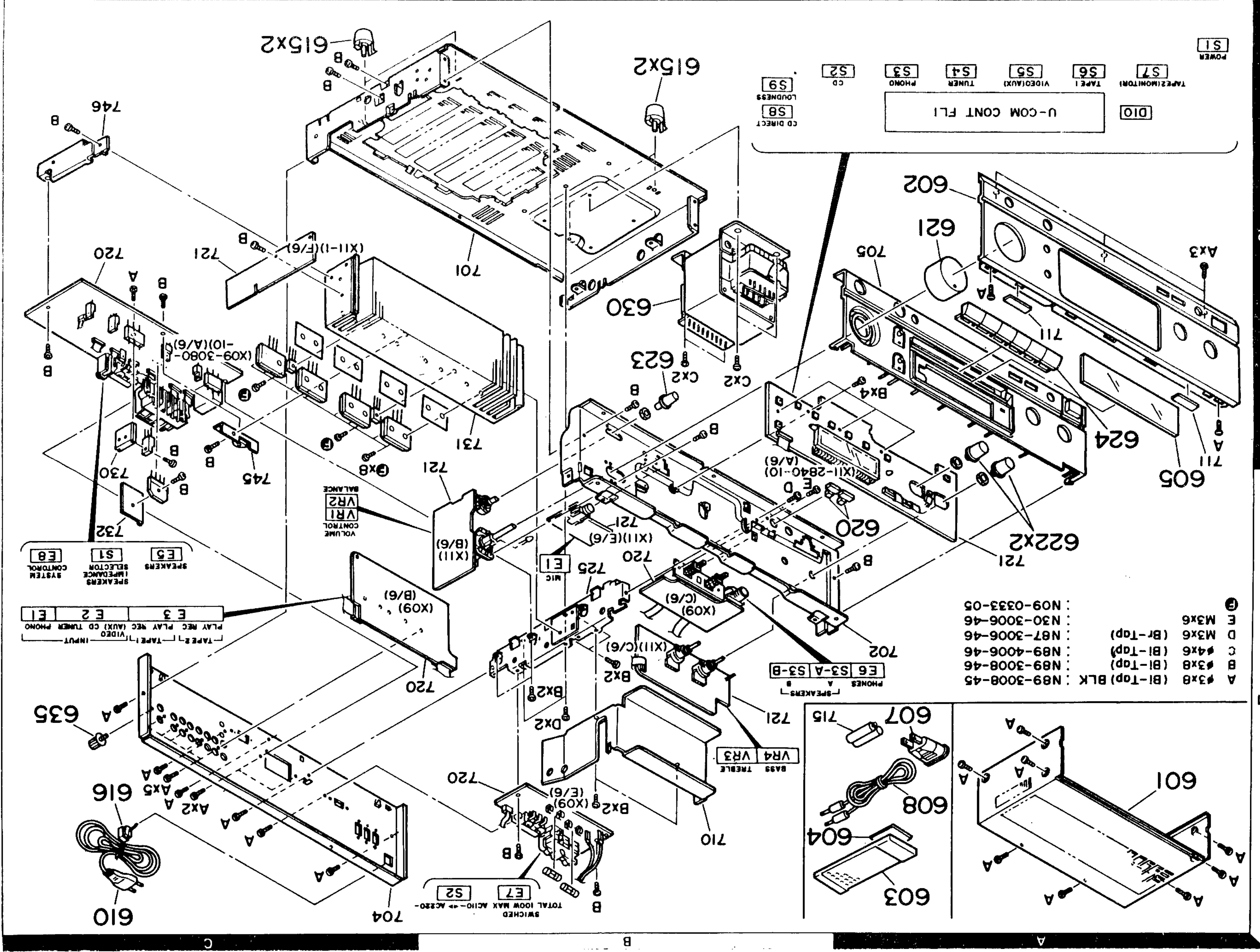

零部件表

* 新零部件
不提供无零件号码的更换用零件。

Ref. No. 参考号码	Address 位置	New Parts 新零件	Parts No. 零件号码	Description 零件名称 / 规格	Destination 向 到该地	Remarks 备注
KA-99 (JAPAN MADE)						
601	1A	*	A01-1834-01	METALLIC CABINET	KPYX	
602	2A	*	A20-6006-02	PANEL	M	
602	2A	*	A20-6007-02	PANEL	M	
603	1A, 1B	*	A70-0343-05	REMOTE CONTROLLER ASSY		
604	1A	*	A09-0078-08	BATTERY COVER		
605	2A	*	B10-1078-03	FRONT GLASS	K	
-	-	-	B46-0092-03	WARRANTY CARD	Y	
-	-	-	B46-0094-03	WARRANTY CARD	Y	
-	-	-	B46-0095-03	WARRANTY CARD	Y	
-	-	-	B46-0096-13	WARRANTY CARD	X	
-	-	-	B46-0121-03	WARRANTY CARD	P	
-	-	-	B58-0513-04	CAUTION CARD (PRESET220-240)	Y	
-	-	-	B60-0093-00	INSTRUCTION MANUAL (ENGLISH)		
-	-	-	B60-0094-00	INSTRUCTION MANUAL (FRENCH)		
-	-	-	B60-0095-00	INSTRUCTION MANUAL (SP, AL, CH)	PM	
607	1A, 1B	*	E03-0115-05	AC PLUG ADAPTER	M	
608	1A, 1B	*	E30-1392-05	CORD WITH PLUG	M	
610	1C	*	E30-0459-05	AC POWER CORD	M	
610	1C	*	E30-0812-05	AC POWER CORD	Y	
610	1C	*	E30-0974-05	AC POWER CORD	KP	
610	1C	*	E30-1341-05	AC POWER CORD	X	
E7	1B	*	E03-0055-05	AC OUTLET	X	
E7	1B	*	E03-0114-05	AC OUTLET	M	
-	-	-	H01-8749-04	ITEM CARTON CASE		
-	-	-	H10-3971-02	POLYSTYRENE FOAMED FIXTURE		
-	-	-	H10-3972-02	POLYSTYRENE FOAMED FIXTURE		
-	-	-	H25-0223-04	PROTECTION BAG (750X350X0.03)		
-	-	-	H25-0232-04	PROTECTION BAG (235X350X0.03)		
615	2B, 2C	*	J02-1013-05	FOOT		
616	1C	*	J42-0083-05	POWER CORD BUSHING		
-	-	-	J61-0307-05	WIRE BAND		
620	1B	*	K27-2014-04	KNØB (BUTTON) (SPEAKERS)		
621	2A	*	K29-3744-04	KNØB (VOLUME CONTROL)		
622	1A, 2A	*	K29-3909-04	KNØB (BASS, TREBLE)		
623	2B	*	K29-3911-04	KNØB (BALANCE)		
624	2A	*	K29-3914-03	KNØB (INPUT SELECTOR)		
630	2B	*	L07-0054-05	POWER TRANSFORMER	K	
630	2B	*	L07-0055-05	POWER TRANSFORMER	P	
630	2B	*	L07-0056-05	POWER TRANSFORMER	Y	
630	2B	*	L07-0057-05	POWER TRANSFORMER	M	
630	2B	*	L07-0058-05	POWER TRANSFORMER	X	
635	1C	*	N08-0128-35	BINDING POST (EARTH)		
A	2B	*	N30-3006-46	PAN HEAD MACHINE SCREW		
B	2B, 3C	*	N87-3006-46	BRAZIER HEAD TAPTITE SCREW		
C	1A, 1C	*	N89-3008-45	BINDING HEAD TAPTITE SCREW		
D	1B, 2B	*	N89-3008-46	BINDING HEAD TAPTITE SCREW		
E	2B	*	N89-4006-46	BINDING HEAD TAPTITE SCREW		
AUDIO UNIT (X09-308X-XX)						
C1, 2			CE04KWIH100M	ELECTRØ	10UF	50WV
C3, 4			CE04KWI1A101M	ELECTRØ	100UF	10WV
C5, 6			CK45FB1H561K	CERAMIC	560PF	K
C7, 8			CF92FV1H123J	MF	0.012UF	J

零部件表

* 新零部件
不提供无零件号码的更换用零件。

Ref. No. 参考号码	Address 位置	New Parts 新零件	Parts No. 零件号码	Description 零件名称 / 规格	Destination 向 到该地	Remarks 备注
C9			CF92FV1H332J	MF	3300PF	J
C11			CE04KW1H4R7M	ELECTRØ	4.7UF	50WV
C27			CE04KW1H2R2M	ELECTRØ	2.2UF	50WV
C31			CC45FSL1H221J	CERAMIC	220PF	J
C33			CF92FV1H152J	MF	1500PF	J
C37			CE04KW1A101M	ELECTRØ	100UF	10WV
C39			CC45FSL1H050C	CERAMIC	5.0PF	C
C41			CE04KW1H010M	ELECTRØ	1.0UF	50WV
C45			CC45FSL1H331J	CERAMIC	330PF	J
C47			CC45FSL1H020C	CERAMIC	2.0PF	C
C49			CC45FSL1H220J	CERAMIC	22PF	J
C51			CE04KW1H010M	ELECTRØ	1.0UF	50WV
C53			CK45FF1H103Z	CERAMIC	0.010UF	Z
C55			CF92FV1H104J	MF	0.10UF	J
C57			CF92FV1H222J	MF	2200PF	J
C65			CC45FSL1H221J	CERAMIC	220PF	J
C77			CE04KW1C220M	ELECTRØ	22UF	16WV
C79			C91-0769-05	CERAMIC	0.01UF	M
C80			CK45FB1H102K	CERAMIC	1000PF	K
C82			CK45FB1H332K	CERAMIC	3300PF	K
C83			CE04KW1H4R7M	ELECTRØ	4.7UF	50WV
C84			CE04KW1H010M	ELECTRØ	1.0UF	50WV
C85			CE04KW1E102M	ELECTRØ	1000UF	25WV
C87			CE04KW1E470M	ELECTRØ	47UF	25WV
C88			CE04KW1C470M	ELECTRØ	47UF	16WV
C89			CF92FV1H104J	MF	0.10UF	J
C91			CK45FE2H103P	CERAMIC	0.010UF	P
C93			C90-1645-05	ELECTRØ	200UF	80WV
C95			CC45FSL1H101J	CERAMIC	100PF	J
C97			CE04KW1H3R3M	ELECTRØ	3.3UF	50WV
C98			CE04KW0J221M	ELECTRØ	220UF	6.3WV
C99			C91-0647-05	CERAMIC	0.01UF	P
C100			CE04KW2A101M	ELECTRØ	100UF	100WV
C102			CE04KW1A101M	ELECTRØ	100UF	10WV
C103			CE04KW1C220M	ELECTRØ	22UF	16WV
C108			CE04KW1V331M	ELECTRØ	330UF	35WV
C109			CF92FV1H104J	MF	0.10UF	J
E1		*	E13-0259-05	PHONØ JACK (2P) (PHONØ)		
E2		*	E13-0637-05	PHONØ JACK (6P) (CD, TUNER, AUX)		
E3		*	E13-0826-05	PHONØ JACK (TAPB)		
E5		*	E20-0823-05	TERMINAL BOARD (8P) (SPEAKER)		
E6		*	E11-0162-05	PHONE JACK (3P) (PHONES)		
E7		*	E03-0093-05	AC OUTLET		
E8		*	E11-0188-05	PHONE JACK (SYSTEM CONTROL)		
F1			F05-3121-05	FUSE (SEMØØ)	(250V T3.15A)	X
F1			F05-6029-05	FUSE (UL)	(250V T6.3A)	KP
F1			F05-6321-05	FUSE (SEMØØ)	(250V 6.3A)	M
F1			F05-6324-05	FUSE	(250V T3.15A)	Y
F2			F05-3121-05	FUSE (SEMØØ)	(250V T3.15A)	M
F2			F05-3123-05	FUSE	(250V 3.15A)	Y
CNS		*	J13-0075-05	FUSE CLIP		YM
CNS		*	J13-0075-05	FUSE CLIP		KPX

零部件表

*新零部件
不提供无零件号码的更换用零件。

Ref. No. 参考号码	Address 位置	New Parts 新零件	Parts No. 零件号码	Description 零件名称 / 规格	Destination 仕向	Remarks 备注
L1 ,2			L39-0085-05	PHASE-COMPENSATION COIL	到筑地	
C	2C		N89-3008-45	BINDING HEAD TAPTITE SCREW		
D	2C		N89-3008-46	BINDING HEAD TAPTITE SCREW		
F	2C		N09-0333-05	TAPPING SCREW (3X12)		
G	2C		N35-3008-46	BINDING HEAD MACHINE SCREW		
CP1 ,2			R90-0187-05	MULTI-COMP 0.22X2 K 5W		
R81			RD14GB2E221J	FL-PROOF RD 220 J 1/4W		
R82			RD14NB2E221J	RD 220 J 1/4W		
R83			RD14GB2E221J	FL-PROOF RD 220 J 1/4W		
R84			RD14NB2E221J	RD 220 J 1/4W		
R87			RD14NB2E101J	RD 100 J 1/4W		
R88			RD14GB2E101J	FL-PROOF RD 100 J 1/4W		
R95 -98		*	RD14NB2E220J	RD 22 J 1/4W		
R99 -101			RD14AB2E331J	FL-PROOF RD 330 J 1/4W		
R102			RD14GB2E331J	FL-PROOF RD 330 J 1/4W		
R103			RD14AB2E2R2J	FL-PROOF RD 2.2 J 1/4W		
R104,105		*	RD14NB2E2R2J	RD 2.2 J 1/4W		
R106			RD14GB2E2R2J	FL-PROOF RD 2.2 J 1/4W		
R107,108			RS14DB3D100J	FL-PROOF RS 10 J 2W		
R115,116			RD14NB2E100J	RD 10 J 1/4W		
R117,118			RS14DB3D561J	FL-PROOF RS 560 J 2W		
R147			RD14NB2E100J	RD 10 J 1/4W		
R163,164			RD14AB2E6R8J	FL-PROOF RD 6.8 J 1/4W		
R167,168			RD14NB2E220J	RD 22 J 1/4W		
VR1 ,2		*	R12-1083-05	TRIM POT. 1K		
K1			S51-2092-05	MAGNETIC RELAY		
K2			S51-1052-05	MAGNETIC RELAY		
S1			S31-2136-05	SLIDE SWITCH(IMPEDANCE SELECT)	YMX	
S2			S31-2131-05	SLIDE SWITCH(VOLTAGE SELECTOR)	Y	
S3			S42-2163-05	MULTIPLE PUSH SWITCH (SPEAKER)		
S4		*	S31-2322-05	SLIDE SWITCH(VOLTAGE SELECTOR)	M	
D1 -10			HSS104A	DIODE		
D1 -10			1SS131	DIODE		
D11			HZS4.7N(B)	ZENER DIODE		
D11			RD4.7ES(B)	ZENER DIODE		
D12 -15			S5566B	DIODE		
D16			RBV-602LFA	DIODE		
D17 -23			HSS104A	DIODE		
D17 -23			1SS131	DIODE		
D24			S5566B	DIODE		
D25 ,26			MA177	DIODE		
IC1			TC9163N	IC(BILATERAL SWITCH X16)		
IC2			UPC4570C-A	IC(OP AMP X2)		
IC3			UPC7812HF	IC(VOLTAGE REGULATOR/ +12V)		
Q1 -4			2SC1845(F,E)	TRANSISTOR		
Q5 -8			2SA992(F,E)	TRANSISTOR		
Q9 -14			2SC2632(Q,R,S)	TRANSISTOR		
Q15 ,16			2SA1124(Q,R,S)	TRANSISTOR		
Q17 ,18			2SC4137	TRANSISTOR		
Q19 ,20			2SC3944(Q,R,S)	TRANSISTOR		
Q21 ,22			2SA1535(Q,R,S)	TRANSISTOR		
Q23 ,24			2SC2921	TRANSISTOR		
Q25 ,26			2SA1215	TRANSISTOR		

零部件表

*新零部件
不提供无零件号码的更换用零件。

Ref. No. 参考号码	Address 位置	New Parts 新零件	Parts No. 零件号码	Description 零件名称 / 规格	Destination 仕向	Remarks 备注
Q27 ,28			2SC2631(R,S)	TRANSISTOR		
Q29 ,30			2SC2878(B)	TRANSISTOR		
Q31			2SA733(A)(Q,P)	TRANSISTOR		
Q31			2SA933S(Q,R)	TRANSISTOR		
Q32			2SA1123(R,S)	TRANSISTOR		
Q33			2SC2003(L,K)	TRANSISTOR		
Q34			2SA733(A)(Q,P)	TRANSISTOR		
Q34			2SA933S(Q,R)	TRANSISTOR		
Q35			2SB941	TRANSISTOR		
Q36			2SC1740S(Q,R)	TRANSISTOR		
Q36			2SC945(A)(Q,P)	TRANSISTOR		
Q37			2SA733(A)(Q,P)	TRANSISTOR		
Q37			2SA933S(Q,R)	TRANSISTOR		
Q38			2SC1740S(Q,R)	TRANSISTOR		
Q38			2SC945(A)(Q,P)	TRANSISTOR		
Q39			2SC2003(L,K)	TRANSISTOR		
Q40 ,41			2SC1740S(Q,R)	TRANSISTOR		
Q40 ,41			2SC945(A)(Q,P)	TRANSISTOR		
CONTROL UNIT (X11-284X-XX)						
D10		*	B30-1291-05	LED		
C1 ,2			CE04DW1V221M	ELECTRO 220UF 35WV		
C3			CE04KW0J221M	ELECTRO 220UF 6.3WV		
C4			CF92FV1H103J	MF 0.010UF J		
C5 ,6			CE04KW1V100M	ELECTRO 10UF 35WV		
C7 ,8			CE04KW1H2R2M	ELECTRO 2.2UF 50WV		
C9			CK45FF1H103Z	CERAMIC 0.010UF Z		
C10			CE04KW1HOR1M	ELECTRO 0.1UF 50WV		
C11			C91-0769-05	CERAMIC 0.01UF M		
C12			C91-0928-05	BACKUP C 0.047F 5.5WV		
C13			CE04KW0J221M	ELECTRO 220UF 6.3WV		
C14			C91-0085-05	CERAMIC 0.022UF N		
C15			CE04KW1C101M	ELECTRO 100UF 16WV		
C17 ,18			CE04KW1E470M	ELECTRO 47UF 25WV		
C19 ,20			CF92FV1H473J	MF 0.047UF J		
C21 ,22			CF92FV1H333J	MF 0.033UF J		
C23 ,24			CE04KW1V100M	ELECTRO 10UF 35WV		
C25			CF92FV1H104J	MF 0.10UF J		
C26			C90-1333-05	NP-ELEC 22UF 10WV		
C27			C90-1353-05	NP-ELEC 10UF 25WV		
C28			CE04KW1E470M	ELECTRO 47UF 25WV		
C29 ,30			CE04KW1V100M	ELECTRO 10UF 35WV		
C31 -34			CC45FSL1H221J	CERAMIC 220PF J		
C35 -38			CK45FB1H561K	CERAMIC 560PF K		
C39 ,40			CE04KW1H2R2M	ELECTRO 2.2UF 50WV		
C41 ,42			CE04KW1V100M	ELECTRO 10UF 35WV		
C43 ,44			CF92FV1H203J	MF 0.020UF J		
C45			CE04KW1E470M	ELECTRO 47UF 25WV		
C46			CK45FF1H472Z	CERAMIC 4700PF Z		
C47			CC45FSL1H221J	CERAMIC 220PF J		
C48			CF92FV1H473J	MF 0.047UF J		
C49			CC45FSL1H221J	CERAMIC 220PF J		
C50 -52			CE04KW1V100M	ELECTRO 10UF 35WV		
C53			CF92FV1H102J	MF 1000PF J		
C54			CK45FF1H103Z	CERAMIC 0.010UF Z		

零部件表

规格

* 新零部件
不提供无零件号码的更换用零件。

Ref. No. 参考号码	Address 位置	New Parts 零件	Parts No. 零件号码	Description 零件名称 / 规格	Destination 到货地	Remarks 备注
C55, 56 C57, 58 C59, 60 C61 C62			CE04KW1V100M CE04KW1E470M CE92FV1H683J CE04KW1E470M CK45FF1H103Z	ELECTRØ ELECTRØ MF ELECTRØ CERAMIC	M M KPYX	
C62, 63 C64 C65 C66			CK45FF1H103Z CE04DW1V221M C91-0769-05 CE04DW1V221M	CERAMIC ELECTRØ CERAMIC ELECTRØ	M M	
E1			E11-0159-05	PHONE JACK(3P)(MIC JACK)	M	
X1			L78-0244-05	RESONATOR 4.0MHZ		
CP1 R1 R2 R4 R4 VR1			R90-0482-05 RS14KB3A561J RD14NB2E101J RD14NB2E1R0J R29-5037-05	MULTI-COMP FL-PROOF RS RD RD RD		
VR2 VR3 VR5			R01-5072-05 R06-3068-05 R10-5037-05	POTENTIOMETER(200K) POTENTIOMETER(100KX2) POTENTIOMETER(100KX2)	M	
S1			S40-1064-05	PUSH SWITCH (SELECTOR)		
D1 D6 D6 D7 D7			S5566B HSS104 1SS133 1SS133 HZSS.6N(B2) RD5.6ES(B2)	DIODE DIODE DIODE DIODE ZENER DIODE ZENER DIODE		
D8 D8 D11 D11 D11 D21			HSS104 1SS133 HSS104 1SS133 1SS133 HZS3.9N(B2)	DIODE DIODE DIODE DIODE DIODE ZENER DIODE		
D21 D22 D22 D22 D22 D22			RD3.9ES(B2) HSS104 1SS133 1SS133 HSS104 1SS133	ZENER DIODE DIODE DIODE DIODE DIODE DIODE		
FL1 IC1 IC2 IC3 IC4		*	FIP7AM7R UPC7805H M51951ASL BA6138 TA8409S	FLUORESCENT INDICATOR IC(VOLTAGE REGULATOR/ +5V) IC(SYSTEM RESET) IC(ROOT AMP X2) IC(MOTOR CONTROL)		
IC5 IC6 IC7 IC9 IC9		*	M50940-197SP NJM4565L TC9215P UPC4570C-A UPC4570C-A	IC IC IC(ANALOG SWITCH X 6) IC(OP AMP X2) IC(OP AMP X2)		
Q1 Q1 Q5 Q7 A1 A1		*	2SC1740S(Q,R) 2SC945(A)(Q,P) 2SC2878(B) 2SC1845(F,E) M02-0975-05 M02-1043-05	TRANSISTOR TRANSISTOR TRANSISTOR TRANSISTOR ELECTRIC CIRCUIT MODULE OPTIC RECEIVING MODULE		

最大连续功率输出

(IHF '66)从20赫至20,000赫, 0.05% T.H.D. 8 欧 110瓦 + 110瓦

1,000赫, 0.05%, T.H.D. 8 欧 135瓦 + 135瓦

音乐功率, 8 欧 220瓦 + 220瓦

总谐波失真真线输入至扬声器输出

(20赫至20,000赫) 0.03%, 1/2的额定功率, 8 欧

(1千赫) 0.01%, 1/2的额定功率, 8 欧

相互调制失真 (60赫 : 7千赫 = 4 : 1) 0.03%, 额定功率, 8 欧

功率带宽 10赫至100千赫, 0.2% T.H.D. 8 欧

频率响应 10赫至50千赫, + 0分贝, - 3分贝

输入灵敏度/阻抗

声音 2.5毫伏/47千欧

调谐器, 磁带演奏, CD, 辅助设备, 电视 150毫伏/33千欧

信噪比 (IHF-A)

声音 75分贝, 用于2.5毫伏输入

调谐器, 磁带演奏, CD, 辅助设备, 电视 100分贝

声音最大输入电平 100毫伏, T.H.D. 0.3%, 1千赫

输出电平/阻抗

磁带REC (Pin) 150毫伏/3.3千赫

音频响应 RIAA标准曲线 ± 0.5分贝 (20赫至20,000赫)

音频控制

低频 ± 10dB (at 100Hz)

音频控制

音响控制 + 8分贝, 70赫 (-30分贝音量音平)

综合

功率消耗 220瓦 (IEC)

尺寸 宽: 440毫米

高: 133毫米

深: 281毫米

净重 8.9公斤