

Die angegebenen Gleichspannungswerte wurden mit einem hochohmigen Spannungsmesser ohne Eingangssignal gemessen. Dabei schwanden die Meßwerte aufgrund von Unterschieden zwischen einzelnen Instrumenten oder Geräten u.U. geringfügig.

DC voltages are as measured with a high impedance voltmeter with no signal input. Values may vary slightly due to variations between individual instruments or/and units.

Les tensions c.c. doivent être mesurées avec un voltmètre à haute impédance sans signal d'entrée. Les valeurs peuvent différer légèrement du fait des variations inhérentes aux appareils et aux instruments de mesure individuels.

CAUTION: For continued safety, replace safety critical components only with manufacturer's recommended parts (refer to parts list). ∇ Indicates safety critical components. To reduce the risk of electric shock, leakage-current or resistance measurements shall be carried out (exposed parts are accepted) by insulated from the supply circuit) before the appliance is returned to the customer.

— SIGNAL LINE
 ——— + B LINE
 ——— - B LINE

| DESTINATION | M.T. | NO. |
|-------------|------|-----|
| 0-00 | | |
| 2-71 | E | |
| C33-35 | | |

Ref. No. C33-35

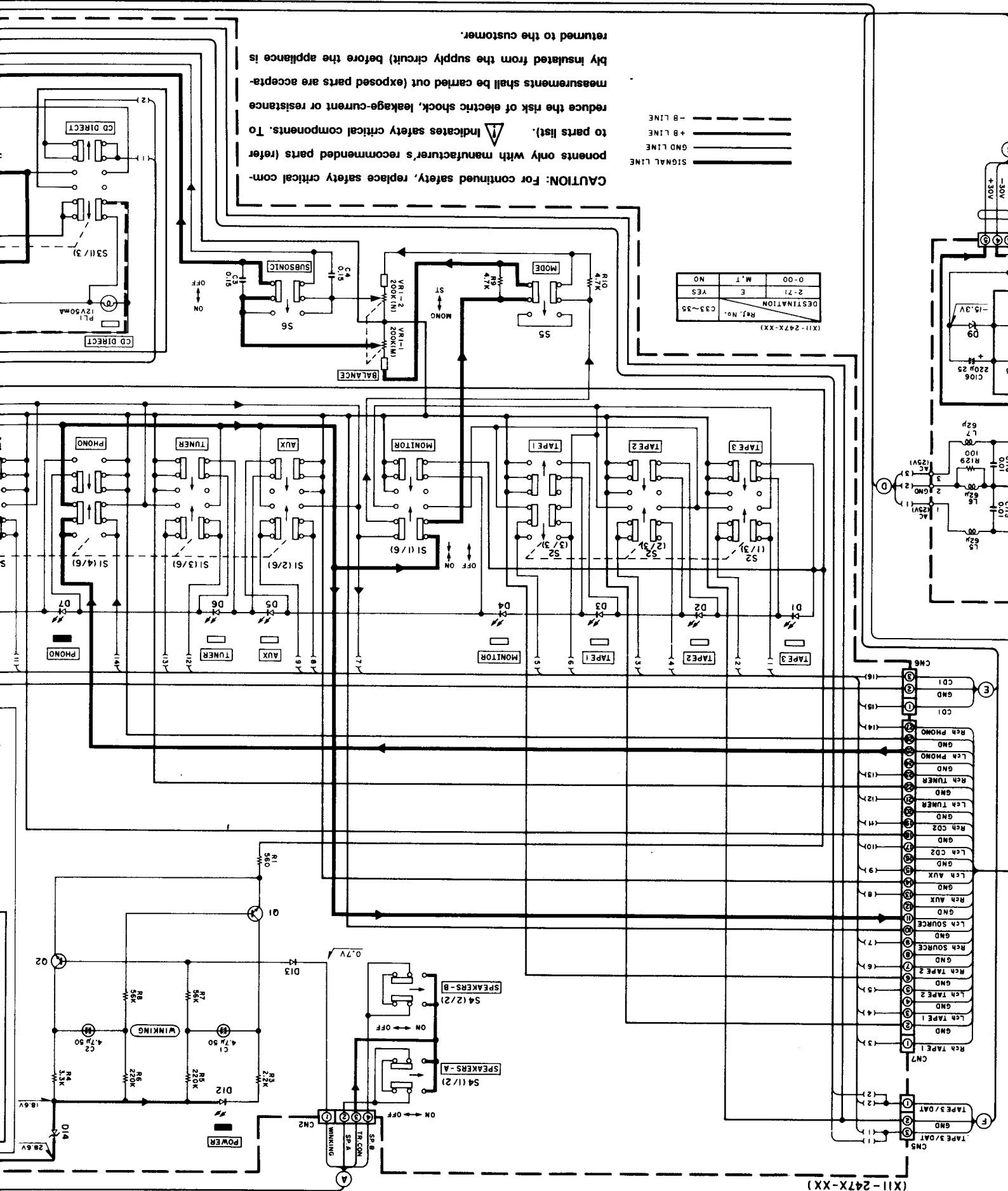

(X11-247X-XX)

M2041D-D
M5532D

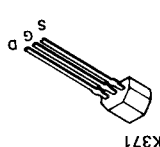
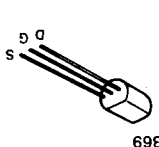
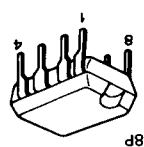
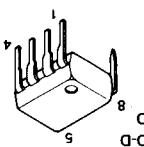

M5218P

2SK369

2SK371

- 01~4 : 2SK369(V) or 2SK371(V)
- 05~10 : 2SC945(A)(Q,P) or 2SC2320(E,F)
- 011 : 2SA1110(Q,R)
- 012 : 2SC2590(Q,R)
- D1,2 : RD5JJS(B) or HZS5JJS(B)
- D3,B,9 : RD16S(B) or HZS16N(B)
- D4 : RD5JJS(B2) or HZS5JJS(B2)
- D5 : RD8,24S(B2) or HZS8,25(B2)
- D6 : E-102
- D7 : E-152
- D10~13 : DSM1A1
- D14~17 : 1SS131 or 1SS178
- D18,19 : 1SS133 or 1SS176

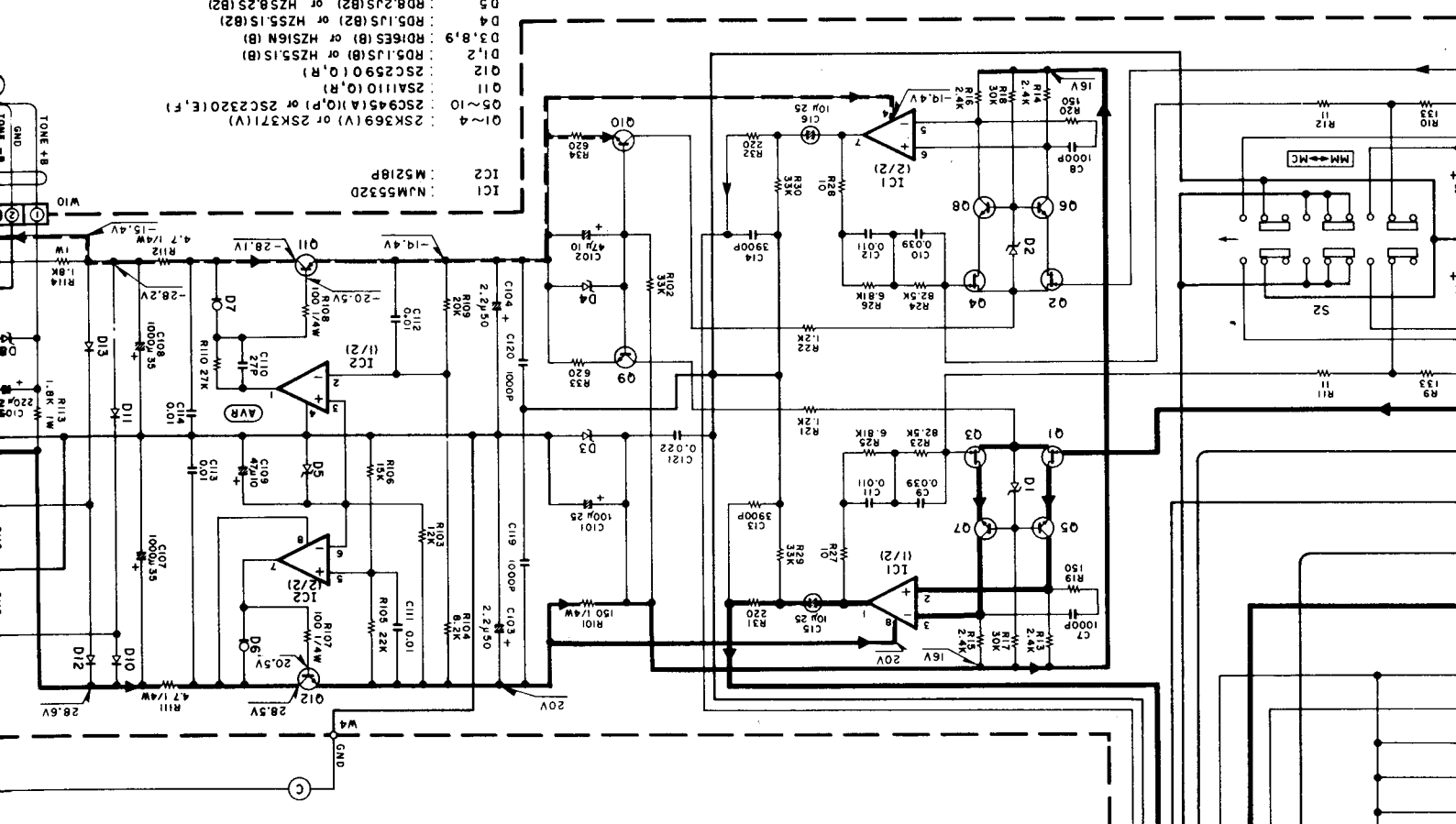

1X08-223X-X111A/51

| | | | | |
|-------------|--------|------|-------|--------|
| RET. NO. | C25-40 | C1,2 | 43~48 | C41,42 |
| DESTINATION | | | | |
| | NO | YES | NO | 220P |
| | E,T | M | 0-21 | |

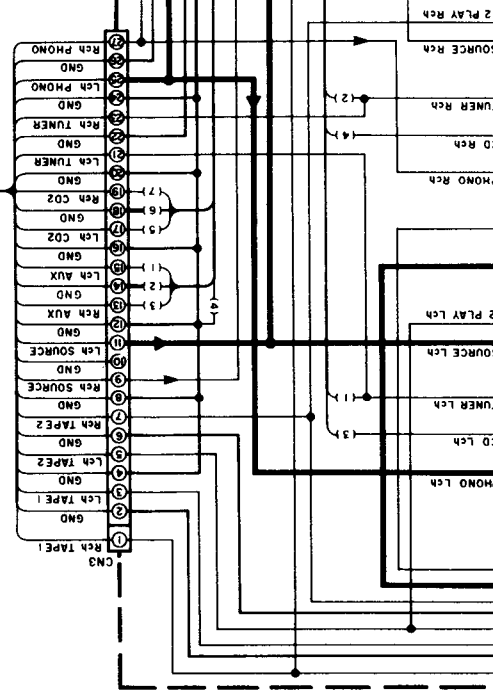

D E F G H

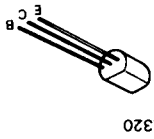
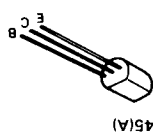
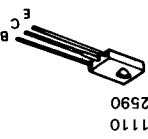
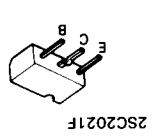

NJM NJM

2SC2021F

2SA1110

2SC945(A)

2SC2320

7

6

5

4

3

2

1

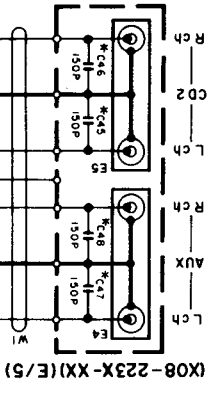
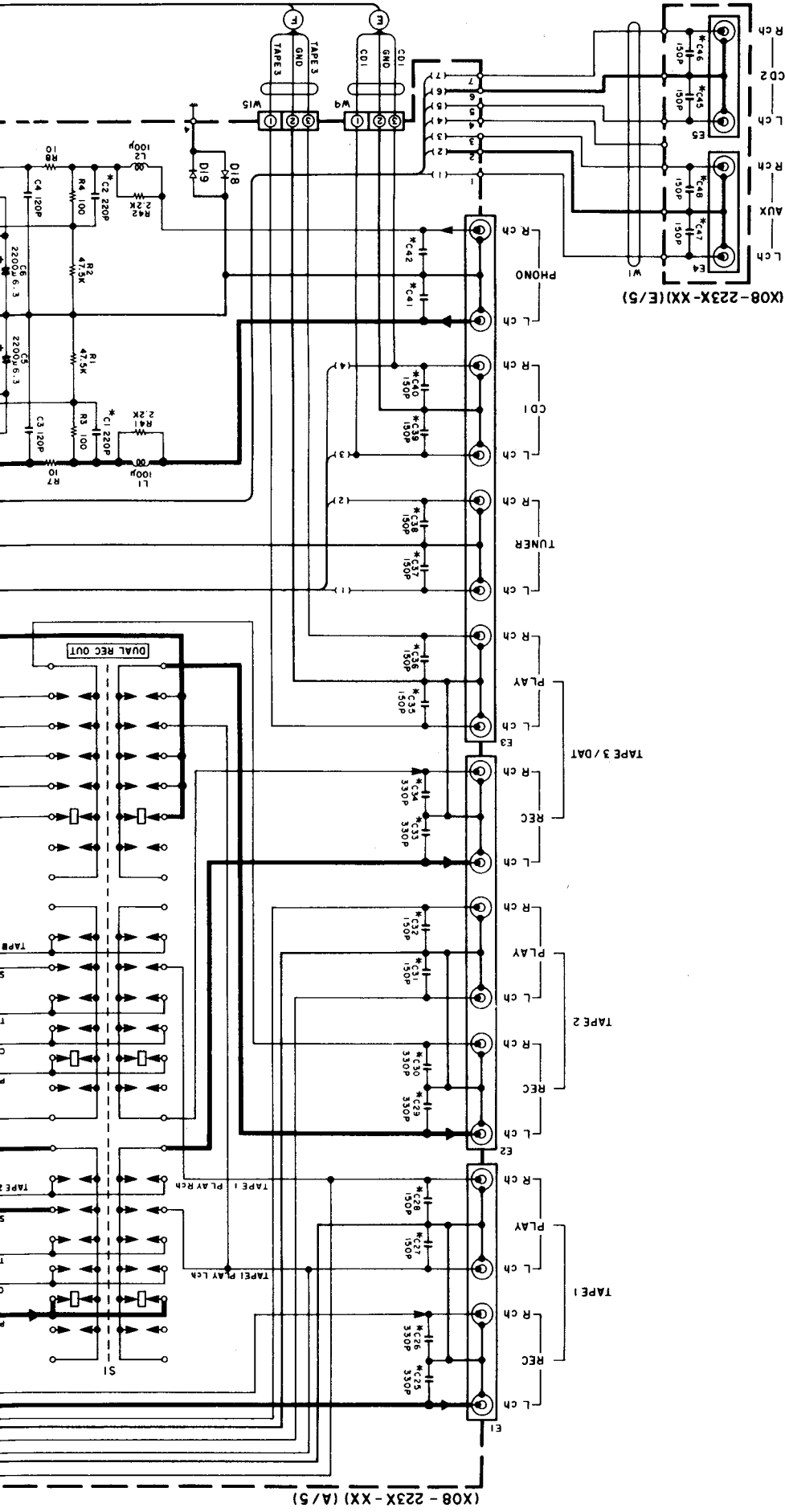

(X08-223X-XX) (A/5)

C

A

B

KA-990EX

KENWOOD

| | | | |
|------|----|---------|-----|
| C124 | NO | YES | 3A |
| F1 | E7 | JA4,121 | 75A |
| YES | NO | NO | YES |
| 125A | | | |

SIGNAL LINE
 GND LINE
 +B LINE
 -B LINE

KA-990EX(E) (2/2)

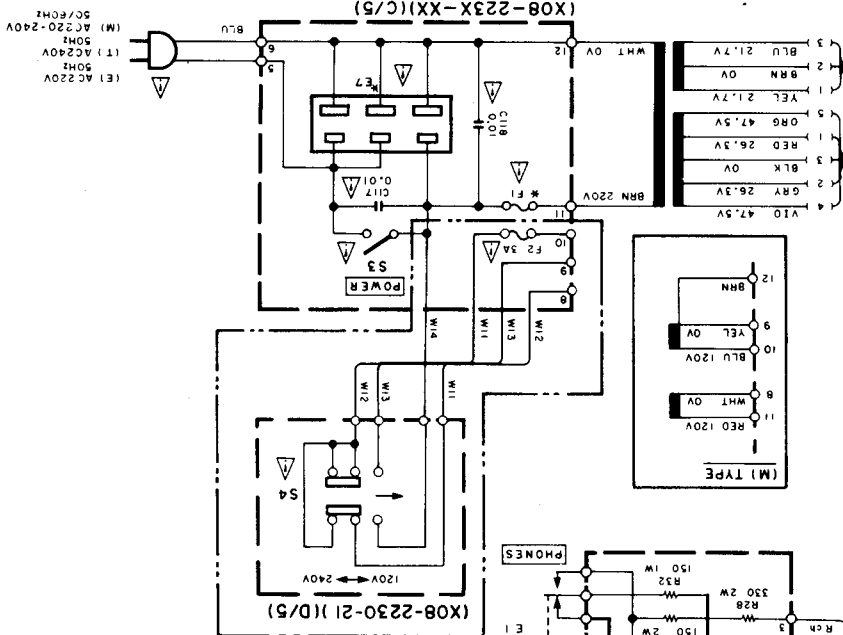

CAUTION: For continued safety, replace safety critical components only with manufacturer's recommended parts (refer to parts list). ∇ Indicates safety critical components. To reduce the risk of electric shock, leakage-current or resistance measurements shall be carried out (exposed parts are acceptably insulated from the supply circuit) before the appliance is returned to the customer.

(X08-223X-XX)(B/5)
 D14, 15 : 25C945(A)(P)
 or 25C2320(E,F)
 D14-17, 21, 22 : ISS131 or ISS17B

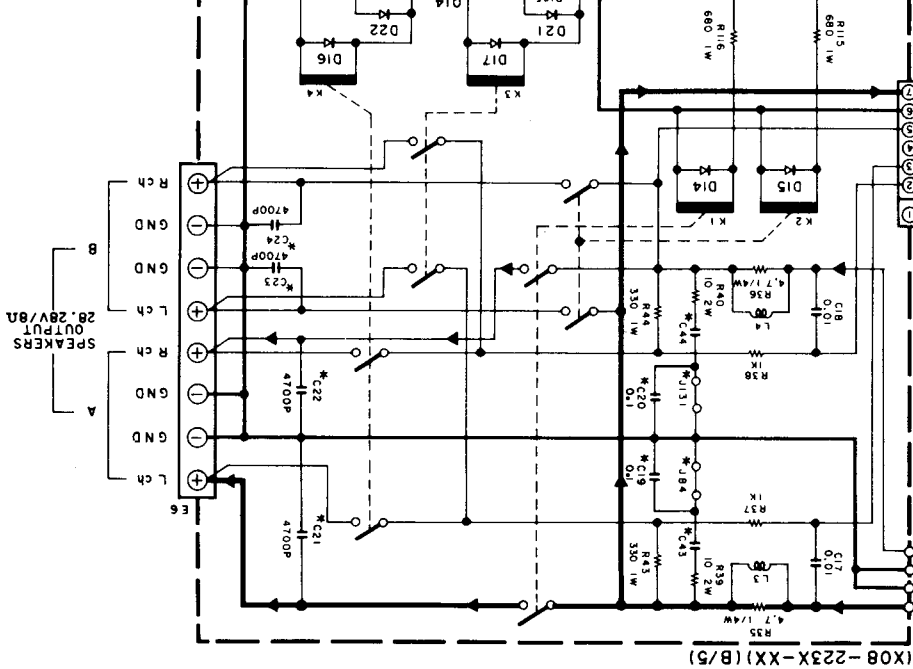

AL

AK

AJ

AI

AH

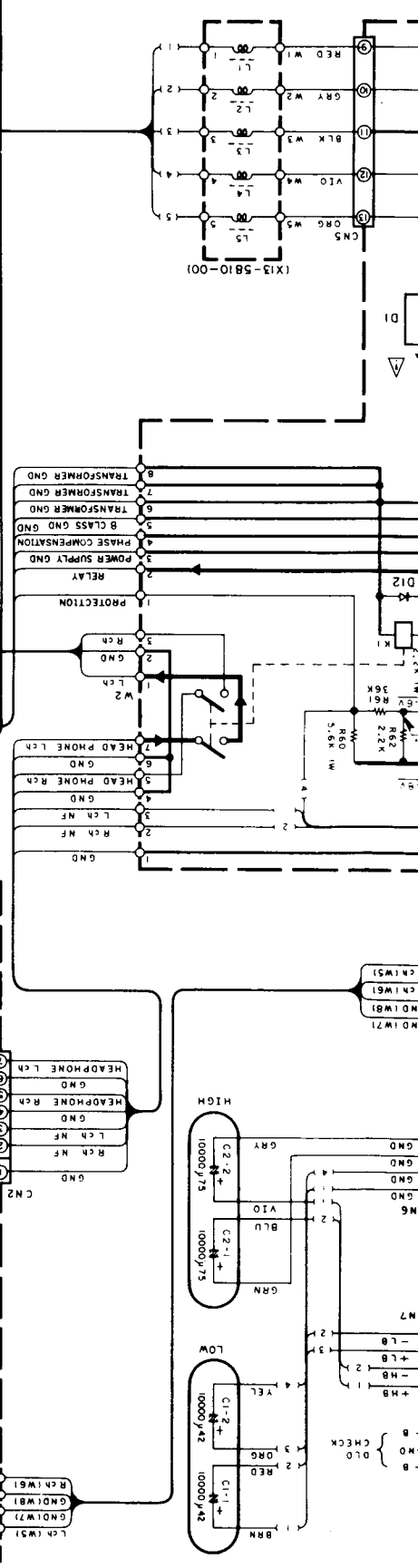

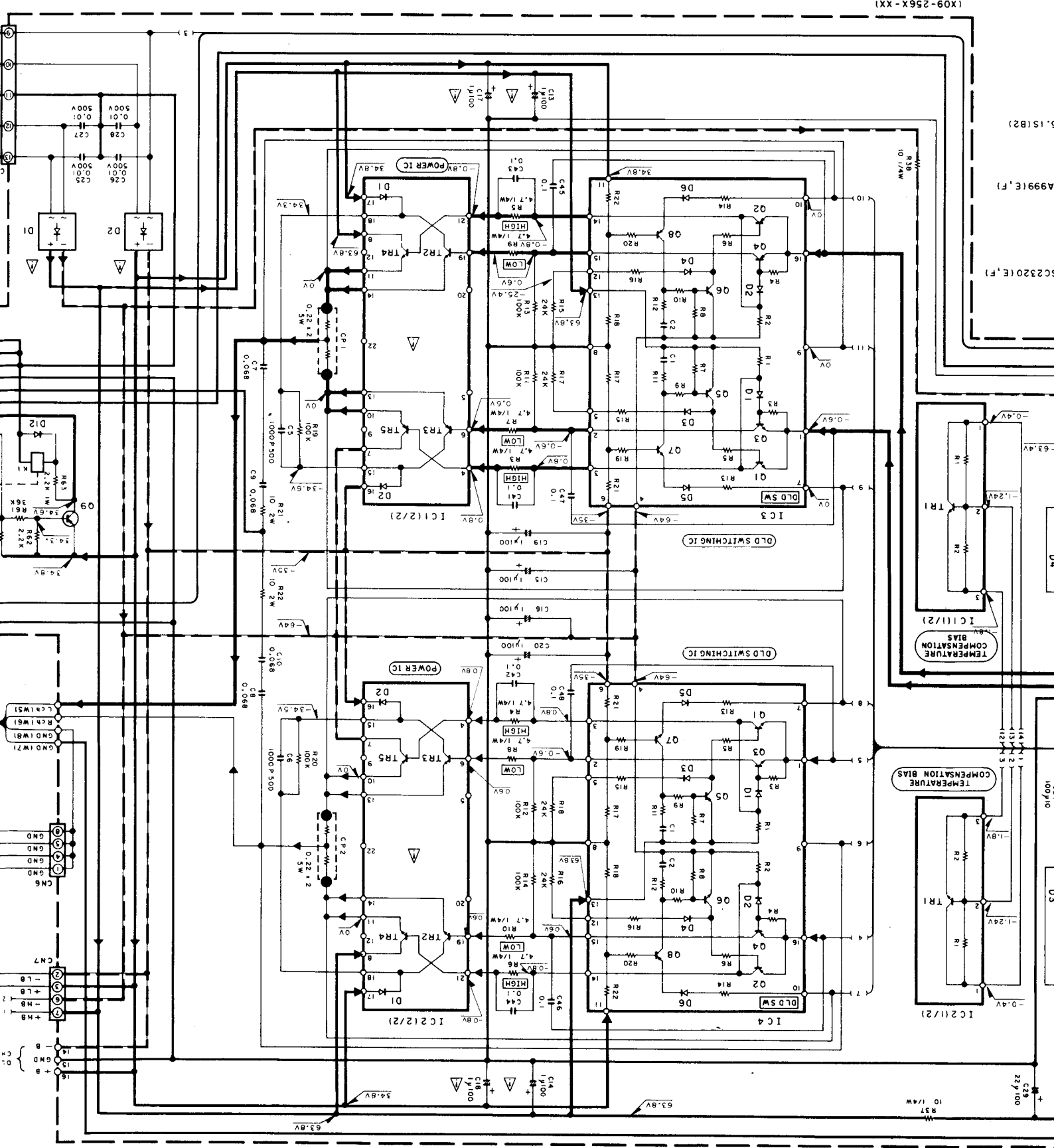

| DESTINATION | | RT. NO. | NO. | M | NO. | MC | NO. |
|-------------|------|---------|---------|---------|------|-------|-----|
| YES | E, T | C19, 20 | C21, 24 | C43, 44 | C124 | 0.1 | YES |
| NO | | | | | | 0.047 | NO |

X08-223X-KX1(B)/C151

D1, 2 : D5F820 * I
 D3, 4, 7 : E-102
 D5, 6, 8 : R08, 245(B2) or HZS08, 251(B2)
 D9, 10 : R020J5(B2) or HZS020J5(B2)
 D11, 12 : ISS131 or ISS178

07 : 25A1124 (Q, R, S)
 08 : 25C2632 (Q, R, S)
 09 : 25A999 (E, F)
 01, 2 : 25C2003 (L, K)
 03 : 25C1845 (F, E)
 04, 5 : 25A954 (L, K)
 06 : 25A992 (F, E)

Les tensions c.c. doivent être mesurées avec un volt-mètre à haute impédance sans signal d'entrée. Les valeurs peuvent différer légèrement du fait des variations inhérentes aux appareils et aux instruments de mesure individuels.

Die angegebenen Gleichspannungswerte wurden mit einem hochohmigen Spannungsmesser ohne Eingangssignal gemessen. Dabei schwanden die Messwerte aufgrund von Unterschieden zwischen einzelnen Instrumenten oder Geräten u.U. geringfügig.

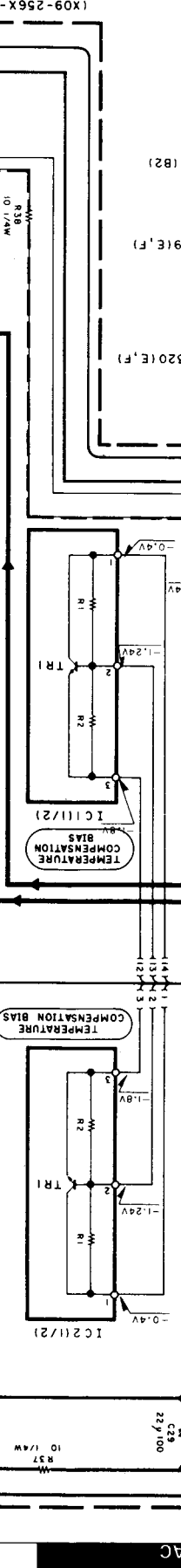

X

Y

Z

AA

AB

(X09-256X-XX) (A/3)

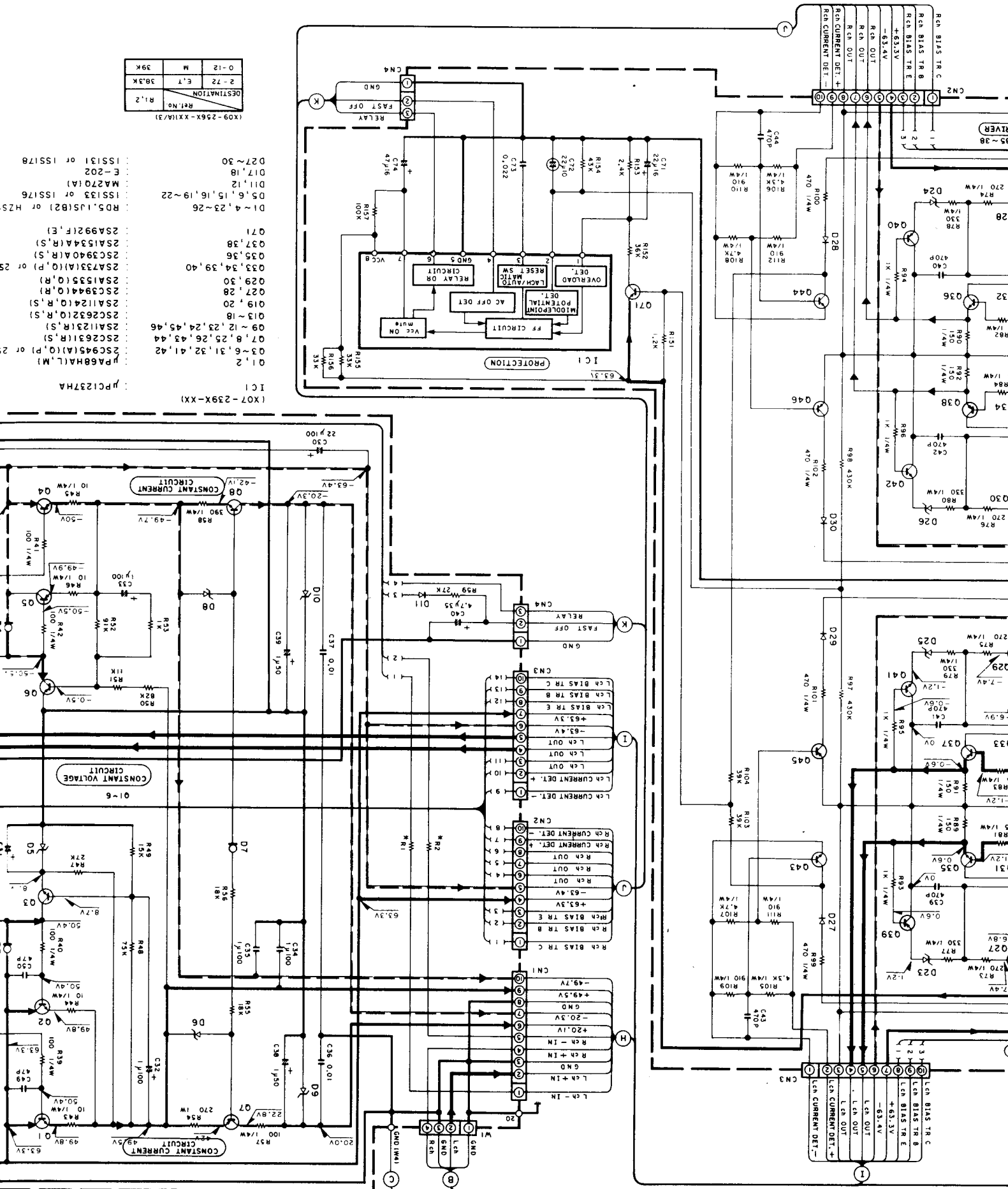

| REL. NO. | DESTINATION |
|----------|-------------|
| R1,2 | |
| 2-72 | E.T |
| 0-12 | M |
| | 38.3K |

- IC1 : μ PC1237HA (X07-239X-XX)
- 01,2 PA68HA(L,M) : 03~6,31,32,41,42
 - 02,8,25,26,43,44 : 25C2631(R,S)
 - 03~6,31,32,41,42 : 25C2631(R,S)
 - 07,8,25,26,43,44 : 25C2631(R,S)
 - 09~12,23,24,45,46 : 25A1123(R,S)
 - 013~18 : 25C2632(Q,R,S)
 - 019,20 : 25A1124(Q,R,S)
 - 027,28 : 25C2634(Q,R,S)
 - 029,30 : 25A1535(Q,R)
 - 033,34,39,40 : 25A733(A)(Q,P) or 25
 - 035,36 : 25C3940(A,R,S)
 - 037,38 : 25A1534(A,R,S)
 - 071 : 25A992(F,E)
 - D1~4,23~26 : R05,15J1821 or HZ5
 - D5,6,15,16,19~22 : 15S33 or 15S176
 - D11,12 : MA270(A)
 - E-202 : 15S131 or 15S178

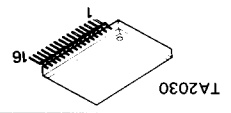
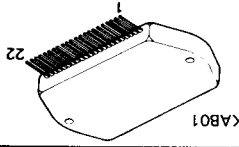

DC voltages are as measured with a high impedance voltmeter with no signal input. Values may vary slightly due to variations between individual instruments or/and units.

| DESTINATION | Ref. No. | R1,2 | R5~8 | R15,16 | R19,20 | R21,22 | C1,2 |
|-------------|----------|------|-------|--------|--------|--------|----------|
| 2-72 | E, T | 316 | 8.25K | 1.62K | 196 | 82.5K | 82P/125V |
| 0-12 | M | 330 | 8.2K | 2K | 200 | 82K | 82P |

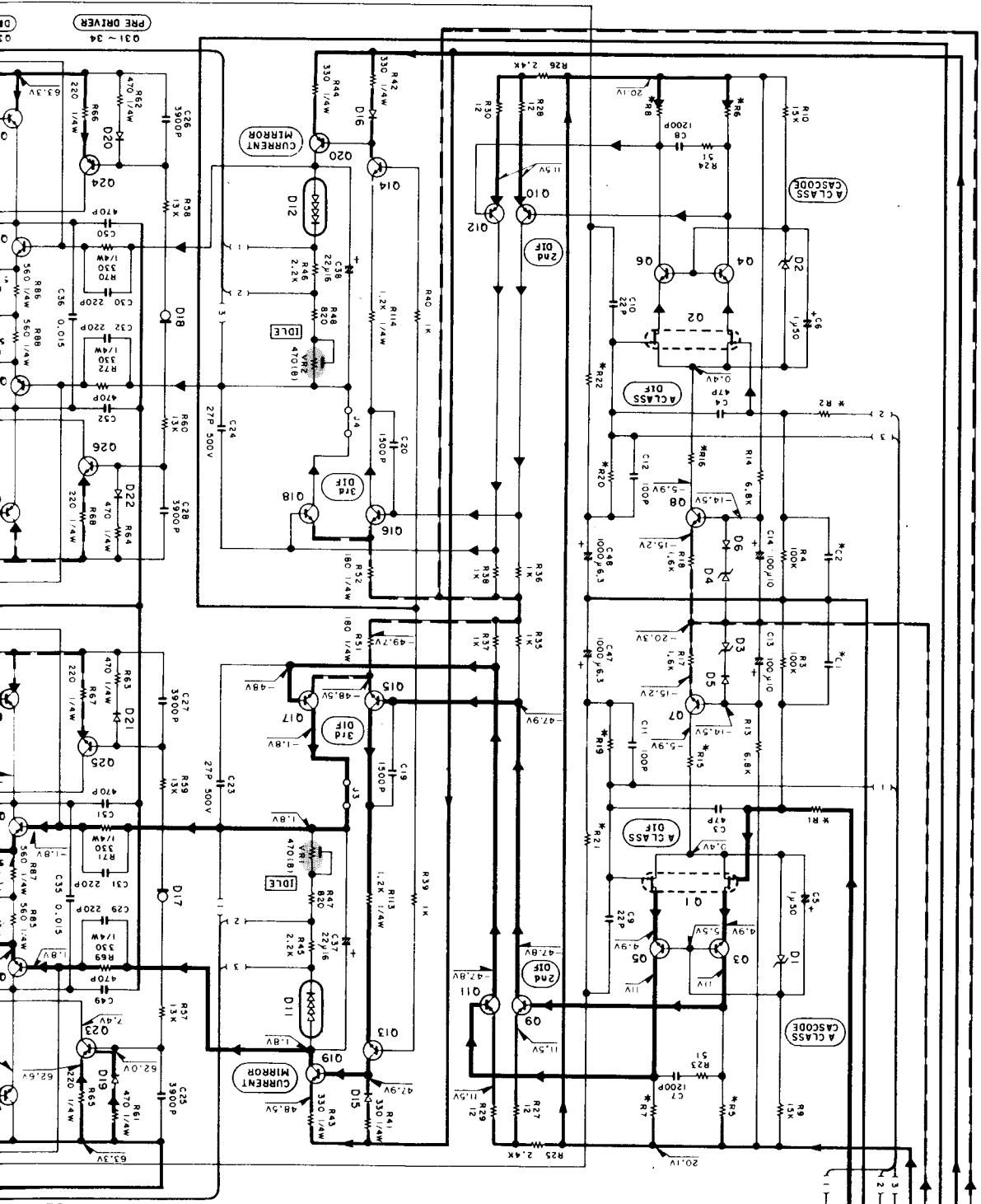
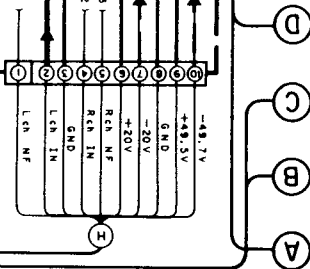

(X07-239X-XX)

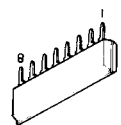

#PC1237HA



ZSA1B35
ZSC3944

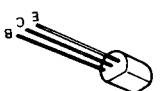

ZSC940A
ZSC945(A)

ZSA1123 ZSA733(A) ZSA999 ZSC1845 ZSC2631 ZSC2632
ZSA1534A ZSA992 ZSC2003 ZSC2003

03

PRE DRIVER
031 ~ 34

CASCADE BOOT STRAP CIRCUIT
023 - 30, 39 ~ 42

W

V

U

T

PREAMPLIFIER UNIT (X08-2232-71)

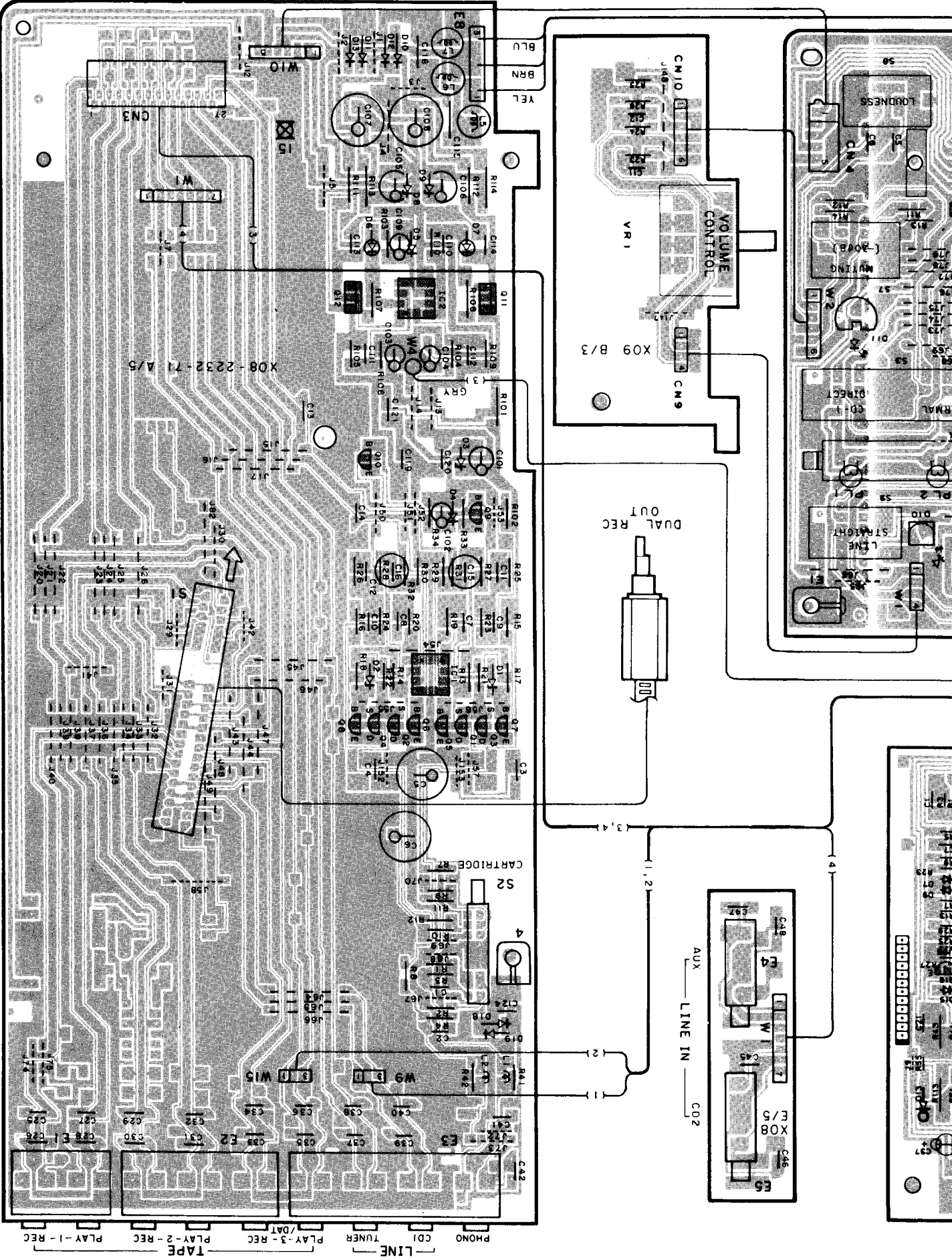

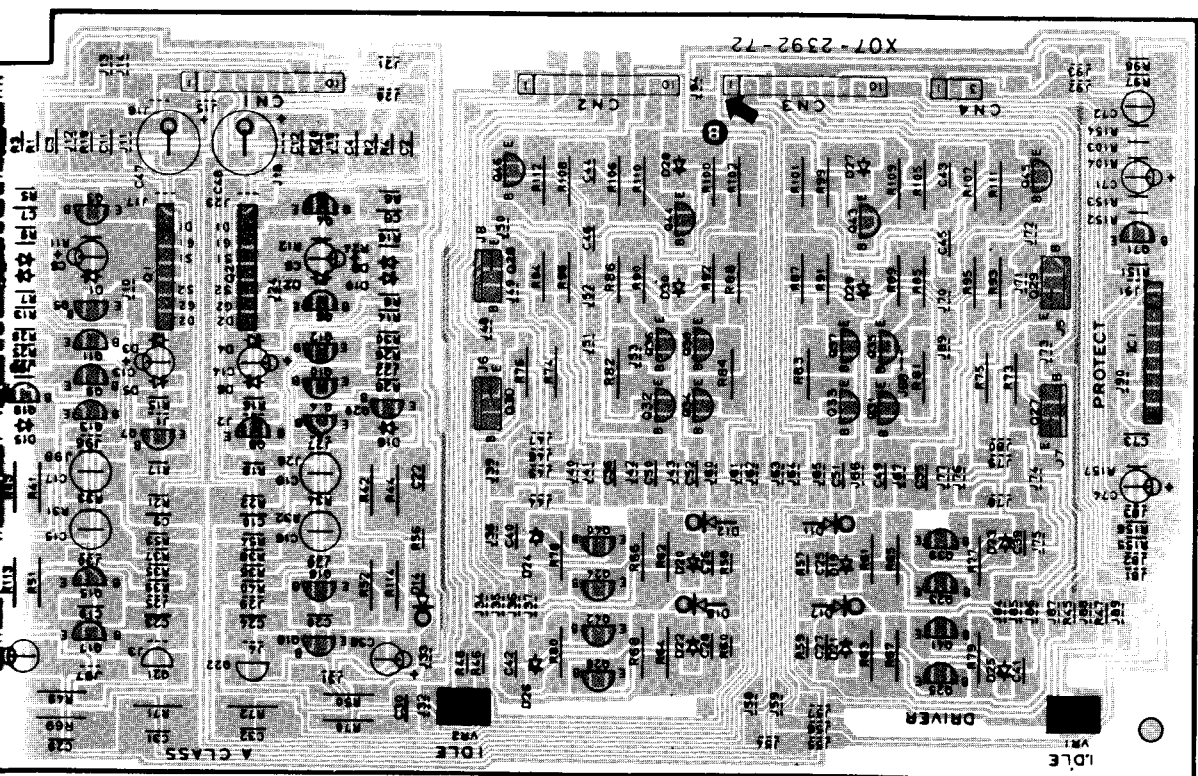
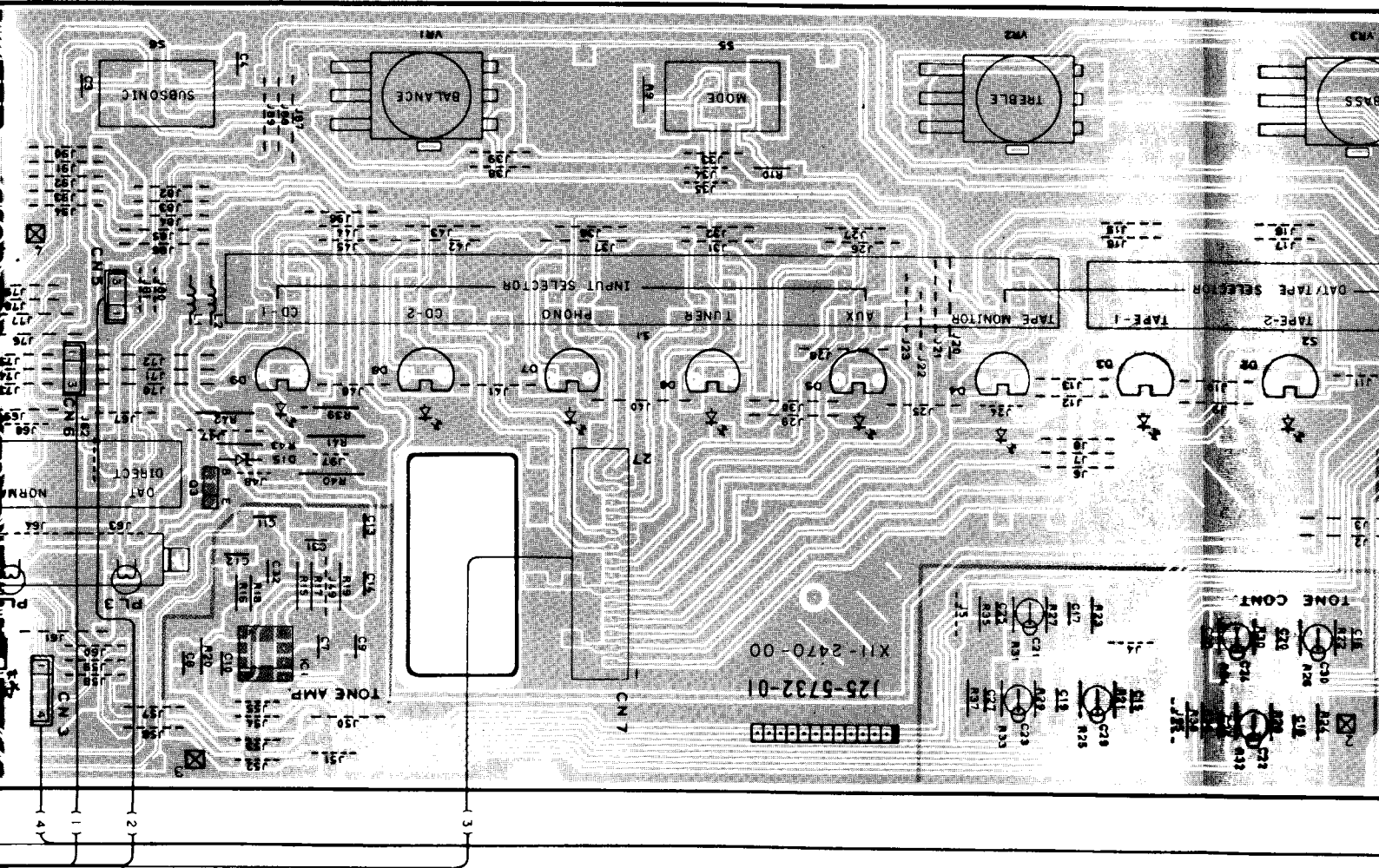

POWER AMPLIFIER UNIT (X07-2392-71)

POWER AMPLIFIER UNIT (X07-2392-72)

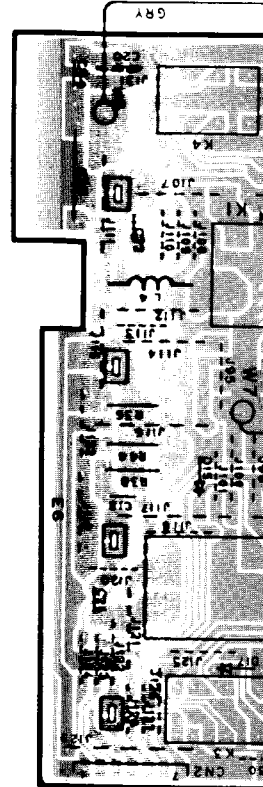

POWER AMPLIFIER UNIT (X08-2232-71)

TONE UNIT (X11-2470)

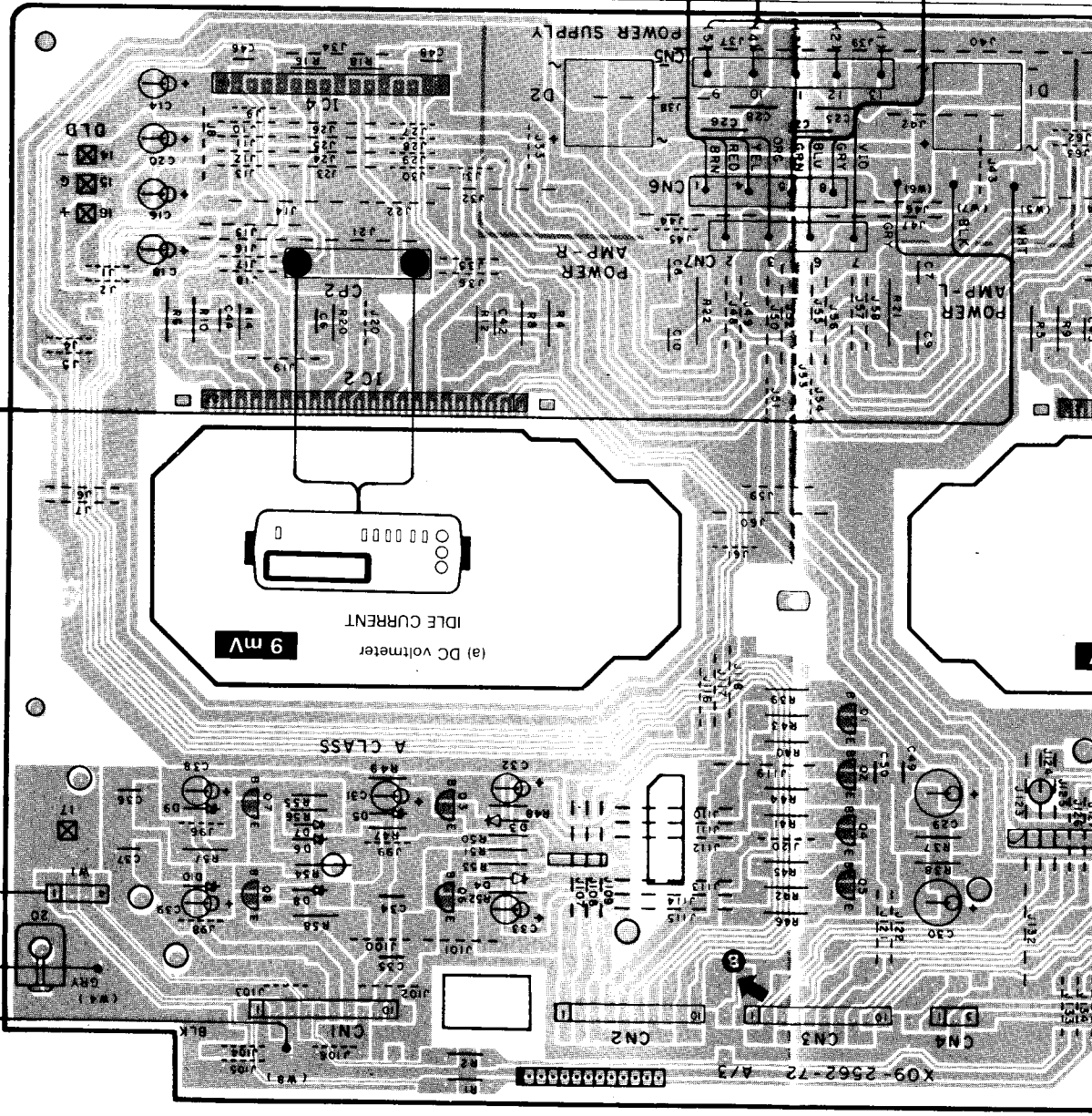
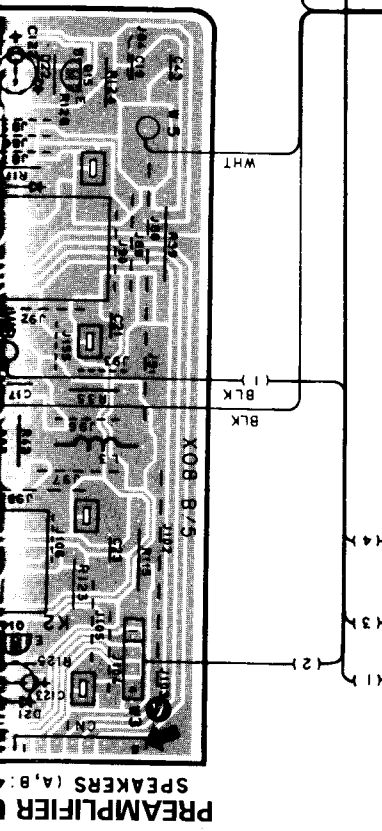
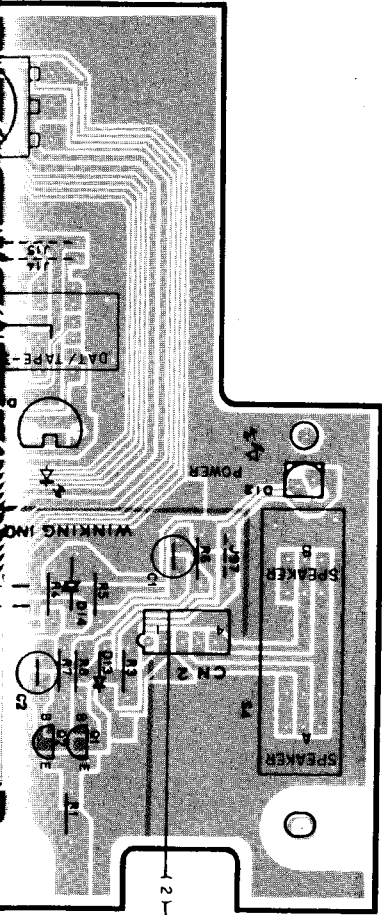

SUB-CIRCUIT UNIT (X13-5810-00)

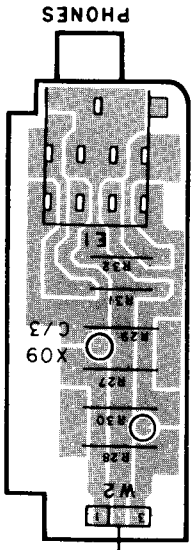
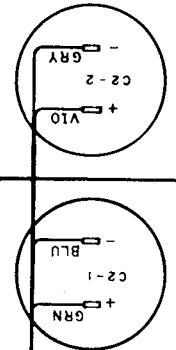
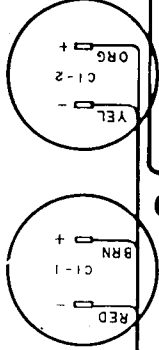
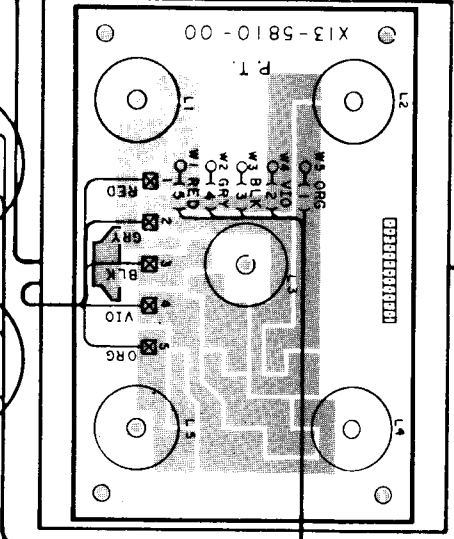

PC BOARD VIEW (Component side view)

AC220V/50Hz



2

3

4

5

6

7

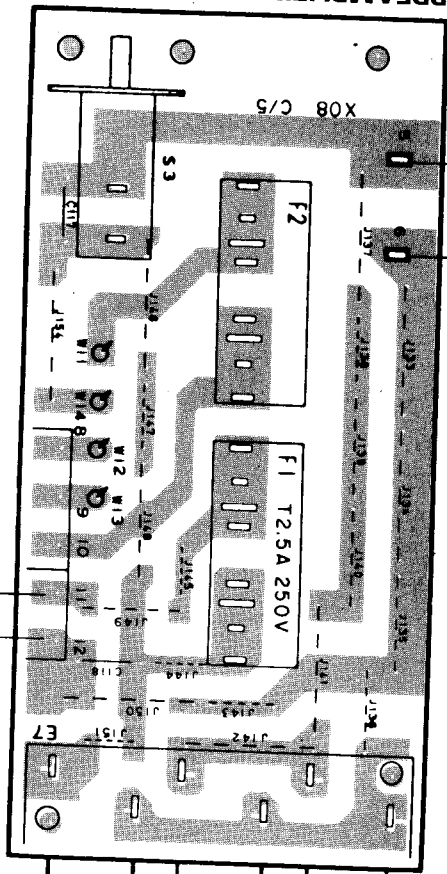

UNSWITCHED TOTAL 400W MAX. 100W MAX. SWITCHED

PREAMPLIFIER UNIT POWER
(X08-2232-71)

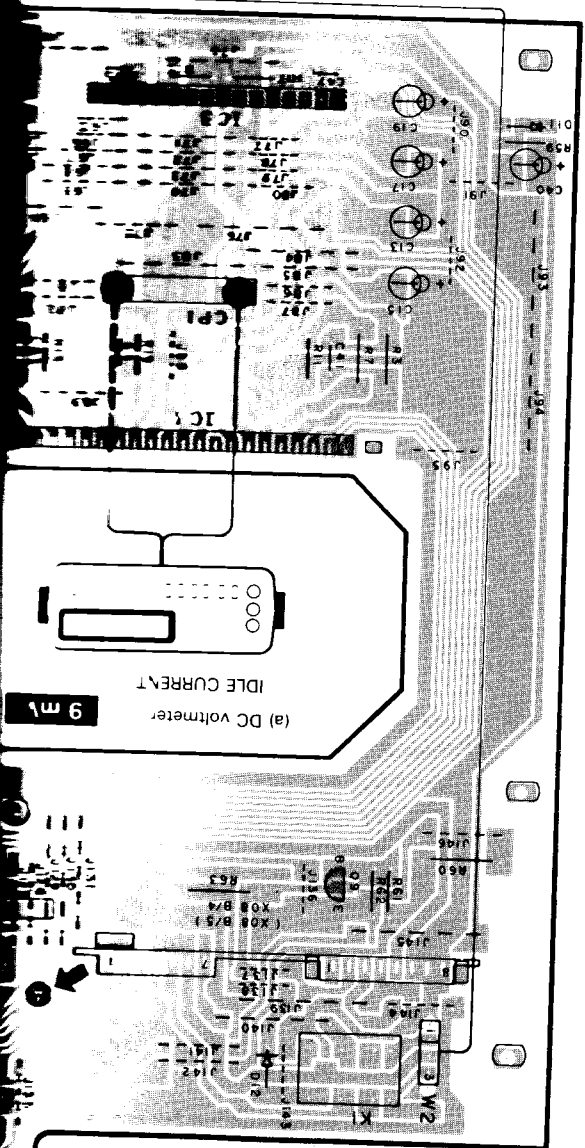

AUDIO UNIT
(X09-2562-72)

C

B

A

REC - 1 - PLAY TAPE REC - 2 - PLAY REC - 3 - PLAY /DAT LINE CD1 PHONO

PC BOARD VIEW (Foil side view)

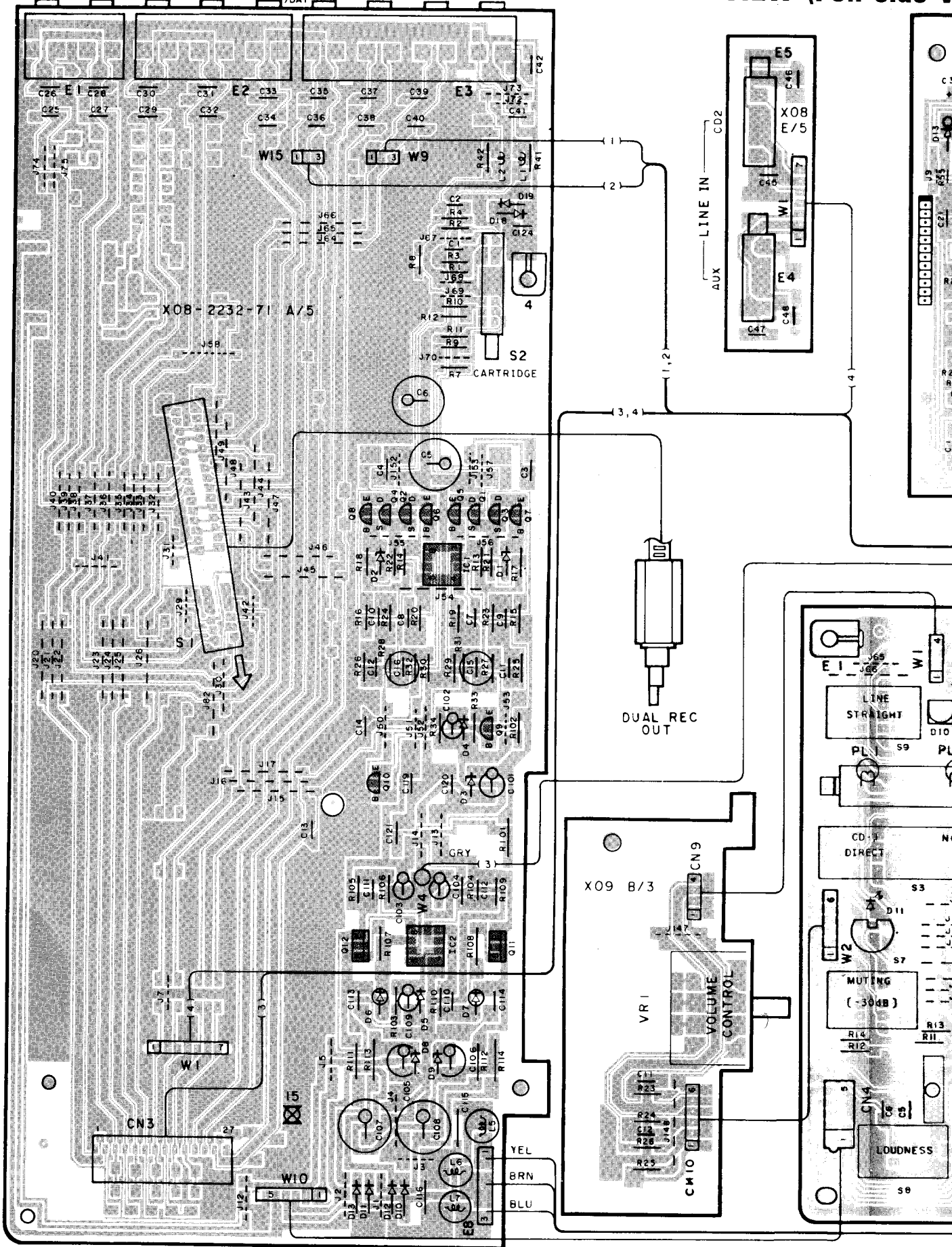

PREAMPLIFIER UNIT (X08-2232-71)

POWER AMPLIFIER UNIT (X07-2392-72)

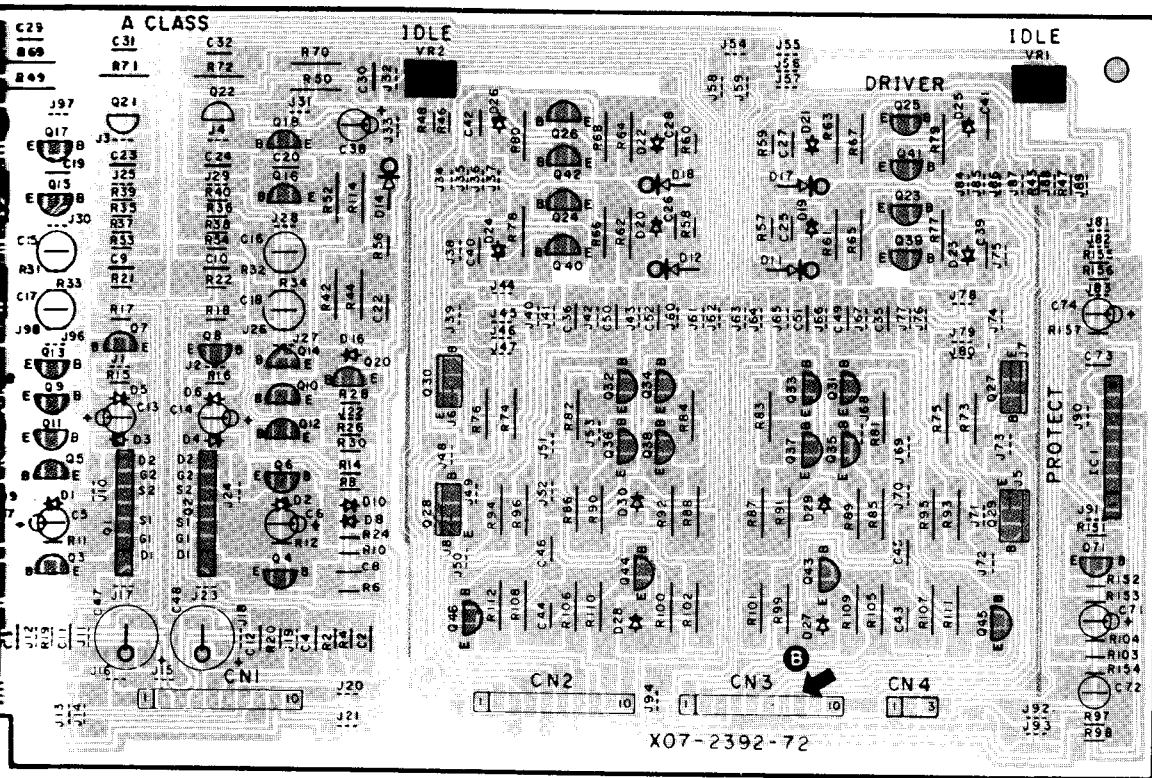

PREAMPLIFIER UNIT SPEAKERS (A,B 4~16Ω)

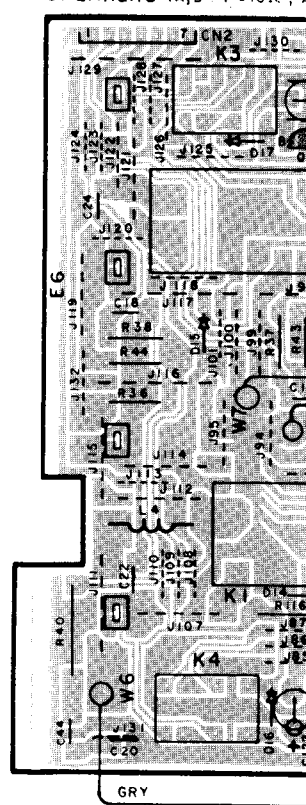

TONE UNIT (X11-2470-00)

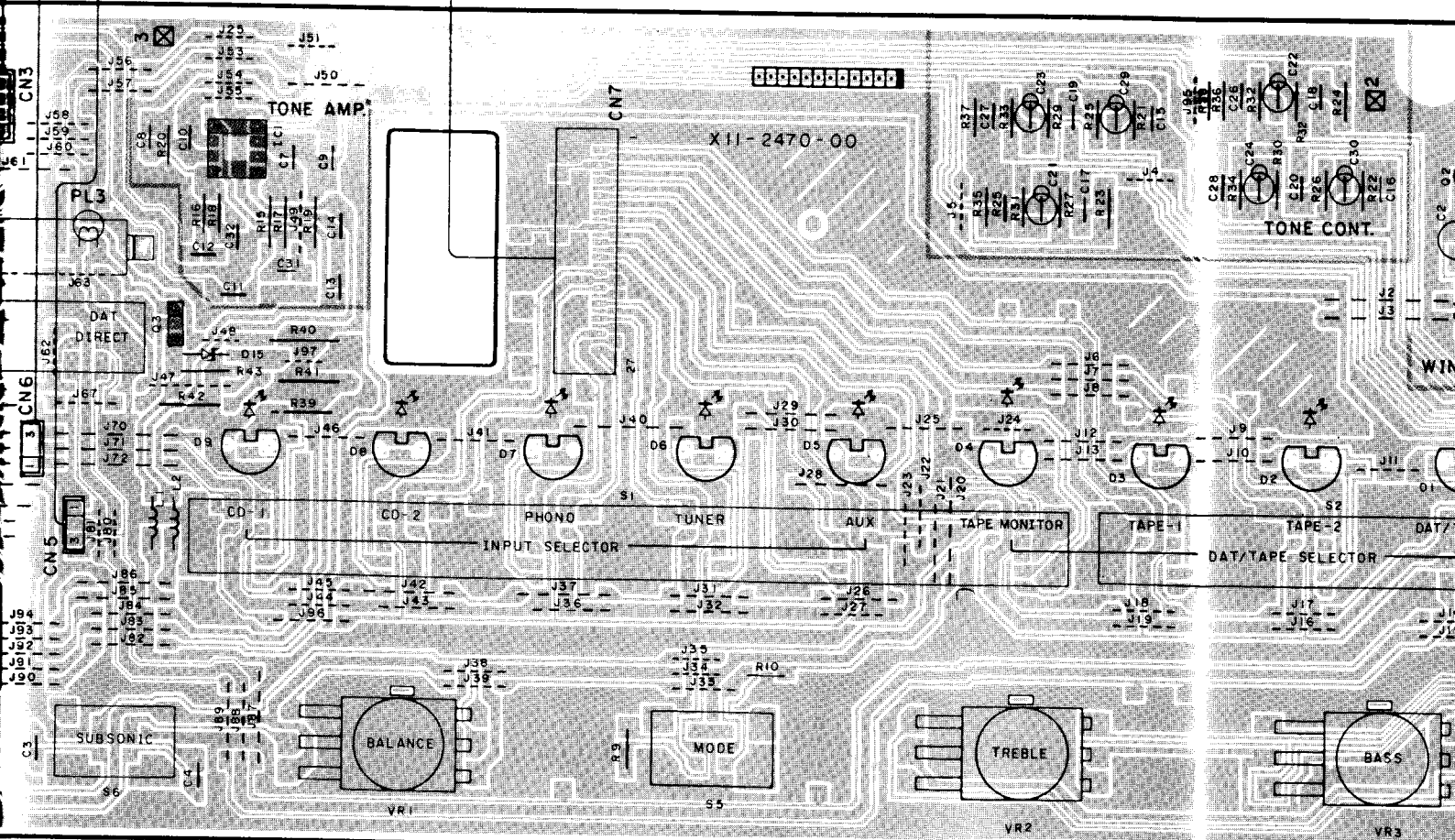

(X08-2232-71)

AUDIO UNIT (X09-2562-72)

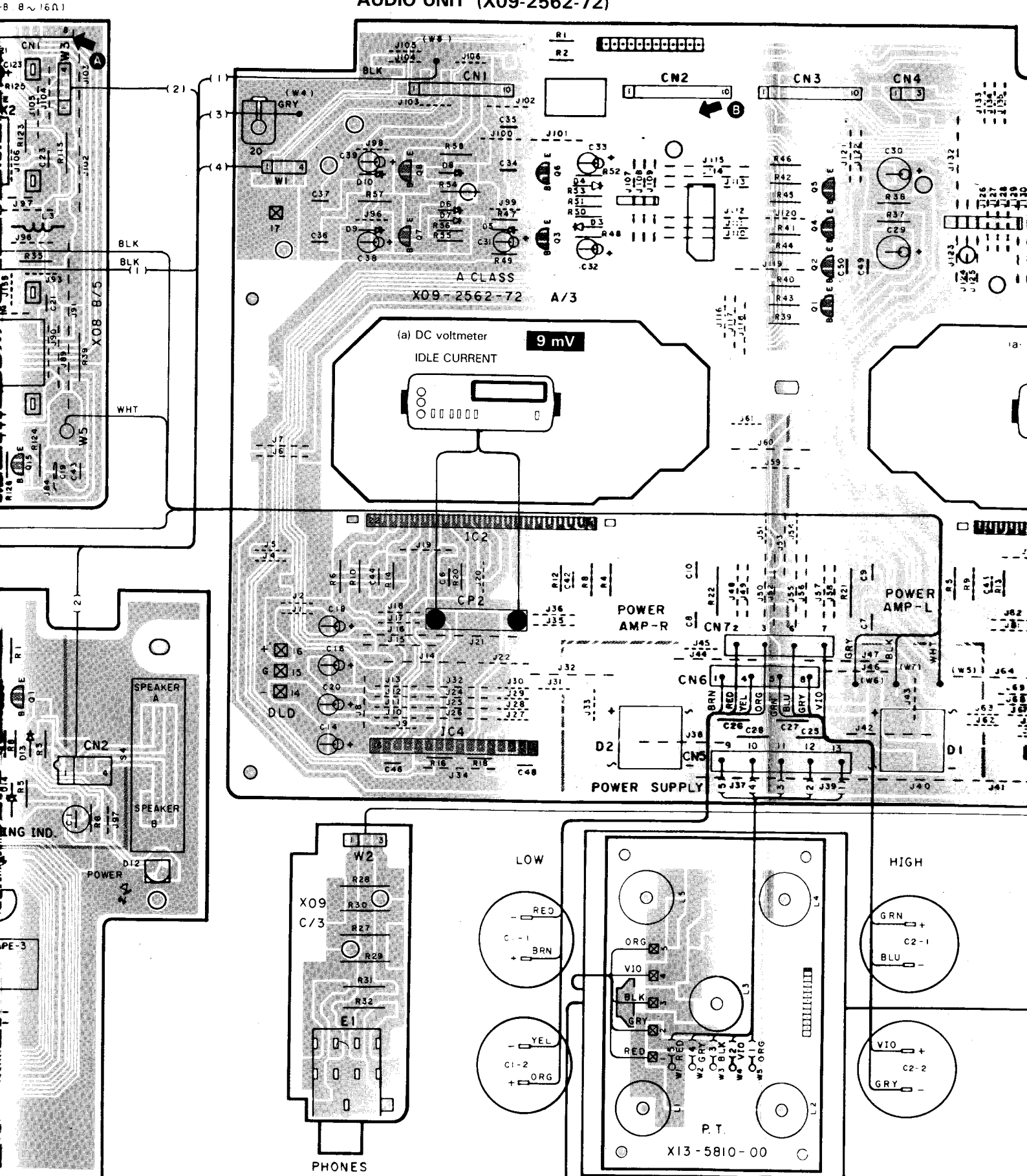

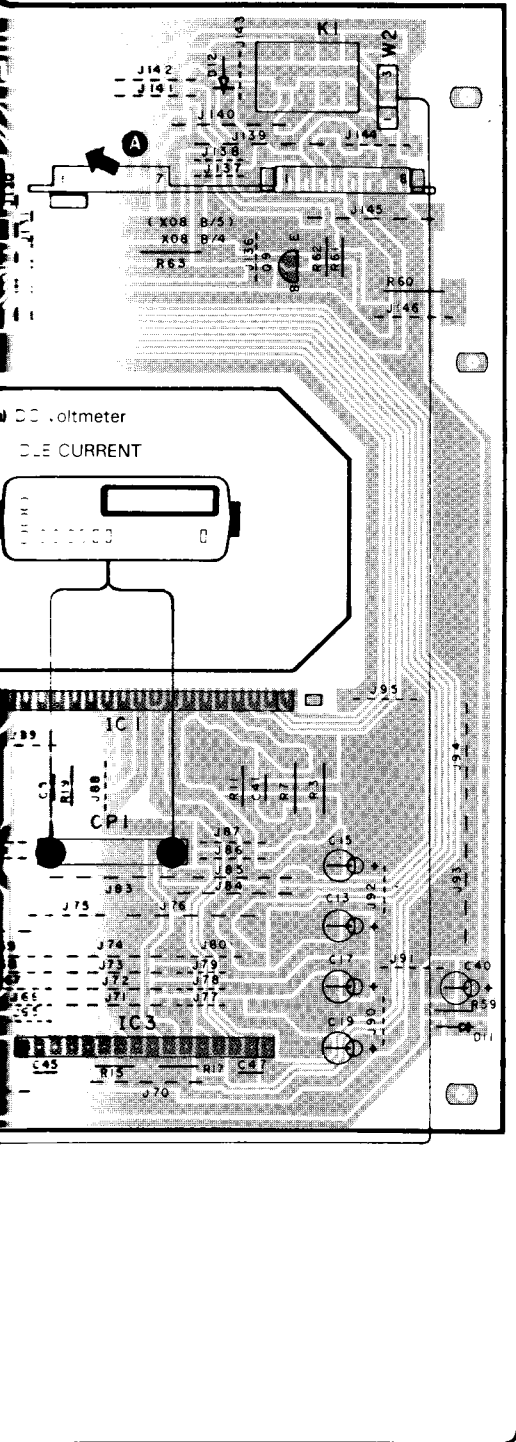

DC voltmeter
D.C. CURRENT



AC 220V/ 50Hz

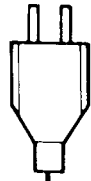

**PREAMPLIFIER UNIT
(X08-2232-71)**

SWITCHED UNSWITCHED
100W MAX. TOTAL 400W MAX.

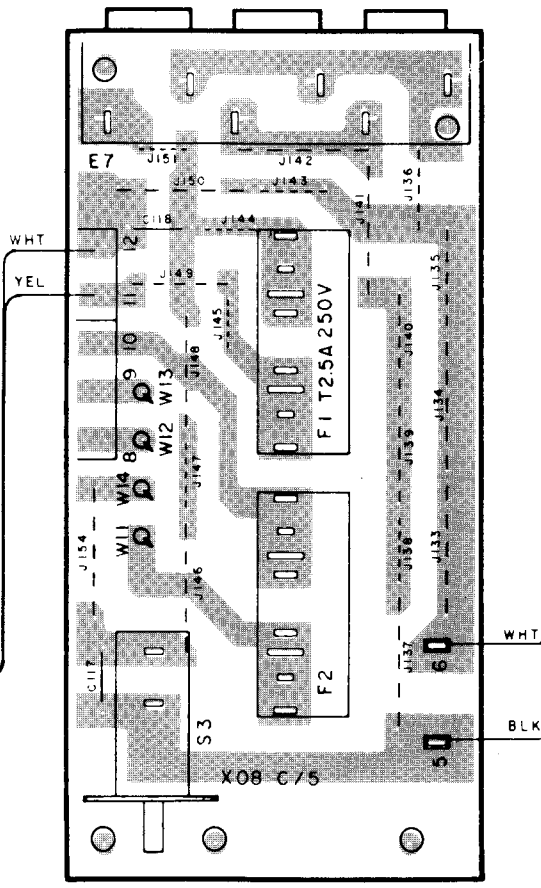

POWER

(X08-223X-XX)(E/5)

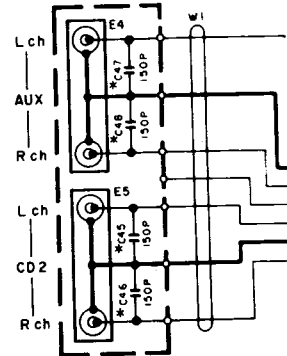

2SC2320

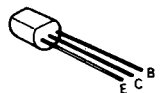

Refer to the schematic diagram for the values of resistors and capacitors.

1
2
3
4
5
6
7

TAPE 1
TAPE 2
TAPE 3 / DAY