

KR-V888D/1080VR

KENWOOD

Y05-3310-10

KR-V888D/1080VR(K) (5/6)

— B LINE
— +B LINE
— GND LINE
— SIGNAL LINE

DESTINATION	UNIT No.	U.22	YES	NO	U.23	YES	NO	U.24	YES	NO
RUSSIA	0 381									
EUROPE	E 271									
UK	T 051									
AUSTRIA	X 071									
GENERAL MARKET	M 021									
CHINA	C 301									
COUNTRY ABB.										
DESTINATION	UNIT No.	U.22	YES	NO	U.23	YES	NO	U.24	YES	NO
RUSSIA	0 381									
EUROPE	E 271									
UK	T 051									
AUSTRIA	X 071									
GENERAL MARKET	M 021									
CHINA	C 301									
COUNTRY ABB.										
DESTINATION	UNIT No.	U.22	YES	NO	U.23	YES	NO	U.24	YES	NO
RUSSIA	0 381									
EUROPE	E 271									
UK	T 051									
AUSTRIA	X 071									
GENERAL MARKET	M 021									
CHINA	C 301									
COUNTRY ABB.										

DESTINATION	UNIT No.	U.22	YES	NO	U.23	YES	NO	U.24	YES	NO
RUSSIA	0 381									
EUROPE	E 271									
UK	T 051									
AUSTRIA	X 071									
GENERAL MARKET	M 021									
CHINA	C 301									
COUNTRY ABB.										
DESTINATION	UNIT No.	U.22	YES	NO	U.23	YES	NO	U.24	YES	NO
RUSSIA	0 381									
EUROPE	E 271									
UK	T 051									
AUSTRIA	X 071									
GENERAL MARKET	M 021									
CHINA	C 301									
COUNTRY ABB.										

DESTINATION	UNIT No.	U.22	YES	NO	U.23	YES	NO	U.24	YES	NO
RUSSIA	0 381									
EUROPE	E 271									
UK	T 051									
AUSTRIA	X 071									
GENERAL MARKET	M 021									
CHINA	C 301									
COUNTRY ABB.										
DESTINATION	UNIT No.	U.22	YES	NO	U.23	YES	NO	U.24	YES	NO
RUSSIA	0 381									
EUROPE	E 271									
UK	T 051									
AUSTRIA	X 071									
GENERAL MARKET	M 021									
CHINA	C 301									
COUNTRY ABB.										

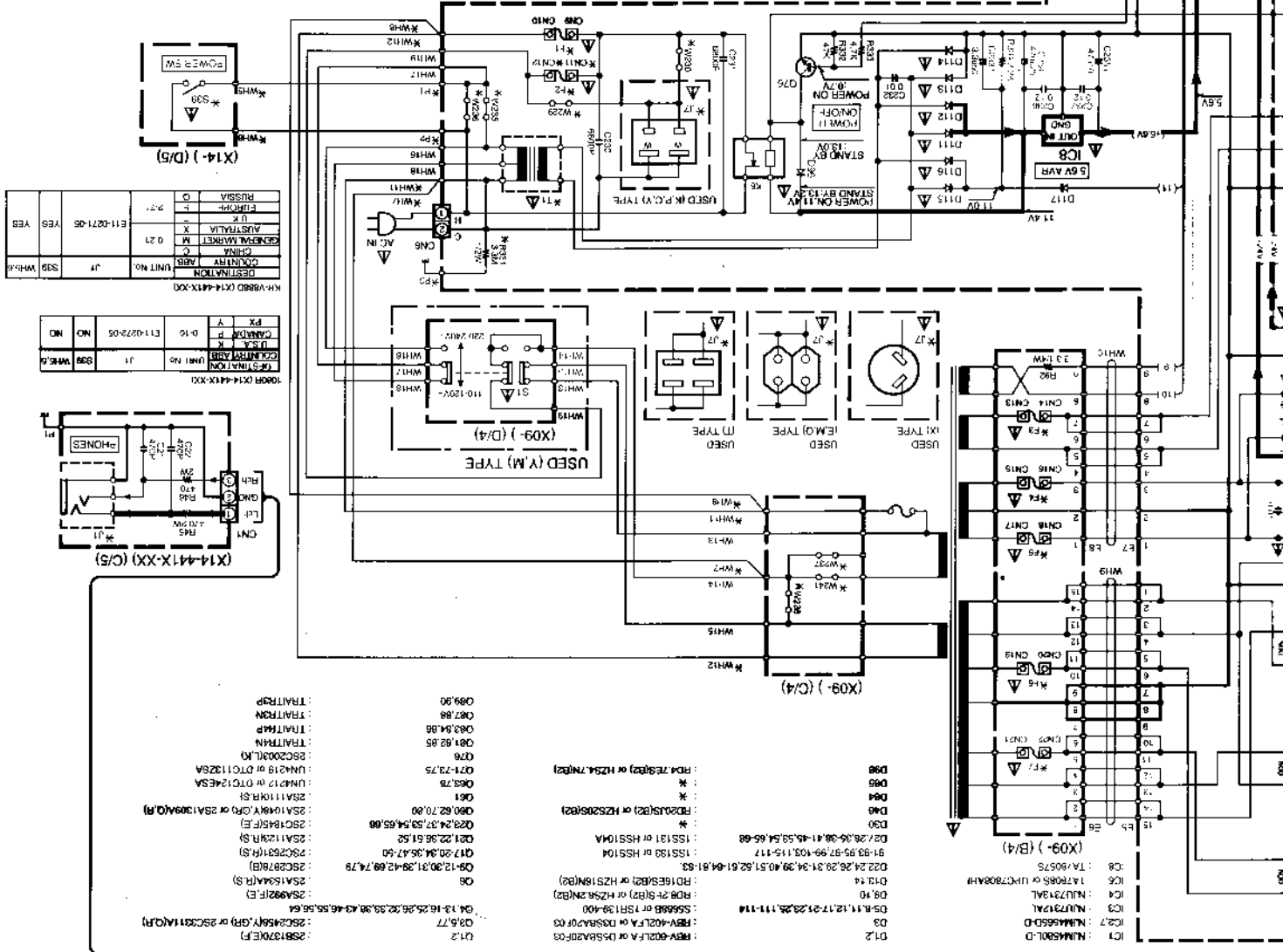

DESTINATION	UNIT No.	U.22	YES	NO	U.23	YES	NO	U.24	YES	NO
RUSSIA	0 381									
EUROPE	E 271									
UK	T 051									
AUSTRIA	X 071									
GENERAL MARKET	M 021									
CHINA	C 301									
COUNTRY ABB.										

DESTINATION	UNIT No.	U.22	YES	NO	U.23	YES	NO	U.24	YES	NO
RUSSIA	0 381									
EUROPE	E 271									
UK	T 051									
AUSTRIA	X 071									
GENERAL MARKET	M 021									
CHINA	C 301									
COUNTRY ABB.										

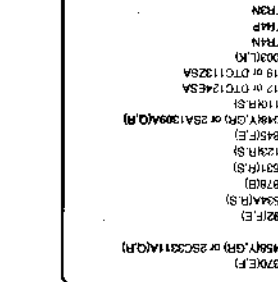
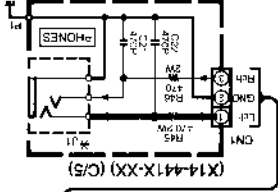

KR-V888D/1080VR

BLOCK DIAGRAM

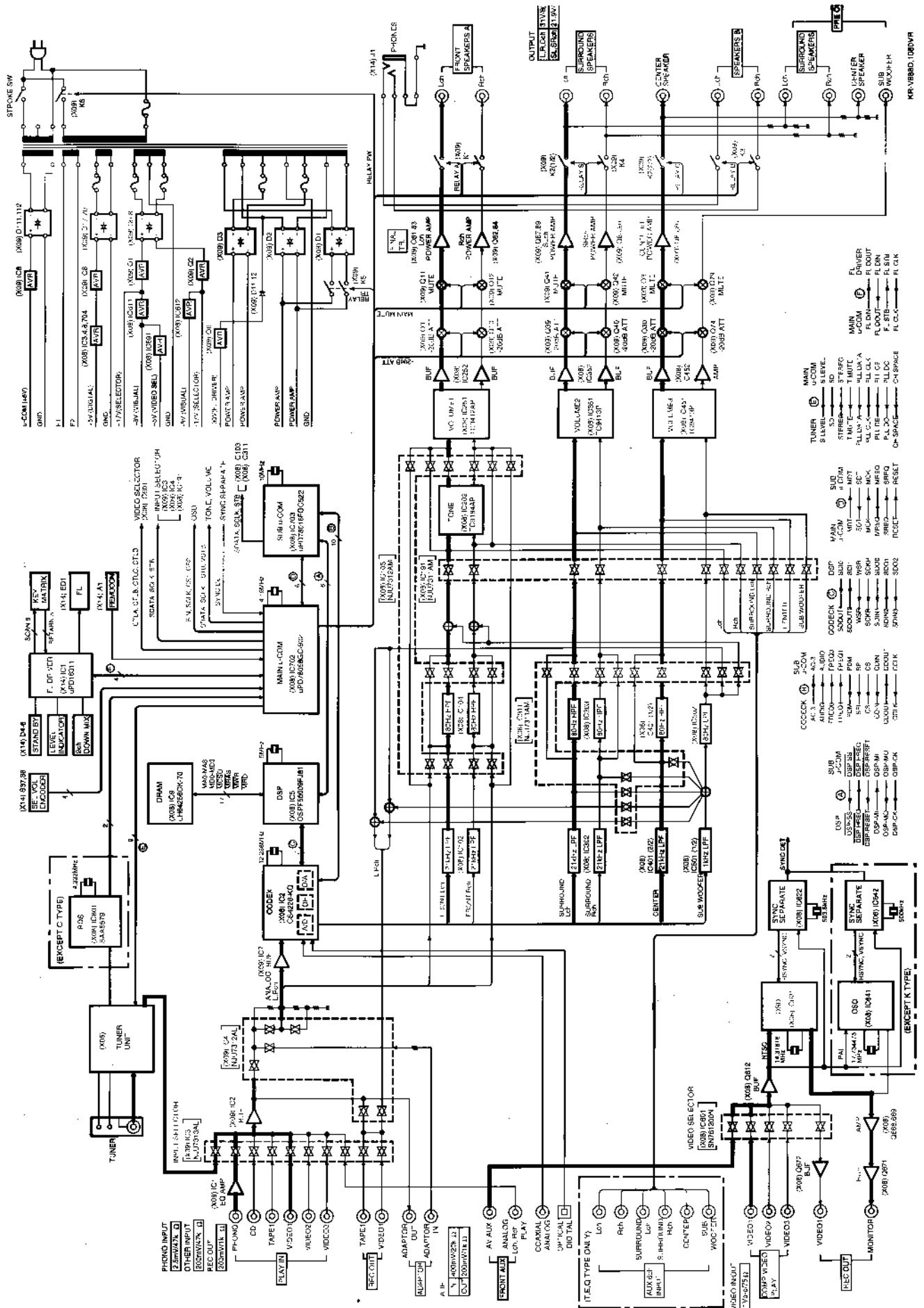

MR-V888D (1080VR)

PDI/MS/IN/	220	12K	8.2K	NO		YES		YES
				NO	YES	NO	YES	
D65	H125,126,183	H129,132,185,186	H231,234	R331	C8,10,21,22,23,26	C129,130	C148,150	W209,237,238
	221,228	261,266,330			28,34,37,38	193,194	147,149	W230,238,241

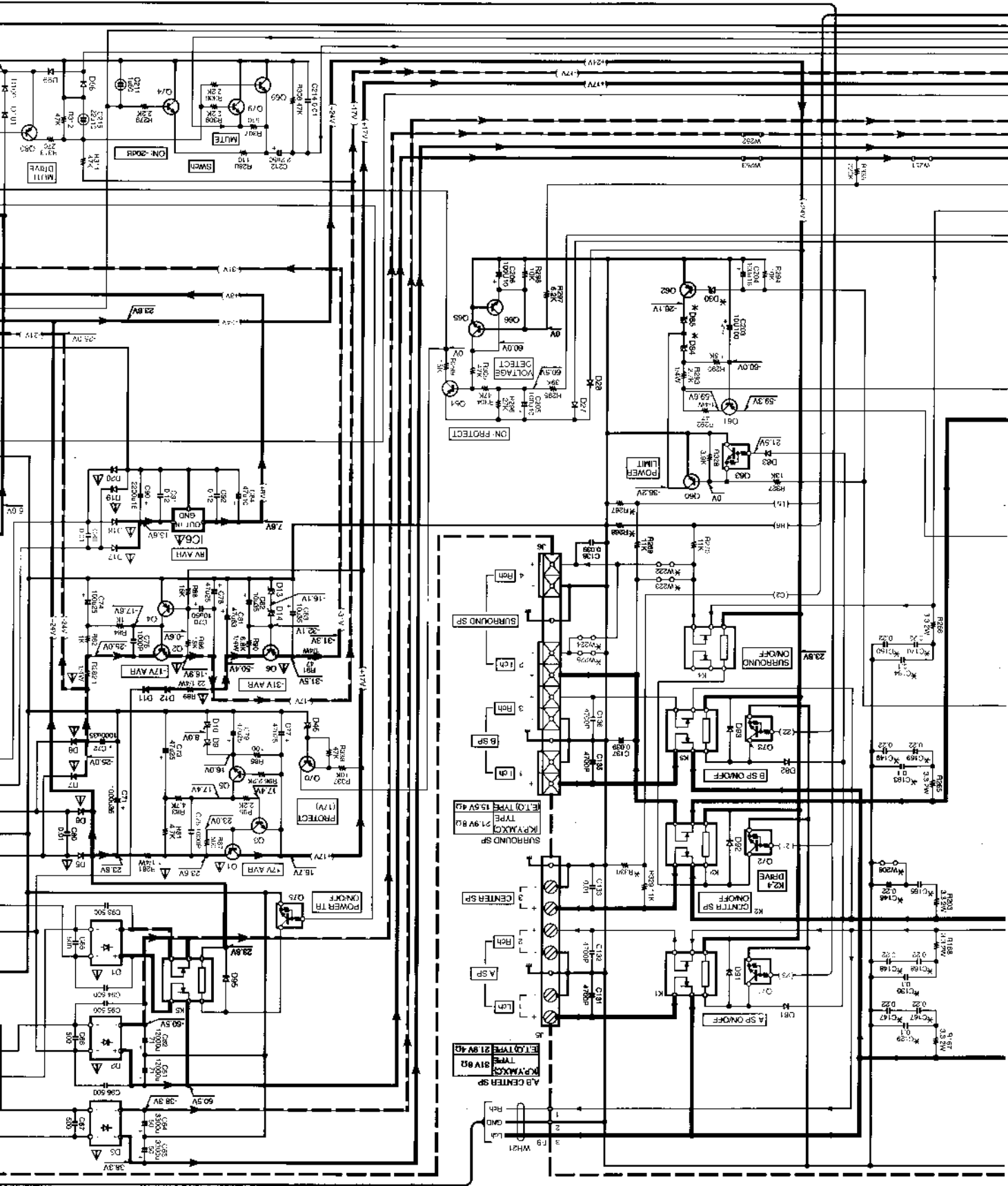

CC CD CE CF CG

(X08-274X-XX) (B/3)

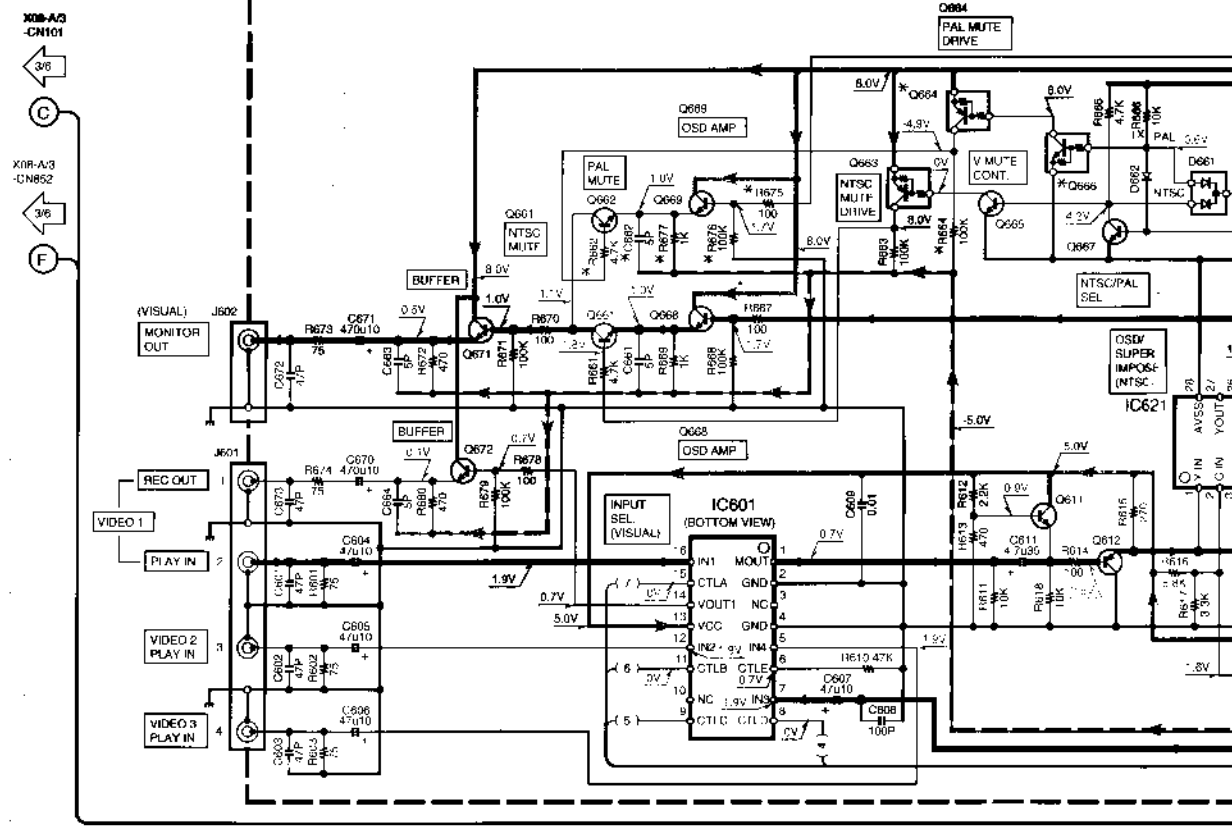
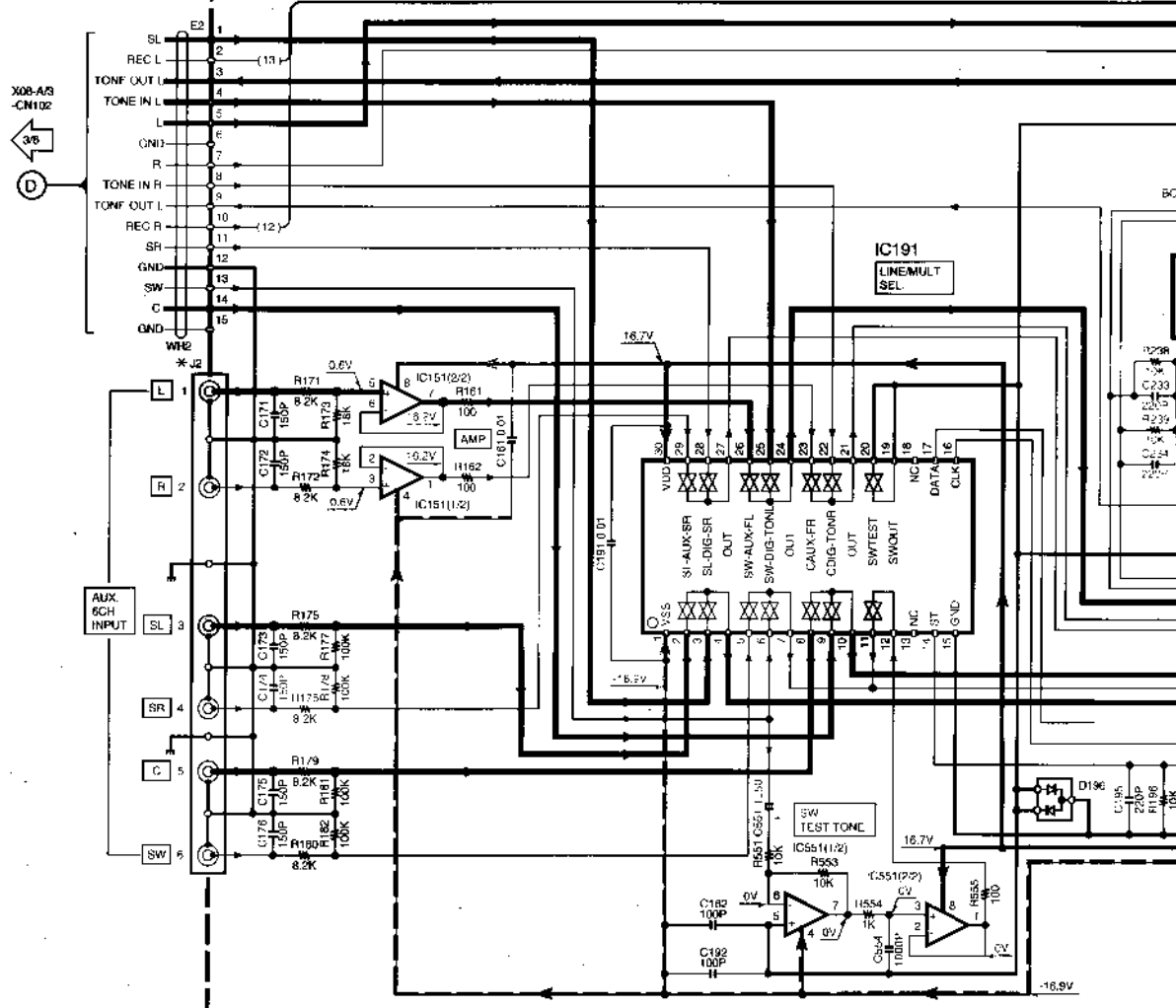

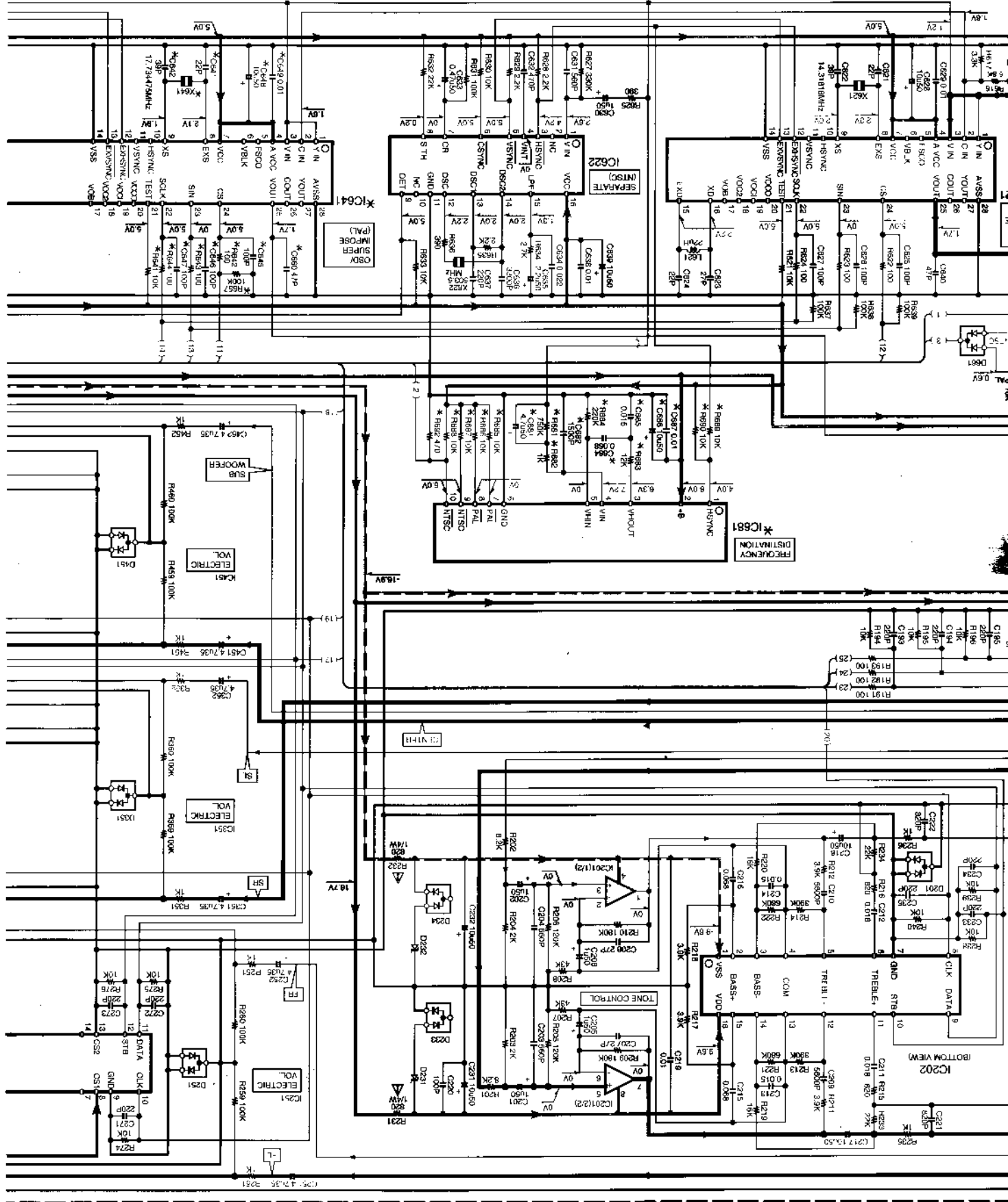

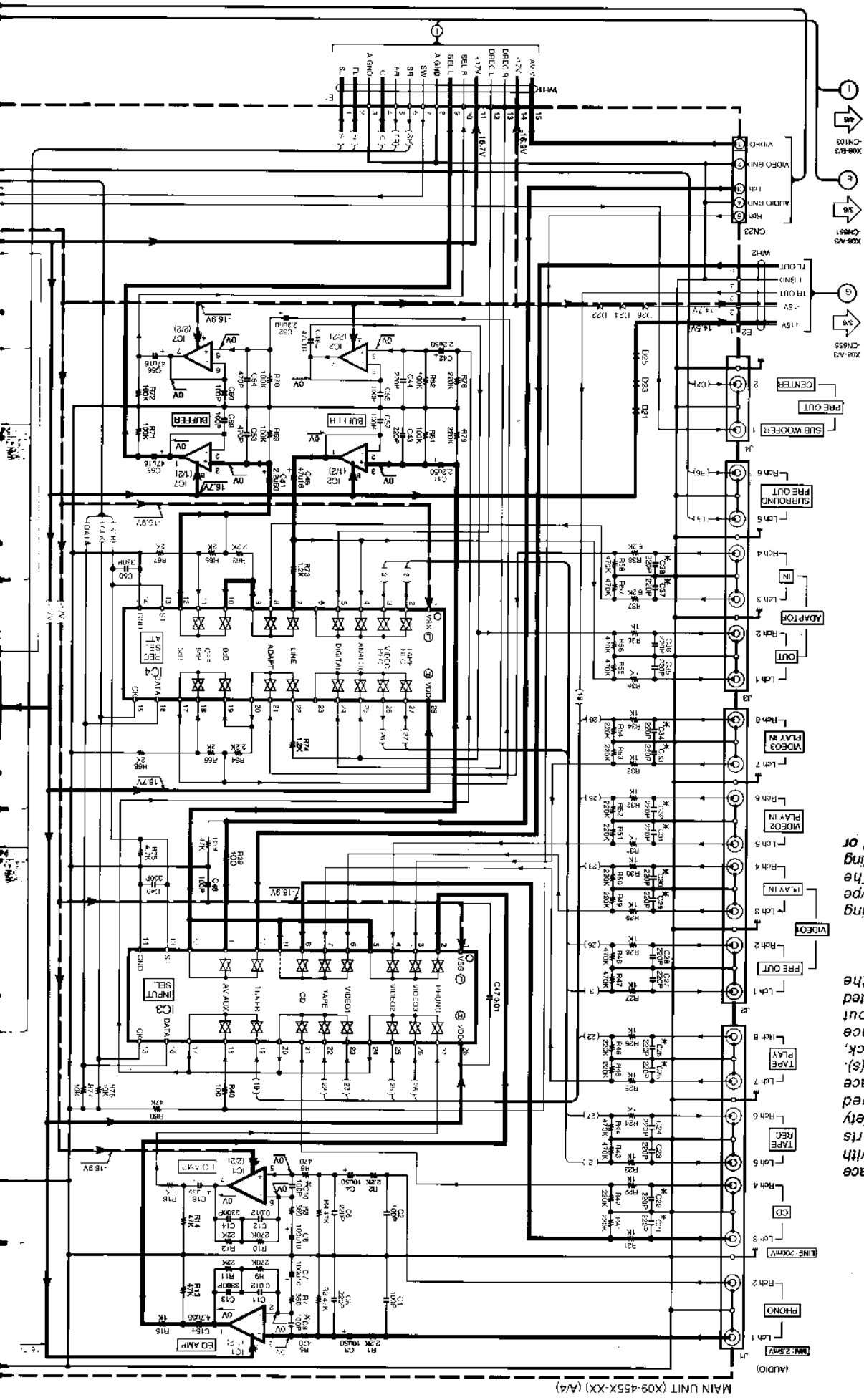

CAUTION: For continued safety, replace safety critical components only with manufacturer's recommended parts (refer to parts list). Δ indicates safety critical components. For continued protection against risk of fire, replace only with same type and rating fuses(s). To reduce the risk of electric shock, leakage-current or resistance measurements shall be carried out (exposed parts are acceptably insulated from the supply circuit) before the appliance is returned to the customer.

The DC voltage is an actual reading measured with a high impedance type voltmeter with no signal input. The measurement value may vary depending on the product.

MAIN UNIT (X9-455-XX) (A4)

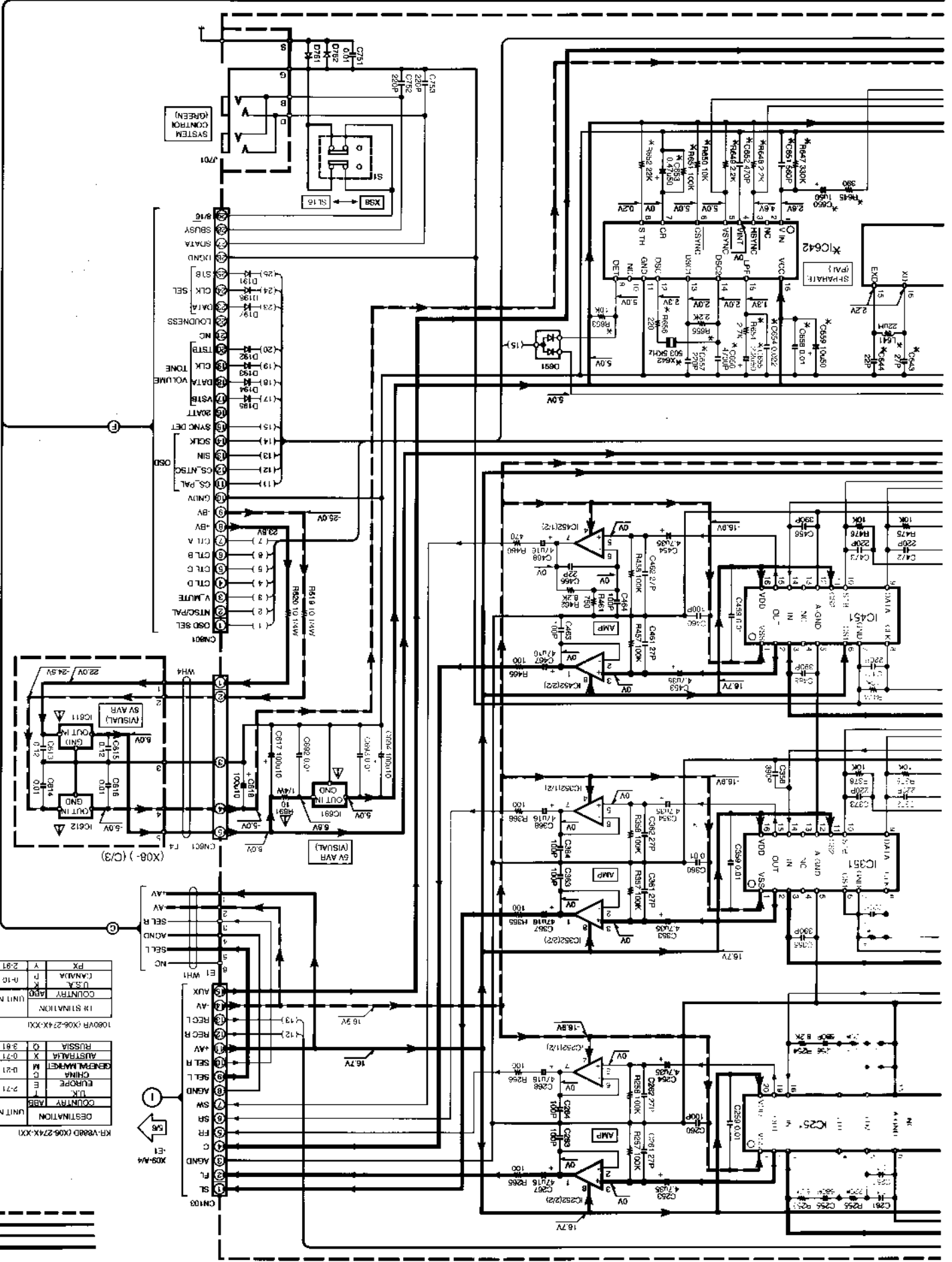

DESTINATION	UNIT No.	KR-988D (X06-274X-XX)
COUNTRY	ABB	
U.K.	E	7-71
EUROPE	J	
CHINA	M	0-21
GENERAL MARKET	C	0-21
AUSTRALIA	X	0-21
RUSSIA	Q	3-81
IRI STATION	UNIT No.	1080VR (X06-274X-XX)
COUNTRY	APP	
U.S.A.	P	0-10
CANADA	K	
FX	Y	2-81
YES		

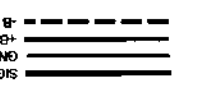

SIGNAL LINE
 GND LINE
 +B LINE
 -B LINE

IC641, 642	IC681	Q692, 694, 695, 696	Q641, 690, 692, 693, 694, 695, 696	R641, 645, 647, 657, 652, 654, 655, 673, 677, 681, 690	R692, 632	L641	X641, 642	J2
YES	YES	YES	YES	YES	NO	YES	YES	YES
	NO							NO
								YES

IC641, 642, 681	Q692, 694, 695, 696	Q641, 690, 692, 693, 694, 695, 696	R641, 645, 647, 657, 652, 654, 655, 673, 677, 681, 690	R692, 632	L641	X641, 642	J2
NO	NO	NO	NO	YES	NO	NO	NO
YES	YES	YES	YES	NO	YES	YES	YES

- (X08-1) (B3WC3)
- IC181, 201, 232, 252, 452, 551
- NJM4565M
- IC181 NJU7311AM
- IC292 TC9184AP
- IC251 TC9412AP
- IC351, 451 TC9413P
- IC801 SN761200N
- IC811 TA7805S
- IC812 TA79005S
- IC821, 841 MB90009PF-108
- IC822, 842 MM1067AF
- IC801 LA7805
- IC811 TA7805B or MPC7805AHF
- Q61, 1, 201, 232 2SC4081(R,S) or 2SC4116(Y,GR)
- Q612 2SA1578A(R,S) or 2SA1586(Y,GR)
- Q691, 692 2SC4213(B)
- Q693, 694 UM6112 or DT4124EUA
- Q695-697 UN5212 or DTC124EUA
- Q671, 672 2SC3115/D07.2B
- D195, 201, 232, 252, 451, 551 DA204U or 1SS302 or MA143A
- D191-195, 197, 198, 662, 751, 752 MA111
- D231, 232 UDZ8.2B
- O661 DAN202U or 1SS301 or MA142WK
- O691 DAN202U or 1SS300 or MA142WA

CAUTION: For continued safety, replace safety critical components only with manufacturer's recommended parts (refer to parts list). Δ indicates safety critical components. For continued protection against risk of fire, replace only with same type and rating fuse(s). To reduce the risk of electric shock, leakage-current or resistance measurements shall be carried out (exposed parts are acceptably insulated from the supply circuit) before the appliance is returned to the customer.

The DC voltage is an actual reading measured with a high impedance type voltmeter with no signal input. The measurement value may vary depending on the measuring instruments used or on the product.

2SA1110 DTC124ESA 2SA1586 2SC4081 2SB1370
 2SA1048 2SC2714 2SC4116
 2SC2458 2SC3115

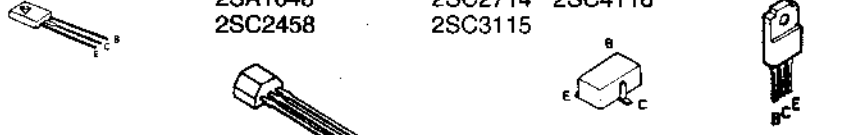

TRAITR3N
 TRAITR3P
 TRAITR4N
 TRAITR4P



NJM4565D-D

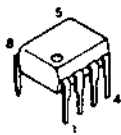

TC9184AP

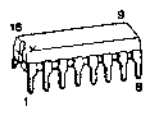

TC9413P

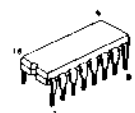

SN761200N

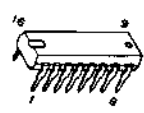

UN4212
 UN4219
 2SA1309A
 2SC3311A

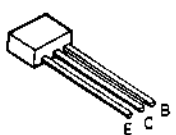

NJM4565M
 TC7W04FU



UPD16311



DAN202U

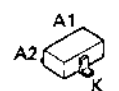

UPC7805AHF
 UPC7808AHF



DAP202U
 DA204U



MA142WA
 MA142WK
 UN5212



1SS301

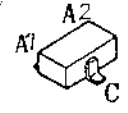

MC13028AM

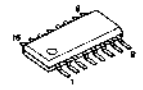

TC74HCU04AF

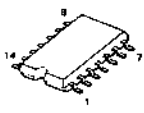

2SD1757K

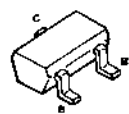

TC9412AP

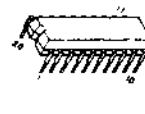

LC72131

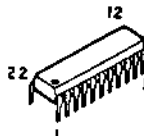

NJU7311AM
 NJU7312AM

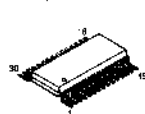

TA7805S

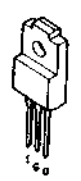

TA79005S

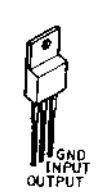

LA1832

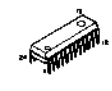

2SA1123
 2SA1534A
 2SA992
 2SC1845
 2SC2003

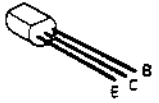

2SC2631
 2SC2878

TC7S04F

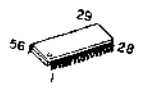

NJU7312AL
 NJU7313AL

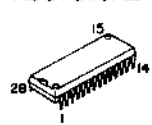

TA7808S

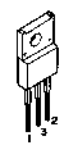

NJM4580L-D

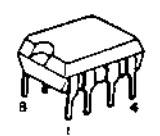

DSPF56009FJ81

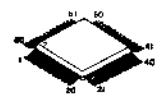

KR-V888D/1080VF

KENWOOD

Y05-3310-10