

AM-FM STEREO RECEIVER

KR-A4070/A5070 [E, T, G Type]

SERVICE MANUAL

KENWOOD



KENW-04416

© 1995-3 PRINTED IN KOREA
B51-5057-00(S) 1812

PHOTO is KR-A4070 (T type)

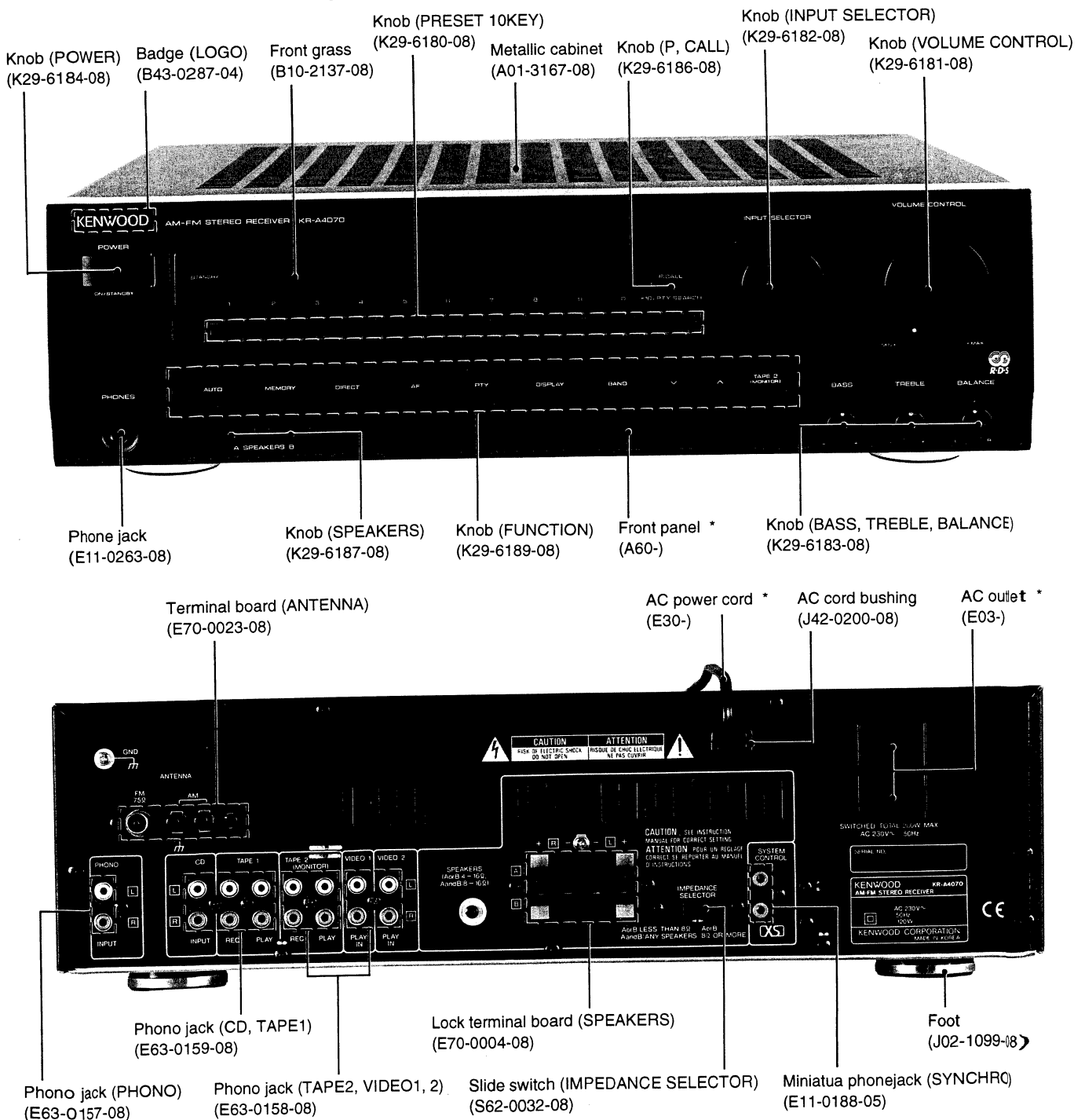

* Refer to parts list on page 26.



4416

KR-A4070/A5070 [E, T, G]

CONTENTS/ACCESSORIES

CONTENTS/ACCESSORIES.....	2	WIRING DIAGRAM.....	12
EXTERNAL VIEW KR-A5070.....	3	PC BOARD(Component side view).....	13
DISASSEMBLY FOR REPAIR.....	4	SCHEMATIC DIAGRAM.....	17
BLOCK DIAGRAM.....	5	EXPLODED VIEW.....	25
CIRCUIT DESCRIPTION.....	6	PARTS LIST.....	26
ADJUSTMENT.....	11	SPECIFICATIONS.....	31

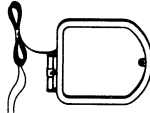
ACCESSORIES

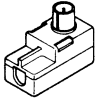
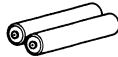
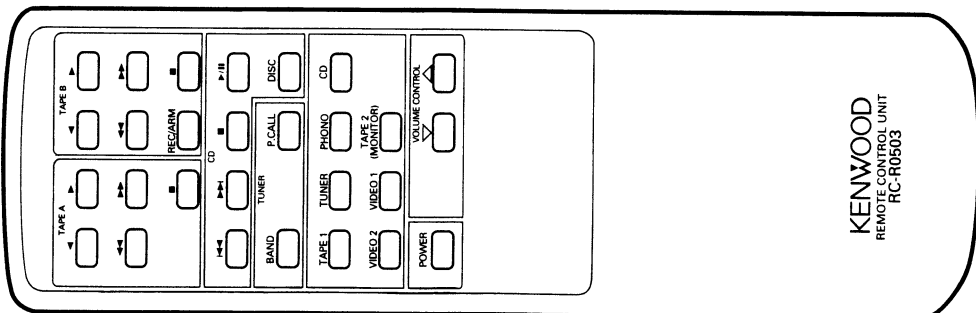
<p>T type antenna(1) (T90-0176-05)</p> 	<p>AM loop antenna.....(1) (T90-0804-08)</p> 	<p>Loop antenna holder(1) (J19-2815-04)</p> 
<p>Antenna adaptor(1) (T90-0805-08)</p> 	<p>Batteries (R6/A4).....(2)</p> 	
<p>Remote control unit (RC-R0503).....(1) (A70-0985-08)</p> 		<p>Battery cover (A09-0170-08)</p>

Model: RC-R0503
Infrared ray system

INSTRUCTION MANUAL

	Parts No.	Destination
ENGLISH	B60-2114-08	T, E
FRE/DUC/ITA/SPA	B60-2115-08	E
GERMANY	B60-2116-08	E, G

KR-A4070/A5070 [E, T, G]

EXTERNAL VIEW : KR-A5070

PHOTO is KR-A5070 (E, G type)

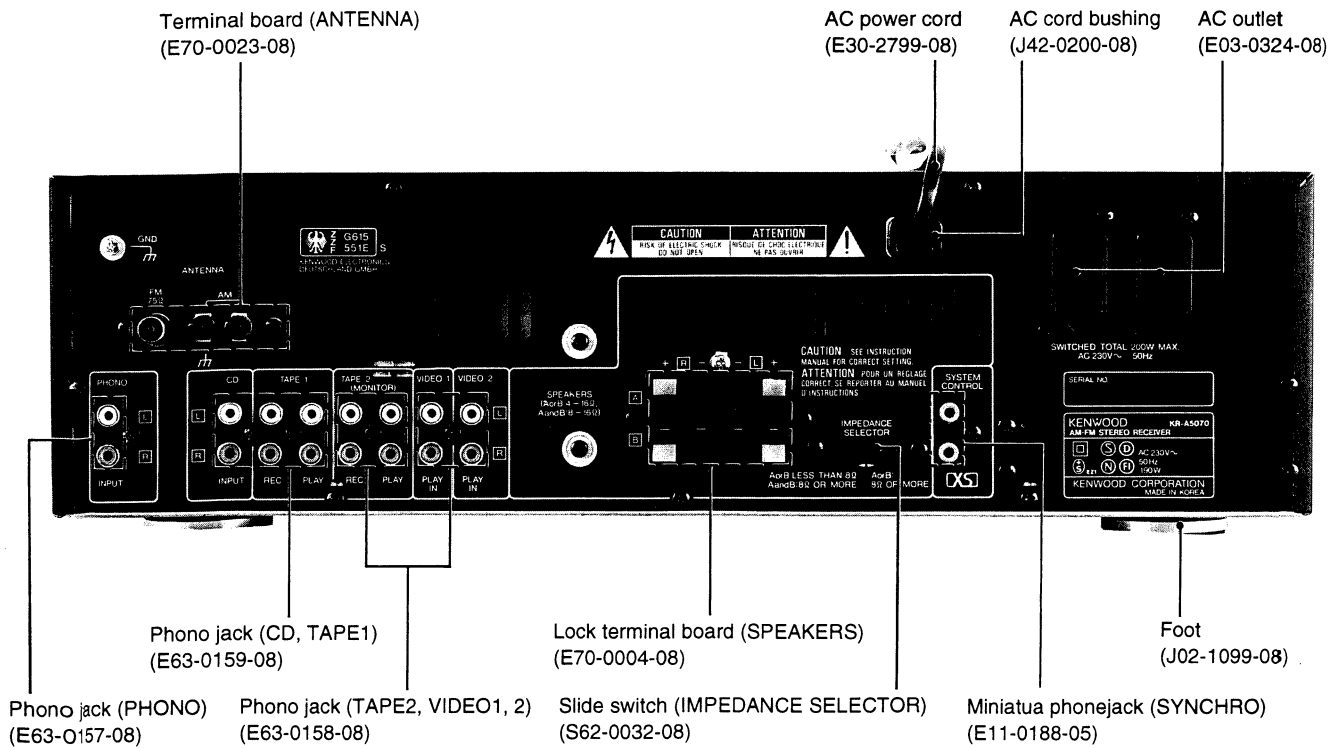
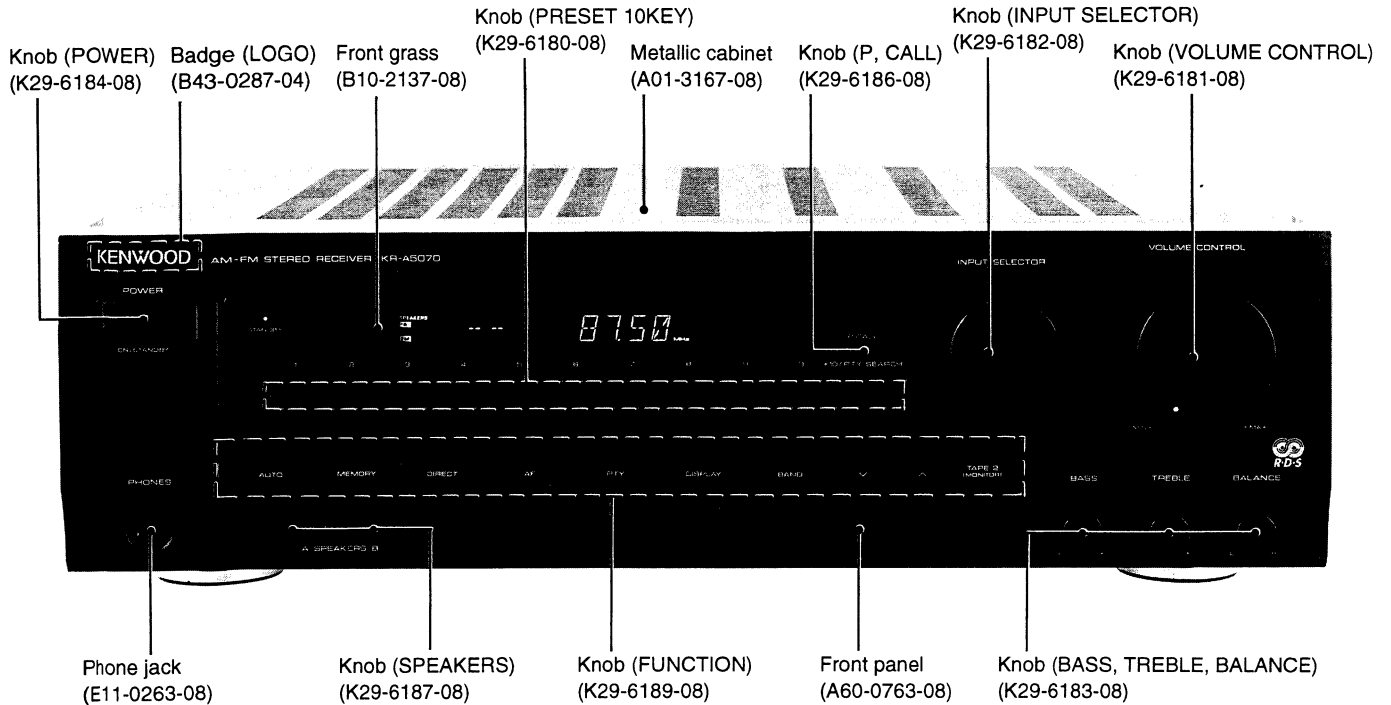

* Refer to parts list on page 26.

KR-A4070/A5070 [E, T, G]

DISASSEMBLY FOR REPAIR

[Illustrations are reference materials.]

1. Repair can be carried out with the Main (AUDIO) PCB and the power supply PCB mounted on the rear panel when the 17 screws (❶) are removed.

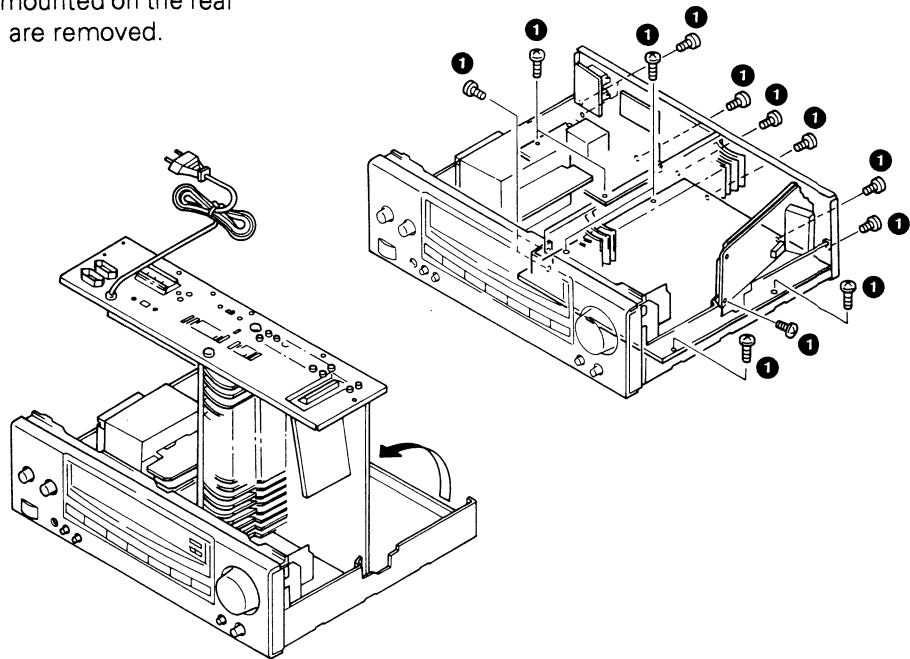

2. Cut the 4 places with a pair of nippers (❶), and remove the bottom panel from chassis.
3. Move the unit holder from the current position to the open mounting position.
4. Rotate the lid, which was cut off, by 180° degrees (❷).
5. Insert the lids in the 2 places of the chassis (❸), and mount them with the 3 screws (❹).

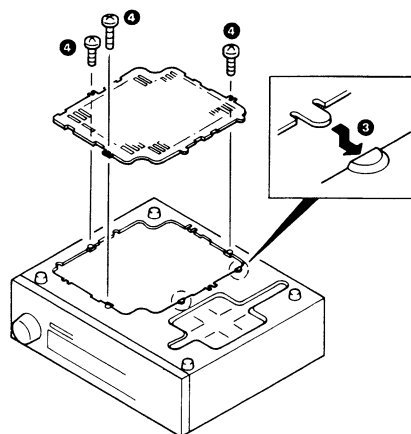
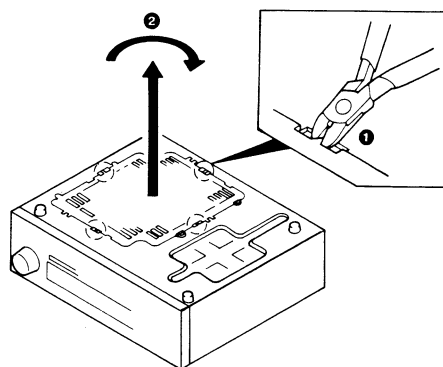

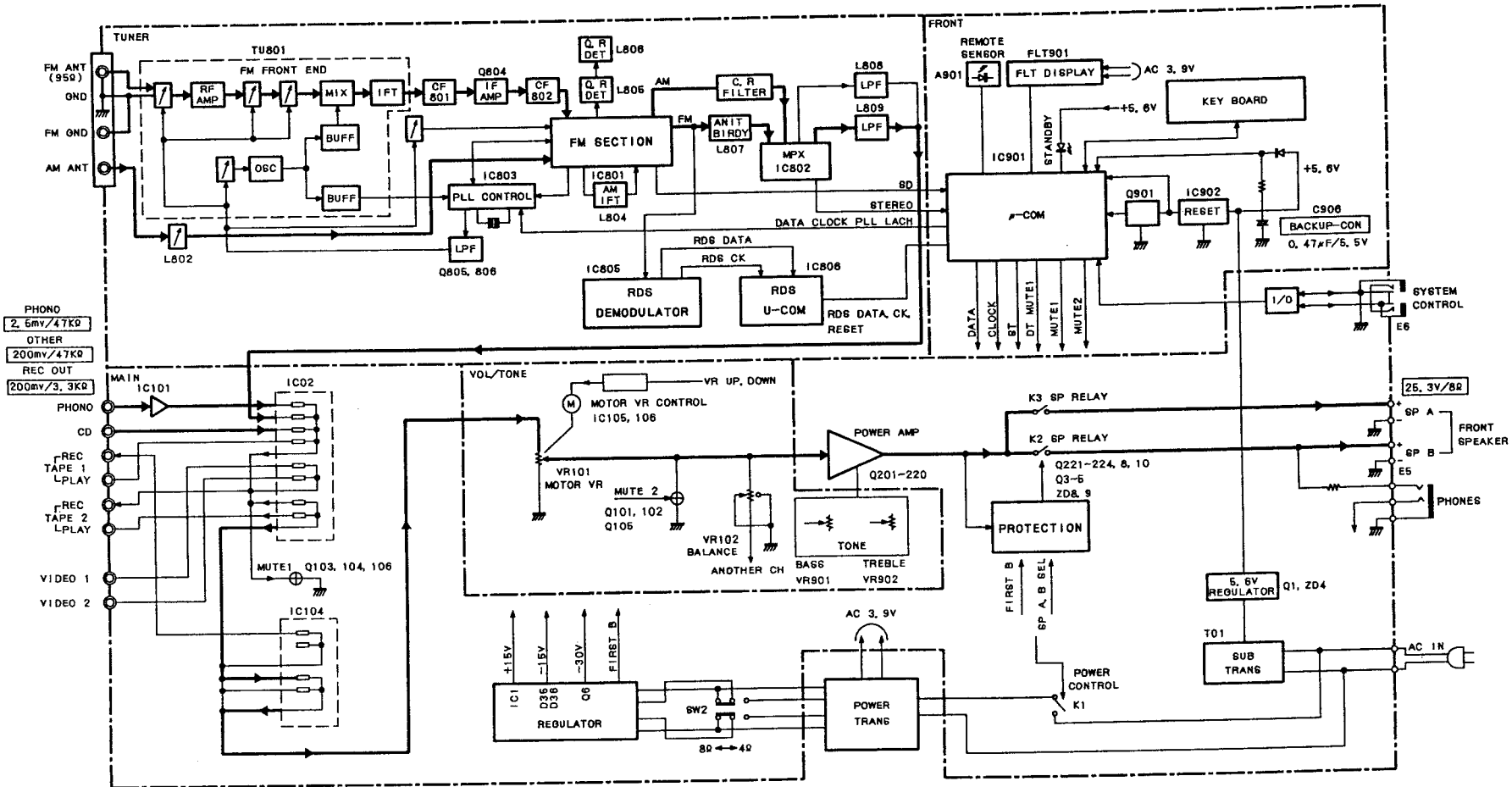

BLOCK DIAGRAM

KR-A4070/A5070 [E, T, G]

KR-A4070/A5070 [E, T, G]

CIRCUIT DESCRIPTION

1. Function description

Features

1-1. AMP

- Seven position selector :
CD, TUNER, PHONO, TAPE1, TAPE2, VIDEO1, VIDEO2
- Six audio output terminals :
CD, PHONO, TAPE1, TAPE2, VIDEO1, VIDEO2
- Tree output terminals :
TAPE1, TAPE2
- LINE STRAIGHT

- Speaker A/B change-over
- TAPE2 monitor

1-2. TUNER

- 20ch random preset
- Tuning control by IF count
- Direct selection
- RDS function (E, T type only)

2. Conditions according to the destination and model

2-1. AMP

MODEL	DIODE SW		Surround function
	5	4	
KR-V7050	0	0	PRO-LOGIC, 3-STEREO, DSP, DSP-LOGIC
KR-V6050 (Except E, T only)	0	1	PRO-LOGIC, 3-STEREO
KR-A4060/A5060 (E, T only)	1	X	No surround
KR-A4070/A5070 (E, T only)	1	X	No surround

X : Don't care

2-2. TUNER

Destination	DIODE SW				Band	Receiving Remarks	Channel space	IF	RF	Note
	3	2	1	0						
K1	0	0	0	0	FM	87.5MHz~108.0MHz	100kHz	+10.7MHz	50kHz	
					AM	530kHz~1610kHz	10kHz	+450kHz	10kHz	
K2	0	0	1	0	FM	87.5MHz~108.0MHz	100kHz	+10.7MHz	50kHz	
					AM	530kHz~1700kHz	10kHz	+450kHz	10kHz	
E	0	1	0	0	FM	87.5MHz~108.0MHz	50kHz	+10.7MHz	50kHz	
					AM	531kHz~1602kHz	9kHz	+450kHz	9kHz	
E	1	1	0	0	FM	87.5MHz~108.0MHz	50kHz	+10.7MHz	50kHz	With RDS
					AM	531kHz~1602kHz	9kHz	+450kHz	9kHz	

2-3. Diode matrix : Diode switch No.

	Pin No.	55	56	57	58	59	60
Pin No.	Pin name	KR5	KR4	KR3	KR2	KR1	KR0
61	KS7	Channel space	AM 1610/1700	RDS Yes/No	DSP.DOL/DOL only	Surround Yes/No	(X)
Diode switch No.		2	1	3	4	5	0
Diode Ref. No.		D911	-	D910	-	D909	-

- Diode SW 0→
- Diode SW 1→ AM band range/Except E, T type only
0 : AM NARROW
1 : AM WIDE
- Diode SW 2→ Channel base
(Products bound for M : Change-over with switch)
0 : FM 100kHz/step, AM 10kHz/step
1 : FM 50kHz/step, AM 9kHz/step
- Diode SW 3→With/Without RDS/E, T type only
0 : Without RDS
1 : With RDS
- Diode SW 4→Surround mode
0 : Dolby function & DSP function
1 : Dolby function only
- Diode SW 5→With/Without surround
0 : With surround
1 : Without surround

CIRCUIT DESCRIPTION

3. Initial state

- ① POWER OFF
- ② AMP system
 - Audio selector TUNER
 - Video system selector VIDEO 1
 - Speaker A ON
 - Speaker B OFF
 - TAPE 2 monitor OFF
 - LINE STARIGHT OFF
- ③ TUNER system
 - Band FM
 - Frequency Lower limit of FM (87.5MHz)
 - TUNING mode AUTO TUNING (AUTO STEREO)
 - P.CH indication --ch
- ④ Test frequency

	K1 type	K2 type	E type
01ch	FM 98.00MHz	FM 98.00MHz	FM 98.00MHz
02ch	FM108.00MHz	FM108.00MHz	FM108.00MHz
03ch	AM 630 kHz	AM 630 kHz	AM 630 kHz
04ch	AM 990 kHz	AM 990 kHz	AM 990 kHz
05ch	AM 1440 kHz	AM 1440 kHz	AM 1440 kHz
06ch	AM 1610 kHz	AM 1700 kHz	AM 1602 kHz
07ch	FM 87.50MHz	FM 87.50MHz	FM 87.50MHz
08ch	FM 98.50MHz	FM 98.50MHz	FM 98.50MHz
09ch	AM 530 kHz	AM 530 kHz	AM 531 kHz
10ch	FM 89.10MHz	FM 89.10MHz	FM 89.10MHz
11ch	FM 87.50MHz	FM 87.50MHz	FM 87.50MHz
12ch	FM 87.50MHz	FM 87.50MHz	FM 87.50MHz
13ch	FM 87.50MHz	FM 87.50MHz	FM 87.50MHz
14ch	FM 87.50MHz	FM 87.50MHz	FM 87.50MHz
15ch	FM 87.50MHz	FM 87.50MHz	FM 87.50MHz
16ch	FM 87.50MHz	FM 87.50MHz	FM 87.50MHz
17ch	FM 87.50MHz	FM 87.50MHz	FM 87.50MHz
18ch	FM 87.50MHz	FM 87.50MHz	FM 87.50MHz
19ch	FM 87.50MHz	FM 87.50MHz	FM 87.50MHz
20ch	FM 87.50MHz	FM 87.50MHz	FM 87.50MHz

Initial setting Insert the AC power cord plug in the electrical outlet while pushing the "POWER" key.

KR-A4070/A5070 [E, T, G]

CIRCUIT DESCRIPTION

4. Main Unit Test Mode

Setting method

Turn the AC power ON while pushing the "TUNING DOWN" key.

Cancellation method

Turn the AC power OFF.

Contents

① Start of the main unit test mode

The operation gets in the test mode through a main unit key, when the AC power is turned ON while pushing the "TUNING DOWN" key.

Three operations are carried out in this case.

- Automatic power ON
- All fluorescent character display tubes and LED light up.
- Initialization of all states except POWER ON/OFF.
The "All indications lit up" states is cancelled by pushing any key of the main unit.
The states changed during the test mode are initialized when the main unit test mode is cancelled (AC power OFF).

② Automatic motor VR UP/DOWN (AMP)

The operation (16 sec. UP→16 sec. DOWN→STOP) of the motor is carried out when the "TAPE 2" key is operated. Therefore, "TAPE 2 (MONITOR)" can not be changed-over during the main unit test mode.

③ Mute signal output (AMP)

No control of selector MUTE (MUTE1) is carried out.

④ Test mode operation of 0~9, +10 (TUNER)

- a) When the +10 key is not operated, the channels 1~9 (keys 1~9), as well as the channel 10 (key 0), can be called.
- b) When the +10 key is operated once, the channels 11~19 (keys 1~9), as well as the channel 20 (key 0), can be called.
- c) When the +10 key is operated once again, the operation returns to the case "a) When the +10 key is not operated".

⑤ Processing of keys available only in the remote controller

- Processing related to the AMP : None
- Processing related to the TUNER : None

⑥ Cancellation of the main unit test mode

The test mode is cancelled, and the operation returns to the initial state when the AC power is turned OFF during the test mode.

CIRCUIT DESCRIPTION

5. μ -com : μ PD78044GF-021 (Front PCB : IC901)

5-1. μ -com periphery block diagram

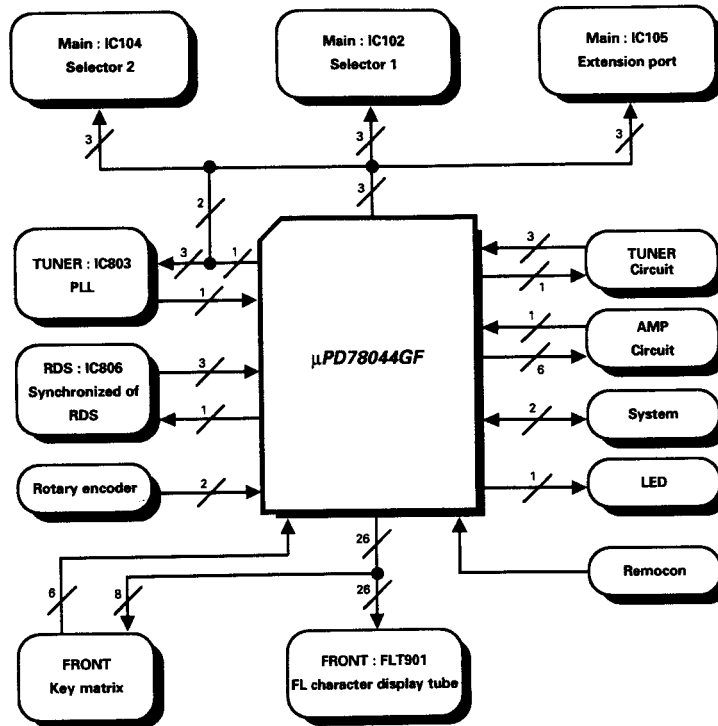

5-2. Pin connection

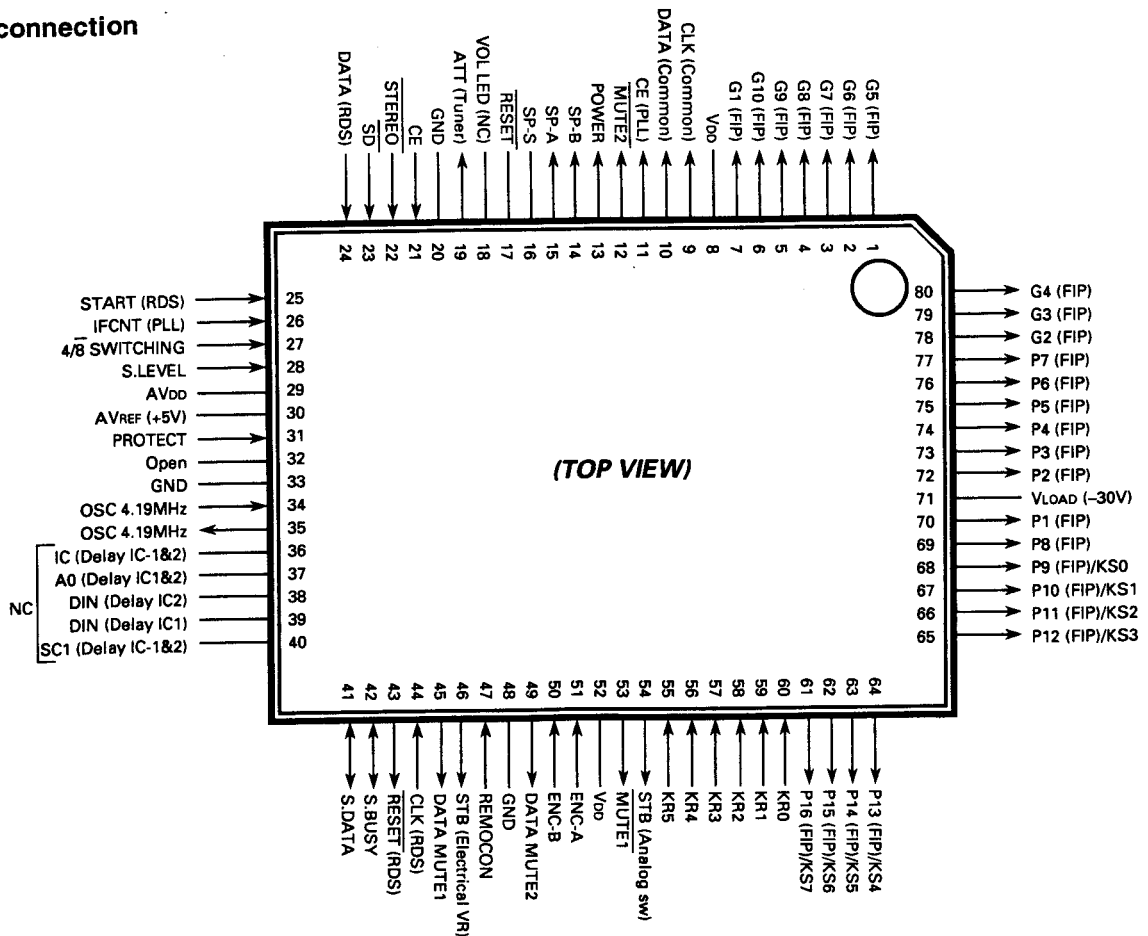

KR-A4070/A5070 [E, T, G]

CIRCUIT DESCRIPTION

5-3. Pin function

No.	Name	I/O	Function
1~6, 7	G5~G10, G1	O	FL grid 5~10, and 1.
8	V _{DD}	-	Power supply.
9	CLK (Common)	O	Clock for control IC. (Analog sw/PLL IC/Electronic VOL)
10	DATA (Common)	O	Data for control IC. (Analog sw/PLL IC/Electronic VOL)
11	CE (PLL)	O	PLL CE.
12	MUTE ₂	O	Amplifier mute control. ("H" : Mute OFF, "L" : Mute ON)
13	POWER	O	Power relay control. ("H" : Power ON, "L" : Power OFF)
14	SP-B	O	Speaker B relay control. ("H" : SP-B ON, "L" : SP-B OFF)
15	SP-A	O	Speaker A relay control. ("H" : SP-A ON, "L" : SP-A OFF)
16	SP-S	-	Not used (open).
17	RESET	I	μ-com reset.
18	VOL LED	-	Not used (open).
19	ATT (Tuner)	O	Attenuator control ("H" : ATT ON, "L" : ATT OFF)
20	GND	-	A/D power supply.
21	CE	I	μ-com CE.
22	STEREO	I	Stereo signal detection. ("H" : Monaural, "L" : Stereo)
23	SD	I	Tuning signal detection. ("H" : Not tuned, "L" : Tuned)
24	DATA (RDS)	I	RDS data.
25	START (RDS)	I	RDS start bit.
26	IFCNT (PLL)	I	IF CNT data (PLL DO).
27	4/8 SWITCHING	I	Speaker impedance switching. ("H" : 4Ω, "L" : 8Ω)
28	S.LEVEL	I	Signal level (A/D).
29	AV _{DD}	-	A/D power supply.
30	AVREF	-	A/D reference voltage (+5V).
31	PROTECT	I	Protection detection. ("H" : Protection, "L" : Normal)
32	NC	-	Open.
33	V _{SS}	-	GND
34	X1	I	4.19MHz oscillator.
35	X2	O	4.19MHz oscillator.
36	I C (DELAY IC-1 & 2)	-	Not used.
37	A0 (DELAY IC-1 & 2)	-	Not used.
38	DIN (DELAY IC-1)	-	Not used.
39	DIN (DELAY IC-2)	-	Not used.
40	SC1 (DELAY IC-1 & 2)	-	Not used.
41	S.DATA	I/O	8-bit system data.
42	S. BUSY	I/O	8-bit system busy.
43	RESET (RDS)	O	RDS reset.
44	CLK (RDS)	I	RDS clock.
45	DT MUTE1	O	Data mute 1. ("H" : ON, "L" : OFF)
46	STB (Electrical VOL)	-	Not used.
47	REMOCON	I	Remote controller input.
48	GND	-	
49	DT MUTE2	-	Not used.
50, 51	ENC-B, ENC-A	I	Encoder input. (50 pin : Encoder B, 51 pin : Encoder A)
52	V _{DD}	-	Power supply.
53	MUTE ₁	O	Selector MUTE control. ("H" : MUTE OFF, "L" : MUTE ON)
54	STB (Analog sw)	O	Analog sw STB.
55~60	KR5~KR0	I	Key return 5~0. (Pin 56 : Not used)
61~68	P16/KS7~P9/KS0	O	FL segment 16~9 / Key scan 7~0.
69, 70	P8, P1	O	FL segment. (69 pin : Segment 8, 70 pin : Segment 1)
71	-30V (V _{LOAD})	-	FL drive power supply.
72~77	P2~P7	O	FL segment 2~7.
78~80	G2~G4	O	FL grid 2~4.

PC BOARD (Component side view) : KR-A4070/A5070

**TUNER UNIT
WP4140K2**

**PHONE UNIT
WP4139K2**

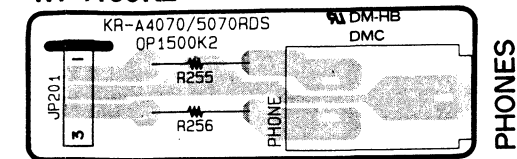

(a) Discriminator:

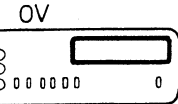

DC Voltmeter
**MOTER
VOLUME UNIT
WP4142K2**

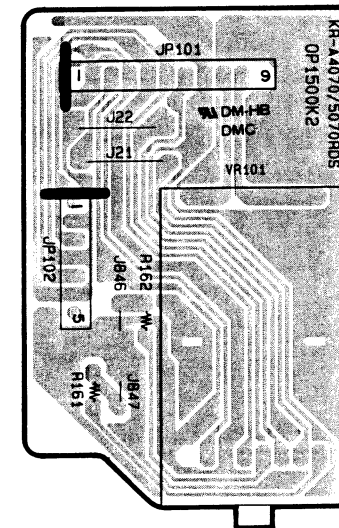

VOLUME CONTROL

**TONE BALANCE UNIT
WP4141K2**

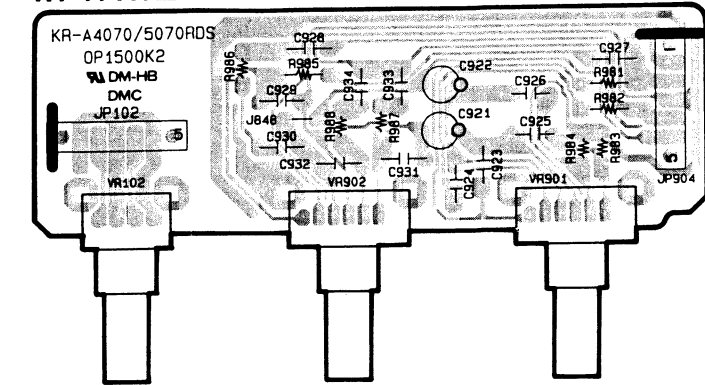

BALANCE TREBLE BASS
R L + - + -

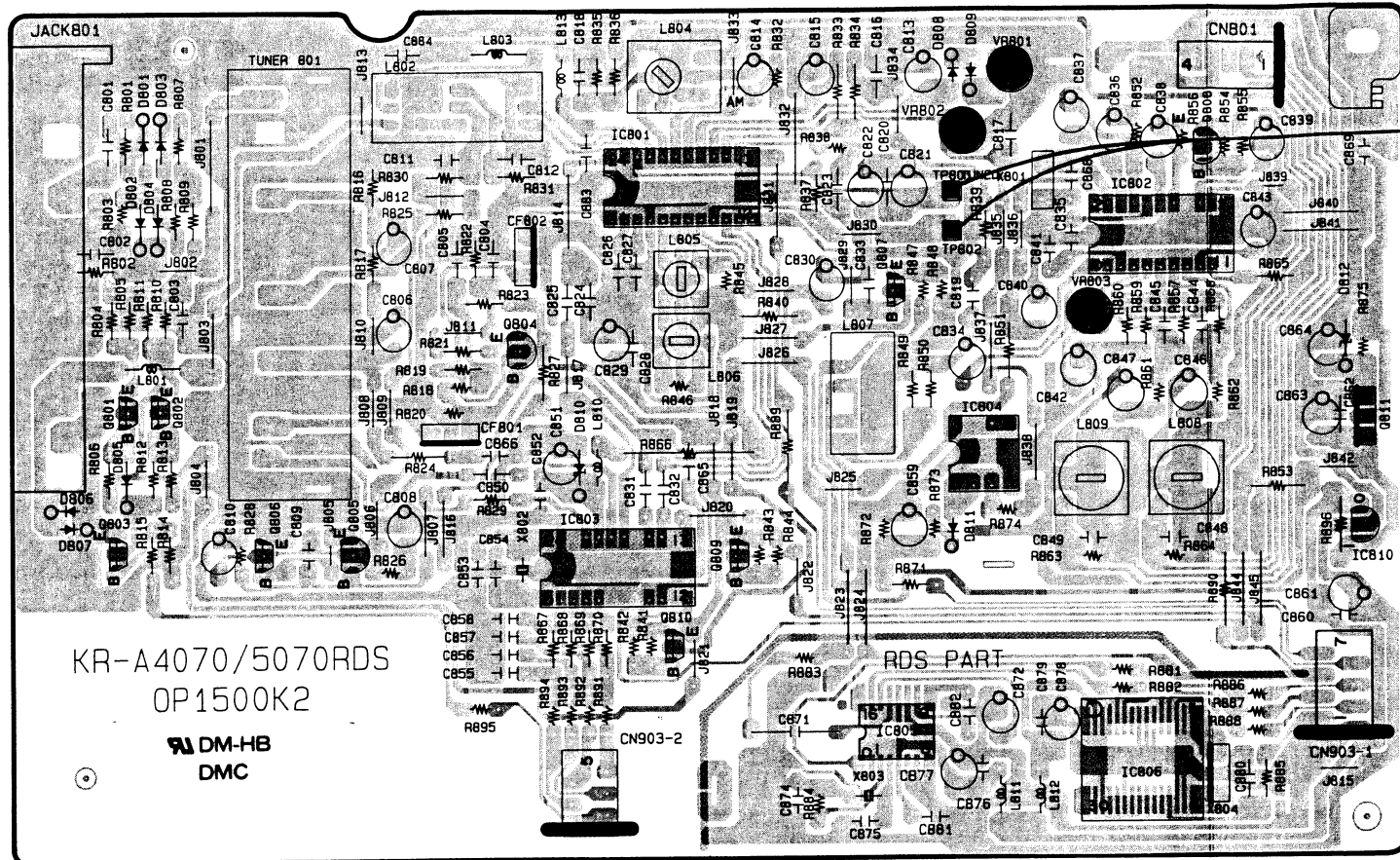

**FRONT UNIT
WP4138K2**

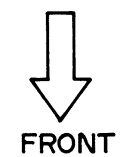
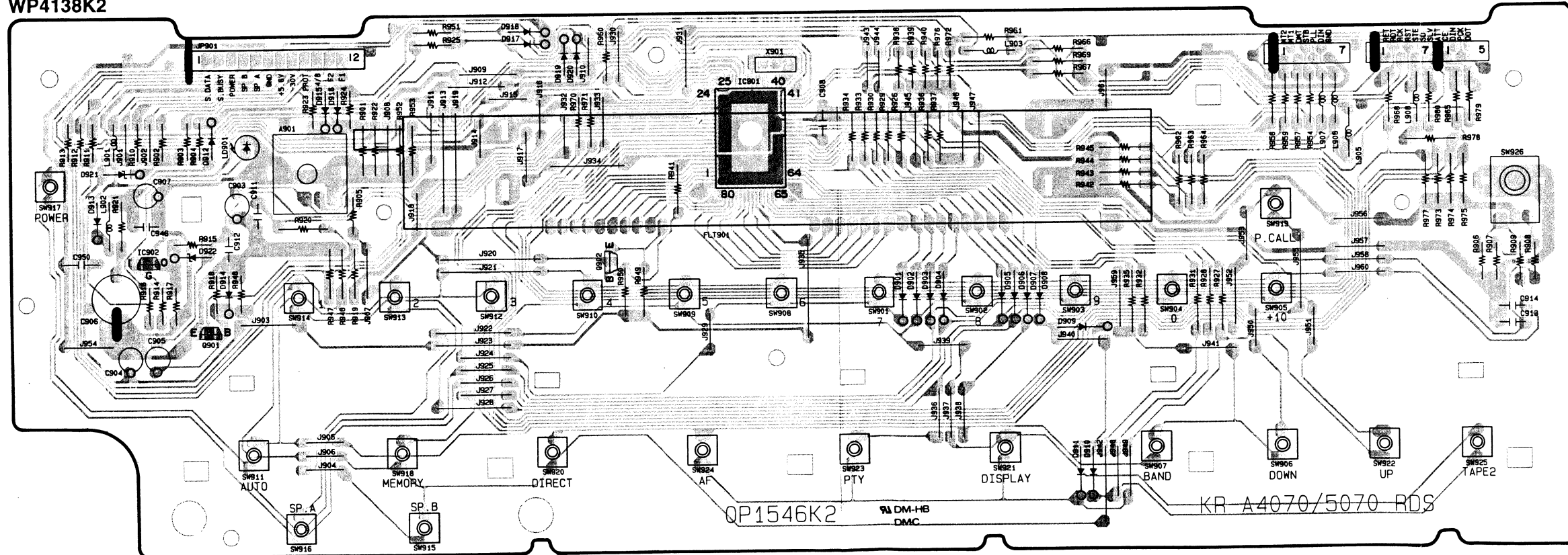

Refer to the schematic diagram for the values of resistors and capacitors.

PC BOARD (Component side view) : KR-A4070/A5070

IMPEDANCE SELECTOR

A or B : 8Ω OR MORE A or B : LESS THAN 8Ω
 A and B : ANY SPEAKERS

SYSTEM CONTROL

SPEAKERS (A or B : 4-16Ω, A and B : 8-16Ω) A B
 + L - - R +

VIDEO 2 VIDEO 1 TAPE 2
 L PLAY PLAY (MONITOR)
 R IN IN PLAY REC

TAPE 1
 PLAY REC

CD
 L R INPUT

PHONO
 L R INPUT

MAIN UNIT
 WP4143K3 (KR-A4070 E, G)
 WP4143K4 (KR-A4070 T)
 WP4137K4 (KR-A5070 E, G)

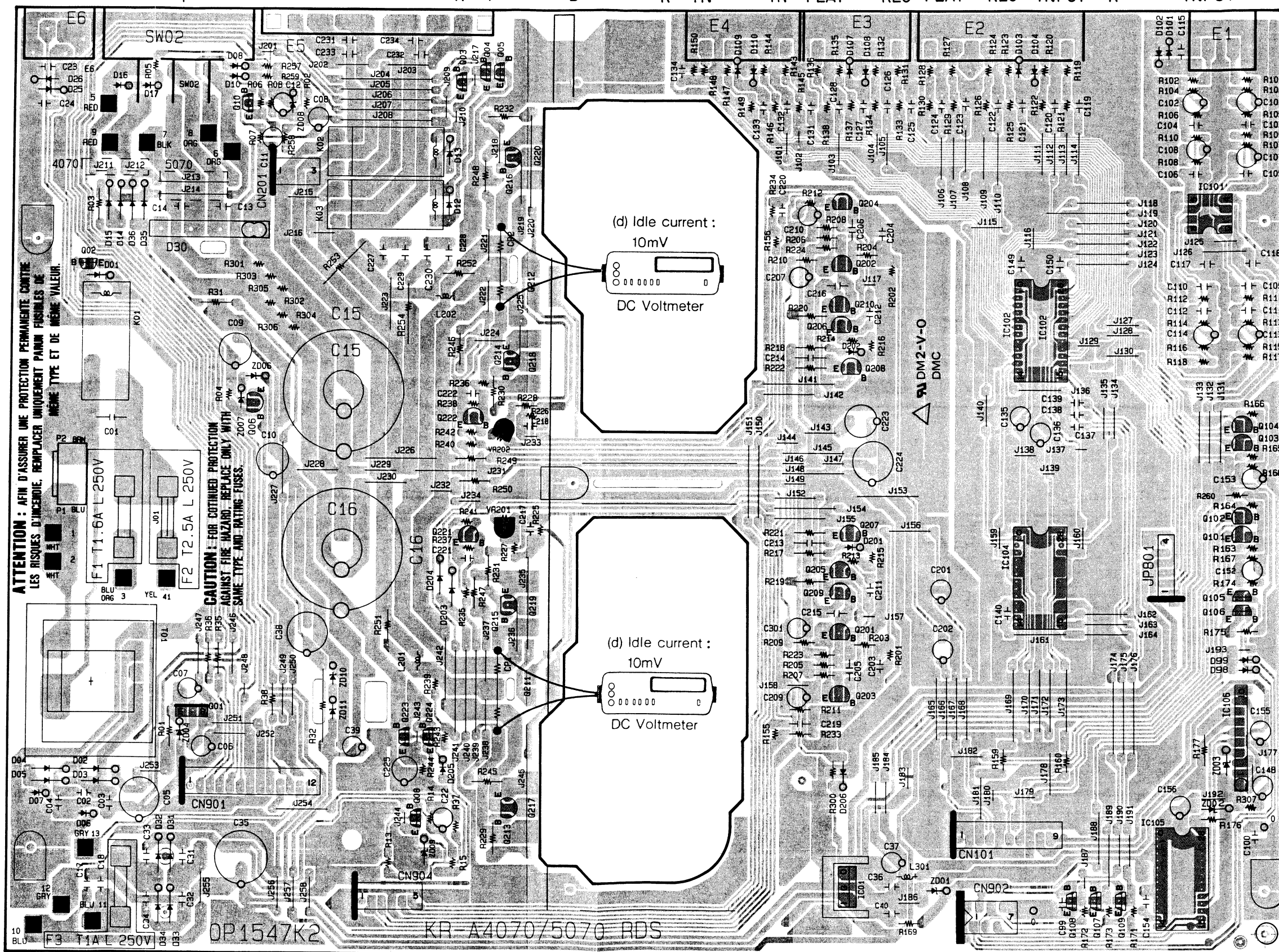
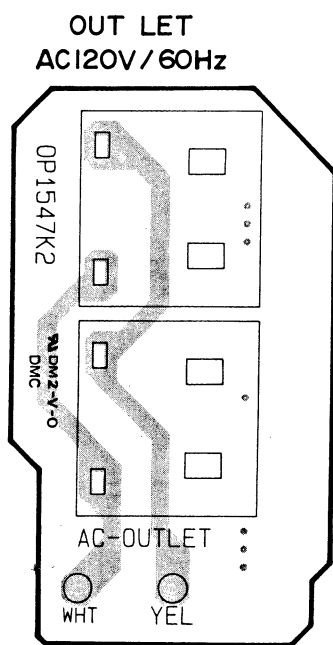

ATTENTION : AFIN D'ASSURER UNE PROTECTION PERMANENTE CONTRE LES RISQUES D'INCENDIE, REMPLACER UNIQUEMENT PAR DES FUSIBLES DE MEME TYPE ET DE MEME VALEUR.

CAUTION : FOR CONTINUED PROTECTION AGAINST FIRE HAZARD, REPLACE ONLY WITH SAME TYPE AND RATING FUSES.

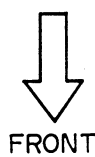

FRONT

TUNER UNIT WP4140K2

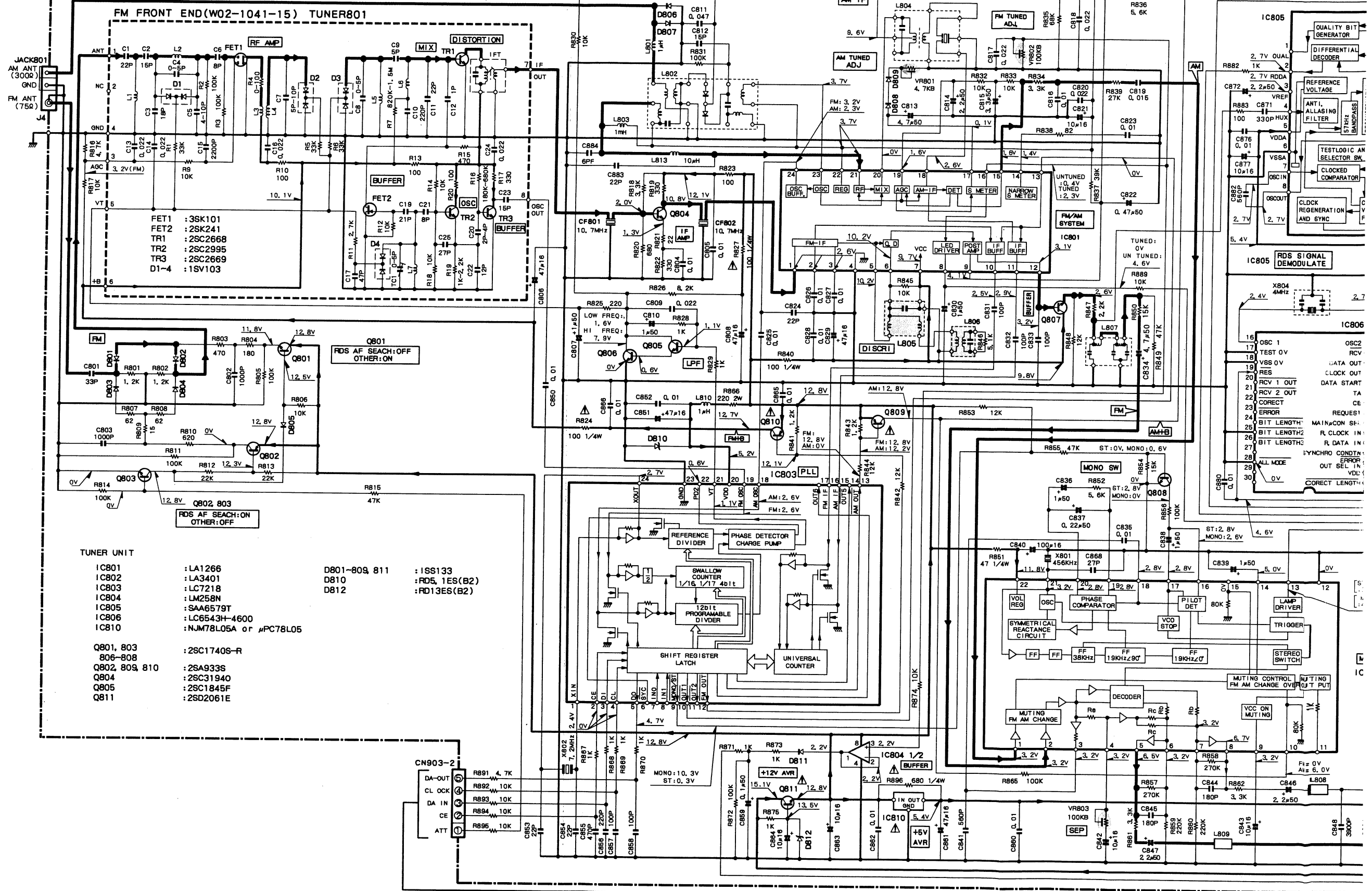

- TUNER UNIT**
- IC801 : LA1266
 - IC802 : LA3401
 - IC803 : LC7218
 - IC804 : LM258N
 - IC805 : SAA6579T
 - IC806 : LC6543H-4600
 - IC810 : NJM78L05A or μ PC78L05
- Q801, 803** : 2SC1740S-R
- Q802, 809, 810** : 2SA933S
- Q804** : 2SC3194D
- Q805** : 2SC1845F
- Q811** : 2SD2061E
- D801-809, 811** : 1SS133
- D810** : RDS, 1ES(B2)
- D812** : RD13ES(B2)

DC voltages are as measured with high imped
Values may vary slightly due to variations between
ments or/and units.

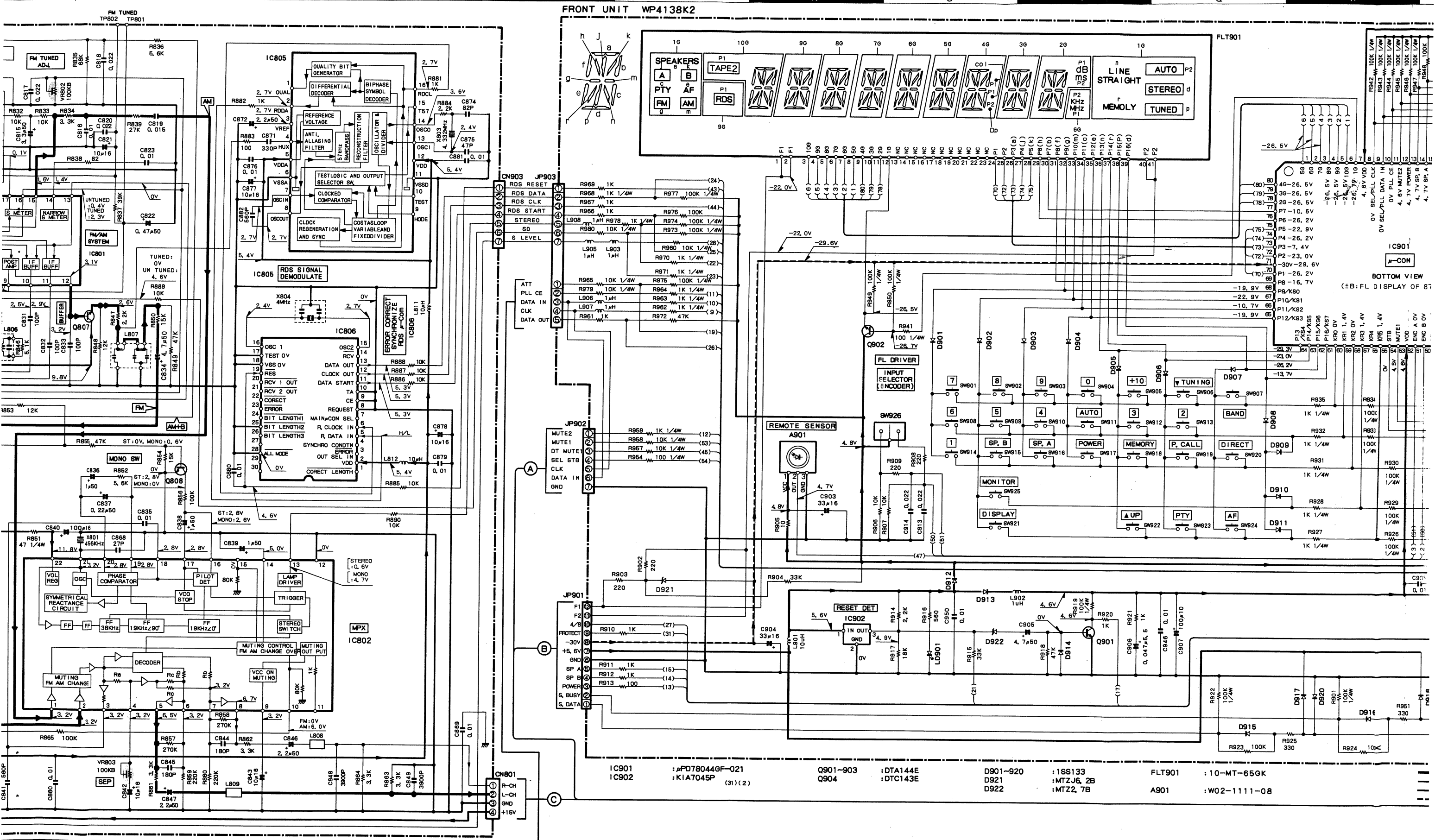

DC voltages are as measured with a high impedance voltmeter. Values may vary slightly due to variations between individual instruments or/and units.

Les tensions c.c. doivent être mesurées avec un voltmètre à haute impédance. Les valeurs peuvent différer légèrement du fait des variations inhérentes aux appareils et aux instruments de mesure individuels.

Die angegebenen Gleichspannungswerte wurden mit einem hochohmigen Spannungsmesser gemessen. Dabei schwanken die Meßwerte aufgrund von Unterschieden zwischen einzelnen Instrumenten oder Geräten u. U. geringfügig.

CAUTION: For continued safety, replace safety critical components only with manufacturer's recommended parts (refer to parts list). Δ indicates safety critical components. To reduce the risk of electric shock, leakage-current or resistance measurements shall be carried out (exposed parts are acceptably insulated from the supply circuit) before the appliance is returned to the customer.

IC901	: #PD78044GF-021	Q901-903	: DTA144E	D901-920	: 1SS133	FLT901	: 10-MT-65GK
IC902	: K1A7045P (31) (2)	Q904	: DTC143E	D921	: MTZJ6, 2B	A901	: W02-1111-08
				D922	: MTZ2, 7B		

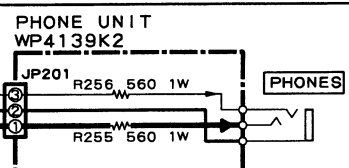
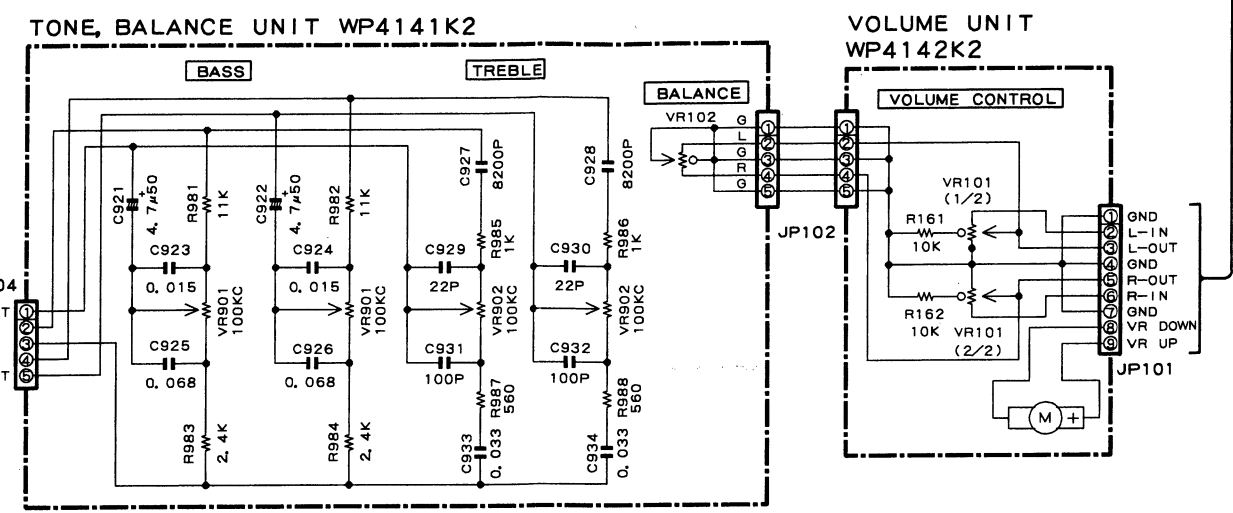
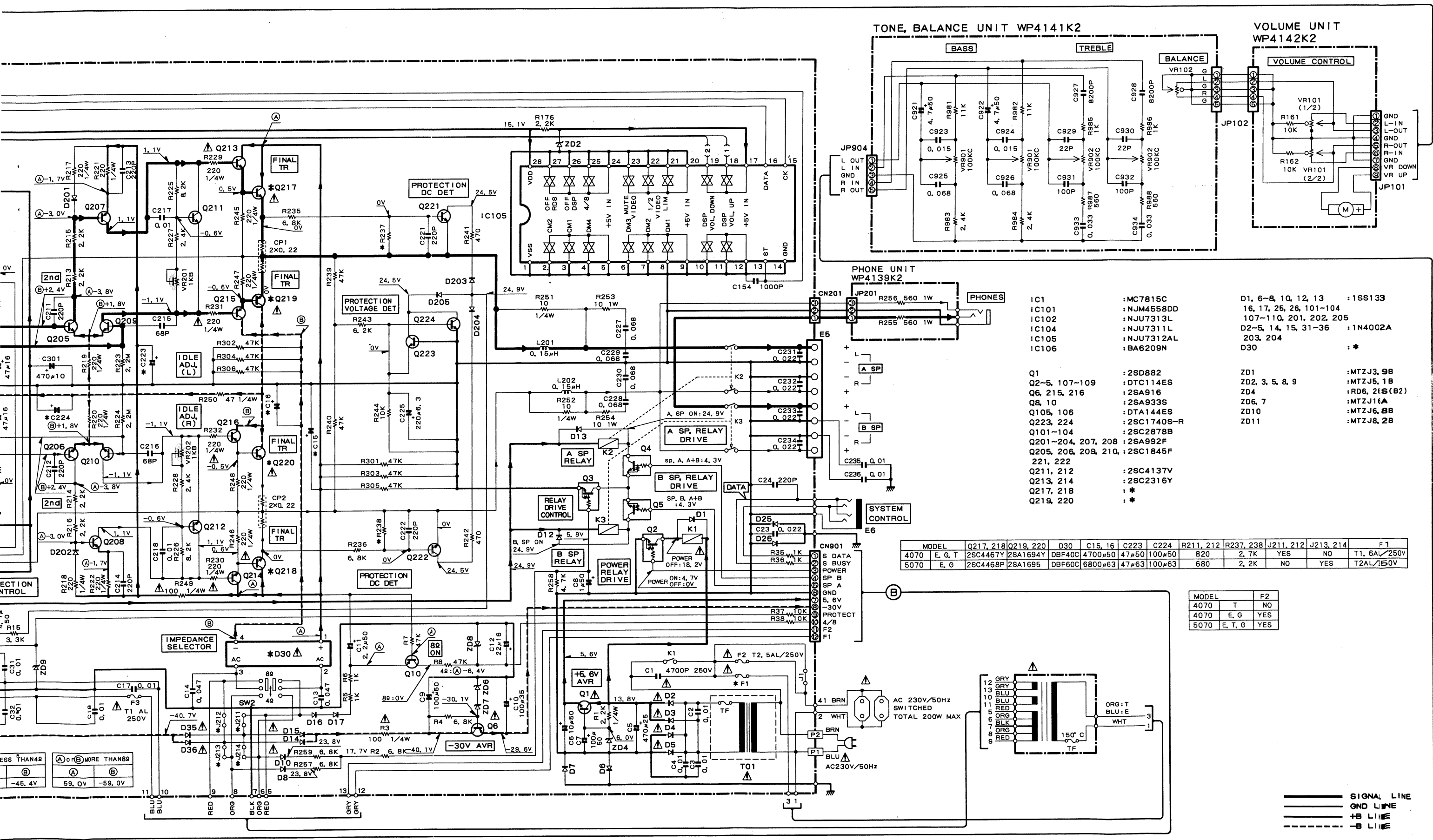

- | | | | |
|-------------------------------|-------------|-------------------------|---------------|
| IC1 | :MC7815C | D1, 6-8, 10, 12, 13 | :1S8133 |
| IC101 | :NJM4558DD | 16, 17, 25, 26, 101-104 | |
| IC102 | :NJU7313L | 107-110, 201, 202, 205 | |
| IC104 | :NJU7311L | D2-5, 14, 15, 31-36 | :1N4002A |
| IC105 | :NJU7312AL | 203, 204 | |
| IC106 | :BA6209N | D30 | :* |
| Q1 | :2SD882 | ZD1 | :MTZJ3, 9B |
| Q2-5, 107-109 | :DTC114ES | ZD2, 3, 5, 8, 9 | :MTZJ5, 1B |
| Q6, 215, 216 | :2SA916 | ZD4 | :RD6, 2ES(B2) |
| Q8, 10 | :2SA933S | ZD6, 7 | :MTZJ16A |
| Q105, 106 | :DTA144ES | ZD10 | :MTZJ6, 8B |
| Q223, 224 | :2SC1740S-R | ZD11 | :MTZJ8, 2B |
| Q101-104 | :2SC2878B | | |
| Q201-204, 207, 208 | :2SA992F | | |
| Q205, 206, 209, 210, 221, 222 | :2SC1845F | | |
| Q211, 212 | :2SC4137V | | |
| Q213, 214 | :2SC2316Y | | |
| Q217, 218 | :* | | |
| Q219, 220 | :* | | |

MODEL	Q217, 218	Q219, 220	D30	C15, 16	C223	C224	R211, 212	R237, 238	J211, 212	J213, 214	F1	
4070	E, G, T	2SC4467Y	2SA1694Y	DBF40C	4700µ50	100µ50	820	2, 7K	YES	NO	T1, 6AL/250V	
5070	E, G	2SC4468P	2SA1695	DBF60C	6800µ63	47µ63	100µ63	680	2, 2K	NO	YES	T2AL/150V

MODEL	F2
4070	T NO
4070	E, G YES
5070	E, T, G YES

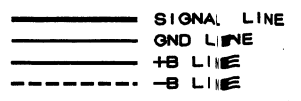

WP4143K3(KR-A4070 E, G)
WP4143K4(KR-A4070 T)
WP4137K4(KR-A5070 E, G)

MAIN UNIT

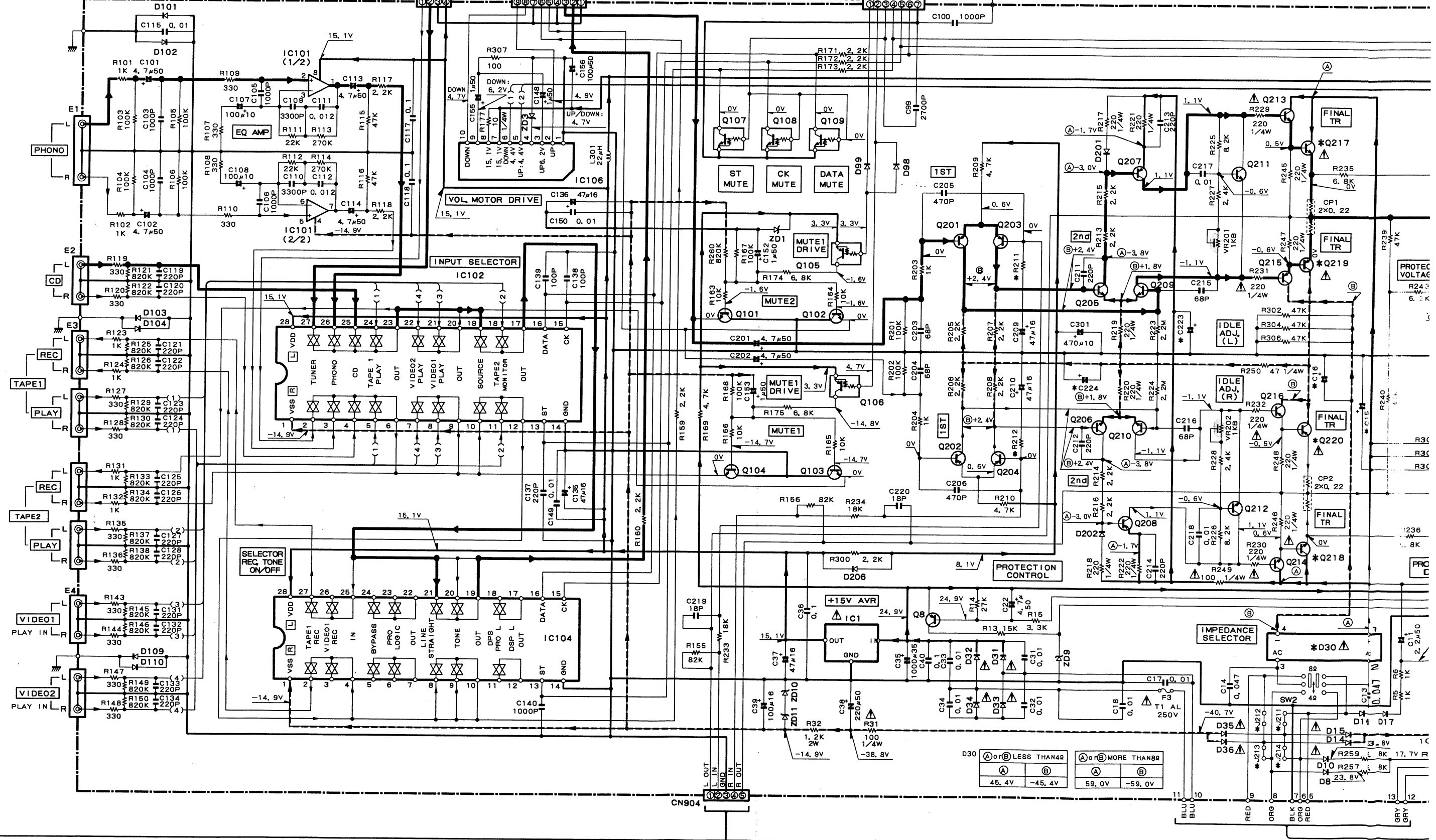

TO FRONT UNIT JP902

TO TUNER UNIT CN801

TO FRONT UNIT JP901

D30 (A) or (B) LESS THAN 4Ω
45.4V -45.4V

(A) or (B) MORE THAN 8Ω
59.0V -59.0V

D15, D14, D16, D17
D10, R257, L 8K
D8 23.8V

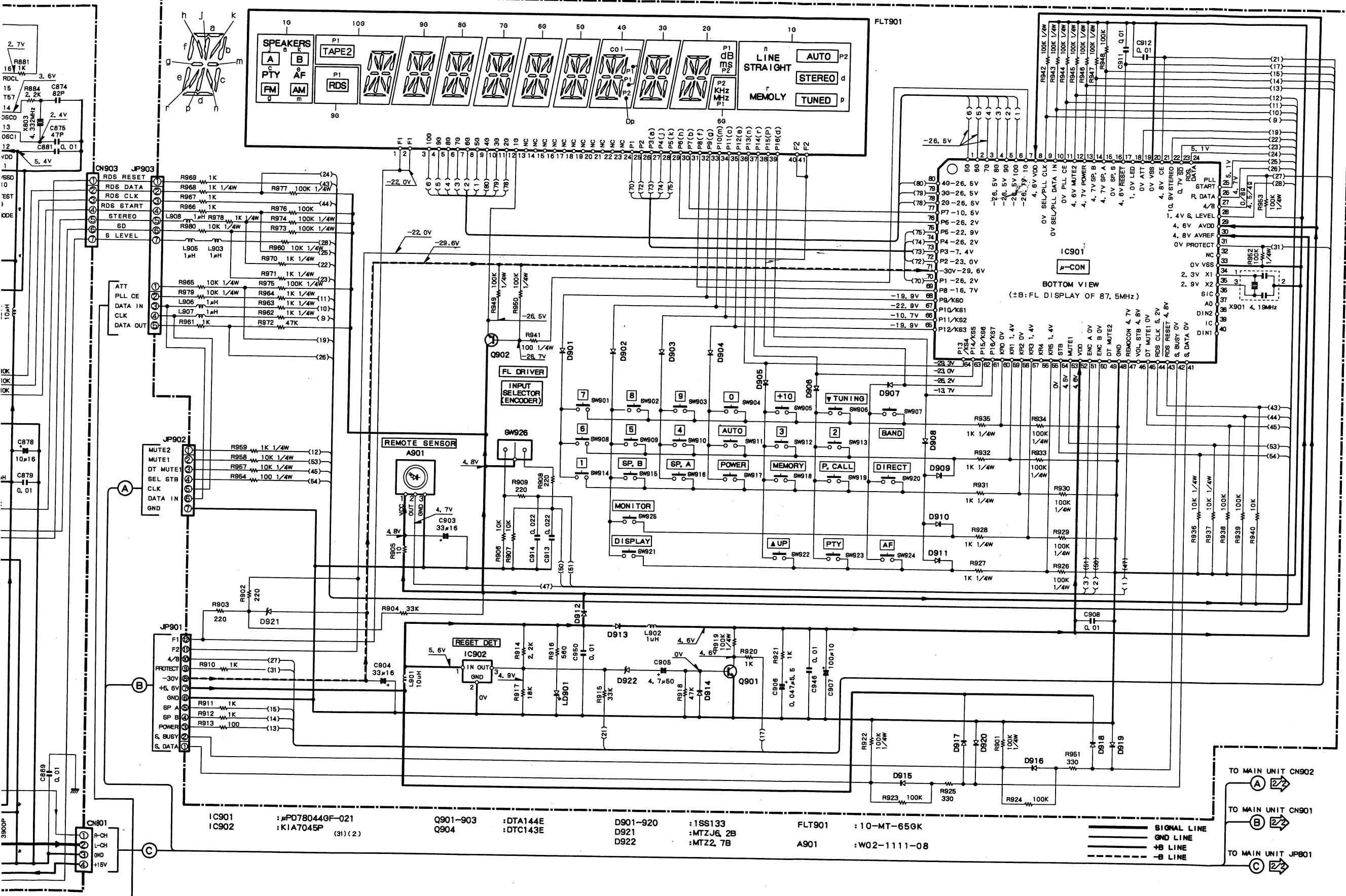

Les tensions c.c doivent être mesurées avec un voltmètre à haute impédance. Les valeurs peuvent différer légèrement du fait des variations inhérentes aux appareils et aux instruments de mesure individuels.

Die angegebenen Gleichspannungswerte wurden mit einem hochohmigen Spannungsmesser gemessen. Dabei schwanken die Meßwerte aufgrund von Unterschieden zwischen einzelnen Instrumenten oder Geräten u. U. geringfügig.

CAUTION: For continued safety, replace safety critical components only with manufacturer's recommended parts (refer to parts list). **⚠** indicates safety critical components. To reduce the risk of electric shock, leakage-current or resistance measurements shall be carried out (exposed parts are acceptably insulated from the supply circuit) before the appliance is returned to the customer.

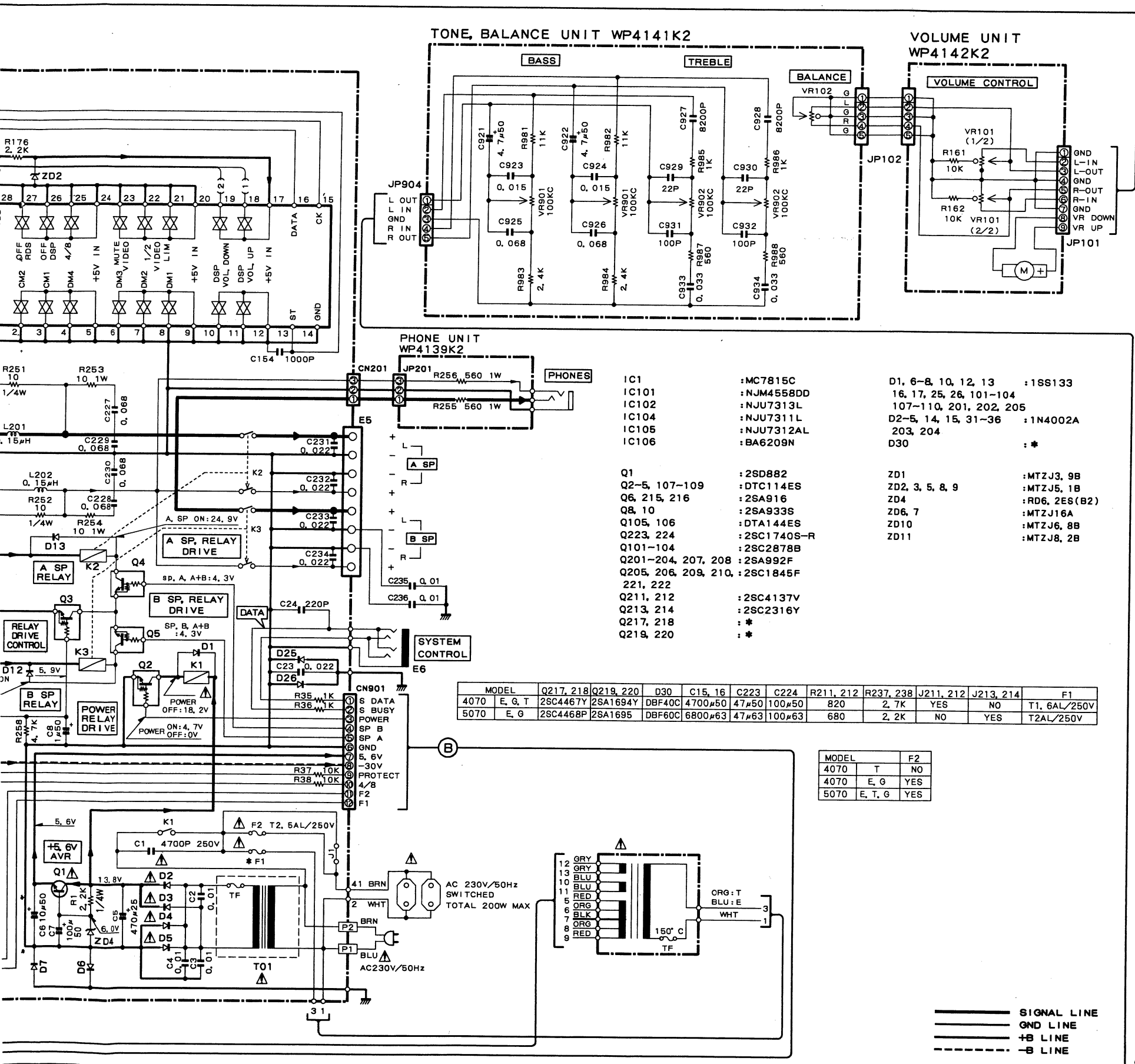

- | | | | |
|-------------------------------|--------------|-------------------------|----------------|
| IC1 | : MC7815C | D1, 6-8, 10, 12, 13 | : 1S8133 |
| IC101 | : NJM4558DD | 16, 17, 25, 26, 101-104 | |
| IC102 | : NJU7313L | 107-110, 201, 202, 205 | |
| IC104 | : NJU7311L | D2-5, 14, 15, 31-36 | : 1N4002A |
| IC105 | : NJU7312AL | 203, 204 | |
| IC106 | : BA6209N | D30 | : * |
| Q1 | : 2SD882 | ZD1 | : MTZJ3, 9B |
| Q2-5, 107-109 | : DTC114ES | ZD2, 3, 5, 8, 9 | : MTZJ5, 1B |
| Q6, 215, 216 | : 2SA916 | ZD4 | : RD6, 2ES(B2) |
| Q8, 10 | : 2SA933S | ZD6, 7 | : MTZJ16A |
| Q105, 106 | : DTA144ES | ZD10 | : MTZJ6, 8B |
| Q223, 224 | : 2SC1740S-R | ZD11 | : MTZJ8, 2B |
| Q101-104 | : 2SC2878B | | |
| Q201-204, 207, 208 | : 2SA992F | | |
| Q205, 206, 209, 210, 2SC1845F | | | |
| 221, 222 | | | |
| Q211, 212 | : 2SC4137V | | |
| Q213, 214 | : 2SC2316Y | | |
| Q217, 218 | : * | | |
| Q219, 220 | : * | | |

MODEL	Q217, 218	Q219, 220	D30	C15, 16	C223	C224	R211, 212	R237, 238	J211, 212	J213, 214	F1	
4070	E, G, T	2SC4467Y	2SA1694Y	DBF40C	4700µ50	47µ50	100µ50	820	2, 7K	YES	NO	T1, 6AL/250V
5070	E, G	2SC4468P	2SA1695	DBF60C	6800µ63	47µ63	100µ63	680	2, 2K	NO	YES	T2AL/250V

MODEL	F2
4070	T
4070	E, G
5070	E, T, G

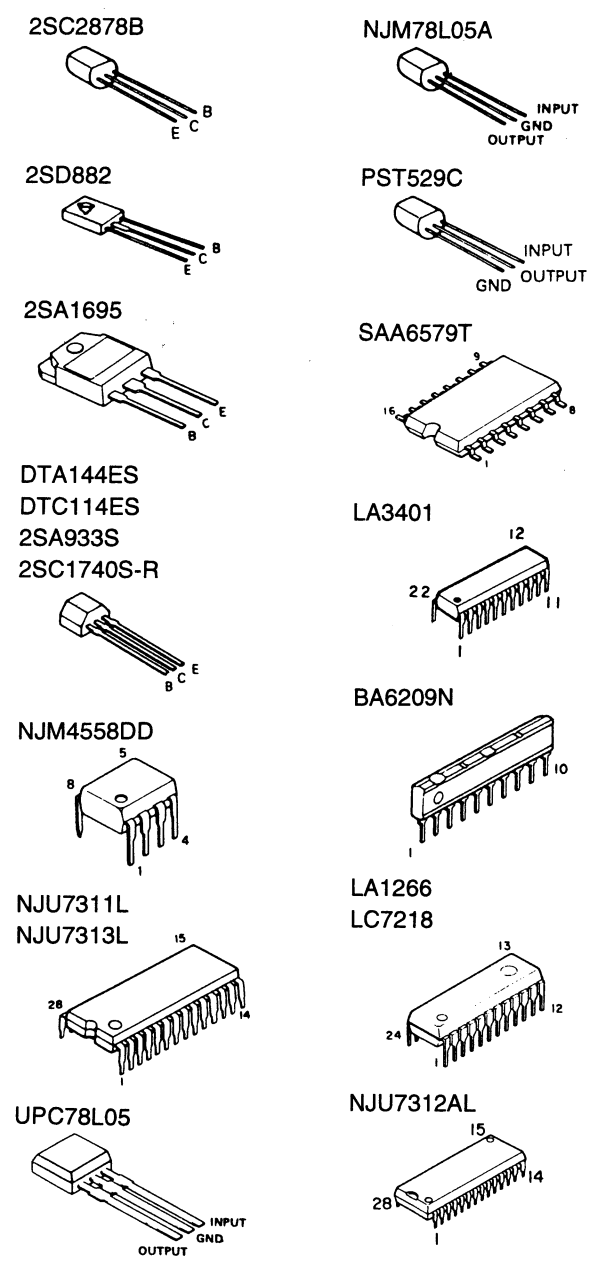

DC voltages are as measured with a high impedance voltmeter. Values may vary slightly due to variations between individual instruments or/and units.

Les tensions c.c. doivent être mesurées avec un voltmètre à haute impédance. Les valeurs peuvent différer légèrement du fait des variations inhérentes aux appareils et aux instruments de mesure individuels.

Die angegebenen Gleichspannungswerte wurden mit einem hochohmigen Spannungsmesser gemessen. Dabei schwanken die Meßwerte aufgrund von Unterschieden zwischen einzelnen Instrumenten oder Geräten u. U. geringfügig.

CAUTION: For continued safety, replace safety critical components only with manufacturer's recommended parts (refer to parts list). Δ indicates safety critical components. To reduce the risk of electric shock, leakage-current or resistance measurements shall be carried out (exposed parts are acceptably insulated from the supply circuit) before the appliance is returned to the customer.

KR-A4070/A5070 [E, T, G]

KENWOOD

EXPLODED VIEW (UNIT)

KR-A4070/A5070 [E, T, G]

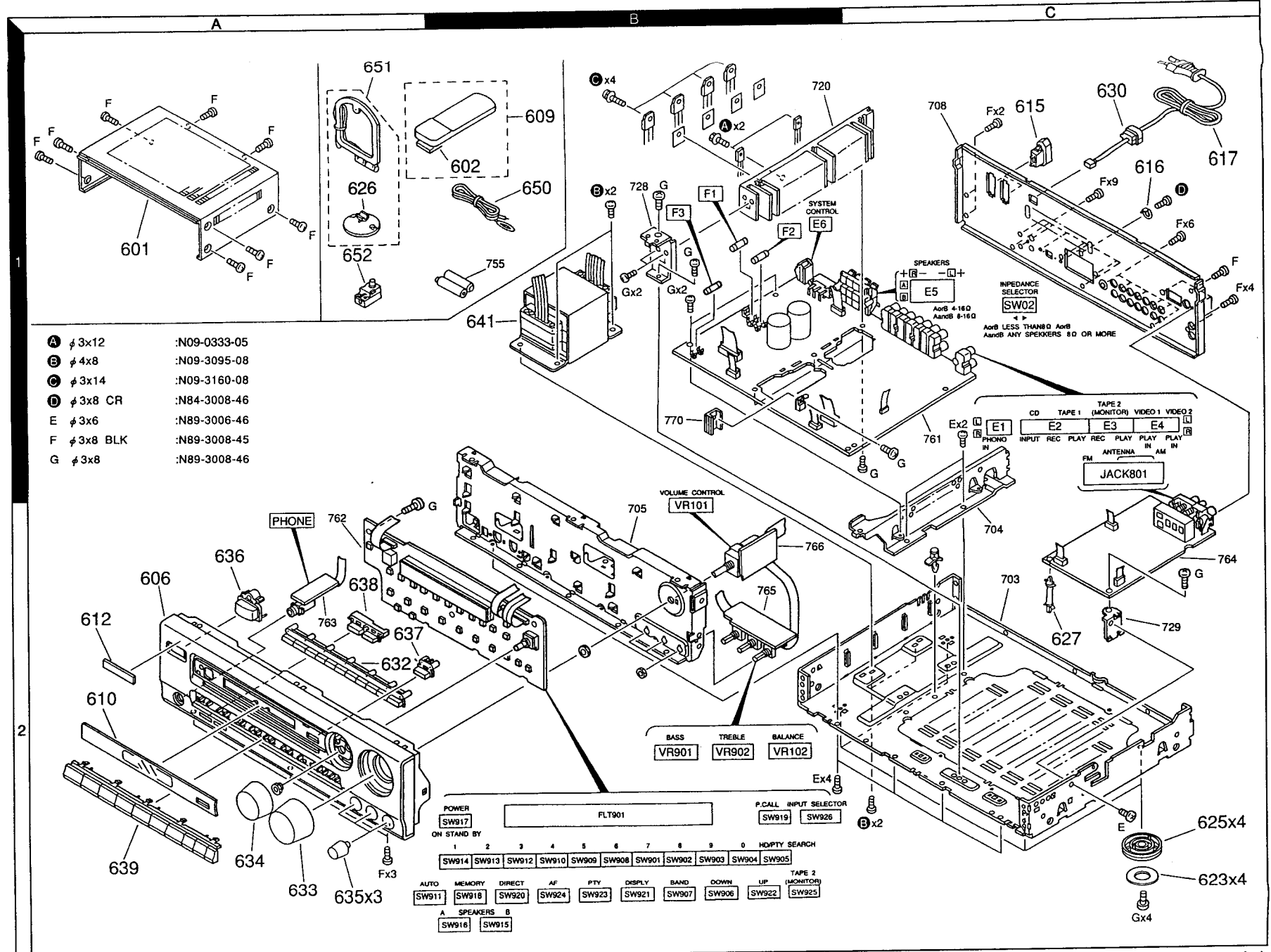

- A ϕ 3x12 :N09-0333-05
- B ϕ 4x8 :N09-3095-08
- C ϕ 3x14 :N09-3160-08
- D ϕ 3x8 CR :N84-3008-46
- E ϕ 3x6 :N89-3006-46
- F ϕ 3x8 BLK :N89-3008-45
- G ϕ 3x8 :N89-3008-46

POWER		FL901										P.CALL INPUT SELECTOR							
SW917												SW919 SW926							
ON STAND BY																			
1	2	3	4	5	6	7	8	9	0	MEMORY SEARCH									
SW914	SW913	SW912	SW910	SW909	SW908	SW901	SW902	SW903	SW904	SW905									
AUTO		MEMORY		DIRECT		AF		PTY		DISPLY		BAND		DOWN		UP		TAPE 2 (MONITOR)	
SW911		SW918		SW920		SW924		SW923		SW921		SW907		SW906		SW922		SW925	
A SPEAKERS		B																	
SW916		SW915																	

Parts with exploded numbers larger than 700 are not supplied.

× New Parts
Parts without Parts No. are not supplied.
Les articles non mentionnés dans le Parts No. ne sont pas fournis.
Teile ohne Parts No. werden nicht geliefert.

No.1

Ref. No. 参照番号	Address 位置	New Parts 新	Parts No. 部品番号	Description 部品名 / 規格	Desti- nation 仕 向	Re- marks 備考
KR-A4070						
601	1A		A01-3167-08	METALIC CABINET		
602	1B		A09-0170-08	BATTERY COVER		
606	2A	*	A60-0764-08	FRONT PANEL	T	
606	2A	*	A60-0765-08	FRONT PANEL	E	
609	1B		A70-0985-08	REMOTE CONTROL ASSY	G	
610	2A	*	B10-2137-08	FRONT GLASS		
612	2A		B43-0287-04	KENWOOD BADGE	E	
-			B46-0122-23	WARRANTY CARD	E	
-		*	B60-2114-08	INSTRUCTION MANUAL (ENGLISH)	T	
-		*	B60-2115-08	INSTRUCTION MANUAL (F/D/I/S)	E	
-		*	B60-2116-08	INSTRUCTION MANUAL (GERMANY)	E	
△ 615	1C		E03-0085-05	AC OUTLET	T	
△ 615	1C		E03-0324-08	AC OUTLET	E	
△ 616	1C		E21-0031-08	GND TERMINAL	E	
△ 617	1C	*	E30-2721-05	AC POWER CORD ASSY	T	
△ 617	1C	*	E30-2799-08	AC POWER CORD ASSY	E	
623	2C		G13-0513-08	CUSHION FOOT		
-		*	H10-7076-08	POLYSTYRENE FOAMED FIXTURE		
-			H25-0232-04	PROTECTION BAG (ACCESSORY)		
-			H25-0232-04	PROTECTION BAG (MANUAL)		
-			H25-1544-08	PROTECTION BAG (UNIT)		
-		*	H50-1508-08	ITEM CARTON CASE	T	
-		*	H50-1510-08	ITEM CARTON CASE	E	
625	2C		J02-1099-08	FOOT		
626	1A	*	J19-2815-04	LOOP ANTENNA HOLDER		
627	2C		J19-3631-08	PCB HOLDER		
630	1C		J42-0200-08	AC CORD BUSHING		
632	2A	*	K29-6180-08	KNOB PRESET(10KEY)		
633	2A	*	K29-6181-08	KNOB VOLUME CONTROL		
634	2A	*	K29-6182-08	KNOB INPUT SELECTOR		
635	2A	*	K29-6183-08	KNOB BASS, TREBLE, BALANCE		
636	2A	*	K29-6184-08	KNOB POWER		
637	2A	*	K29-6186-08	KNOB P.CALL		
638	2A	*	K29-6187-08	KNOB SPEAKERS		
639	2A	*	K29-6189-08	KNOB FUNCTION		
641	1B		L07-1801-08	POWER TRANSFORMER		
B			N09-3095-08	TAPTITE SCREW (M4X8)		
C			N09-3160-08	TAPTITE SCREW (M3X14)		
650	1B		T90-0176-05	T TYPE ANTENNA		
651	1A	*	T90-0804-08	LOOP ANTENNA		
652	1A	*	T90-0805-08	ANTENNA ADAPTER		
KR-A5070						
601	1A		A01-3167-08	METALIC CABINET		
602	1B		A09-0170-08	BATTERY COVER		
606	2A	*	A60-0763-08	FRONT PANEL		
609	1B		A70-0985-08	REMOTE CONTROL UNIT		
610	2A	*	B10-2137-08	FRONT GLASS		
612	2A		B43-0287-04	KENWOOD BADGE		
-			B46-0122-23	WARRANTY CARD		

L: Scandinavia K: USA P: Canada R: Mexico
Y: PX (Far East, Hawaii) T: England E: Europe G: Germany
Y: AAFES (Europe) X: Australia M: Other Areas

△ indicates safety critical components.

× New Parts
Parts without Parts No. are not supplied.
Les articles non mentionnés dans le Parts No. ne sont pas fournis.
Teile ohne Parts No. werden nicht geliefert.

No.2

Ref. No. 参照番号	Address 位置	New Parts 新	Parts No. 部品番号	Description 部品名 / 規格	Desti- nation 仕 向	Re- marks 備考
-		*	B60-2114-08	INSTRUCTION MANUAL (ENGLISH)	E	
-		*	B60-2115-08	INSTRUCTION MANUAL (F/D/I/S)	E	
-		*	B60-2116-08	INSTRUCTION MANUAL (GERMANY)	E	
△ 615	1C	*	E03-0324-08	AC OUTLET		
△ 616	1C		E21-0031-08	GND TERMINAL		
△ 617	1C	*	E30-2799-08	AC POWER CORD		
623	2C	*	G13-0513-08	CUSHION FOOT		
-		*	H10-7076-08	POLYSTYRENE FOAMED FIXTURE		
-			H25-0232-04	PROTECTION BAG (ACCESSORY)		
-			H25-0232-04	PROTECTION BAG (MANUAL)		
-			H25-1544-08	PROTECTION BAG (UNIT)		
-		*	H50-1513-08	ITEM CARTON CASE		
625	2C		J02-1099-08	FOOT		
626	1A		J19-2815-04	ANTENNA HOLDER		
627	2C		J19-3631-08	UNIT HOLDER		
630	1C		J42-0200-08	AC CORD BUSHING		
632	2A	*	K29-6180-08	KNOB PRESET(10KEY)		
633	2A	*	K29-6181-08	KNOB VOLUME CONTROL		
634	2A	*	K29-6182-08	KNOB INPUT SELECTOR		
635	2A	*	K29-6183-08	KNOB BASS, TREBLE, BALANCE		
636	2A	*	K29-6184-08	KNOB POWER		
637	2A	*	K29-6186-08	KNOB P.CALL		
638	2A	*	K29-6187-08	KNOB SPEAKERS		
639	2A	*	K29-6189-08	KNOB FUNCTION		
641	1B		L07-0999-08	POWER TRANSFORMER		
B			N09-3095-08	TAPTITE SCREW (M4X8)		
C			N09-3160-08	TAPTITE SCREW (M3X14)		
650	1B		T90-0176-05	T TYPE ANTENNA		
651	1A	*	T90-0804-08	LOOP ANTENNA		
652	1A	*	T90-0805-08	ANTENNA ADAPTER		
ELECTRIC PARTS						
LD901			B30-0413-05	LED(LTL4213(RED))		
C01			C91-1441-08	CERAMIC 4700PF 250WV		
C02 -04			CK45FF1H103Z	CERAMIC 0.010UF Z		
C05			CE04KW1E471M	ELECTRO 470UF 25WV		
C06			CE04KW1H100M	ELECTRO 10UF 50WV		
C07			CE04KW1A101M	ELECTRO 100UF 10WV		
C08			CE04KW1H010M	ELECTRO 1.0UF 50WV		
C09			CE04KW1H101M	ELECTRO 100UF 50WV		
C10			CE04KW1V101M	ELECTRO 100UF 35WV		
C11			CE04KW1H2R2M	ELECTRO 2.2UF 50WV		
C12			CE04KW1C220M	ELECTRO 22UF 16WV		
C13 ,14			CK45FF1H473Z	CERAMIC 0.047UF Z		
C15 ,16			C90-3561-05	ELECTRO 4700UF 50WV		
C15 ,16			C90-3565-08	ELECTRO 6800UF 63WV		
C17 ,18			CK45FF1H103Z	CERAMIC 0.010UF Z		
C22			CE04KW1H4R7M	ELECTRO 4.7UF 50WV		
C23			CK45FF1H223Z	CERAMIC 0.022UF Z		
C24			CC45FSL1H221J	CERAMIC 220PF J		
C31 -34			CK45FF1H103Z	CERAMIC 0.010UF Z		
C35			CE04KW1V102M	ELECTRO 1000UF 35WV		

L: Scandinavia K: USA P: Canada R: Mexico
Y: PX (Far East, Hawaii) T: England E: Europe G: Germany
Y: AAFES (Europe) X: Australia M: Other Areas

△ indicates safety critical components.

KR-A4070/A5070 [E, T, G]

PARTS LIST

4 : KR-A4070
5 : KR-A5070

× New Parts

Parts without Parts No. are not supplied.

Les articles non mentionnés dans le Parts No. ne sont pas fournis.

Teile ohne Parts No. werden nicht geliefert.

No.3

Ref. No. 参照番号	Address 位置	New Parts 新	Parts No. 部品番号	Description 部品名 / 規格	Desti- nation 仕向	Re- marks 備考
C36		*	C91-1528-08	CERAMIC 0.1UF Z		
C37			CE04KW1C470M	ELECTR0 47UF 16WV		
C38			CE04KW1H221M	ELECTR0 220UF 50WV		
C39			CE04KW1C101M	ELECTR0 100UF 16WV		
C40			C91-1528-08	CERAMIC 0.1UF Z		
C99			CK45FB1H272K	CERAMIC 2700PF K		
C100			CK45FB1H102K	CERAMIC 1000PF K		
C101, 102			CE04KW1H4R7M	ELECTR0 4.7UF 50WV		
C103-106			CK45FB1H102K	CERAMIC 1000PF K		
C107, 108			CE04KW1A101M	ELECTR0 100UF 10WV		
C109, 110			CQ93FMG1H332J	MYLAR 3300PF J		
C111, 112			CQ93FMG1H123J	MYLAR 0.012UF J		
C113, 114			CE04KW1H4R7M	ELECTR0 4.7UF 50WV		
C115			CK45FF1H103Z	CERAMIC 0.010UF Z		
C117, 118		*	C91-1528-08	CERAMIC 0.1UF Z		
C119-128			CC45FSL1H221J	CERAMIC 220PF J		
C131-134			CC45CH1H221J	CERAMIC 220PF J		
C135, 136			CE04KW1C470M	ELECTR0 47UF 16WV		
C137			CC45FSL1H221J	CERAMIC 220PF J		
C138, 139			CC45FSL1H101J	CERAMIC 100PF J		
C140			CK45FB1H102K	CERAMIC 1000PF K		
C148			CE04KW1H010M	ELECTR0 1.0UF 50WV		
C149, 150			CK45FF1H103Z	CERAMIC 0.010UF Z		
C152, 153			CE04KW1H010M	ELECTR0 1.0UF 50WV		
C154			CK45FB1H102K	CERAMIC 1000PF K		
C155			CE04KW1H010M	ELECTR0 1.0UF 50WV		
C156			CE04KW1C101M	ELECTR0 100UF 16WV		
C201, 202			CE04KW1H4R7M	ELECTR0 4.7UF 50WV		
C203, 204			CC45FSL1H680J	CERAMIC 68PF J		
C205, 206			CK45FB1H471K	CERAMIC 470PF K		
C207			CE04KW1A471M	ELECTR0 470UF 10WV		
C209, 210			CE04KW1A101M	ELECTR0 100UF 10WV		
C211-214			CC45FSL1H221J	CERAMIC 220PF J		
C215, 216			CC45FSL2H680J	CERAMIC 68PF J		
C217, 218			CK45FF1H103Z	CERAMIC 0.010UF Z		
C219, 220			CC45FCH1H180J	CERAMIC 18PF J		
C221, 222			CC45FSL1H221J	CERAMIC 220PF J		
C223			CE04KW1H470M	ELECTR0 47UF 50WV		4
C223			CE04KW1J470M	ELECTR0 47UF 63WV		5
C224			CE04KW1H101M	ELECTR0 100UF 50WV		4
C224			CE04KW1J101M	ELECTR0 100UF 63WV		5
C225			CE04KW0J221M	ELECTR0 220UF 6.3WV		
C227-230			CQ93FMG1H683J	MYLAR 0.068UF J		
C231-234			CK45FF1H223Z	CERAMIC 0.022UF Z		
C235, 236			CK45FF1H103Z	CERAMIC 0.010UF Z		
C301			CE04KW1A471M	ELECTR0 470UF 10WV		
C801			CC45FCH1H330J	CERAMIC 33PF J		
C802, 803			CK45FB1H102K	CERAMIC 1000PF K		
C804, 805			CK45FF1H103Z	CERAMIC 0.010UF Z		
C806			CE04KW1C470M	ELECTR0 47UF 16WV		
C807			CE04KW1H010M	ELECTR0 1.0UF 50WV		
C808			CE04KW1C470M	ELECTR0 47UF 16WV		
C809			CQ93FMG1H223J	MYLAR 0.022UF J		
C810			CE04KW1H010M	ELECTR0 1.0UF 50WV		
C811			CK45FF1H473Z	CERAMIC 0.047UF Z		

L: Scandinavia

K: USA

P: Canada

R: Mexico

4 : KR-A4070

Y: PX (Far East, Hawaii)

T: England

E: Europe

G: Germany

5 : KR-A5070

Y: AAFES (Europe)

X: Australia

M: Other Areas

△ indicates safety critical components.

× New Parts

Parts without Parts No. are not supplied.

Les articles non mentionnés dans le Parts No. ne sont pas fournis.

Teile ohne Parts No. werden nicht geliefert.

No.4

Ref. No. 参照番号	Address 位置	New Parts 新	Parts No. 部品番号	Description 部品名 / 規格	Desti- nation 仕向	Re- marks 備考
C812			CC45FCH1H150J	CERAMIC 15PF J		
C813			CE04KW1H4R7M	ELECTR0 4.7UF 50WV		
C814			CE04KW1H2R2M	ELECTR0 2.2UF 50WV		
C815			CE04KW1H3R3M	ELECTR0 3.3UF 50WV		
C816			CK45FF1H103Z	CERAMIC 0.010UF Z		
C817, 818			CK45FF1H223Z	CERAMIC 0.022UF Z		
C819			CQ93FMG1H153J	MYLAR 0.015UF J		
C820			CK45FF1H223Z	CERAMIC 0.022UF Z		
C821			CE04KW1C100M	ELECTR0 10UF 16WV		
C822			CE04KW1HR47M	ELECTR0 0.47UF 50WV		
C823			CK45FF1H103Z	CERAMIC 0.010UF Z		
C824			CC45FCH1H220J	CERAMIC 22PF J		
C825-828			CK45FF1H103Z	CERAMIC 0.010UF Z		
C829			CE04KW1C470M	ELECTR0 47UF 16WV		
C830			CE04KW1H010M	ELECTR0 1.0UF 50WV		
C831-833			CC45FSL1H101J	CERAMIC 100PF J		
C834			CE04KW1H4R7M	ELECTR0 4.7UF 50WV		
C835			CQ93FMG1H103J	MYLAR 0.010UF J		
C836			CE04KW1H010M	ELECTR0 1.0UF 50WV		
C837			CE04KW1HR22M	ELECTR0 0.22UF 50WV		
C838, 839			CE04KW1H010M	ELECTR0 1.0UF 50WV		
C840			CE04KW1C101M	ELECTR0 100UF 16WV		
C841			CK45FB1H561J	CERAMIC 560PF J		
C842, 843			CE04KW1C100M	ELECTR0 10UF 16WV		
C844, 845			CC45FSL1H181J	CERAMIC 180PF J		
C846, 847			CE04KW1H2R2M	ELECTR0 2.2UF 50WV		
C848, 849			CQ93FMG1H392J	MYLAR 3900PF J		
C850			CK45FF1H103Z	CERAMIC 0.010UF Z		
C851			CE04KW1C470M	ELECTR0 47UF 16WV		
C852			CK45FF1H103Z	CERAMIC 0.010UF Z		
C853, 854			CC45FCH1H220J	CERAMIC 22PF J		
C855			CC45FB1H471K	CERAMIC 470PF K		
C856			CC45FSL1H221J	CERAMIC 220PF J		
C857, 858			CC45FSL1H101J	CERAMIC 100PF J		
C859			CE04KW1HOR1M	ELECTR0 0.1UF 50WV		
C860			CK45FF1H103Z	CERAMIC 0.010UF Z		
C861			CE04KW1C470M	ELECTR0 47UF 16WV		
C862			CK45FF1H103Z	CERAMIC 0.010UF Z		
C863, 864			CE04KW1C100M	ELECTR0 10UF 16WV		
C865, 866			CK45FF1H103Z	CERAMIC 0.010UF Z		
C868			CC45FSL1H270J	CERAMIC 27PF J		
C869			CK45FF1H103Z	CERAMIC 0.010UF Z		
C871			CC45FSL1H331J	CERAMIC 330PF J		
C872			CE04KW1H2R2M	ELECTR0 2.2UF 50WV		
C873			CK45F1H103M	CERAMIC 0.010UF M		
C874			CC45FSL1H820J	CERAMIC 82PF J		
C875			CC45FSL1H470J	CERAMIC 47PF J		
C876			CK45FF1H103Z	CERAMIC 0.010UF Z		
C877, 878			CE04KW1C100M	ELECTR0 10UF 16WV		
C879-881			CK45FF1H103Z	CERAMIC 0.010UF Z		
C882		*	CK45FB1H561J	CERAMIC 560PF J		
C883			CC45FCH1H220J	CERAMIC 22PF J		
C884			CC45FCH1H060D	CERAMIC 6.0PF D		
C903, 904			CE04KW1C330M	ELECTR0 33UF 16WV		
C905			CE04KW1H4R7M	ELECTR0 4.7UF 50WV		

L: Scandinavia

K: USA

P: Canada

R: Mexico

Y: PX (Far East, Hawaii)

T: England

E: Europe

G: Germany

Y: AAFES (Europe)

X: Australia

M: Other Areas

△ indicates safety critical components.

PARTS LIST

KR-A4070/A5070 [E, T, G]

* New Parts

Parts without Parts No. are not supplied.

Les articles non mentionnés dans le Parts No. ne sont pas fournis.

Teile ohne Parts No. werden nicht geliefert.

No.5

Ref. No. 参照番号	Address 位置	New Parts 新	Parts No. 部品番号	Description 部品名 / 規格	Desti- nation 仕 向	Re- marks 備考
C906			C90-1827-05	ELECTRO 0.047F 5.5WV		
C907			CE04KW1A101M	ELECTRO 100UF 10WV		
C908			CK45FF1H103Z	CERAMIC 0.010UF Z		
C911, 912			CK45FF1H103Z	CERAMIC 0.010UF Z		
C913, 914			CK45FF1H223Z	CERAMIC 0.022UF Z		
C921, 922			CE04KW1H4R7M	ELECTRO 4.7UF 50WV		
C923, 924			CQ93FMG1H153J	MYLAR 0.015UF J		
C925, 926			CQ93FMG1H683J	MYLAR 0.068UF J		
C927, 928			CK45FB1H822Z	CERAMIC 8200PF Z		
C929, 930			CC45FCH1H220J	CERAMIC 22PF J		
C931, 932			CC45FSL1H101J	CERAMIC 100PF J		
C933, 934			CQ93FMG1H333J	MYLAR 0.033UF J		
C946			CK45FF1H103Z	CERAMIC 0.010UF Z		
C950			CK45FF1H103Z	CERAMIC 0.010UF Z		
E1	1C		E63-0157-08	PHONE JACK PHONE		
E2	1C		E63-0159-08	PHONE JACK CD, TAPE1		
E3, 4	1C		E63-0158-08	PHONE JACK TAPE2, VIDEO1,2		
E5	1C		E70-0004-08	LOCK TERMINAL BOARD SPEAKERS		
E6	1B		E11-0188-05	MINIATUA PHONE JACK SYNCHRO		
JACK801	1C		E70-0023-08	TERMINAL BOARD ANTENNA		
PHONE	2A		E11-0263-08	PHONE JACK HEAD PHONES		
F1	1B		F05-1623-05	FUSE SEMCO T1.6A/250V		4 5
F1	1B		F06-2021-05	FUSE SEMCO T2A/250V		
F2	1B		F05-2525-05	FUSE SEMCO T2.5A/250V		
F3	1B		F06-1022-05	FUSE SEMCO T1A/250V		
-			J13-0084-08	FUSE CLIP		
CF801, 802			L72-0575-08	CERAMIC FILTER 10.7MHz		
L201, 202			L39-1303-08	INDUCTOR 0.15UH		
L301			L33-0379-08	INDUCTOR 22UH		
L801			L40-1091-17	SMALL FIXED INDUCTOR 1UH		
L802			L39-1322-08	COIL		
L803			L33-0381-08	SMALL FIXED INDUCTOR 1mH		
L804			L30-0904-08	IFT AM		
L805			L30-0905-08	IFT FM		
L806			L30-0906-08	IFT FM		
L807			L39-1323-08	COIL		
L808, 809			L35-0070-08	COIL		
L810			L40-1091-17	SMALL FIXED INDUCTOR 1UH		
L811-813			L40-1001-17	SMALL FIXED INDUCTOR 10UH		
L901			L40-1001-17	SMALL FIXED INDUCTOR 10UH		
L902, 903			L40-1091-17	SMALL FIXED INDUCTOR 1UH		
L905-908			L40-1091-17	SMALL FIXED INDUCTOR 1UH		
T01		*	L07-1987-08	TRANSFORMER		4
X801			L78-0616-08	RESONATOR 456kHz		
X802			L77-2126-08	CRYSTAL 7.200MHz		
X803			L77-2127-08	CRYSTAL 4.332MHz		
X804			L78-0617-08	RESONATOR 4.00MHz		
X901			L78-0209-05	RESONATOR 4.19MHz		
G	2K		N89-3010-46	BINDING HEAD TAPTITE SCREW		
CP1, 2			R90-0947-08	MULTI-COMP 0.22X2 K 3W		
R03			RD14GB2E101J	FL-PROOF RD 100 J 1/4W		
R31			RD14GB2E101J	FL-PROOF RD 100 J 1/4W		

L: Scandinavia

Y: PX (Far East, Hawaii)

Y: AAFES (Europe)

K: USA

T: England

X: Australia

P: Canada

E: Europe

M: Other Areas

R: Mexico

G: Germany

4: KR-A4070

5: KR-A5070

△ indicates safety critical components.

* New Parts

Parts without Parts No. are not supplied.

Les articles non mentionnés dans le Parts No. ne sont pas fournis.

Teile ohne Parts No. werden nicht geliefert.

No.6

Ref. No. 参照番号	Address 位置	New Parts 新	Parts No. 部品番号	Description 部品名 / 規格	Desti- nation 仕 向	Re- marks 備考
R32			RS14KB3D122J	FL-PROOF RS 1.2K J 2W		
R177			RD14GB2E100J	FL-PROOF RD 10 J 1/4W		
R217-222			RD14GB2E221J	FL-PROOF RD 220 J 1/4W		
R229-232			RD14GB2E221J	FL-PROOF RD 220 J 1/4W		
R245-248			RD14GB2E221J	FL-PROOF RD 220 J 1/4W		
R249			RD14GB2E101J	FL-PROOF RD 100 J 1/4W		
R250			RD14GB2E470J	FL-PROOF RD 47 J 1/4W		
R253, 254			RS14KB3A100J	FL-PROOF RS 10 J 1W		
R255, 256			RS14KB3A561J	FL-PROOF RS 560 J 1W		
R824			RD14GB2E101J	FL-PROOF RD 100 J 1/4W		
R827			RD14GB2E101J	FL-PROOF RD 100 J 1/4W		
R840			RD14GB2E101J	FL-PROOF RD 100 J 1/4W		
R851			RD14GB2E470J	FL-PROOF RD 47 J 1/4W		
R866			RS14KB3D221J	FL-PROOF RS 220 J 2W		
VR101	2B		R39-0001-08	POTENTIOMETER 100KBX2 VOLUME		
VR102	2B	*	R31-0053-08	POTENTIOMETER BALANCE		5
VR201, 202			R12-1066-05	TRIM POT. 1KB IDLE ADJ		
VR801			R12-1053-05	TRIM POT. 4.7KB AM TUNE LEVEL		
VR802			R32-0012-08	TRIM POT. 100KB FM TUNE LEVEL		
VR803			R32-0012-08	TRIM POT. 100KB SEPARATION		
VR901, 902	2B		R31-0058-08	POTENTIOMETER BASS TREBLE		
K1			S76-0034-08	MAGNETIC RELAY		
K2, 3			S76-0035-08	MAGNETIC RELAY		
SW2	1C		S62-0032-08	SLIDE SWITCH IMPEDANCE SELECT		
SW901-925	2B		S70-0030-08	TACT SWITCH KEY BOARD		
SW926	2B		S60-0030-08	ROTARY SWITCH INPUT SELECTOR		
D1			1SS133	DIODE		
D2 -5			1N4002A	DIODE		
D06 -08			1SS133	DIODE		
D10			1SS133	DIODE		
D12, 13			1SS133	DIODE		
D14, 15			1N4002A	DIODE		
D16, 17			1SS133	DIODE		
D25, 26			1SS133	DIODE		
D30			DBF40C	DIODE		
D30			DBF60C	DIODE		4 5
D31 -36			1N4002A	DIODE		
D98, 99			1SS133	DIODE		
D101-104			1SS133	DIODE		
D107-110			1SS133	DIODE		
D201, 202			1SS133	DIODE		
D203, 204			1N4002A	DIODE		
D205, 206			1SS133	DIODE		
D801-809			1SS133	DIODE		
D810			RD5.1ES(B2)	ZENER DIODE		
D811			1SS133	DIODE		
D812			RD13ES(B2)	ZENER DIODE		
D901-920			1SS133	DIODE		
D921			MTZJ6.2B	ZENER DIODE		
D922			MTZ2.7B	ZENER DIODE		
FLT901	2B	*	10-MT-65GK	FLUORESCENT INDICATOR TUBE		
IC01			MC7815C	IC(VOLTAGE REGULATOR/+15)		
IC101			NJM4558DD	IC(OP AMP X2)		
IC102			NJU7313L	IC(ANALOG SWITCH) SELECTOR SW)		

L: Scandinavia

Y: PX (Far East, Hawaii)

Y: AAFES (Europe)

K: USA

T: England

X: Australia

P: Canada

E: Europe

M: Other Areas

R: Mexico

G: Germany

4: KR-A4070

5: KR-A5070

△ indicates safety critical components.

KR-A4070/A5070 [E, T, G]

PARTS LIST

* New Parts

Parts without Parts No. are not supplied.

Les articles non mentionnés dans le Parts No. ne sont pas fournis.

Teile ohne Parts No. werden nicht geliefert.

No.7

Ref. No. 参照番号	Address 位置	New Parts 新	Parts No. 部品番号	Description 部品名/規格	Desti- nation 向	Re- marks 備考
IC104		*	NJU7311L	IC(ANALOG SWITCH)ARRAY)		
IC105		*	NJU7312AL	IC(SWITCHING IC)TCH X16)		
IC106			BA6209N	IC(MOTOR DRIVER)		
IC801			LA1266	IC(AM/FM IF)		
IC802			LA3401	IC(FM MPX)		
IC803			LC7218	IC(PLL FREQUENCY SYNTHESIZER)		
IC804			LM258N	IC		
IC805			SAA6579T	IC(RDS DEMODULATOR)		
IC806			LC6543H-4600	IC(4bit MICROPROCESSOR)		
IC810			NJM78L05A	IC(VOLTAGE REGULATOR/ +5V)		
IC810			UPC78L05	IC(VOLTAGE REGULATOR/ +5V)		
IC901			UPD78044GF-021	IC(8BIT MICROPROCESSOR)		
IC902			PST529C	IC(SYSTEM RESET)		
Q01			2SD882	TRANSISTOR		
Q02 -05			DTC114ES	DIGITAL TRANSISTOR		
Q06			2SA916	TRANSISTOR		
Q08			2SA933S	TRANSISTOR		
Q10			2SA933S	TRANSISTOR		
Q101-104			2SC2878B	TRANSISTOR		
Q105, 106			DTA144ES	DIGITAL TRANSISTOR		
Q107-109			DTC114ES	DIGITAL TRANSISTOR		
Q201-204			2SA992F	TRANSISTOR		
Q205, 206			2SC1845F	TRANSISTOR		
Q207, 208			2SA992F	TRANSISTOR		
Q209, 210			2SC1845F	TRANSISTOR		
Q211, 212			2SC4137V	TRANSISTOR		
Q213, 214		*	2SC2316Y	TRANSISTOR		
Q215, 216			2SA916	TRANSISTOR		
Q217, 218			2SC4467Y	TRANSISTOR		
Q217, 218			2SC4468P	TRANSISTOR		4 5
Q219, 220		*	2SA1694Y	TRANSISTOR		4 5
Q219, 220			2SA1695	TRANSISTOR		
Q221, 222			2SC1845F	TRANSISTOR		
Q223, 224			2SC1740S-R	TRANSISTOR		
Q801			2SC1740S-R	TRANSISTOR		
Q802			2SA933S	TRANSISTOR		
Q803			2SC1740S-R	TRANSISTOR		
Q804			2SC31940	TRANSISTOR		
Q805			2SC1845F	TRANSISTOR		
Q806-808			2SC1740S-R	TRANSISTOR		
Q809, 810			2SA933S	TRANSISTOR		
Q811			2SD2061E	TRANSISTOR		
Q901, 902			2SC1740S-R	TRANSISTOR		
ZD01			MTZJ3.9B	ZENER DIODE		
ZD02, 03			MTZJ5.1B	ZENER DIODE		
ZD04			RD6.2ES(B2)	ZENER DIODE		
ZD06, 07			MTZJ16A	ZENER DIODE		
ZD08, 09			MTZJ5.1B	ZENER DIODE		
ZD10			MTZJ6.8B	ZENER DIODE		
ZD11			MTZJ8.2B	ZENER DIODE		
A901			W02-1111-08	ELECTRIC CIRCUIT MODULE		
TUNER801			W02-1041-15	FM FRONT END		

PARTS LIST

KR-A4070/A5070 [E, T, G]

L: Scandinavia

K: USA

P: Canada

R: Mexico

4: KR-A4070

Y: PX (Far East, Hawaii)

T: England

E: Europe

G: Germany

5: KR-A5070

Y: AAFES (Europe)

X: Australia

M: Other Areas

△ indicates safety critical components.

KR-A4070/A5070 [E, T, G]

SPECIFICATIONS

KR-A5070

Audio section

Rated power output (DIN)	1,000 Hz	at 8 Ω	100 W + 100 W
		at 4 Ω	90 W + 90 W
Total harmonic distortion (1 kHz, 8 Ω)	0.01% at 50 W		
Signal to noise ratio			
PHONO (MM)	56 dB (DIN, 50 mW output)		
CD, TAPE, VIDEO	57 dB (DIN, 50 mW output)		
Input sensitivity / impedance			
PHONO (MM)	2.5 mV / 47 kΩ		
CD, TAPE, VIDEO	200 mV / 47kΩ		
Tone controls			
BASS	±10 dB (at 100 Hz)		
TREBLE	±10 dB (at 10 kHz)		

FM Tuner section

Tuning frequency range	87.5 MHz~108 MHz		
Usable sensitivity (DIN at 75 Ω)			
MONO	1.1 μV		
STEREO	45 μV		
Total harmonic distortion at 1 kHz (DIN)			
MONO	0.15%		
STEREO	0.5%		
Signal to noise ratio (DIN weighted at 1 kHz)			
MONO	68 dB (65.2 dBf input)		
STEREO	61 dB (65.2 dBf input)		
Selectivity (DIN ± 300 kHz)	53 dB		
Stereo separation (DIN)			
1 kHz	40 dB		
6.3 kHz	33 dB		
Frequency response	30 Hz~15 kHz, + 0.5 dB, - 2.0 dB		

AM Tuner section

Tuning frequency range	531 kHz ~ 1,602 kHz		
Usable sensitivity	12 μV / (400 μV / m)		
Total harmonic distortion	0.3 %		
Signal to noise ratio (at 30% mod. 1mV input)	50 dB		
Selectivity	30 dB		

General

Power consumption	190 W		
AC outlet			
SWITCHED	2: (total 200 W max)		
Dimensions	W:440 mm		
	H:133 mm		
	D:350 mm		
Weight (net)	8.3 kg		

KR-A4070

Audio section

Rated power output (DIN)	1,000 Hz	at 8 Ω	60 W + 60 W
		at 4 Ω	55 W + 55 W
Total harmonic distortion (1 kHz, 8 Ω)	0.01% at 30 W		
Signal to noise ratio			
PHONO (MM)	56 dB (DIN, 50 mW output)		
CD, TAPE, VIDEO	57 dB (DIN, 50 mW output)		
Input sensitivity / impedance			
PHONO (MM)	2.5 mV / 47 kΩ		
CD, TAPE, VIDEO	200 mV / 47kΩ		
Tone controls			
BASS	±10 dB (at 100 Hz)		
TREBLE	±10 dB (at 10 kHz)		

FM Tuner section

Tuning frequency range	87.5 MHz~108 MHz		
Usable sensitivity (DIN at 75 Ω)			
MONO	1.1 μV		
STEREO	45 μV		
Total harmonic distortion at 1 kHz (DIN)			
MONO	0.15%		
STEREO	0.5%		
Signal to noise ratio (DIN weighted at 1 kHz)			
MONO	68 dB (65.2 dBf input)		
STEREO	61 dB (65.2 dBf input)		
Selectivity (DIN ± 300 kHz)	53 dB		
Stereo separation (DIN)			
1 kHz	40 dB		
6.3 kHz	33 dB		
Frequency response	30 Hz~15 kHz, + 0.5 dB, - 2.0 dB		

AM Tuner section

Tuning frequency range	531 kHz ~ 1,602 kHz		
Usable sensitivity	12 μV / (400 μV / m)		
Total harmonic distortion	0.3 %		
Signal to noise ratio (at 30% mod. 1mV input)	50 dB		
Selectivity	30 dB		

General

Power consumption	120 W		
AC outlet			
SWITCHED	2: (total 200 W max)		
Dimensions	W:440 mm		
	H:133 mm		
	D:350 mm		
Weight (net)	6.7 kg		

KENWOOD follows a policy of continuous advancements in development. For this reason specifications may be changed without notice.

KENWOOD CORPORATION

14-6, Dogenzaka 1-chome, Shibuya-ku, Tokyo, 150 Japan

KENWOOD SERVICE CORPORATION

P.O. BOX 22745, 2201 East Dominguez St., Long Beach, CA 90801-5745 U.S.A.

KENWOOD ELECTRONICS CANADA INC.

6070 Kestrel Road, Mississauga, Ontario, Canada L5T 1S8

KENWOOD ELECTRONICS LATIN AMERICA S.A.

P.O. BOX 55-2791, Piso 6 Plaza Chase, Cl. 47 y Aquilino de la Guardia, Panama, Republic de Panama

TRIO-KENWOOD U.K. LIMITED

KENWOOD House, Dwight Road, Watford, Herts. WD1 8EB United Kingdom

KENWOOD ELECTRONICS BENELUX N.V.

Mecheelsesteenweg 418 B-1930 Zaventem, Belgium

KENWOOD ELECTRONICS DEUTSCHLAND GMBH

Rembrücker Str. 15, 63150 Heusenstamm, Germany

TRIO-KENWOOD FRANCE S.A.

13 Boulevard Ney, 75018 Paris, France

KENWOOD ELECTRONICS ITALIA S.p.A.

Via G. Sirtori, 7/9 20129 Milano, Italy

KENWOOD ESPAÑA S.A.

Bolivia, 239-08020 Barcelona, Spain

KENWOOD ELECTRONICS AUSTRALIA PTY. LTD. (A.C.N. 001 499 074)

P.O. BOX 504, 8 Figtree Drive, Australia Centre, Homebush, N.S.W. 2140, Australia

KENWOOD & LEE ELECTRONICS, LTD.

Unit 3712-3724, Level 37 Tower 1, Metroplaza, 223 Hing Fong Road, Kwai Fong N.T. Hong Kong

KENWOOD ELECTRONICS SINGAPORE PTE LTD.

No. 1 Genting Lane # 07-00, KENWOOD Building, Singapore, 1334

KENWOOD ELECTRONICS (MALAYSIA) SDN BHD

10 th Floor, Block B, Wisma Semantan, No. 12, Jalan Gelinggong, Bukit Damansara, 50490 Kuala Lumpur, Malaysia

Note:

Component and circuitry are subject to modification to insure best operation under differing local conditions. This manual is based on the U.S.A. (K) standard, and provides information on regional circuit modification through use of alternate schematic diagrams, and information on regional component variations through use of parts list.