

AUDIO VIDEO SURROUND RECEIVER
**KRF-V5010/V5010E/V5010W/
 V6010/V6010E/V6010W/
 V7010/V7010E/V7010W/
 VR-205/207/255/257**
SERVICE MANUAL

KENWOOD

© 1998-4/B51-5425-00 (K/K) 3484

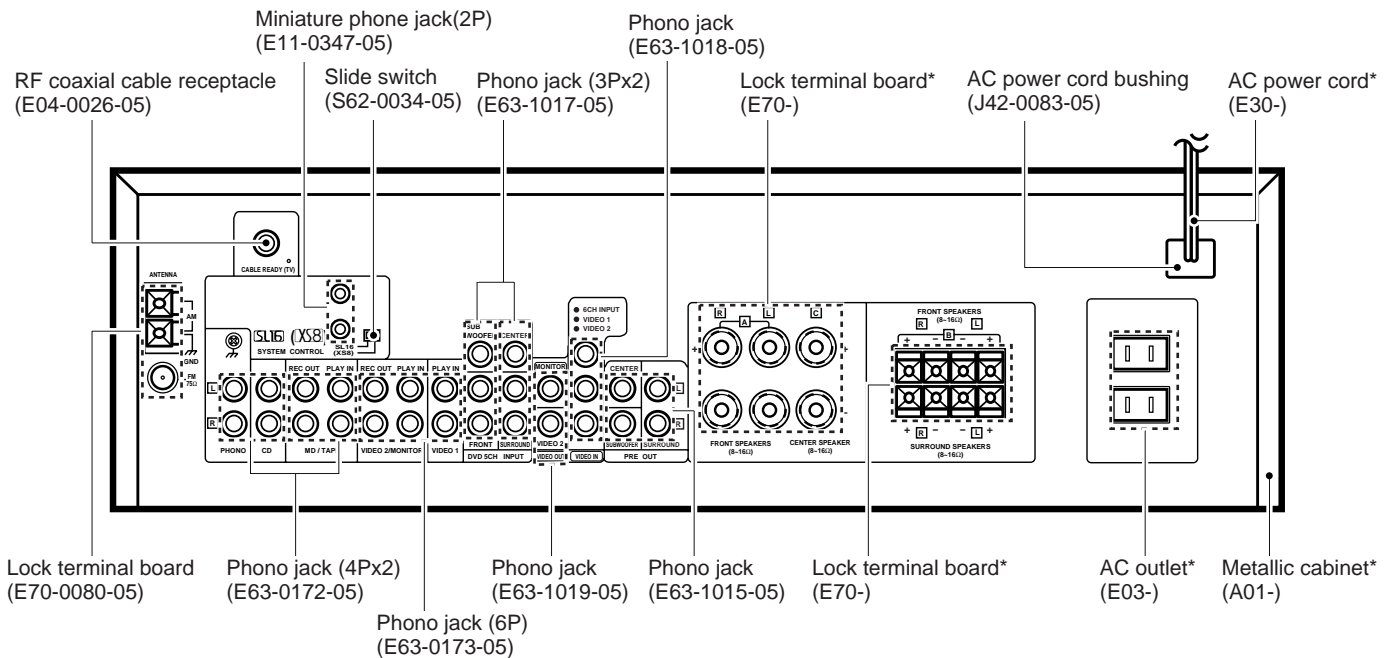
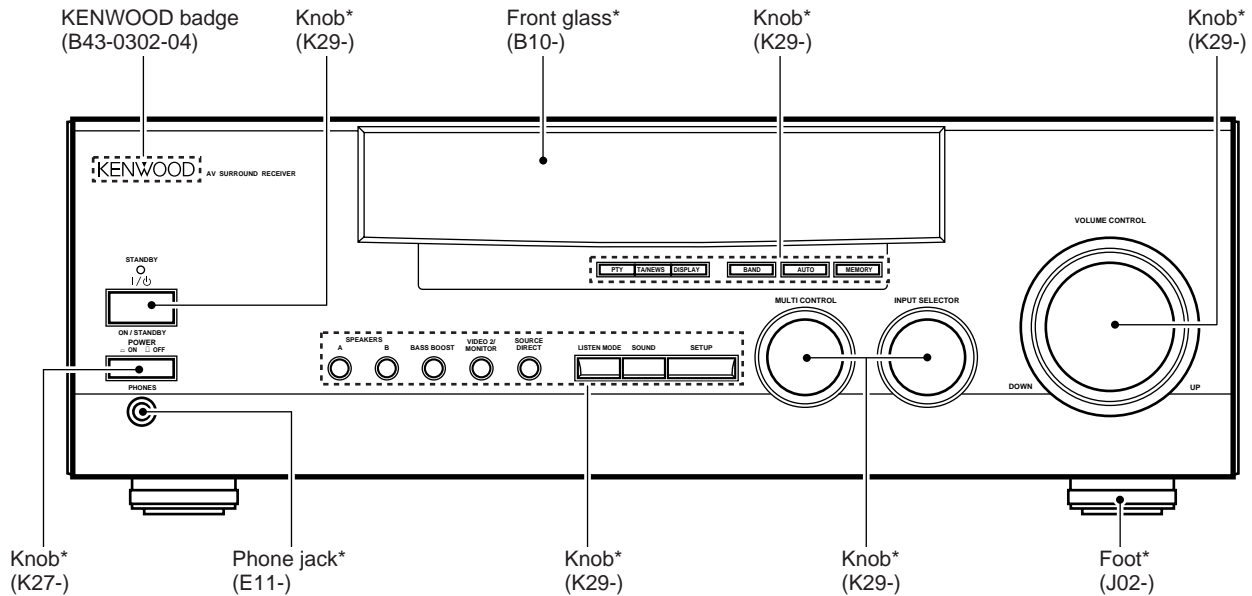

* Refer to parts list on page 33.



KRF-V5010/V6010/V7010/VR-205/206/207/255/257

CONTENTS / ACCESSORIES

Contents

CONTENTS / ACCESSORIES	2	ADJUSTMENT	13
CONTROLS	3	PC BOARD	14
DISASSEMBLY FOR REPAIR	5	SCHEMATIC DIAGRAM	17
WIRING DIAGRAM	6	EXPLODED VIEW	32
BLOCK DIAGRAM	7	PARTS LIST	33
CIRCUIT DESCRIPTION	8	SPECIFICATIONS	47

Accessories

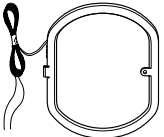
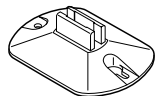
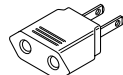
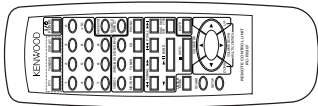
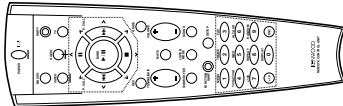
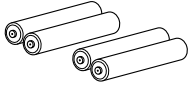
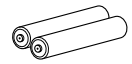
<p>FM indoor antenna (1) (T90-0836-05)</p> 	<p>---AM loop antenna (1) (T90-0833-05) ---</p> 	<p>Loop antenna stand (1) (J19-3645-05)</p> 	<p>AC plug adaptor (1) (E03-0115-05)</p>  <p>*Use to adapt the plug on the power cord to the shape of the wall outlet. (Accessory only for regions where use is necessary.)</p>
<p>Remote control unit (1) RC-R0307/R0407</p> 	<p>Remote control unit (1) RC-R0507/R0607</p> 	<p>Batteries (R03/AAA) (4)</p> 	<p>Batteries (R06/AA) (2)</p> 

Model name vs remote controller

Remote controller		Model name	Destination	Battery cover	
Parts number	Model name				
A70-1194-05	RC-R0607	VR-207	KP1	A09-0366-08	
		VR-257	K1P2		
		VR-255	K1P2		
		KRF-V7010	Y1M1		
A70-1195-05	RC-R0507	KRF-V7010	X1E1T1		
		KRF-V7010W	Q1		
		KRF-V7010E	E2		
A70-1196-05	RC-R0307	KRF-V6010	E		A09-0396-08
		KRF-V6010W	Q1		
		KRF-V6010E	E1		
		KRF-V5010	E1T1		
		KRF-V5010W	Q1		
		KRF-V5010E	E2		
A70-1199-05	RC-R0407	VR-206	K2P3		
		KRF-V6010	M1X1		
		VR-205	KP1		
		KRF-V5010	Y1M1X1		

Resetting the Microcomputer

If the microcomputer may malfunction (unit cannot be operated, or shows an erroneous display) if the power cord is unplugged while the power is ON, or due to some other external factor. If this happens, execute the following procedure to reset the microcomputer and return the unit to its normal operating condition.

For U.S.A. and Canada

Unplug the power cord from the wall outlet, then plug it back in while holding down the POWER key.

For other countries

With the power cord plugged in, turn the POWER key OFF. Then, while holding down the ON/STANDBY key, press POWER.

- Please note that resetting the microcomputer will clear the contents of the memory and returns the unit to the state it was in when it left the factory.

KRF-V5010/V6010/V7010/VR-205/206/207/255/257

CONTROLS

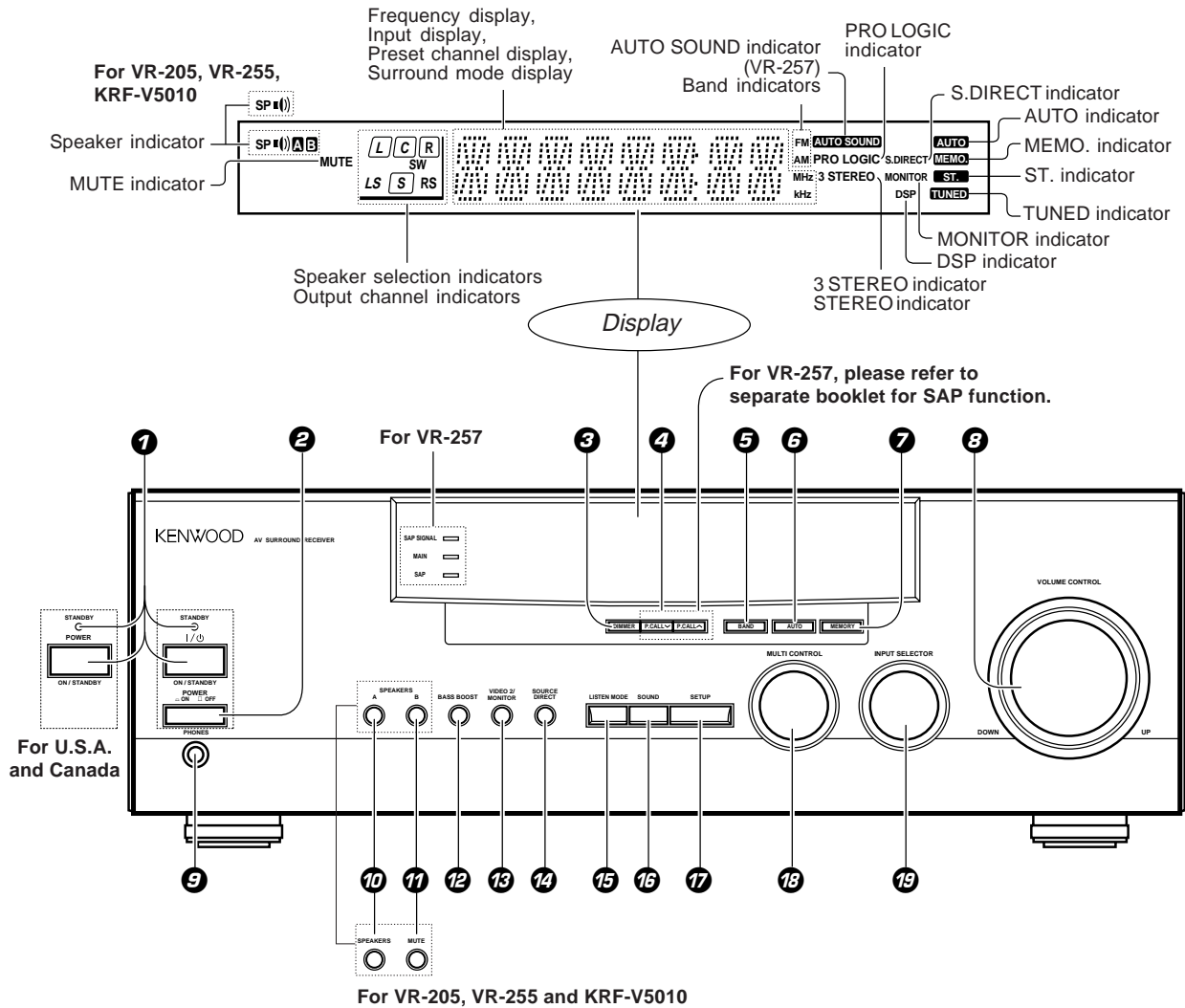

- | | | |
|---|---|---|
| <p>1 POWER key
(For U.S.A. and Canada)
Use to turn the power ON/OFF.
STANDBY indicator</p> <p>1 ON/STANDBY (I/O) key
(Except for U.S.A. and Canada)
Use to switch the power ON/STANDBY when the POWER is turned ON.
STANDBY indicator</p> <p>2 POWER key
(Except for U.S.A. and Canada)</p> <p>3 DIMMER key
Use to adjust the brightness of the display.</p> <p>4 P.CALL keys (Except for VR-257)
Use to call up previously registered radio stations.</p> <p>5 BAND key
Use to select the broadcast band.</p> <p>6 AUTO key
Use to select the auto tuning mode.</p> | <p>7 MEMORY key
Use to store radio stations in the preset memory.</p> <p>8 VOLUME CONTROL knob</p> <p>9 PHONES jack
Use for headphone listening.</p> <p>10 SPEAKERS A key
Use to turn speaker system A on and off.
SPEAKERS key
(VR-205, VR-255, KRF-V5010)
Use to turn the speakers on and off.</p> <p>11 SPEAKERS B key
Use to turn speaker system B on and off.
MUTE key
(VR-205, VR-255, KRF-V5010)
Use to temporarily mute the sound.</p> <p>12 BASS BOOST key
Use to select the maximum adjustment setting for the low frequency range.</p> | <p>13 VIDEO 2/MONITOR key</p> <p>14 SOURCE DIRECT key</p> <p>15 LISTEN MODE key
Use to select the listening mode.</p> <p>16 SOUND key
Use to adjust the sound quality and ambience effects.</p> <p>17 SETUP key
Use to select the surround sound settings.</p> <p>18 MULTI CONTROL knob
Used to make a variety of settings.</p> <p>19 INPUT SELECTOR knob
Use to select the input sources.</p> |
|---|---|---|

About the STANDBY indicator

This unit has a STANDBY indicator. When the STANDBY indicator is lit, the unit consumes a small amount of power to preserve the memory. This is called STANDBY mode. This mode also lets you turn the power ON using the remote control.

CONTROLS

Remote control unit (RC-R0407)

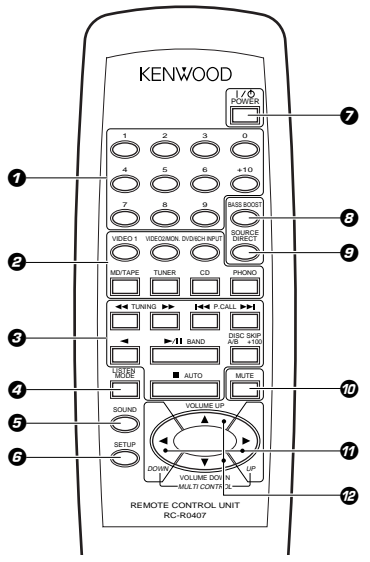

- ➊ **Numeric keys**
If CD or MD is selected as the input source, these keys function as numeric keys. If tuner is selected as the input source, these keys are used to call up station presets.
- ➋ **Input selector keys**
Use to select the receiver's input source.
- ➌ **Component operation keys**
Use these keys to operate other components with system control connections to the receiver.
TUNING (◀▶) keys
If tuner is selected as the input source, these keys function as tuning keys.
If CD or MD is selected as the input source, these keys function as search keys.
P.CALL (◀▶) keys
If tuner is selected as the input source, these keys function as P.CALL keys.
If CD or MD is selected as the input source, these keys function as skip keys.
- ➍ **◀ key**
If tape is selected as the input source, this key functions as the play key for side B of the cassette (the side facing away from the front of the deck).
BAND (▶||) key
If tuner is selected as the input source, this key functions as the band selector key.
If CD is selected as the input source, this key functions as the play/pause key.
If MD is selected as the input source, this key functions as the play key.
DISC SKIP, A/B, +100 key
If CD is selected as the input source, this key functions as the multi-CD player disc skip key.
If TAPE is selected as the input source, this key is used to switch between the two decks (A and B) of a double cassette deck.
AUTO key
If tuner is selected as the input source, this key functions as the AUTO key.
If CD or MD is selected as the input source, this key functions as the stop key.

- ➎ **LISTEN MODE key**
Use to select the listening mode.
- ➏ **SOUND key**
Use to adjust the sound quality and ambience effects.
- ➐ **SETUP key**
Use to select the surround sound settings.
- ➑ **POWER key**
Use to switch the power ON/STANDBY when the POWER is turned ON.
- ➒ **BASS BOOST key**
Use to select the maximum adjustment setting for the low frequency range.
- ➓ **SOURCE DIRECT key**
- ➑ **MUTE key**
Use to temporarily mute the sound.
- ➒ **MULTI CONTROL key**
Used to make a variety of settings.
- ➓ **VOLUME CONTROL key**

Remote control unit (RC-R0607, RC-R0507)

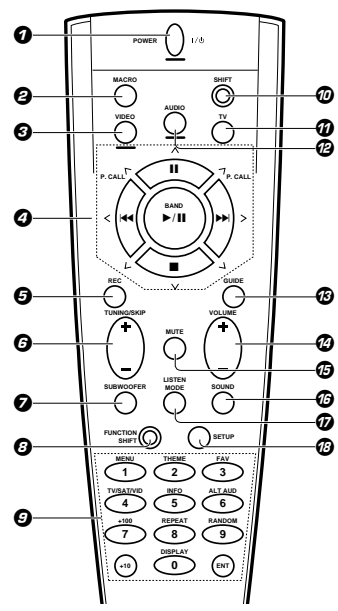

- ➊ **POWER key**
Use to turn the receiver on and off.
Use in combination with the input selector (AUDIO, VIDEO, or TV) keys and SHIFT key to turn various components on and off.
- ➋ **MACRO key**
Use in combination with the AUDIO, VIDEO, or TV keys to execute a series of commands automatically (MACRO PLAY).
- ➌ **VIDEO selector key**
Selects the video inputs and sets the remote control to operate the component registered at the respective input.
- ➍ **Multi control keys**
Use to operate the selected component.
- ➎ **REC key**
Use to operate the selected component.
- ➏ **TUNING/SKIP key**
Use during the setup procedure to specify various settings. Use to operate the tuner or selected component.
- ➐ **SUBWOOFER key**
Use in combination with the VOLUME +/- keys to adjust the volume of the subwoofer.
- ➑ **FUNCTION SHIFT key**
Use in combination with the numeric keys to execute alternate commands.
- ➒ **Numeric keys**
Provide functions identical to those of the original remote control supplied with the component you are controlling.
To access the functions printed above the keys, press within 3 seconds of pressing the FUNCTION SHIFT key. Function availability varies for each component.
- ➓ **SHIFT key**
Use in combination with the AUDIO and VIDEO keys to change the remote control mode without changing the input selector or in combination with the POWER key to turn on and off components programmed into the remote control.
- ➑ **TV selector key**
Sets the remote control to operate a TV or cable box. This key does not change the input selector on the receiver.

There are some cases in which keys (or knobs) that have the same function on the receiver and on the remote control have different names. In the instructions of this manual, if the names of corresponding keys (or knobs) on the receiver and remote control are different, the name of the remote control key is indicated in parentheses.

- ➒ **AUDIO selector key**
Selects the audio inputs and sets the remote control to operate the respective KENWOOD audio component.
If you connect audio components from KENWOOD and other makers to the MD/TAPE or CD jacks, you can set the remote control to operate these components by registering the appropriate setup code at the respective input.
- ➓ **GUIDE key**
Use to activate the OSD menu functions of registered components.
- ➑ **VOLUME key**
Use to adjust the receiver volume.
- ➒ **MUTE key**
Use to temporarily mute the sound.
- ➓ **SOUND key**
Use to adjust the sound quality and ambience effects.
- ➑ **LISTEN MODE key**
Use to select the listening mode.
- ➓ **SETUP key**
Use to select the surround sound settings.

KRF-V5010/V6010/V7010/VR-205/206/207/255/257

DISASSEMBLY FOR REPAIR

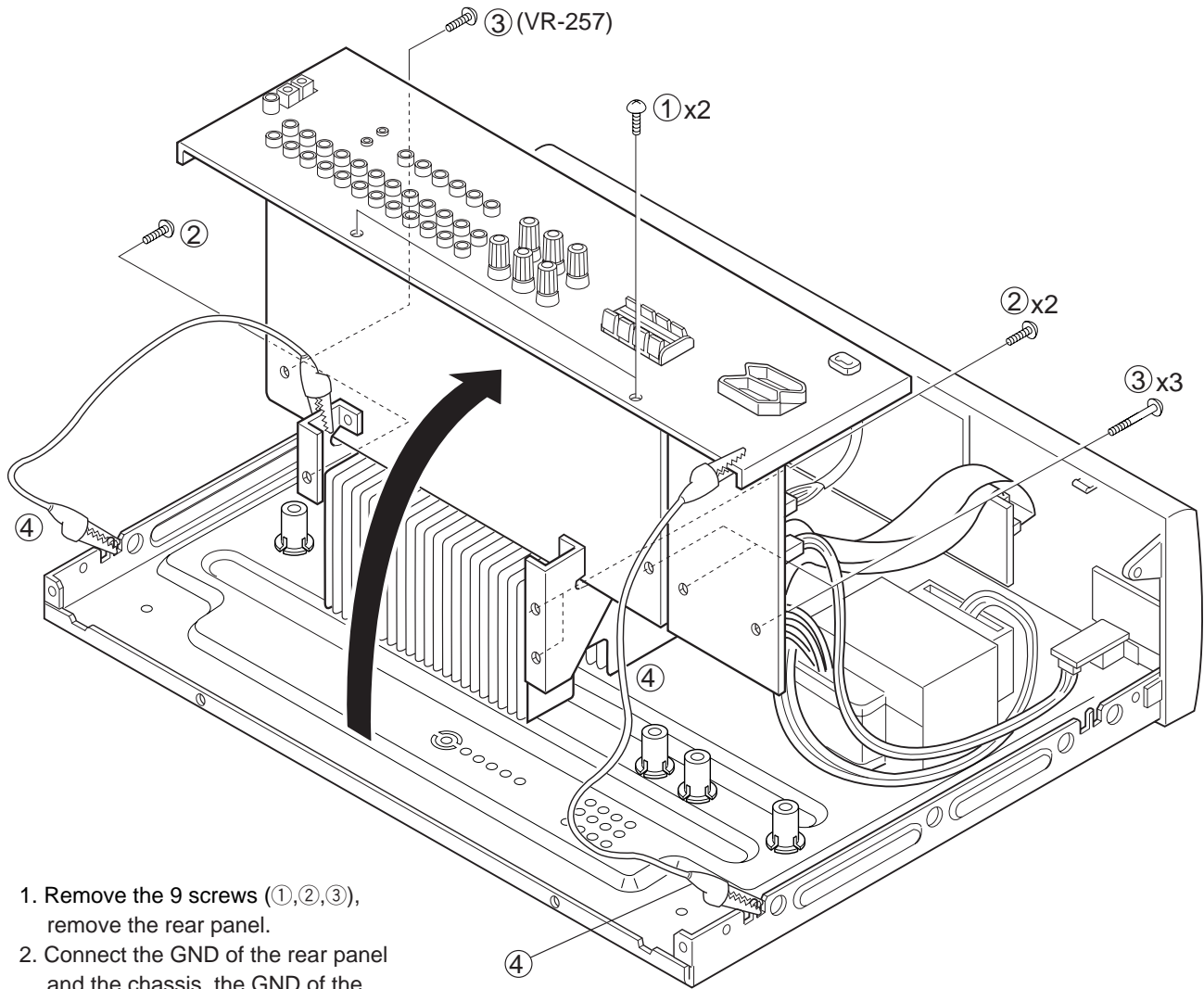

1. Remove the 9 screws (①,②,③), remove the rear panel.
2. Connect the GND of the rear panel and the chassis, the GND of the mounting hardware and the chassis with 2 alligators clip (④)

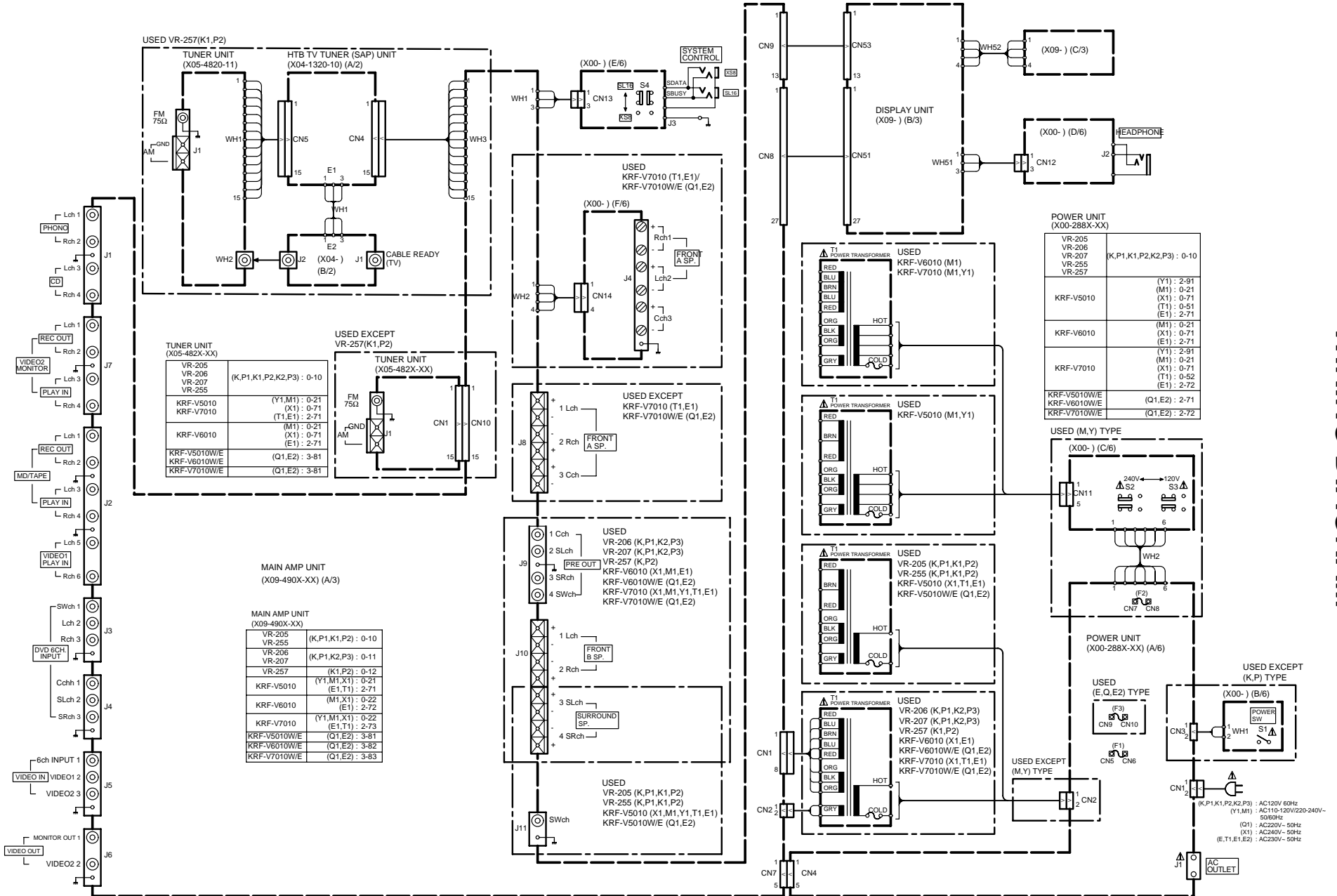

VR-205/206/207/255/257 (K)
 KRF-V5010/V5010E/5010W/V6010/V6010E/V6010W/V7010/V7010E/V7010W (E)

KRF-V5010/V6010/V7010/VR-205/206/207/255/257 BLOCK DIAGRAM

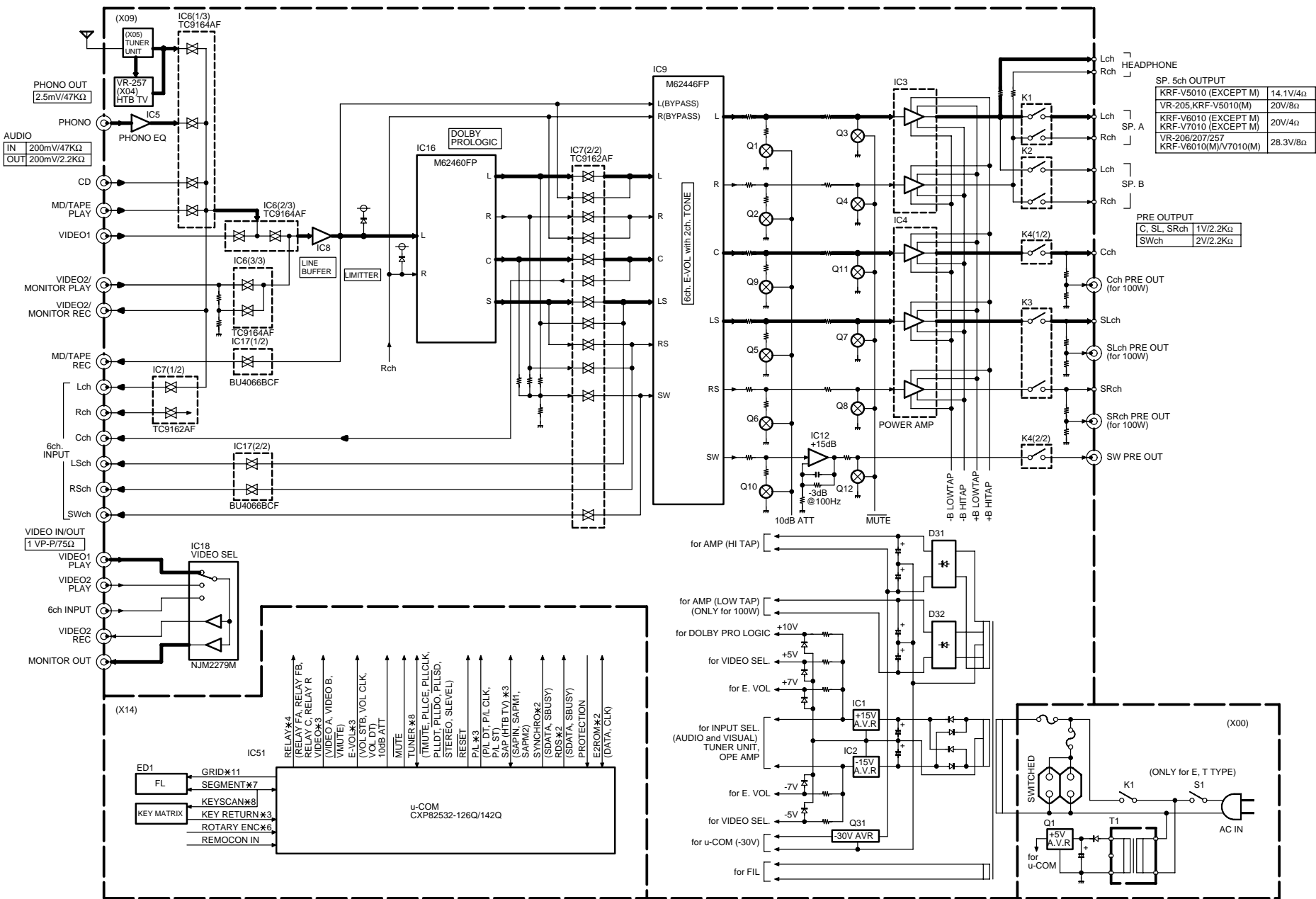

KRF-V5010/V6010/V7010/VR-205/206/207/255/257

CIRCUIT DESCRIPTION

1. BACK UP DATA AND INITIAL STATE

1-1 BACK UP

(1) AMP

- POWER.....STAND BY
- INPUT SELECTORTUNER
- SELECTOR FRESETNONE
- VIDEO OUTPUT.....VIDEO1
- SPEAKER A RELAYON
- SPEAKER B RELAYOFF
- VOLUME LEVEL-78dB
- BASS LEVEL.....0dB
- TREBLE LEVEL0dB
- INPUT LEVEL.....0dB
- BASS BOOSTOFF
- SOURCE DIRECTOFF
- SUB WOOFERYES
- MONITOR.....OFF
- SL16/XS8SL16
- DIMMER LEVEL.....LIGHT

(2) SURROUND

- LISTEN MODESTEREO
- INPUT MODEDIGITAL AUTO
- CENTER SPEAKER.....NORMAL
- SURROUND SPEAKER....YES
- DISTANCEFch 3.0m/10ft
Cch 3.0m/10ft
Sch 3.0m/10ft
- LEFT LEVEL.....0dB
- RIGHT LEVEL0dB

- CENTER LEVEL.....0dB
- REAR (LS, RS) LEVEL.....0dB
- SUB WOOFER LEVEL.....0dB
- MID NIGHTOFF

(3) TUNER

- BAND.....FM(EXCEPT VR-257)
TV (VR-257)
- FRESET CHANNEL"- -"
- FREQUENCYMINIMUM FREQUENCY
J1FM : 76.00MHz
AM : 531kHz
K1FM : 87.50MHz
AM : 530kHz
E1/E3.....FM : 87.50MHz
AM : 531kHz
Q1FM : 65.00MHz
AM : 531kHz
VR-257.....TV : 3ch
- SAP MODE.....STEREO (VR-257)
- AUTO/MANUAL.....AUTO
- DISPLAY MODE.....FREQUENCY
- EON THRUST
RECEIVING MODEOFF
- M TYPE SETTING
MODE (K2/E1).....E1

1-2 INITIAL SETTING

The initial setting is performed when the AC power cord is plugged into the AC power wall outlet while pressing the power (STANDBY) key.

2. DIFFERENCE POINT OF MODEL (VR-209/207)

Model		VR-205/206 KRF-V5010/6010	VR-207/255/257 KRF-V7010	VR-208/209 KRF-V8010D
Function				
REMOCON		NORMAL REMOTE RC-R0407 K, P, M, C, X, Y RC-R0307 E, T, Q	PRESET REMOTE RC-R0607 K, P, M, C, Y RC-R0507 E, T, Q, X	PRESET REMOTE RC-R0607 K, P, M, C, Y
SELECTOR	AUDIO	TUNER CD TAPE/MD PHONO	TUNER CD TAPE/MD PHONO	TUNER CD TAPE/MD PHONO
	VISUAL & AUDIO	VIDEO1 VIDEO2/MONITOR DVD 6ch INPUT	VIDEO1 VIDEO2/MONITOR DVD 6ch INPUT	VIDEO1 VIDEO2 VIDEO3
MONITOR	FUNCTION	VIDEO2/MONITOR	VIDEO2/MONITOR	MONITOR
	ON LEVEL	2 step (0/-6)	2 step (0/-6)	3 step (0/-3/-6)
SPEAKER		SP.A/SP.B (206) SP.1 stage (205/255)	SP.A/SP.B	SP.A/SP.B
DIGITAL AUTO		X	X	O
DOLBY DIGITAL		X	X	O
INPUT MODE (VIDEO2/ VIDEO3)		X	X	DIGITAL AUTO/ DIGITAL MANUAL/ ANALOG
LIVE, HALL		O	O	X
SOUND LEVEL		Sch	Sch	RSch/LSch
TUNER	TV & SAP	X	VR257	X
	RDS	E, T, Q	E, T, Q	X

CIRCUIT DESCRIPTION

FUNCTION DIODE MATRIX (X14-)

Model Function	VR-205/255 KRF-V5010	VR-206/207 KRF-V6010/V7010	VR-257	VR-209 KRF-V8010
DOLBY DIGITAL	X	X	X	D503
SPEAKER A only	D522	X	X	X
TV & SAP	X	X	D506	X

3. DESTINATION LIST OF TUNER

• TUNER

Destination	TUNER type	BAND	Receiving frequency range	Channel space	IF	PLL reference frequency	Diode SW			
							DSW3	DSW2	DSW1	DSW0
							D507	D505	D504	D510
K, P, R	K1 1700	FM	87.5MHz~108.0MHz	100kHz	+10.7MHz	25kHz	0	0	0	0
		AM	530kHz~1700kHz	10kHz	+450kHz	10kHz				
Y, M, I, C, V, E, X, H	E1	FM	87.5MHz~108.0MHz	50kHz	+10.7MHz	25kHz	0	0	1	1
		AM	531kHz~1602kHz	9kHz	+450kHz	9kHz				
T	E2 LW	FM	87.5MHz~108.0MHz	50kHz	+10.7MHz	25kHz	0	1	0	0
		MW	531kHz~1602kHz	9kHz	+450kHz	9kHz				
		LW	153kHz~279kHz	9kHz	+450kHz	9kHz				
E	E3 RDS	FM	87.5MHz~108.0MHz	50kHz	+10.7MHz	25kHz	0	1	0	1
		AM	531kHz~1602kHz	9kHz	+450kHz	9kHz				
Q	Q1 RDS	FML	65.0MHz~74.0MHz	10kHz	+10.7MHz	5kHz	1	0	1	1
		FMH	87.5MHz~108.0MHz	50kHz	+10.7MHz	5kHz				
		AM	531kHz~1602kHz	9kHz	+450kHz	9kHz				

※ 0 : NONE DIODE, 1: ADD DIODE

3-1 Channel Space Selector in Broadcasting setting

1. Push the BAND key for 2 seconds in the standby mode.
2. Display shows "F100/A10kHz" or "F50/A9kHz" blinkingly for 5 seconds.
3. Turn the VOLUME knob (Encoder) to choose your channel space.
4. Push the BAND key to memorize the channel space to E2P ROM.

Note : Channel space will be set by the data from E2P ROM if reconnect the power cord..

Channel space will be set by the destination data from E2P ROM if backup data damaged.

4. TEST MODE

4-1 SETTING

Turn the power ON while pressing the [BAND] key.

4-2 CANCEL

Unplug the AC power cord from an AC power wall outlet.

4-3 STARTING ACTIVE CONTENTS

- ① The power on state is entered whenever the power is turned on while pressing the [BAND] key. All functions are then initialized and activated in the all-lighting mode.
- ③ All lighting mode is canceled when any main unit's keys are pressed. The normal display obtained when the selector is set to TUNER then appears.

③ E2P ROM check (E, T, Q, M, V type)

Check the reading data and the writing data of the E2P ROM after setting the test mode.

Display shows blank if the reading and writing data is the same. Display shows "□" if the different.

Data (FM 50kHz, AM 9kHz, De-emphasis 50us) will be written to E2P ROM if the unit for M and V type.

4-4 ACTIVE CONTENTS

- ① The mute control is not activated when the mode is switched.
- ② The test mode will be terminated by plugging it off the power source or by initializing it, when all the settings will be initialized.
- ③ During the test mode, it can be operated in a special manner that is different from an ordinary operation by using the keys on the remote control or the main body, specifically as shown in the following table (5. contents).
- ④ Channel space will be no change if set channel space in the reset mode.

4-5 CONTENTS

TUNER (E, T, Q, RDS ONLY)

OPERATION KEY	FUNCTION	FL DISPLAY	Remarks
PTY	• S LEVEL • RF ATT	(EXP.)	(1) (2)↔(3) CYCLIC
		(1) (S LEVEL), (RF ATT) OFF	
		(2) (S LEVEL), (RF ATT) ON	
DISPLAY	P. CALL UP	P. CALL FREQUENCY	
BASS BOOST	P. CALL DOWN		

CIRCUIT DESCRIPTION

EXCEPT TUNER (BELOW ※ : TONE, CH. LEVEL is selected SOUND key.)

OPERATION KEY	INPUT LEVEL	FUNCTION	FL DISPLAY
※ BAND	-6dB	BASS, TREBLE each CH.	-10dB -89dB
※ AUTO	-3dB	BASS, TREBLE each CH.	+10dB 0dB
※ MEMORY	0dB	BASS, TREBLE each CH.	0dB -78dB
P. CALL ∨	—	MUTE	ON OFF
P. CALL ∧	—	CH. DELAY TIME	DMAX DMIN

5. Microprocessor periphery diagram

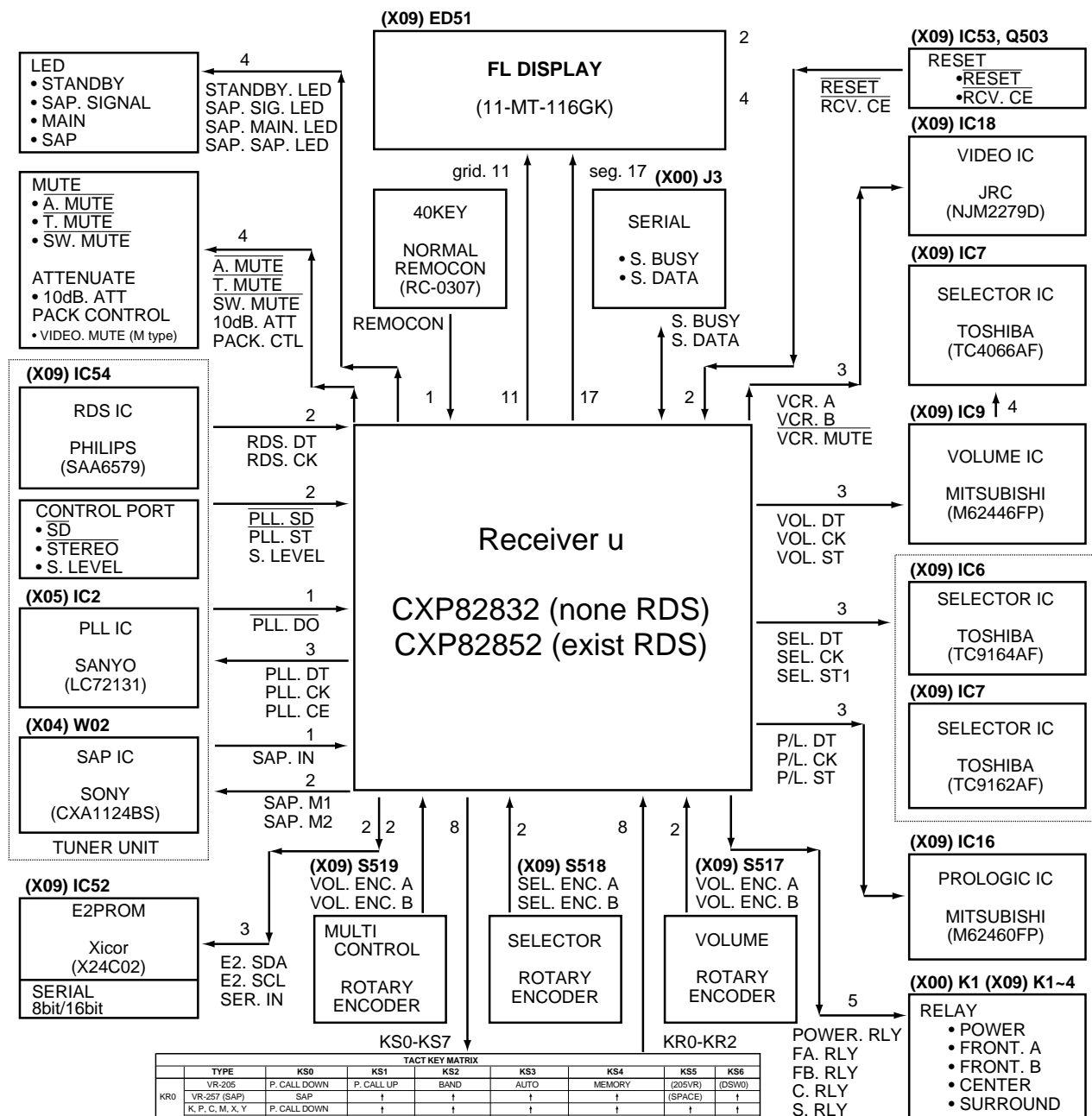

TYPE	TACT KEY MATRIX							
	KS0	KS1	KS2	KS3	KS4	KS5	KS6	
KR0	VR-205 (SAP)	P. CALL DOWN	P. CALL UP	BAND	AUTO	MEMORY	(205/VR) (DSW0)	
	K, P, C, M, X, Y	SAP						
	E, T, Q (RDS)	P. CALL DOWN	T. NEWS	DISPLAY				
KR1	VR-205	ON/STANDBY	DIMMER	SOUND	LISTEN MODE	SETUP	(SPACE) (DSW1)	
	VR-257 (SAP)							
	K, P, C, M, X, Y		PTY					
KR2	VR-205	SPEAKER	MUTE	BASS BOOST	MONITOR	SOURCE DIRECT	(SPACE) (DSW2)	
	VR-257 (SAP)	SPEAKER A	SPEAKER B					
	K, P, C, M, X, Y							
E, T, Q (RDS)								

CIRCUIT DESCRIPTION

6. Microprocessor pin description

Pin No.	Pin name	I/O	Description	Active
1, 2	G10~G11	O	FL (11-MT-116GK) GRID 10, 11	
3	–	–	Unused	
4	RDS. CK	I	RDS IC (SAA6579) clock input control	
5	RDS. DT	I	RDS IC (SAA6579) data input control	
6	–	I	Unused	
7	VOL. ENC. A	I	Volume encoder A (CW) signal	
8	REMOCON	I	Remote control	
9	VOL. ENC. B	I	Volume encoder B (CCW) signal	
10, 11	–	O	Unused	
12~14	KR0 - KR2	I	Key return 0~2	
15	PROTECT	I	Protection detect	H : PROTECT
16	S. DATA	I/O	Serial communication data	
17	S. BUSY	I/O	Serial communication busy	
18	E2. DT	I/O	E2PROM data	
19	E2. CLK	O	E2PROM clock	
20	SEL. ENC.A	I	Selector encoder A (CW)	
21	SEL. ENC.B	I	Selector encoder B (CCW)	
22	MULTI. ENC.A	I	Multi control encoder A (CW)	
23	MULTI. ENC.B	I	Multi control encoder B (CCW)	
24	SER.IN	I	Serial communication 8bit/16bit changeover	L : 8bit H : 16bit
25	SAP.M1	O	SAP IC (CXA1124BS) M1 control	
26	SAP.IN	I	SAP IC (CXA1124BS) SAP signal control	L : sap
27	SAP.M2	O	SAP IC (CXA1124BS) M2 control	
28	Vdd	–	Analog power supply (+5V)	
29	S.LEVEL	I	Signal level A/D input	
30	P/L. DT	O	PROLOGIC IC (M62460FP) strobe	L : active
31	P/L. CK	O	PROLOGIC IC (M62460FP) clock	L : active
32	P/L. ST	O	PROLOGIC IC (M62460FP) data	
33	PLL. DO	I	PLL IC DO signal	
34	PLL. ST	I	TUNER STEREO signal detect	L : STEREO
35	PLL. SD	I	TUNER SD signal detect	L : TUNED
36	RCV. CE	I	RECEIVER CHIP ENABLE signal	L : ENABLE
37	AVss	–	Analog GND	
38	RESET	I	u-Com reset	
39	EXTAL	I	Main clock (8MHz)	
40	XTAL	–	Main clock (8MHz)	
41	Vss	–	u-Com GND	
42	TX	–	Unused	
43	TEX	I	GND	
44	Vdd	–	+5V	
45	Vfdp	–	-33V	
46	SEL. ST1	O	TC9162AF/63AF/64AF strobe1	H : LATCH
47	PLL. DT	O	PLL IC DATA signal output	
48	PLL. CK	O	PLL IC CLOCK signal output	
49	PLL. CE	O	PLL IC CE signal output	
50	T. MUTE	O	Tuner mute control	L : MUTE ON
51	A. MUTE	O	Output mute control	L : MUTE ON
52	SW. MUTE	O	SUB WOOFER mute control	L : MUTE ON
53	10dB. ATT	O	VOLUME 10dB ATTENUATOR control	L : ATT ON
54	VOL. DT	O	VOLUME IC (M62446SP) data control	
55	VOL. CK	O	VOLUME IC (M62446SP) clock control	H : active
56	VOL. ST	O	VOLUME IC (M62446SP) strobe control	H : active
57	VCR. MUTE	O	VIDEO IC (NJU2279D) cont2/4 control	L : mute on
58	VCR. A	O	VIDEO IC (NJU2279D) cont1 control	H/L : static
59	VCR. B	O	VIDEO IC (NJU2279D) cont3 control	H/L : static
60	FA. RLY	O	Front SP. A relay control	H : relay ON
61	FB. RLY	O	Front SP. B relay control	H : relay ON
62	C. RLY	O	Center SP. relay control	H : relay ON
63	S. RLY	O	Surround SP. relay control	H : relay ON

CIRCUIT DESCRIPTION

Pin No.	Pin name	I/O	Description	Active
64	POWER. RLY	O	Power relay control	H : relay ON
65	STANDBY. LED	O	STANDBY LED control	H : relay ON L : LED ON
66, 67	-	O	Unused	
68	SAP. LED1	O	SAP LED1	L : LED ON
69	SAP. LED2	O	SAP LED2	L : LED ON
70	SAP. LED3	O	SAP LED3	L : LED ON
71	PACK_CTL	O	VIDEO MUTE (M type)	L : MUTE ON
72	-	O	Unused	
73	EMPHASIS	O	TUNER EMPHASIS (M type)	H : 100 /10k L : 50k/9k
74~81	P1/KS7~P8/KS0	O	FL (11-MT-116GK) SEG 1~8 & KEY SCAN 7~0	
82~88	P9~P15	O	FL (11-MT-116GK) SEG 9~15	
89	Vdd	O	u-Com +5V power supply	
90, 91	P16, P17	O	FL (11-MT-116GK) SEG 16, 17	
92~100	G1~G9	O	FL (11-MT-116GK) GRID 1~9	

7. Control list for the switch and the port

(1) Input selector (BU4066BCF)

X09, IC17			
	IC PORT	⑩, ⑪	③, ④
	Surround	⑧, ⑨	②, ①
No.	Input Selector	MD/TAPE REC	LSch/RSch
1	MD/TAPE	X	X
2	6ch INPUT	O	O
3	OTHERS	O	X

(0 : SW OFF/1 : SW ON)

(2) Electric volume (M62446FP)

X09, IC9					
	IC PORT	⑰	⑱	⑲	⑳
	Surround	out1	out2	out3	out4
No.	Input Selector	LSch/RSch	LSch/RSch	----	----
1	MD/TAPE	X	X	X	X
2	6ch INPUT	O	O	X	X
3	OTHERS	X	X	X	X

(0 : SW OFF/1 : SW ON)

(3) Input selector (TC9164AF)

X09, IC6													
	IC CHANNEL	Lch	Rch	Lch	Rch	Lch	Rch	Lch	Rch	Lch	Rch	Lch	Rch
	IC PORT	S1	S2	S3	S4	S5	S6	S7	S8				
No.	Input Selector	TUNER	PHONO	CD	MD/TAPE/PLAY	VIDEO1 PLAY	VIDEO1 REC	VIDEO2	MONITOR				
1	PHONO	X	O	X	X	X	O	X	X				
2	CD	X	X	O	X	X	O	X	X				
3	VIDEO2	X	X	X	X	X	X	O	X				
4	MONITOR ON	now condition	now condition	now condition	now condition	now condition	X	O(0dB selector)	O(-6dB selector)				
5	TAPE/MD	X	X	X	O	X	O	X	X				
6	VIDEO1	X	X	X	X	O	O	X	X				
7	TUNER	O	X	X	X	X	O	X	X				
8	6ch INPUT	X	X	X	X	X	O	X	X				

(0 : SW OFF/1 : SW ON)

(4)Surr. Mode selector(TC9162AF)

X09, IC7														
	IC CHANNEL	Lch	Rch	Lch	Rch	Lch	Rch	Lch	Rch	Lch	Rch	Lch	Rch	---
	IC PORT	② S1 ⑲	③ S2 ⑳	⑤ S3 ㉑	⑥ S4 ㉒	⑧ S5 ㉓	⑨ S6 ㉔	⑪ S7 ㉕						
	Surround	prologic	6ch input	prologic	6ch input	prologic	6ch input	6ch input						
No.	Speaker	FLch	FRch	FLch	FRch	SWch	Cch	SWch	Cch	LSch	RSch	LSch	RSch	---
1	DOLBY PROLOGIC	O		X		O	O	X		O		X		X
2	DOLBY 3STEREO	O		X		O	O	X		X		X		X
3	DSP LOGIC	O (2ch selector)	O (4ch selector)	O	O	X		O		O (4ch selector)		X		X
4	STEREO	X		O		O	X	X		X		X		X
5	SOURCE DIRECT	X		X		O	X	X		X		X		X
6	6ch INPUT	O		O		X	X	O		X		X		O

(0 : SW OFF/1 : SW ON)

8. Contents of the speaker setting

(VR-207 series only)

SUB WOOFER	YES/NO					
	LARGE		NORMAL		NO	
CENTER SP.	YES	NO	YES	NO	YES	NO
SURROUND SP.	YES	NO	YES	NO	YES	NO
CENTER MODE (PRO LOGIC)	WIDEBAND	PHANTOM	NORMAL	PHANTOM	PHANTOM	PHANTOM

ADJUSTMENT

No.	ITEM	INPUT SETTINGS	OUTPUT SETTINGS	TUNER SETTINGS	ALIGNMENT POINTS	ALIGN FOR	FIG.
FM SECTION : EXCEPT E,T,Q type		SELECTOR : FM					
1	DISTORTION (STEREO)	(C) 98.0MHz 1kHz, ±68.25kHz dev. Selector : L or R Pilot : ±6.75kHz dev. 70dBf (ANT. input)	(B)	98.0MHz	IFT (TUNER UNIT: A1)	Minimum distortion (L or R)	(a)
2	TUNING LEVEL	(A) 98.0MHz MONO 1kHz, ±75kHz dev. 25dBf (ANT. input)	(B)	MONO 98.0MHz	VR1 (TUNER UNIT)	Adjust VR1 and stop at the point where ED51 (TUNED) goes on.	(a)
TV SECTION : VR-257 (X04-) only		SELECTOR : TV					
1	SEPARATION	(D) TV 3ch : 65.75MHz or TV 4ch : 71.75MHz STEREO AF : 3kHz, NR ON 70dBf.	(B)	TV 3ch or TV 4ch	VR1 (HTB TV UNIT)	Minimum crosstalk	(a)
FM SECTION : E,T,Q type only		SELECTOR : FM ※Adjust NO.1 and NO.2 repeat.					
1	DISCRIMINATOR	(A) 98.0MHz 1kHz, ±40kHz dev. 70dBf (ANT. input)	Connect a DC voltmeter between CN2 ① and CN2 ② (TUNER UNIT)	MONO 98.0MHz	L4 (TUNER UNIT)	0V	(a)
2	DISTORTION (MONO)	(A) 98.0MHz 1kHz, ±40kHz dev. MONO 70dBf (ANT. input)	(B)	MONO 98.0MHz	L5 (TUNER UNIT)	Minimum distortion	(a)
3	DISTORTION (STEREO)	(C) 98.0MHz 1kHz, ±40kHz dev. Selector : L or R Pilot : ±6kHz dev. 70dBf (ANT. input)	(B)	AUTO 98.0MHz	IFT (TUNER UNIT : A1)	Minimum distortion (L or R)	(a)
4	TUNING LEVEL	(A) 98.0MHz MONO 1kHz, ±40kHz dev. 25dBf (ANT. input)	(B)	MONO 98.0MHz	VR1 (TUNER UNIT)	Adjust VR1 and stop at the point where ED51 (TUNED) goes on.	(a)

SYSTEM CONNECTIONS

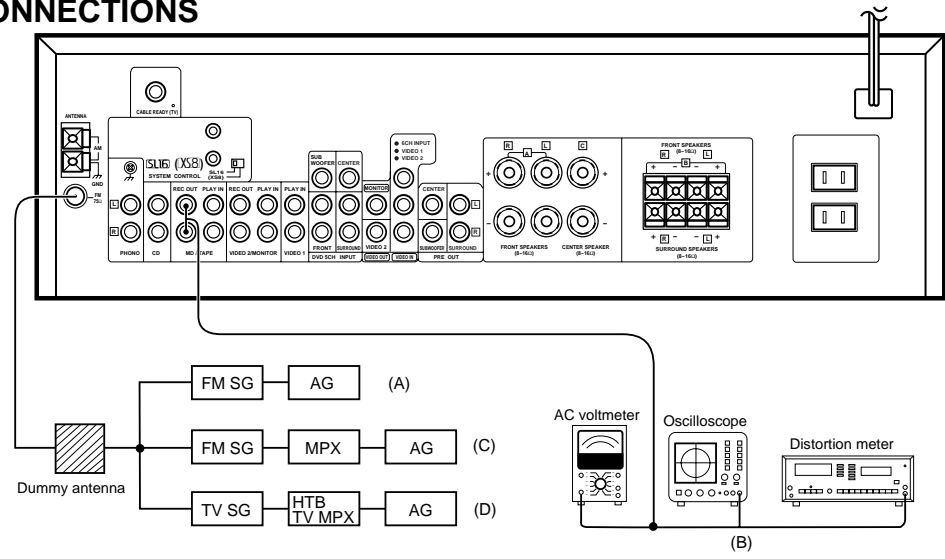

PC BOARD (Component side view)

1 TUNER UNIT

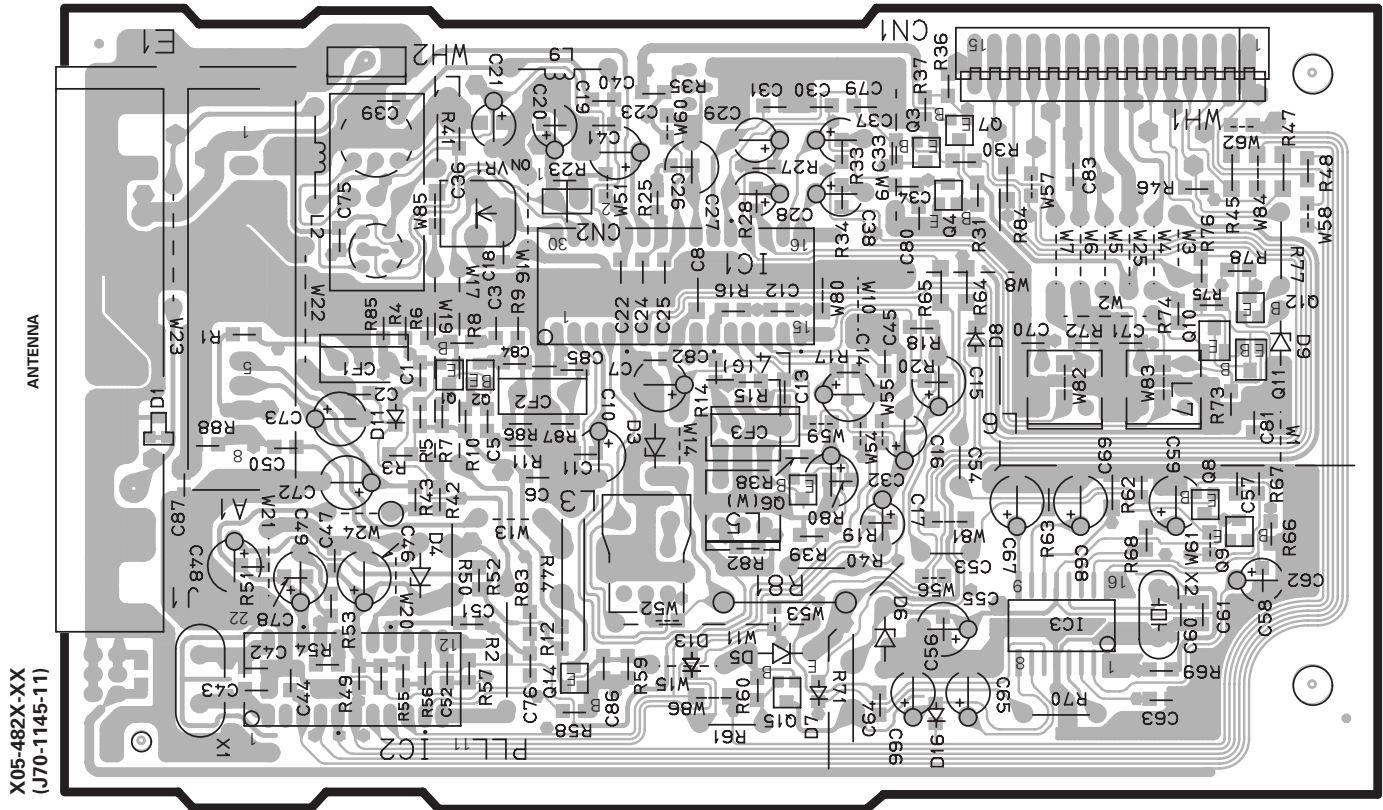

4 POWER SUPPLY UNIT

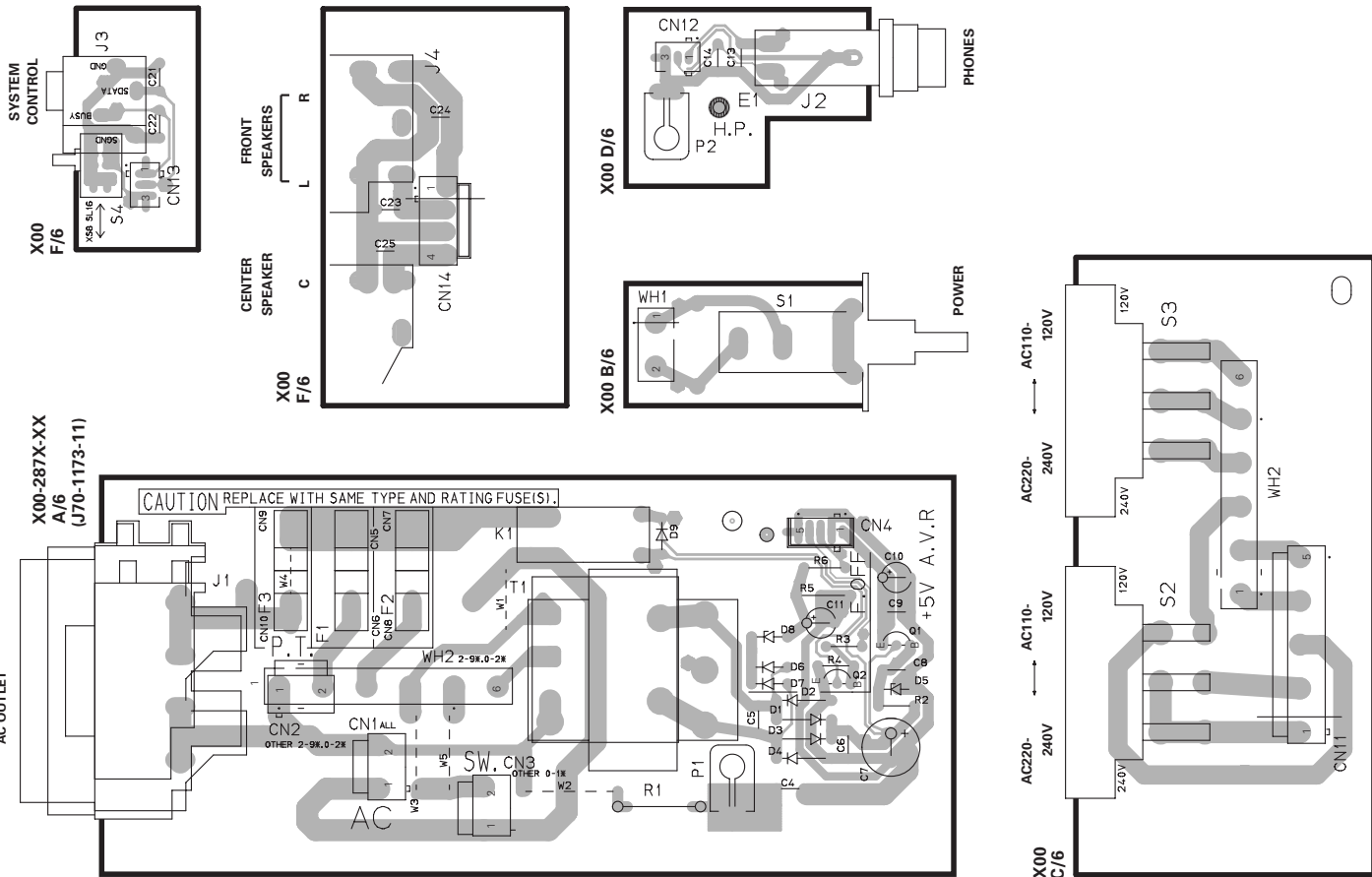

PC BOARD(Component side view)

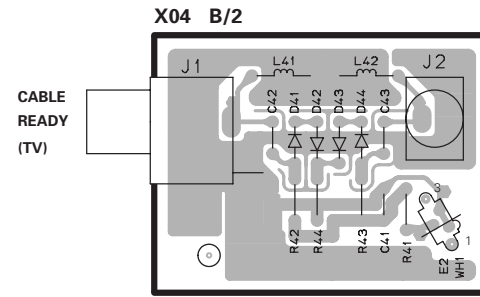

X04-1320-10 A/2 (J70-1165-01)

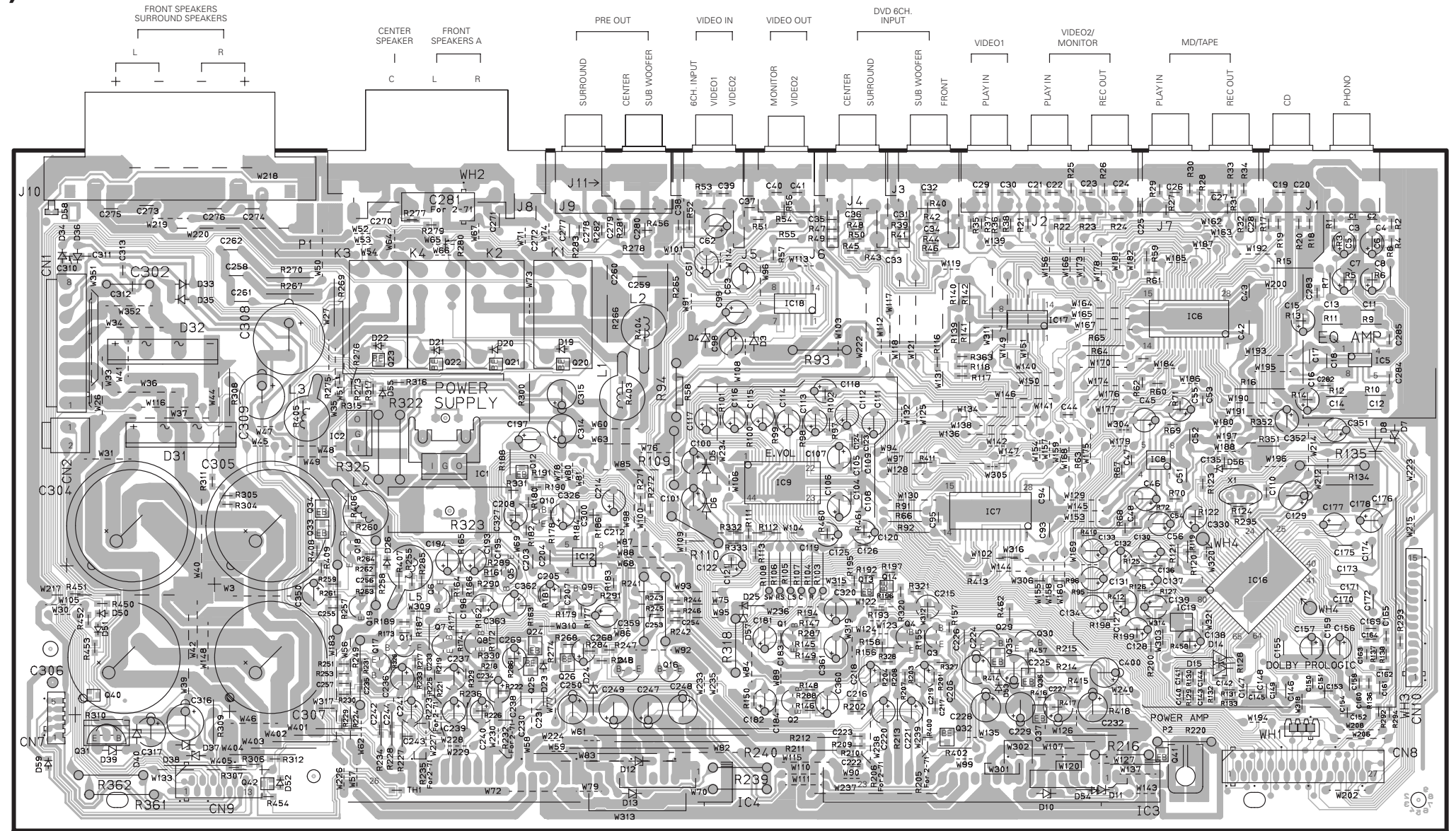
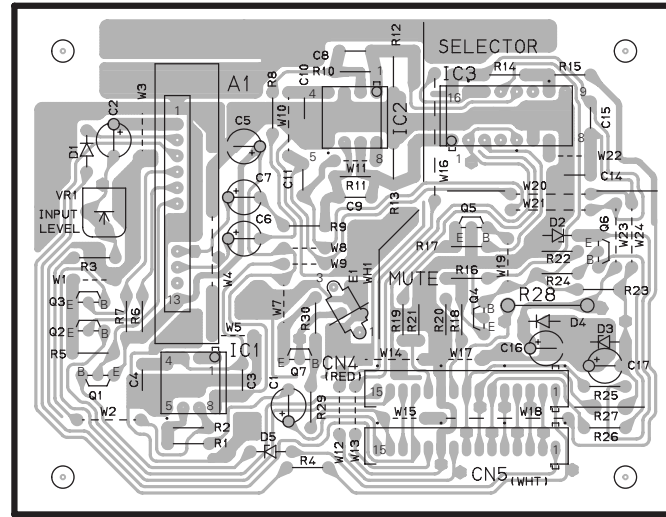

X09-490X-XX A/3 (J70-1172-21)

X09 C/3

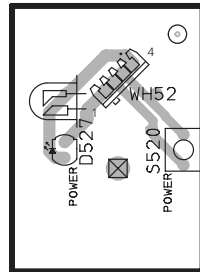

X09 B/3

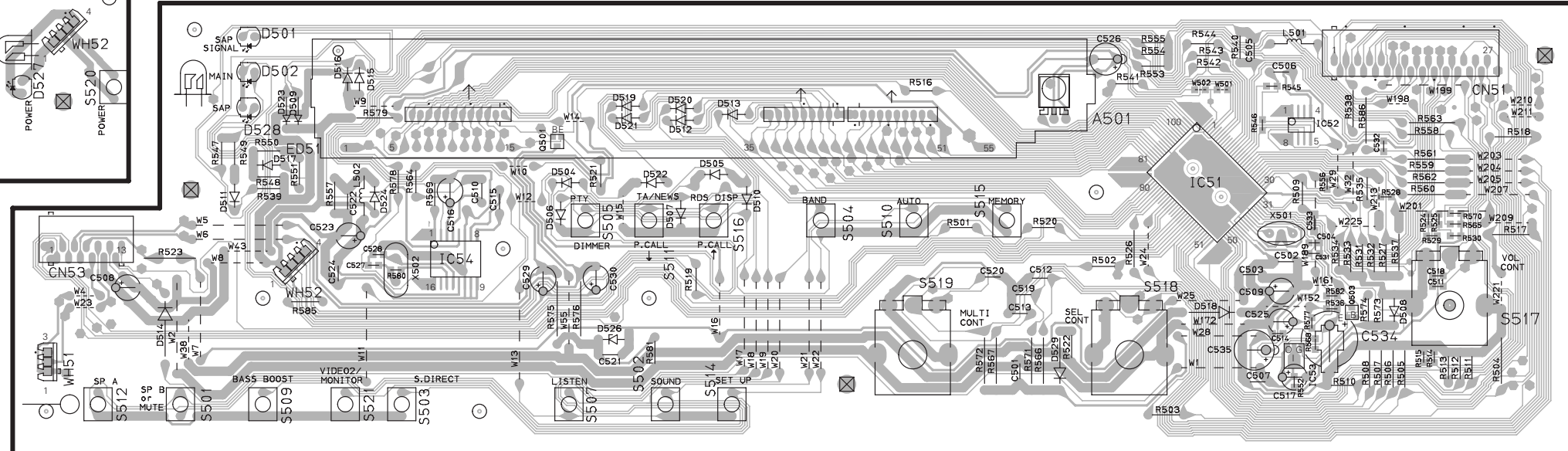

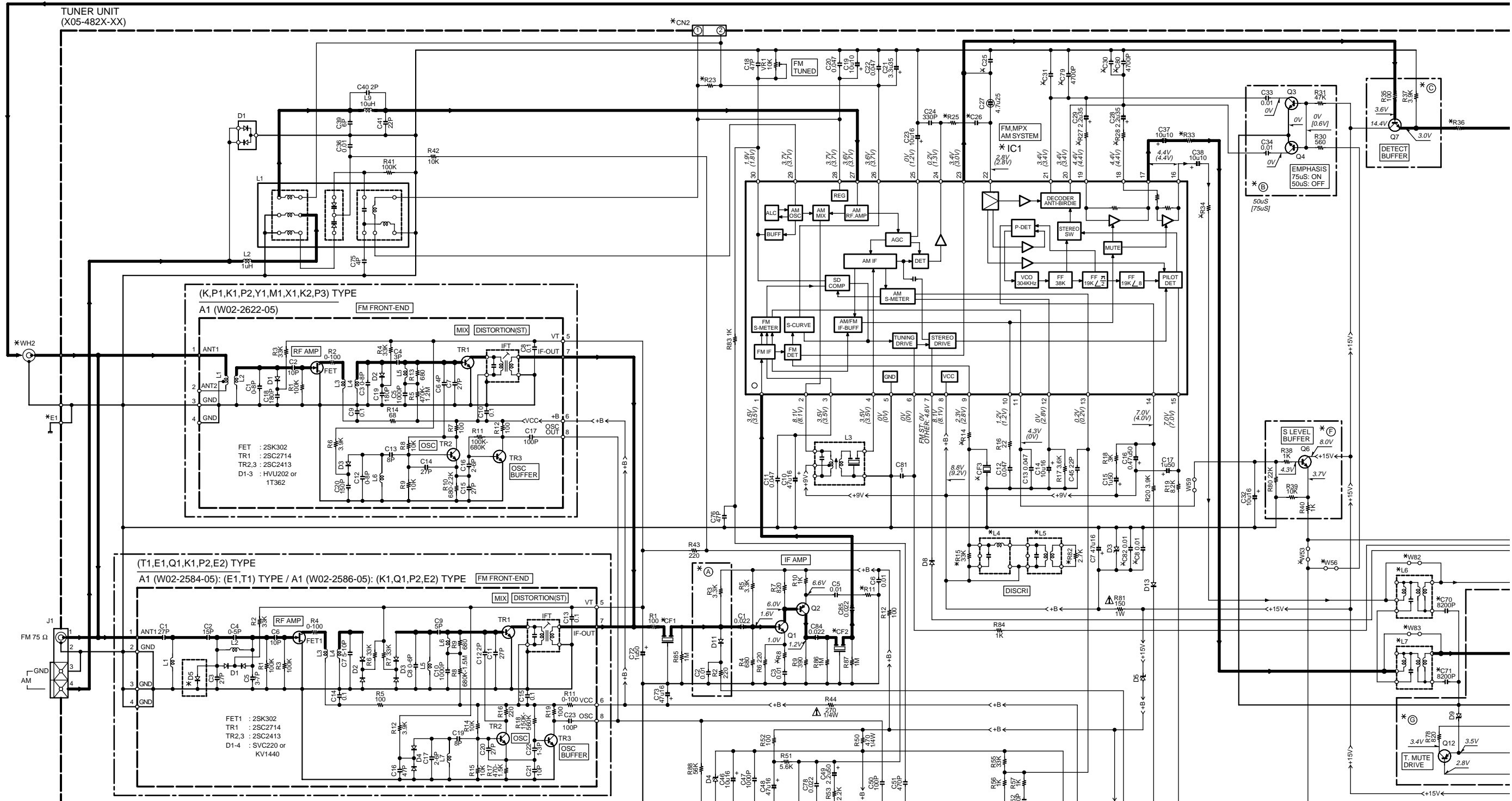

KRF-V5010/V7010 (X05-482X-XX)

DESTINATION	UNIT No.	E1	CF1.2	CF3	R8	R11	R14	R15	R23	R25	R27	R28	R33	R34	R36	R72	C8	C25	C26	C30	C70.71	L4-7	CN1	CN2	IC1	A1	Ⓐ	Ⓑ	Ⓒ	Ⓓ	Ⓔ	WH1.2	WS3.56	WS6	WS8	WS8.2	
GENERAL MARKET	M1	0-21	F10-1108-04	L72-0531	YES	33	33	270	NO	3.3K	18K	8.2K	1K	1K	NO	8.2K	YES	390P	0.022	0.022	NO	NO	YES	NO	LA1838	W02-2622	NO	YES	NO	NO	NO	YES	YES	NO	NO	NO	
AUSTRALIA	X1	0-71	F10-1108-04	L72-0531	YES	33	33	270	NO	3.3K	18K	8.2K	1K	1K	NO	8.2K	YES	390P	0.022	0.022	NO	NO	YES	NO	LA1838	W02-2622	NO	YES	NO	NO	NO	YES	YES	NO	NO	NO	
U.K.	T1	2-71	F10-1109-04	L72-0536	NO	10	22	100	YES	15K	27K	4.3K	1K	1K	3.9K	NO	180P	0.018			YES	YES	YES	YES	LA1837	W02-2584	YES	NO	NO	NO	NO	NO	NO	NO	NO	NO	
EUROPE	E1																																				

KRF-V6010 (X05-482X-XX)

DESTINATION	UNIT No.	E1	CF1.2	CF3	R8	R11	R14	R15	R23	R25	R27	R28	R33	R34	R36	R72	C8	C25	C26	C30	C70.71	L4-7	CN1	CN2	IC1	A1	Ⓐ	Ⓑ	Ⓒ	Ⓓ	Ⓔ	WH1.2	WS3.56	WS6	WS8	WS8.2
GENERAL MARKET	M1	0-21	F10-1108-04	L72-0531	YES	33	33	270	NO	3.3K	18K	8.2K	1K	1K	NO	8.2K	YES	390P	0.022	0.022	NO	NO	YES	NO	LA1838	W02-2622	NO	YES	NO	NO	NO	YES	YES	NO	NO	NO
AUSTRALIA	X1	0-71	F10-1108-04	L72-0531	YES	33	33	270	NO	3.3K	18K	8.2K	1K	1K	NO	8.2K	YES	390P	0.022	0.022	NO	NO	YES	NO	LA1838	W02-2622	NO	YES	NO	NO	NO	YES	YES	NO	NO	NO
U.K.	T1	2-71	F10-1109-04	L72-0536	NO	10	22	100	YES	15K	27K	4.3K	1K	1K	3.9K	NO	180P	0.018			YES	YES	YES	YES	LA1837	W02-2584	YES	NO	NO	NO	NO	NO	NO	NO	NO	NO
EUROPE	E1																																			

VR-205/206/207/255 (X05-4820-10)

DESTINATION	UNIT No.	E1	CF1.2	CF3	R8	R11	R14	R15	R23	R25	R27	R28	R33	R34	R36	R72	C8	C25	C26	C30	C70.71	L4-7	CN1	CN2	IC1	A1	Ⓐ	Ⓑ	Ⓒ	Ⓓ	Ⓔ	WH1.2	WS3.56	WS6	WS8	WS8.2	
U.S.A.	K																																				
CANADA	P1																																				
U.S.A.	K1	0-10	F10-1108-04	L72-0596	YES	33	33	270	NO	3.3K	18K	8.2K	1K	1K	NO	8.2K	YES	390P	0.022	0.033	NO	NO	YES	NO	LA1838	W02-2622	NO	YES	NO	NO	NO	YES	YES	NO	NO	YES	
CANADA	P2																																				
U.S.A.	K2																																				
CANADA	P3																																				

VR-257 (X05-4820-11)

DESTINATION	UNIT No.	E1	CF1.2	CF3	R8	R11	R14	R15	R23	R25	R27	R28	R33	R34	R36	R72	C8	C25	C26	C30	C70.71	L4-7	CN1	CN2	IC1	A1	Ⓐ	Ⓑ	Ⓒ	Ⓓ	Ⓔ	WH1.2	WS3.56	WS6	WS8	WS8.2
U.S.A.	K1	0-11	F10-1108-04	L72-0531	YES	33	33	270	NO	3.3K	18K	8.2K	100	15K	YES	390P	0.022	0.033	NO	NO	YES	NO	YES	NO	LA1838	W02-2586	NO	YES	YES	YES	YES	YES	YES	YES	YES	
CANADA	P2																																			

KRF-V5010W/V6010W/V7010W (X05-4823-81)

DESTINATION	UNIT No.	E1	CF1.2	CF3	R8	R11	R14	R15	R23	R25	R27	R28	R33	R34	R36	R72	C8	C25	C26	C30	C70.71	L4-7	CN1	CN2	IC1	A1	Ⓐ	Ⓑ	Ⓒ	Ⓓ	Ⓔ	WH1.2	WS3.56	WS6	WS8	WS8.2
RUSSIA	Q1	3-81	F10-1109-04	L72-0536	NO	10	22	100	YES	15K	27K	4.3K	1K	1K	3.9K	NO	180P	0.018	0.022	0.022	YES	YES	YES	YES	LA1837	W02-2586	YES	NO	NO	NO	NO	NO	NO	NO	YES	

KRF-V5010E/V6010E/V7010E (X05-4823-81)

DESTINATION	UNIT No.	E1	CF1.2	CF3	R8	R11	R14	R15	R23	R25	R27	R28	R33	R34	R36	R72	C8	C25	C26	C30	C70.71	L4-7	CN1	CN2	IC1	A1	Ⓐ	Ⓑ	Ⓒ	Ⓓ	Ⓔ	WH1.2	WS3.56	WS6	WS8	WS8.2
EUROPE	E2	3-81	F10-1109-04	L72-0536	NO	10	22	100	YES	15K	27K	4.3K	1K	1K	3.9K	NO	180P	0.018	0.022	0.022	YES	YES	YES	YES	LA1837	W02-2586	YES	NO	NO	NO	NO	NO	NO	NO	YES	

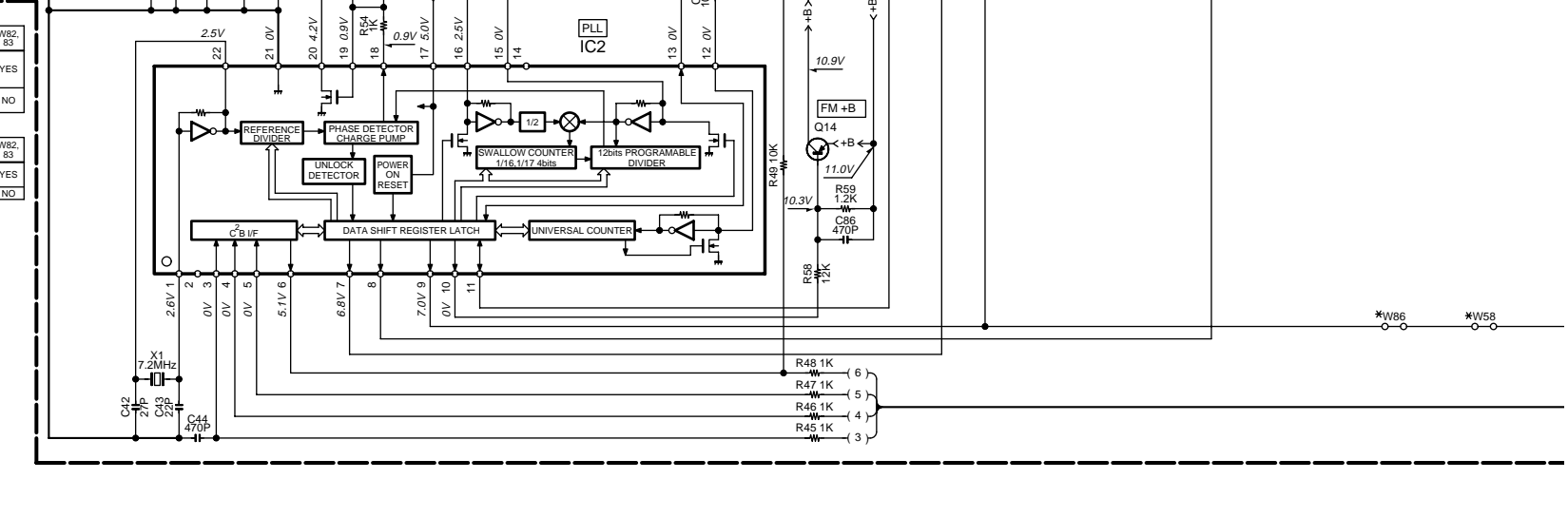

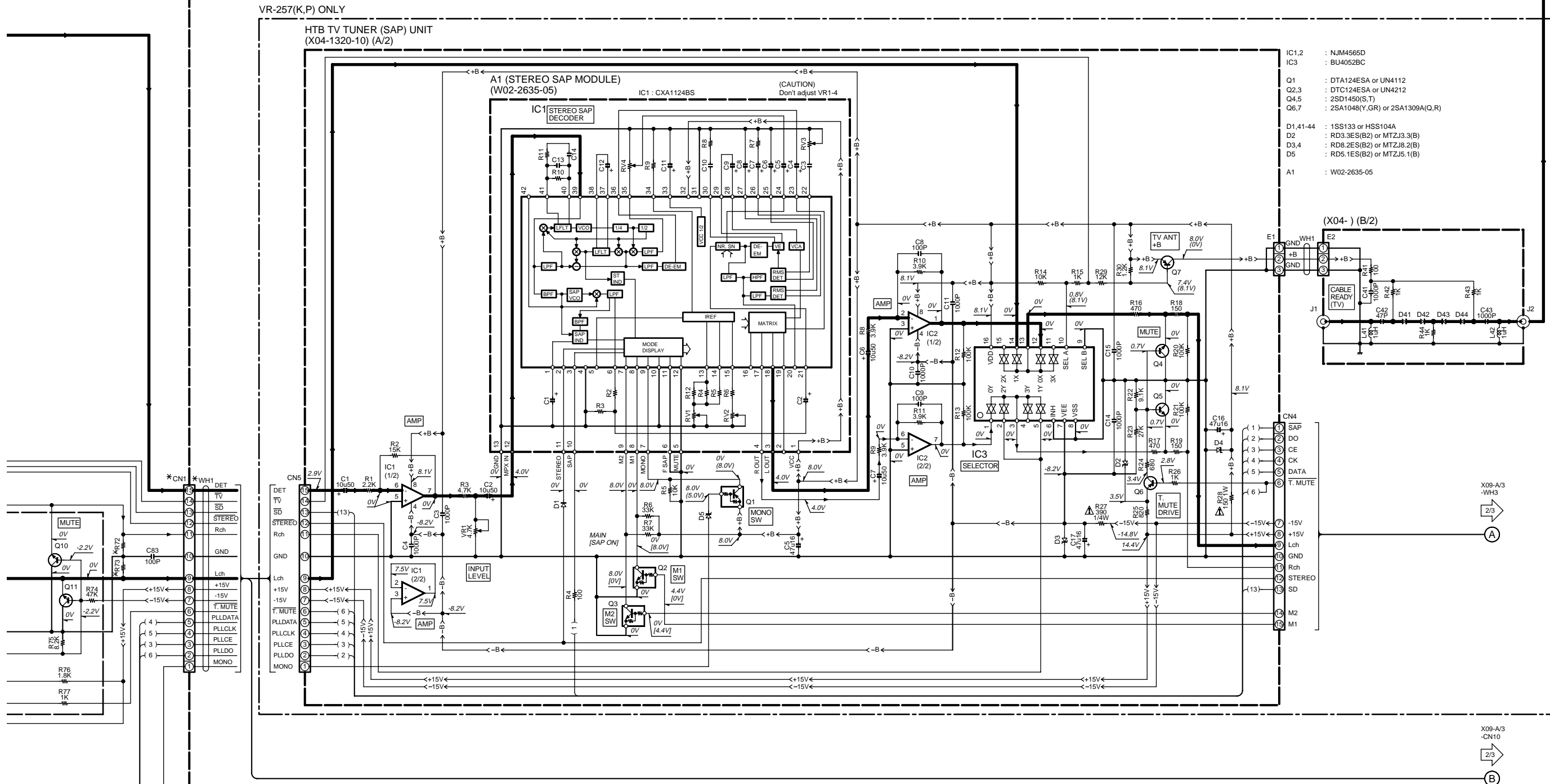

- IC1,2 : NJM4565D
- IC3 : BU4052BC
- Q1 : DTA124ESA or UN4112
- Q2,3 : DTC124ESA or UN4212
- Q4,5 : 2SD1450(S,T)
- Q6,7 : 2SA1048(Y,GR) or 2SA1309A(Q,R)
- D1,41-44 : 1SS133 or HSS104A
- D2 : RD3.3ES(B2) or MTZJ3.3(B)
- D3,4 : RD8.2ES(B2) or MTZJ8.2(B)
- D5 : RD5.1ES(B2) or MTZJ5.1(B)
- A1 : W02-2635-05

- IC1 : *
- IC2 : LC72131
- Q1,3,4,6,7 : 2SC4081(R,S) or 2SC4116(Y,GR)
- Q2,12,14 : 2SA1576A(R,S) or 2SA1586(Y,GR)
- Q10,11 : 2SD1757K
- D1 : DA204V or MA143A or 1SS302
- D3 : RD8.2ES(B2) or MTZJ8.2(B)
- D4 : RD5.1ES(B2) or MTZJ5.1(B)
- D5 : RD2.7ES(B2) or MTZJ2.7(B)
- D8,10,11,13 : MA111
- D9 : RD3.3ES(B2) or MTZJ3.3(B)
- A1 : *

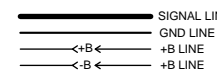

The DC voltage is an actual reading measured with a high impedance type voltmeter as the AM/FM signal generator is specified to the conditions as shown in the list below. The measurement value may vary depending on the measuring instruments used or on the product. The value shown in () is actual reading measured in the AM mode.

MODE	CARRIER	MODULATION		ANT INPUT
		FREQUENCY	DEVIATION	
FM	98MHz	1kHz	STEREO 67.5kHz 7.5kHz(Pilot)	60dB
AM	1000(999)kHz	400Hz	MONO 30% MOD	60dB

VR-205/206/207/255/257 (K) (1/3)
KRF-V5010/V6010/V7010/V5010W/V6010W/V7010W (E) (1/3)

CAUTION: For continued safety, replace safety critical components only with manufacturer's recommended parts (refer to parts list). Δ indicates safety critical components. For continued protection against risk of fire, replace only with same type and rating fuse(s). To reduce the risk of electric shock, leakage-current or resistance measurements shall be carried out (exposed parts are acceptably insulated from the supply circuit) before the appliance is returned to the customer.

KRF-V5010/V6010/V7010/VR-205/206/207/255/257

- IC1 : TA7815SB
- IC2 : TA79015SB
- IC3 : *
- IC4 : *
- IC5 : NJM4580ED
- IC6 : TC9164AF
- IC7 : TC9162AF
- IC8,12 : NJM4565MD
- IC9 : M62446FP
- IC16 : M62460AFP
- IC17 : BU4066BCF
- IC18 : NJM2279M
- IC19 : M5278L05M
- Q1-11 : 2SC2878(B)
- Q12,40,42 : 2SC4213(B)
- Q13,14 : 2SA1585(V,GR) or 2SA1611(M5,M6)
- Q15-19 : 2SC1845(F,E)
- Q20-23 : DTC123ZUA
- Q24,25,32-34,36,37 : 2SC3722K(R,S)
- Q26,35 : 2SA1255
- Q29 : 2SC2631(S,T)
- Q30 : 2SA1123(S,T)
- Q31 : *
- Q31 : DTC113JUA or UNS219
- Q41 : TH1 : PTH9C42BD471Q
- D3,4,7 : MTZJ5.1(B) or RD5.1ES(B2)
- D5,6 : MTZJ6.8(B) or RD6.8ES(B2)
- D8 : MTZJ11(B) or RD11ES(B2)
- D10,12,13 : MTZJ8.2(B) or RD8.2ES(B2)
- D11,56 : MTZJ7.5(B) or RD7.5ES(B2)
- D14,15 : MTZJ10(B) or RD10ES(B2)
- D19-23,26,50-55,59 : MA111
- D24 : MTZJ4.7(B) or RD4.7ES(B2)
- D25 : MTZJ3.3(B) or RD3.3ES(B2)
- D31,32 : D4SBL20UFQ3
- D33-36 : S5888B(TP85)
- D37,38 : MTZJ16(B) or RD16ES(B2)
- D39,40 : MTZJ18(B) or RD18ES(B2)

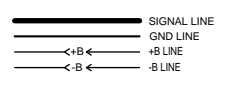

IC18 I/O TABLE

INPUT	⑩ MONITOR	⑪ VIDEO1 REC	⑫ V-A	⑬ V-B	⑭ MUTE
① VIDEO1		X	L	L	L
② VIDEO2			L	H	H
③ 6ch INPUT			H	H	H

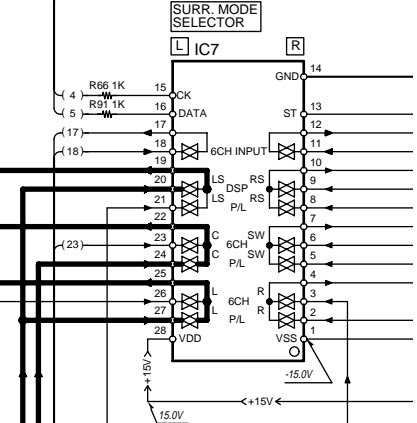
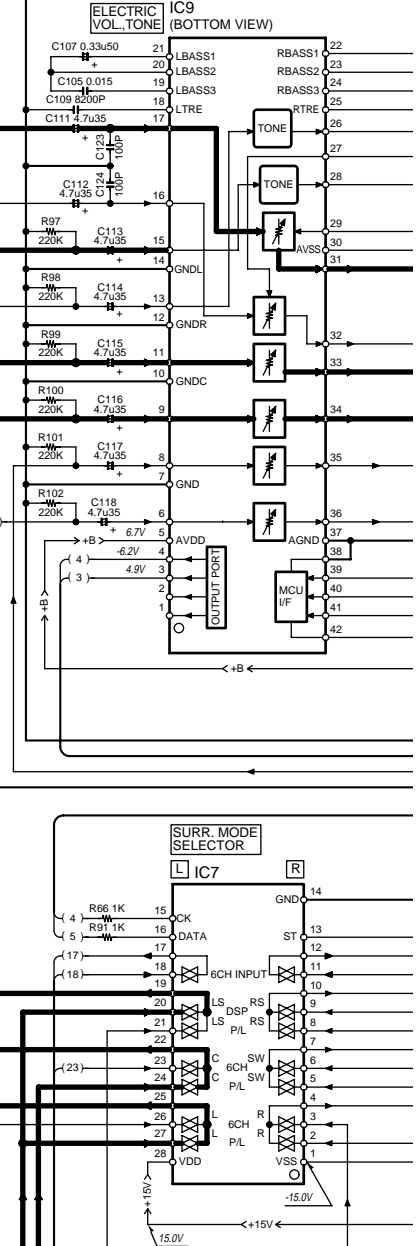
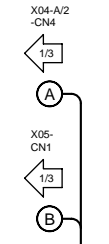
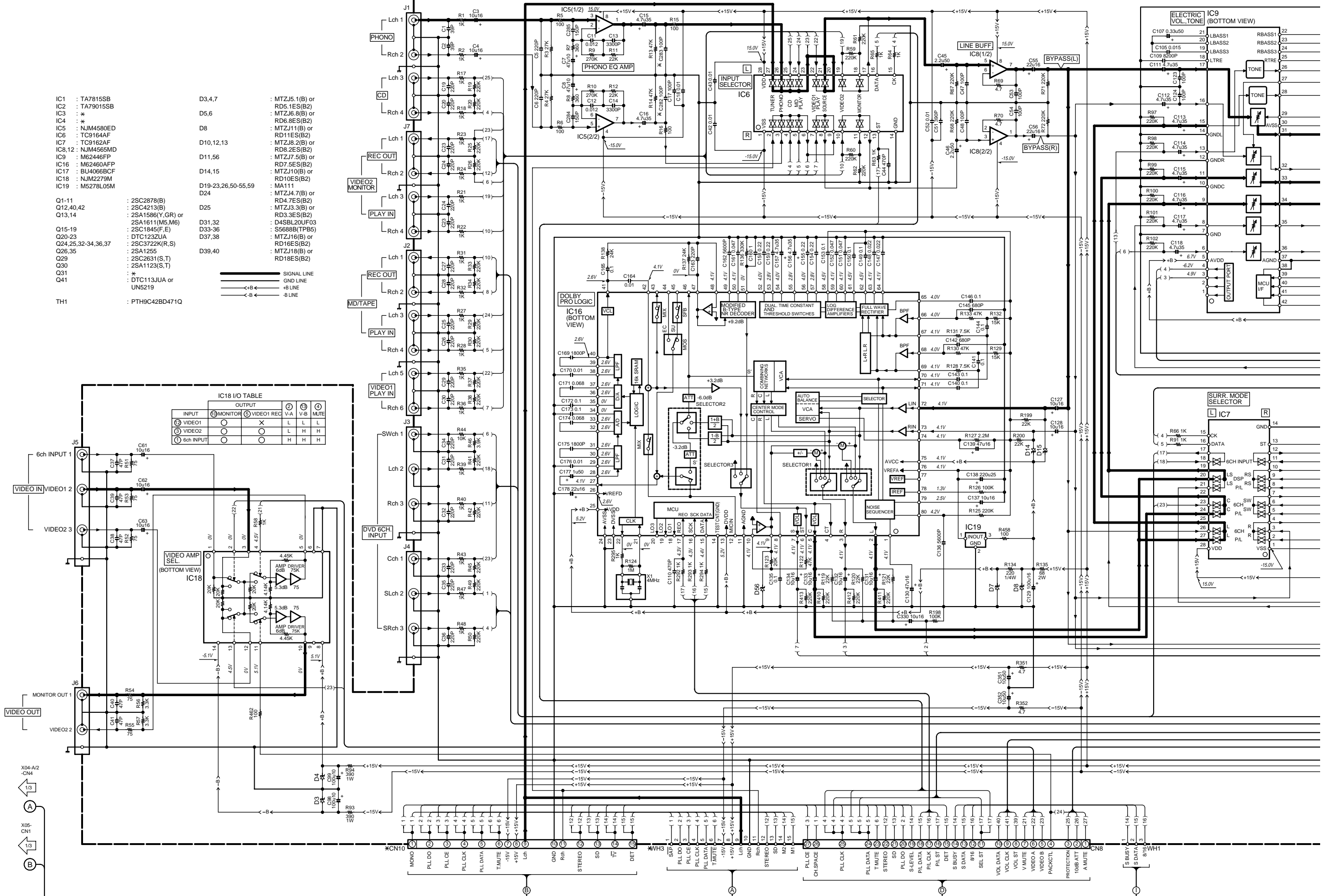

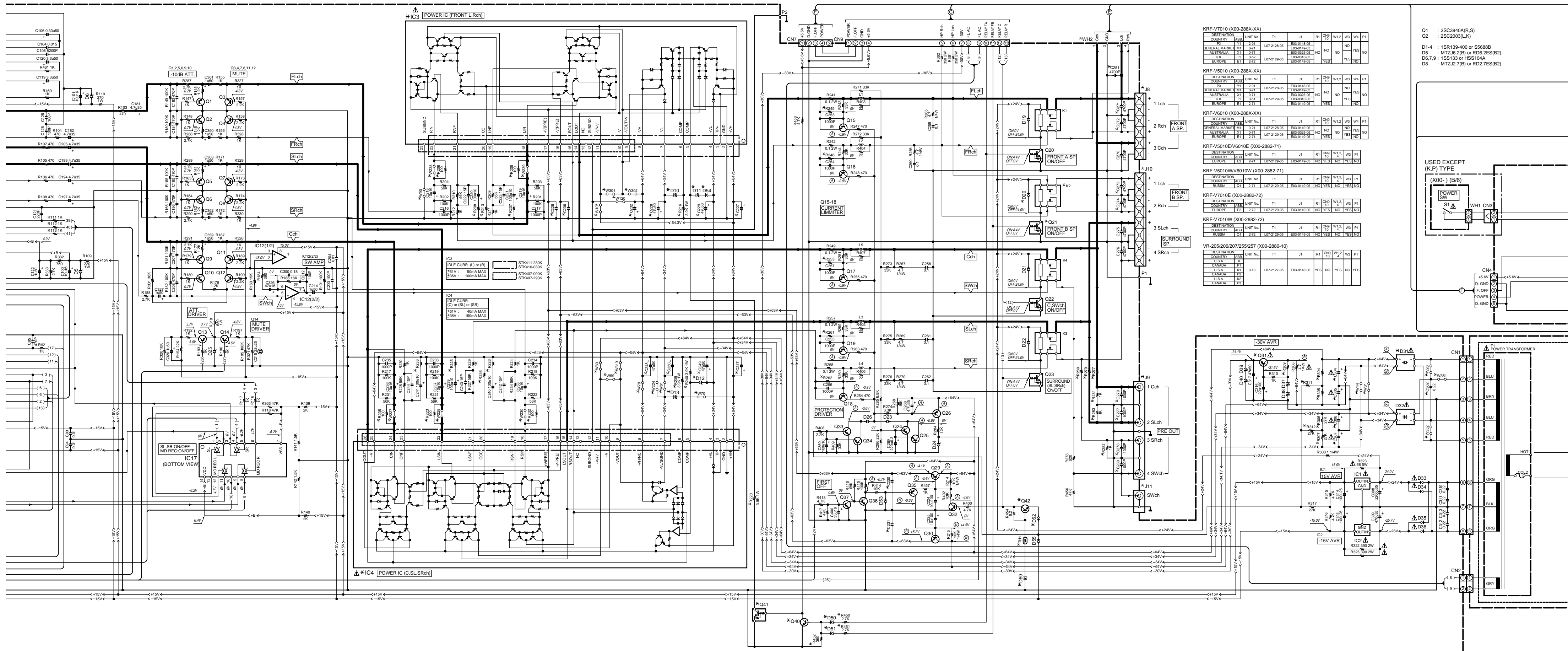

KRF-V7010 (X00-288X-XX)

DESTINATION	UNIT No.	T1	J1	R1	CN8	W1,2	W3	W4	P1
COUNTRY	ABS	Y1	2-91	L07-2129-05	E03-0148-05	NO	NO	NO	NO
GENERAL MARKET	MT	0-21	L07-2129-05	E03-0149-05	NO	NO	NO	NO	NO
AUSTRALIA	X1	0-71	L07-2129-05	E03-0205-05	NO	NO	NO	NO	NO
U.S.	T1	0-51	L07-2129-05	E03-0310-05	YES	NO	NO	NO	NO
EUROPE	E1	2-71	L07-2129-05	E03-0149-05	YES	NO	NO	NO	NO

KRF-V5010 (X00-288X-XX)

DESTINATION	UNIT No.	T1	J1	R1	CN8	W1,2	W3	W4	P1
COUNTRY	ABS	Y1	2-91	L07-2129-05	E03-0148-05	NO	NO	NO	NO
GENERAL MARKET	MT	0-21	L07-2129-05	E03-0149-05	NO	NO	NO	NO	NO
AUSTRALIA	X1	0-71	L07-2129-05	E03-0205-05	NO	NO	NO	NO	NO
U.S.	T1	0-51	L07-2129-05	E03-0310-05	YES	NO	NO	NO	NO
EUROPE	E1	2-71	L07-2129-05	E03-0149-05	YES	NO	NO	NO	NO

KRF-V6010 (X00-288X-XX)

DESTINATION	UNIT No.	T1	J1	R1	CN8	W1,2	W3	W4	P1
COUNTRY	ABS	Y1	2-91	L07-2129-05	E03-0148-05	NO	NO	NO	NO
GENERAL MARKET	MT	0-21	L07-2129-05	E03-0149-05	NO	NO	NO	NO	NO
AUSTRALIA	X1	0-71	L07-2129-05	E03-0205-05	NO	NO	NO	NO	NO
U.S.	T1	0-51	L07-2129-05	E03-0310-05	YES	NO	NO	NO	NO
EUROPE	E1	2-71	L07-2129-05	E03-0149-05	YES	NO	NO	NO	NO

KRF-V5010E/V6010E (X00-2882-71)

DESTINATION	UNIT No.	T1	J1	R1	CN8	W1,2	W3	W4	P1
COUNTRY	ABS	E2	2-71	L07-2129-05	E03-0149-05	NO	NO	NO	NO
RUSSIA	Q1	2-71	L07-2129-05	E03-0149-05	NO	NO	NO	NO	NO

KRF-V5010W/V6010W (X00-2882-71)

DESTINATION	UNIT No.	T1	J1	R1	CN8	W1,2	W3	W4	P1
COUNTRY	ABS	E2	2-71	L07-2129-05	E03-0149-05	NO	NO	NO	NO
RUSSIA	Q1	2-71	L07-2129-05	E03-0149-05	NO	NO	NO	NO	NO

KRF-V7010E (X00-2882-72)

DESTINATION	UNIT No.	T1	J1	R1	CN8	W1,2	W3	W4	P1
COUNTRY	ABS	E2	2-72	L07-2129-05	E03-0149-05	NO	NO	NO	NO
RUSSIA	Q1	2-72	L07-2129-05	E03-0149-05	NO	NO	NO	NO	NO

KRF-V7010W (X00-2882-72)

DESTINATION	UNIT No.	T1	J1	R1	CN8	W1,2	W3	W4	P1
COUNTRY	ABS	E2	2-72	L07-2129-05	E03-0149-05	NO	NO	NO	NO
RUSSIA	Q1	2-72	L07-2129-05	E03-0149-05	NO	NO	NO	NO	NO

VR-205/206/207/255/257 (X00-2880-10)

DESTINATION	UNIT No.	T1	J1	R1	CN8	W1,2	W3	W4	P1
COUNTRY	ABS	0-10	L07-2127-05	E03-0148-05	YES	NO	YES	NO	YES
U.S.A.	R								
U.S.A.	K1								
U.S.A.	K2								
U.S.A.	P2								
U.S.A.	K3								
CANADA	P3								

- Q1 : 2SC3940A(R,S)
- Q2 : 2SC2003(L,K)
- D1-4 : 1SR139-400 or S5688B
- D5 : MTZJ6.2(B) or RD5.2ES(B2)
- D6,7,9 : 1SS133 or HSS104A
- D8 : MTZJ2.7(B) or RD2.7ES(B2)

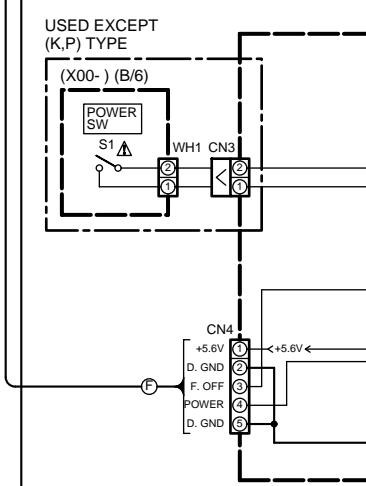

DC VOLTAGE FOR IC3

PIN NO.	1	2	3	4	5	6	7	8	9	10	11	12	13	14	15	16	17	18	19	20	21	22	23
STK411-230K	⊕12V	0V	36.7V	36.0V	27.8V	27.7V	⊖36.0V	⊕12V	35.7V	35.7V	35.7V	0V	0V	0V	0V	36.0V	37.2V	0V	0V	34.8V	0V	0V	0V
STK407-090K	⊕12V	0V	36.7V	36.0V	27.8V	27.7V	⊖36.0V	⊕12V	35.7V	35.7V	35.7V	0V	0V	0V	0V	36.1V	37.4V	0V	0V	35.9V	0V	0V	0V

DC VOLTAGE FOR IC4

PIN NO.	1	2	3	4	5	6	7	8	9	10	11	12	13	14	15	16	17	18	19	20	21	22	23	24	25	26
STK411-230K	⊕12V	0V	36.7V	36.0V	27.8V	27.7V	⊖36.0V	⊕12V	35.7V	35.7V	35.7V	0V	0V	0V	0V	36.1V	37.4V	0V	0V	35.9V	0V	0V	0V	0V	0V	0V
STK407-090K	⊕12V	0V	36.7V	36.0V	27.8V	27.7V	⊖36.0V	⊕12V	35.7V	35.7V	35.7V	0V	0V	0V	0V	36.1V	37.4V	0V	0V	35.9V	0V	0V	0V	0V	0V	0V

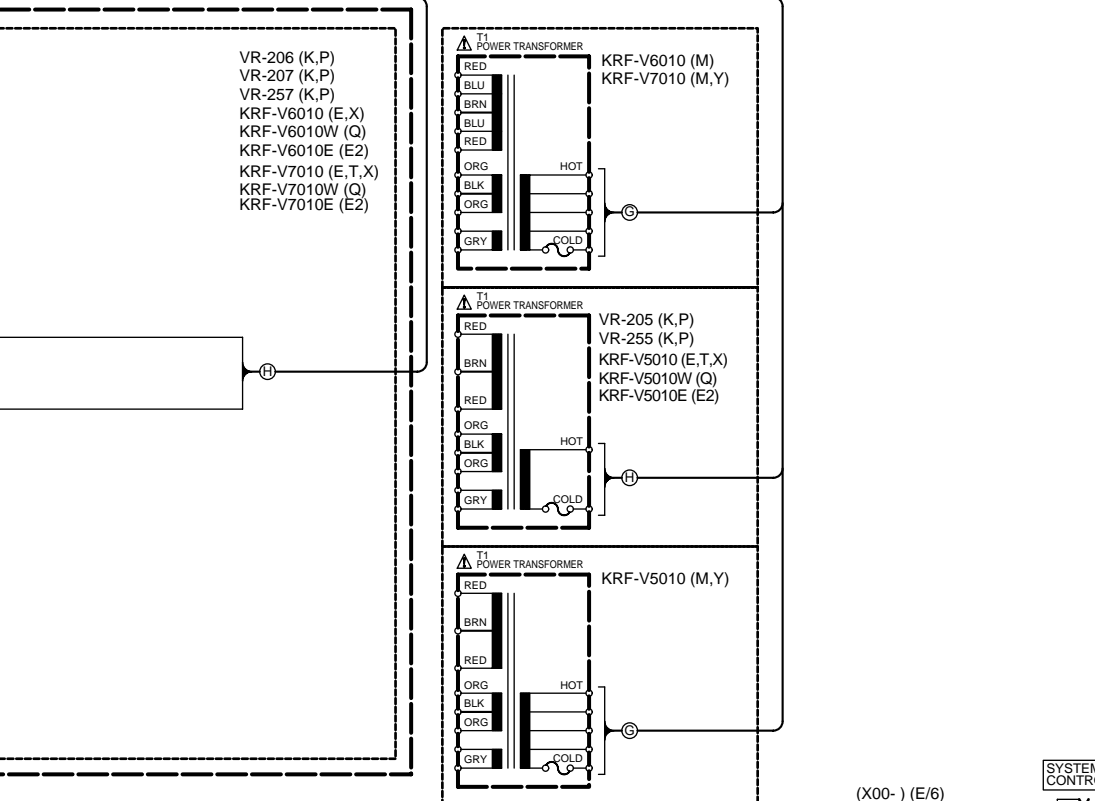
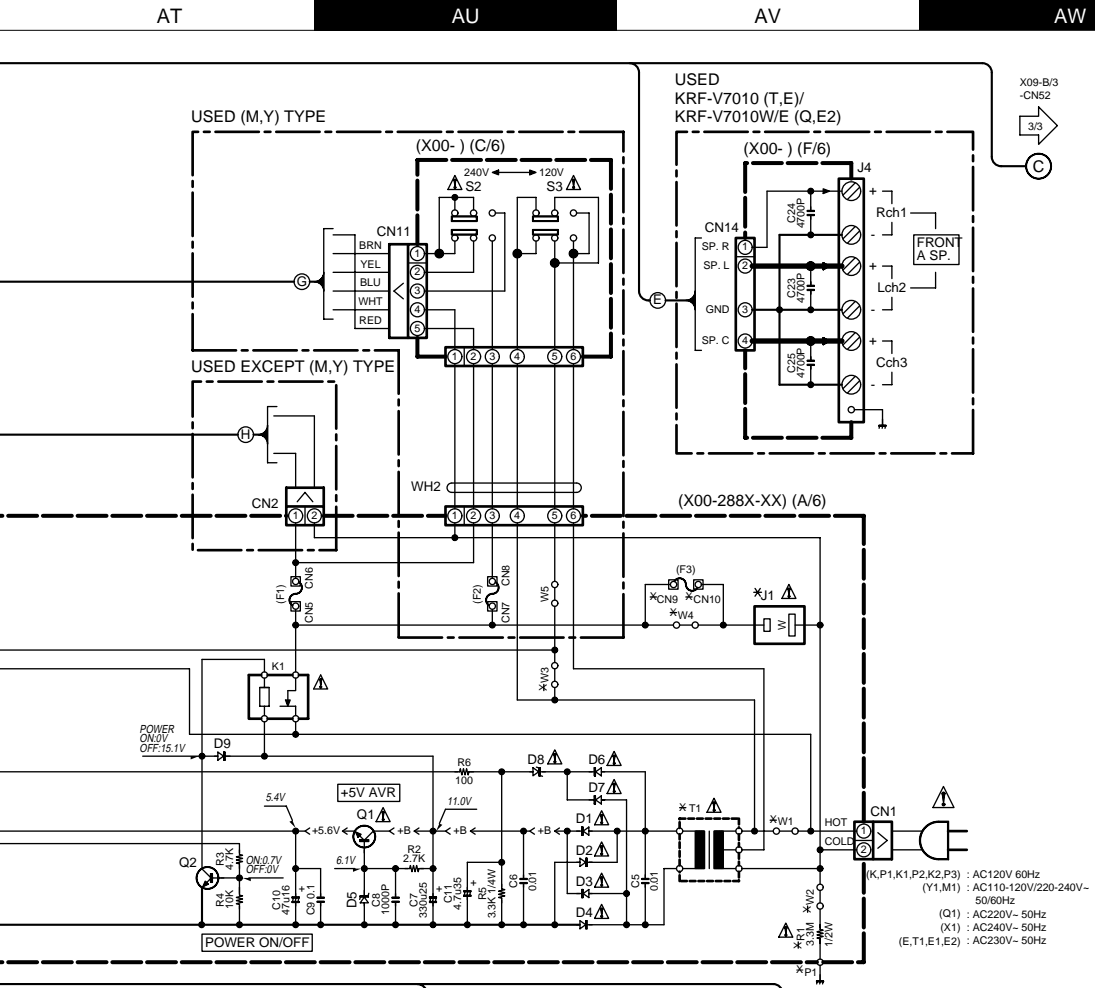

DESTINATION	COUNTRY	ABB	UNIT No.	CN10	J8,9	J10	J11,12	WH2,3	WH3	W26,31,44,56,70,83,107 120,224,302,313,352-355	W59,61,79,90,227,228, 230,238,239,301,351	IC3	IC4	Q21, 40,41	Q31	D10-13,20, 31,50,51,54	D52,59	R205,206,223, 232,235,454	R207, 208	R213, 236	R216,220,239,240,281-283, 306,307,312,450-453	R225, 226,233	R245,246, 253,261,262	R304, 305,311	R309, R402	C206,226, 230,231	C227,232, 247,248	C228,229,249,250,273,274, 277,280,282,283,302	C271, 272	C272, 304,305	K2	TH1				
U.S.A.	K			0-10	YES	YES	NO	(4P)	NO	YES	NO	STK407-090K	STK407-290K	NO	2SA1534A	NO	NO	NO	NO	470	20K	430	39K	27K	4.7K 10K	56K	3900P50	47u50	YES	3300u50	NO	NO				
CANADA	P1			0-11	YES	YES	(8P)	NO	NO	NO	YES	STK411-230K or STK411-230D	STK410-030K or STK410-030D	YES	2SB1640	NO	YES	NO	330	33K	YES	YES	300	24K	27K	51K	10K 14W	42K	3900P50	10u100	YES	NO	4700u75	3300u42	YES	NO
U.S.A.	K			0-11	YES	YES	(8P)	NO	NO	NO	YES	STK411-230K or STK411-230D	STK410-030K or STK410-030D	YES	2SB1640	NO	YES	NO	330	33K	YES	YES	300	24K	27K	51K	10K 14W	42K	3900P50	10u100	YES	NO	4700u75	3300u42	YES	NO



VR-205/206/207/255/257 (K) (2/3)
KRF-V5010/5010W/V6010/V6010W/V7010/V7010W (E) (2/3)

- 2SA1123
- 2SA1534A
- 2SC1845
- 2SC2003
- 2SC2631
- 2SC2878
- 2SC3940A

- DTA124ESA
- DTC124ESA
- UN4112
- 2SA1048
- UN5219
- 2SA1586
- 2SC3722K
- 2SC4081
- 2SC4116
- UN4212
- 2SA1309A

- 2SD1757K
- NJM4565D
- NJM4565MD
- NJM4580ED
- DA204U
- SAA6579T
- TC9162AF
- TC9164AF
- BU4066BCF
- LC72131
- S-80740AL-A4
- X24C02S

- LA1837
- LA1838
- SAA6579T/R

CAUTION: For continued safety, replace safety critical components only with manufacturer's recommended parts (refer to parts list). Δ indicates safety critical components. For continued protection against risk of fire, replace only with same type and rating fuse(s). To reduce the risk of electric shock, leakage-current or resistance measurements shall be carried out (exposed parts are acceptably insulated from the supply circuit) before the appliance is returned to the customer.

The DC voltage is an actual reading measured with a high impedance type voltmeter with no signal input. The measurement value may vary depending on the measuring instruments used or on the product.

DOLBY and the double-D symbol are trademarks of Dolby Laboratories Licensing Corporation. Noise reduction circuit made under license from Dolby Laboratories Licensing Corporation.

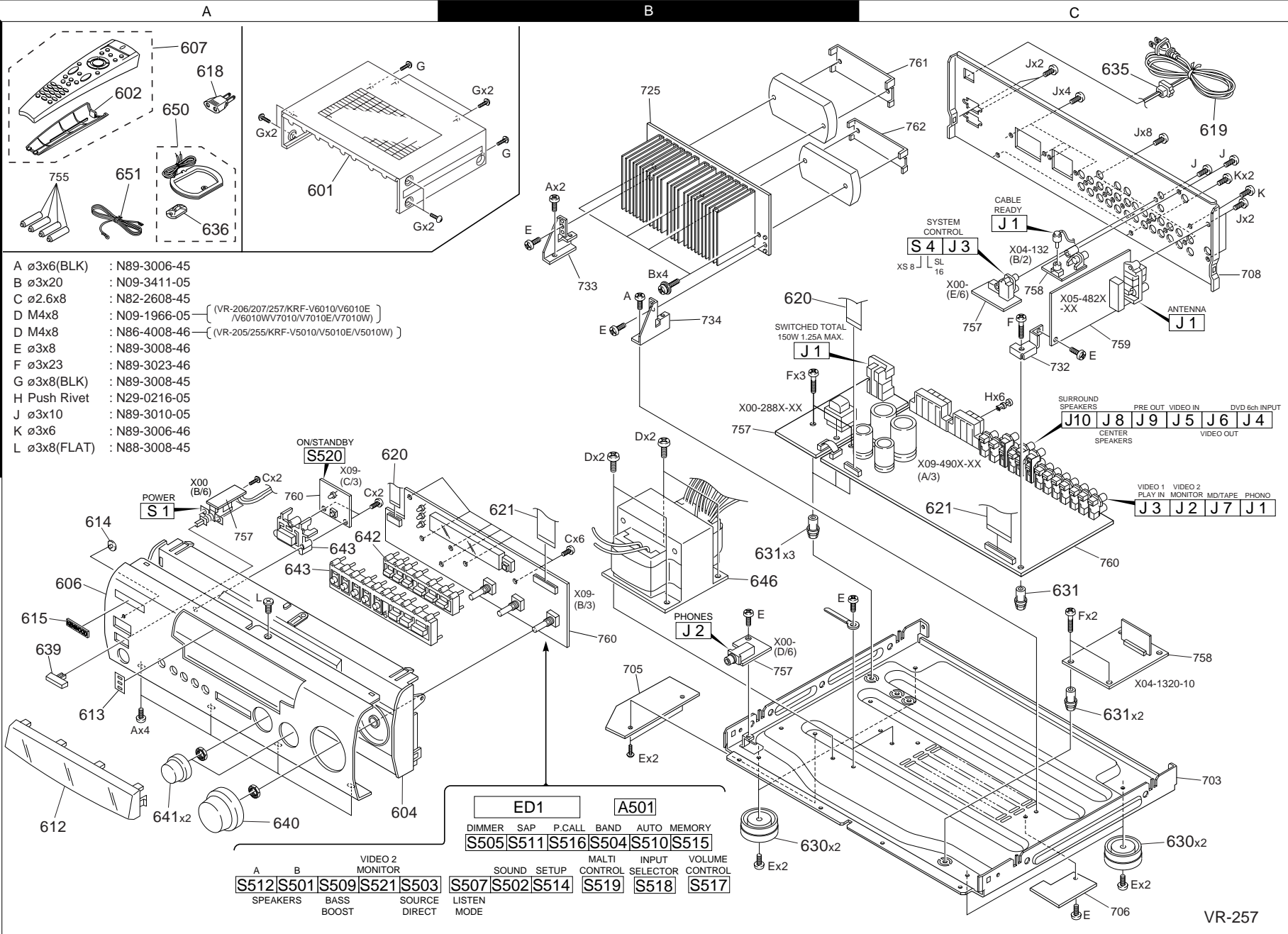

- A ϕ 3x6(BLK) : N89-3006-45
- B ϕ 3x20 : N09-3411-05
- C ϕ 2.6x8 : N82-2608-45
- D M4x8 : N09-1966-05 (VR-206/207/257/KRF-V6010/V6010E/V6010WV7010/V7010E/V7010W)
- D M4x8 : N86-4008-46 (VR-205/255/KRF-V5010/V5010E/V5010W)
- E ϕ 3x8 : N89-3008-46
- F ϕ 3x23 : N89-3023-46
- G ϕ 3x8(BLK) : N89-3008-45
- H Push Rivet : N29-0216-05
- J ϕ 3x10 : N89-3010-05
- K ϕ 3x6 : N89-3006-46
- L ϕ 3x8(FLAT) : N88-3008-45

ED1		A501			
DIMMER	SAP	P.CALL	BAND	AUTO	MEMORY
S505	S511	S516	S504	S510	S515
VIDEO 2 MONITOR		SOUND SETUP		MULTI INPUT	
S512 S501		S509 S521 S503		S507 S502 S514	
SPEAKERS		BASS BOOST		SOURCE DIRECT	
LISTEN MODE		CONTROL SELECTOR		VOLUME CONTROL	
S518		S519		S517	

* New Parts
Parts without **Parts No.** are not supplied.
Les articles non mentionnés dans le **Parts No.** ne sont pas fournis.
Teile ohne **Parts No.** werden nicht geliefert.



Ref. No	Add-ress	New Parts	Parts No.	Description	Desti-nation	Re-marks
VR-206/207/257/KRF-V7010/V7010E/V7010W						
601	1A	*	A01-3534-01	METALLIC CABINET	KP1Y1	
601	1A	*	A01-3534-01	METALLIC CABINET	M1X1K1	
601	1A	*	A01-3534-01	METALLIC CABINET	P2K2P3	
601	1A	*	A01-3545-01	METALLIC CABINET	E1T1Q1	
601	1A	*	A01-3545-01	METALLIC CABINET	E2	
602	1A		A09-0366-08	BATTERY COVER	KP1Y1	
602	1A		A09-0366-08	BATTERY COVER	M1X1E1	
602	1A		A09-0366-08	BATTERY COVER	P2E2	
602	1A		A09-0366-08	BATTERY COVER	T1Q1K1	
602	1A	*	A09-0396-08	BATTERY COVER	K2P3	
604	2A	*	A22-1804-11	SUB PANEL	E1T1Q1	
604	2A	*	A22-1804-11	SUB PANEL	E2	
606	2A	*	A60-1319-12	PANEL	E1T1Q1	
606	2A	*	A60-1319-12	PANEL	E2	
606	2A	*	A60-1320-11	PANEL	KP1	
606	2A	*	A60-1321-11	PANEL	Y1	
606	2A	*	A60-1368-11	PANEL	K1P2	
606	2A	*	A60-1375-11	PANEL	K2P3	
606	2A	*	A60-1443-01	PANEL	M1X1	
607	1A		A70-1194-05	REMOTE CONTROL ASSY(RC-R0607)	KP1Y1	
607	1A		A70-1194-05	REMOTE CONTROL ASSY(RC-R0607)	M1K1P2	
607	1A	*	A70-1195-05	REMOTE CONTROL ASSY(RC-R0507)	Q1E2	
607	1A	*	A70-1195-05	REMOTE CONTROL ASSY(RC-R0507)	X1E1T1	
607	1A	*	A70-1199-05	REMOTE CONTROL ASSY(RC-R0407)	K2P3	
612	2A	*	B10-2439-02	FRONT GLASS	KP1Y1	
612	2A	*	B10-2439-02	FRONT GLASS	M1X1E1	
612	2A	*	B10-2439-02	FRONT GLASS	P3E2	
612	2A	*	B10-2439-02	FRONT GLASS	T1Q1K2	
612	2A	*	B10-2440-02	FRONT GLASS	K1P2	
613	2A		B11-0361-04	SMOKED FILTER	K1P2	
613	2A	*	B11-0362-04	SMOKED FILTER	K1P2	
614	2A	*	B12-0334-14	INDICATOR		
615	2A		B43-0302-04	KENWOOD BADGE		
-	-		B46-0096-53	WARRANTY CARD	X1	
-	-		B46-0197-00	QUESTIONNAIRE CARD	KK1K2	
-	-		B46-0310-03	WARRANTY CARD	E1T1Q1	
-	-		B46-0310-03	WARRANTY CARD	E2	
-	-		B46-0330-03	WARRANTY CARD	KY1K1	
-	-		B46-0330-03	WARRANTY CARD	K2	
-	-		B46-0336-03	WARRANTY CARD	P1P2P3	
-	-		B58-0513-04	CAUTION CARD (PRESET220-240)	Y1	
-	-		B58-0945-03	CAUTION CARD	T1	
-	-		B58-0964-13	CAUTION CARD (UL)	KY1K1	
-	-		B58-0964-13	CAUTION CARD (UL)	K2	
-	-	*	B58-0965-13	CAUTION CARD (T,XtypePL)	X1T1	
-	-	*	B58-0966-13	CAUTION CARD (ELMtypePL)	M1E1	
-	-	*	B58-0967-03	CAUTION CARD (PtypePL)	P1P2P3	
-	-	*	B58-1607-03	CAUTION CARD	Q1E2	
-	-		B59-1104-00	SERVICE DIRECTORY	Y1	
-	-	*	B59-1404-03	CATALOG	KP1K2	
-	-	*	B59-1404-03	CATALOG	P3	
-	-	*	B59-1406-00	CATALOG	KP1K2	
-	-	*	B59-1406-00	CATALOG	P3	

L : Scandinavia K : USA P : Canada R : Mexico C : China I : Malaysia
Y : PX(Far East, Hawaii) T : Europe E : Europe G : Germany V : China (Shanghai)
Y : AAFES(Europe) X : Australia Q : Russia H : Korea M : Other Areas Δ indicates safety critical components.

* New Parts
Parts without **Parts No.** are not supplied.
Les articles non mentionnés dans le **Parts No.** ne sont pas fournis.
Teile ohne **Parts No.** werden nicht geliefert.



Ref. No	Add-ress	New Parts	Parts No.	Description	Desti-nation	Re-marks
-	-	*	B59-1407-00	CATALOG	P1P3	
-	-	*	B60-3605-00	INSTRUCTION MANUAL(I/SP)	E1	
-	-	*	B60-3606-00	INSTRUCTION MANUAL(HG/CZ)	E2	
-	-	*	B60-3609-00	INSTRUCTION MANUAL(ENGLISH)	T1Q1E2	
-	-	*	B60-3610-00	INSTRUCTION MANUAL(ENGLISH)	KP1Y1	
-	-	*	B60-3610-00	INSTRUCTION MANUAL(ENGLISH)	M1X1K1	
-	-	*	B60-3610-00	INSTRUCTION MANUAL(ENGLISH)	P2K2P3	
-	-	*	B60-3611-00	INSTRUCTION MANUAL(F/D)	E1	
-	-	*	B60-3612-00	INSTRUCTION MANUAL(FRENCH)	P1P2P3	
-	-	*	B60-3613-00	INSTRUCTION MANUAL(GERMAN)	E1	
-	-	*	B60-3614-00	INSTRUCTION MANUAL(SP/CHINESE)	M1	
-	-	*	B60-3616-00	INSTRUCTION MANUAL(PH)	E2	
-	-	*	B60-3617-00	INSTRUCTION MANUAL(ENGLISH)	E2	
-	-	*	B60-3617-00	INSTRUCTION MANUAL(ENGLISH)	X1T1Q1	
-	-	*	B60-3618-00	INSTRUCTION MANUAL(ENGLISH)	KP1Y1	
-	-	*	B60-3618-00	INSTRUCTION MANUAL(ENGLISH)	M1K1P2	
-	-	*	B60-3619-00	INSTRUCTION MANUAL(F/D/I/SP)	E1	
-	-	*	B60-3620-00	INSTRUCTION MANUAL(FRENCH)	P1P2	
-	-	*	B60-3621-00	INSTRUCTION MANUAL(SP/CHINESE)	M1	
-	-	*	B60-3623-00	INSTRUCTION MANUAL(PH/HG/CZ/R)	Q1E2	
-	-	*	B60-3625-00	INSTRUCTION MANUAL(E/F)	K1P2	
-	-	*	B60-3626-00	INSTRUCTION MANUAL(R)	Q1	
Δ 618	1A		E03-0115-05	AC PLUG ADAPTER	M1	
Δ 619	1C		E30-2605-05	AC POWER CORD	Y1	
Δ 619	1C		E30-2717-05	AC POWER CORD	X1	
Δ 619	1C		E30-2721-05	AC POWER CORD	T1	
Δ 619	1C		E30-2842-05	AC POWER CORD	E2	
Δ 619	1C		E30-2842-05	AC POWER CORD	M1E1Q1	
Δ 619	1C		E30-2849-05	AC POWER CORD	KP1K1	
Δ 619	1C		E30-2849-05	AC POWER CORD	P2K2P3	
620	1A,1B		E35-2017-05	FLAT CABLE(13P)		
621	2B,2C	*	E35-2042-05	FLAT CABLE(27P)		
Δ F1			F50-0077-05	FUSE(5X20) 125V 8A	KP1K1	
Δ F1			F50-0077-05	FUSE(5X20) 125V 8A	P2K2P3	
Δ F1			F50-0101-05	FUSE(5X20) 250V T3.15AL	E1T1Q1	
Δ F1			F50-0101-05	FUSE(5X20) 250V T3.15AL	E2	
Δ F1			F50-0101-05	FUSE(5X20) 250V T3.15AL	Y1M1X1	
Δ F3			F50-0100-05	FUSE(5X20) 250V T2.5AL	E1Q1E2	
-	-		H10-7418-12	POLYSTYRENE FOAMED FIXTURE(L)		
-	-		H10-7419-02	POLYSTYRENE FOAMED FIXTURE(R)		
-	-		H25-0232-04	PROTECTION BAG (235X350X0.03)	KP1Y1	
-	-		H25-0232-04	PROTECTION BAG (235X350X0.03)	K2P3E2	
-	-		H25-0232-04	PROTECTION BAG (235X350X0.03)	M1X1E1	
-	-		H25-0232-04	PROTECTION BAG (235X350X0.03)	Q1K1P2	
-	-		H25-0391-04	PROTECTION BAG	T1	
-	-		H25-0651-04	PROTECTION BAG (0232 PRINT)	KP1	
-	-	*	H50-2721-04	ITEM CARTON CASE	M1	
-	-	*	H50-2722-04	ITEM CARTON CASE	M1	
-	-	*	H50-2723-04	ITEM CARTON CASE	T1	
-	-	*	H50-2723-04	ITEM CARTON CASE	Y1X1E1	
-	-	*	H50-2724-14	ITEM CARTON CASE	Q1	
-	-	*	H50-2725-04	ITEM CARTON CASE	K1P2	
-	-	*	H50-2844-04	ITEM CARTON CASE	K2P3	

L : Scandinavia K : USA P : Canada R : Mexico C : China I : Malaysia
Y : PX(Far East, Hawaii) T : Europe E : Europe G : Germany V : China (Shanghai)
Y : AAFES(Europe) X : Australia Q : Russia H : Korea M : Other Areas Δ indicates safety critical components.

KRF-V5010W6010W7010WVR-205/206/207/255/257
PARTS LIST

* New Parts

Parts without **Parts No.** are not supplied.
Les articles non mentionnés dans le **Parts No.** ne sont pas fournis.
Teile ohne **Parts No.** werden nicht geliefert.

③

Ref. No	Add-ress	New Parts	Parts No.	Description	Desti-nation	Re-marks
-		*	H50-3085-04	ITEM CARTON CASE	E2	
630	2B,2C		J02-1167-03	FOOT	M1X1E1	
630	2B,2C		J02-1167-03	FOOT	T1Q1E2	
630	2B,2C		J02-1405-03	FOOT (D=46,H=14.5,T)	KP1Y1	
630	2B,2C		J02-1405-03	FOOT (D=46,H=14.5,T)	K1P2K2	
630	2B,2C		J02-1405-03	FOOT (D=46,H=14.5,T)	P3	
635	2B,2C		J19-5787-04	UNIT HOLDER		
636	1C		J42-0083-05	POWER CORD BUSHING		
-	1A		J19-3645-05	ANTENNA STAND		
-			J61-0307-05	WIRE BAND		
639	2A		K27-2185-04	KNOB (POWER)	M1X1E1	
639	2A		K27-2185-04	KNOB (POWER)	T1Q1E2	
639	2A	*	K27-2274-04	KNOB (POWER)	Y1	
640	2A	*	K29-6880-04	KNOB (VOLUME CONTROL)	KP1Y1	
640	2A	*	K29-6880-04	KNOB (VOLUME CONTROL)	K1P2K2	
640	2A		K29-6880-04	KNOB (VOLUME CONTROL)	P3	
640	2A	*	K29-7306-14	KNOB (VOLUME CONTROL)	M1X1E1	
640	2A	*	K29-7306-14	KNOB (VOLUME CONTROL)	T1Q1E2	
641	2A		K29-6881-04	KNOB (MULTI CONTROL)	KP1Y1	
641	2A		K29-6881-04	KNOB (MULTI CONTROL)	K1P2K2	
641	2A		K29-6881-04	KNOB (MULTI CONTROL)	P3	
641	2A	*	K29-7307-14	KNOB (MULTI CONTROL)	M1X1E1	
641	2A	*	K29-7307-14	KNOB (MULTI CONTROL)	T1Q1E2	
642	2A		K29-6898-03	KNOB	KP1Y1	
642	2A		K29-6898-03	KNOB	K2P3	
642	2A	*	K29-6899-13	KNOB	E1T1Q1	
642	2A	*	K29-6899-13	KNOB	E2	
642	2A	*	K29-6907-03	KNOB	K1P2	
642	2A	*	K29-7366-03	KNOB	M1X1	
643	2A	*	K29-6939-12	KNOB	KP1Y1	
643	2A	*	K29-6939-12	KNOB	K1P2K2	
643	2A	*	K29-6939-12	KNOB	P3	
643	2A	*	K29-7365-12	KNOB	M1X1	
646	2A	*	L07-2479-05	POWER TRANSFORMER	KP1K1	
646	2A	*	L07-2479-05	POWER TRANSFORMER	P2K2P3	
646	2A	*	L07-2480-05	POWER TRANSFORMER	E1T1	
646	2A	*	L07-2481-05	POWER TRANSFORMER	Y1M1	
646	2A	*	L07-2482-05	POWER TRANSFORMER	Q1E2	
646	2A	*	L07-2483-05	POWER TRANSFORMER	X1	
650	1A		T90-0833-05	LOOP ANTENNA		
651	1A		T90-0836-05	LEAD WIRE ANTENNA		
VR-205/255/KRF-V5010/V5010E/V5010W						
601	1A		A01-3534-01	METALLIC CABINET		
602	1A		A09-0366-08	BATTERY COVER	K1P2	
602	1A	*	A09-0396-08	BATTERY COVER	KP1Y1	
602	1A	*	A09-0396-08	BATTERY COVER	M1X1E1	
602	1A	*	A09-0396-08	BATTERY COVER	T1Q1E2	
606	2A	*	A60-1323-21	PANEL	KP1	
606	2A	*	A60-1324-21	PANEL	Y1	
606	2A	*	A60-1359-21	PANEL	E1T1Q1	
606	2A	*	A60-1359-21	PANEL	E2	
606	2A	*	A60-1376-21	PANEL	K1P2	

L : Scandinavia K : USA P : Canada R : Mexico C : China I : Malaysia
Y : PX(Far East, Hawaii) T : Europe E : Europe G : Germany V : China (Shanghai)
Y : AAFES(Europe) X : Australia Q : Russia H : Korea M : Other Areas Δ indicates safety critical components.

* New Parts

Parts without **Parts No.** are not supplied.
Les articles non mentionnés dans le **Parts No.** ne sont pas fournis.
Teile ohne **Parts No.** werden nicht geliefert.

④

Ref. No	Add-ress	New Parts	Parts No.	Description	Desti-nation	Re-marks
606	2A	*	A60-1444-01	PANEL	M1X1	
607	1A		A70-1194-05	REMOTE CONTROL ASSY(RC-R0607)	K1P2	
607	1A	*	A70-1196-05	REMOTE CONTROL ASSY(RC-R0307)	E1T1Q1	
607	1A	*	A70-1196-05	REMOTE CONTROL ASSY(RC-R0307)	E2	
607	1A	*	A70-1199-05	REMOTE CONTROL ASSY(RC-R0407)	KP1Y1	
607	1A	*	A70-1199-05	REMOTE CONTROL ASSY(RC-R0407)	M1X1	
612	2A	*	B10-2439-02	FRONT GLASS		
614	2A		B12-0334-14	INDICATOR		
615	2A		B43-0302-04	KENWOOD BADGE		
-			B46-0096-53	WARRANTY CARD	X1	
-			B46-0197-00	QUESTIONNAIRE CARD	KK1	
-			B46-0310-03	WARRANTY CARD	E1T1Q1	
-			B46-0310-03	WARRANTY CARD	E2	
-			B46-0330-03	WARRANTY CARD	KY1K1	
-			B46-0336-03	WARRANTY CARD	P1P2	
-			B58-0513-04	CAUTION CARD (PRESET220-240)	Y1	
-			B58-0945-03	CAUTION CARD	T1	
-			B58-0964-13	CAUTION CARD (UL)	KY1K1	
-		*	B58-0965-13	CAUTION CARD (T,XtypePL)	X1T1	
-		*	B58-0966-13	CAUTION CARD (ELMtypePL)	M1E1	
-		*	B58-0967-03	CAUTION CARD (PtypePL)	P1P2	
-		*	B58-1607-03	CAUTION CARD	Q1E2	
-			B59-1104-00	SERVICE DIRECTORY	Y1	
-		*	B59-1404-03	CATALOG	KP1K1	
-		*	B59-1404-03	CATALOG	P2	
-		*	B59-1406-00	CATALOG	KP1K1	
-		*	B59-1406-00	CATALOG	P2	
-		*	B59-1407-00	CATALOG	P1P2	
-		*	B60-3605-00	INSTRUCTION MANUAL(I/SP)	E1	
-		*	B60-3606-00	INSTRUCTION MANUAL(HG/CZ)	E2	
-		*	B60-3609-00	INSTRUCTION MANUAL(ENGLISH)	T1Q1E2	
-		*	B60-3610-00	INSTRUCTION MANUAL(ENGLISH)	KP1Y1	
-		*	B60-3610-00	INSTRUCTION MANUAL(ENGLISH)	M1X1K1	
-		*	B60-3610-00	INSTRUCTION MANUAL(ENGLISH)	P2	
-		*	B60-3611-00	INSTRUCTION MANUAL(F/D)	E1	
-		*	B60-3612-00	INSTRUCTION MANUAL(FRENCH)	P1P2	
-		*	B60-3613-00	INSTRUCTION MANUAL(GERMAN)	E1	
-		*	B60-3614-00	INSTRUCTION MANUAL(SP/CHINESE)	M1	
-		*	B60-3616-00	INSTRUCTION MANUAL(PH)	E2	
-		*	B60-3618-00	INSTRUCTION MANUAL(ENGLISH)	K1P2	
-		*	B60-3620-00	INSTRUCTION MANUAL(FRENCH)	P2	
Δ 618	1A		E03-0115-05	AC PLUG ADAPTER	M1	
Δ 619	1C		E30-2605-05	AC POWER CORD	Y1	
Δ 619	1C		E30-2717-05	AC POWER CORD	X1	
Δ 619	1C		E30-2721-05	AC POWER CORD	T1	
Δ 619	1C		E30-2842-05	AC POWER CORD	E2	
Δ 619	1C		E30-2842-05	AC POWER CORD	M1E1Q1	
Δ 619	1C		E30-2849-05	AC POWER CORD	KP1K1	
Δ 619	1C		E30-2849-05	AC POWER CORD	P2	
620	1A,1B		E35-2017-05	FLAT CABLE		
621	2B,2C	*	E35-2042-05	FLAT CABLE		
Δ F1			F50-0076-05	FUSE(5X20) 125V 6.3A	KP1K1	
Δ F1			F50-0076-05	FUSE(5X20) 125V 6.3A	P2	
Δ F2		*	F50-0099-05	FUSE(5X20) 250V T2AL	E1T1Q1	

L : Scandinavia K : USA P : Canada R : Mexico C : China I : Malaysia
Y : PX(Far East, Hawaii) T : Europe E : Europe G : Germany V : China (Shanghai)
Y : AAFES(Europe) X : Australia Q : Russia H : Korea M : Other Areas Δ indicates safety critical components.

* New Parts
Parts without **Parts No.** are not supplied.
Les articles non mentionnés dans le **Parts No.** ne sont pas fournis.
Teile ohne **Parts No.** werden nicht geliefert.

5

Ref. No	Address	New Parts	Parts No.	Description	Destination	Remarks
Δ F2		*	F50-0099-05	FUSE(5X20) 250V T2AL	E2	
Δ F2		*	F50-0099-05	FUSE(5X20) 250V T2AL	Y1M1X1	
Δ F3			F50-0100-05	FUSE(5X20) 250V T2.5AL	E1Q1E2	
-			H10-7418-12	POLYSTYRENE FOAMED FIXTURE(L)		
-			H10-7419-02	POLYSTYRENE FOAMED FIXTURE(R)		
-			H25-0232-04	PROTECTION BAG (235X350X0.03)	E2	
-			H25-0232-04	PROTECTION BAG (235X350X0.03)	KP1Y1	
-			H25-0232-04	PROTECTION BAG (235X350X0.03)	M1X1E1	
-			H25-0232-04	PROTECTION BAG (235X350X0.03)	Q1K1P2	
-			H25-0232-04	PROTECTION BAG (235X350X0.03)		
-			H25-0391-04	PROTECTION BAG		
-			H25-0651-04	PROTECTION BAG (0232 PRI)	T1	
-		*	H50-2727-04	ITEM CARTON CASE	KP1	
-		*	H50-2728-04	ITEM CARTON CASE	M1	
-		*	H50-2729-04	ITEM CARTON CASE	T1	
-		*	H50-2729-04	ITEM CARTON CASE	Y1X1E1	
-		*	H50-2730-14	ITEM CARTON CASE	Q1	
-		*	H50-2731-04	ITEM CARTON CASE	K1P2	
-		*	H50-3086-04	ITEM CARTON CASE	E2	
630	2B,2C		J02-1167-03	FOOT	M1X1E1	
630	2B,2C		J02-1167-03	FOOT	T1Q1E2	
630	2B,2C		J02-1405-03	FOOT (D=46,H=14.5,T)	KP1Y1	
630	2B,2C		J02-1405-03	FOOT (D=46,H=14.5,T)	K1P2	
631	2B,2C		J19-5787-04	UNIT HOLDER		
Δ 635	1C		J42-0083-05	POWER CORD BUSHING		
636	1A		J19-3645-05	ANTENNA STAND	E1T1Q1	
-			J61-0307-05	WIRE BAND	E2	
-			J61-0307-05	WIRE BAND	Y1M1X1	
-			J61-0307-05	WIRE BAND		
639	2A		K27-2185-04	KNOB (POWER)	M1X1E1	
639	2A		K27-2185-04	KNOB (POWER)	T1Q1E2	
639	2A	*	K27-2274-04	KNOB (POWER)	Y1	
640	2A		K29-6880-04	KNOB (VOLUME CONTROL)	KP1Y1	
640	2A		K29-6880-04	KNOB (VOLUME CONTROL)	K1P2	
640	2A	*	K29-7306-14	KNOB (VOLUME CONTROL)	M1X1E1	
640	2A	*	K29-7306-14	KNOB (VOLUME CONTROL)	T1Q1E2	
641	2A		K29-6881-04	KNOB (MULTI CONTROL)	KP1Y1	
641	2A		K29-6881-04	KNOB (MULTI CONTROL)	K1P2	
641	2A	*	K29-7307-14	KNOB (MULTI CONTROL)	M1X1E1	
641	2A	*	K29-7307-14	KNOB (MULTI CONTROL)	T1Q1E2	
642	2A		K29-6898-03	KNOB	KP1Y1	
642	2A		K29-6898-03	KNOB	K1P2	
642	2A	*	K29-6899-13	KNOB	E1T1Q1	
642	2A	*	K29-6899-13	KNOB	E2	
642	2A	*	K29-7366-03	KNOB	M1X1	
643	2A	*	K29-6939-12	KNOB	KP1Y1	
643	2A	*	K29-6939-12	KNOB	K1P2	
643	2A	*	K29-7365-12	KNOB	M1X1E1	
643	2A	*	K29-7365-12	KNOB	T1Q1E2	
Δ 646	2A	*	L07-2470-15	POWER TRANSFORMER	KP1K1	
Δ 646	2A	*	L07-2470-15	POWER TRANSFORMER	P2	
Δ 646	2A	*	L07-2471-05	POWER TRANSFORMER	E1T1	
Δ 646	2A	*	L07-2472-05	POWER TRANSFORMER	Y1M1	
Δ 646	2A	*	L07-2473-05	POWER TRANSFORMER	Q1E2	
Δ 646	2A	*	L07-2474-05	POWER TRANSFORMER	X1	

L: Scandinavia K: USA P: Canada R: Mexico C: China I: Malaysia
Y: PX(Far East, Hawaii) T: Europe E: Europe G: Germany V: China (Shanghai)
Y: AAFES(Europe) X: Australia Q: Russia H: Korea M: Other Areas Δ indicates safety critical components.

* New Parts
Parts without **Parts No.** are not supplied.
Les articles non mentionnés dans le **Parts No.** ne sont pas fournis.
Teile ohne **Parts No.** werden nicht geliefert.

6

Ref. No	Address	New Parts	Parts No.	Description	Destination	Remarks
650	1A		T90-0833-05	LOOP ANTENNA		
651	1A		T90-0836-05	LEAD WIRE ANTENNA		
KRF-V6010/V6010E/V6010W						
601	1A	*	A01-3534-01	METALLIC CABINET		
602	1A	*	A09-0396-08	BATTERY COVER		
606	2A	*	A60-1334-11	PANEL		EQ1E1
606	2A	*	A60-1335-11	PANEL		M1X1
607	1A	*	A70-1196-05	REMOTE CONTROL ASSY(RC-R0307)		EQ1E1
607	1A	*	A70-1199-05	REMOTE CONTROL ASSY(RC-R0407)		M1X1
612	2A	*	B10-2439-02	FRONT GLASS		
614	2A	*	B12-0334-14	INDICATOR		
615	2A	*	B43-0302-04	KENWOOD BADGE		
-			B46-0096-53	WARRANTY CARD		X1
-			B46-0310-03	WARRANTY CARD		E1Q1E2
-		*	B58-0965-13	CAUTION CARD (T.XtyoePL)		X1
-		*	B58-0966-13	CAUTION CARD (ELMtypePL)		E1M1
-		*	B58-1607-03	CAUTION CARD		Q1E2
-		*	B60-3605-00	INSTRUCTION MANUAL(I/SP)		E1
-		*	B60-3606-00	INSTRUCTION MANUAL(HG/CZ)		E2
-		*	B60-3609-00	INSTRUCTION MANUAL(ENGLISH)		Q1E2
-		*	B60-3610-00	INSTRUCTION MANUAL(ENGLISH)		M1X1
-		*	B60-3611-00	INSTRUCTION MANUAL(F/D)		E1
-		*	B60-3614-00	INSTRUCTION MANUAL(SP/CHINESE)		M1
-		*	B60-3616-00	INSTRUCTION MANUAL(PH)		E2
-		*	B60-3626-00	INSTRUCTION MANUAL(R)		Q1
Δ 618	1A		E03-0115-05	AC PLUG ADAPTER		M1
Δ 619	1C		E30-2717-05	AC POWER CORD		X1
Δ 619	1C		E30-2842-05	AC POWER CORD		E1Q1M1
Δ 619	1C		E30-2842-05	AC POWER CORD		E2
620	1A,1B	*	E35-2017-05	FLAT CABLE(13P)		
621	2B,2C	*	E35-2042-05	FLAT CABLE(27P)		
Δ F1			F50-0101-05	FUSE(5X20) 250V T3.15AL		
Δ F3			F50-0100-05	FUSE(5X20) 250V T2.5AL		E1Q1E2
-		*	H10-7418-12	POLYSTYRENE FOAMED FIXTURE		
-		*	H10-7419-02	POLYSTYRENE FOAMED FIXTURE		
-		*	H25-0232-04	PROTECTION BAG (235X350X0.03)		
-		*	H25-0391-04	PROTECTION BAG		
-		*	H50-2750-04	ITEM CARTON CASE		E1X1
-		*	H50-2751-14	ITEM CARTON CASE		Q1
-		*	H50-2752-04	ITEM CARTON CASE		M1
-		*	H50-3087-04	ITEM CARTON CASE		E2
630	2B,2C		J02-1167-03	FOOT		
631	2B,2C		J19-5787-04	UNIT HOLDER		
Δ 635	1C		J42-0083-05	POWER CORD BUSHING		
636	1A		J19-3645-05	ANTENNA STAND		
-			J61-0307-05	WIRE BAND		
639	2A		K27-2185-04	KNOB (POWER)		
640	2A	*	K29-7306-14	KNOB (VOLUME CONTROL)		
641	2A	*	K29-7307-14	KNOB (MULTI CONTROL)		
641	2A	*	K29-7366-03	KNOB		M1X1
642	2A	*	K29-6899-13	KNOB		E1Q1E2

L: Scandinavia K: USA P: Canada R: Mexico C: China I: Malaysia
Y: PX(Far East, Hawaii) T: Europe E: Europe G: Germany V: China (Shanghai)
Y: AAFES(Europe) X: Australia Q: Russia H: Korea M: Other Areas Δ indicates safety critical components.

KRF-V5010/V6010/V7010/VR-205/206/207/255/257
PARTS LIST

* New Parts
Parts without **Parts No.** are not supplied.
Les articles non mentionnés dans le **Parts No.** ne sont pas fournis.
Teile ohne **Parts No.** werden nicht geliefert.



Ref. No	Address	New Parts	Parts No.	Description	Destination	Remarks
643	2A	*	K29-7365-12	KNOB		
△ 646	2A	*	L07-2480-05	POWER TRANSFORMER	E1	
△ 646	2A	*	L07-2481-05	POWER TRANSFORMER	M1	
△ 646	2A	*	L07-2482-05	POWER TRANSFORMER	Q1E2	
△ 646	2A	*	L07-2483-05	POWER TRANSFORMER	X1	
650	1A		T90-0833-05	LOOP ANTENNA		
651	1A		T90-0836-05	LEAD WIRE ANTENNA		
POWER SUPPLY UNIT (X00-288X-XX)						
C5 ,6			CK45FF1H103Z	CERAMIC 0.010UF Z		
C7			CE04EW1E331M	ELECTRO 330UF 25WV		
C8			CK45FB1H102K	CERAMIC 1000PF K		
C9			CQ92FM1H104J	MYLAR 0.10UF J		
C10			CE04LW1C470M	ELECTRO 47UF 16WV		
C11			CE04LW1V4R7M	ELECTRO 4.7UF 35WV		
C13 ,14			CC45FSL1H101J	CERAMIC 100PF J		
C21 ,22			CC45FSL1H221J	CERAMIC 220PF J		
C23 -25			CK45FF1H472Z	CERAMIC 4700PF Z	E1T1Q1	7
C23 -25			CK45FF1H472Z	CERAMIC 4700PF Z	E2	7
△ CN1			E40-4245-05	PIN ASSY	Y1M1	
△ CN1 -3			E40-4245-05	PIN ASSY	Q1E2	
△ CN1 -3			E40-4245-05	PIN ASSY	X1E1T1	
△ CN1 ,2			E40-4245-05	PIN ASSY	KP1K1	
△ CN1 ,2			E40-4245-05	PIN ASSY	P2K2P3	
CN3			E40-4245-05	PIN ASSY	Y1M1	
CN4			E40-8197-05	SOCKET FOR PIN ASSY		
CN11			E40-4281-05	PIN ASSY	Y1M1	
CN12,13			E40-3247-05	PIN ASSY		
CN14			E40-4101-05	PIN ASSY	E1T1Q1	
△ CN14			E40-4101-05	PIN ASSY	E2	
△ J1			E03-0148-05	AC OUTLET	KP1Y1	
△ J1			E03-0148-05	AC OUTLET	K1P2K2	
△ J1			E03-0148-05	AC OUTLET	P3	
△ J1			E03-0149-05	AC OUTLET	E2	
△ J1			E03-0149-05	AC OUTLET	M1E1Q1	
△ J1			E03-0310-05	AC OUTLET	T1	
△ J1			E03-0325-05	AC OUTLET	X1	
J2			E11-0295-05	PHONE JACK (3P)		
J3			E11-0347-05	MINIATURE PHONE JACK(2P)		
J4			E70-0089-05	SCREW TERMINAL BOARD	E1T1Q1	7
J4			E70-0089-05	SCREW TERMINAL BOARD	E2	7
CN5 ,6			J13-0075-05	FUSE CLIP		
CN7 ,8			J13-0075-05	FUSE CLIP	Y1M1	
CN9 ,10			J13-0075-05	FUSE CLIP	E1Q1E2	
E1			J11-0808-05	WIRE CLAMPER		
△ T1			L07-2127-05	POWER TRANSFORMER	KP1K1	
△ T1			L07-2127-05	POWER TRANSFORMER	P2K2P3	
△ T1			L07-2128-05	POWER TRANSFORMER	Y1M1	
△ T1			L07-2129-05	POWER TRANSFORMER	Q1E2	
△ T1			L07-2129-05	POWER TRANSFORMER	X1E1T1	
△ R1			R92-1844-05	CARBON 3.3M J 1/2W	KP1K1	
△ R1			R92-1844-05	CARBON 3.3M J 1/2W	P2K2P3	
K1			S76-0070-05	MAGNETIC RELAY		

L : Scandinavia K : USA P : Canada R : Mexico C : China I : Malaysia
Y : PX(Far East, Hawaii) T : Europe E : Europe G : Germany V : China (Shanghai)
Y : AAFES(Europe) X : Australia Q : Russia H : Korea M : Other Areas △ indicates safety critical components.

* New Parts
Parts without **Parts No.** are not supplied.
Les articles non mentionnés dans le **Parts No.** ne sont pas fournis.
Teile ohne **Parts No.** werden nicht geliefert.



Ref. No	Address	New Parts	Parts No.	Description	Destination	Remarks
△ S1			S68-0088-05			E1T1Q1
△ S1			S68-0088-05			E2
△ S1			S68-0088-05			Y1M1X1
△ S2 ,3			S62-0001-05	SLIDE SWITCH		Y1M1
△ S4			S62-0034-05	SLIDE SWITCH		
△ D1 -4			S5688B	DIODE		
△ D1 -4			1SR139-400	DIODE		
D5			MTZJ6.2(B)	ZENER DIODE		
D5			RD6.2ES(B2)	ZENER DIODE		
△ D6 ,7			HSS104A	DIODE		
△ D6 ,7			1SS133	DIODE		
△ D8			MTZJ2.7(B)	ZENER DIODE		
△ D8			RD2.7ES(B2)	ZENER DIODE		
△ D9			HSS104A	DIODE		
△ D9			1SS133	DIODE		
△ Q1			2SC3940A(R,S)	TRANSISTOR		
△ Q2			2SC2003(L,K)	TRANSISTOR		
MPX (SAP) UNIT (X04-1320-10) VR-257 ONLY						
C1 ,2			CE04LW1H100M	ELECTRO 10UF 50WV		
C3 ,4			CQ92FM1H102J	MYLAR 1000PF J		
C5			CE04LW1C470M	ELECTRO 47UF 16WV		
C6 ,7			CE04LW1H100M	ELECTRO 10UF 50WV		
C8 ,9			CC45FCH1H101J	CERAMIC 100PF J		
C10 ,11			CQ92FM1H102J	MYLAR 1000PF J		
C14 ,15			CQ92FM1H102J	MYLAR 1000PF J		
C16 ,17			CE04LW1C470M	ELECTRO 47UF 16WV		
C41			CK45FB1H102K	CERAMIC 1000PF K		
C42			CC45FCH1H470J	CERAMIC 47PF J		
C43			CK45FB1H102K	CERAMIC 1000PF K		
CN4			E40-4372-05	PIN ASSY		
CN5			E40-3259-05	PIN ASSY		
J1			E04-0026-05	RF COAXIAL CABLE RECEPTACLE		
J2			E13-0194-05	PHONO JACK (1P)		
L41 ,42		*	L40-1091-82	SMALL FIXED INDUCTOR(1.0UH)		
R27			RD14NB2E391J	RD 390 J 1/4W		
R28			RS14KB3A151J	FL-PROOF RS 150 J 1W		
VR1			R32-0036-05	SEMI FIXED VARIABLE RESISTOR		
D1			HSS104A	DIODE		
D1			1SS133	DIODE		
D2			MTZJ3.3(B)	ZENER DIODE		
D2			RD3.3ES(B2)	ZENER DIODE		
D3 ,4			MTZJ8.2(B)	ZENER DIODE		
D3 ,4			RD8.2ES(B2)	ZENER DIODE		
D5			MTZJ5.1(B)	ZENER DIODE		
D5			RD5.1ES(B2)	ZENER DIODE		
D41 -44			HSS104A	DIODE		
D41 -44			1SS133	DIODE		
IC1 ,2			NJM4565D	ANALOGUE IC		
IC3			BU4052BC	MOS-IC		
Q1			DTA124ESA	DIGITAL TRANSISTOR		
Q1			UN4112	DIGITAL TRANSISTOR		
Q2 ,3			DTC124ESA	DIGITAL TRANSISTOR		

L : Scandinavia K : USA P : Canada R : Mexico C : China I : Malaysia
Y : PX(Far East, Hawaii) T : Europe E : Europe G : Germany V : China (Shanghai)
Y : AAFES(Europe) X : Australia Q : Russia H : Korea M : Other Areas △ indicates safety critical components.

* New Parts
 Parts without **Parts No.** are not supplied.
 Les articles non mentionnés dans le **Parts No.** ne sont pas fournis.
 Teile ohne **Parts No.** werden nicht geliefert.



Ref. No	Add-ress	New Parts	Parts No.	Description	Desti-nation	Re-marks
Q2 ,3			UN4212	DIGITAL TRANSISTOR		
Q4 ,5			2SD1450(S,T)	TRANSISTOR		
Q6 ,7			2SA1048(Y,GR)	TRANSISTOR		
Q6 ,7			2SA1309A(Q,R)	TRANSISTOR		
A1			W02-2635-05	ELECTRIC CIRCUIT MODULE		
TUNER UNIT (X05-482X-XX)						
C1			CK73FB1H223K	CHIP C		
C2			CK73FB1H103K	CHIP C		
C2			CK73FB1H103K	CHIP C		
C3			CK73FB1H103K	CHIP C		
C5 ,6			CK73FB1H103K	CHIP C		
C7			CE04LW1C470M	ELECTRO		
C8			CK73EB1H103K	CHIP C		
C8			CK73EB1H103K	CHIP C		
C8			CK73EB1H103K	CHIP C		
C10			CE04LW1C470M	ELECTRO		
C11 -13			CK73FB1H473K	CHIP C		
C14			CE04LW1C100M	ELECTRO		
C15			CE04LW1H010M	ELECTRO		
C16			C90-3251-05	ELECTRO		
C17			C90-3253-05	ELECTRO		
C18			CC73FCH1H470J	CHIP C		
C19			C90-3217-05	ELECTRO		
C20			CK73FB1H473K	CHIP C		
C21			C90-3241-05	ELECTRO		
C22			CK73FB1H473K	CHIP C		
C23			CE04LW1C100M	ELECTRO		
C24			CK73FB1H331K	CHIP C		
C25			CC73FCH1H181J	CHIP C		
C25			CC73FCH1H181J	CHIP C		
C25			CC73FCH1H391J	CHIP C		
C25			CC73FCH1H391J	CHIP C		
C26			CK73FB1H183K	CHIP C		
C26			CK73FB1H183K	CHIP C		
C26			CK73FB1H223K	CHIP C		
C26			CK73FB1H223K	CHIP C		
C26			CK73FB1H223K	CHIP C		
C27			CE04HW1E4R7M	NP-ELEC		
C28 ,29			C90-3240-05	ELECTRO		
C30 ,31			CK73FB1H223K	CHIP C		
C30 ,31			CK73FB1H223K	CHIP C		
C30 ,31			CK73FB1H333K	CHIP C		
C30 ,31			CK73FB1H333K	CHIP C		
C32			CE04LW1C100M	ELECTRO		
C33 ,34			CK73FB1H103K	CHIP C		
C36			CK73FB1H103K	CHIP C		
C37 ,38			C90-3217-05	ELECTRO		
C39			CC73FCH1H060D	CHIP C		
C40			CC73FCH1H020C	CHIP C		
C41			CC73FCH1H220J	CHIP C		
C42			CC73FCH1H270J	CHIP C		
C43			CC73FCH1H220J	CHIP C		

L : Scandinavia K : USA P : Canada R : Mexico C : China I : Malaysia
 Y : PX(Far East, Hawaii) T : Europe E : Europe G : Germany V : China (Shanghai)
 Y : AAFES(Europe) X : Australia Q : Russia H : Korea M : Other Areas Δ indicates safety critical components.

* New Parts
 Parts without **Parts No.** are not supplied.
 Les articles non mentionnés dans le **Parts No.** ne sont pas fournis.
 Teile ohne **Parts No.** werden nicht geliefert.



Ref. No	Add-ress	New Parts	Parts No.	Description	Desti-nation	Re-marks
C44			CK73FB1H471K	CHIP C		
C45			CC73FCH1H220J	CHIP C		
C46			CE04LW1C100M	ELECTRO		
C47			CK73FB1H102K	CHIP C		
C48			CE04LW1C470M	ELECTRO		
C49			CE04LW1H2R2M	ELECTRO		
C50			CC73FSL1H101J	CHIP C		
C51			CK73FB1H471K	CHIP C		
C52			CC73FSL1H101J	CHIP C		
C70 ,71			CK73FB1H822K	CHIP C		
C70 ,71			CK73FB1H822K	CHIP C		
C72			CE04LW1H010M	ELECTRO		
C73			CE04LW1C470M	ELECTRO		
C75			CC73FCH1H040C	CHIP C		
C76			CC73FCH1H470J	CHIP C		
C78			CK73FB1H223K	CHIP C		
C79 ,80			CK73FB1H472K	CHIP C		
C79 ,80			CK73FB1H472K	CHIP C		
C81			CK73FF1C105Z	CHIP C		
C82			CK73FB1H103K	CHIP C		
C82			CK73FB1H103K	CHIP C		
C83			CC73FSL1H101J	CHIP C		
C84 ,85			CK73FB1H223K	CHIP C		
C86			CK73FB1H471K	CHIP C		
CN1			E40-9831-05	SOCKET FOR PIN ASSY		
CN1			E40-9831-05	SOCKET FOR PIN ASSY		
CN1			E40-9831-05	SOCKET FOR PIN ASSY		
CN1			E40-9831-05	SOCKET FOR PIN ASSY		
CN2			E40-4871-05	PIN ASSY		
CN2			E70-0080-05	LOCK TERMINAL BOARD		
CF1 ,2			L72-0531-05	CERAMIC FILTER		
CF1 ,2			L72-0531-05	CERAMIC FILTER		
CF1 ,2		*	L72-0536-05	CERAMIC FILTER		
CF1 ,2		*	L72-0536-05	CERAMIC FILTER		
CF1 ,2			L72-0596-05	CERAMIC FILTER		
CF1 ,2		*	L72-0596-05	CERAMIC FILTER		
CF3		*	L72-0607-05	CERAMIC FILTER		
CF3		*	L72-0607-05	CERAMIC FILTER		
CF3		*	L72-0607-05	CERAMIC FILTER		
L1			L39-1366-05	COMBINATION COIL		
L2			L40-1091-82	SMALL FIXED INDUCTOR(1.0UH)		
L3			L30-0911-05	AM IFT		
L4			L30-0950-05	FM IFT		
L4			L30-0950-05	FM IFT		
L5			L30-0951-05	FM IFT		
L5			L30-0951-05	FM IFT		
L6 ,7			L79-1239-05	LC FILTER		
L6 ,7			L79-1239-05	LC FILTER		
L9		*	L40-1001-82	SMALL FIXED INDUCTOR(10UH)		
X1		*	L77-2187-05	CRYSTAL RESONATOR		
R1			RK73FB2A101J	CHIP R		
R3			RK73FB2A332J	CHIP R		
R3			RK73FB2A332J	CHIP R		

L : Scandinavia K : USA P : Canada R : Mexico C : China I : Malaysia
 Y : PX(Far East, Hawaii) T : Europe E : Europe G : Germany V : China (Shanghai)
 Y : AAFES(Europe) X : Australia Q : Russia H : Korea M : Other Areas Δ indicates safety critical components.

KRF-V5010W6010W7010WR-205/206/207/255/257
PARTS LIST

* New Parts
 Parts without **Parts No.** are not supplied.
 Les articles non mentionnés dans le **Parts No.** ne sont pas fournis.
 Teile ohne **Parts No.** werden nicht geliefert.



Ref. No	Add-ress	New Parts	Parts No.	Description	Desti-nation	Re-marks
R4			RK73FB2A681J	CHIP R 680	J 1/10W	
R5			RK73FB2A332J	CHIP R 3.3K	J 1/10W	
R6			RK73FB2A221J	CHIP R 220	J 1/10W	
R7			RK73FB2A821J	CHIP R 820	J 1/10W	
R8			RK73FB2A100J	CHIP R 10	J 1/10W	E1T1Q1
R8			RK73FB2A100J	CHIP R 10	J 1/10W	E2
R8			RK73FB2A330J	CHIP R 33	J 1/10W	KP1Y1
R8			RK73FB2A330J	CHIP R 33	J 1/10W	M1X1K1
R8			RK73FB2A330J	CHIP R 33	J 1/10W	P2K2P3
R9			RK73FB2A391J	CHIP R 390	J 1/10W	
R10			RK73FB2A102J	CHIP R 1.0K	J 1/10W	
R11			RK73FB2A220J	CHIP R 22	J 1/10W	E1T1Q1
R11			RK73FB2A220J	CHIP R 22	J 1/10W	E2
R11			RK73FB2A330J	CHIP R 33	J 1/10W	KP1Y1
R11			RK73FB2A330J	CHIP R 33	J 1/10W	M1X1K1
R11			RK73FB2A330J	CHIP R 33	J 1/10W	P2K2P3
R12			RK73FB2A101J	CHIP R 100	J 1/10W	
R14			RK73FB2A101J	CHIP R 100	J 1/10W	E1T1Q1
R14			RK73FB2A101J	CHIP R 100	J 1/10W	E2
R14			RK73FB2A271J	CHIP R 270	J 1/10W	KP1Y1
R14			RK73FB2A271J	CHIP R 270	J 1/10W	M1X1K1
R14			RK73FB2A271J	CHIP R 270	J 1/10W	P2K2P3
R15			RK73FB2A333J	CHIP R 33K	J 1/10W	E1T1Q1
R15			RK73FB2A333J	CHIP R 33K	J 1/10W	E2
R16			RK73FB2A220J	CHIP R 22	J 1/10W	
R17			RK73FB2A362J	CHIP R 3.6K	J 1/10W	
R18			RK73FB2A302J	CHIP R 3.0K	J 1/10W	
R19			RK73FB2A822J	CHIP R 8.2K	J 1/10W	
R20			RK73FB2A392J	CHIP R 3.9K	J 1/10W	
R23			RK73FB2A153J	CHIP R 15K	J 1/10W	E1T1Q1
R23			RK73FB2A153J	CHIP R 15K	J 1/10W	E2
R23			RK73FB2A332J	CHIP R 3.3K	J 1/10W	KP1Y1
R23			RK73FB2A332J	CHIP R 3.3K	J 1/10W	M1X1K1
R23			RK73FB2A332J	CHIP R 3.3K	J 1/10W	P2K2P3
R25			RK73FB2A183J	CHIP R 18K	J 1/10W	KP1Y1
R25			RK73FB2A183J	CHIP R 18K	J 1/10W	M1X1K1
R25			RK73FB2A183J	CHIP R 18K	J 1/10W	P2K2P3
R25			RK73FB2A273J	CHIP R 27K	J 1/10W	E1T1Q1
R25			RK73FB2A273J	CHIP R 27K	J 1/10W	E2
Δ R27, 28			RK73FB2A432J	CHIP R 4.3K	J 1/10W	E1T1Q1
Δ R27, 28			RK73FB2A432J	CHIP R 4.3K	J 1/10W	E2
Δ R27, 28			RK73FB2A822J	CHIP R 8.2K	J 1/10W	KP1Y1
Δ R27, 28			RK73FB2A822J	CHIP R 8.2K	J 1/10W	M1X1K1
Δ R27, 28			RK73FB2A822J	CHIP R 8.2K	J 1/10W	P2K2P3
R30			RK73FB2A561J	CHIP R 560	J 1/10W	Y1M1
R31			RK73FB2A473J	CHIP R 47K	J 1/10W	Y1M1
R33, 34			RK73FB2A101J	CHIP R 100	J 1/10W	K1P2
R33, 34			RK73FB2A101J	CHIP R 100	J 1/10W	K1P2
R33, 34			RK73FB2A102J	CHIP R 1.0K	J 1/10W	KP1Y1
R33, 34			RK73FB2A102J	CHIP R 1.0K	J 1/10W	M1X1E1
R33, 34			RK73FB2A102J	CHIP R 1.0K	J 1/10W	P3E2
R33, 34			RK73FB2A102J	CHIP R 1.0K	J 1/10W	T1Q1K2
R35			RK73FB2A101J	CHIP R 100	J 1/10W	E1T1Q1
R35			RK73FB2A101J	CHIP R 100	J 1/10W	E2K1P2
R36			RK73FB2A101J	CHIP R 100	J 1/10W	K1P2

L : Scandinavia K : USA P : Canada R : Mexico C : China I : Malaysia
 Y : PX(Far East, Hawaii) T : Europe E : Europe G : Germany V : China (Shanghai)
 Y : AAFES(Europe) X : Australia Q : Russia H : Korea M : Other Areas Δ indicates safety critical components.

* New Parts
 Parts without **Parts No.** are not supplied.
 Les articles non mentionnés dans le **Parts No.** ne sont pas fournis.
 Teile ohne **Parts No.** werden nicht geliefert.



Ref. No	Add-ress	New Parts	Parts No.	Description	Desti-nation	Re-marks
R36			RK73FB2A102J	CHIP R 1.0K	J 1/10W	E1T1Q1
R36			RK73FB2A102J	CHIP R 1.0K	J 1/10W	E2
R37			RK73FB2A392J	CHIP R 3.9K	J 1/10W	E1T1Q1
R37			RK73FB2A392J	CHIP R 3.9K	J 1/10W	K1P2E2
R38			RK73FB2A102J	CHIP R 1.0K	J 1/10W	E1T1Q1
R38			RK73FB2A102J	CHIP R 1.0K	J 1/10W	E2
R39			RK73FB2A103J	CHIP R 10K	J 1/10W	E1T1Q1
R39			RK73FB2A103J	CHIP R 10K	J 1/10W	E2
R42			RK73FB2A103J	CHIP R 10K	J 1/10W	
R43			RK73FB2A221J	CHIP R 220	J 1/10W	
Δ R44			RD14NB2E271J	RD 270	J 1/4W	
R45			RK73EB2B102J	CHIP R 1.0K	J 1/8W	
R46			RK73FB2A102J	CHIP R 1.0K	J 1/10W	
R47			RK73EB2B102J	CHIP R 1.0K	J 1/8W	
R48			RK73FB2A102J	CHIP R 1.0K	J 1/10W	
R49			RK73FB2A103J	CHIP R 10K	J 1/10W	
R50			RD14NB2E471J	RD 470	J 1/4W	
R51			RK73FB2A562J	CHIP R 5.6K	J 1/10W	
R52			RK73FB2A101J	CHIP R 100	J 1/10W	
R53			RK73FB2A222J	CHIP R 2.2K	J 1/10W	
R54			RK73FB2A102J	CHIP R 1.0K	J 1/10W	
R55			RK73FB2A333J	CHIP R 33K	J 1/10W	
R56, 57			RK73FB2A102J	CHIP R 1.0K	J 1/10W	
R58			RK73FB2A123J	CHIP R 12K	J 1/10W	
R59			RK73FB2A122J	CHIP R 1.2K	J 1/10W	
R72, 73			RK73FB2A153J	CHIP R 15K	J 1/10W	KP1K1
R72, 73			RK73FB2A153J	CHIP R 15K	J 1/10W	P2K2P3
R72, 73			RK73FB2A392J	CHIP R 3.9K	J 1/10W	E1T1Q1
R72, 73			RK73FB2A392J	CHIP R 3.9K	J 1/10W	E2
R72, 73			RK73FB2A822J	CHIP R 8.2K	J 1/10W	Y1M1X1
R74			RK73FB2A473J	CHIP R 47K	J 1/10W	KP1Y1
R74			RK73FB2A473J	CHIP R 47K	J 1/10W	M1X1E1
R74			RK73FB2A473J	CHIP R 47K	J 1/10W	P3E2
R74			RK73FB2A473J	CHIP R 47K	J 1/10W	T1Q1K2
R75			RK73FB2A822J	CHIP R 8.2K	J 1/10W	KP1Y1
R75			RK73FB2A822J	CHIP R 8.2K	J 1/10W	M1X1E1
R75			RK73FB2A822J	CHIP R 8.2K	J 1/10W	P3E2
R75			RK73FB2A822J	CHIP R 8.2K	J 1/10W	T1Q1K2
R76			RK73FB2A182J	CHIP R 1.8K	J 1/10W	KP1Y1
R76			RK73FB2A182J	CHIP R 1.8K	J 1/10W	M1X1E1
R76			RK73FB2A182J	CHIP R 1.8K	J 1/10W	P3E2
R76			RK73FB2A182J	CHIP R 1.8K	J 1/10W	T1Q1K2
R78			RK73FB2A821J	CHIP R 820	J 1/10W	KP1Y1
R78			RK73FB2A821J	CHIP R 820	J 1/10W	M1X1E1
R78			RK73FB2A821J	CHIP R 820	J 1/10W	P3E2
R78			RK73FB2A821J	CHIP R 820	J 1/10W	T1Q1K2
R80			RK73FB2A223J	CHIP R 22K	J 1/10W	E1T1Q1
R80			RK73FB2A223J	CHIP R 22K	J 1/10W	E2
R81			RS14KB3A151J	FL-PROOF RS 150	J 1W	
R82			RK73FB2A272J	CHIP R 2.7K	J 1/10W	E1T1Q1
R82			RK73FB2A272J	CHIP R 2.7K	J 1/10W	E2
R83			RK73FB2A102J	CHIP R 1.0K	J 1/10W	
R84			RK73EB2B102J	CHIP R 1.0K	J 1/8W	
R85 -87			RK73FB2A105J	CHIP R 1.0M	J 1/10W	
R88			RK73FB2A563J	CHIP R 56K	J 1/10W	

L : Scandinavia K : USA P : Canada R : Mexico C : China I : Malaysia
 Y : PX(Far East, Hawaii) T : Europe E : Europe G : Germany V : China (Shanghai)
 Y : AAFES(Europe) X : Australia Q : Russia H : Korea M : Other Areas Δ indicates safety critical components.

* New Parts

Parts without **Parts No.** are not supplied.
Les articles non mentionnés dans le **Parts No.** ne sont pas fournis.
Teile ohne **Parts No.** werden nicht geliefert.

13

Ref. No	Address	New Parts	Parts No.	Description	Destination	Remarks
VR1			R32-0037-05	SEMI FIXED VARIABLE RESISTOR		
W51_55			R92-0670-05	CHIP R 0 OHM	K1P2	
W51_52			R92-0670-05	CHIP R 0 OHM	KP1Y1	
W51_52			R92-0670-05	CHIP R 0 OHM	M1X1E1	
W51_52			R92-0670-05	CHIP R 0 OHM	P3E2	
W51_52			R92-0670-05	CHIP R 0 OHM	T1Q1K2	
W54_57			R92-0670-05	CHIP R 0 OHM	Y1M1	
W54_55			R92-0670-05	CHIP R 0 OHM	E1T1Q1	
W54_55			R92-0670-05	CHIP R 0 OHM	KP1X1	
W54_55			R92-0670-05	CHIP R 0 OHM	K2P3E2	
W57			R92-0670-05	CHIP R 0 OHM	E1T1K2	
W57			R92-0670-05	CHIP R 0 OHM	KP1X1	
W57			R92-0670-05	CHIP R 0 OHM	P3	
W57_60			R92-0670-05	CHIP R 0 OHM	E2	
W57_60			R92-0670-05	CHIP R 0 OHM	Q1K1P2	
W59_60			R92-0670-05	CHIP R 0 OHM	KP1Y1	
W59_60			R92-0670-05	CHIP R 0 OHM	M1X1E1	
W59_60			R92-0670-05	CHIP R 0 OHM	T1K2P3	
W80			R92-0679-05	CHIP R 0 OHM		
W82_85			R92-0679-05	CHIP R 0 OHM	KP1Y1	
W82_85			R92-0679-05	CHIP R 0 OHM	M1X1K2	
W82_85			R92-0679-05	CHIP R 0 OHM	P3	
W82_86			R92-0679-05	CHIP R 0 OHM	K1P2	
W84_86			R92-0679-05	CHIP R 0 OHM	Q1E2	
W84_85			R92-0679-05	CHIP R 0 OHM	E1T1	
D1			DA204U	DIODE		
D1			MA143A	DIODE		
D1			1SS302	DIODE		
D3			MTZJ8.2(B)	ZENER DIODE		
D3			RD8.2ES(B2)	ZENER DIODE		
D4			MTZJ5.1(B)	ZENER DIODE		
D4			RD5.1ES(B2)	ZENER DIODE		
D5			MTZJ2.7(B)	ZENER DIODE		
D5			RD2.7ES(B2)	ZENER DIODE		
D8			MA111	DIODE		
D9			MTZJ3.3(B)	ZENER DIODE	KP1Y1	
D9			MTZJ3.3(B)	ZENER DIODE	M1X1E1	
D9			MTZJ3.3(B)	ZENER DIODE	P3E2	
D9			MTZJ3.3(B)	ZENER DIODE	T1Q1K2	
D9			RD3.3ES(B2)	ZENER DIODE	KP1Y1	
D9			RD3.3ES(B2)	ZENER DIODE	M1X1E1	
D9			RD3.3ES(B2)	ZENER DIODE	P3E2	
D9			RD3.3ES(B2)	ZENER DIODE	T1Q1K2	
D11			MA111	DIODE	E1T1Q1	
D11			MA111	DIODE	E2	
D13			MA111	DIODE		
IC1			LA1837	ANALOGUE IC	E1T1Q1	
IC1			LA1837	ANALOGUE IC	E2	
IC1			LA1838	ANALOGUE IC	KP1Y1	
IC1			LA1838	ANALOGUE IC	M1X1K1	
IC1			LA1838	ANALOGUE IC	P2K2P3	
IC2			LC72131	MOS-IC		
Q1			2SC4081(R,S)	TRANSISTOR		
Q1			2SC4116(Y,GR)	TRANSISTOR		
Q2			2SA1576A(R,S)	TRANSISTOR		

L : Scandinavia K : USA P : Canada R : Mexico C : China I : Malaysia

Y : PX(Far East, Hawaii) T : Europe E : Europe G : Germany V : China (Shanghai)

Y : AAFES(Europe) X : Australia Q : Russia H : Korea M : Other Areas Δ indicates safety critical components.

* New Parts

Parts without **Parts No.** are not supplied.
Les articles non mentionnés dans le **Parts No.** ne sont pas fournis.
Teile ohne **Parts No.** werden nicht geliefert.

14

Ref. No	Address	New Parts	Parts No.	Description	Destination	Remarks
Q2			2SA1586(Y,GR)	TRANSISTOR		
Q3_4			2SC4081(R,S)	TRANSISTOR		Y1M1
Q3_4			2SC4116(Y,GR)	TRANSISTOR		Y1M1
Q6			2SC4081(R,S)	TRANSISTOR		E1T1Q1
Q6			2SC4081(R,S)	TRANSISTOR		E2
Q6			2SC4116(Y,GR)	TRANSISTOR		E1T1Q1
Q6			2SC4116(Y,GR)	TRANSISTOR		E2
Q7			2SC4081(R,S)	TRANSISTOR		E1T1Q1
Q7			2SC4081(R,S)	TRANSISTOR		E2K1P2
Q7			2SC4116(Y,GR)	TRANSISTOR		E1T1Q1
Q7			2SC4116(Y,GR)	TRANSISTOR		E2
Q7			2SC4116(Y,GR)	TRANSISTOR		E1T1Q1
Q7			2SC4116(Y,GR)	TRANSISTOR		E2
Q7			2SC4116(Y,GR)	TRANSISTOR		E1T1Q1
Q7			2SC4116(Y,GR)	TRANSISTOR		E2
Q7			2SC4116(Y,GR)	TRANSISTOR		E1T1Q1
Q7			2SC4116(Y,GR)	TRANSISTOR		E2
Q10_11			2SD1757K	TRANSISTOR		E2K1P2
Q10_11			2SD1757K	TRANSISTOR		KP1Y1
Q10_11			2SD1757K	TRANSISTOR		M1X1E1
Q10_11			2SD1757K	TRANSISTOR		P3E2
Q10_11			2SD1757K	TRANSISTOR		T1Q1K2
Q12			2SA1576A(R,S)	TRANSISTOR		KP1Y1
Q12			2SA1576A(R,S)	TRANSISTOR		M1X1E1
Q12			2SA1576A(R,S)	TRANSISTOR		P3E2
Q12			2SA1576A(R,S)	TRANSISTOR		T1Q1K2
Q12			2SA1586(Y,GR)	TRANSISTOR		KP1Y1
Q12			2SA1586(Y,GR)	TRANSISTOR		M1X1E1
Q12			2SA1586(Y,GR)	TRANSISTOR		P3E2
Q12			2SA1586(Y,GR)	TRANSISTOR		T1Q1K2
Q14			2SA1576A(R,S)	TRANSISTOR		
Q14			2SA1586(Y,GR)	TRANSISTOR		
A1			W02-2584-05	FM FRONT-END ASSY		E1T1
A1			W02-2586-05	FM FRONT-END ASSY		E2
A1			W02-2586-05	FM FRONT-END ASSY		Q1K1P2
A1			W02-2622-05	FM FRONT-END ASSY		KP1Y1
A1			W02-2622-05	FM FRONT-END ASSY		M1X1K2
A1			W02-2622-05	FM FRONT-END ASSY		P3

AUDIO UNIT(X09-490X-XX)

D501,502			B30-2513-05	LED(RED)		K1P2	7
D527			B30-2513-05	LED(RED)			
D528			B30-2513-05	LED(RED)		K1P2	7
C1_2			CC73FSL1H390J	CHIP C 39PF	J		
C3_4			CE04LW1C100M	ELECTRO 10UF	16WV		
C5_6			CC73FSL1H221J	CHIP C 220PF	J		
C7_8			CE04LW1A470M	ELECTRO 47UF	10WV		
C11_12			CQ93FMG1H123J	MYLAR 0.012UF	J		
C13_14			CQ93FMG1H332J	MYLAR 3300PF	J		
C15_16			CE04LW1V4R7M	ELECTRO 4.7UF	35WV		
C17			CC45FSL1H101J	CERAMIC 100PF	J		
C18			CK45FF1H103Z	CERAMIC 0.010UF	Z		
C19_36			CC73FSL1H221J	CHIP C 220PF	J		
C37_41			CC73FCH1H470J	CHIP C 47PF	J		
C42_43			CK45FF1H103Z	CERAMIC 0.010UF	Z		
C44			CC73FSL1H471J	CHIP C 470PF	J		
C45_46			CE04LW1H2R2M	ELECTRO 2.2UF	50WV		
C47_48			CC73FSL1H101J	CHIP C 100PF	J		
C51			CK45FB1H391K	CERAMIC 390PF	K		
C52			CK45FF1H103Z	CERAMIC 0.010UF	Z		
C53_54			CC73FSL1H101J	CHIP C 100PF	J		
C55_56			CE04LW1C220M	ELECTRO 22UF	16WV		

L : Scandinavia K : USA P : Canada R : Mexico C : China I : Malaysia

Y : PX(Far East, Hawaii) T : Europe E : Europe G : Germany V : China (Shanghai)

Y : AAFES(Europe) X : Australia Q : Russia H : Korea M : Other Areas Δ indicates safety critical components.

KRF-V5010W6010N/7010VR-205/206/207/255/257
PARTS LIST

* New Parts
Parts without **Parts No.** are not supplied.
Les articles non mentionnés dans le **Parts No.** ne sont pas fournis.
Teile ohne **Parts No.** werden nicht geliefert.

15

Ref. No	Add-ress	New Parts	Parts No.	Description	Desti-nation	Re-marks
C61-63			CE04LW1C100M	ELECTRO 10UF 16WV		
C93,94			CK45FF1H103Z	CERAMIC 0.010UF Z		
C95			CC73FSL1H471J	CHIP C 470PF J		
C98,99			CE04LW1A101M	ELECTRO 100UF 10WV		
C100,101			CE04LW1C100M	ELECTRO 10UF 16WV		
C104,105			CK73FB1H153K	CHIP C 0.015UF K		
C106,107			CE04LW1HR33M	ELECTRO 0.33UF 50WV		
C108,109			CQ93FMG1H822J	MYLAR 8200PF J		
C110			CC73FSL1H471J	CHIP C 470PF J		
C111-118			CE04LW1V4R7M	ELECTRO 4.7UF 35WV		
C119,120			CE04LW1H3R3M	ELECTRO 3.3UF 50WV		
C121			CC73FSL1H221J	CHIP C 220PF J		
C122			CE04LW1H010M	ELECTRO 1.0UF 50WV		
C123-126			CC73FSL1H101J	CHIP C 100PF J		
C127,128			CE04LW1C100M	ELECTRO 10UF 16WV		
C129			CE04LW1C101M	ELECTRO 100UF 16WV		
C130			CE04LW1C470M	ELECTRO 47UF 16WV		
C131-134			CE04LW1C100M	ELECTRO 10UF 16WV		
C135			CK73FB1C104K	CHIP C 0.10UF K		
C136			CK73FB1H562K	CHIP C 5600PF K		
C137			CE04LW1C100M	ELECTRO 10UF 16WV		
C138			CE04LW1E221M	ELECTRO 220UF 25WV		
C139			CE04LW1C470M	ELECTRO 47UF 16WV		
C140,141			CK73FF1E104Z	CHIP C 0.10UF Z		
C142			CK73FB1H681K	CHIP C 680PF K		
C143,144			CK73FF1E104Z	CHIP C 0.10UF Z		
C145			CK73FB1H681K	CHIP C 680PF K		
C146			CQ93FMG1H104J	MYLAR 0.10UF J		
C147,148			CQ93FMG1H223J	MYLAR 0.022UF J		
C149,150			CK73FB1C104K	CHIP C 0.10UF K		
C151,152			CQ93FMG1H473J	MYLAR 0.047UF J		
C153			CK73FB1C104K	CHIP C 0.10UF K		
C154			CK73FF1C224Z	CHIP C 0.22UF Z		
C155			CQ93FMG1H224J	MYLAR 0.22UF J		
C156,157			CE04LW1V4R7M	ELECTRO 4.7UF 35WV		
C158			CQ93FMG1H224J	MYLAR 0.22UF J		
C159			CK73FF1C224Z	CHIP C 0.22UF Z		
C160			CK73FF1C105Z	CHIP C 1.0UF Z		
C161			CK73EB1E473K	CHIP C 0.047UF K		
C162			CK73FB1H562K	CHIP C 5600PF K		
C163			CK73FB1H221K	CHIP C 220PF K		
C164			CK73FB1H103K	CHIP C 0.010UF K		
C165			CK73FB1C104K	CHIP C 0.10UF K		
C169			CK73FB1H182K	CHIP C 1800PF K		
C170			CK73FB1H103K	CHIP C 0.010UF K		
C171			CQ93FMG1H683J	MYLAR 0.068UF J		
C172,173			CQ93FMG1H104J	MYLAR 0.10UF J		
C174			CQ93FMG1H683J	MYLAR 0.068UF J		
C175			CQ93FMG1H182J	MYLAR 1800PF J		
C176			CK73FB1H103K	CHIP C 0.010UF K		
C177			CE04LW1H010M	ELECTRO 1.0UF 50WV		
C178			CE04LW1C220M	ELECTRO 22UF 16WV		
C181,182			CE04LW1V4R7M	ELECTRO 4.7UF 35WV		
C183,184			CC73FSL1H471J	CHIP C 470PF J		
C193,194			CE04LW1V4R7M	ELECTRO 4.7UF 35WV		

L: Scandinavia K: USA P: Canada R: Mexico C: China I: Malaysia

Y: PX(Far East, Hawaii) T: Europe E: Europe G: Germany V: China (Shanghai)

Y: AAFES(Europe) X: Australia Q: Russia H: Korea M: Other Areas Δ indicates safety critical components.

* New Parts
Parts without **Parts No.** are not supplied.
Les articles non mentionnés dans le **Parts No.** ne sont pas fournis.
Teile ohne **Parts No.** werden nicht geliefert.

15

Ref. No	Add-ress	New Parts	Parts No.	Description	Desti-nation	Re-marks
C195,196			CC73FSL1H471J	CHIP C 470PF J		
C197			CE04LW1V4R7M	ELECTRO 4.7UF 35WV		
C203			CC45FSL1H101J	CERAMIC 100PF J		
C204			CK45FF1H103Z	CERAMIC 0.010UF Z		
C205			CE04LW1V4R7M	ELECTRO 4.7UF 35WV		
C206			CK45FB1H392K	CERAMIC 3900PF K		5
C206			CK45FB2H392K	CERAMIC 3900PF K		7
C206			CK45FB2H392K	CERAMIC 3900PF K		6
C207,208			CC73FSL1H471J	CHIP C 470PF J		
C212			CC73FSL1H101J	CHIP C 100PF J		
C214			CE04LW1H010M	ELECTRO 1.0UF 50WV		
C215			GE04HW1E220M	NP-ELEC 22UF 25WV		
C216,217			CK73FB1H102K	CHIP C 100PF K		
C218,219			CE04LW1C100M	ELECTRO 10UF 16WV		
C220,221			CE04LW1A101M	ELECTRO 100UF 10WV		
C222,223			CC73FCH1H150J	CHIP C 15PF J		
C224,225			CE04LW2A100M	ELECTRO 10UF 100WV		
C226			CK45FB1H392K	CERAMIC 3900PF K		5
C226			CK45FB2H392K	CERAMIC 3900PF K		7
C226			CK45FB2H392K	CERAMIC 3900PF K		6
C227			CE04LW1H470M	ELECTRO 47UF 50WV		5
C227			CE04LW2A100M	ELECTRO 10UF 100WV		7
C227			CE04LW2A100M	ELECTRO 10UF 100WV		6
C228,229			CE04LW1H470M	ELECTRO 47UF 50WV		7
C228,229			CE04LW1H470M	ELECTRO 47UF 50WV		6
C230,231			CK45FB1H392K	CERAMIC 3900PF K		5
C230,231			CK45FB2H392K	CERAMIC 3900PF K		7
C230,231			CK45FB2H392K	CERAMIC 3900PF K		6
C232			CE04LW1H470M	ELECTRO 47UF 50WV		5
C232			CE04LW2A100M	ELECTRO 10UF 100WV		
C233-235			CK73FB1H102K	CHIP C 1000PF K		
C236-238			CE04LW1C100M	ELECTRO 10UF 16WV		
C239-241			CE04LW1A101M	ELECTRO 100UF 10WV		
C242-244			CC73FCH1H150J	CHIP C 15PF J		
C247,248			CE04LW1H470M	ELECTRO 47UF 50WV		5
C249,250			CE04LW2A100M	ELECTRO 10UF 100WV		
C253-257			CK73FB1H102K	CHIP C 1000PF K		
C258-262			CQ93FMG1H104J	MYLAR 0.10UF J		
C268			CE04LW1V4R7M	ELECTRO 4.7UF 35WV		
C269			GE04LW0J221M	ELECTRO 220UF 6.3WV		
C270			CK45FF1H472Z	CERAMIC 4700PF Z		
C271			CK45FF1H472Z	CERAMIC 4700PF Z		5
C272			CK45FF1H472Z	CERAMIC 4700PF Z	KP1Y1	
C272			CK45FF1H472Z	CERAMIC 4700PF Z	KP1Y11	7
C272			CK45FF1H472Z	CERAMIC 4700PF Z	KP1Y11	6
C272			CK45FF1H472Z	CERAMIC 4700PF Z	M1X1K1	7
C272			CK45FF1H472Z	CERAMIC 4700PF Z	M1X1K1	6
C272			CK45FF1H472Z	CERAMIC 4700PF Z	P2K2P3	7
C272			CK45FF1H472Z	CERAMIC 4700PF Z	P2K2P3	6
C273,274			CK45FF1H472Z	CERAMIC 4700PF Z		7
C273,274			CK45FF1H472Z	CERAMIC 4700PF Z		6
C275,276			CK45FF1H472Z	CERAMIC 4700PF Z	E2	
C277-279			CK45FB1H102K	CERAMIC 1000PF K		6
C277-279			CK45FB1H102K	CERAMIC 1000PF K		7

L: Scandinavia K: USA P: Canada R: Mexico C: China I: Malaysia

Y: PX(Far East, Hawaii) T: Europe E: Europe G: Germany V: China (Shanghai)

Y: AAFES(Europe) X: Australia Q: Russia H: Korea M: Other Areas Δ indicates safety critical components.

* New Parts
 Parts without **Parts No.** are not supplied.
 Les articles non mentionnés dans le **Parts No.** ne sont pas fournis.
 Teile ohne **Parts No.** werden nicht geliefert.



Ref. No	Address	New Parts	Parts No.	Description	Destination	Remarks
C280			CK45FB1H102K	CERAMIC 1000PF K		
C282,283			CC73FSL1H101J	CHIP C 100PF J		
C284,285			CC73FSL1H151J	CHIP C 150PF J		
C300			CQ93FMG1H184J	MYLAR 0.18UF J		
C302			C91-1480-05	MP 0.22UF 250WV	E1T1Q1	
C302			C91-1480-05	MP 0.22UF 250WV	E2	
C302			C91-1480-05	MP 0.22UF 250WV	Y1M1X1	
Δ C304,305			C90-3760-05	ELECTRO 4700UF 75WV	KP1Y1	7
Δ C304,305			C90-3760-05	ELECTRO 4700UF 75WV	KP1Y1	6
Δ C304,305			C90-3760-05	ELECTRO 4700UF 75WV	M1X1K1	7
Δ C304,305			C90-3760-05	ELECTRO 4700UF 75WV	M1X1K1	6
Δ C304,305			C90-3760-05	ELECTRO 4700UF 75WV	P2K2P3	7
Δ C304,305			C90-3761-05	ELECTRO 3300UF 50WV	KP1Y1	5
Δ C304,305			C90-3761-05	ELECTRO 3300UF 50WV	M1X1K1	5
Δ C304,305			C90-3761-05	ELECTRO 3300UF 50WV	P2	5
Δ C304,305			C90-3762-05	ELECTRO 4700UF 63WV	E1T1Q1	7
Δ C304,305			C90-3762-05	ELECTRO 4700UF 63WV	E1T1Q1	6
Δ C304,305			C90-3762-05	ELECTRO 4700UF 63WV	E2	6
Δ C304,305			C90-3762-05	ELECTRO 4700UF 63WV	E2	7
Δ C304,305			C90-3776-05	ELECTRO 3300UF 42WV	E1T1Q1	5
Δ C304,305			C90-3776-05	ELECTRO 3300UF 42WV	E2	5
Δ C306,307			C90-3763-05	ELECTRO 3300UF 35WV	E1T1Q1	7
Δ C306,307			C90-3763-05	ELECTRO 3300UF 35WV	E1T1Q1	6
Δ C306,307			C90-3763-05	ELECTRO 3300UF 35WV	E2	7
Δ C306,307			C90-3763-05	ELECTRO 3300UF 35WV	E2	6
Δ C306,307			C90-3776-05	ELECTRO 3300UF 42WV	KP1Y1	7
Δ C306,307			C90-3776-05	ELECTRO 3300UF 42WV	KP1Y1	6
Δ C306,307			C90-3776-05	ELECTRO 3300UF 42WV	M1X1K1	7
Δ C306,307			C90-3776-05	ELECTRO 3300UF 42WV	M1X1K1	6
Δ C306,307			C90-3776-05	ELECTRO 3300UF 42WV	P2K2P3	7
Δ C306,307			C90-3776-05	ELECTRO 3300UF 42WV	P2K2P3	6
C308			CE04LW1V222M	ELECTRO 2200UF 35WV		
C309			CE04LW1V471M	ELECTRO 470UF 35WV		
C310-313			CK73FF1C224Z	CHIP C 0.22UF Z		
C314,315			CE04LW1E101M	ELECTRO 100UF 25WV		
C316			CE04LW2A220M	ELECTRO 22UF 100WV		
C317			CE04LW1H470M	ELECTRO 47UF 50WV		
C320			CE04LW1H010M	ELECTRO 1.0UF 50WV		
C326			CE04LW1C470M	ELECTRO 47UF 16WV		
C327			CE04LW1H010M	ELECTRO 1.0UF 50WV		
C330			CE04LW1C100M	ELECTRO 10UF 16WV		
C350			CE04LW1A101M	ELECTRO 100UF 10WV		
C351,352			CE04LW1H100M	ELECTRO 10UF 50WV		
C359-363			CE04LW1H010M	ELECTRO 1.0UF 50WV		
C400			CE04LW1C330M	ELECTRO 33UF 16WV		
C501			CK45FF1H103Z	CERAMIC 0.010UF Z		
C502			CQ93FMG1H104J	MYLAR 0.10UF J		
C503			CK45FF1H103Z	CERAMIC 0.010UF Z		
C504			CK73FB1H103K	CHIP C 0.010UF K		
C505			CK45FF1H103Z	CERAMIC 0.010UF Z		
C506			CK45FB1H102K	CERAMIC 1000PF K		
C507			CK45FF1H103Z	CERAMIC 0.010UF Z		
C508,509			CE04LW1A101M	ELECTRO 100UF 10WV		
C510			CC45FSL1H331J	CERAMIC 330PF J	E1T1Q1	

L: Scandinavia K: USA P: Canada R: Mexico C: China I: Malaysia
 Y: PX(Far East, Hawaii) T: Europe E: Europe G: Germany V: China (Shanghai)
 Y: AAFES(Europe) X: Australia Q: Russia H: Korea M: Other Areas Δ indicates safety critical components.

* New Parts
 Parts without **Parts No.** are not supplied.
 Les articles non mentionnés dans le **Parts No.** ne sont pas fournis.
 Teile ohne **Parts No.** werden nicht geliefert.



Ref. No	Address	New Parts	Parts No.	Description	Destination	Remarks
C510			CC45FSL1H331J	CERAMIC 330PF J	E2	
C511			CK73FB1H103K	CHIP C 0.010UF K		
C512,513			CK45FF1H103Z	CERAMIC 0.010UF Z		
C514			CK73FB1H103K	CHIP C 0.010UF K		
C515			CK45FB1H561K	CERAMIC 560PF K	E1T1Q1	
C515			CK45FB1H561K	CERAMIC 560PF K	E2	
C516			CE04LW1H2R2M	ELECTRO 2.2UF 50WV	E1T1Q1	
C516			CE04LW1H2R2M	ELECTRO 2.2UF 50WV	E2	
C517			CE04LW1H010M	ELECTRO 1.0UF 50WV		
C518			CK73FB1H103K	CHIP C 0.010UF K		
C519-521			CK45FF1H103Z	CERAMIC 0.010UF Z		
C522			CK45FF1H103Z	CERAMIC 0.010UF Z	E1T1Q1	
C522			CK45FF1H103Z	CERAMIC 0.010UF Z	E2	
C523			CE04LW1A101M	ELECTRO 100UF 10WV	E1T1Q1	
C523			CE04LW1A101M	ELECTRO 100UF 10WV	E2	
C524			CK45FF1H103Z	CERAMIC 0.010UF Z	E1T1Q1	
C524			CK45FF1H103Z	CERAMIC 0.010UF Z	E2	
C525			CE04LW1H010M	ELECTRO 1.0UF 50WV		
C526			C90-3214-05	ELECTRO 100UF 6.3WV		
C527			CC73FCH1H470J	CHIP C 47PF J	E1T1Q1	
C527			CC73FCH1H470J	CHIP C 47PF J	E2	
C528			CC73FCH1H180J	CHIP C 18PF J	E1T1Q1	
C528			CC73FCH1H180J	CHIP C 18PF J	E2	
C529,530			GE04LW1V4R7M	ELECTRO 4.7UF 35WV		
C531			CK73FB1H103K	CHIP C 0.010UF K		
C532			CK73FB1H102K	CHIP C 1000PF K	E1T1Q1	
C533			CK73EB1H102K	CHIP C 1000PF K	E2	
C533			CK73EB1H102K	CHIP C 1000PF K	E1T1Q1	
C534			C90-1827-05	ELECTRO 0.047F 5.5WV	E1T1Q1	
C534			C90-1827-05	ELECTRO 0.047F 5.5WV	E2	
C534			C90-1827-05	ELECTRO 0.047F 5.5WV		
C534			C90-1827-05	ELECTRO 0.047F 5.5WV		
C534			C90-1827-05	ELECTRO 0.047F 5.5WV		
C535			CE04LW0J471M	ELECTRO 470UF 6.3WV	Y1M1X1	
C535			CE04LW0J471M	ELECTRO 470UF 6.3WV	KP1K1	
C535			CE04LW0J471M	ELECTRO 470UF 6.3WV	P2K2P3	
CN1			E40-4299-05	PIN ASSY		
CN2			E40-4248-05	PIN ASSY		
CN7			E40-8196-05	PIN ASSY		
CN8		*	E40-8260-05	FLAT CABLE CONNECTOR		
CN9			E40-8251-05	FLAT CABLE CONNECTOR		
CN10			E40-9848-05	PIN ASSY	KP1Y1	
CN10			E40-9848-05	PIN ASSY	M1X1E1	
CN10			E40-9848-05	PIN ASSY	P3E2	
CN10			E40-9848-05	PIN ASSY	T1Q1K2	
CN51		*	E40-8259-05	FLAT CABLE CONNECTOR		
CN53			E40-8250-05	FLAT CABLE CONNECTOR		
J1			E63-0172-05	PHONO JACK		
J2			E63-0173-05	PHONO JACK		
J3,4			E63-1017-05	PHONO JACK		
J5			E63-1018-05	PHONO JACK		
J6			E63-1019-05	PHONO JACK		
J7			E63-0172-05	PHONO JACK		
J8			E70-0082-05	LOCK TERMINAL BOARD		5
J8			E70-0082-05	LOCK TERMINAL BOARD		6
J8			E70-0082-05	LOCK TERMINAL BOARD	KP1Y1	7
J8			E70-0082-05	LOCK TERMINAL BOARD		
J8			E70-0082-05	LOCK TERMINAL BOARD	M1X1K1	7
J8			E70-0082-05	LOCK TERMINAL BOARD	P2K2P3	7
J9			E63-1015-05	PHONO JACK		7

L: Scandinavia K: USA P: Canada R: Mexico C: China I: Malaysia
 Y: PX(Far East, Hawaii) T: Europe E: Europe G: Germany V: China (Shanghai)
 Y: AAFES(Europe) X: Australia Q: Russia H: Korea M: Other Areas Δ indicates safety critical components.

KRF-V5010W6010W7010WR-205/206/207/255/257
PARTS LIST

* New Parts
Parts without **Parts No.** are not supplied.
Les articles non mentionnés dans le **Parts No.** ne sont pas fournis.
Teile ohne **Parts No.** werden nicht geliefert.

19

Ref. No	Add-ress	New Parts	Parts No.	Description	Desti-nation	Re-marks
J9			E63-1015-05	PHONO JACK		6
J10			E70-0068-05	LOCK TERMINAL BOARD		7
J10			E70-0068-05	LOCK TERMINAL BOARD		6
J10			E70-0094-05	LOCK TERMINAL BOARD		5
J11			E63-1016-05	PHONO JACK		5
-			J19-5879-13	HOLDER		
L1 -5			L39-1373-05	PHASE COMPENSATION COIL		
L501			L40-1091-82	SMALL FIXED INDUCTOR(1.0UH)	E1T1Q1	
L501			L40-1091-82	SMALL FIXED INDUCTOR(1.0UH)	E2	
L502			L40-1001-82	SMALL FIXED INDUCTOR(10UH)	E1T1Q1	
L502			L40-1001-82	SMALL FIXED INDUCTOR(10UH)	E2	
X1		*	L78-0244-05	RESONATOR (4MHZ)		
X501			L78-0290-05	RESONATOR (8MHZ)		
X502			L77-2206-05	CRYSTAL RESONATOR(4.332MHZ)	E1T1Q1	
X502			L77-2206-05	CRYSTAL RESONATOR(4.332MHZ)	E2	
R1 ,2			RK73FB2A102J	CHIP R 1.0K	J 1/10W	
R3 ,4			RK73FB2A273J	CHIP R 27K	J 1/10W	
R5 ,6			RK73FB2A101J	CHIP R 100	J 1/10W	
R13 ,14			RK73FB2A473J	CHIP R 47K	J 1/10W	
R17 ,18			RK73FB2A102J	CHIP R 1.0K	J 1/10W	
R19 ,20			RK73FB2A224J	CHIP R 220K	J 1/10W	
R21 -24			RK73FB2A102J	CHIP R 1.0K	J 1/10W	
R25 ,26			RK73FB2A224J	CHIP R 220K	J 1/10W	
R27 ,28			RK73FB2A102J	CHIP R 1.0K	J 1/10W	
R29 ,30			RK73FB2A224J	CHIP R 220K	J 1/10W	
R31 ,32			RK73FB2A102J	CHIP R 1.0K	J 1/10W	
R33 ,34			RK73FB2A224J	CHIP R 220K	J 1/10W	
R35 ,36			RK73FB2A102J	CHIP R 1.0K	J 1/10W	
R37 ,38			RK73FB2A224J	CHIP R 220K	J 1/10W	
R39 ,40			RK73FB2A102J	CHIP R 1.0K	J 1/10W	
R41 ,42			RK73FB2A224J	CHIP R 220K	J 1/10W	
R43			RK73FB2A102J	CHIP R 1.0K	J 1/10W	
R44			RK73FB2A103J	CHIP R 10K	J 1/10W	
R45			RK73FB2A224J	CHIP R 220K	J 1/10W	
R46			RK73FB2A392J	CHIP R 3.9K	J 1/10W	
R47 ,48			RK73FB2A102J	CHIP R 1.0K	J 1/10W	
R49 ,50			RK73FB2A224J	CHIP R 220K	J 1/10W	
R51 -53			RK73FB2A750J	CHIP R 75	J 1/10W	
R56 ,57			RK73FB2A332J	CHIP R 3.3K	J 1/10W	
R59 -62			RK73FB2A224J	CHIP R 220K	J 1/10W	
R67 ,68			RK73FB2A224J	CHIP R 220K	J 1/10W	
R69 ,70			RK73FB2A4R7J	CHIP R 4.7	J 1/10W	
R71 ,72			RK73FB2A224J	CHIP R 220K	J 1/10W	
R93 ,94			RS14KB3A391J	FL-PROOF RS 390	J 1W	
R97			RK73EB2B224J	CHIP R 220K	J 1/8W	
R98 -102			RK73FB2A224J	CHIP R 220K	J 1/10W	
R109			RS14KB3A221J	FL-PROOF RS 220	J 1W	
R110			RS14KB3A271J	FL-PROOF RS 270	J 1W	
R111-113			RK73FB2A102J	CHIP R 1.0K	J 1/10W	
R116,117			RK73FB2A102J	CHIP R 1.0K	J 1/10W	
R118			RK73FB2A473J	CHIP R 47K	J 1/10W	
R119			RK73FB2A223J	CHIP R 22K	J 1/10W	
R122			RK73FB2A473J	CHIP R 47K	J 1/10W	
R123			RK73FB2A203J	CHIP R 20K	J 1/10W	
R124			RK73FB2A105J	CHIP R 1.0M	J 1/10W	

L : Scandinavia K : USA P : Canada R : Mexico C : China I : Malaysia
Y : PX(Far East, Hawaii) T : Europe E : Europe G : Germany V : China (Shanghai)
Y : AAFES(Europe) X : Australia Q : Russia H : Korea M : Other Areas Δ indicates safety critical components.

* New Parts
Parts without **Parts No.** are not supplied.
Les articles non mentionnés dans le **Parts No.** ne sont pas fournis.
Teile ohne **Parts No.** werden nicht geliefert.

20

Ref. No	Add-ress	New Parts	Parts No.	Description	Desti-nation	Re-marks
R125			RK73FB2A224J	CHIP R 220K	J 1/10W	
R126			RK73FB2A104J	CHIP R 100K	J 1/10W	
R127			RK73FB2A225J	CHIP R 2.2M	J 1/10W	
R128			RK73FB2A752J	CHIP R 7.5K	J 1/10W	
R129			RK73FB2A153J	CHIP R 15K	J 1/10W	
R130			RK73FB2A473J	CHIP R 47K	J 1/10W	
R131			RK73FB2A752J	CHIP R 7.5K	J 1/10W	
R132			RK73FB2A153J	CHIP R 15K	J 1/10W	
R133			RK73FB2A473J	CHIP R 47K	J 1/10W	
R134			RD14NB2E221J	RD 220	J 1/4W	
R135			RS14KB3D680J	FL-PROOF RS 68	J 2W	
R136			RK73FB2A334J	CHIP R 330K	J 1/10W	
R137,138			RK73FB2A243J	CHIP R 24K	J 1/10W	
R145,146			RK73FB2A122J	CHIP R 1.2K	J 1/10W	
R147,148			RK73FB2A102J	CHIP R 1.0K	J 1/10W	
R149,150			RK73FB2A104J	CHIP R 100K	J 1/10W	
R157,158			RK73FB2A222J	CHIP R 2.2K	J 1/10W	
R161,162			RK73FB2A122J	CHIP R 1.2K	J 1/10W	
R163,164			RK73FB2A102J	CHIP R 1.0K	J 1/10W	
R165,166			RK73FB2A104J	CHIP R 100K	J 1/10W	
R173,174			RK73FB2A222J	CHIP R 2.2K	J 1/10W	
R177,178			RK73FB2A122J	CHIP R 1.2K	J 1/10W	
R179,180			RK73FB2A102J	CHIP R 1.0K	J 1/10W	
R181,182			RK73FB2A104J	CHIP R 100K	J 1/10W	
R183			RK73FB2A153J	CHIP R 15K	J 1/10W	
R184			RK73FB2A391J	CHIP R 390	J 1/10W	
R186			RK73FB2A183J	CHIP R 18K	J 1/10W	
R189,190			RK73FB2A222J	CHIP R 2.2K	J 1/10W	
R191			RK73FB2A104J	CHIP R 100K	J 1/10W	
R192,193			RK73FB2A102J	CHIP R 1.0K	J 1/10W	
R194			RK73FB2A223J	CHIP R 22K	J 1/10W	
R195			RK73FB2A104J	CHIP R 100K	J 1/10W	
R196,197			RK73FB2A102J	CHIP R 1.0K	J 1/10W	
R198			RK73FB2A104J	CHIP R 100K	J 1/10W	
R199,200			RK73FB2A223J	CHIP R 22K	J 1/10W	
R201,202			RK73FB2A104J	CHIP R 100K	J 1/10W	
R203,204			RK73FB2A563J	CHIP R 56K	J 1/10W	
R207,208			RK73FB2A331J	CHIP R 330	J 1/10W	KP1Y1 6
R207,208			RK73FB2A331J	CHIP R 330	J 1/10W	KP1Y1 7
R207,208			RK73FB2A331J	CHIP R 330	J 1/10W	M1X1K1 7
R207,208			RK73FB2A331J	CHIP R 330	J 1/10W	M1X1K1 6
R207,208			RK73FB2A331J	CHIP R 330	J 1/10W	P2K2P3 7
R207,208			RK73FB2A331J	CHIP R 330	J 1/10W	P2K2P3 6
R207,208			RK73FB2A431J	CHIP R 430	J 1/10W	E1T1Q1 7
R207,208			RK73FB2A431J	CHIP R 430	J 1/10W	E1T1Q1 6
R207,208			RK73FB2A431J	CHIP R 430	J 1/10W	E2 6
R207,208			RK73FB2A431J	CHIP R 430	J 1/10W	E2 7
R207,208			RK73FB2A471J	CHIP R 470	J 1/10W	KP1Y1 5
R207,208			RK73FB2A471J	CHIP R 470	J 1/10W	M1X1K1 5
R207,208			RK73FB2A471J	CHIP R 470	J 1/10W	P2 5
R207,208			RK73FB2A621J	CHIP R 620	J 1/10W	E1T1Q1 5
R207,208			RK73FB2A621J	CHIP R 620	J 1/10W	E2 5
R209,210			RK73FB2A563J	CHIP R 56K	J 1/10W	
R214,215			RD14NB2E103J	RD 10K	J 1/4W	
R216			RS14KB3A392J	FL-PROOF RS 3.9K	J 1W	6

L : Scandinavia K : USA P : Canada R : Mexico C : China I : Malaysia
Y : PX(Far East, Hawaii) T : Europe E : Europe G : Germany V : China (Shanghai)
Y : AAFES(Europe) X : Australia Q : Russia H : Korea M : Other Areas Δ indicates safety critical components.

* New Parts
Parts without **Parts No.** are not supplied.
Les articles non mentionnés dans le **Parts No.** ne sont pas fournis.
Teile ohne **Parts No.** werden nicht geliefert.

21

Ref. No	Add-ress	New Parts	Parts No.	Description	Desti-nation	Re-marks
R216			RS14KB3A392J	FL-PROOF RS 3.9K	J 1W	7
R217-219			RK73FB2A104J	CHIP R 100K	J 1/10W	
R220			RS14KB3A392J	FL-PROOF RS 3.9K	J 1W	7
R220			RS14KB3A392J	FL-PROOF RS 3.9K	J 1W	6
R221,222			RK73FB2A563J	CHIP R 56K	J 1/10W	
R224			RK73FB2A102J	CHIP R 1.0K	J 1/10W	
R225,226			RK73FB2A301J	CHIP R 300	J 1/10W	7 KP1Y1
R225,226			RK73FB2A301J	CHIP R 300	J 1/10W	6 KP1Y1
R225,226			RK73FB2A301J	CHIP R 300	J 1/10W	6 M1X1K1
R225,226			RK73FB2A301J	CHIP R 300	J 1/10W	7 M1X1K1
R225,226			RK73FB2A301J	CHIP R 300	J 1/10W	6 P2K2P3
R225,226			RK73FB2A301J	CHIP R 300	J 1/10W	7 P2K2P3
R225,226			RK73FB2A431J	CHIP R 430	J 1/10W	7 E1T1Q1
R225,226			RK73FB2A431J	CHIP R 430	J 1/10W	7 E1T1Q1
R225,226			RK73FB2A431J	CHIP R 430	J 1/10W	6 E2
R225,226			RK73FB2A431J	CHIP R 430	J 1/10W	5 KP1Y1
R225,226			RK73FB2A431J	CHIP R 430	J 1/10W	5 M1X1K1
R225,226			RK73FB2A431J	CHIP R 430	J 1/10W	5 P2
R225,226			RK73FB2A561J	CHIP R 560	J 1/10W	5 E1T1Q1
R225,226			RK73FB2A561J	CHIP R 560	J 1/10W	5 E2
R229,230			RK73FB2A102J	CHIP R 1.0K	J 1/10W	
R231			RK73FB2A563J	CHIP R 56K	J 1/10W	
R233			RK73FB2A301J	CHIP R 300	J 1/10W	6 KP1Y1
R233			RK73FB2A301J	CHIP R 300	J 1/10W	7 KP1Y1
R233			RK73FB2A301J	CHIP R 300	J 1/10W	6 M1X1K1
R233			RK73FB2A301J	CHIP R 300	J 1/10W	7 M1X1K1
R233			RK73FB2A301J	CHIP R 300	J 1/10W	6 P2K2P3
R233			RK73FB2A301J	CHIP R 300	J 1/10W	7 P2K2P3
R233			RK73FB2A431J	CHIP R 430	J 1/10W	6 E1T1Q1
R233			RK73FB2A431J	CHIP R 430	J 1/10W	6 E2
R233			RK73FB2A431J	CHIP R 430	J 1/10W	7 E2
R233			RK73FB2A431J	CHIP R 430	J 1/10W	5 KP1Y1
R233			RK73FB2A431J	CHIP R 430	J 1/10W	5 M1X1K1
R233			RK73FB2A431J	CHIP R 430	J 1/10W	5 P2
R233			RK73FB2A561J	CHIP R 560	J 1/10W	5 E1T1Q1
R233			RK73FB2A561J	CHIP R 560	J 1/10W	5 E2
R239,240			RS14KB3A392J	FL-PROOF RS 3.9K	J 1W	7
R239,240			RS14KB3A392J	FL-PROOF RS 3.9K	J 1W	6
R241,242			R92-1866-05	METALFILM 0.1	2W	
R243,244			RK73FB2A333J	CHIP R 33K	J 1/10W	
R245,246			RK73FB2A243J	CHIP R 24K	J 1/10W	7
R245,246			RK73FB2A243J	CHIP R 24K	J 1/10W	6
R245,246			RK73FB2A393J	CHIP R 39K	J 1/10W	5
R247,248			RK73FB2A471J	CHIP R 470	J 1/10W	
R249			R92-1866-05	METALFILM 0.1	2W	
R251			RK73FB2A333J	CHIP R 33K	J 1/10W	
R253			RK73FB2A243J	CHIP R 24K	J 1/10W	7
R253			RK73FB2A243J	CHIP R 24K	J 1/10W	6
R253			RK73FB2A393J	CHIP R 39K	J 1/10W	
R255			RK73FB2A471J	CHIP R 470	J 1/10W	
R257,258			R92-1866-05	METALFILM 0.1	2W	
R259,260			RK73FB2A333J	CHIP R 33K	J 1/10W	
R261,262			RK73FB2A243J	CHIP R 24K	J 1/10W	7
R261,262			RK73FB2A243J	CHIP R 24K	J 1/10W	6

L: Scandinavia K: USA P: Canada R: Mexico C: China I: Malaysia
Y: PX(Far East, Hawaii) T: Europe E: Europe G: Germany V: China (Shanghai)
Y: AAFES(Europe) X: Australia Q: Russia H: Korea M: Other Areas Δ indicates safety critical components.

* New Parts
Parts without **Parts No.** are not supplied.
Les articles non mentionnés dans le **Parts No.** ne sont pas fournis.
Teile ohne **Parts No.** werden nicht geliefert.

22

Ref. No	Add-ress	New Parts	Parts No.	Description	Desti-nation	Re-marks
R261,262			RK73FB2A393J	CHIP R 39K	J 1/10W	5
R263,264			RK73FB2A471J	CHIP R 470	J 1/10W	
R265-267			RD14NB2E4R7J	RD 4.7	J 1/4W	
R268			RK73FB2A153J	CHIP R 15K	J 1/10W	
R269,270			RD14NB2E4R7J	RD 4.7	J 1/4W	
R271-273			RK73FB2A333J	CHIP R 33K	J 1/10W	
R275,276			RK73FB2A333J	CHIP R 33K	J 1/10W	
R277			RK73FB2A203J	CHIP R 20K	J 1/10W	7 E1T1Q1
R277			RK73FB2A203J	CHIP R 20K	J 1/10W	6 E1T1Q1
R277			RK73FB2A203J	CHIP R 20K	J 1/10W	7 E2
R277			RK73FB2A203J	CHIP R 20K	J 1/10W	6 E26
R277			RK73FB2A273J	CHIP R 27K	J 1/10W	7 KP1Y1
R277			RK73FB2A273J	CHIP R 27K	J 1/10W	6 KP1Y1
R277			RK73FB2A273J	CHIP R 27K	J 1/10W	7 M1X1K1
R277			RK73FB2A273J	CHIP R 27K	J 1/10W	6 M1X1K1
R277			RK73FB2A273J	CHIP R 27K	J 1/10W	7 P2K2P3
R277			RK73FB2A273J	CHIP R 27K	J 1/10W	6 P2K2P3
R279,280			RK73FB2A203J	CHIP R 20K	J 1/10W	7 E1T1Q1
R279,280			RK73FB2A203J	CHIP R 20K	J 1/10W	6 E1T1Q1
R279,280			RK73FB2A203J	CHIP R 20K	J 1/10W	7 E2
R279,280			RK73FB2A203J	CHIP R 20K	J 1/10W	6 E2
R279,280			RK73FB2A273J	CHIP R 27K	J 1/10W	7 KP1Y1
R279,280			RK73FB2A273J	CHIP R 27K	J 1/10W	6 KP1Y1
R279,280			RK73FB2A273J	CHIP R 27K	J 1/10W	7 M1X1K1
R279,280			RK73FB2A273J	CHIP R 27K	J 1/10W	6 M1X1K1
R279,280			RK73FB2A273J	CHIP R 27K	J 1/10W	7 P2K2P3
R279,280			RK73FB2A273J	CHIP R 27K	J 1/10W	6 P2K2P3
R281-283			RK73FB2A102J	CHIP R 1.0K	J 1/10W	
R284			RK73FB2A123J	CHIP R 12K	J 1/10W	
R285			RK73FB2A682J	CHIP R 6.8K	J 1/10W	
R286			RK73FB2A223J	CHIP R 22K	J 1/10W	
R287-291			RK73FB2A272J	CHIP R 2.7K	J 1/10W	
R292-295			RK73FB2A102J	CHIP R 1.0K	J 1/10W	
R300			RD14NB2E1R0J	RD 1	J 1/4W	
R304,305			RK73FB2A273J	CHIP R 27K	J 1/10W	5
R304,305			RK73FB2A513J	CHIP R 51K	J 1/10W	7
R304,305			RK73FB2A513J	CHIP R 51K	J 1/10W	6
R306,307			RK73FB2A273J	CHIP R 27K	J 1/10W	7
R306,307			RK73FB2A273J	CHIP R 27K	J 1/10W	6
R308			RD14NB2E4R7J	RD 4.7	J 1/4W	
R309			RD14NB2E103J	RD 10K	J 1/4W	7
R309			RD14NB2E103J	RD 10K	J 1/4W	6
R309			RD14NB2E472J	RD 4.7K	J 1/4W	5
R311			RK73FB2A273J	CHIP R 27K	J 1/10W	5
R311			RK73FB2A513J	CHIP R 51K	J 1/10W	7
R311			RK73FB2A513J	CHIP R 51K	J 1/10W	6
R312			RK73FB2A273J	CHIP R 27K	J 1/10W	7
R312			RK73FB2A273J	CHIP R 27K	J 1/10W	6
R315,316			RK73FB2A472J	CHIP R 4.7K	J 1/10W	
R317			RK73FB2A273J	CHIP R 27K	J 1/10W	
R318			RS14KB3A681J	FL-PROOF RS 680	J 1W	
R320			RK73FB2A103J	CHIP R 10K	J 1/10W	
R321			RK73FB2A473J	CHIP R 47K	J 1/10W	
R322			RS14KB3D391J	FL-PROOF RS 390	J 2W	
R323			R92-1878-05	WIRE-WOUND RESISTOR		
R325			RS14KB3D391J	FL-PROOF RS 390	J 2W	

L: Scandinavia K: USA P: Canada R: Mexico C: China I: Malaysia
Y: PX(Far East, Hawaii) T: Europe E: Europe G: Germany V: China (Shanghai)
Y: AAFES(Europe) X: Australia Q: Russia H: Korea M: Other Areas Δ indicates safety critical components.

KRF-V5010W6010W7010WR-205/206/207/255/257
PARTS LIST

* New Parts
Parts without **Parts No.** are not supplied.
Les articles non mentionnés dans le **Parts No.** ne sont pas fournis.
Teile ohne **Parts No.** werden nicht geliefert.

23

Ref. No	Add-ress	New Parts	Parts No.	Description	Desti-nation	Re-marks
R326-330			RK73FB2A102J	CHIP R 1.0K J 1/10W		
R331			RK73FB2A363J	CHIP R 36K J 1/10W		
R332			RK73FB2A751J	CHIP R 750 J 1/10W		
R333			RK73FB2A272J	CHIP R 2.7K J 1/10W		
R361,362			RS14KB3D391J	FL-PROOF RS 390 J 2W		
R363			RK73FB2A473J	CHIP R 47K J 1/10W		
R400			RK73FB2A472J	CHIP R 4.7K J 1/10W		
R403-407			RK73EB2B220J	CHIP R 22 J 1/8W		
R408			RK73FB2A222J	CHIP R 2.2K J 1/10W		
R409			RK73FB2A333J	CHIP R 33K J 1/10W		
R410,411			RK73EB2B224J	CHIP R 220K J 1/8W		
R412,413			RK73FB2A224J	CHIP R 220K J 1/10W		
R414			RK73FB2A103J	CHIP R 10K J 1/10W		
R415			RK73FB2A104J	CHIP R 100K J 1/10W		
R416			RK73FB2A683J	CHIP R 68K J 1/10W		
R417			RK73FB2A473J	CHIP R 47K J 1/10W		
R450,451			RK73FB2A272J	CHIP R 2.7K J 1/10W		7
R450,451			RK73FB2A272J	CHIP R 2.7K J 1/10W		6
R452			RK73FB2A361J	CHIP R 360 J 1/10W		7
R452			RK73FB2A361J	CHIP R 360 J 1/10W		6
R453			RK73FB2A472J	CHIP R 4.7K J 1/10W		7
R453			RK73FB2A472J	CHIP R 4.7K J 1/10W		6
R456			RK73FB2A473J	CHIP R 47K J 1/10W		
R457			RK73FB2A102J	CHIP R 1.0K J 1/10W		
R458			RK73FB2A101J	CHIP R 100 J 1/10W		
R460,461			RK73FB2A102J	CHIP R 1.0K J 1/10W		
R462			RK73EB2B101J	CHIP R 100 J 1/8W		
R514			RK73FB2A222J	CHIP R 2.2K J 1/10W		
R515			RK73FB2A103J	CHIP R 10K J 1/10W		
R523			RD14NB2E1R0J	RD 1 J 1/4W		
R524,525			RK73FB2A101J	CHIP R 100 J 1/10W		
R528			RK73FB2A101J	CHIP R 100 J 1/10W		
R529,530			RK73FB2A473J	CHIP R 47K J 1/10W		
R536			RK73FB2A102J	CHIP R 1.0K J 1/10W		
R545,546			RK73FB2A103J	CHIP R 10K J 1/10W		
R552			RK73FB2A102J	CHIP R 1.0K J 1/10W		
R556			RK73FB2A103J	CHIP R 10K J 1/10W	KP1Y1	
R556			RK73FB2A103J	CHIP R 10K J 1/10W	M1X1K1	
R556			RK73FB2A103J	CHIP R 10K J 1/10W	P2K2P3	
R565			RK73FB2A103J	CHIP R 10K J 1/10W		
R568			RK73FB2A103J	CHIP R 10K J 1/10W		
R570			RK73FB2A103J	CHIP R 10K J 1/10W		
R577			RK73FB2A103J	CHIP R 10K J 1/10W		
R580			RK73FB2A222J	CHIP R 2.2K J 1/10W	E1T1Q1	
R580			RK73FB2A222J	CHIP R 2.2K J 1/10W	E2	
R582			RK73FB2A102J	CHIP R 1.0K J 1/10W		
W303			R92-0679-05	CHIP R 0 OHM		
W304-306			R92-0670-05	CHIP R 0 OHM		
W309,310			R92-0679-05	CHIP R 0 OHM		
W312			R92-0679-05	CHIP R 0 OHM		
W314			R92-0679-05	CHIP R 0 OHM		
W315			R92-0670-05	CHIP R 0 OHM		
W316-318			R92-0679-05	CHIP R 0 OHM		
W501,502			R92-0670-05	CHIP R 0 OHM	KP1Y1	
W501,502			R92-0670-05	CHIP R 0 OHM	M1X1K1	

L : Scandinavia K : USA P : Canada R : Mexico C : China I : Malaysia
Y : PX(Far East, Hawaii) T : Europe E : Europe G : Germany V : China (Shanghai)
Y : AAFES(Europe) X : Australia Q : Russia H : Korea M : Other Areas Δ indicates safety critical components.

* New Parts
Parts without **Parts No.** are not supplied.
Les articles non mentionnés dans le **Parts No.** ne sont pas fournis.
Teile ohne **Parts No.** werden nicht geliefert.

24

Ref. No	Add-ress	New Parts	Parts No.	Description	Desti-nation	Re-marks
W501,502			R92-0670-05	CHIP R 0 OHM		P2K2P3
K1			S76-0061-05	MAGNETIC RELAY		
K2			S76-0061-05	MAGNETIC RELAY		7
K2			S76-0061-05	MAGNETIC RELAY		6
K3 ,4			S76-0061-05	MAGNETIC RELAY		
S501-505			S70-0031-05	TACT SWITCH		
S507			S70-0031-05	TACT SWITCH		
S509-512			S70-0031-05	TACT SWITCH		
S514-516			S70-0031-05	TACT SWITCH		
S520,521			S70-0031-05	TACT SWITCH		
S517			T99-0602-05	ROTARY ENCODER		
S518,519			T99-0605-05	ROTARY ENCODER		
D3 ,4			MTZJ5.1(B)	ZENER DIODE		
D3 ,4			RD5.1ES(B2)	ZENER DIODE		
D5 ,6			MTZJ6.8(B)	ZENER DIODE		
D5 ,6			RD6.8ES(B2)	ZENER DIODE		
D7			MTZJ5.1(B)	ZENER DIODE		
D7			RD5.1ES(B2)	ZENER DIODE		
D8			MTZJ11(B)	ZENER DIODE		
D8			RD11ES(B2)	ZENER DIODE		
D10			MTZJ8.2(B)	ZENER DIODE		7
D10			MTZJ8.2(B)	ZENER DIODE		6
D10			RD8.2ES(B2)	ZENER DIODE		7
D10			RD8.2ES(B2)	ZENER DIODE		6
D11			MTZJ7.5(B)	ZENER DIODE		7
D11			MTZJ7.5(B)	ZENER DIODE		6
D11			RD7.5ES(B2)	ZENER DIODE		6
D11			RD7.5ES(B2)	ZENER DIODE		7
D12 ,13			MTZJ8.2(B)	ZENER DIODE		7
D12 ,13			MTZJ8.2(B)	ZENER DIODE		6
D12 ,13			RD8.2ES(B2)	ZENER DIODE		7
D12 ,13			RD8.2ES(B2)	ZENER DIODE		6
D14 ,15			MTZJ10(B)	ZENER DIODE		6
D14 ,15			MTZJ10(B)	ZENER DIODE		7
D14 ,15			RD10ES(B2)	ZENER DIODE		7
D14 ,15			RD10ES(B2)	ZENER DIODE		6
D19			MA111	DIODE		
D20			MA111	DIODE		7
D20			MA111	DIODE		6
D21 -23			MA111	DIODE		
D24			MTZJ4.7(B)	ZENER DIODE		
D24			RD4.7ES(B2)	ZENER DIODE		
D25			MTZJ3.3(B)	ZENER DIODE		
D25			RD3.3ES(B2)	ZENER DIODE		
D26			MA111	DIODE		
D31 ,32			D4SBL20UF03	DIODE		
D33 -36			S5688B(TPB5)	DIODE		
D37 ,38			MTZJ16(B)	ZENER DIODE		
D37 ,38			RD16ES(B2)	ZENER DIODE		
D39 ,40			MTZJ18(B)	ZENER DIODE		
D39 ,40			RD18ES(B2)	ZENER DIODE		
D50 ,51			MA111	DIODE		
D50 ,51			MA111	DIODE		6
D52			MA111	DIODE		7
D52			MA111	DIODE		

L : Scandinavia K : USA P : Canada R : Mexico C : China I : Malaysia
Y : PX(Far East, Hawaii) T : Europe E : Europe G : Germany V : China (Shanghai)
Y : AAFES(Europe) X : Australia Q : Russia H : Korea M : Other Areas Δ indicates safety critical components.

PARTS LIST

KRF-V5010/N6010/N7010/NR-205/206/207/255/257

* New Parts
Parts without **Parts No.** are not supplied.
Les articles non mentionnés dans le **Parts No.** ne sont pas fournis.
Teile ohne **Parts No.** werden nicht geliefert.

25

Ref. No	Add-ress	New Parts	Parts No.	Description	Desti-nation	Re-marks
D53			MA111	DIODE		6
D53			MA111	DIODE		7
D54			MA111	DIODE		7
D54			MA111	DIODE		6
D55			MA111	DIODE		7
D55			MA111	DIODE		6
D56			MTZJ7.5(B)	ZENER DIODE		6
D56			RD7.5ES(B2)	ZENER DIODE		
D504			HSS104A	DIODE	Q1E2	
D504			HSS104A	DIODE	Y1M1X1	
D504			1SS133	DIODE	Q1E2	
D504			1SS133	DIODE	Y1M1X1	
D505			HSS104A	DIODE	E1T1	
D505			1SS133	DIODE	E1T1	
D506			HSS104A	DIODE	K1P2	7
D506			1SS133	DIODE	K1P2	7
D507			HSS104A	DIODE	Q1E2	7
D507			1SS133	DIODE	Q1E2	7
D508,509			HSS104A	DIODE		
D508,509			1SS133	DIODE	KP1K1	
D510			HSS104A	DIODE	E1T1Q1	
D510			HSS104A	DIODE	E2	
D510			HSS104A	DIODE	Y1M1X1	
D510			1SS133	DIODE	E1T1Q1	
D510			1SS133	DIODE	E2	
D510			1SS133	DIODE	Y1M1X1	
D511-521			HSS104A	DIODE		
D511-521			1SS133	DIODE		
D511-521			1SS133	DIODE		
D522			HSS104A	DIODE		5
D522			1SS133	DIODE		5
D523			HSS104A	DIODE		
D523			1SS133	DIODE		
D524			HSS104A	DIODE	E1T1Q1	
D524			HSS104A	DIODE	E2	
D524			1SS133	DIODE	E1T1Q1	
D524			1SS133	DIODE	E2	
D526			MTZJ6.2(B)	ZENER DIODE		
D526			RD6.2ES(B2)	ZENER DIODE		
D529			HSS104A	DIODE		
D529			1SS133	DIODE		
ED51			11-MT-116GK	INDICATOR TUBE		
Δ IC1			TA7815SB	ANALOGUE IC		
Δ IC2			TA79015SB	ANALOGUE IC		
Δ IC3		*	STK407-090K	HYBRID IC		5
Δ IC3		*	STK411-230D	HYBRID IC		7
Δ IC3		*	STK411-230D	HYBRID IC		6
Δ IC3		*	STK411-230K	HYBRID IC	KP1Y1	7
Δ IC3		*	STK411-230K	HYBRID IC	M1X1K1	7
Δ IC3		*	STK411-230K	HYBRID IC	P2K2P3	7
Δ IC4		*	STK407-290K	HYBRID IC		5
Δ IC4		*	STK410-030D	HYBRID IC		7
Δ IC4		*	STK410-030D	HYBRID IC		6
Δ IC4		*	STK410-030K	HYBRID IC		7
Δ IC4		*	STK410-030K	HYBRID IC		6
Δ IC5			NJM4580ED	ANALOGUE IC		

L : Scandinavia K : USA P : Canada R : Mexico C : China I : Malaysia
Y : PX(Far East, Hawaii) T : Europe E : Europe G : Germany V : China (Shanghai)
Y : AAFES(Europe) X : Australia Q : Russia H : Korea M : Other Areas Δ indicates safety critical components.

* New Parts
Parts without **Parts No.** are not supplied.
Les articles non mentionnés dans le **Parts No.** ne sont pas fournis.
Teile ohne **Parts No.** werden nicht geliefert.

26

Ref. No	Add-ress	New Parts	Parts No.	Description	Desti-nation	Re-marks
IC6			TC9164AF	MOS-IC		
IC7			TC9162AF	MOS-IC		
IC8			NJM4565MD	IC(OP AMP X2)		
IC9			M62446FP	ANALOGUE IC		
IC12			NJM4565MD	IC(OP AMP X2)		
IC16			M62460AFP	ANALOGUE IC		
IC17			BU4066BCF	IC(ANALOG SWITCH X4)		
IC18			NJM2279M	ANALOGUE IC		
IC19			M5278L05M	ANALOGUE IC		
IC51			CXP82832-144Q	MI-COM IC		KP1Y1
IC51			CXP82832-144Q	MI-COM IC		M1X1K1
IC51			CXP82832-144Q	MI-COM IC		P2K2P3
IC51			CXP82852-130Q	MI-COM IC		E1T1Q1
IC51			CXP82852-130Q	MI-COM IC		E2
IC52			X24C02S	MEMORY IC		E1T1Q1
IC52			X24C02S	MEMORY IC		E2
IC52			X24C02S	MEMORY IC		Y1M1X1
IC53			S-80740AL-A4	IC(VOLTAGE DETECTOR)		
IC54			SAA6579T	ANALOGUE IC		E1T1Q1
IC54			SAA6579T	ANALOGUE IC		E2
IC54			SAA6579T/R	ANALOGUE IC		E1T1Q1
IC54			SAA6579T/R	ANALOGUE IC		E2
Q1 -11			2SC2878(B)	TRANSISTOR		
Q12			2SC4213(B)	TRANSISTOR		
Q13 ,14			2SA1586(Y,GR)	TRANSISTOR		
Q13 ,14			2SA1611(M5,M6)	TRANSISTOR		
Q15 -19			2SC1845(F,E)	TRANSISTOR		
Q20			DTC123JUA	DIGITAL TRANSISTOR		
Q21			DTC123JUA	DIGITAL TRANSISTOR		7
Q22 ,23			DTC123JUA	DIGITAL TRANSISTOR		
Q24 ,25			2SC3722K(R,S)	TRANSISTOR		
Q26			2SA1255	TRANSISTOR		
Q29			2SC2631(S,T)	TRANSISTOR		
Q30			2SA1123(S,T)	TRANSISTOR		
Q31			2SA1534A	TRANSISTOR		5
Δ Q31			2SB1640	TRANSISTOR		7
Δ Q31			2SB1640	TRANSISTOR		6
Q32 -34			2SC3722K(R,S)	TRANSISTOR		
Q35			2SA1255	TRANSISTOR		
Q36 ,37			2SC3722K(R,S)	TRANSISTOR		
Q40			2SC4213(B)	TRANSISTOR		7
Q40			2SC4213(B)	TRANSISTOR		6
Q41			DTC113ZUA	DIGITAL TRANSISTOR		7
Q41			DTC113ZUA	DIGITAL TRANSISTOR		6
Q41			UN5219	DIGITAL TRANSISTOR		7
Q41			UN5219	DIGITAL TRANSISTOR		6
Q42			2SC4213(B)	TRANSISTOR		7
Q42			2SC4213(B)	TRANSISTOR		6
Q501			2SC4116(Y,GR)	TRANSISTOR		Y1M1X1
Q501			2SC4177(L5,L6)	TRANSISTOR		Y1M1X1
Q501			2SC4116(Y,GR)	TRANSISTOR		
Q503			2SC4177(L5,L6)	TRANSISTOR		
A501			W02-2625-05	OPTIC RECEIVING MODULE		

L : Scandinavia K : USA P : Canada R : Mexico C : China I : Malaysia
Y : PX(Far East, Hawaii) T : Europe E : Europe G : Germany V : China (Shanghai)
Y : AAFES(Europe) X : Australia Q : Russia H : Korea M : Other Areas Δ indicates safety critical components.

KRF-V5010W6010N/7010MR-205/206/207/255/257
PARTS LIST

KRF-V5010/V6010/V7010/VR-205/206/207/255/257

PARTS LIST

HOW TO READ THE PARTS LIST

ABBREVIATION OF MODEL AND MASS PRODUCTION'S DESTINATIONS

MODEL	ABB.	Australia	Canada	China	England	Europe	Germany	Korea	Malaysia
KRF-5010	5	X1	-	-	T1	E1	-	-	-
KRF-5010E		-	-	-	-	E2	-	-	-
KRF-5010W		-	-	-	-	-	-	-	-
VR-205		-	P1	-	-	-	-	-	-
VR-255		-	P2	-	-	-	-	-	-
KRF-V6010	6	X1	-	-	-	E1	-	-	-
KRF-V6010E		-	-	-	-	E2	-	-	-
KRF-V6010W		-	-	-	-	-	-	-	-
KRF-V7010	7	X1	-	-	T1	E1	-	-	-
KRF-V7010E		-	-	-	-	E2	-	-	-
KRF-V7010W		-	-	-	-	-	-	-	-
VR-206		-	P3	-	-	-	-	-	-
VR-207		-	P1	-	-	-	-	-	-
VR-257		-	P2	-	-	-	-	-	-
MODEL	ABB.	Mexico	PX/AAFES	Russia	Scandinavia	Shanghai	USA	Other area	
KRF-5010	5	-	Y1	-	-	-	-	M1	-
KRF-5010E		-	-	-	-	-	-	-	-
KRF-5010W		-	-	Q1	-	-	-	-	-
VR-205		-	-	-	-	-	K	-	-
VR-255		-	-	-	-	-	K1	-	-
KRF-V6010	6	-	-	-	-	-	-	M1	-
KRF-V6010E		-	-	-	-	-	-	-	-
KRF-V6010W		-	-	Q1	-	-	-	-	-
KRF-V7010	7	-	Y1	-	-	-	-	M1	-
KRF-V7010E		-	-	-	-	-	-	-	-
KRF-V7010W		-	-	Q1	-	-	-	-	-
VR-206		-	-	-	-	-	K2	-	-
VR-207		-	-	-	-	-	K	-	-
VR-257		-	-	-	-	-	K1	-	-

KRF-V5010/V6010/V7010/VR-205/206/207/255/257

SPECIFICATIONS

For U.S.A and Canada

AUDIO section

Rated power output during STEREO operation
VR-207, VR-257, VR-206

100 watts per channel minimum RMS, both channels driven, at 8 Ω from 40 Hz to 20 kHz with no more than 0.7% total harmonic distortion.(FTC)

VR-205, VR-255

50 watts per channel minimum RMS, both channels driven, at 8 Ω from 40 Hz to 20 kHz with no more than 0.7% total harmonic distortion.(FTC)

Effective power output during SURROUND operation

VR-207, VR-257, VR-206
FRONT (1kHz, 0.7% T.H.D. at 8 Ω one channel driven)
..... 100 W + 100 W
CENTER (1kHz, 0.7% T.H.D. at 8 Ω one channel driven)
..... 100 W
SURROUND (1kHz, 0.7% T.H.D. at 8 Ω one channel driven)
..... 100 W + 100 W

VR-205, VR-255
FRONT (1kHz, 0.7% T.H.D. at 8 Ω one channel driven)
..... 50 W + 50 W
CENTER (1kHz, 0.7% T.H.D. at 8 Ω one channel driven)
..... 50 W
SURROUND (1kHz, 0.7% T.H.D. at 8 Ω one channel driven)
..... 50 W + 50 W

Total harmonic distortion
VR-207, VR-257, VR-206 0.03% (1 kHz, 50W, 8 Ω)
VR-205, VR-255 0.03% (1 kHz, 25W, 8 Ω)

Signal to noise ratio (IHF'66)
PHONO (MM) 75 dB
CD 91 dB

Input sensitivity / impedance
PHONO (MM) 2.5 mV / 27 kΩ
CD 200 mV / 47 kΩ
DVD 6CH (SUBWOOFER) 200 mV / 10 kΩ

Output level / impedance
TAPE REC 200 mV / 1 kΩ
PRE OUT (CENTER, SURROUND) 1 V / 1 kΩ
(only VR-207, VR-257, VR-206)
PRE OUT (SUBWOOFER) 1 V / 600 Ω

Tone control
BASS ±10 dB (at 100 Hz)
TREBLE ±10 dB (at 10 kHz)

VIDEO section

VIDEO inputs / outputs
VIDEO (composite) 1 V_{p-p} / 75 Ω

TV tuner section (For VR-257)

Reception frequency 65.75 MHz (3ch)
71.75 MHz (4ch)

FM tuner section

Tuning frequency range 87.5 MHz ~ 108 MHz
Usable sensitivity (MONO)
..... 1.6 μV (75 Ω) / 15.2 dBf (75 kHz DEV., SINAD 30 dB)
50dB quieting sensitivity
STEREO 31.6 μV (75 Ω) / 41.2 dBf
Total harmonic distortion (1 kHz)
MONO 0.6% (65 dBf input)
STEREO 0.7% (65 dBf input)
Signal to noise ratio (1 kHz, 75 kHz DEV.)
MONO 75 dB (65 dBf input)
STEREO 68 dB (65 dBf input)
Stereo separation (1 kHz) 38 dB
Selectivity (±400 kHz) 70 dB
Frequency response 30 Hz ~ 15kHz, +0.5 dB, -3.0 dB

AM tuner section

Tuning frequency range
10 kHz step 530 kHz ~ 1,700 kHz
Usable sensitivity (30% mod., S/N 20 dB)
..... 16 μV / (600 μV/m)
Signal to noise ratio (30% mod. 1 mV input) 50 dB

GENERAL

Power consumption 2.2 A
AC outlet
SWITCHED 2 (total 150 W, 1.25 A max.)

Dimensions W : 440 mm (17-5/16")
H : 144 mm (5-11/16")
D : 390 mm (15-3/8")

Weight (Net)
VR-207, VR-257, VR-206 8.6 kg (19.0 lb)
VR-205, VR-255 8.2 kg (18.1 lb)

Notes

1. KENWOOD follows a policy of continuous advancements in development. For this reason specifications may be changed without notice.
2. The full performance may not be exhibited in an extremely cold location (under a water-freezing temperature).

KRF-V5010/V6010/V7010/VR-205/206/207/255/257

SPECIFICATIONS

For Europ

AUDIO section

Rated power output during STEREO operation

KRF-V7010
(DIN) 1 kHz, 0.7% at 4 Ω 100 W + 100 W

KRF-V6010
(DIN) 1 kHz, 0.7% at 4 Ω 90 W + 90 W

KRF-V5010
(DIN) 1 kHz, 0.7% at 4 Ω 50 W + 50 W

Effective power output during SURROUND operation

KRF-V7010
FRONT(1kHz, 0.7% T.H.D. at 4 Ω one channel driven)
..... 100 W + 100 W
CENTER (1kHz, 0.7% T.H.D. at 4 Ω one channel driven)
..... 100 W
SURROUND(1kHz, 0.7% T.H.D. at 4 Ω one channel driven)
..... 100 W + 100 W

KRF-V6010
FRONT(1kHz, 0.7% T.H.D. at 4 Ω one channel driven)
..... 80 W + 80 W
CENTER (1kHz, 0.7% T.H.D. at 4 Ω one channel driven)
..... 80 W
SURROUND(1kHz, 0.7% T.H.D. at 4 Ω one channel driven)
..... 80 W + 80 W

KRF-V5010
FRONT(1kHz, 0.7% T.H.D. at 4 Ω one channel driven)
..... 50 W + 50 W
CENTER (1kHz, 0.7% T.H.D. at 4 Ω one channel driven)
..... 50 W
SURROUND(1kHz, 0.7% T.H.D. at 4 Ω one channel driven)
..... 50 W + 50 W

Total harmonic distortion

KRF-V7010 0.03%(1 kHz, 50W, 4 Ω)
KRF-V6010 0.03%(1 kHz, 40W, 4 Ω)
KRF-V5010 0.03%(1 kHz, 25W, 4 Ω)

Signal to noise ratio

PHONO (MM) 75 dB (IHF'66)
..... 55 dB (DIN 50mW output)
CD 91 dB (IHF'66)
..... 56 dB (DIN 50mW output)

Input sensitivity / impedance

PHONO (MM) 2.5 mV / 27 kΩ
CD 200 mV / 47 kΩ
DVD 6CH (SUBWOOFER) 200 mV / 10 kΩ

Output level / impedance

TAPE REC 200 mV / 1 kΩ
PRE OUT (CENTER, SURROUND) 1 V / 1 kΩ
(only KRF-V7010, KRF-V6010)
PRE OUT (SUBWOOFER) 1 V / 600 Ω

Tone control

BASS ±10 dB (at 100 Hz)
TREBLE ±10 dB (at 10 kHz)

VIDEO section

VIDEO inputs / outputs

VIDEO (composite) 1 Vp-p / 75 Ω

FM tuner section

Tuning frequency range

U.K. and Europe 87.5 MHz ~ 108 MHz
Russia 87.5 MHz ~ 108 MHz,
65.0 MHz ~ 74.0 MHz

Usable sensitivity (DIN, 75 Ω)

MONO 1.2 μV / 13.2 dBf (40 kHz DEV., S/N 26 dB)
STEREO 35 μV / 42.1 dBf (46 kHz DEV., S/N 46 dB)

Total harmonic distortion (DIN, 1 kHz)

MONO 0.2% (65.2 dBf input)
STEREO 0.8% (65.2 dBf input)

Signal to noise ratio (DIN weighted, 1 kHz)

U.K. and Europe
MONO 65 dB (40 kHz DEV., 65.2 dBf input)
STEREO 60 dB (46 kHz DEV., 65.2 dBf input)
Russia
MONO 63 dB (40 kHz DEV., 65.2 dBf input)
STEREO 58 dB (46 kHz DEV., 65.2 dBf input)

Stereo separation (DIN, 1 kHz) 36 dB

Selectivity (DIN, ±300 kHz) 64 dB

Frequency response (30 Hz ~ 15kHz) +0.5 dB, -3.0 dB

AM tuner section

Tuning frequency range 531 kHz ~ 1,602 kHz

Usable sensitivity (30% mod., S/N 20 dB)

..... 16 μV / (600 μV/m)

Signal to noise ratio (30% mod., 1 mV input) 50 dB

GENERAL

Power consumption

KRF-V7010, KRF-V6010 280 W
KRF-V5010 210 W

AC outlet

SWITCHED 2 (total 150 W max.)

Dimensions W : 440 mm

H : 144 mm

KRF-V7010 D : 400 mm

KRF-V6010, KRF-V5010 D : 390 mm

Weight (Net)

KRF-V7010, KRF-V6010 8.6 kg

KRF-V5010 8.2 kg

Notes

1. KENWOOD follows a policy of continuous advancements in development. For this reason specifications may be changed without notice.
2. The full performance may not be exhibited in an extremely cold location (under a water-freezing temperature).

KRF-V5010/V6010/V7010/VR-205/206/207/255/257

SPECIFICATIONS

For other countries

AUDIO section

Effective power output during STEREO operation

KRF-V7010	
1kHz, 10% T.H.D., at 8 Ω	140 W + 140 W
KRF-V6010	
1kHz, 10% T.H.D., at 8 Ω	120 W + 120 W
KRF-V5010	
1kHz, 10% T.H.D., at 8 Ω	70 W + 70 W

Rated power output during STEREO operation

KRF-V7010	
DIN (63 Hz ~ 12.5 kHz, 0.7%, 8 Ω)	110 W + 110 W

100 watts per channel minimum RMS, both channels driven, at 8 Ω from 40 Hz to 20 kHz with no more than 0.7% total harmonic distortion.(FTC)

KRF-V6010	
DIN (63 Hz ~ 12.5 kHz, 0.7%, 8 Ω)	80 W + 80 W

80 watts per channel minimum RMS, both channels driven, at 8 Ω from 40 Hz to 20 kHz with no more than 0.7% total harmonic distortion.(FTC)

KRF-V5010	
DIN (63 Hz ~ 12.5 kHz, 0.7%, 8 Ω)	50 W + 50 W

50 watts per channel minimum RMS, both channels driven, at 8 Ω from 40 Hz to 20 kHz with no more than 0.7% total harmonic distortion.(FTC)

Effective power output during SURROUND operation

KRF-V7010	
FRONT (1kHz, 10% T.H.D. at 8 Ω one channel driven)	100 W + 100 W
CENTER (1kHz, 10% T.H.D. at 8 Ω one channel driven)	100 W
SURROUND (1kHz, 10% T.H.D. at 8 Ω one channel driven)	100 W + 100 W

KRF-V6010	
FRONT (1kHz, 10% T.H.D. at 8 Ω one channel driven)	80 W + 80 W
CENTER (1kHz, 10% T.H.D. at 8 Ω one channel driven)	80 W
SURROUND (1kHz, 10% T.H.D. at 8 Ω one channel driven)	80 W + 80 W

KRF-V5010	
FRONT (1kHz, 10% T.H.D. at 8 Ω one channel driven)	50 W + 50 W
CENTER (1kHz, 10% T.H.D. at 8 Ω one channel driven)	50 W
SURROUND (1kHz, 10% T.H.D. at 8 Ω one channel driven)	50 W + 50 W

Total harmonic distortion

KRF-V7010	0.03%(1 kHz, 50W, 8 Ω)
KRF-V6010	0.03%(1 kHz, 40W, 8 Ω)
KRF-V5010	0.03%(1 kHz, 25W, 8 Ω)

Signal to noise ratio (IHF'66)

PHONO (MM)	75 dB
CD	91 dB

Input sensitivity / impedance

PHONO (MM)	2.5 mV / 27 kΩ
CD	200 mV / 47 kΩ
DVD 6CH (SUBWOOFER)	200 mV / 10 kΩ

Output level / impedance

TAPE REC	200 mV / 1 kΩ
PRE OUT (CENTER, SURROUND)	1 V / 1 kΩ
(only KRF-V7010, KRF-V6010)	
PRE OUT (SUBWOOFER)	1 V / 600 Ω

Tone control

BASS	±10 dB (at 100 Hz)
TREBLE	±10 dB (at 10 kHz)

VIDEO section

VIDEO inputs / outputs

VIDEO (composite)	1 Vp-p / 75 Ω
-------------------	---------------

FM tuner section

Tuning frequency range	87.5 MHz ~ 108 MHz
Usable sensitivity (MONO)	1.6 μV (75 Ω) / 15.2 dBf (75 kHz DEV., SINAD 30 dB)
50dB quieting sensitivity	
STEREO	31.6 μV (75 Ω) / 41.2 dBf
Total harmonic distortion (1 kHz)	
MONO	0.6% (65 dBf input)
STEREO	0.7% (65 dBf input)
Signal to noise ratio (1 kHz, 75 kHz DEV.)	
MONO	75 dB (65 dBf input)
STEREO	68 dB (65 dBf input)
Stereo separation (1 kHz)	38 dB
Selectivity (±400 kHz)	50 dB
Frequency response	30 Hz ~ 15kHz, +0.5 dB, -3.0 dB

AM tuner section

Tuning frequency range	
9 kHz step	531 kHz ~ 1,602 kHz
10 kHz step	530 kHz ~ 1,610 kHz
Usable sensitivity (30% mod., S/N 20 dB)	16 μV / (600 μV/m)
Signal to noise ratio (30% mod. 1 mV input)	50 dB

GENERAL

Power consumption

KRF-V7010, KRF-V6010	280 W
KRF-V5010	210 W

AC outlet

SWITCHED (for Australia)	1 (total 150 W max.)
SWITCHED (except Australia)	2 (total 150 W max.)

Dimensions	W : 440 mm
	H : 144 mm
	D : 390 mm

Weight (Net)

KRF-V7010, KRF-V6010	9.4 kg
KRF-V5010	8.2 kg

Notes

1. KENWOOD follows a policy of continuous advancements in development. For this reason specifications may be changed without notice.
2. The full performance may not be exhibited in an extremely cold location (under a water-freezing temperature).

Note:

Component and circuit are subject to modification to insure best operation under differing local conditions. This manual is based on General market(M) standard, and provides information on regional circuit modification through use of alternate schematic diagrams, and information on regional component variations through use of parts list.

KENWOOD CORPORATION

14-6,Dogenzaka 1-chome, Shibuya-ku, Tokyo, 150-8501 Japan

KENWOOD SERVICE CORPORATION

P.O BOX 22745, 2201 East Dominguez St., Long Beach, CA 90801-5745, U.S.A.

KENWOOD ELECTRONICS CANADA INC.

6070 Kestrel Road, Mississauga, Ontario, Canada L5T 1S8

KENWOOD ELECTRONICS LATIN AMERICA S.A.

P.O BOX 55-2791, Piso 6 plaza Chase, Cl. 47 y Aquilino de la Guardia Panama, Republic de Panama

KENWOOD ELECTRONICS BRASIL LTDA.

Av Indianópolis, 628, 04062-001 Planalto Paullista São Paulo-SP-Brasil

KENWOOD ELECTRONICS U.K. LIMITED

KENWOOD House, Dwight Road, Watford, Herts., WD1 8EB., United Kingdom

KENWOOD ELECTRONICS BELGUM N.V.

Meachelsesteenweg 418, B-1930 Zaventem, Belgium

KENWOOD ELECTRONICS DEUTSCHLAND GMBH

Rembrücker Str. 15, 63150 Heusenstamm, Germany

KENWOOD ELECTRONICS FRANCE S.A.

13 Boulevard Ney, 75018 Paris, France

KENWOOD ELECTRONICS ITALIA S.p.A.

Via G. Sirtori, 7/9 20129, Milano, Italy

KENWOOD IBÉRICA S.A.

Bolivia, 239-08020 Barcelona, Spain

KENWOOD ELECTRONICS AUSTRALIA PTY. LTD.

(A.C.N. 001499 074)

P.O Box 504, 8 Figtree Drive, Australia Centre, Homebush, N.S.W. 2140, Australia

KENWOOD & LEE ELECTRONICS, LTD.

Unit 3712-3724, Level 37, Tower 1, Metroplaza, 223 Hing Fong Road, Kwai Fong N.T., Hong Kong

KENWOOD ELECTRONICS GULF FZE

P.O.Box 61318, Jebel Ali, Dubai, U.A.E.

KENWOOD ELECTRONICS SINGAPORE PTE LTD.

No. 1 Genting Lane #02-02, KENWOOD Building, Singapore, 349544

KENWOOD ELECTRONICS (MALAYSIA) SDN BHD.

#4.01 Level 4, Wisma Academy Lot 4A, Jalan 19/1 46300 Petaling Jaya Selangor Darul Ehsan Malaysia

KENWOOD ELECTRONICS (THAILAND) CO., LTD.

573/111 Soi Ramkhamhaeng 39, Ramkhamhaeng Road, Wangthonglang, Bangkok, Bangkok 10301 Thailand