

KRF-V7510D/VR-208 KRF-V8010D/VR-209 SERVICE MANUAL

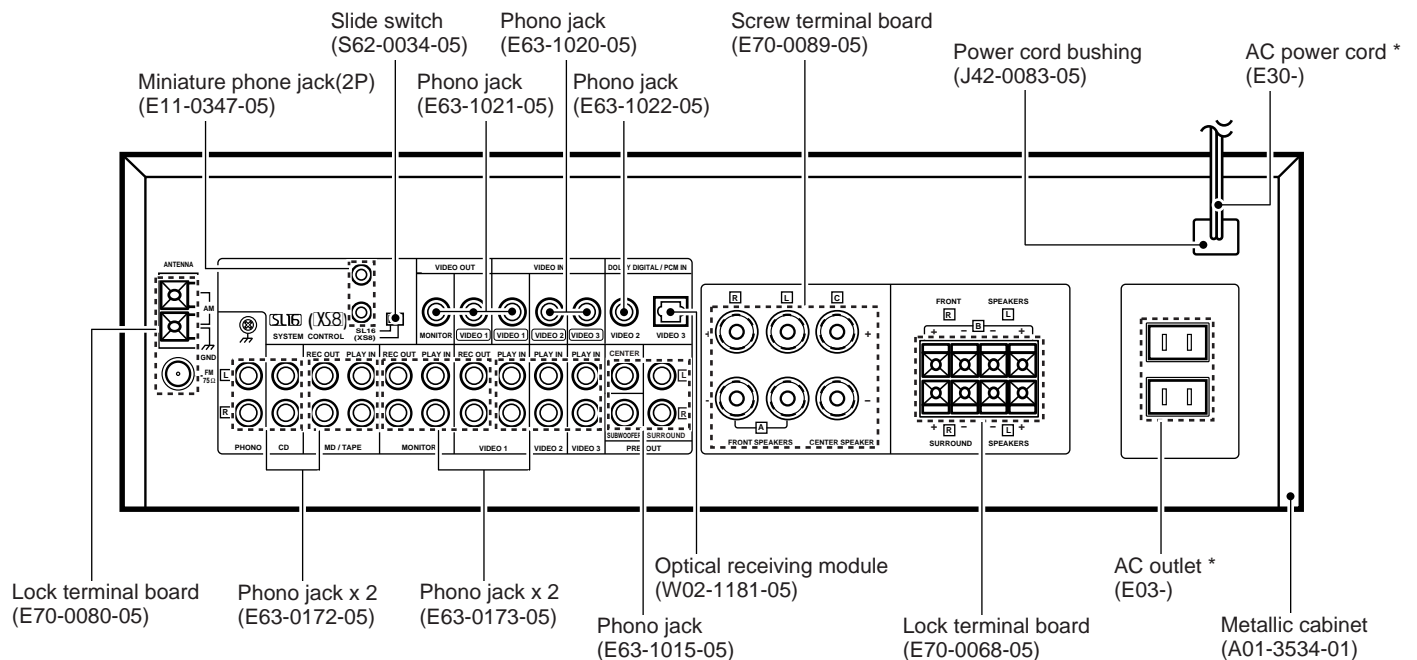

* Refer to parts list on page 32.

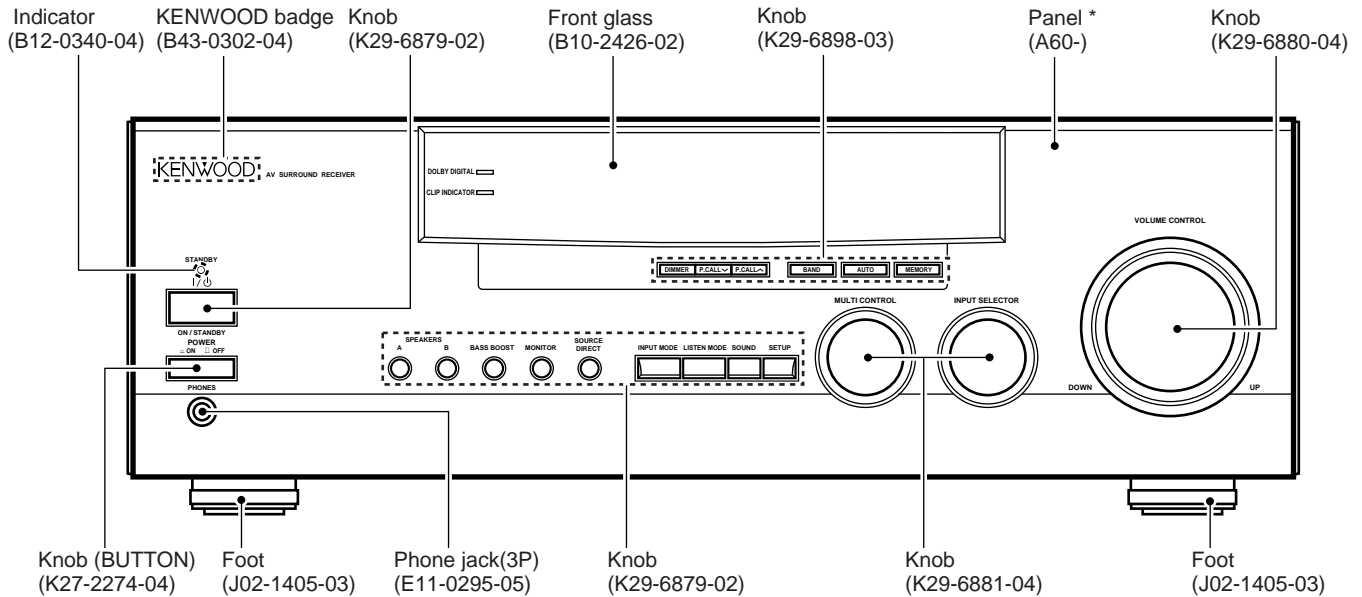



CONTENTS / ACCESSORIES

Contents

CONTENTS / ACCESSORIES	2	PC BOARD	12
CONTROLS	3	SCHEMATIC DIAGRAM	17
DISASSEMBLY FOR REPAIR	5	EXPLODED VIEW	31
BLOCK DIAGRAM	6	PARTS LIST	32
CIRCUIT DESCRIPTION	7	SPECIFICATIONS	41
ADJUSTMENT	11		

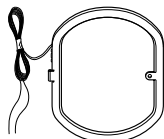
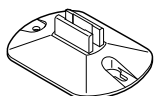
Accessories

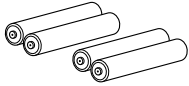
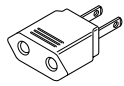
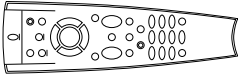
<p>FM indoor antenna (1) (T90-0810-05)</p>	<p>AM loop antenna (1) (T90-0833-05)</p>  <p>Loop antenna stand (1)</p> 	
	<p>Batteries (R03/AAA) (4)</p>	<p>*AC plug adaptor (1) (E03-0115-05)</p>
<p>Remote control unit (1) (A70-1194-05) : KP1Y1K1P2Y2M1 (A70-1195-05) : V</p>		
	<p>Battery cover (A09-0366-08)</p>	<p>*Use to adapt the plug on the power cord to the shape of the wall outlet. (Accessory only for regions where use is necessary.)</p>

Resetting the Microcomputer

If the microcomputer may malfunction (unit cannot be operated, or shows an erroneous display) if the power cord is unplugged while the power is ON, or due to some other external factor. If this happens, execute the following procedure to reset the microcomputer and return the unit to its normal operating condition.

For U.S.A. and Canada

Unplug the power cord from the wall outlet, then plug it back in while holding down the POWER key.

For other countries

With the power cord plugged in, turn the POWER key OFF. Then, while holding down the ON/STANDBY key, press POWER.

- Please note that resetting the microcomputer will clear the contents of the memory and returns the unit to the state it was in when it left the factory.

CONTROLS

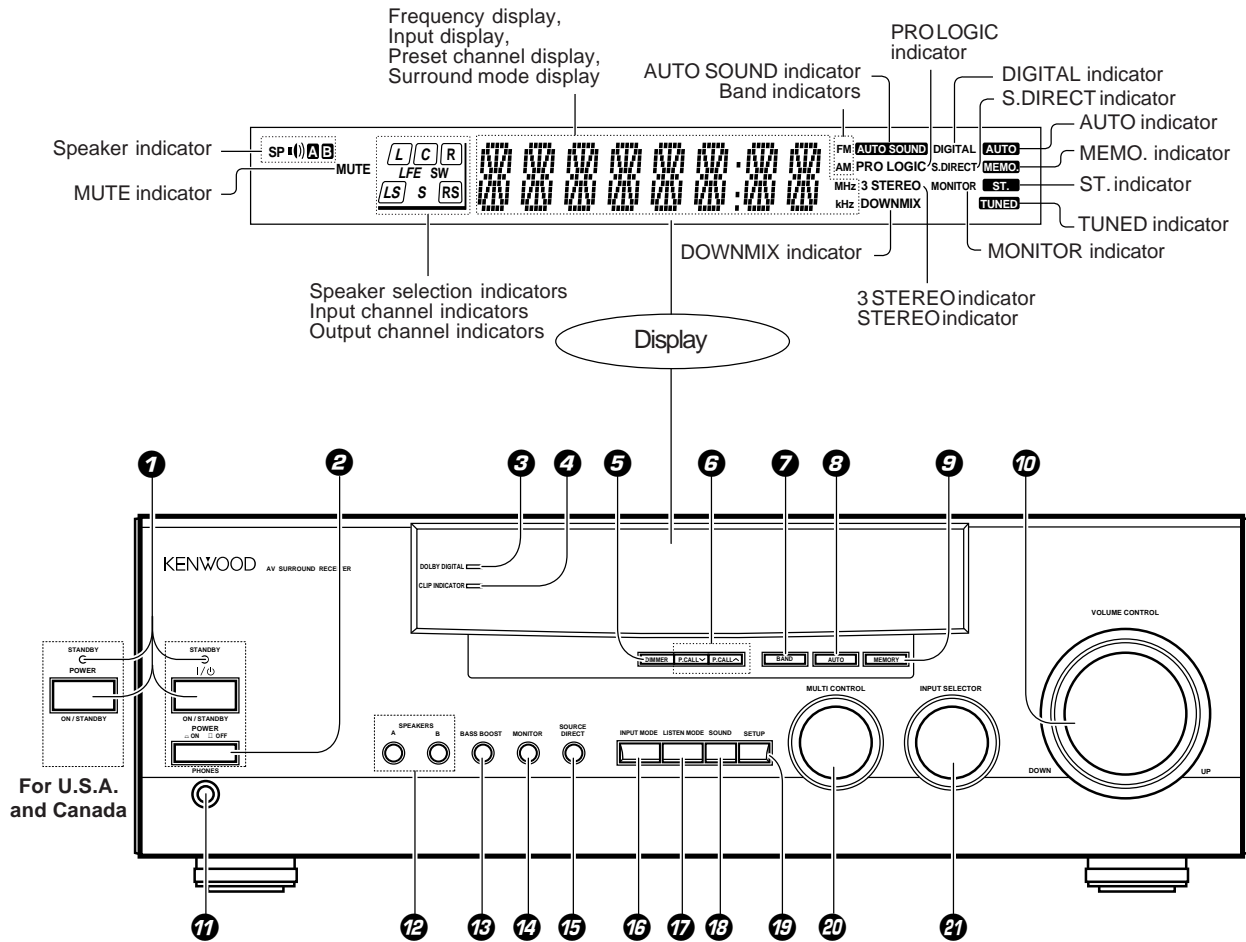

- 1 POWER key (For U.S.A. and Canada)**
Use to turn the power ON/OFF.
STANDBY indicator
- 1 ON/STANDBY (I/ϕ) key (Except for U.S.A. and Canada)**
Use to switch the power ON/STANDBY when the POWER is turned ON.
STANDBY indicator
- 2 POWER key (Except for U.S.A. and Canada)**
Use to turn the main power ON/OFF.
- 3 DOLBY DIGITAL indicator**
Lights when the receiver is in the Dolby Digital mode.
- 4 CLIP INDICATOR**
Lights when the input signal is too large to be handled by the receiver, and "clipping" is occurring.
- 5 DIMMER key**
Use to adjust the brightness of the display.
- 6 P.CALL keys**
Use to call up previously registered radio stations.
- 7 BAND key**
Use to select the broadcast band.
- 8 AUTO key**
Use to select the auto tuning mode.
- 9 MEMORY key**
Use to store radio stations in the preset memory.
- 10 VOLUME CONTROL knob**
- 11 PHONES jack**
Use for headphone listening.
- 12 SPEAKERS A/B keys**
Use to turn the speakers ON/OFF.
- 13 BASS BOOST key**
Use to select the maximum adjustment setting for the low frequency range.
- 14 MONITOR key**
- 15 SOURCE DIRECT key**
- 16 INPUT MODE key**
Use to switch between the digital and analog inputs.
- 17 LISTEN MODE key**
Use to select the listening mode.
- 18 SOUND key**
Use to adjust the sound quality and ambience effects.
- 19 SETUP key**
Use to select the surround sound settings.
- 20 MULTI CONTROL knob**
Used to make a variety of settings.
- 21 INPUT SELECTOR knob**
Use to select the input sources.

About the STANDBY indicator

This unit has a STANDBY indicator. When the STANDBY indicator is lit, the unit consumes a small amount of power to preserve the memory. This is called STANDBY mode. This mode also lets you turn the power ON using the remote control.

CONTROLS

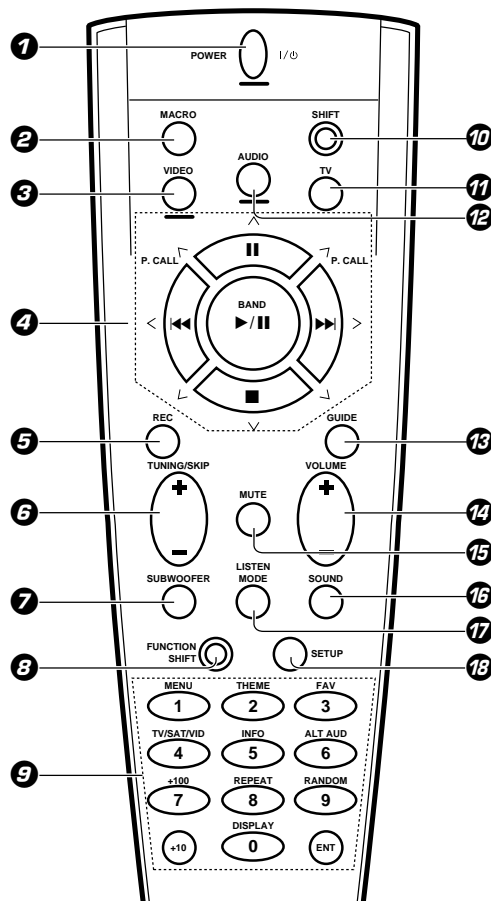

There are some cases in which keys (or knobs) that have the same function on the receiver and on the remote control have different names. In the instructions of this manual, if the names of corresponding keys (or knobs) on the receiver and remote control are different, the name of the remote control key is indicated in parentheses.

1 POWER key

Use to turn the receiver on and off.
Use in combination with the input selector (AUDIO, VIDEO, or TV) keys and SHIFT key to turn various components on and off.

2 MACRO key

Use in combination with the AUDIO, VIDEO, or TV keys to execute a series of commands automatically (MACRO PLAY).

3 VIDEO selector key

Selects the video inputs and sets the remote control to operate the component registered at the respective input.

4 Multi control keys

Use to operate the selected component.

5 REC key

Use to operate the selected component.

6 TUNING/SKIP key

Use during the setup procedure to specify various settings. Use to operate the tuner or selected component.

7 SUBWOOFER key

Use in combination with the VOLUME +/- keys to adjust the volume of the subwoofer.

8 FUNCTION SHIFT key

Use in combination with the numeric keys to execute alternate commands.

9 Numeric keys

Provide functions identical to those of the original remote control supplied with the component you are controlling. To access the functions printed above the keys, press within 3 seconds of pressing the FUNCTION SHIFT key. Function availability varies for each component.

10 SHIFT key

Use in combination with the AUDIO and VIDEO keys to change the remote control mode without changing the input selector or in combination with the POWER key to turn on and off components programmed into the remote control.

11 TV selector key

Sets the remote control to operate a TV or cable box. This key does not change the input selector on the receiver.

12 AUDIO selector key

Selects the audio inputs and sets the remote control to operate the respective KENWOOD audio component.

If you connect audio components from KENWOOD and other makers to the MD/TAPE or CD jacks, you can set the remote control to operate these components by registering the appropriate setup code at the respective input.

13 GUIDE key

Use to activate the OSD menu functions of registered components.

14 VOLUME key

Use to adjust the receiver volume.

15 MUTE key

Use to temporarily mute the sound.

16 SOUND key

Use to adjust the sound quality and ambience effects.

17 LISTEN MODE key

Use to select the listening mode.

18 SETUP key

Use to select the surround sound settings.

DISASSEMBLY FOR REPAIR

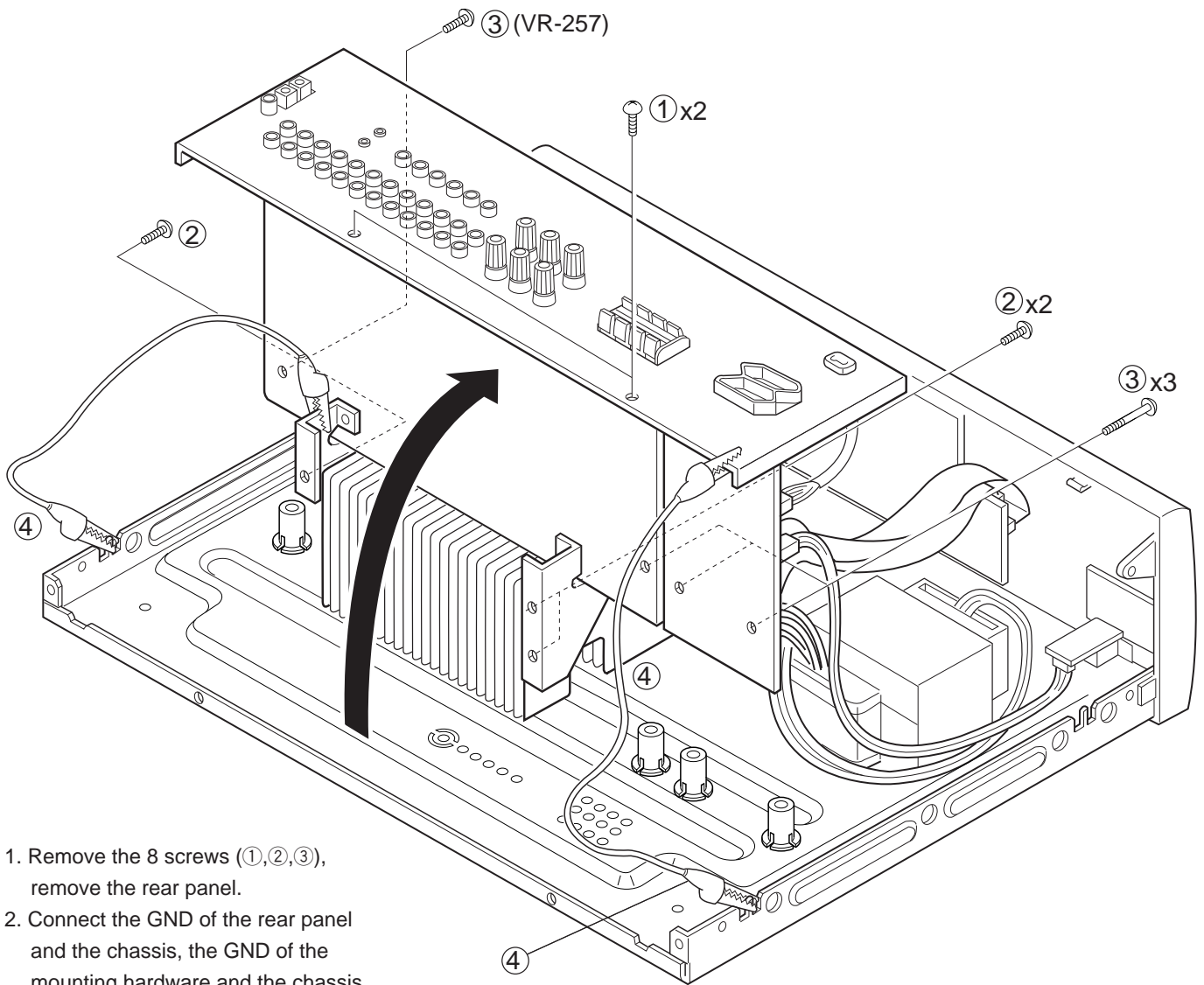

1. Remove the 8 screws (①,②,③), remove the rear panel.
2. Connect the GND of the rear panel and the chassis, the GND of the mounting hardware and the chassis with 2 alligators clip (④)

BLOCK DIAGRAM

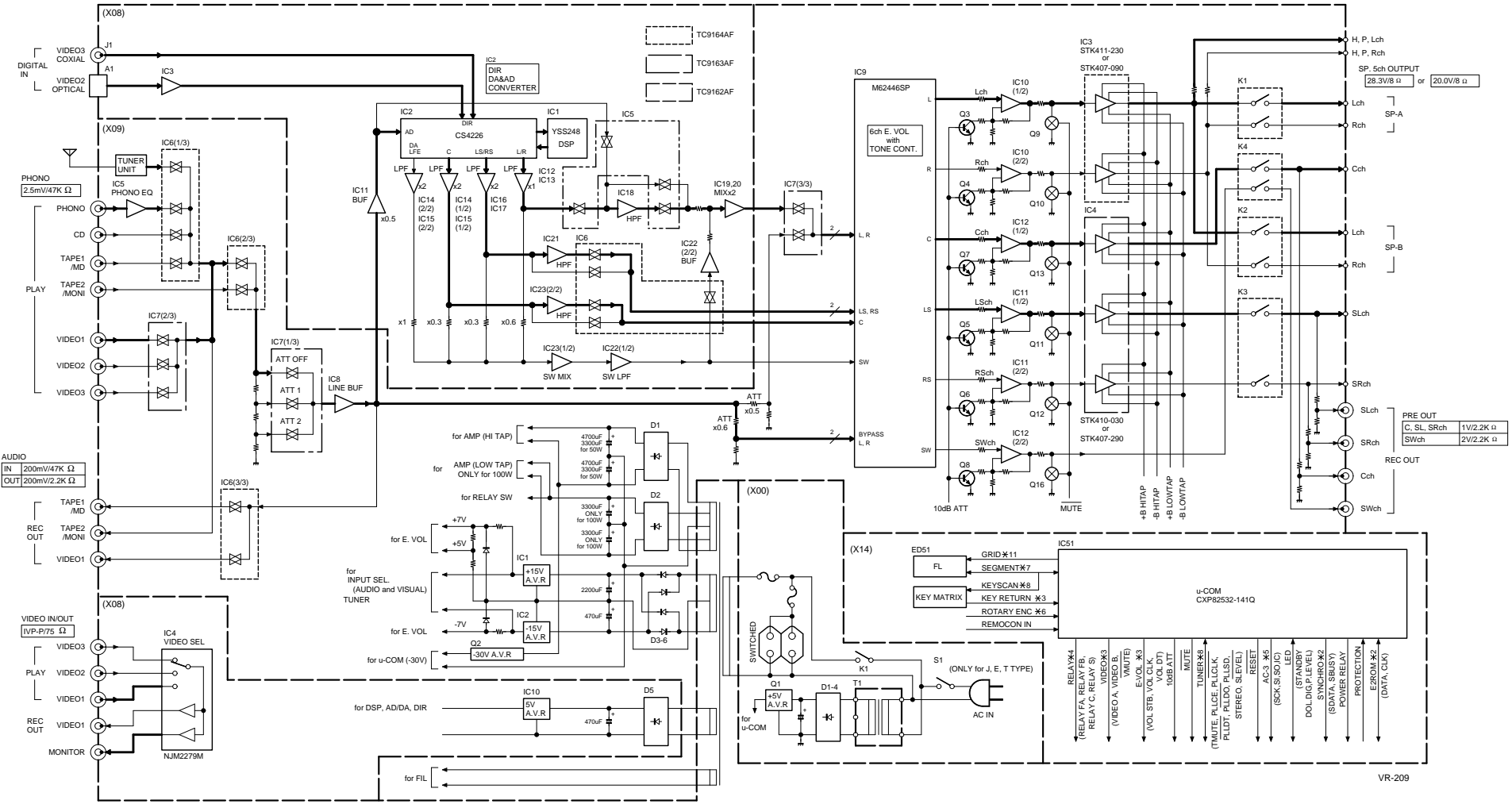

CIRCUIT DESCRIPTION

1. Microprocessor CXP82832-141Q(X09 : IC51)

1-1 Microprocessor periphery block diagram

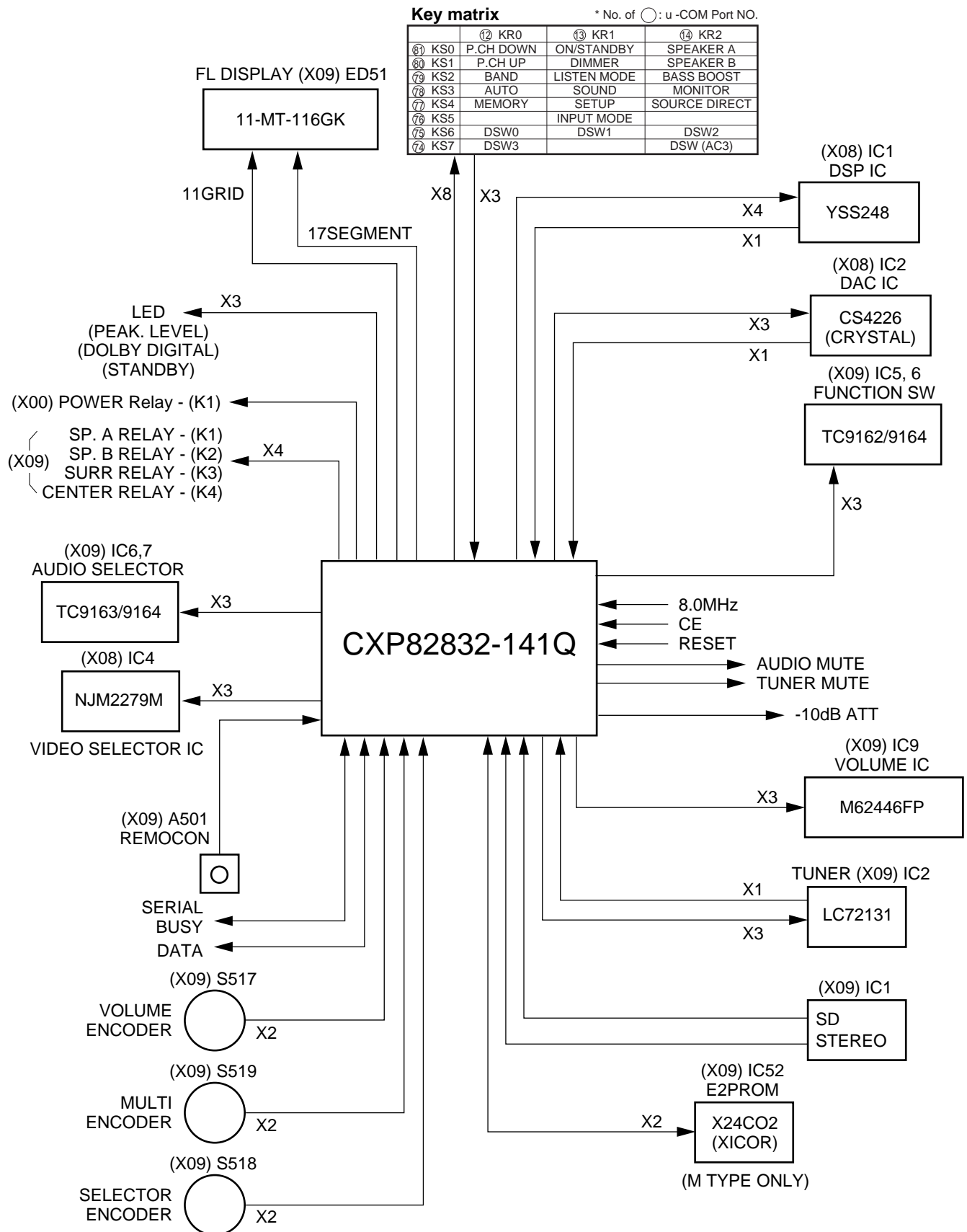

CIRCUIT DESCRIPTION

1-2 Pin description

Pin No.	Pin Name	I/O	Description
1,2	G10,11	O	Display grids 10,11
3	None	-	Ic test mode port.
4,5	None	I	No connect
6	AUDIO	I	Audio signal detection port. L=AUDIO.
7	VOL.ENC.A	I	Volume encoder A(clockwise) output.
8	REMOCON	I	Remote contol signal input.
9	VOL.ENC.B	I	Volume encoder B(counterclockwise) output.
10,11	None	O	Ic test mode port.
12-14	KR0-2	I	Key return 0-2.
15	PROTECT	I	Protection signal detection port. H=PROTECT.
16	S.DATA	I/O	Serial DATA signal.
17	S.BUSY	I/O	Serial BUSY signal.
18	E2.DT	I/O	E2 PROM data.
19	E2.CLK	I/O	E2 PROM clock.
20	SEL.ENC.A	I	Selector encoder A(clockwise) input.
21	SEL.ENC.B	I	Selector encoder B(counterclockwise) input.
22	MULTI.ENC.A	I	Multi encoder A(clockwise) input.
23	MULTI.ENC.B	I	Multi encoder B(counterclockwise) input.
24	SER.IN	I	SL16/XS8 selector. H=16bit.
25	AC3.SCK	O	YSS248 clock output.
26	AC3.SI	I	YSS248 data input.
27	AS3.SO	O	YSS248 data output.
28	Vdd	-	Analog power supply(+5V)
29	None	I	No connect
30	SEL.ST2	O	TC9162AF/63AF/64AF st2 output. H=latch.
31	AC3.CS	O	YSS248 CS output.
32	CODEC.CS	O	CS4226 CS output.
33	PLL.DO	I	Pll ic do signal input port.
34	PLL.ST	I	Tuner stereo signal detection port. L=STEREO.
35	PLL.SD	I	Tuner sd signal detection port. L=TUNED.
36	RCV.CE	I	Receiver chip enable signal port. L=ENABLE.
37	Avss	-	Analog GND.
38	RESET	I	Microprocessor reset signal.
39,40	8MHz	I	Main clock generation(8MHz).
41	Vss	-	Microprocessor GND.
42	None	I	No connect
43	TEX	-	GND.
44	Vdd	-	Power supply(+5V).
45	Vfdp	-	Power supply(-33V).
46	SEL.ST1	O	TC9162AF/63AF/64AF st1 output. H=latch.
47	PLL.DT	O	Pll ic data signal output port.
48	PLL.CK	O	Pll ic clock signal output port.
49	PLL.CE	O	Pll ic ce signal output port.
50	T.TUNE	O	Tuner mute control. L=mute on.
51	A.MUTE	O	Output mute control. L=mute on.
52	SW.MUTE	O	Sub woofer mute control. L=mute on.
53	10dB.ATT	O	Volume 10dB attenuation control. H=att. on.
54	VOL.DT	O	Volume ic (M62446SP) data control.
55	VOL.CK	O	Volume ic (M62447SP) clock control. H=active.
56	VOL.ST	O	Volume ic (M62448SP) st control. H=active.
57	VCR.MUTE	O	Video ic (NJU2279D) cont2/4 mute control. L=mute on.
58	VCR.A	O	Video ic (NJU2279D) cont1 mute control. H/L=static.
59	VCR.BB	O	Video ic (NJU2279D) cont3 mute control. H/L=static.
60	FA.RLY	O	Front A speaker relay control. H=relay on.

CIRCUIT DESCRIPTION

Pin No.	Pin Name	I/O	Description
61	FB.RLY	O	Front B speaker relay control. H=relay on.
62	C.RLY	O	Center speaker relay control. H=relay on.
63	S.RLY	O	Rear speaker relay control. H=relay on.
64	POWER.RLY	O	Power relay control. H=relay on.
65	STANDBY.LED	O	Standby led control.L=led on.
66	DOL.DIG.LED	O	Dolby digital led control.L=led on.
67	P.LEVEL.LED	O	Peak level led control.L=led on.
68-70	None	O	No connect
71	PACL_CTL	O	Non oscillation of power pack ic at power off. L=stop oscillation.
72	AC3.IC	O	YSS248/CS4226 initial clear port.
73	EMPHASIS	O	Tuner emphasis on/off. H=100k/10k,L=50k/9k.
74-81	P1-8	O	Display segments 1-8 & key returns 0-7.
82-88	P9-15	O	Display segments 9-15.
89	Vdd	O	Microprocessor power supply(+5V)
90,91	P16,17	O	Display segments 16,17
92-100	G1-9	O	Display grids 1-9.

2. DSP YSS248 (X08 : IC1)

2-1 Pin description

Pin No.	Pin Name	I/O	Descriptions
1	Vdd	-	Power supply(+5V)
2~7	TEST	O	Test port.
8	XI	I	Crystal oscillation port.
9	XO	O	Crystal oscillation port.
10	Vss	-	GND
11	CPO	O	PLL output port.
12~18	TEST	I	Test port.
19	VIN	I	PLL input port.
20	Vref	I	PLL input port.
21	Vdd	-	Power supply(+5V)
22~29	TEST	I	Test port.
30	Vss	-	GND
31	Vdd	-	Power supply(+5V)
32~39	OPORT	O	Register output ports.
40	Vss	-	GND
41	Vdd	-	Power supply(+5V)
42~44	TEST	I	Test port.
45~47	SDO2~0	O	PCM output port.
48	SDOBCK	I	Bit clock for SD output ports.
49	SDOWCK	I	Word clock for SD output ports.
50	Vss	-	GND
51	Vdd	-	Power supply(+5V)
52	AC3DATA	O	AC3 data detection port.
53	CRC	O	CRC error detection port.
54	MUTE	O	Automatic mute detection port.
55	KARAOKE	O	AC3 karaoke data detection port.
56	SURENC	O	AC3 2/0 mode dolby surround encode input detection port.
57	2/0MODE	O	AC3 2/0 mode input detection port.3.5
58,59	TEST	I	Test port.
60	Vss	-	GND
61	TEST	I	Test port.
62	/IC	I	Initial clear port.
63~65	TEST	I	Test port.
66	/CS	I	Microprocessor interface chip selector input port.

CIRCUIT DESCRIPTION

Pin No.	Pin Name	I/O	Descriptions
67	SO	O	Microprocessor interface serial data output port.
68	SI	I	Microprocessor interface serial data input port.
69	SCK	I	Microprocessor interface clock input port.
70	TEST	I	Test port.
71	Vdd	-	Power supply(+5V)
72~79	STREAM	O	STREAM detection port.
80	Vss	-	GND
81	Vdd	-	Power supply(+5V)
82	SDIWCK	I	Word clock for SD input ports.
83	SDIBCK	I	Bit clock for SD input ports.
84,85	SD10,11	I	AC3 bit stream data input port.
86~89	TEST	I	Test port.
90	Vss	-	GND
91	Vdd	-	Power supply(+5V)
92~99	IPORT	I	Register input ports.
100	Vss	-	GND

3. FUNCTION IC TC9162AF(X08:IC5)

CONDITION(PIN NO.)		(2,27)	(3,26)	(5,24)	(6,23)
S.DIRECT		ON	OFF	*	*
STEREO		ON	OFF	*	*
SURROUND (DOWN MIX)		OFF	ON	*	*
SETUP	TEST TONE	OFF	ON	*	*
	SW-ch ON	*	*	OFF	ON
	SW-ch OFF	*	*	ON	OFF

4. FUNCTION IC TC9164AF(X08:IC6)

CONDITION(PIN NO.)			(2)	(3-5)	(7)	(8)	(10)	(10)
			C-ch HPF	C-ch FLAT	SW-SW+C	-	SR-ch FLAT	SR-ch HPF
SETUP	TEST TONE	SW-ch	*	*	ON	ON	*	*
		SW-ch	*	*	OFF	OFF	*	*
	C-ch	NORMAL	ON	OFF	ON	OFF	OFF	ON
		LARGE or NONE	OFF	ON	OFF	OFF	OFF	ON

5. FUNCTION IC TC9164AF(X08:IC6)

CONDITION(PIN NO.)			(18)	(19)	(21)	(22)	(24)	(25)	(26)	(27)	
DOLBY DIGITAL	YSE		ON	OFF	*	*	*	*	ON	ON	
	NONE		ON	OFF	*	*	*	*	OFF	OFF	
A & B SPEAKER OFF			ON	OFF	ON	OFF	OFF	OFF			
SETUP	TEST TONE		ON	OFF	*	*	OFF	OFF	OFF	OFF	
	SW-ch NONE		ON	OFF	*	*	*	*	OFF	OFF	
	SW-ch	YES	ON	OFF	OFF	ON	ON	ON	ON	*	*
		NONE	ON	OFF	ON	OFF	OFF	OFF	OFF	*	*

*: Be not concerned with the condition.

6. SPEAKER SETUP

SUB WOOFER	YES				NO					
	LOW CUT FREQ.				FULL FREQ.					
FRONT SP										
CENTER SP	NORMAL		NO		LARGE		NORMAL		NO	
SURROUND SP	YES	NO	YES	NO	YES	NO	YES	NO	YES	NO
CENTER MODE (PRO LOGIC)	NORMAL	-	PHANTOM	-	WIDE BAND	-	NORMAL	-	PHANTOM	-

ADJUSTMENT

No.	ITEM	INPUT SETTINGS	OUTPUT SETTINGS	RECEIVER SETTINGS	ALIGNMENT POINTS	ALIGN FOR	FIG.
FM SECTION		SELECTOR : FM					
1	DISTORTION (STEREO)	(A) 98.0MHz 1kHz, ±68.25kHz dev. Selector : L or R Pilot : ±6.75kHz dev. 70dBf(ANT. input)	(B)	98.0 MHz	IFT (TUNER A1)	Minimum distortion (L or R)	
2	TUNING LEVER	(A) 98.0MHz MONO 1kHz, ±75kHz dev. 25dBf(ANT. input)	(B)	MONO 98.0 MHz	VR1 (TUNER UNIT)	Adjust VR1 and stop at the point where ED51 (TUNED) goes on.	

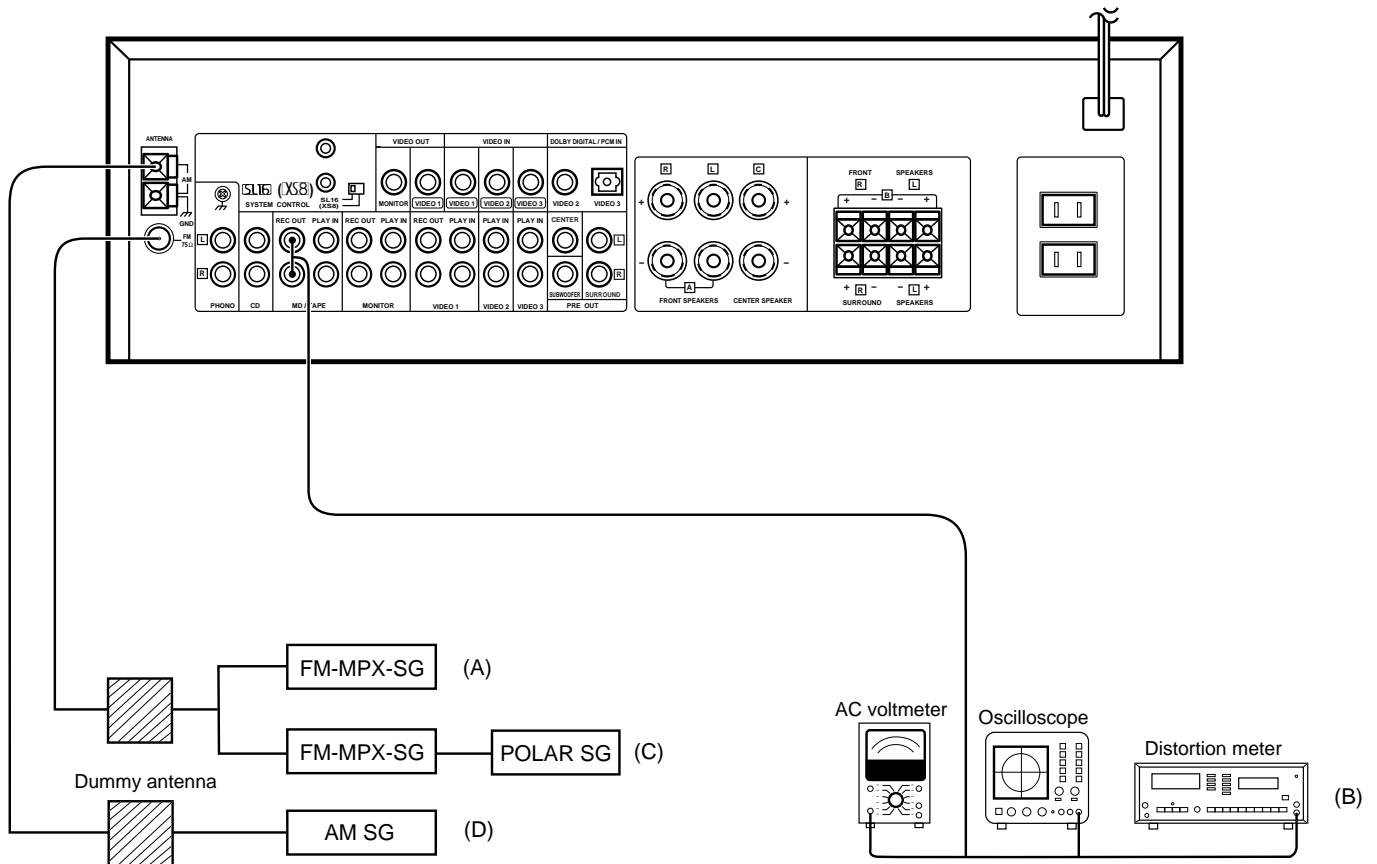

PC BOARD (Component side view)

POWER SUPPLY UNIT

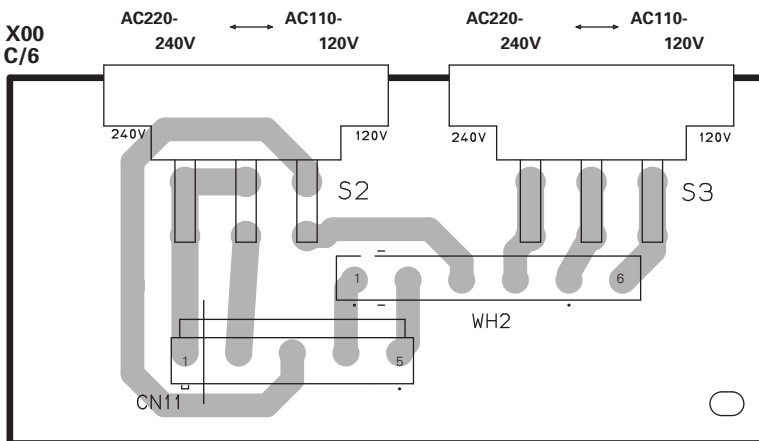
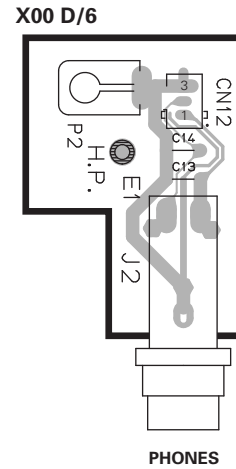
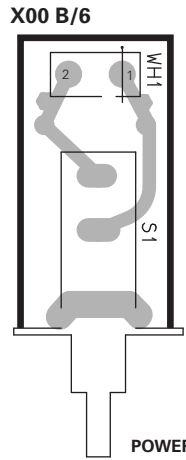
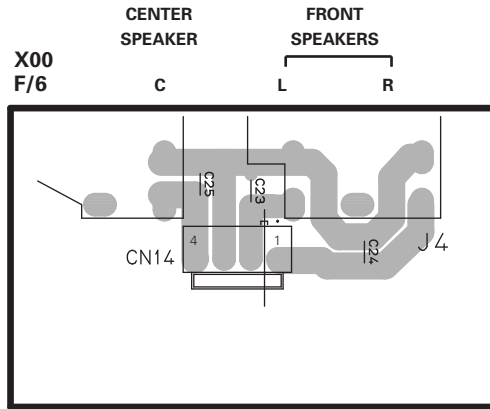
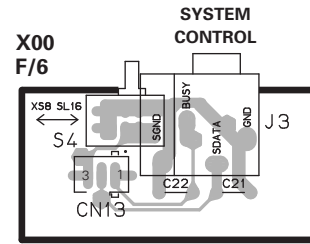
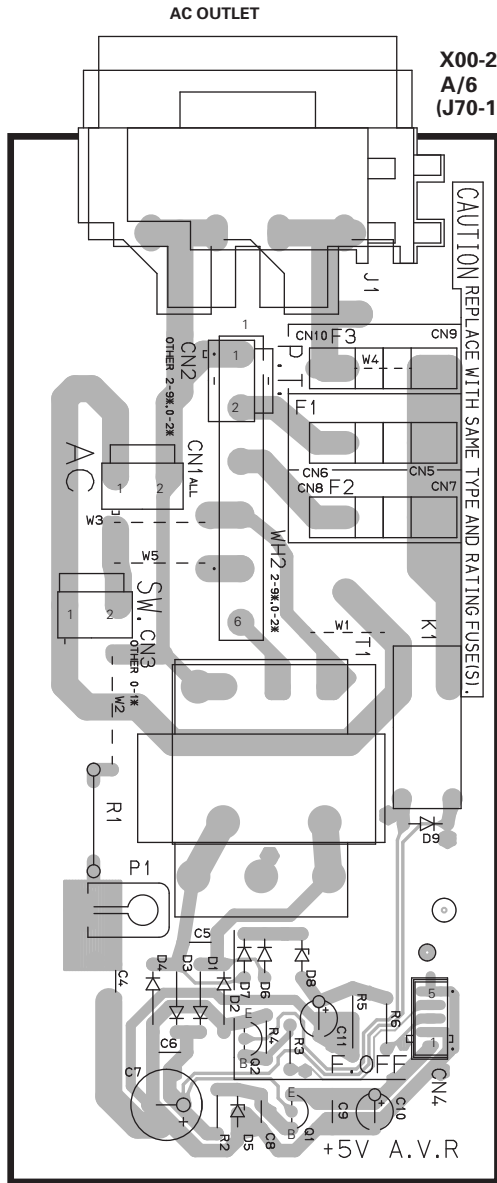

PC BOARD (Component side view)

TUNER UNIT
X05-482X-XX
(J70-1145-11)

ANTENNA

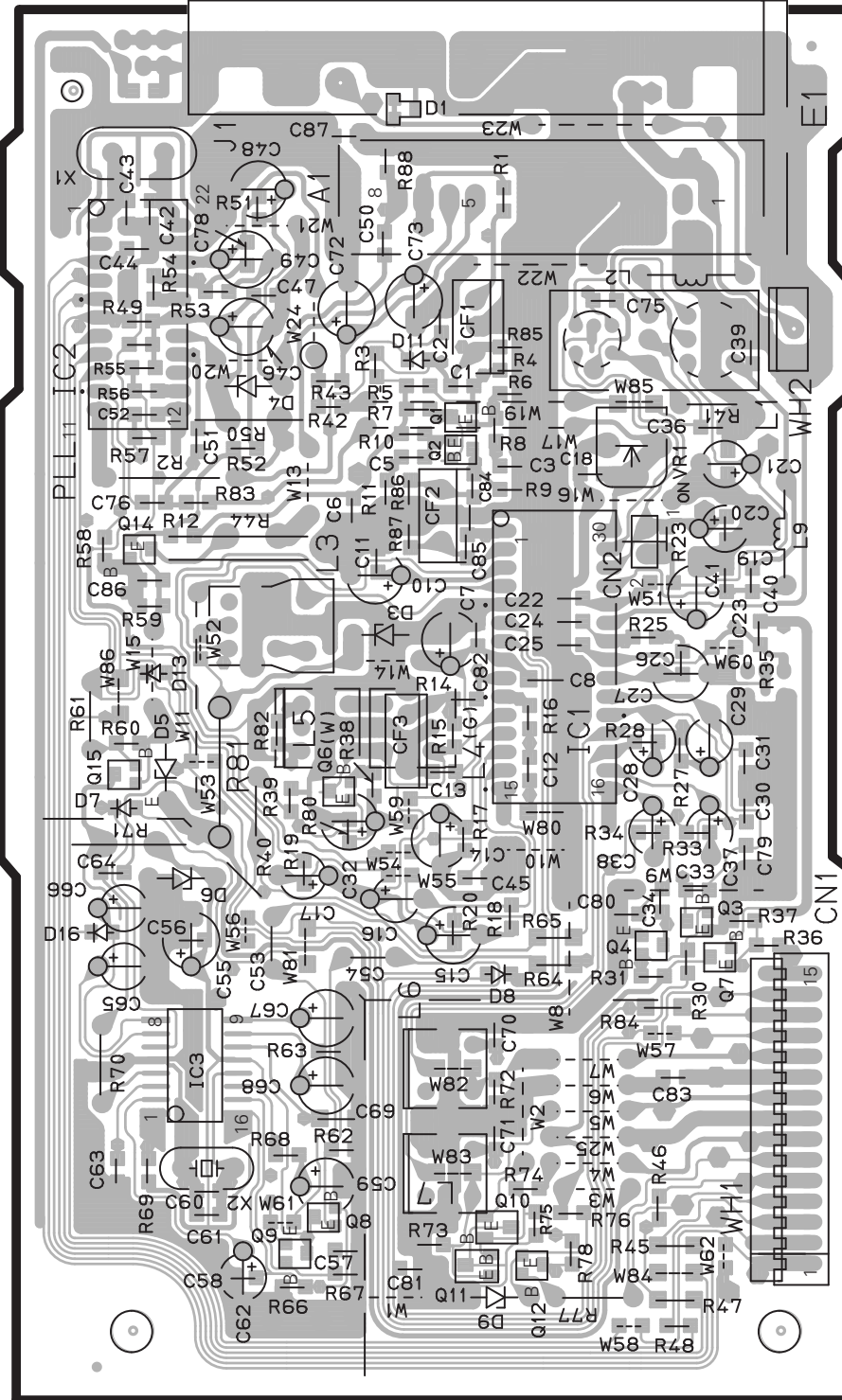

SURROUND UNIT
X08-284X-XX
(J70-1169-21)

SYSTEM CONTROL
MONITOR
VIDEO OUT
VIDEO1
VIDEO1
VIDEO IN
VIDEO2
VIDEO3
DOLBY DIGITAL/
PCM IN
VIDEO2
VIDEO3

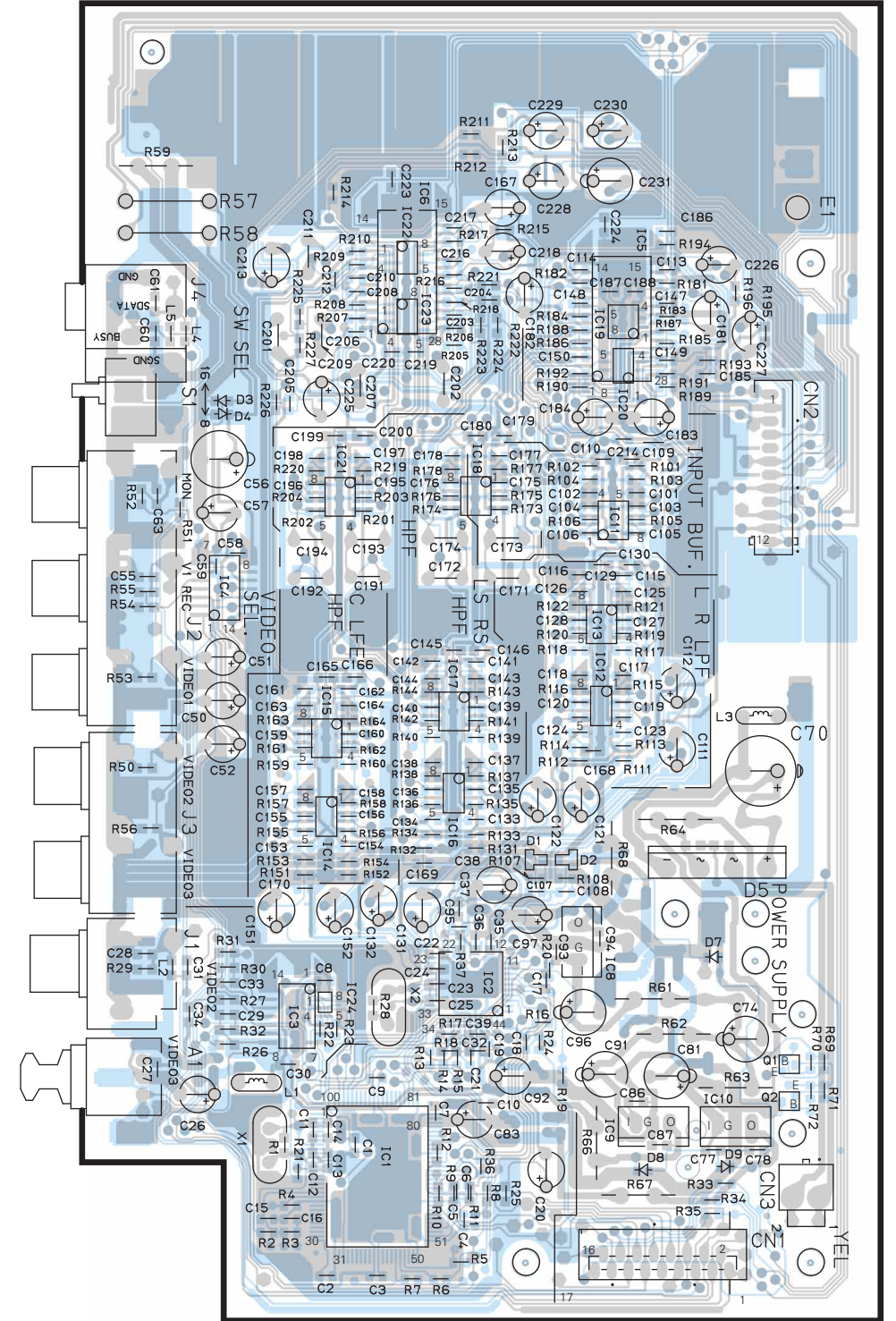

PC BOARD (Component side view)

AUDIO UNIT

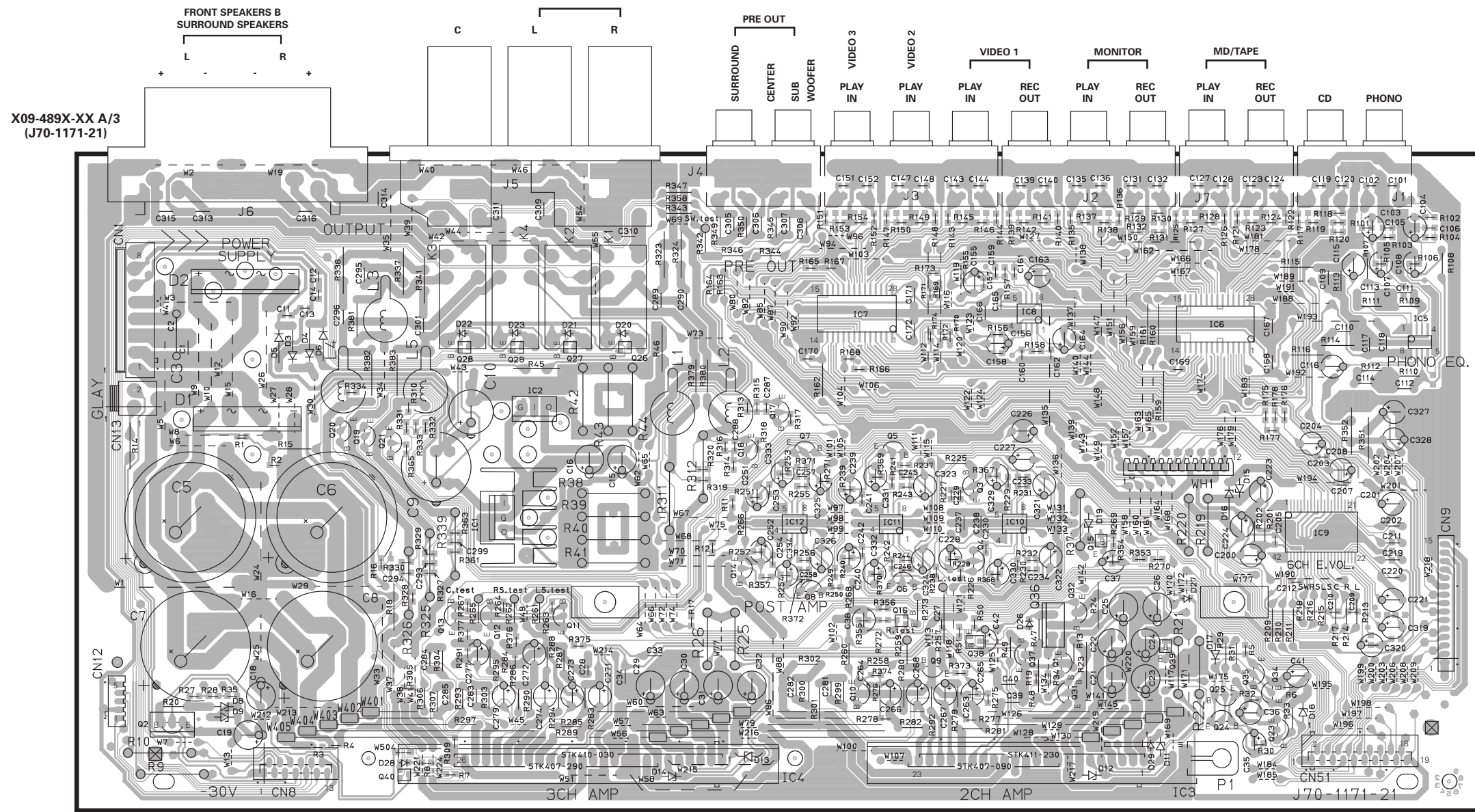

X09 C/3

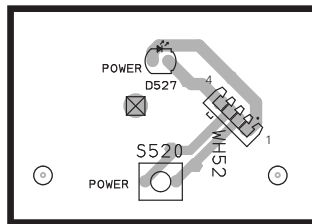

X09 B/3

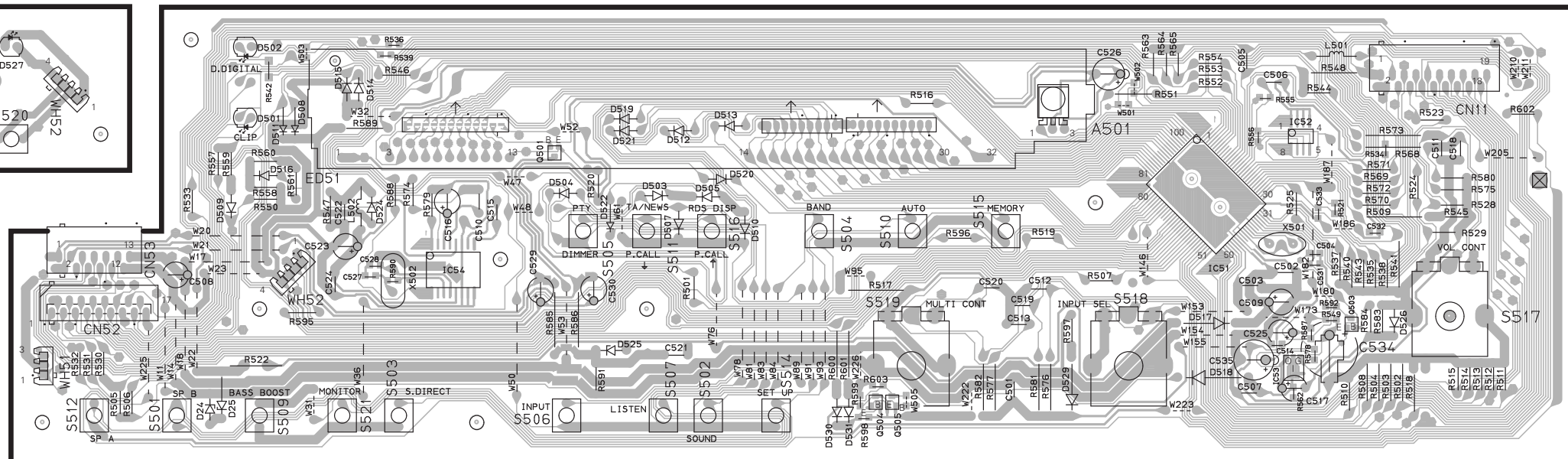

TUNER UNIT
(X05-4XXX-XX)

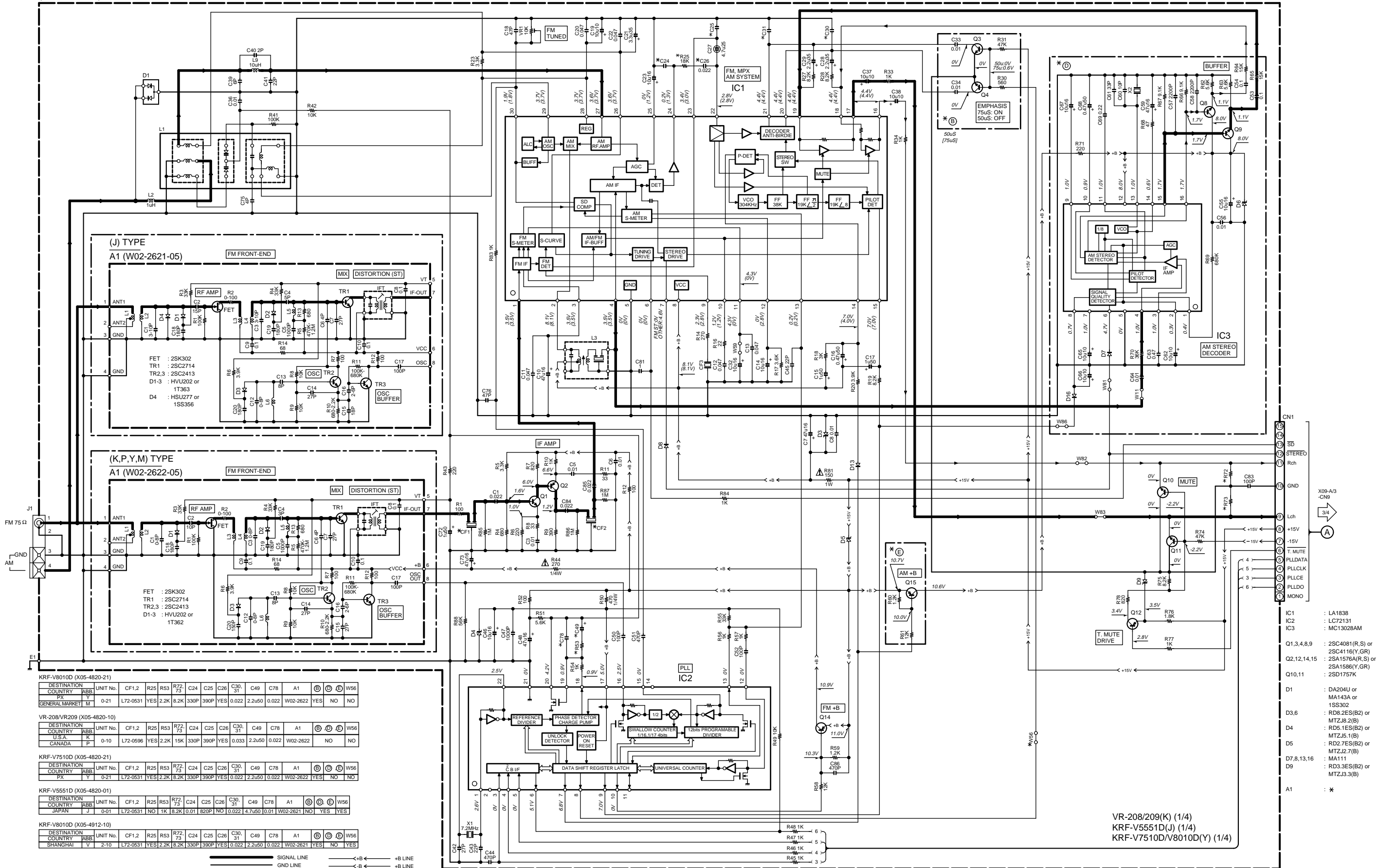

CAUTION: For continued safety, replace safety critical components only with manufacturer's recommended parts (refer to parts list). Δ indicates safety critical components. For continued protection against risk of fire, replace only with same type and rating fuse(s). To reduce the risk of electric shock, leakage-current or resistance measurements shall be carried out (exposed parts are acceptably insulated from the supply circuit) before the appliance is returned to the customer.

The DC voltage is an actual reading measured with a high impedance type voltmeter as the AM/FM signal generator is specified to the conditions as shown in the list below. The measurement value may vary depending on the measuring instruments used or on the product. The value shown in () is actual reading measured in the AM mode.

MODE	CARRIER	MODULATION		ANT INPUT
		FREQUENCY	DEVIATION	
FM	98MHz	1kHz	STEREO 67.5kHz 7.5kHz(Pilot)	60dB
AM	1000(999)kHz	400Hz	MONO 30% MOD	60dB

Y05-3600-10

KRF-V7510D/V8010D/VR-208/209

KENWOOD

SURROUND UNIT
(X08-2840-10)

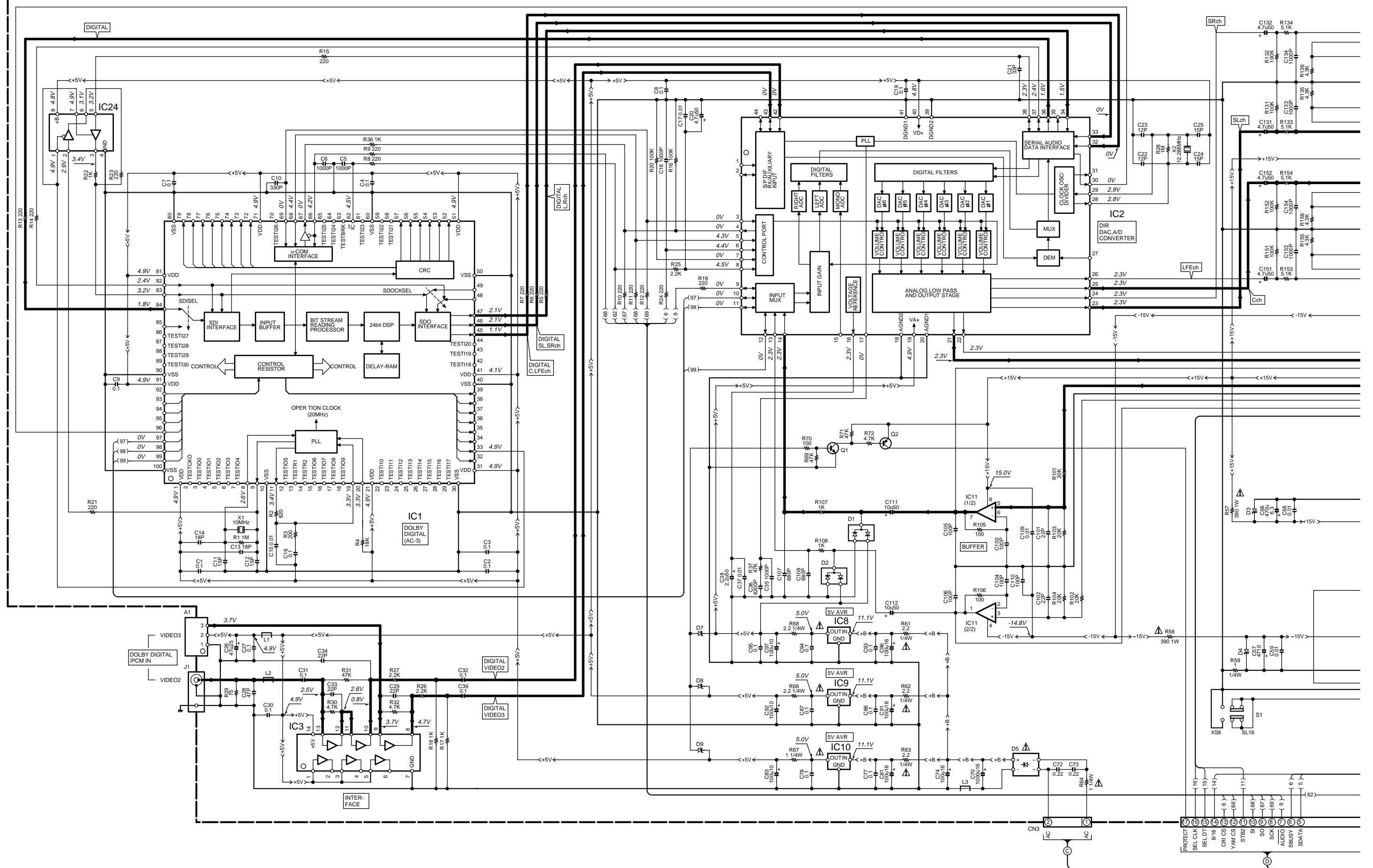

1
2
3
4
5
6
7

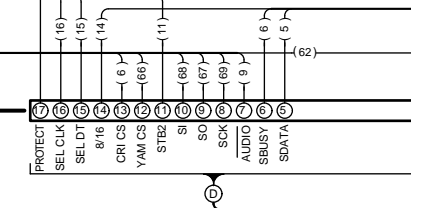

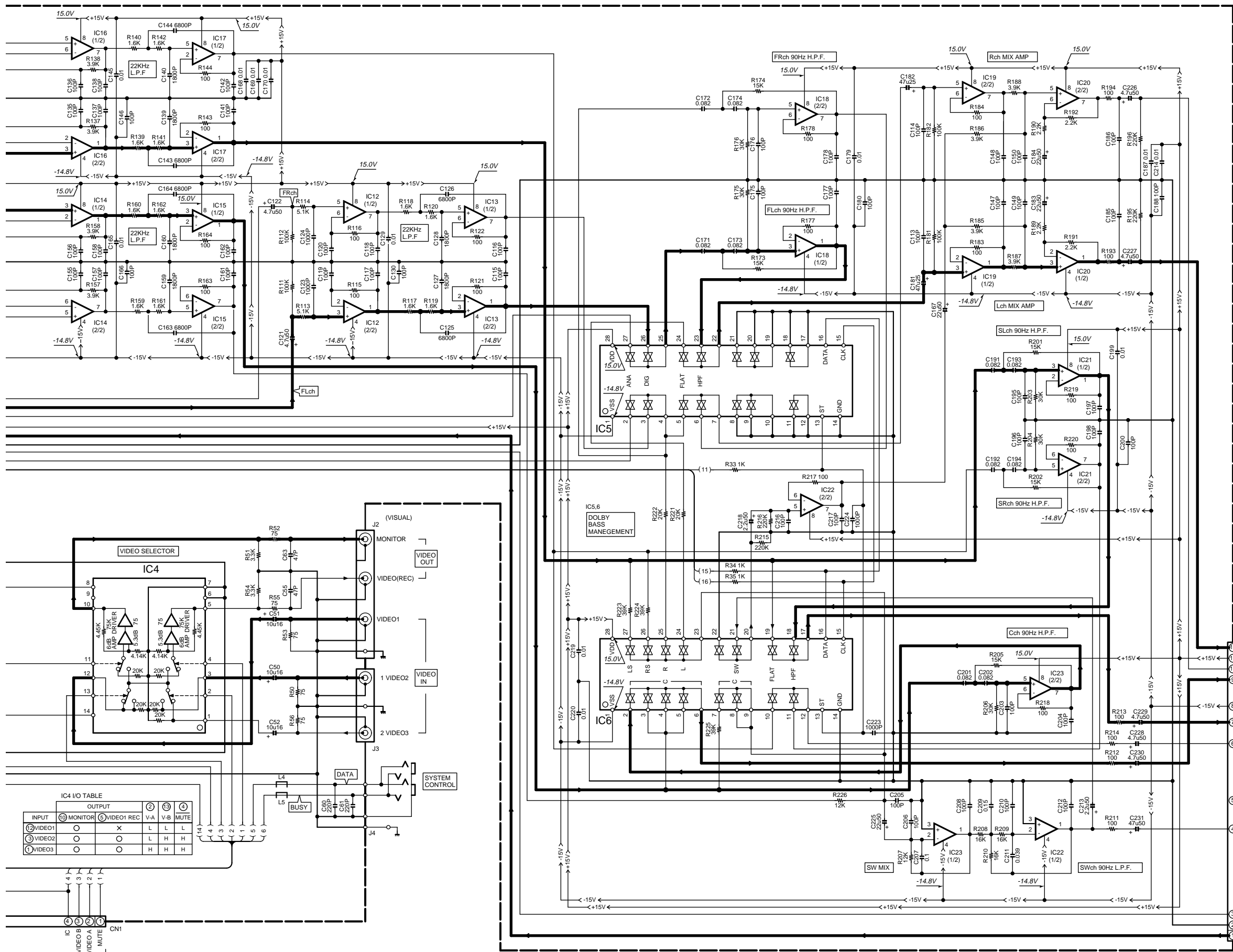

- IC1 : YSS248
- IC2 : CS4226KQC or CS4226-KQ
- IC3 : TC74HCU04AF
- IC4 : NUM2279M
- IC5 : TC9162AF
- IC6 : TC9164AF
- IC8-10 : TA7805SB
- IC11,13,15,17-19,21 : NUM4565M
- IC12,14,16,20,22,23 : NJM4580ED
- IC24 : TC7W241FU
- D1,2 : DA204U or 1SS302
- D3,4 : UD25.1B
- D5 : D2SBA20F03
- D7-9 : UD26.2B
- Q1 : 2SC4081(R,S) or 2SC4116(Y,GR)
- Q2 : 2SA1576A(R,S) or 2SA1586(Y,GR)

CAUTION: For continued safety, replace safety critical components only with manufacturer's recommended parts (refer to parts list). Δ indicates safety critical components. For continued protection against risk of fire, replace only with same type and rating fuse(s). To reduce the risk of electric shock, leakage-current or resistance measurements shall be carried out (exposed parts are acceptably insulated from the supply circuit) before the appliance is returned to the customer.

The DC voltage is an actual reading measured with a high impedance type voltmeter with a cassette loaded at playback mode. The measurement value may vary depending on the measuring instruments used or on the product. Bias circuit DC voltage is measured while in the record mode.

DOLBY and the double-D symbol are trademarks of Dolby Laboratories Licensing Corporation. Noise reduction circuit made under license from Dolby Laboratories Licensing Corporation.

IC4 I/O TABLE

INPUT	MONITOR	VIDEO REC	V-A	V-B	MUTE
VIDEO1	○	×	L	L	L
VIDEO2	○	○	L	H	H
VIDEO3	○	○	H	H	H

VR208/209(K) (2/4)
KRF-V5551D/V7510D/V8010D(M) (2/4)

Y05-3600-10

KRF-V7510D/V8010D/VR-208/209

KENWOOD

(X09-XXXX-XX) (A/3)

VR-208 (X09-4890-11)

DESTINATION	COUNTRY	ABB	UNIT No.	C1,2	C3	C5,6	C7,8	C21,22	C23-26	C33,34	D1,11-14,29	D26	IC3	IC4	Q2	R1,2	R3,4,16	R13	R21	R27,28	R46	R229	R241	R315,316	R343	R367	R369	W4,10,12,28,57,58,60	W56,63
U.S.A.	K		0-11	YES	NO	3300u50	NO	NO	47u50	3900P50	NO	MA111	STK407-090K	STK407-290K	2SA1534A(R,S)	27K	NO	56K	6.2K	820	YES	13K	51K	39K	20K	3.3K	6.2K	YES	NO
CANADA	P		0-11	YES	NO	3300u50	NO	NO	47u50	3900P50	NO	MA111	STK407-090K	STK407-290K	2SA1534A(R,S)	27K	NO	56K	6.2K	820	YES	13K	51K	39K	20K	3.3K	6.2K	YES	NO

VR-209 (X09-4890-10)

DESTINATION	COUNTRY	ABB	UNIT No.	C1,2	C3	C5,6	C7,8	C21,22	C23-26	C33,34	D1,12-14,29	D11	D26	IC3	IC4	Q2	R1,2	R3,4,16	R13	R21	R27,28	R46	R229	R241	R315,316	R343	R367	R369	W4,10,12,28,57,58,60	W56,63	
U.S.A.	K		0-10	YES	NO	4700u75	3300u42	YES	10u100	3900P500	YES	MTZJ7.5(B) or RD7.5JS(B2)	MA111	STK411-230K	STK410-030K or STK410-030D	2SB1640	51K	YES	27K	43K	3.9K	2.7K	NO	9.1K	36K	24K	27K	2.4K	5.6K	NO	YES
CANADA	P		0-10	YES	NO	4700u75	3300u42	YES	10u100	3900P500	YES	MTZJ7.5(B) or RD7.5JS(B2)	MA111	STK411-230K	STK410-030K or STK410-030D	2SB1640	51K	YES	27K	43K	3.9K	2.7K	NO	9.1K	36K	24K	27K	2.4K	5.6K	NO	YES

KRF-V5551D (X09-4890-01)

DESTINATION	COUNTRY	ABB	UNIT No.	C1,2	C3	C5,6	C7,8	C21,22	C23-26	C33,34	D1,12-14,29	D11	D26	IC3	IC4	Q2	R1,2	R3,4,16	R13	R21	R27,28	R46	R229	R241	R315,316	R343	R367	R369	W4,10,12,28,57,58,60	W56,63	
JAPAN	J		0-01	YES	NO	4700u63	3300u35	YES	10u100	3900P500	YES	MTZJ7.5(B) or RD7.5JS(B2)	MA111	STK411-230D	STK410-030K or STK410-030D	2SB1640	51K	YES	27K	43K	3.9K	1.8K	NO	13K	51K	24K	20K	3.3K	6.2K	NO	YES

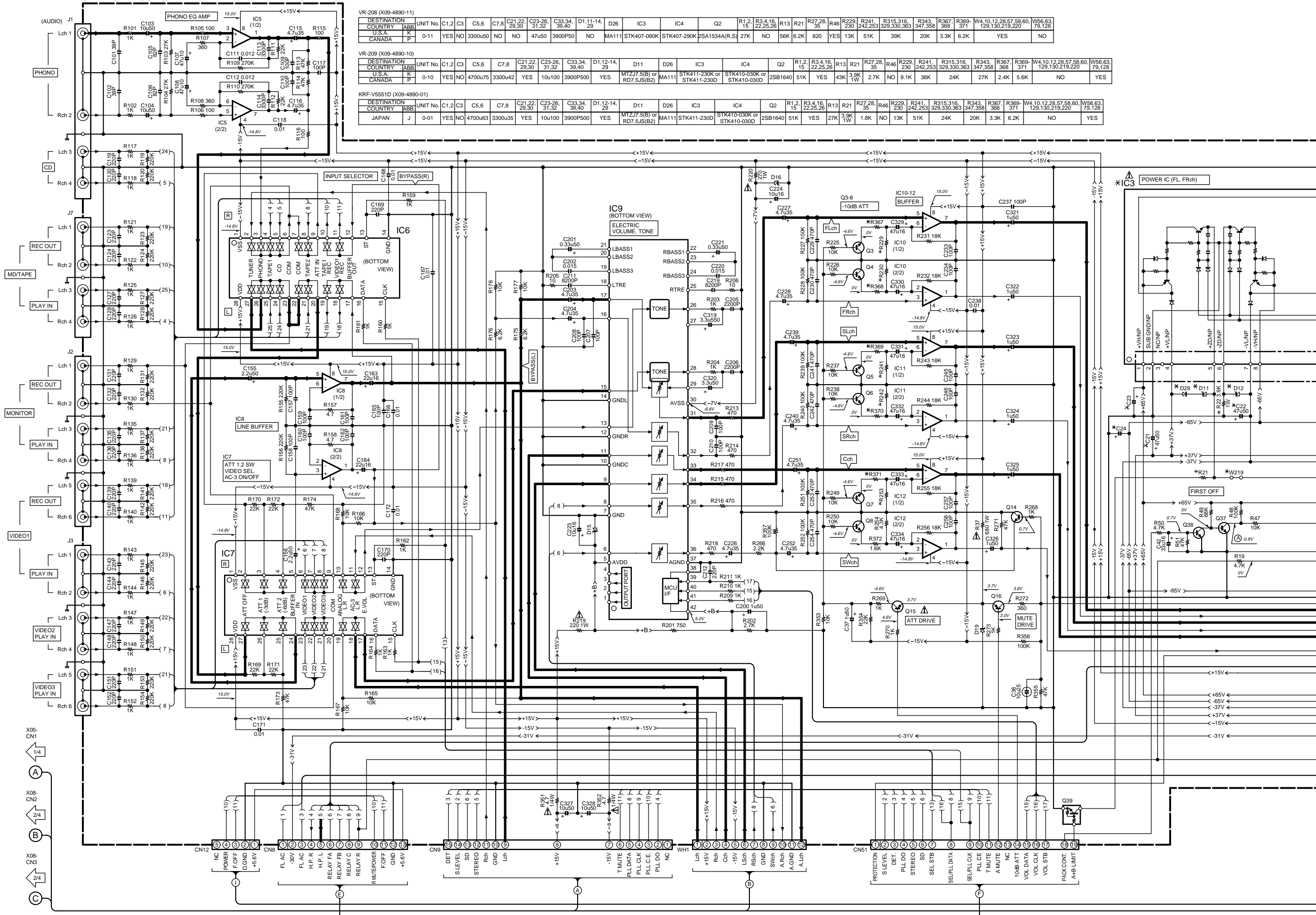

1
2
3
4
5
6
7

KRF-V7510D (X09-4892-91)

DESTINATION	COUNTRY	ABB	UNIT No.	C1,2	C3	C5,6	C7,8	C21,22	C23-26	C33,34	D1,11-14	D26	IC3	IC4	Q2	R1,2	R3,4,16	R13	R21	R27,28	R46	R229	R241	R315,316	R343	R367	R369	W4,10,12,28,57,58,60	W56,63
PX	Y		2-91	NO	YES	3300u50	NO	NO	47u50	3900P50	NO	MA111	STK407-090K	STK407-290K	ZSA1534A(R,S)	27K	NO	22K	6.2K	820	YES	13K	51K	39K	20K	3.3K	6.2K	YES	NO

KRF-V8010D (X09-4890-21)

DESTINATION	COUNTRY	ABB	UNIT No.	C1,2	C3	C5,6	C7,8	C21,22	C23-26	C33,34	D1,12-14	D11	D26	IC3	IC4	Q2	R1,2	R3,4,16	R13	R21	R27,28	R46	R229	R241	R315,316	R343	R367	R369	W4,10,12,28,57,58,60	W56,63	
PX	Y		0-21	NO	YES	4700u75	3300u42	YES	10u100	3900P500	YES	MTZJ7.5(B) or RD7.5JS(B2)	MA111	STK411-230K or STK411-230D	STK410-030K or STK410-030D	2SB1640	51K	YES	51K	27K	3.9K	1.8K	NO	13K	51K	24K	27K	2.4K	5.6K	NO	YES

KRF-V8010D (X09-6062-10)

DESTINATION	COUNTRY	ABB	UNIT No.	C1,2	C3	C5,6	C7,8	C21,22	C23-26	C33,34	D1,12-14	D11	D26	IC3	IC4	Q2	R1,2	R3,4,16	R13	R21	R27,28	R46	R229	R241	R315,316	R343	R367	R369	W4,10,12,28,57,58,60	W56,63	
SHANGHAI	V		2-10	YES	NO	4700u63	3300u35	YES	10u100	3900P500	YES	MTZJ8.2(B) or RD8.2JS(B2)	HSS104A or 1SS133	STK411-230D	STK410-030K or STK410-030D	2SB1640	51K	YES	51K	27K	3.9K	1.8K	NO	13K	51K	24K	27K	2.4K	5.6K	NO	YES

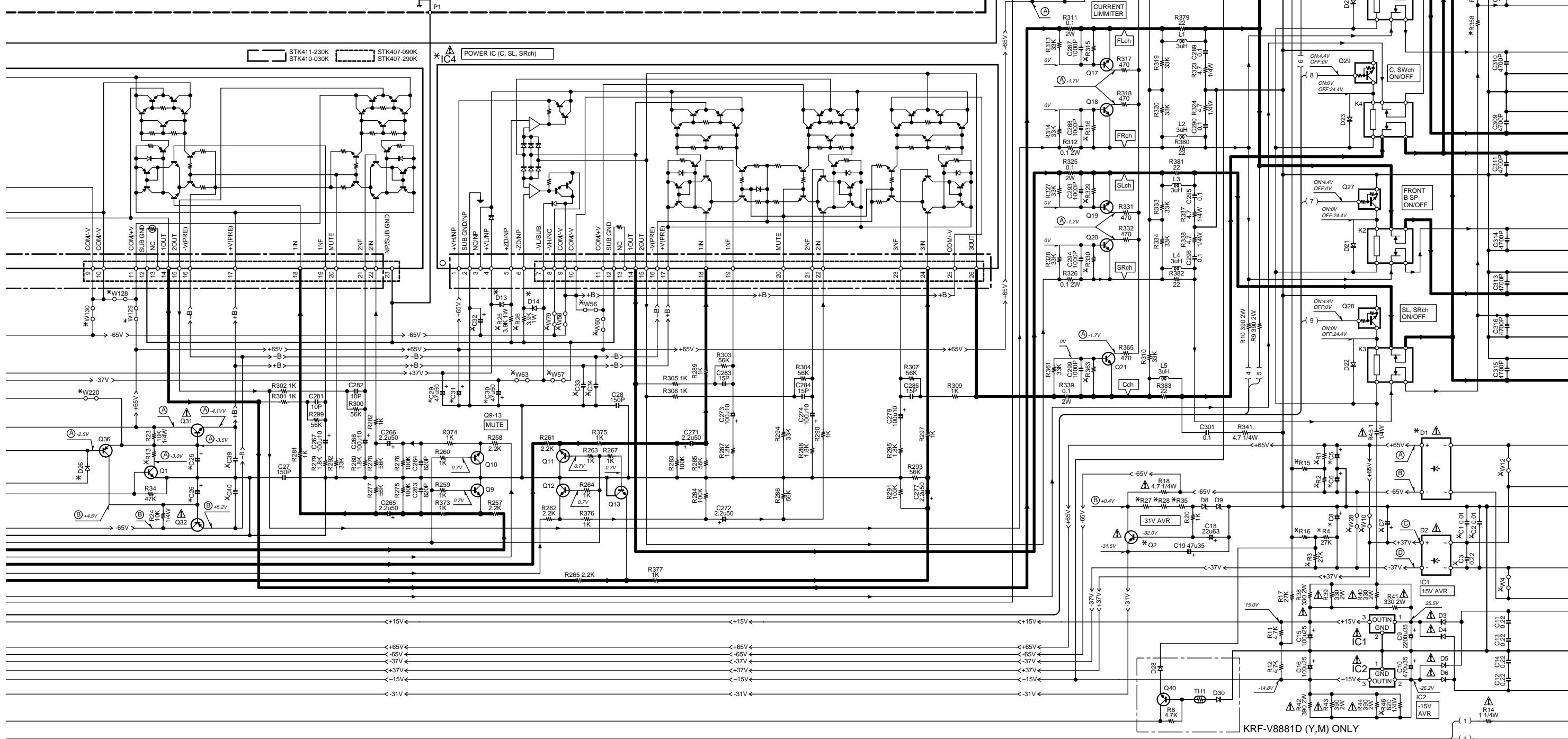

IC1	: TA7815SB	Q1,17-21,24,25,34,35,37	D1,2	: D4SBL20UF03	D17	: 1SS133 or HSS104A	
IC2	: TA79015SB	Q2	: *	D3-6	: 2SC1845(F,E)	D18	: MTZJ4.7(B) or RD4.7ES(B2) or HZS4.7N(B2)
IC3	: *	Q3-14	: 2SC2878(B)	D8,9	: MTZJ16(B) or RD16ES(B2) or HZS16N(B2)	D19	: MTZJ3.3(B) or RD3.3ES(B2) or HZS3.3N(B2)
IC4	: *	Q15,16	: 2SA1576A(R,S)	D11	: *	D20-23,27-30	: MA111
IC5	: NUM4580ED	Q23	: 2SA992(F,E)	D12-14	: MTZJ8.2(B) or RD8.2ES(B) or HZS8.2N(B2)	D26	: *
IC6	: TC9164AF	Q26-29	: DTC123JUA	D15,16	: MTZJ6.8(B) or RD6.8ES(B) or HZS6.8N(B2)		
IC7	: TC9163AF	Q31	: 2SC2631(S,T)				
IC8,10-12	: NJM4565MD	Q32	: 2SA1123(S,T)				
IC9	: M62446FP	Q36	: 2SA1535(Q,R)				
		Q38	: 2SC3722K(R,S)				
		Q39	: DTC113ZUA				
		Q40	: 2SC4116(Y,GR) or 2SC4177(L5,L6)				

DC VOLTAGE FOR IC3

PIN NO	1	2	3	4	5	6	7	8	9	10	11	12	13	14	15	16	17	18	19	20	21	22	23								
STK411-230K	(A)	66.9V	0V	36.1V	(C)	36.3V	28.2V	-28.3V	(D)	-36.4V	(B)	-66.6V	-36.2V	-36.2V	-36.2V	0V	0V	0V	0V	-62.0V	62.8V	0V	0V	-60.8V	0V	0V					
STK407-090K											(B)	(D)	-41.5V	(B)	(D)	-41.5V	(A)	(C)	41.5V	0V	0V	0V	0V	-37.9V	38.2V	0V	0V	-36.6V	0V	0V	0V

DC VOLTAGE FOR IC4

PIN NO	1	2	3	4	5	6	7	8	9	10	11	12	13	14	15	16	17	18	19	20	21	22	23	24	25	26					
STK410-030K	(A)	66.9V	0V	36.1V	(C)	36.4V	28.2V	-28.3V	(D)	-36.4V	(B)	-66.6V	-56.5V	-56.5V	-56.5V	0V	0V	0V	0V	-62.0V	62.8V	0V	0V	-60.8V	0V	0V	-57.9V	0V			
STK407-290K											(B)	(D)	-41.5V	(B)	(D)	-41.5V	(A)	(C)	41.5V	0V	0V	0V	0V	-38.0V	38.2V	0V	0V	-36.8V	0V	0V	0V

KRF-V8881D (Y,M) ONLY

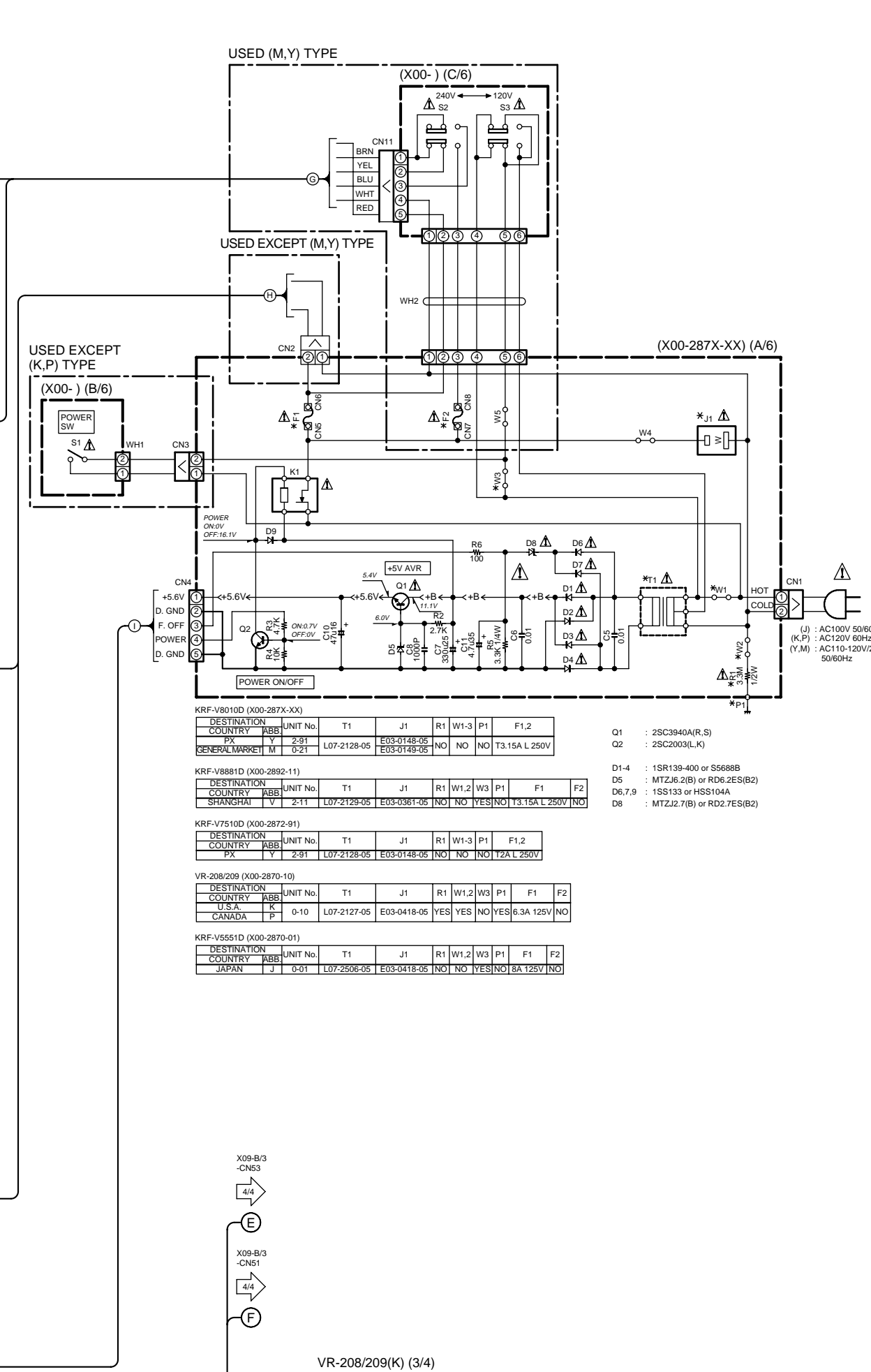
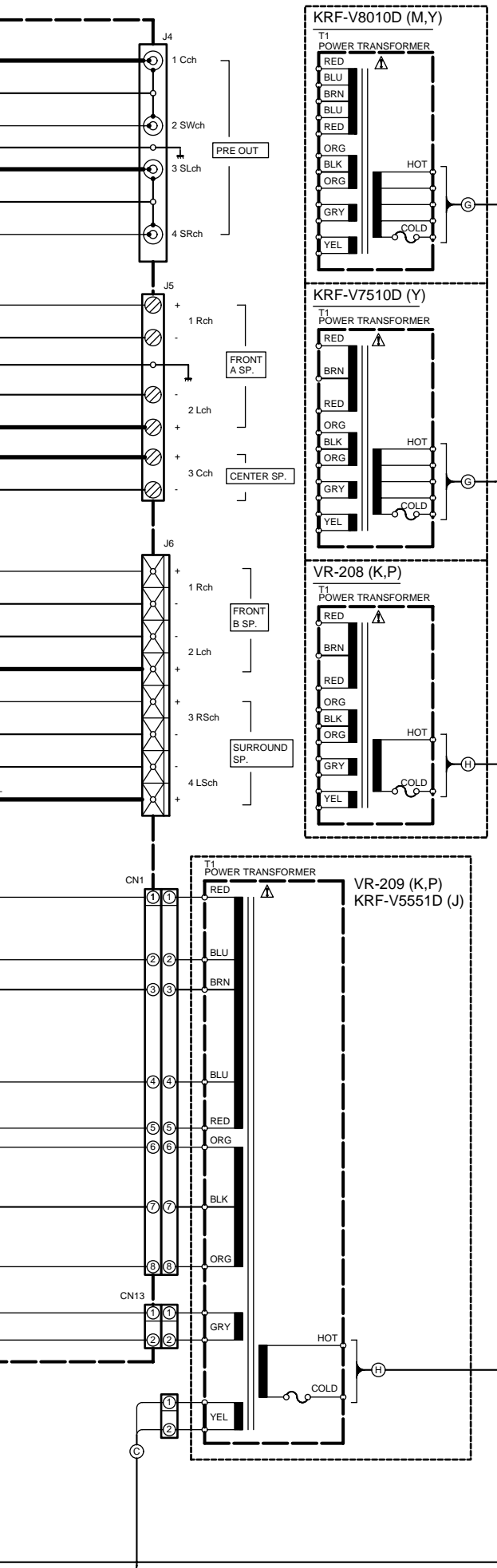

KRF-V8010D (X00-287X-XX)									
DESTINATION	COUNTRY	ABB	UNIT No.	T1	J1	R1	W1-3	P1	F1,2
PX	Y		2-91	L07-2128-05	E03-0148-05	NO	NO	NO	T3.15A L 250V
GENERAL MARKET	M		0-21	L07-2128-05	E03-0149-05	NO	NO	NO	T3.15A L 250V

KRF-V8881D (X00-2892-11)											
DESTINATION	COUNTRY	ABB	UNIT No.	T1	J1	R1	W1,2	W3	P1	F1	F2
PX	Y		2-91	L07-2128-05	E03-0148-05	NO	NO	NO	NO	T2A L 250V	NO
SHANGHAI	V		2-11	L07-2129-05	E03-0381-05	NO	NO	YES	NO	T3.15A L 250V	NO

KRF-V7510D (X00-2872-91)									
DESTINATION	COUNTRY	ABB	UNIT No.	T1	J1	R1	W1-3	P1	F1,2
PX	Y		2-91	L07-2128-05	E03-0148-05	NO	NO	NO	T2A L 250V

VR-208/209 (X00-2870-10)												
DESTINATION	COUNTRY	ABB	UNIT No.	T1	J1	R1	W1,2	W3	P1	F1	F2	
U.S.A.	K		0-10	L07-2127-05	E03-0418-05	YES	YES	NO	YES	6.3A	125V	NO
CANADA	P		0-10	L07-2127-05	E03-0418-05	YES	YES	NO	YES	6.3A	125V	NO

KRF-V5551D (X00-2870-01)												
DESTINATION	COUNTRY	ABB	UNIT No.	T1	J1	R1	W1,2	W3	P1	F1	F2	
JAPAN	J		0-01	L07-2506-05	E03-0418-05	NO	NO	YES	NO	8A	125V	NO

- 2SA1123
- 2SA1534A
- 2SA992
- 2SC1845
- 2SC2003
- 2SC2631
- 2SC2878
- 2SC3940A

- 2SA1586
- 2SC3722K
- 2SC4081
- 2SC4116

- TC9162AF
- TC9163AF
- TC9164AF

- NJM4565M
- NJM4565MD
- NJM4580ED

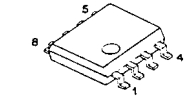
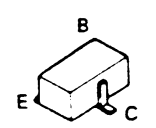
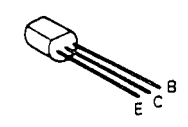

- 2SD1757K

- 2SA1535

- TC74HCU04AF

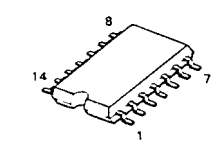
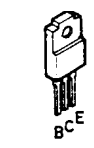
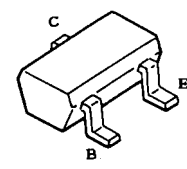

- LA1838

- LC72131

- S-80740AL-A4

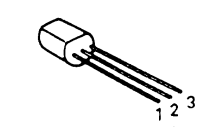
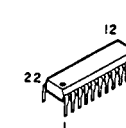
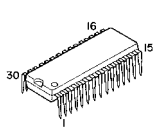

- X24C02S

- DA204U

- TC7W241FU

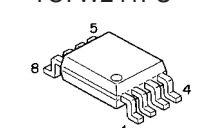
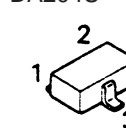
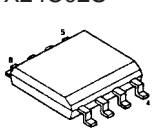

CAUTION: For continued safety, replace safety critical components only with manufacturer's recommended parts (refer to parts list). ⚠ indicates safety critical components. For continued protection against risk of fire, replace only with same type and rating fuse(s). To reduce the risk of electric shock, leakage-current or resistance measurements shall be carried out (exposed parts are acceptably insulated from the supply circuit) before the appliance is returned to the customer.

The DC voltage is an actual reading measured with a high impedance type voltmeter with a cassette loaded at playback mode. The measurement value may vary depending on the measuring instruments used or on the product. Bias circuit DC voltage is measured while in the record mode.

VR-208/209(K) (3/4)
KRF-V5551D/V7510D/V8010D(M) (3/4)

Y05-3600-10

KRF-V7510D/V8010D/VR-208/209

KENWOOD

DISPLAY UNIT
(X09-XXXX-XX) (B/3)

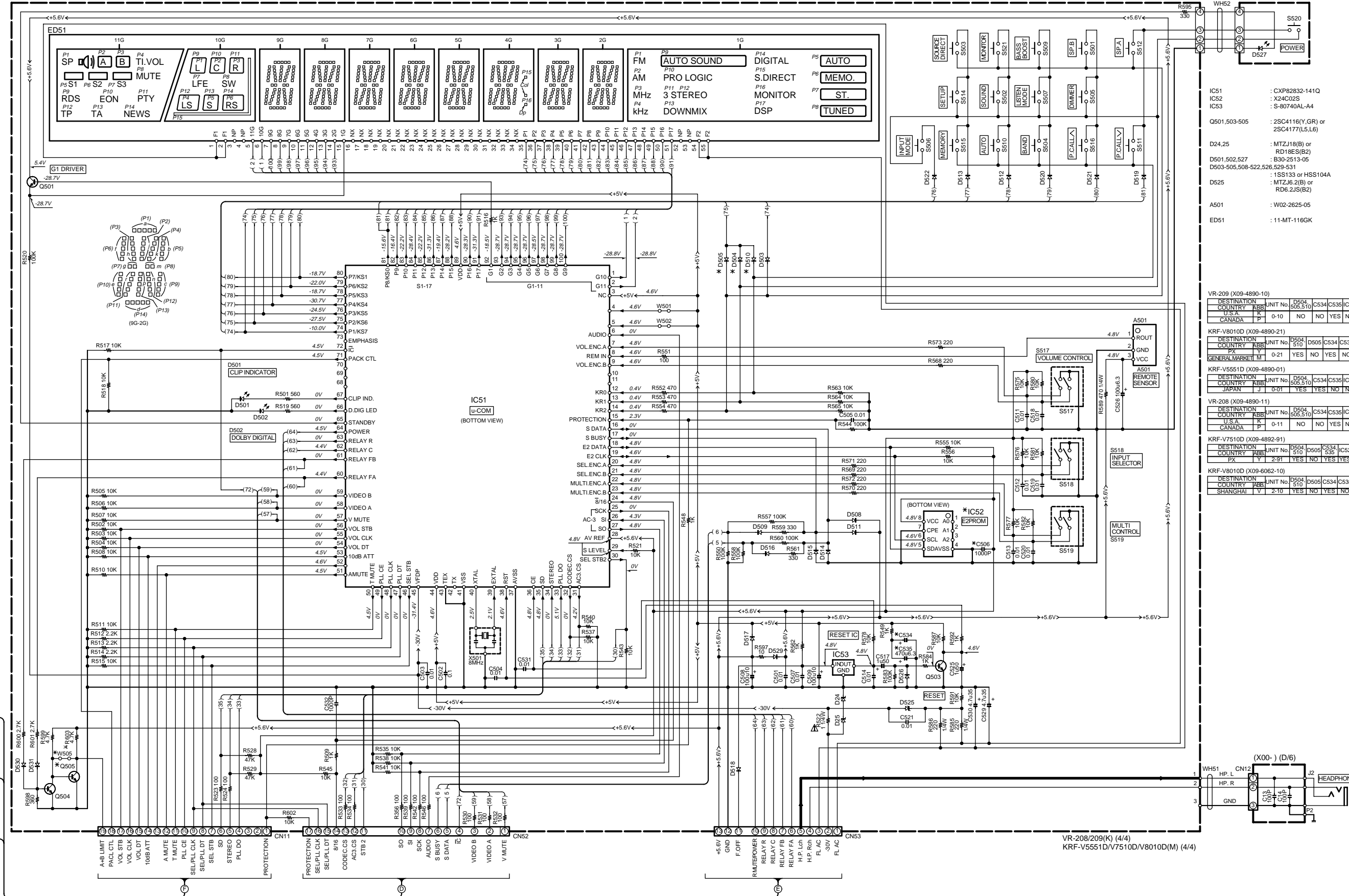

- IC51 : CXP82832-141Q
- IC52 : X24C02S
- IC53 : S-80740AL-A4
- Q501,503-505 : 2SC4116(Y,GR) or 2SC4177(L5,L6)
- D24,25 : MTZJ18(B) or RD18ES(B2)
- D501,502,527 : B30-2513-05
- D503-505,508-522,526,529-531 : 1SS133 or HSS104A
- D525 : MTZJ6.2(B) or RD6.2J(S)(B2)
- A501 : W02-2625-05
- ED51 : 11-MT-116GK

VR-209 (X09-4890-10)

DESTINATION	UNIT No.	D504	D505	C534	C535	IC52	W505	Q505	R603
COUNTRY	ABB	D504	D505	C534	C535	IC52	W505	Q505	R603
U.S.A.	K	0-10	NO	NO	YES	NO	YES	NO	NO
CANADA	P	0-10	NO	NO	YES	NO	YES	NO	NO

KRF-V8010D (X09-4890-21)

DESTINATION	UNIT No.	D504	D505	C534	C535	IC52	W505	Q505	R603
COUNTRY	ABB	D504	D505	C534	C535	IC52	W505	Q505	R603
U.S.A.	K	0-21	YES	NO	YES	NO	YES	YES	NO
GENERAL MARKET	M	0-21	YES	NO	YES	NO	YES	YES	NO

KRF-V5551D (X09-4890-01)

DESTINATION	UNIT No.	D504	D505	C534	C535	IC52	W505	Q505	R603
COUNTRY	ABB	D504	D505	C534	C535	IC52	W505	Q505	R603
JAPAN	J	0-01	YES	YES	NO	NO	YES	NO	NO

VR-208 (X09-4890-11)

DESTINATION	UNIT No.	D504	D505	C534	C535	IC52	W505	Q505	R603
COUNTRY	ABB	D504	D505	C534	C535	IC52	W505	Q505	R603
U.S.A.	K	0-11	NO	NO	YES	NO	NO	YES	YES
CANADA	P	0-11	NO	NO	YES	NO	NO	YES	YES

KRF-V7510D (X09-4892-91)

DESTINATION	UNIT No.	D504	D505	C534	C535	IC52	W505	Q505	R603
COUNTRY	ABB	D504	D505	C534	C535	IC52	W505	Q505	R603
U.S.A.	K	2-91	YES	NO	YES	YES	NO	YES	YES
CANADA	P	2-91	YES	NO	YES	YES	NO	YES	YES

KRF-V8010D (X09-6062-10)

DESTINATION	UNIT No.	D504	D505	C534	C535	IC52	W505	Q505	R603
COUNTRY	ABB	D504	D505	C534	C535	IC52	W505	Q505	R603
SHANGHAI	V	2-10	YES	NO	YES	NO	NO	YES	NO

CAUTION: For continued safety, replace safety critical components only with manufacturer's recommended parts (refer to parts list). indicates safety critical components. For continued protection against risk of fire, replace only with same type and rating fuse(s). To reduce the risk of electric shock, leakage-current or resistance measurements shall be carried out (exposed parts are acceptably insulated from the supply circuit) before the appliance is returned to the customer.

The DC voltage is an actual reading measured with a high impedance type voltmeter with a cassette loaded at playback mode. The measurement value may vary depending on the measuring instruments used or on the product. Bias circuit DC voltage is measured while in the record mode.

Y05-3600-10

KRF-V7510D/V8010D/VR-208/209

KENWOOD

A

B

C

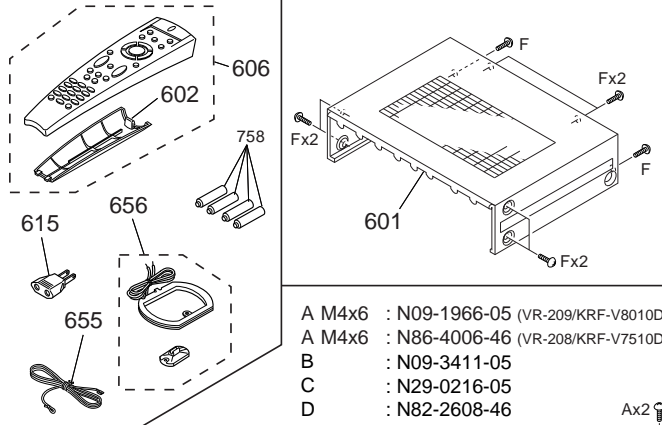

- A M4x6 : N09-1966-05 (VR-209/KRF-V8010D)
- A M4x6 : N86-4006-46 (VR-208/KRF-V7510D)
- B : N09-3411-05
- C : N29-0216-05
- D : N82-2608-46
- E ø3x6 : N89-3006-45
- F ø3x8 : N89-3008-45
- G ø3x8 : N89-3008-46
- H ø3x23 : N89-3023-46

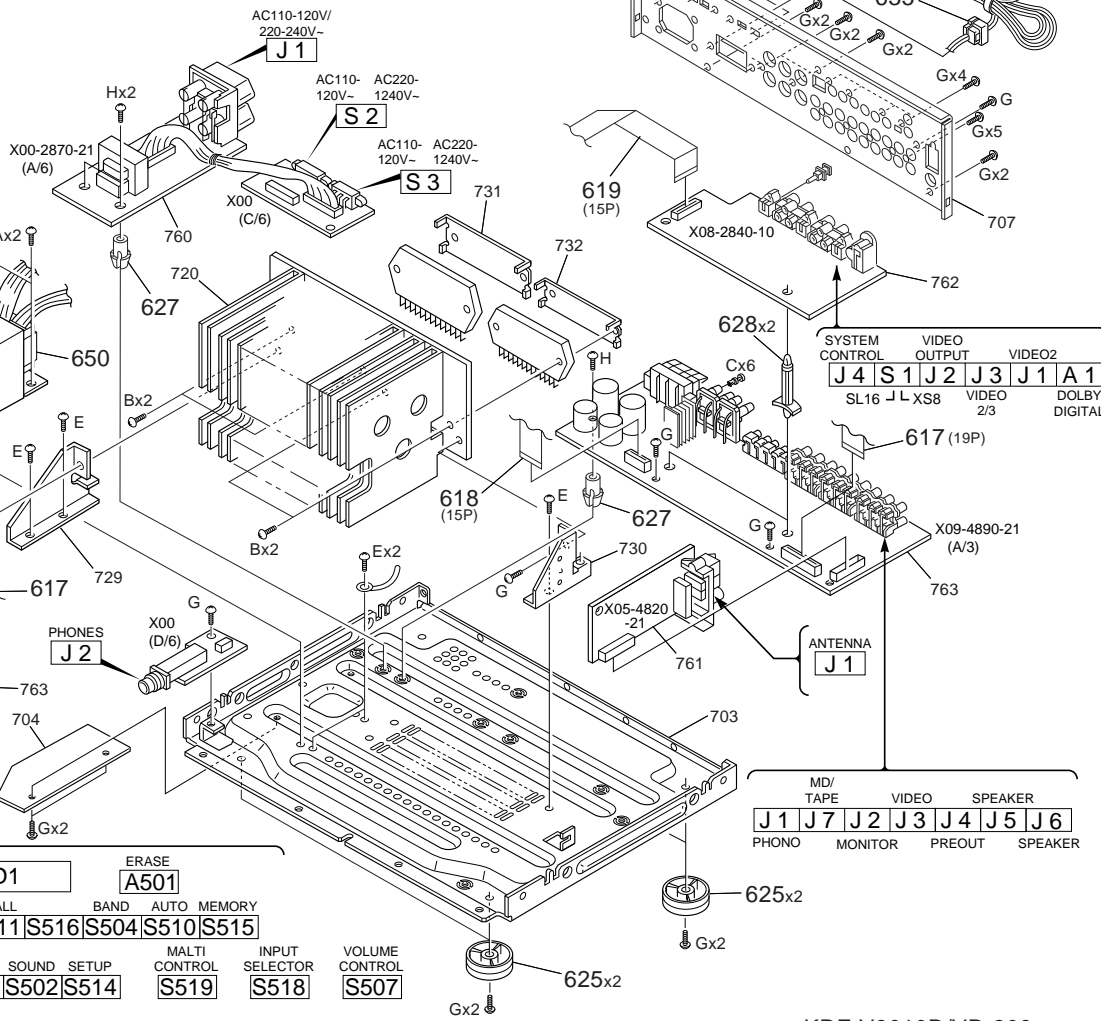

SYSTEM CONTROL	VIDEO OUTPUT	VIDEO2
J4	S1	J2
SL16	JL	XS8
	VIDEO	2/3
		DOLBY DIGITAL

MD/ TAPE	VIDEO	SPEAKER
J1	J7	J2
PHONO	MONITOR	PREOUT
		SPEAKER

ED1	ERASE		
	A501		
DIMMER	P.CALL	BAND	AUTO MEMORY
S505	S511	S516	S504
S510	S515		

A	B	MONITOR	INPUT MODE	SOUND SETUP	MULTI CONTROL	INPUT SELECTOR	VOLUME CONTROL
S512	S501	S509	S521	S503	S506	S507	S502
S514	S502	S507	S503	S506	S507	S502	S514
SPEAKERS	BASS BOOST	XOURCE DIRECT	LISTEN MODE				

KRF-V8010D/VR-209

EXPLODED VIEW

KRF-V7510D/N8010D/VR-208/209

* New Parts
Parts without **Parts No.** are not supplied.
Les articles non mentionnés dans le **Parts No.** ne sont pas fournis.
Teile ohne **Parts No.** werden nicht geliefert.

①

Ref. No	Add-ress	New Parts	Parts No.	Description	Desti-nation	Re-marks
VR-208/209/KRF-V7510D/V8010D						
601	1A	*	A01-3534-01	METALLIC CABINET		
602	1A	*	A09-0366-08	BATTERY COVER		
605	2A	*	A60-1317-01	PANEL	KP1	
605	2A	*	A60-1318-01	PANEL	Y1M1	
605	2A	*	A60-1367-01	PANEL	K1P2	
605	2A	*	A60-1385-01	PANEL	Y2	
605	2A	*	A60-1439-01	PANEL	V	
606	1A	*	A70-1194-05	REMOTE CONTROLLER ASSY	KP1Y1	
606	1A	*	A70-1194-05	REMOTE CONTROLLER ASSY	K1P2Y2	
606	1A	*	A70-1194-05	REMOTE CONTROLLER ASSY	M1	
606	1A		A70-1195-05	REMOTE CONTROLLER ASSY	V	
610	2A	*	B10-2426-02	FRONT GLASS		
611	2A	*	B11-0361-04	SMOKED FILTER		
612	2A	*	B12-0340-04	INDICATOR		
613	2A	*	B43-0302-04	KENWOOD BADGE		
-	-	-	B46-0197-00	QUESTIONNAIRE CARD	KK1	
-	-	-	B46-0329-03	WARRANTY CARD	V	
-	-	-	B46-0330-03	WARRANTY CARD	KY1K1	
-	-	-	B46-0330-03	WARRANTY CARD	Y2	
-	-	-	B46-0336-03	WARRANTY CARD	P1P2	
-	-	-	B58-0513-04	CAUTION CARD (PRESET220-240)	Y1Y2	
-	-	-	B58-0964-13	CAUTION CARD (UL)	KY1K1	
-	-	-	B58-0964-13	CAUTION CARD (UL)	Y2	
-	-	-	B58-0966-13	CAUTION CARD (PL)	M1	
-	-	-	B58-0967-03	CAUTION CARD (PL)	P1P2	
-	-	-	B58-1546-03	CAUTION CARD	V	
-	-	-	B59-1104-00	SERVICE DIRECTORY	Y1Y2	
-	-	*	B60-3598-00	INSTRUCTION MANUAL(ENG)	KP1Y1	
-	-	*	B60-3598-00	INSTRUCTION MANUAL(ENG)	K1P2Y2	
-	-	*	B60-3598-00	INSTRUCTION MANUAL(ENG)	M1	
-	-	*	B60-3600-00	INSTRUCTION MANUAL(FRN)	P1P2	
-	-	*	B60-3602-00	INSTRUCTION MANUAL(SPN,CHN)M1	V	
-	-	*	B60-3603-00	INSTRUCTION MANUAL(CHAINA)	KP1Y1	
-	-	*	B60-3618-00	INSTRUCTION MANUAL(ENG)	K1P2Y2	
-	-	*	B60-3618-00	INSTRUCTION MANUAL(ENG)	M1	
-	-	*	B60-3618-00	INSTRUCTION MANUAL(ENG)	P1P2	
-	-	*	B60-3620-00	INSTRUCTION MANUAL(FRN)	V	
-	-	*	B60-3621-00	INSTRUCTION MANUAL(SPN,CHN)M1	V	
-	-	*	B60-3622-00	INSTRUCTION MANUAL(CHN)	V	
△ 615	1A		E03-0115-05	AC PLUG ADAPTER	M1	
△ 616	1C		E30-2605-05	AC POWER CORD	Y1Y2	
△ 616	1C		E30-2824-15	AC POWER CORD	V	
△ 616	1C		E30-2842-05	AC POWER CORD	M1	
△ 616	1C		E30-2849-05	AC POWER CORD	KP1K1	
△ 616	1C		E30-2849-05	AC POWER CORD	P2	
△ 617	2B,1C	*	E35-2016-05	FLAT CABLE		
618	2A,2B	*	E35-2017-05	FLAT CABLE		
619	2A,1C	*	E35-2018-05	FLAT CABLE		
△ F1			F50-0076-05	FUSE(5X20) 125V 6.3A	K1P2	
△ F1			F50-0077-05	FUSE(5X20) 125V 8A	KP1	
△ F1 ,2			F50-0099-05	FUSE(5X20) 250V T2A	Y2	
△ F1 ,2			F50-0101-05	FUSE(5X20) 250V T3.15A	Y1M1V	

L : Scandinavia K : USA P : Canada R : Mexico C : China I : Malaysia
Y : PX(Far East, Hawaii) T : Europe E : Europe G : Germany V : China (Shanghai)
Y : AAFES(Europe) X : Australia Q : Russia H : Korea M : Other Areas

△ indicates safety critical components.

* New Parts
Parts without **Parts No.** are not supplied.
Les articles non mentionnés dans le **Parts No.** ne sont pas fournis.
Teile ohne **Parts No.** werden nicht geliefert.

②

Ref. No	Add-ress	New Parts	Parts No.	Description	Desti-nation	Re-marks
-		*	H10-7418-02	POLYSTYRENE FOAMED FIXTURE L		
-		*	H10-7419-02	POLYSTYRENE FOAMED FIXTURE R		
-		*	H25-0232-04	PROTECTION BAG (235X350X0.03)		
-		*	H25-0391-04	PROTECTION BAG		
-		*	H50-2715-04	ITEM CARTON CASE	KP1	
-		*	H50-2716-04	ITEM CARTON CASE	M1	
-		*	H50-2717-04	ITEM CARTON CASE	Y1	
-		*	H50-2719-04	ITEM CARTON CASE	K1P2	
-		*	H50-2720-04	ITEM CARTON CASE	V	
-		*	H50-2843-04	ITEM CARTON CASE	Y2	
625	2C		J02-1405-03	FOOT (D=46,H=14.5,T)		
627	1B,2C		J19-5787-04	UNIT HOLDER		
628	1C		J19-5919-05	UNIT HOLDER		
635	1C		J42-0083-05	POWER CORD BUSHING		
-			J61-0307-05	WIRE BAND		
640	2A		K27-2274-04	KNOB (BUTTON)	Y1M1V	
641	2A	*	K29-6879-02	KNOB		
642	2A	*	K29-6880-04	KNOB		
643	2A	*	K29-6881-04	KNOB		
644	2A	*	K29-6898-03	KNOB		
△ 650	1B	*	L07-2485-05	POWER TRANSFORMER	KP1	
△ 650	1B	*	L07-2487-05	POWER TRANSFORMER	Y1M1	
△ 650	1B	*	L07-2494-05	POWER TRANSFORMER	V	
△ 650	1B	*	L07-2496-05	POWER TRANSFORMER	K1P2	
△ 650	1B	*	L07-2498-05	POWER TRANSFORMER	Y2	
655	1A		T90-0810-05	LEAD WIRE ANTENNA		
656	1A		T90-0833-05	LOOP ANTENNA		
POWER SUPPLY (X00-2870-10)						
C5 ,6			CK45FF1H103Z	CERAMIC 0.010UF Z		
C7			CE04EW1E331M	ELECTRO 330UF 25WV		
C8			CK45FB1H102K	CERAMIC 1000PF K		
C10			CE04LW1C470M	ELECTRO 47UF 16WV		
C11			CE04LW1V4R7M	ELECTRO 4.7UF 35WV		
C13 ,14			CC45FSL1H101J	CERAMIC 100PF J		
CN1			E40-4245-05	PIN ASSY	V	
CN1			E40-4245-05	PIN ASSY	Y1M1Y2	
CN2			E40-4245-05	PIN ASSY	KP1K1	
CN2			E40-4245-05	PIN ASSY	P2V	
CN3			E40-4245-05	PIN ASSY	V	
CN3			E40-4245-05	PIN ASSY	Y1M1Y2	
CN4			E40-8197-05	SOCKET FOR PIN ASSY		
CN11			E40-4281-05	PIN ASSY	Y1M1Y2	
CN12			E40-3247-05	PIN ASSY		
△ J1			E03-0148-05	AC OUTLET	KP1Y1	
△ J1			E03-0148-05	AC OUTLET	K1P2Y2	
△ J1			E03-0149-05	AC OUTLET	M1	
△ J1			E03-0361-05	AC OUTLET	V	
J2			E11-0295-05	PHONE JACK (3P)		
CN5 ,6			J13-0075-05	FUSE CLIP		
CN7 ,8			J13-0075-05	FUSE CLIP	Y1M1Y2	
E1			J11-0808-05	WIRE CLAMPER		
△ T1			L07-2127-05	POWER TRANSFORMER	KP1K1	
△ T1			L07-2127-05	POWER TRANSFORMER	P2	

L : Scandinavia K : USA P : Canada R : Mexico C : China I : Malaysia
Y : PX(Far East, Hawaii) T : Europe E : Europe G : Germany V : China (Shanghai)
Y : AAFES(Europe) X : Australia Q : Russia H : Korea M : Other Areas

△ indicates safety critical components.

* New Parts
Parts without **Parts No.** are not supplied.
Les articles non mentionnés dans le **Parts No.** ne sont pas fournis.
Teile ohne **Parts No.** werden nicht geliefert.

3

Ref. No	Add-ress	New Parts	Parts No.	Description	Desti-nation	Re-marks
△ T1			L07-2128-05	POWER TRANSFORMER	Y1M1Y2	
△ T1			L07-2129-05	POWER TRANSFORMER	V	
△ R1			R92-1844-05	CARBON 3.3M J 1/2W	KP1K1	
△ R1			R92-1844-05	CARBON 3.3M J 1/2W	P2	
△ K1			S76-0070-05	MAGNETIC RELAY	V	
△ S1			S68-0088-05	PUSH SWITCH	Y1M1Y2	
△ S1			S68-0088-05	PUSH SWITCH	Y1M1Y2	
△ S2 ,3			S62-0001-05	SLIDE SWITCH	Y1M1Y2	
△ D1 -4			S5688B	DIODE		
△ D1 -4			1SR139-400	DIODE		
△ D5			MTZJ.6.2(B)	ZENER DIODE		
△ D5			RD6.2ES(B2)	ZENER DIODE		
△ D6 ,7			HSS104A	DIODE		
△ D6 ,7			1SS133	DIODE		
△ D8			MTZJ.2.7(B)	ZENER DIODE		
△ D8			RD2.7ES(B2)	ZENER DIODE		
△ D9			HSS104A	DIODE		
△ D9			1SS133	DIODE		
△ Q1			2SC3940A(R,S)	TRANSISTOR		
△ Q2			2SC2003(L,K)	TRANSISTOR		
TUNER (X05-4820-10)						
C1			CK73FB1H223K	CHIP C 0.022UF K		
C3			CK73FB1H103K	CHIP C 0.010UF K		
C5 ,6			CK73FB1H103K	CHIP C 0.010UF K		
C7			CE04LW1C470M	ELECTRO 47UF 16WV		
C8			CK73EB1H103K	CHIP C 0.010UF K		
C10			CE04LW1C470M	ELECTRO 47UF 16WV		
C11 -13			CK73FB1H473K	CHIP C 0.047UF K		
C14			CE04LW1C100M	ELECTRO 10UF 16WV		
C15			CE04LW1H010M	ELECTRO 1.0UF 50WV		
C16			C90-3251-05	ELECTRO 0.47UF 50WV		
C17			C90-3253-05	ELECTRO 1.0UF 50WV		
C18			CC73FCH1H470J	CHIP C 47PF J		
C19			C90-3217-05	ELECTRO 10UF 10WV		
C20			CK73FB1H473K	CHIP C 0.047UF K		
C21			C90-3241-05	ELECTRO 3.3UF 35WV		
C22			CK73FB1H473K	CHIP C 0.047UF K		
C23			CE04LW1C100M	ELECTRO 10UF 16WV		
C24			CK73FB1H331K	CHIP C 330PF K		
C25			CK73FB1H391K	CHIP C 390PF K		
C26			CK73FB1H223K	CHIP C 0.022UF K		
C27			CE04HW1E4R7M	NP-ELEC 4.7UF 25WV		
C28 ,29			C90-3240-05	ELECTRO 2.2UF 35WV		
C30 ,31			CK73FB1H223K	CHIP C 0.022UF K	V	
C30 ,31			CK73FB1H223K	CHIP C 0.022UF K	Y1M1Y2	
C30 ,31			CK73FB1H333K	CHIP C 0.033UF K	KP1K1	
C30 ,31			CK73FB1H333K	CHIP C 0.033UF K	P2	
C32			CE04LW1C100M	ELECTRO 10UF 16WV		
C33 ,34			CK73FB1H103K	CHIP C 0.010UF K	V	
C33 ,34			CK73FB1H103K	CHIP C 0.010UF K	Y1M1Y2	
C36			CK73FB1H103K	CHIP C 0.010UF K		
C37 ,38			C90-3217-05	ELECTRO 10UF 10WV		
C39			CC73FCH1H060D	CHIP C 6.0PF D		

L: Scandinavia K: USA P: Canada R: Mexico C: China I: Malaysia
Y: PX(Far East, Hawaii) T: Europe E: Europe G: Germany V: China (Shanghai)
Y: AAFES(Europe) X: Australia Q: Russia H: Korea M: Other Areas

△ indicates safety critical components.

* New Parts
Parts without **Parts No.** are not supplied.
Les articles non mentionnés dans le **Parts No.** ne sont pas fournis.
Teile ohne **Parts No.** werden nicht geliefert.

4

Ref. No	Add-ress	New Parts	Parts No.	Description	Desti-nation	Re-marks
C40			CC73FCH1H020C	CHIP C 2.0PF C		
C41			CC73FCH1H220J	CHIP C 22PF J		
C42			CC73FCH1H270J	CHIP C 27PF J		
C43			CC73FCH1H220J	CHIP C 22PF J		
C44			CK73FB1H471K	CHIP C 470PF K		
C45			CC73FCH1H220J	CHIP C 22PF J		
C46			CE04LW1C100M	ELECTRO 10UF 16WV		
C47			CK73FB1H102K	CHIP C 1000PF K		
C48			CE04LW1C470M	ELECTRO 47UF 16WV		
C49			CE04LW1H2R2M	ELECTRO 2.2UF 50WV		
C50			CC73FSL1H101J	CHIP C 100PF J		
C51			CK73FB1H471K	CHIP C 470PF K		
C52			CC73FSL1H101J	CHIP C 100PF J		
C72			CE04LW1H010M	ELECTRO 1.0UF 50WV		
C73			CE04LW1C470M	ELECTRO 47UF 16WV		
C75			CC73FCH1H040C	CHIP C 4.0PF C		
C76			CC73FCH1H470J	CHIP C 47PF J		
C78			CK73FB1H223K	CHIP C 0.022UF K		
C81			CK73FF1C105Z	CHIP C 1.0UF Z		
C83			CC73FSL1H101J	CHIP C 100PF J		
C84 ,85			CK73FB1H223K	CHIP C 0.022UF K		
C86			CK73FB1H471K	CHIP C 470PF K		
CN1			E40-9831-05	SOCKET FOR PIN ASSY		
J1			E70-0080-05	LOCK TERMINAL BOARD		
E1			F10-1108-04	SHIELDING PLATE		
CF1 ,2			L72-0531-05	CERAMIC FILTER	V	
CF1 ,2			L72-0531-05	CERAMIC FILTER	Y1M1Y2	
CF1 ,2			L72-0596-05	CERAMIC FILTER	KP1K1	
CF1 ,2			L72-0596-05	CERAMIC FILTER	P2	
CF3		*	L72-0607-05	CERAMIC FILTER		
L1			L39-1366-05	COMBINATION COIL		
L2			L40-1091-82	SMALL FIXED INDUCTOR(1.0UH)		
L3			L30-0911-05	AM IFT		
L9		*	L40-1001-82	SMALL FIXED INDUCTOR(10UH)		
X1		*	L77-2187-05	CRYSTAL RESONATOR		
R1			RK73FB2A101J	CHIP R 100 J 1/10W		
R4			RK73FB2A681J	CHIP R 680 J 1/10W		
R5			RK73FB2A332J	CHIP R 3.3K J 1/10W		
R6			RK73FB2A221J	CHIP R 220 J 1/10W		
R7			RK73FB2A821J	CHIP R 820 J 1/10W		
R8			RK73FB2A330J	CHIP R 33 J 1/10W		
R9			RK73FB2A391J	CHIP R 390 J 1/10W		
R10			RK73FB2A102J	CHIP R 1.0K J 1/10W		
R11			RK73FB2A330J	CHIP R 33 J 1/10W		
R12			RK73FB2A101J	CHIP R 100 J 1/10W		
R14			RK73FB2A271J	CHIP R 270 J 1/10W		
R16			RK73FB2A220J	CHIP R 22 J 1/10W		
R17			RK73FB2A362J	CHIP R 3.6K J 1/10W		
R18			RK73FB2A302J	CHIP R 3.0K J 1/10W		
R19			RK73FB2A822J	CHIP R 8.2K J 1/10W		
R20			RK73FB2A392J	CHIP R 3.9K J 1/10W		
R23			RK73FB2A332J	CHIP R 3.3K J 1/10W		
R25			RK73FB2A183J	CHIP R 18K J 1/10W		

L: Scandinavia K: USA P: Canada R: Mexico C: China I: Malaysia
Y: PX(Far East, Hawaii) T: Europe E: Europe G: Germany V: China (Shanghai)
Y: AAFES(Europe) X: Australia Q: Russia H: Korea M: Other Areas

△ indicates safety critical components.

PARTS LIST

KRF-V7510D/M8010D/M/R-208/209

* New Parts
 Parts without **Parts No.** are not supplied.
 Les articles non mentionnes dans le **Parts No.** ne sont pas fournis.
 Teile ohne **Parts No.** werden nicht geliefert.

5

Ref. No	Add-ress	New Parts	Parts No.	Description	Desti-nation	Re-marks
R27 ,28			RK73FB2A822J	CHIP R 8.2K J 1/10W		
R30			RK73FB2A561J	CHIP R 560 J 1/10W	V	
R30			RK73FB2A561J	CHIP R 560 J 1/10W	Y1M1Y2	
R31			RK73FB2A473J	CHIP R 47K J 1/10W	V	
R31			RK73FB2A473J	CHIP R 47K J 1/10W	Y1M1Y2	
R33 ,34			RK73FB2A102J	CHIP R 1.0K J 1/10W		
R42			RK73FB2A103J	CHIP R 10K J 1/10W		
R43			RK73FB2A221J	CHIP R 220 J 1/10W		
R44			RD14NB2E271J	RD 270 J 1/4W		
R45			RK73EB2B102J	CHIP R 1.0K J 1/8W		
R46			RK73FB2A102J	CHIP R 1.0K J 1/10W		
R47			RK73EB2B102J	CHIP R 1.0K J 1/8W		
R48			RK73FB2A102J	CHIP R 1.0K J 1/10W		
R49			RK73FB2A103J	CHIP R 10K J 1/10W		
R50			RD14NB2E471J	RD 470 J 1/4W		
R51			RK73FB2A562J	CHIP R 5.6K J 1/10W		
R52			RK73FB2A101J	CHIP R 100 J 1/10W		
R53			RK73FB2A222J	CHIP R 2.2K J 1/10W		
R54			RK73FB2A102J	CHIP R 1.0K J 1/10W		
R55			RK73FB2A333J	CHIP R 33K J 1/10W		
R56 ,57			RK73FB2A102J	CHIP R 1.0K J 1/10W		
R58			RK73FB2A123J	CHIP R 12K J 1/10W		
R59			RK73FB2A122J	CHIP R 1.2K J 1/10W		
R72 ,73			RK73FB2A153J	CHIP R 15K J 1/10W	KP1K1	
R72 ,73			RK73FB2A153J	CHIP R 15K J 1/10W	P2	
R72 ,73			RK73FB2A822J	CHIP R 8.2K J 1/10W	V	
R72 ,73			RK73FB2A822J	CHIP R 8.2K J 1/10W	Y1M1Y2	
R74			RK73FB2A473J	CHIP R 47K J 1/10W		
R75			RK73FB2A822J	CHIP R 8.2K J 1/10W		
R76			RK73FB2A182J	CHIP R 1.8K J 1/10W		
R78			RK73FB2A821J	CHIP R 820 J 1/10W		
R81			RS14KB3A151J	FL-PROOF RS 150 J 1W		
R83			RK73FB2A102J	CHIP R 1.0K J 1/10W		
R84			RK73EB2B102J	CHIP R 1.0K J 1/8W		
R85 -87			RK73FB2A105J	CHIP R 1.0M J 1/10W		
R88			RK73FB2A563J	CHIP R 56K J 1/10W		
VR1			R32-0037-05	SEMI FIXED VARIABLE RESISTOR		
W51 ,52			R92-0670-05	CHIP R 0 OHM		
W54 ,55			R92-0670-05	CHIP R 0 OHM	V	
W56			R92-0670-05	CHIP R 0 OHM		
W56			R92-0670-05	CHIP R 0 OHM	Y1M1Y2	
W57			R92-0670-05	CHIP R 0 OHM		
W59 ,60			R92-0670-05	CHIP R 0 OHM		
W80			R92-0679-05	CHIP R 0 OHM		
W82 -85			R92-0679-05	CHIP R 0 OHM		
D1			DA204U	DIODE		
D1			MA143A	DIODE		
D1			1SS302	DIODE		
D3			MTZJ8.2(B)	ZENER DIODE		
D3			RD8.2ES(B2)	ZENER DIODE		
D4			MTZJ5.1(B)	ZENER DIODE		
D4			RD5.1ES(B2)	ZENER DIODE		
D5			MTZJ2.7(B)	ZENER DIODE		
D5			RD2.7ES(B2)	ZENER DIODE		
D8			MA111	DIODE		

L : Scandinavia K : USA P : Canada R : Mexico C : China I : Malaysia
 Y : PX(Far East, Hawaii) T : Europe E : Europe G : Germany V : China (Shanghai)
 Y : AAFES(Europe) X : Australia Q : Russia H : Korea M : Other Areas

Δ indicates safety critical components.

* New Parts
 Parts without **Parts No.** are not supplied.
 Les articles non mentionnes dans le **Parts No.** ne sont pas fournis.
 Teile ohne **Parts No.** werden nicht geliefert.

5

Ref. No	Add-ress	New Parts	Parts No.	Description	Desti-nation	Re-marks
D9			MTZJ3.3(B)	ZENER DIODE		
D9			RD3.3ES(B2)	ZENER DIODE		
D13			MA111	DIODE		
IC1			LA1838	ANALOGUE IC		
IC2			LC72131	MOS-IC		
Q1			2SC4081(R,S)	TRANSISTOR		
Q1			2SC4116(Y,GR)	TRANSISTOR		
Q2			2SA1576A(R,S)	TRANSISTOR		
Q2			2SA1586(Y,GR)	TRANSISTOR		
Q3 ,4			2SC4081(R,S)	TRANSISTOR	V	
Q3 ,4			2SC4081(R,S)	TRANSISTOR	Y1M1Y2	
Q3 ,4			2SC4116(Y,GR)	TRANSISTOR	V	
Q3 ,4			2SC4116(Y,GR)	TRANSISTOR	Y1M1Y2	
Q10 ,11			2SD1757K	TRANSISTOR		
Q12			2SA1576A(R,S)	TRANSISTOR		
Q12			2SA1586(Y,GR)	TRANSISTOR		
Q14			2SA1576A(R,S)	TRANSISTOR		
Q14			2SA1586(Y,GR)	TRANSISTOR		
A1			W02-2622-05	FM FRONT-END ASSY		
SURROUND (X08-2840-10)						
C1 -4			CK73FB1E104K	CHIP C 0.10UF	K	
C5 ,6			CC73FSL1H102J	CHIP C 1000PF	J	
C7 -9			CK73FB1E104K	CHIP C 0.10UF	K	
C10			CC73FSL1H331J	CHIP C 330PF	J	
C11 ,12			CC73FCH1H150J	CHIP C 15PF	J	
C13 ,14			CC73FCH1H180J	CHIP C 18PF	J	
C15			CK73FB1H103K	CHIP C 0.010UF	K	
C16			CK73FB1E104K	CHIP C 0.10UF	K	
C17			CK73FB1H103K	CHIP C 0.010UF	K	
C18			CC73FSL1H102J	CHIP C 1000PF	J	
C19			CK73FB1E104K	CHIP C 0.10UF	K	
C20			CE04LW1H4R7M	ELECTRO 4.7UF	50WV	
C21			CC73FCH1H330J	CHIP C 33PF	J	
C22 ,23			CC73FCH1H120J	CHIP C 12PF	J	
C24 ,25			CC73FCH1H150J	CHIP C 15PF	J	
C26			CE04LW1E470M	ELECTRO 47UF	25WV	
C27			CK73FB1E104K	CHIP C 0.10UF	K	
C28			CC73FSL1H470J	CHIP C 47PF	J	
C29			CC73FCH1H220J	CHIP C 22PF	J	
C30 -32			CK73FB1E104K	CHIP C 0.10UF	K	
C33 ,34			CC73FCH1H220J	CHIP C 22PF	J	
C35			CC73FSL1H102J	CHIP C 1000PF	J	
C36			CK73FB1H822K	CHIP C 8200PF	K	
C37			CK73FB1H103K	CHIP C 0.010UF	K	
C38			CE04LW1H2R2M	ELECTRO 2.2UF	50WV	
C39			CK73FB1E104K	CHIP C 0.10UF	K	
C50 -52			CE04LW1C100M	ELECTRO 10UF	16WV	
C55			CC73FSL1H470J	CHIP C 47PF	J	
C56			CE04LW0J471M	ELECTRO 470UF	6.3WV	
C57			CE04LW1A470M	ELECTRO 47UF	10WV	
C58 ,59			CK73FB1H103K	CHIP C 0.010UF	K	
C60 ,61			CC73FSL1H221J	CHIP C 220PF	J	
C63			CC73FSL1H470J	CHIP C 47PF	J	
C70			CE04LW1C102M	ELECTRO 1000UF	16WV	

L : Scandinavia K : USA P : Canada R : Mexico C : China I : Malaysia
 Y : PX(Far East, Hawaii) T : Europe E : Europe G : Germany V : China (Shanghai)
 Y : AAFES(Europe) X : Australia Q : Russia H : Korea M : Other Areas

Δ indicates safety critical components.

* New Parts
 Parts without **Parts No.** are not supplied.
 Les articles non mentionnés dans le **Parts No.** ne sont pas fournis.
 Teile ohne **Parts No.** werden nicht geliefert.

7

Ref. No	Add-ress	New Parts	Parts No.	Description	Desti-nation	Re-marks
C72 ,73			CK73FF1C224Z	CHIP C 0.22UF Z		
C74			CE04LW1C101M	ELECTRO 100UF 16WV		
C77 ,78			CK73FB1E104K	CHIP C 0.10UF K		
C81			CE04LW1C101M	ELECTRO 100UF 16WV		
C83			CE04LW1A101M	ELECTRO 100UF 10WV		
C86 ,87			CK73FB1E104K	CHIP C 0.10UF K		
C91			CE04LW1C101M	ELECTRO 100UF 16WV		
C92			CE04LW1A101M	ELECTRO 100UF 10WV		
C93 -95			CK73FB1E104K	CHIP C 0.10UF K		
C96			CE04LW1C101M	ELECTRO 100UF 16WV		
C97			CE04LW1A101M	ELECTRO 100UF 10WV		
C101,102			CC73FCH1H220J	CHIP C 22PF J		
C103-106			CC73FSL1H101J	CHIP C 100PF J		
C107,108			CC73FSL1H681J	CHIP C 680PF J		
C109			CK73FB1H103K	CHIP C 0.010UF K		
C110			CC73FSL1H101J	CHIP C 100PF J		
C111, 112			CE04LW1H100M	ELECTRO 10UF 50WV		
C113-120			CC73FSL1H101J	CHIP C 100PF J		
C121,122			CE04LW1H4R7M	ELECTRO 4.7UF 50WV		
C123,124			CC73FSL1H102J	CHIP C 1000PF J		
C125,126			CK73FB1H682K	CHIP C 6800PF K		
C127,128			CK73FB1H182K	CHIP C 1800PF K		
C129			CK73FB1H103K	CHIP C 0.010UF K		
C130			CC73FSL1H101J	CHIP C 100PF J		
C131,132			CE04LW1H4R7M	ELECTRO 4.7UF 50WV		
C133,134			CC73FSL1H102J	CHIP C 1000PF J		
C135-138			CC73FSL1H101J	CHIP C 100PF J		
C139,140			CK73FB1H182K	CHIP C 1800PF K		
C141,142			CC73FSL1H101J	CHIP C 100PF J		
C143,144			CK73FB1H682K	CHIP C 6800PF K		
C145			CK73FB1H103K	CHIP C 0.010UF K		
C146-150			CC73FSL1H101J	CHIP C 100PF J		
C151,152			CE04LW1H4R7M	ELECTRO 4.7UF 50WV		
C153,154			CC73FSL1H102J	CHIP C 1000PF J		
C155-158			CC73FSL1H101J	CHIP C 100PF J		
C159,160			CK73FB1H182K	CHIP C 1800PF K		
C161,162			CC73FSL1H101J	CHIP C 100PF J		
C163,164			CK73FB1H682K	CHIP C 6800PF K		
C165			CK73FB1H103K	CHIP C 0.010UF K		
C166			CC73FSL1H101J	CHIP C 100PF J		
C167			CE04LW1H220M	ELECTRO 22UF 50WV		
C168-170			CK73FB1H103K	CHIP C 0.010UF K		
C171-174			CQ92FM1H823J	MYLAR 0.082UF J		
C175-178			CC73FSL1H101J	CHIP C 100PF J		
C179			CK73FB1H103K	CHIP C 0.010UF K		
C180			CC73FSL1H101J	CHIP C 100PF J		
C181,182			CE04LW1E470M	ELECTRO 47UF 25WV		
C183,184			CE04LW1H220M	ELECTRO 22UF 50WV		
C185,186			CC73FSL1H101J	CHIP C 100PF J		
C187			CK73FB1H103K	CHIP C 0.010UF K		
C188			CC73FSL1H101J	CHIP C 100PF J		
C191-194			CQ92FM1H823J	MYLAR 0.082UF J		
C195-198			CC73FSL1H101J	CHIP C 100PF J		
C199			CK73FB1H103K	CHIP C 0.010UF K		
C200			CC73FSL1H101J	CHIP C 100PF J		

L : Scandinavia K : USA P : Canada R : Mexico C : China I : Malaysia
 Y : PX(Far East, Hawaii) T : Europe E : Europe G : Germany V : China (Shanghai)
 Y : AAFES(Europe) X : Australia Q : Russia H : Korea M : Other Areas

Δ indicates safety critical components.

* New Parts
 Parts without **Parts No.** are not supplied.
 Les articles non mentionnés dans le **Parts No.** ne sont pas fournis.
 Teile ohne **Parts No.** werden nicht geliefert.

8

Ref. No	Add-ress	New Parts	Parts No.	Description	Desti-nation	Re-marks
C201,202			CQ92FM1H823J	MYLAR 0.082UF J		
C203-206			CC73FSL1H101J	CHIP C 100PF J		
C207			CQ92FM1H104J	MYLAR 0.10UF J		
C208			CC73FSL1H101J	CHIP C 100PF J		
C209			CQ92FM1H154J	MYLAR 0.15UF J		
C210			CC73FSL1H101J	CHIP C 100PF J		
C211			CQ92FM1H393J	MYLAR 0.039UF J		
C212			CC73FSL1H101J	CHIP C 100PF J		
C213			CE04LW1H2R2M	ELECTRO 2.2UF 50WV		
C214			CK73FB1H103K	CHIP C 0.010UF K		
C216,217			CC73FSL1H101J	CHIP C 100PF J		
C218			CE04LW1H2R2M	ELECTRO 2.2UF 50WV		
C219,220			CK73FB1H103K	CHIP C 0.010UF K		
C223,224			CC73FSL1H102J	CHIP C 1000PF J		
C225			CE04LW1H220M	ELECTRO 22UF 50WV		
C226-230			CE04LW1H4R7M	ELECTRO 4.7UF 50WV		
C231			CE04LW1H470M	ELECTRO 47UF 50WV		
CN1			E40-8253-05	FLAT CABLE CONNECTOR		
CN2			E40-3256-05	PIN ASSY		
CN3			E40-4248-05	PIN ASSY		
J1			E63-1022-05	PHONO JACK		
J2			E63-1021-05	PHONO JACK		
J3			E63-1020-05	PHONO JACK		
J4			E11-0347-05	MINIATURE PHONE JACK(2P)		
E1			J11-0808-05	WIRE CLAMPER		
L1			L92-0044-05	FERRITE CORE		
L2			L79-1216-05	LINE FILTER		
L3			L92-0044-05	FERRITE CORE		
L4 ,5			L79-1216-05	LINE FILTER		
X1			L77-2220-05	CRYSTAL RESONATOR(10MHZ)		
X2			L77-2221-05	CRYSTAL RESONATOR(12.288MHZ)		
R1			RK73FB2A105J	CHIP R 1.0M J 1/10W		
R2			RK73FB2A821J	CHIP R 820 J 1/10W		
R3			RK73FB2A201J	CHIP R 200 J 1/10W		
R4			RK73FB2A183J	CHIP R 18K J 1/10W		
R5 -15			RK73FB2A221J	CHIP R 220 J 1/10W		
R16			RK73FB2A104J	CHIP R 100K J 1/10W		
R17 ,18			RK73FB2A102J	CHIP R 1.0K J 1/10W		
R19			RK73FB2A221J	CHIP R 220 J 1/10W		
R20			RK73FB2A104J	CHIP R 100K J 1/10W		
R21			RK73FB2A221J	CHIP R 220 J 1/10W		
R22			RK73FB2A102J	CHIP R 1.0K J 1/10W		
R23 ,24			RK73FB2A221J	CHIP R 220 J 1/10W		
R25 -27			RK73FB2A222J	CHIP R 2.2K J 1/10W		
R28			RK73FB2A105J	CHIP R 1.0M J 1/10W		
R29			RK73FB2A750J	CHIP R 75 J 1/10W		
R30			RK73FB2A472J	CHIP R 4.7K J 1/10W		
R31			RK73FB2A473J	CHIP R 47K J 1/10W		
R32			RK73FB2A472J	CHIP R 4.7K J 1/10W		
R33 -36			RK73FB2A102J	CHIP R 1.0K J 1/10W		
R37			RK73FB2A473J	CHIP R 47K J 1/10W		
R50			RK73FB2A750J	CHIP R 75 J 1/10W		

L : Scandinavia K : USA P : Canada R : Mexico C : China I : Malaysia
 Y : PX(Far East, Hawaii) T : Europe E : Europe G : Germany V : China (Shanghai)
 Y : AAFES(Europe) X : Australia Q : Russia H : Korea M : Other Areas

Δ indicates safety critical components.

PARTS LIST

KRF-V7510DNV8010DNVR-208/209

* New Parts
 Parts without **Parts No.** are not supplied.
 Les articles non mentionnés dans le **Parts No.** ne sont pas fournis.
 Teile ohne **Parts No.** werden nicht geliefert.

9

Ref. No	Add-ress	New Parts	Parts No.	Description	Desti-nation	Re-marks
R51			RK73FB2A332J	CHIP R 3.3K	J	1/10W
R52_53			RK73FB2A750J	CHIP R 75	J	1/10W
R54			RK73FB2A332J	CHIP R 3.3K	J	1/10W
R55_56			RK73FB2A750J	CHIP R 75	J	1/10W
Δ R57_58			RS14KB3A391J	FL-PROOF RS 390	J	1W
R59			RD14NB2E1R0J	RD 1	J	1/4W
Δ R61 -63			RD14NB2E2R2J	RD 2.2	J	1/4W
Δ R64			RD14NB2E1R0J	RD 1	J	1/4W
R66			RD14NB2E2R2J	RD 2.2	J	1/4W
R67			RD14NB2E1R0J	RD 1	J	1/4W
R68			RD14NB2E2R2J	RD 2.2	J	1/4W
R69			RK73FB2A203J	CHIP R 20K	J	1/10W
R70			RK73FB2A101J	CHIP R 100	J	1/10W
R71			RK73FB2A473J	CHIP R 47K	J	1/10W
R72			RK73FB2A472J	CHIP R 4.7K	J	1/10W
R101-104			RK73FB2A203J	CHIP R 20K	J	1/10W
R105,106			RK73FB2A101J	CHIP R 100	J	1/10W
R107,108			RK73FB2A102J	CHIP R 1.0K	J	1/10W
R111,112			RK73FB2A104J	CHIP R 100K	J	1/10W
R113,114			RK73FB2A512J	CHIP R 5.1K	J	1/10W
R115,116			RK73FB2A101J	CHIP R 100	J	1/10W
R117-120			RK73FB2A162J	CHIP R 1.6K	J	1/10W
R121,122			RK73FB2A101J	CHIP R 100	J	1/10W
R131,132			RK73FB2A104J	CHIP R 100K	J	1/10W
R133,134			RK73FB2A512J	CHIP R 5.1K	J	1/10W
R135,136			RK73FB2A432J	CHIP R 4.3K	J	1/10W
R137,138			RK73FB2A392J	CHIP R 3.9K	J	1/10W
R139-142			RK73FB2A162J	CHIP R 1.6K	J	1/10W
R143,144			RK73FB2A101J	CHIP R 100	J	1/10W
R151,152			RK73FB2A104J	CHIP R 100K	J	1/10W
R153,154			RK73FB2A512J	CHIP R 5.1K	J	1/10W
R155,156			RK73FB2A432J	CHIP R 4.3K	J	1/10W
R157,158			RK73FB2A392J	CHIP R 3.9K	J	1/10W
R159-162			RK73FB2A162J	CHIP R 1.6K	J	1/10W
R163,164			RK73FB2A101J	CHIP R 100	J	1/10W
R173,174			RK73FB2A153J	CHIP R 15K	J	1/10W
R175,176			RK73FB2A303J	CHIP R 30K	J	1/10W
R177,178			RK73FB2A101J	CHIP R 100	J	1/10W
R181,182			RK73FB2A104J	CHIP R 100K	J	1/10W
R183,184			RK73FB2A101J	CHIP R 100	J	1/10W
R185-188			RK73FB2A392J	CHIP R 3.9K	J	1/10W
R189-192			RK73FB2A222J	CHIP R 2.2K	J	1/10W
R193,194			RK73FB2A101J	CHIP R 100	J	1/10W
R195,196			RK73FB2A224J	CHIP R 220K	J	1/10W
R201,202			RK73FB2A153J	CHIP R 15K	J	1/10W
R203,204			RK73FB2A303J	CHIP R 30K	J	1/10W
R205			RK73FB2A153J	CHIP R 15K	J	1/10W
R206			RK73FB2A303J	CHIP R 30K	J	1/10W
R207			RK73FB2A123J	CHIP R 12K	J	1/10W
R208-210			RK73FB2A163J	CHIP R 16K	J	1/10W
R211-214			RK73FB2A101J	CHIP R 100	J	1/10W
R215,216			RK73FB2A224J	CHIP R 220K	J	1/10W
R217-220			RK73FB2A101J	CHIP R 100	J	1/10W
R221,222			RK73FB2A203J	CHIP R 20K	J	1/10W
R223-225			RK73FB2A393J	CHIP R 39K	J	1/10W

L : Scandinavia K : USA P : Canada R : Mexico C : China I : Malaysia
 Y : PX(Far East, Hawaii) T : Europe E : Europe G : Germany V : China (Shanghai)
 Y : AAFES(Europe) X : Australia Q : Russia H : Korea M : Other Areas

Δ indicates safety critical components.

* New Parts
 Parts without **Parts No.** are not supplied.
 Les articles non mentionnés dans le **Parts No.** ne sont pas fournis.
 Teile ohne **Parts No.** werden nicht geliefert.

10

Ref. No	Add-ress	New Parts	Parts No.	Description	Desti-nation	Re-marks
R226			RK73FB2A123J	CHIP R 12K	J	1/10W
S1			S62-0034-05	SLIDE SWITCH		
D1_2			DA204U	DIODE		
D1_2			1SS302	DIODE		
Δ D3_4			UDZ5.1B	ZENER DIODE		
D5			D2SBA20F03	DIODE		
Δ D7_9			UDZ6.2B	ZENER DIODE		
IC1			YSS248	MOS-IC		
IC2			CS4226-KQ	MOS-IC		
IC2			CS4226KQC	MOS-IC		
IC3			TC74HCU04AF	IC(HEX INVERTER SMD)		
IC4			NJM2279M	ANALOGUE IC		
IC5			TC9162AF	MOS-IC		
IC6			TC9164AF	MOS-IC		
Δ IC8 -10			TA7805SB	ANALOGUE IC		
IC11			NJM4565M	IC(OP AMP X2)		
IC12			NJM4580ED	ANALOGUE IC		
IC13			NJM4565M	IC(OP AMP X2)		
IC14			NJM4580ED	ANALOGUE IC		
IC15			NJM4565M	IC(OP AMP X2)		
IC16			NJM4580ED	ANALOGUE IC		
IC17-19			NJM4565M	IC(OP AMP X2)		
IC20			NJM4580ED	ANALOGUE IC		
IC21			NJM4565M	IC(OP AMP X2)		
IC22,23			NJM4580ED	ANALOGUE IC		
IC24			TC7W241FU	MOS-IC		
Q1			2SC4081(R,S)	TRANSISTOR		
Q1			2SC4116(Y,GR)	TRANSISTOR		
Q2			2SA1576A(R,S)	TRANSISTOR		
Q2			2SA1586(Y,GR)	TRANSISTOR		
A1			W02-1181-05	OPTIC RECEIVING MODULE		
AUDIO (X09-4890-10)						
D501,502			B30-2513-05	LED(RED)		
D527			B30-2513-05	LED(RED)		
C1_2			CK45FF1H103Z	CERAMIC 0.010UF	Z	KP1K1
C1_2			CK45FF1H103Z	CERAMIC 0.010UF	Z	P2V
C3			C91-1480-05	MP 0.22UF	250WV	Y1M1Y2
C5_6			C90-3760-05	ELECTRO 4700UF	75WV	KP1Y1
C5_6			C90-3760-05	ELECTRO 4700UF	75WV	M1
C5_6			C90-3761-05	ALMINIUM ELECTROLYTIC C.		K1P2Y2
C5_6			C90-3762-05	ALMINIUM ELECTROLYTIC C.		V
C7_8			C90-3763-05	ALMINIUM ELECTROLYTIC C.		V
C7_8			C90-3776-05	ALMINIUM ELECTROLYTIC C.		KP1Y1
C7_8			C90-3776-05	ALMINIUM ELECTROLYTIC C.		M1
C9			CE04LW1V222M	ELECTRO 2200UF	35WV	
C10			CE04LW1V471M	ELECTRO 470UF	35WV	
C11 -14			CK73FF1C224Z	CHIP C 0.22UF	Z	
C15_16			CE04LW1E101M	ELECTRO 100UF	25WV	
C18			CE04LW1J220M	ELECTRO 22UF	63WV	
C19			CE04LW1V470M	ELECTRO 47UF	35WV	
C21_22			CE04LW1H470M	ELECTRO 47UF	50WV	KP1Y1
C21_22			CE04LW1H470M	ELECTRO 47UF	50WV	M1V

L : Scandinavia K : USA P : Canada R : Mexico C : China I : Malaysia
 Y : PX(Far East, Hawaii) T : Europe E : Europe G : Germany V : China (Shanghai)
 Y : AAFES(Europe) X : Australia Q : Russia H : Korea M : Other Areas

Δ indicates safety critical components.

* New Parts
 Parts without **Parts No.** are not supplied.
 Les articles non mentionnés dans le **Parts No.** ne sont pas fournis.
 Teile ohne **Parts No.** werden nicht geliefert.

11

Ref. No	Add-ress	New Parts	Parts No.	Description	Desti-nation	Re-marks
C23 -26			CE04LW1H470M	ELECTRO 47UF 50WV	K1P2Y2	
C23 -26			CE04LW2A100M	ELECTRO 10UF 100WV	KP1Y1	
C23 -26			CE04LW2A100M	ELECTRO 10UF 100WV	M1V	
C27 ,28			CC73FSL1H151J	CHIP C 150PF J		
C29 ,30			CE04LW1H470M	ELECTRO 47UF 50WV	KP1Y1	
C29 ,30			CE04LW1H470M	ELECTRO 47UF 50WV	M1V	
C31 ,32			CE04LW1H470M	ELECTRO 47UF 50WV	K1P2Y2	
C31 ,32			CE04LW2A100M	ELECTRO 10UF 100WV	KP1Y1	
C31 ,32			CE04LW2A100M	ELECTRO 10UF 100WV	M1V	
C33 ,34			CK45FB1H392K	CERAMIC 3900PF K	K1P2Y2	
C33 ,34			CK45FB2H392K	CERAMIC 3900PF K	KP1Y1	
C33 ,34			CK45FB2H392K	CERAMIC 3900PF K	M1V	
C35			CE04LW0J221M	ELECTRO 220UF 6.3WV		
C36			CE04LW1V4R7M	ELECTRO 4.7UF 35WV		
C37			CE04LW1H010M	ELECTRO 1.0UF 50WV		
C38			CE04HW1E100M	NP-ELEC 10UF 25WV		
C39 ,40			CK45FB1H392K	CERAMIC 3900PF K	K1P2Y2	
C39 ,40			CK45FB2H392K	CERAMIC 3900PF K	KP1Y1	
C39 ,40			CK45FB2H392K	CERAMIC 3900PF K	M1V	
C41			CE04LW1A101M	ELECTRO 100UF 10WV		
C42			CE04LW1C330M	ELECTRO 33UF 16WV		
C101,102			CC73FSL1H390J	CHIP C 39PF J		
C103,104			CE04LW1H100M	ELECTRO 10UF 50WV		
C105,106			CC73FSL1H820J	CHIP C 82PF J		
C107,108			CE04LW1A470M	ELECTRO 47UF 10WV		
C109,110			CC45FSL1H101J	CERAMIC 100PF J		
C111,112			CQ93FMG1H123J	MYLAR 0.012UF J		
C113,114			CK45FB1H332K	CERAMIC 3300PF K		
C115,116			CE04LW1V4R7M	ELECTRO 4.7UF 35WV		
C117			CC45FSL1H101J	CERAMIC 100PF J		
C118			CK45FF1H103Z	CERAMIC 0.010UF Z		
C119,120			CC73FSL1H221J	CHIP C 220PF J		
C123,124			CC73FSL1H221J	CHIP C 220PF J		
C127,128			CC73FSL1H221J	CHIP C 220PF J		
C131,132			CC73FSL1H221J	CHIP C 220PF J		
C135,136			CC73FSL1H221J	CHIP C 220PF J		
C139,140			CC73FSL1H221J	CHIP C 220PF J		
C143,144			CC73FSL1H221J	CHIP C 220PF J		
C147,148			CC73FSL1H221J	CHIP C 220PF J		
C151,152			CC73FSL1H221J	CHIP C 220PF J		
C155,156			CE04LW1H2R2M	ELECTRO 2.2UF 50WV		
C157-162			CC73FSL1H101J	CHIP C 100PF J		
C163,164			CE04LW1C220M	ELECTRO 22UF 16WV		
C165			CC45FSL1H101J	CERAMIC 100PF J		
C166-168			CK45FF1H103Z	CERAMIC 0.010UF Z		
C169,170			CC73FSL1H221J	CHIP C 220PF J		
C171,172			CK45FF1H103Z	CERAMIC 0.010UF Z		
C200			CE04LW1H010M	ELECTRO 1.0UF 50WV		
C201			CE04LW1HR33M	ELECTRO 0.33UF 50WV		
C202			CQ93FMG1H153J	MYLAR 0.015UF J		
C203,204			CE04LW1V4R7M	ELECTRO 4.7UF 35WV		
C205,206			CK73FB1H222K	CHIP C 2200PF K		
C207-210			CC73FSL1H101J	CHIP C 100PF J		
C211			CQ93FMG1H822J	MYLAR 8200PF J		
C212			CC73FSL1H221J	CHIP C 220PF J		

L : Scandinavia K : USA P : Canada R : Mexico C : China I : Malaysia
 Y : PX(Far East, Hawaii) T : Europe E : Europe G : Germany V : China (Shanghai)
 Y : AAFES(Europe) X : Australia Q : Russia H : Korea M : Other Areas

Δ indicates safety critical components.

* New Parts
 Parts without **Parts No.** are not supplied.
 Les articles non mentionnés dans le **Parts No.** ne sont pas fournis.
 Teile ohne **Parts No.** werden nicht geliefert.

12

Ref. No	Add-ress	New Parts	Parts No.	Description	Desti-nation	Re-marks
C219			CQ93FMG1H822J	MYLAR 8200PF J		
C220			CQ93FMG1H153J	MYLAR 0.015UF J		
C221			CE04LW1HR33M	ELECTRO 0.33UF 50WV		
C223,224			CE04LW1C100M	ELECTRO 10UF 16WV		
C226-228			CE04LW1V4R7M	ELECTRO 4.7UF 35WV		
C229,230			CC73FSL1H471J	CHIP C 470PF J		
C233,234			CC73FSL1H101J	CHIP C 100PF J		
C237			CC45FSL1H101J	CERAMIC 100PF J		
C238			CK45FF1H103Z	CERAMIC 0.010UF Z		
C239,240			CE04LW1V4R7M	ELECTRO 4.7UF 35WV		
C241,242			CC73FSL1H471J	CHIP C 470PF J		
C245,246			CC73FSL1H101J	CHIP C 100PF J		
C251,252			CE04LW1V4R7M	ELECTRO 4.7UF 35WV		
C253,254			CC73FSL1H471J	CHIP C 470PF J		
C257,258			CC73FSL1H101J	CHIP C 100PF J		
C263,264			CC73FSL1H821J	CHIP C 820PF J		
C265,266			CE04LW1H2R2M	ELECTRO 2.2UF 50WV		
C267,268			CE04LW1A101M	ELECTRO 100UF 10WV		
C271,272			CE04LW1H2R2M	ELECTRO 2.2UF 50WV		
C273,274			CE04LW1A101M	ELECTRO 100UF 10WV		
C277			CE04LW1H2R2M	ELECTRO 2.2UF 50WV		
C279			CE04LW1A101M	ELECTRO 100UF 10WV		
C281,282			CC45FCH1H100D	CERAMIC 10PF D		
C283-285			CC45FCH1H150J	CERAMIC 15PF J		
C287,288			CK73FB1H102K	CHIP C 1000PF K		
C289,290			CQ93FMG1H104J	MYLAR 0.10UF J		
C293,294			CK73FB1H102K	CHIP C 1000PF K		
C295,296			CQ93FMG1H104J	MYLAR 0.10UF J		
C299			CK73FB1H102K	CHIP C 1000PF K		
C301			CQ93FMG1H104J	MYLAR 0.10UF J		
C305-308			CC45FSL1H101J	CERAMIC 100PF J		
C309-311			CK45FF1H472Z	CERAMIC 4700PF Z		
C313-316			CK45FF1H472Z	CERAMIC 4700PF Z		
C319,320			CE04LW1H3R3M	ELECTRO 3.3UF 50WV		
C321-325			CE04LW1H010M	ELECTRO 1.0UF 50WV		
C326-328			CE04LW1H100M	ELECTRO 10UF 50WV		
C329-334			CE04LW1C470M	ELECTRO 47UF 16WV		
C501			CK45FF1H103Z	CERAMIC 0.010UF Z		
C502			CQ93FMG1H104J	MYLAR 0.10UF J		
C503			CK45FF1H103Z	CERAMIC 0.010UF Z		
C504			CK73FB1H103K	CHIP C 0.010UF K		
C505			CK45FF1H103Z	CERAMIC 0.010UF Z		
C506			CK45FB1H102K	CERAMIC 1000PF K		
C507			CK45FF1H103Z	CERAMIC 0.010UF Z		
C508,509			CE04LW1A101M	ELECTRO 100UF 10WV		
C511-513			CK45FF1H103Z	CERAMIC 0.010UF Z		
C514			CK73FB1H103K	CHIP C 0.010UF K		
C517			CE04LW1H010M	ELECTRO 1.0UF 50WV		
C518-521			CK45FF1H103Z	CERAMIC 0.010UF Z		
C525			CE04LW1H010M	ELECTRO 1.0UF 50WV		
C526			C90-3214-05	ELECTRO 100UF 6.3WV		
C529,530			CE04LW1V4R7M	ELECTRO 4.7UF 35WV		
C531			CK73FB1H103K	CHIP C 0.010UF K		
C532			CK73FB1H102K	CHIP C 1000PF K		
C534			C90-1827-05	ELECTRO 0.047F 5.5WV		V

L : Scandinavia K : USA P : Canada R : Mexico C : China I : Malaysia
 Y : PX(Far East, Hawaii) T : Europe E : Europe G : Germany V : China (Shanghai)
 Y : AAFES(Europe) X : Australia Q : Russia H : Korea M : Other Areas

Δ indicates safety critical components.

PARTS LIST

KRF-V7510DNV8010DNVR-208/209

* New Parts
 Parts without **Parts No.** are not supplied.
 Les articles non mentionnés dans le **Parts No.** ne sont pas fournis.
 Teile ohne **Parts No.** werden nicht geliefert.

13

Ref. No	Add-ress	New Parts	Parts No.	Description	Desti-nation	Re-marks
C534			C90-1827-05	ELECTRO 0.047F 5.5WV	Y1M1Y2	
C535			CE04LW0J471M	ELECTRO 470UF 6.3WV	KP1K1	
C535			CE04LW0J471M	ELECTRO 470UF 6.3WV	P2	
CN1			E40-4299-05	PIN ASSY		
CN8			E40-8251-05	FLAT CABLE CONNECTOR		
CN9			E40-9848-05	PIN ASSY		
CN11		*	E40-8254-05	FLAT CABLE CONNECTOR		
CN12			E40-8196-05	PIN ASSY		
CN13			E40-4248-05	PIN ASSY		
CN51			E40-8258-05	FLAT CABLE CONNECTOR		
CN52			E40-8253-05	FLAT CABLE CONNECTOR		
CN53			E40-8250-05	FLAT CABLE CONNECTOR		
J1			E63-0172-05	PHONO JACK		
J2 ,3			E63-0173-05	PHONO JACK		
J4			E63-1015-05	PHONO JACK		
J5			E70-0089-05	SCREW TERMINAL BOARD		
J6			E70-0068-05	LOCK TERMINAL BOARD		
J7			E63-0172-05	PHONO JACK		
L1 -5			L39-1373-05	PHASE COMPENSATION COIL		
X501			L78-0290-05	RESONATOR (8MHZ)		
R1 ,2			RK73FB2A273J	CHIP R 27K J 1/10W	K1P2Y2	
R1 ,2			RK73FB2A513J	CHIP R 51K J 1/10W	KP1Y1	
R1 ,2			RK73FB2A513J	CHIP R 51K J 1/10W	M1V	
R3 ,4			RK73FB2A273J	CHIP R 27K J 1/10W	KP1Y1	
R3 ,4			RK73FB2A273J	CHIP R 27K J 1/10W	M1V	
R5			RK73FB2A222J	CHIP R 2.2K J 1/10W		
R6			RK73FB2A333J	CHIP R 33K J 1/10W		
R9 ,10			RS14KB3D391J	FL-PROOF RS 390 J 2W		
R11 ,12			RK73FB2A472J	CHIP R 4.7K J 1/10W		
Δ R14			RD14NB2E1R0J	RD 1 J 1/4W		
R15			RK73FB2A513J	CHIP R 51K J 1/10W	V	
R16			RK73FB2A273J	CHIP R 27K J 1/10W	KP1Y1	
R16			RK73FB2A273J	CHIP R 27K J 1/10W	M1V	
R17			RK73FB2A273J	CHIP R 27K J 1/10W		
Δ R18			RD14NB2E4R7J	RD 4.7 J 1/4W		
R19			RK73FB2A472J	CHIP R 4.7K J 1/10W		
R21			RS14KB3A392J	FL-PROOF RS 3.9K J 1W	KP1Y1	
R21			RS14KB3A392J	FL-PROOF RS 3.9K J 1W	M1V	
R22			RS14KB3A392J	FL-PROOF RS 3.9K J 1W	KP1Y1	
R22			RS14KB3A392J	FL-PROOF RS 3.9K J 1W	M1V	
R23 ,24			RD14NB2E103J	RD 10K J 1/4W		
R25 ,26			RS14KB3A392J	FL-PROOF RS 3.9K J 1W	KP1Y1	
R25 ,26			RS14KB3A392J	FL-PROOF RS 3.9K J 1W	M1V	
R27 ,28			RK73FB2A182J	CHIP R 1.8K J 1/10W	V	
R27 ,28			RK73FB2A272J	CHIP R 2.7K J 1/10W	KP1Y1	
R27 ,28			RK73FB2A272J	CHIP R 2.7K J 1/10W	M1	
R27 ,28			RK73FB2A821J	CHIP R 820 J 1/10W	K1P2Y2	
R30			RK73FB2A223J	CHIP R 22K J 1/10W		
R32			RK73FB2A153J	CHIP R 15K J 1/10W		
R34			RK73FB2A473J	CHIP R 47K J 1/10W		
R35			RK73FB2A182J	CHIP R 1.8K J 1/10W	V	
R35			RK73FB2A272J	CHIP R 2.7K J 1/10W	KP1Y1	
R35			RK73FB2A272J	CHIP R 2.7K J 1/10W	M1	
R35			RK73FB2A821J	CHIP R 820 J 1/10W	K1P2Y2	

L : Scandinavia K : USA P : Canada R : Mexico C : China I : Malaysia
 Y : PX(Far East, Hawaii) T : Europe E : Europe G : Germany V : China (Shanghai)
 Y : AAFES(Europe) X : Australia Q : Russia H : Korea M : Other Areas

Δ indicates safety critical components.

PARTS LIST

* New Parts
 Parts without **Parts No.** are not supplied.
 Les articles non mentionnés dans le **Parts No.** ne sont pas fournis.
 Teile ohne **Parts No.** werden nicht geliefert.

14

Ref. No	Add-ress	New Parts	Parts No.	Description	Desti-nation	Re-marks
Δ R37			RS14KB3A681J	FL-PROOF RS 680 J 1W		
Δ R38 -41			RS14KB3D331J	FL-PROOF RS 330 J 2W		
Δ R42 -44			RS14KB3D391J	FL-PROOF RS 390 J 2W		
R45			RD14NB2E1R0J	RD 1 J 1/4W		
R46			RD14NB2E821J	RD 820 J 1/4W	KP1	
R50			RK73FB2A472J	CHIP R 4.7K J 1/10W		
R51			RK73FB2A473J	CHIP R 47K J 1/10W		
R101,102			RK73FB2A102J	CHIP R 1.0K J 1/10W		
R103,104			RK73FB2A273J	CHIP R 27K J 1/10W		
R105,106			RK73FB2A101J	CHIP R 100 J 1/10W		
R117,118			RK73FB2A102J	CHIP R 1.0K J 1/10W		
R119,120			RK73FB2A224J	CHIP R 220K J 1/10W		
R121,122			RK73FB2A102J	CHIP R 1.0K J 1/10W		
R123,124			RK73FB2A224J	CHIP R 220K J 1/10W		
R125,126			RK73FB2A102J	CHIP R 1.0K J 1/10W		
R127,128			RK73FB2A224J	CHIP R 220K J 1/10W		
R129,130			RK73FB2A102J	CHIP R 1.0K J 1/10W		
R131,132			RK73FB2A224J	CHIP R 220K J 1/10W		
R135,136			RK73FB2A102J	CHIP R 1.0K J 1/10W		
R137,138			RK73FB2A224J	CHIP R 220K J 1/10W		
R139,140			RK73FB2A102J	CHIP R 1.0K J 1/10W		
R141,142			RK73FB2A224J	CHIP R 220K J 1/10W		
R143,144			RK73FB2A102J	CHIP R 1.0K J 1/10W		
R145,146			RK73FB2A224J	CHIP R 220K J 1/10W		
R147,148			RK73FB2A102J	CHIP R 1.0K J 1/10W		
R149,150			RK73FB2A224J	CHIP R 220K J 1/10W		
R151,152			RK73FB2A102J	CHIP R 1.0K J 1/10W		
R153-156			RK73FB2A224J	CHIP R 220K J 1/10W		
R157,158			RK73FB2A4R7J	CHIP R 4.7 J 1/10W		
R165-168			RK73FB2A103J	CHIP R 10K J 1/10W		
R169-172			RK73FB2A223J	CHIP R 22K J 1/10W		
R173,174			RK73FB2A473J	CHIP R 47K J 1/10W		
R175,176			RK73FB2A622J	CHIP R 6.2K J 1/10W		
R177,178			RK73FB2A103J	CHIP R 10K J 1/10W		
R203,204			RK73FB2A102J	CHIP R 1.0K J 1/10W		
R205,206			RK73FB2A100J	CHIP R 10 J 1/10W		
Δ R219			RS14KB3A221J	FL-PROOF RS 220 J 1W		
Δ R220			RS14KB3A271J	FL-PROOF RS 270 J 1W		
R226			RK73FB2A103J	CHIP R 10K J 1/10W		
R227,228			RK73FB2A104J	CHIP R 100K J 1/10W		
R229,230			RK73FB2A133J	CHIP R 13K J 1/10W	K1P2Y2	
R229,230			RK73FB2A133J	CHIP R 13K J 1/10W	V	
R229,230			RK73FB2A912J	CHIP R 9.1K J 1/10W	KP1Y1	
R229,230			RK73FB2A912J	CHIP R 9.1K J 1/10W	M1	
R231,232			RK73FB2A183J	CHIP R 18K J 1/10W		
R237,238			RK73FB2A103J	CHIP R 10K J 1/10W		
R239,240			RK73FB2A104J	CHIP R 100K J 1/10W		
R241,242			RK73FB2A363J	CHIP R 36K J 1/10W	KP1Y1	
R241,242			RK73FB2A363J	CHIP R 36K J 1/10W	M1	
R241,242			RK73FB2A513J	CHIP R 51K J 1/10W	K1P2Y2	
R241,242			RK73FB2A513J	CHIP R 51K J 1/10W	V	
R243,244			RK73FB2A183J	CHIP R 18K J 1/10W		
R249,250			RK73FB2A103J	CHIP R 10K J 1/10W		
R251,252			RK73FB2A104J	CHIP R 100K J 1/10W		
R253			RK73FB2A363J	CHIP R 36K J 1/10W	KP1Y1	

L : Scandinavia K : USA P : Canada R : Mexico C : China I : Malaysia
 Y : PX(Far East, Hawaii) T : Europe E : Europe G : Germany V : China (Shanghai)
 Y : AAFES(Europe) X : Australia Q : Russia H : Korea M : Other Areas

Δ indicates safety critical components.

* New Parts
 Parts without **Parts No.** are not supplied.
 Les articles non mentionnés dans le **Parts No.** ne sont pas fournis.
 Teile ohne **Parts No.** werden nicht geliefert.

15

Ref. No	Add-ress	New Parts	Parts No.	Description	Desti-nation	Re-marks
R253			RK73FB2A363J	CHIP R 36K J 1/10W	M1	
R253			RK73FB2A513J	CHIP R 51K J 1/10W	K1P2Y2	
R253			RK73FB2A513J	CHIP R 51K J 1/10W	V	
R254			RK73FB2A432J	CHIP R 4.3K J 1/10W		
R255,256			RK73FB2A183J	CHIP R 18K J 1/10W		
R263,264			RK73FB2A102J	CHIP R 1.0K J 1/10W		
R267			RK73FB2A102J	CHIP R 1.0K J 1/10W		
R269,270			RK73FB2A102J	CHIP R 1.0K J 1/10W		
R271			RK73FB2A473J	CHIP R 47K J 1/10W		
R272			RK73FB2A361J	CHIP R 360 J 1/10W		
R275,276			RK73FB2A104J	CHIP R 100K J 1/10W		
R277,278			RK73FB2A563J	CHIP R 56K J 1/10W		
R284			RK73FB2A104J	CHIP R 100K J 1/10W		
R291			RK73FB2A104J	CHIP R 100K J 1/10W		
R305			RK73FB2A102J	CHIP R 1.0K J 1/10W		
R309			RK73FB2A102J	CHIP R 1.0K J 1/10W		
R310			RK73FB2A333J	CHIP R 33K J 1/10W		
R311,312			R92-1866-05	METAL 0.1HM 2W		
R313,314			RK73FB2A333J	CHIP R 33K J 1/10W	KP1Y1	
R315,316			RK73FB2A243J	CHIP R 24K J 1/10W		
R315,316			RK73FB2A243J	CHIP R 24K J 1/10W	M1V	
R315,316			RK73FB2A393J	CHIP R 39K J 1/10W	K1P2Y2	
R317,318			RK73FB2A471J	CHIP R 470 J 1/10W		
R319,320			RK73FB2A333J	CHIP R 33K J 1/10W		
R323,324			RD14NB2E4R7J	RD 4.7 J 1/4W		
R325,326			R92-1866-05	METAL 0.1HM 2W		
R327,328			RK73FB2A333J	CHIP R 33K J 1/10W		
R329,330			RK73FB2A243J	CHIP R 24K J 1/10W	KP1Y1	
R329,330			RK73FB2A243J	CHIP R 24K J 1/10W	M1V	
R329,330			RK73FB2A393J	CHIP R 39K J 1/10W	K1P2Y2	
R331,332			RK73FB2A471J	CHIP R 470 J 1/10W		
R333,334			RK73FB2A333J	CHIP R 33K J 1/10W		
R337,338			RD14NB2E4R7J	RD 4.7 J 1/4W		
R339			R92-1866-05	METAL 0.1HM 2W		
R341			RD14NB2E4R7J	RD 4.7 J 1/4W		
R351,352			RD14NB2E4R7J	RD 4.7 J 1/4W		
R353			RK73FB2A103J	CHIP R 10K J 1/10W		
R354			RK73FB2A223J	CHIP R 22K J 1/10W		
R355			RK73FB2A473J	CHIP R 47K J 1/10W		
R356,357			RK73FB2A104J	CHIP R 100K J 1/10W		
R361			RK73FB2A333J	CHIP R 33K J 1/10W		
R363			RK73FB2A243J	CHIP R 24K J 1/10W	KP1Y1	
R363			RK73FB2A243J	CHIP R 24K J 1/10W	M1V	
R363			RK73FB2A393J	CHIP R 39K J 1/10W	K1P2Y2	
R365			RK73FB2A471J	CHIP R 470 J 1/10W		
R367,368			RK73FB2A242J	CHIP R 2.4K J 1/10W	KP1Y1	
R367,368			RK73FB2A242J	CHIP R 2.4K J 1/10W	M1	
R367,368			RK73FB2A332J	CHIP R 3.3K J 1/10W	K1P2Y2	
R367,368			RK73FB2A332J	CHIP R 3.3K J 1/10W	V	
R369-371			RK73FB2A562J	CHIP R 5.6K J 1/10W	KP1Y1	
R369-371			RK73FB2A562J	CHIP R 5.6K J 1/10W	M1	
R369-371			RK73FB2A622J	CHIP R 6.2K J 1/10W	K1P2Y2	
R369-371			RK73FB2A622J	CHIP R 6.2K J 1/10W	V	
R372			RK73FB2A162J	CHIP R 1.6K J 1/10W		
R373-377			RK73FB2A102J	CHIP R 1.0K J 1/10W		

L : Scandinavia K : USA P : Canada R : Mexico C : China I : Malaysia
 Y : PX(Far East, Hawaii) T : Europe E : Europe G : Germany V : China (Shanghai)
 Y : AAFES(Europe) X : Australia Q : Russia H : Korea M : Other Areas

Δ indicates safety critical components.

* New Parts
 Parts without **Parts No.** are not supplied.
 Les articles non mentionnés dans le **Parts No.** ne sont pas fournis.
 Teile ohne **Parts No.** werden nicht geliefert.

15

Ref. No	Add-ress	New Parts	Parts No.	Description	Desti-nation	Re-marks
R521			RK73FB2A103J	CHIP R 10K J 1/10W		
R522			RD14NB2E1R0J	RD 1 J 1/4W		
R534			RK73FB2A101J	CHIP R 100 J 1/10W		
R536			RK73FB2A101J	CHIP R 100 J 1/10W		
R539			RK73FB2A101J	CHIP R 100 J 1/10W		
R542			RK73EB2B101J	CHIP R 100 J 1/8W		
R549			RK73FB2A102J	CHIP R 1.0K J 1/10W		
R555,556			RK73FB2A103J	CHIP R 10K J 1/10W		
R562			RK73FB2A102J	CHIP R 1.0K J 1/10W		
R578			RK73FB2A103J	CHIP R 10K J 1/10W		
R587			RK73FB2A103J	CHIP R 10K J 1/10W		
R592			RK73FB2A102J	CHIP R 1.0K J 1/10W		
R598			RK73FB2A361J	CHIP R 360 J 1/10W		
R599			RK73FB2A472J	CHIP R 4.7K J 1/10W		
R603			RK73FB2A472J	CHIP R 4.7K J 1/10W	K1P2Y2	
W501-503			R92-0670-05	CHIP R 0 OHM		
W504			R92-0679-05	CHIP R 0 OHM	KP1Y1	
W504			R92-0679-05	CHIP R 0 OHM	M1K1P2	
W504			R92-0679-05	CHIP R 0 OHM	Y2	
W505			R92-0670-05	CHIP R 0 OHM	KP1Y1	
W505			R92-0670-05	CHIP R 0 OHM	M1	
K1 -4			S76-0076-05	MAGNETIC RELAY		
S501-507			S70-0031-05	TACT SWITCH		
S509-512			S70-0031-05	TACT SWITCH		
S514-516			S70-0031-05	TACT SWITCH		
S520,521			S70-0031-05	TACT SWITCH		
S517			T99-0602-05	ROTARY ENCODER		
S518,519			T99-0605-05	ROTARY ENCODER		
Δ D1			D4SBL20UF03	DIODE	KP1Y1	
Δ D1			D4SBL20UF03	DIODE	M1V	
Δ D2			D4SBL20UF03	DIODE		
Δ D3 -6			S5688B	DIODE		
Δ D3 -6			1SR139-400	DIODE		
D8 ,9			MTZJ16(B)	ZENER DIODE		
D8 ,9			RD16ES(B2)	ZENER DIODE		
D11			MTZJ7.5(B)	ZENER DIODE	KP1Y1	
D11			MTZJ7.5(B)	ZENER DIODE	M1	
D11			RD7.5JS(B2)	ZENER DIODE	KP1Y1	
D11			RD7.5JS(B2)	ZENER DIODE	M1	
D12 -14			MTZJ8.2(B)	ZENER DIODE	KP1Y1	
D12 -14			MTZJ8.2(B)	ZENER DIODE	M1V	
D12 -14			RD8.2JS(B2)	ZENER DIODE	KP1Y1	
D12 -14			RD8.2JS(B2)	ZENER DIODE	M1V	
D15 ,16			MTZJ6.8(B)	ZENER DIODE		
D15 ,16			RD6.8ES(B)	ZENER DIODE		
D17			HSS104A	DIODE		
D17			1SS133	DIODE		
D18			MTZJ4.7(B)	ZENER DIODE		
D18			RD4.7ES(B2)	ZENER DIODE		
D19			MTZJ3.3(B)	ZENER DIODE		
D19			RD3.3ES(B2)	ZENER DIODE		
D20 -23			MA111	DIODE		
D24 ,25			MTZJ18(B)	ZENER DIODE		

L : Scandinavia K : USA P : Canada R : Mexico C : China I : Malaysia
 Y : PX(Far East, Hawaii) T : Europe E : Europe G : Germany V : China (Shanghai)
 Y : AAFES(Europe) X : Australia Q : Russia H : Korea M : Other Areas

Δ indicates safety critical components.

PARTS LIST

KRF-V7510DNV8010DNVR-208/209

* New Parts
Parts without **Parts No.** are not supplied.
Les articles non mentionnés dans le **Parts No.** ne sont pas fournis.
Teile ohne **Parts No.** werden nicht geliefert.

17

Ref. No	Add-ress	New Parts	Parts No.	Description	Desti-nation	Re-marks
D24 ,25 D26 ,27 D29 D29 D503			RD18ES(B2) MA111 MA111 MA111 HSS104A	ZENER DIODE DIODE DIODE DIODE DIODE	KP1Y1 M1V	
D503 D504 D504 D504 D504			1SS133 HSS104A HSS104A 1SS133 1SS133	DIODE DIODE DIODE DIODE DIODE	V Y1M1Y2 V Y1M1Y2	
D508,509 D508,509 D510 D510 D510			HSS104A 1SS133 HSS104A HSS104A 1SS133	DIODE DIODE DIODE DIODE DIODE	V Y1M1Y2 V	
D510 D511-522 D511-522 D525 D525			1SS133 HSS104A 1SS133 MTZJ6.2(B) RD6.2JS(B2)	DIODE DIODE DIODE ZENER DIODE ZENER DIODE	Y1M1Y2	
D526 D526 D529-531 D529-531 ED51			HSS104A 1SS133 HSS104A 1SS133 11-MT-116GK	DIODE DIODE DIODE DIODE INDICATOR TUBE		
Δ IC1 Δ IC2 Δ IC3 Δ IC3 Δ IC3			TA7815SB TA79015SB STK407-090K STK411-230D STK411-230D	ANALOGUE IC ANALOGUE IC HYBRID IC HYBRID IC HYBRID IC	K1P2Y2 KP1Y1 M1V	
Δ IC3 Δ IC3 Δ IC4 Δ IC4 Δ IC4		*	STK411-230K STK411-230K STK407-290K STK410-030D STK410-030D	HYBRID IC HYBRID IC HYBRID IC HYBRID IC HYBRID IC	KP1Y1 M1 K1P2Y2 KP1Y1 M1V	
Δ IC4 Δ IC4 Δ IC5 IC6 IC7		*	STK410-030K STK410-030K NJM4580ED TC9164AF TC9163AF	HYBRID IC HYBRID IC ANALOGUE IC MOS-IC MOS-IC	KP1Y1 M1V	
IC8 IC9 IC10-12 IC51 IC52			NJM4565MD M62446FP NJM4565MD CXP82832-141Q X24C02S	IC(OP AMP X2) ANALOGUE IC IC(OP AMP X2) MI-COM IC MEMORY IC	Y1M1Y2	
Δ IC53 Δ Q1 Δ Q2 Δ Q2			S-80740AL-A4 2SC1845(F,E) 2SA1534A(R,S) 2SB1640 2SB1640	IC(VOLTAGE DETECTOR) TRANSISTOR TRANSISTOR TRANSISTOR TRANSISTOR	K1P2Y2 KP1Y1 M1V	
Δ Q3 -14 Q15 ,16 Q17 -21 Q23 Q24 ,25			2SC2878(B) 2SA1576A(R,S) 2SC1845(F,E) 2SA992(F,E) 2SC1845(F,E)	TRANSISTOR TRANSISTOR TRANSISTOR TRANSISTOR TRANSISTOR		

L : Scandinavia K : USA P : Canada R : Mexico C : China I : Malaysia
Y : PX(Far East, Hawaii) T : Europe E : Europe G : Germany V : China (Shanghai)
Y : AAFES(Europe) X : Australia Q : Russia H : Korea M : Other Areas

Δ indicates safety critical components.

* New Parts
Parts without **Parts No.** are not supplied.
Les articles non mentionnés dans le **Parts No.** ne sont pas fournis.
Teile ohne **Parts No.** werden nicht geliefert.

18

Ref. No	Add-ress	New Parts	Parts No.	Description	Desti-nation	Re-marks
Δ Q26 -29 Δ Q31 Q32 Q34 ,35 Q36			DTC123JUA 2SC2631(S,T) 2SA1123(S,T) 2SC1845(F,E) 2SA1535(Q,R)	DIGITAL TRANSISTOR TRANSISTOR TRANSISTOR TRANSISTOR TRANSISTOR		
Q37 Q38 Q39 Q501 Q501			2SC1845(F,E) 2SC3722K(R,S) DTC113ZUA 2SC4116(Y,GR) 2SC4177(L5,L6)	TRANSISTOR TRANSISTOR DIGITAL TRANSISTOR TRANSISTOR TRANSISTOR		
Q503 Q503 Q504 Q504 Q504 Q505			2SC4116(Y,GR) 2SC4177(L5,L6) 2SC4116(Y,GR) 2SC4177(L5,L6) 2SC4116(Y,GR)	TRANSISTOR TRANSISTOR TRANSISTOR TRANSISTOR TRANSISTOR	K1P2Y2	
Q505			2SC4177(L5,L6)	TRANSISTOR	K1P2Y2	
A501			W02-2625-05	OPTIC RECEIVING MODULE		

L : Scandinavia K : USA P : Canada R : Mexico C : China I : Malaysia
Y : PX(Far East, Hawaii) T : Europe E : Europe G : Germany V : China (Shanghai)
Y : AAFES(Europe) X : Australia Q : Russia H : Korea M : Other Areas

Δ indicates safety critical components.

HOW TO READ THE PARTS LIST

ABBREVIATION OF MODEL AND MASS PRODUCTION'S DESTINATIONS

MODEL	ABB.	Australia	Canada	China	England	Europe	Germany	Korea	Malaysia
VR-208	-	-	P2	-	-	-	-	-	-
VR-209	-	-	P1	-	-	-	-	-	-
KRF-V7510D	-	-	-	-	-	-	-	-	-
KRF-V8010D	-	-	-	-	-	-	-	-	-
MODEL	ABB.	Mexico	PX/AAFES	Russia	Scandinavia	Shanghai	U.S.A.	Other area	
VR-208	-	-	-	-	-	-	K1	-	-
VR-209	-	-	-	-	-	-	K	-	-
KRF-V7510D	-	-	Y2	-	-	-	-	-	-
KRF-V8010D	-	Y1	-	-	-	V	-	M1	-

SPECIFICATIONS

Except U.S.A. and Canada

AUDIO section

Effective power output during STEREO operation	
KRF-V8010D	
1kHz, 10% T.H.D., at 8 Ω	140 W + 140 W
KRF-V7510D	
1kHz, 10% T.H.D., at 8 Ω	70 W + 70 W
Rated power output during STEREO operation	
KRF-V8010D	
DIN (63 Hz ~ 12.5 kHz, 0.7%, 8 Ω)	110 W + 110 W

100 watts per channel minimum RMS, both channels driven, at 8 Ω from 40 Hz to 20 kHz with no more than 0.7% total harmonic distortion.(FTC)

KRF-V7510D	
DIN (63 Hz ~ 12.5 kHz, 0.7%, 8 Ω)	50 W + 50 W

50 watts per channel minimum RMS, both channels driven, at 8 Ω from 40 Hz to 20 kHz with no more than 0.7% total harmonic distortion.(FTC)

Effective power output during SURROUND operation	
KRF-V8010D	
FRONT (1kHz, 10% T.H.D. at 8 Ω)	100 W + 100 W
CENTER (1kHz, 10% T.H.D. at 8 Ω)	100 W
SURROUND (1kHz, 10% T.H.D. at 8 Ω)	100 W + 100 W
KRF-V7510D	
FRONT (1kHz, 10% T.H.D. at 8 Ω)	50 W + 50 W
CENTER (1kHz, 10% T.H.D. at 8 Ω)	50 W
SURROUND (1kHz, 10% T.H.D. at 8 Ω)	50 W + 50 W

Total harmonic distortion	
KRF-V8010D	0.02%(1 kHz, 50W, 8 Ω)
KRF-V7510D	0.02%(1 kHz, 25W, 8 Ω)
Signal to noise ratio (IHF'66)	
PHONO (MM)	75 dB
CD	91 dB
Input sensitivity / impedance	
PHONO (MM)	2.5 mV / 27 kΩ
CD	200 mV / 47 kΩ
Output level / impedance	
TAPE REC	200 mV / 1 kΩ
PRE OUT (CENTER, SURROUND)	1 V / 1 kΩ
PRE OUT (SUBWOOFER)	1 V / 600 Ω
Tone control	
BASS	±10 dB (at 100 Hz)
TREBLE	±10 dB (at 10 kHz)

DIGITAL AUDIO section

Sampling frequency	32 kHz, 44.1 kHz, 48 kHz
Input level / impedance / wave length	
Optical	-15 dBm ~ -21 dBm, 600 nm ±30nm
Coaxial	0.5 Vp-p / 75 Ω

VIDEO section

VIDEO inputs / outputs	
VIDEO (composite)	1 Vp-p / 75 Ω

FM tuner section

Tuning frequency range	87.5 MHz ~ 108 MHz
Usable sensitivity (MONO)	1.6 μV (75 Ω) / 15.2 dBf (75 kHz DEV., SINAD 30 dB)
50dB quieting sensitivity	
STEREO	31.6 μV (75 Ω) / 41.2 dBf
Total harmonic distortion (1 kHz)	
MONO	0.6% (65 dBf input)
STEREO	0.7% (65 dBf input)
Signal to noise ratio (1 kHz, 75 kHz DEV.)	
MONO	75 dB (65 dBf input)
STEREO	68 dB (65 dBf input)
Stereo separation (1 kHz)	38 dB
Selectivity (±400 kHz)	50 dB
Frequency response	30 Hz ~ 15kHz, +0.5 dB, -3.0 dB

AM tuner section

Tuning frequency range	
9 kHz step	531 kHz ~ 1,602 kHz
10 kHz step	530 kHz ~ 1,610 kHz
Usable sensitivity (30% mod., S/N 20 dB)	16 μV / (600 μV/m)
Signal to noise ratio (30% mod. 1 mV input)	50 dB

GENERAL

Power consumption	
KRF-V8010D	280 W
KRF-V7510D	210 W
AC outlet	
SWITCHED	2 (total 150 W max.)
Dimensions	
W	440 mm
H	144 mm
D	400 mm
Weight (Net)	
KRF-V8010D	9.5 kg
KRF-V7510D	7.7 kg



SPECIFICATIONS

For U.S.A. and Canada

AUDIO section

Rated power output during STEREO operation

VR-209

100 watts per channel minimum RMS, both channels driven, at 8 Ω from 40 Hz to 20 kHz with no more than 0.7% total harmonic distortion.(FTC)

VR-208

50 watts per channel minimum RMS, both channels driven, at 8 Ω from 40 Hz to 20 kHz with no more than 0.7% total harmonic distortion.(FTC)

Effective power output during SURROUND operation

VR-209

FRONT (1kHz, 0.7% T.H.D. at 8 Ω)..... 100 W + 100 W
 CENTER (1kHz, 0.7% T.H.D. at 8 Ω) 100 W
 SURROUND (1kHz, 0.7% T.H.D. at 8 Ω) 100 W + 100 W

VR-208

FRONT (1kHz, 0.7% T.H.D. at 8 Ω)..... 50 W + 50 W
 CENTER (1kHz, 0.7% T.H.D. at 8 Ω) 50 W
 SURROUND (1kHz, 0.7% T.H.D. at 8 Ω) 50 W + 50 W

Total harmonic distortion

VR-209 0.02%(1 kHz, 50W, 8 Ω)
 VR-208 0.02%(1 kHz, 25W, 8 Ω)

Signal to noise ratio (IHF'66)

PHONO (MM)..... 75 dB
 CD 91 dB

Input sensitivity / impedance

PHONO (MM)..... 2.5 mV / 27 kΩ
 CD 200 mV / 47 kΩ

Output level / impedance

TAPE REC 200 mV / 1 kΩ
 PRE OUT (CENTER, SURROUND)..... 1 V / 1 kΩ
 PRE OUT (SUBWOOFER) 1 V / 600 Ω

Tone control

BASS ±10 dB (at 100 Hz)
 TREBLE ±10 dB (at 10 kHz)

DIGITAL AUDIO section

Sampling frequency 32 kHz, 44.1 kHz, 48 kHz

Input level / impedance / wave length

Optical -15 dBm ~ -21 dBm, 600 nm ±30nm
 Coaxial 0.5 Vp-p / 75 Ω

Note:

Component and circuit are subject to modification to insure best operation under differing local conditions. This manual is based on Europe (E) standard, and provides information on regional circuit modification through use of alternate schematic diagrams, and information on regional component variations through use of parts list.

KENWOOD CORPORATION

14-6,Dogenzaka 1-chome, Shibuya-ku, Tokyo, 150-8501 Japan

KENWOOD SERVICE CORPORATION

P.O BOX 22745, 2201 East Dominguez St., Long Beach, CA 90801-5745, U.S.A.

KENWOOD ELECTRONICS CANADA INC.

6070 Kestrel Road, Mississauga, Ontario, Canada L5T 1S8

KENWOOD ELECTRONICS LATIN AMERICA S.A.

P.O.BOX 55-2791, Piso 6 plaza Chase, Cl. 47 y Aquilino de la Guardia Panama, Republic de Panama

KENWOOD ELECTRONICS BRASIL LTDA.

Av Indianópolis, 628, 04062-001 Planalto Paulista São Paulo-SP-Brasil

KENWOOD ELECTRONICS U.K. LIMITED

KENWOOD House, Dwight Road, Watford, Herts., WD1 8EB., United Kingdom

KENWOOD ELECTRONICS BELGUM N.V.

Meachelsesteenweg 418, B-1930 Zaventem, Belgium

KENWOOD ELECTRONICS DEUTSCHLAND GMBH

Rembrücker Str. 15, 63150 Heusenstamm, Germany

KENWOOD ELECTRONICS FRANCE S.A.

13 Boulevard Ney, 75018 Paris, France

VIDEO section

VIDEO inputs / outputs

VIDEO (composite) 1 Vp-p / 75 Ω

FM tuner section

Tuning frequency range 87.5 MHz ~ 108 MHz

Usable sensitivity (MONO)

..... 1.6 μV (75 Ω) / 15.2 dBf (75 kHz DEV., SINAD 30 dB)

50dB quieting sensitivity

STEREO 31.6 μV (75 Ω) / 41.2 dBf

Total harmonic distortion (1 kHz)

MONO 0.6% (65 dBf input)

STEREO 0.7% (65 dBf input)

Signal to noise ratio (1 kHz, 75 kHz DEV.)

MONO 75 dB (65 dBf input)

STEREO 68 dB (65 dBf input)

Stereo separation (1 kHz) 38 dB

Selectivity (±400 kHz) 70 dB

Frequency response 30 Hz ~ 15kHz, +0.5 dB, -3.0 dB

AM tuner section

Tuning frequency range

10 kHz step 530 kHz ~ 1,700 kHz

Usable sensitivity (30% mod., S/N 20 dB)

..... 16 μV / (600 μV/m)

Signal to noise ratio (30% mod. 1 mV input) 50 dB

GENERAL

Power consumption 2.2 A

AC outlet

SWITCHED 2 (total 150 W, 1.25 A max.)

Dimensions W : 440 mm (17-5/16")

H : 144 mm (5-11/16")

D : 400 mm (15-3/4")

Weight (Net)

VR-209 8.7 kg (19.2 lb)

VR-208 7.7 kg (17.0 lb)



1. KENWOOD follows a policy of continuous advancements in development. For this reason specifications may be changed without notice.
2. The full performance may not be exhibited in an extremely cold location (under a water-freezing temperature).

KENWOOD ELECTRONICS ITALIA S.p.A.

Via G. Sirtori, 7/9 20129, Milano, Italy

KENWOOD IBÉRICA S.A.

Bolivia, 239-08020 Barcelona, Spain

KENWOOD ELECTRONICS AUSTRALIA PTY. LTD.

(A.C.N. 001499 074)

P.O Box 504, 8 Figtree Drive, Australia Centre, Homebush, N.S.W. 2140, Australia

KENWOOD & LEE ELECTRONICS, LTD.

Unit 3712-3724, Level 37, Tower 1, Metroplaza, 223 Hing Fong Road, Kwai Fong N.T., Hong Kong

KENWOOD ELECTRONICS GULF FZE

P.O.Box 61318, Jebel Ali, Dubai, U.A.E.

KENWOOD ELECTRONICS SINGAPORE PTE LTD.

No. 1 Genting Lane #02-02, KENWOOD Building, Singapore, 349544

KENWOOD ELECTRONICS (MALAYSIA) SDN BHD.

#4.01 Level 4, Wisma Academy Lot 4A, Jalan 19/1 46300 Petaling Jaya Selangor Darul Ehsan Malaysia

KENWOOD ELECTRONICS (THAILAND) CO., LTD.

573/111 Soi Ramkhamhaeng 39, Ramkhamhaeng Road, Wangthonglang, Bangkok, Bangkok 10301 Thailand