

AUDIO-VIDEO SURROUND RECEIVER

KRF-V4060D/V4060DE/V4060DE-S/V4060D-S

KRF-V5060D/V5060DE/V5060D-S/V5560D/V5560D-S

VR-605/615

SERVICE MANUAL

KENWOOD

© 2002-2 PRINTED IN KOREA
B51-5783-00 (K/K) 3526

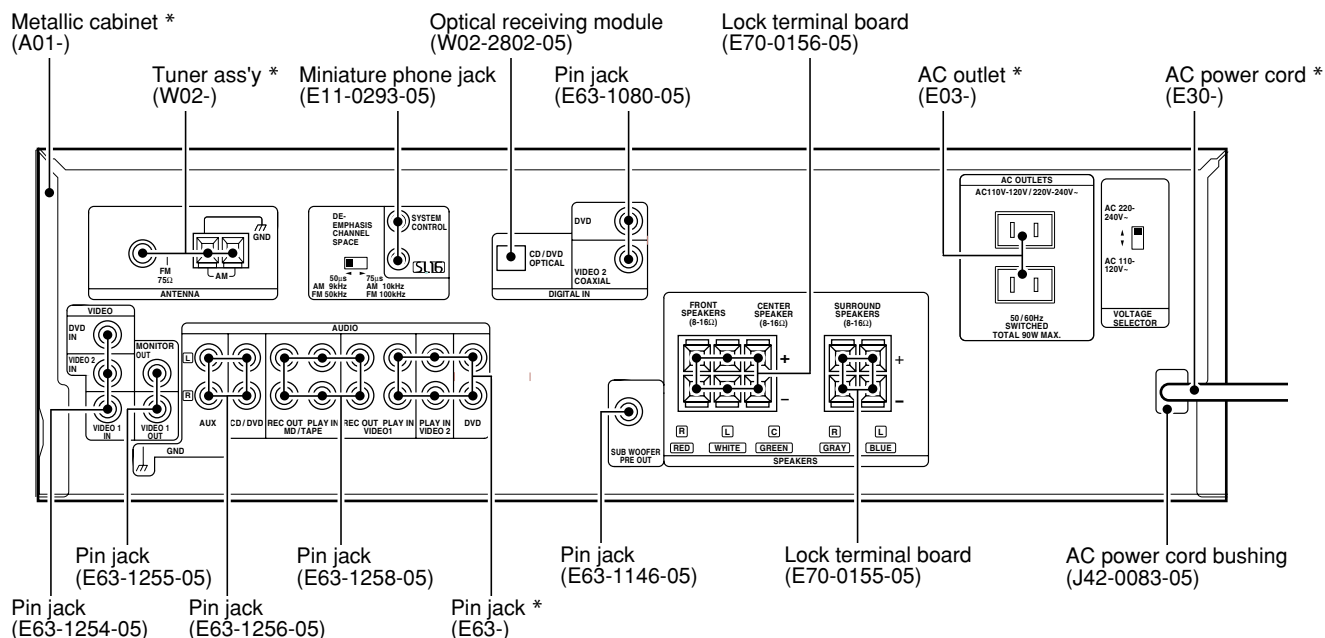
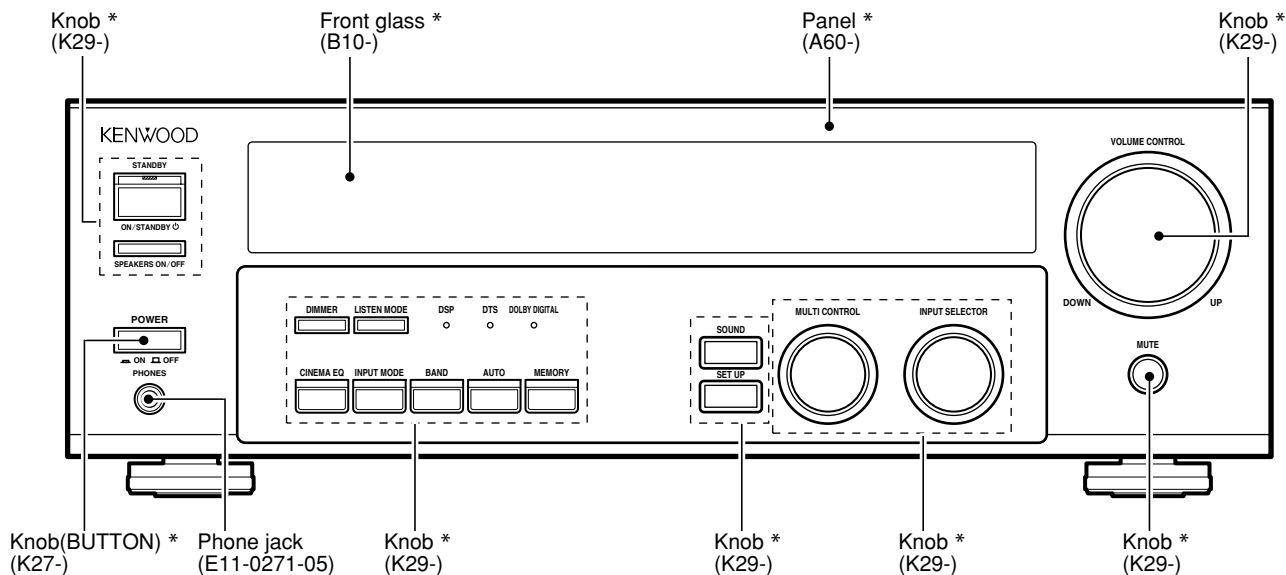

Illust. is KRF-V4060D.

* Refer to parts list on page 21.





KRF-V4060D/V5060D/V5560D/VR-605/615

CONTENTS / ACCESSORIES / CAUTIONS

Contents

CONTENTS / ACCESSORIES / CAUTIONS.....	2	EXPLODED VIEW	27
CIRCUIT DESCRIPTION	3	PARTS LIST	28
PC BOARD	10	SPECIFICATIONS	41
SCHEMATIC DIAGRAM	14		

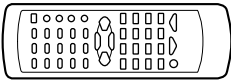
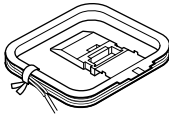
Accessories

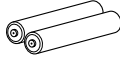
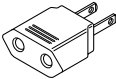
<p>Remote control unit (1) Refer to the table on this page below.</p> 	<p>AM loop antenna (1) (T90-0852-05)</p> 	<p>FM indoor antenna (1) (T90-0877-05)</p> 	<p>Batteries (R6/AA) (2)</p> 
<div style="border: 1px solid black; padding: 10px; width: fit-content; margin: 0 auto;"> <p>AC Plug Adaptor (1) (E03-0115-05)</p>  <p>Use to adapt the plug on the power cord to the shape of the wall outlet. (Accessory only for regions where use is necessary.)</p> </div>			

REMOTE CONTROL vs MODEL

MODEL	PARTS #	REMOTE CONTROL #	DESTINATION
KRF-V4060D	A70-1566-05	RC-R0623	ET
KRF-V4060DE			E1
KRF-V4060DE-S			E2
KRF-V4060D-S	A70-1564-05	RC-R0621	MX
KRF-V4060D-S	A70-1566-05	RC-R0623	E3T1
KRF-V5060D	A70-1563-05	RC-R0620	Y
KRF-V5060D	A70-1565-05	RC-R0622	ET
KRF-V5060DE			E1

MODEL	PARTS #	REMOTE CONTROL #	DESTINATION
KRF-V5060D-S	A70-1563-05	RC-R0620	MX
KRF-V5060D-S	A70-1565-05	RC-R0622	E3T1
KRF-V5560D	A70-1564-05	RC-R0621	Y
KRF-V5560D	A70-1566-05	RC-R0623	E
KRF-V5560D-S	A70-1564-05	RC-R0621	MXH
KRF-V5560D-S	A70-1566-05	RC-R0623	E3T1
VR-605	A70-1564-05	RC-R0621	KP
VR-615	A70-1563-05	RC-R0620	KP

Cautions

Resetting the Microcomputer

The microcomputer may malfunction (unit cannot be operated, or shows an erroneous display) if the power cord is unplugged while the power is ON, or due to some other external factor. If this happens, execute the following procedure to reset the microcomputer and return the unit to its normal operating condition.

- Please note that resetting the microcomputer will clear the contents of the memory and return the unit to the state it was in when it left the factory

For the U.S.A. and Canada

Unplug the power cord from the wall outlet, then plug it back in while holding down the POWER key.

For other countries

With the power cord plugged in, turn the POWER key OFF. Then, while holding down the ON/STANDBY I/⏻ key, press POWER.

Memory back up function

Please note that the following items will be deleted from the unit's memory if the power cord is disconnected from the AC outlet for approximately 3 days.

- | | |
|--|--|
| <ul style="list-style-type: none"> • Power mode. • Input selector settings. • Picture output. • Speaker ON/OFF. • Volume level. • BASS, TREBLE, INPUT level. • Dimmer level. • MD/TAPE settings. • Listen mode setting. • Speaker settings. • SW RE-MIX ON/OFF. | <ul style="list-style-type: none"> • Distance setting. • Input mode setting. • Midnight mode setting. • PRO LOGIC II mode setting. • Broadcast band. • Frequency setting. • Preset stations. • Tuning mode. • CINEMA EQ ON/OFF. • LOUDNESS ON/OFF. |
|--|--|

CIRCUIT DESCRIPTION

1. Model & TUNER Destination

1-1 Model Discrimination

	DVD/6ch PHONO	DVD/6ch AUX	DVD AUX	F=80Hz	F=120Hz
Model TYPE 0(30Pin)	L	L	H	-	-
Model TYPE 1(35Pin)	L	H	L	-	-
CRS OVR CHK(80Pin)	-	-	-	L	H

1-2 TUNER Destination

Set TYPE	TYPE	BAND	Receiving Frequency Range	Channel Space	IF	PLL
K/P	K1	FM	87.50MHz~108.0MHz	100kHz	+10.7MHz	25kHz
		AM	530kHz~1700kHz	10kHz	+450kHz	10kHz
Y/M/I	K2	FM	87.50MHz~108.0MHz	100kHz	+10.7MHz	25kHz
		AM	530kHz~1610kHz	10kHz	+450kHz	10kHz
Y/M/V/X H	E1	FM	87.50MHz~108.0MHz	50kHz	+10.7MHz	25kHz
		AM	531kHz~1602kHz	9kHz	+450kHz	9kHz
E/T	E3 RDS	FM	87.50MHz~108.0MHz	50kHz	+10.7MHz	25kHz
		AM	531kHz~1602kHz	9kHz	+450kHz	9kHz
Y/M	M	K2/E1 are decided by Tuner destination port 1 input. (0 = K2 Type 1 = E1 Type)				

2. Tuner Preset Memory

P.ch	K1	K2	E1/E3	P.ch	K1	K2	E1/E3
1	FM 98.3M	FM 98.3M	FM 98.3M	21	AM 530K	AM 530K	AM 531K
2	FM 108.0M	FM 108.0M	FM 108.0M	22	FM 87.5M	FM 87.5M	FM 87.5M
3	FM 89.1M	FM 89.1M	FM 89.1M	23	FM 87.5M	FM 87.5M	FM 87.5M
4	FM 87.5M	FM 87.5M	FM 87.5M	24	FM 87.5M	FM 87.5M	FM 87.5M
5	FM 90.0M	FM 90.0M	FM 90.0M	25	FM 87.5M	FM 87.5M	FM 87.5M
6	FM 87.5M	FM 87.5M	FM 87.5M	26	FM 87.5M	FM 87.5M	FM 87.5M
7	FM 87.5M	FM 87.5M	FM 87.5M	27	FM 87.5M	FM 87.5M	FM 87.5M
8	AM 1610K	FM 87.5M	AM 1503K	28	FM 87.5M	FM 87.5M	FM 87.5M
9	AM 1700K	AM 1610K	AM 1584K	29	FM 87.5M	FM 87.5M	FM 87.5M
10	AM 1000K	AM 1000K	AM 954K	30	FM 106.0M	FM 106.0M	FM 106.0M
11	AM 630K	AM 630K	AM 621K	31	FM 87.5M	FM 87.5M	FM 87.5M
12	AM 1440K	AM 1440K	AM 1350K	32	FM 87.5M	FM 87.5M	FM 87.5M
13	FM 106.0M	FM 106.0M	FM 106.0M	33	FM 87.5M	FM 87.5M	FM 87.5M
14	AM 530K	AM 530K	AM 531K	34	FM 87.5M	FM 87.5M	FM 87.5M
15	FM 87.5M	FM 87.5M	FM 87.5M	35	FM 87.5M	FM 87.5M	FM 87.5M
16	FM 98.0M	FM 98.0M	FM 98.0M	36	FM 87.5M	FM 87.5M	FM 87.5M
17	FM 98.5M	FM 98.5M	FM 98.5M	37	FM 87.5M	FM 87.5M	FM 87.5M
18	FM 87.5M	FM 87.5M	FM 87.5M	38	FM 87.5M	FM 87.5M	FM 87.5M
19	AM 990K	AM 990K	AM 945K	39	FM 108.0M	FM 108.0M	FM 108.0M
20	FM 97.4M	FM 97.4M	FM 97.4M	40	AM 1000K	AM 1000K	AM 945K

3. Test Mode

3-1 Entering the Test Mode

- With the power cord plugged in, turn the POWER key OFF. Then while holding down the BAND key, press power key.

3-2 Cancelling the Test Mode

- Initialized and cancel the test mode if pulling out the power code.

3-3 Contents of the Test Mode

3-3-1 Pch Call UP/DOWN

Key	Function
DIMMER	Pch CALL UP →01→02→03……→39→40→
LISTEN MODE	Pch CALL DOWN ←01←02←03……←39←40←

3-3-2 TUNER mute on/off

Key	Function
MUTE	TUNER mute on/off

CIRCUIT DESCRIPTION

4. Microcomputer : MN101C51FGA (X14,IC804)

4-1 Microcomputer Periphery Block Diagram

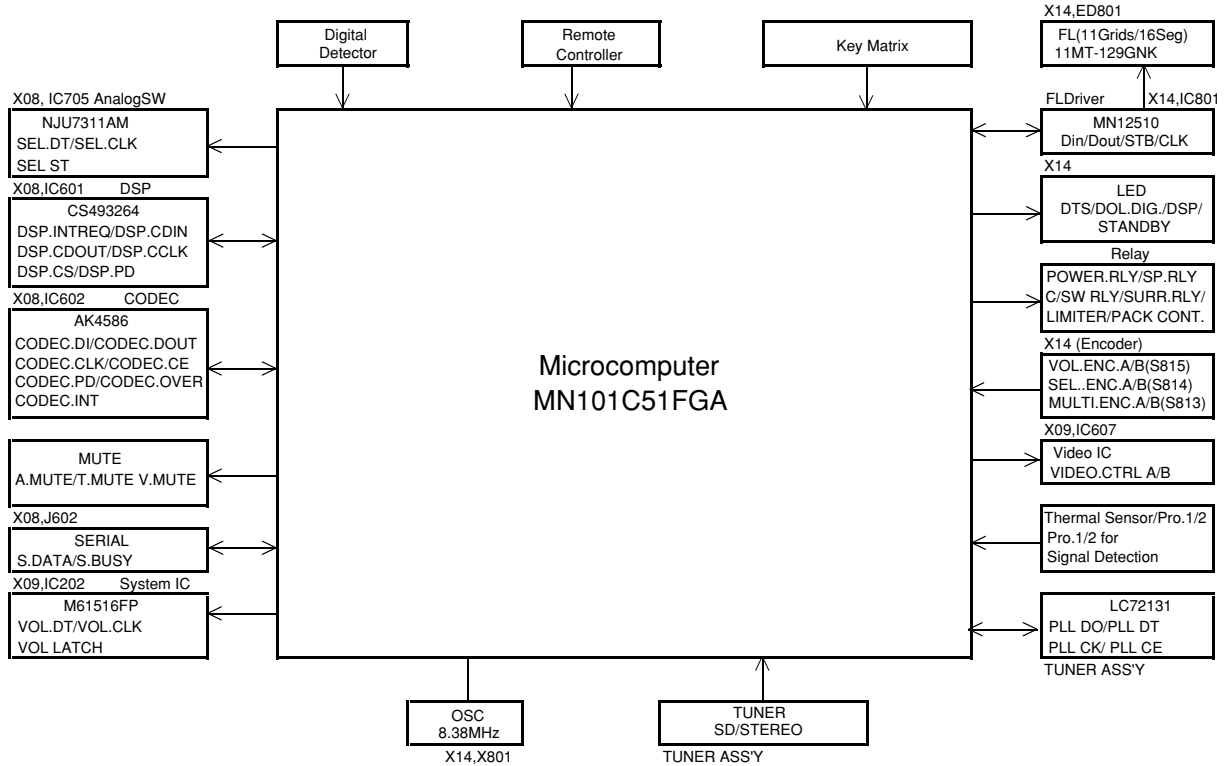

Key Matrix

	P34(30Pin)	P33(29Pin)	P32(28Pin)	P31(27Pin)
SEG1(32Pin)	AUTO	MEMORY	SOUND	-
SEG2(33Pin)	SET UP	MUTE	DIMMER	SPK ON/OFF
SEG3(34Pin)	CINEMA EQ	LISTEN	INPUT	-

4-2 Pin Description of Microcomputer : MN101C51FGA(X14,IC804)

Pin No.	Pin Name	I/O	Description
1	VREF-	-	Connected to ground.
2	TH SENS	I	Protection signal detection port for thermal sensor.
3	S DETECTOR1	I	Protection for signal detection 1.
4	S DETECTOR2	I	Protection for signal detection 2.
5	S LEVEL	I	Detection port for RDS signal level.
6	AD KEY GET	I	A/D key input.
7	AD TUNER DEST	I	Discrimination port for tuner destination.
8	PROT1	I	Protection signal detection port for over current.
9	PROT2	I	Protection signal detection port for over voltage.
10	VREF+	-	A/D reference voltage.
11	VDD	-	Power supply(+5V) for microcomputer.
12	OSC2	O	Main clock output(8.38MHz).
13	OSC1	I	Main clock input(8.38MHz).
14	VSS	-	Connected to ground.
15	XI	-	Connected to ground.
16	XO	-	Unused.
17	MMOD	-	Connected to ground.
18	DSP/CODEC DIN	O	Data output to DSP/CODEC.
19	DSP/CODEC DO	I	Data input port from DSP/CODEC.
20	DSP/CODEC CLK	O	Clock output to DSP/CODEC.
21	DSP CS	-	Chip select for DSP.
22	DSP PD	O	Power down mode port for DSP.
23	CODEC PD	O	Power down mode port for CDDEC.

CIRCUIT DESCRIPTION

Pin No.	Pin Name	I/O	Description
24	CODEC OVER	I	Overflow detection port for CODEC analog signal.
25	RESET	I	Reset signal input for microcomputer.
26	CODEC CSN	O	Chip select for CODEC.
27	RDS DATA	O	RDS signal data output.
28	S BUSY	I/O	Serial busy signal input/output.
29	S DATA	I/O	Serial data signal input/output.
30	MODEL TYPE0	I	Discrimination port for model type.
31	REMOCON	I	Signal input for remote controller.
32	CODEC INT	I	Detection port for digital signal error.
33	RDS CLK	I	Clock input for RDS demodulator IC.
34	DSP INTREQ	I	Detection port for DSP INTREQ.
35	MODEL TYPE1	I	Discrimination port for model type.
36	FL DIN	O	Data output to FL driver.
37	FL DOUT	I	Data input from FL driver.
38	FL CLK	O	Clock output to FL driver.
39	FL STB	O	Strobe output to FL driver.
40	PLL DATA	O	Data output to PLL IC.
41	PLL CLK	O	Clock output to PLL IC.
42,43	NC	-	Unused.
44	PLL CE	O	Chip enable output to PLL IC.
45	PLL DO	I	Data input from PLL IC.
46	T MUTE	O	Mute signal output to PLL IC.
47	STEREO	I	Stereo signal input from PLL IC.
48	PLL SD	I	SD signal input from PLL IC.
49	MULTI ENCA	I	Encoder (X14, S813) signal input.
50	MULTI ENCB	I	Encoder (X14, S813) signal input.
51	SEL ENCA	I	Encoder (X14,S814) signal input.
52	SEL ENCB	I	Encoder (X14,S814) signal input.
53	VOL. ENCA	I	Encoder (X14,S815) signal input.
54	VOL. ENCB	I	Encoder (X14,S815) signal input.
55	CH SPACE	I	Discrimination port for channel space.
56	SP RLY	O	Control port for speaker relay.
57	C/SW RELAY	O	Relay control for center and sub woofer speakers.
58	SURR.RLY	O	Relay control for surround speaker.
59	PWR RLY	O	Control port for power relay.
60	PACK CONT.	O	Power pack control.
61	V. MUTE	O	Mute control for video output.
62	LIMITER	O	Power control for A class.
63	A. MUTE	O	Mute control for audio output.
64	SEL DATA	O	Data output to analog switch IC(X08,IC705).
65	SEL. CLK	O	Clock output to analog switch IC(X08,IC705).
66	SEL. STB	O	Strobe output to analog switch IC(X08,IC705).
67	VIDEO CTRLA	O	Video switch control.
68	VIDEO CTRLB	O	Video switch control.
69	-6 ATT	O	-6dB attenuater control.
70	VOL. DATA	O	Data output to system IC (X09,IC202).
71	VOL. CLK	O	Clock output to system IC (X09,IC202).
72	VOL. LATCH	O	Latch output to system IC (X09,IC202).
73	STANDBY LED	O	Control port for STANDBY LED(X14,D808).
74	DTS LED	O	Control port for DTS LED(X14,D807).
75	DOL DIG LED	O	Control port for DOLBY DIG LED(X14,D806).
76	DSP LED	O	Control port for DSP LED(X14,D805).
77	CE2	I	Detection port of chip enable 2 for microcomputer.
78	CE1	I	Detection port of chip enable 1 for microcomputer.
79	DEGITAL DET	I	Detection port for digital signal.
80	CRS OVR CHK	I	Selection of cut-off frequency for HPF/LPF. L : 80Hz H : 120Hz

CIRCUIT DESCRIPTION

5. Pin Description of ICs.

5-1 CODEC : AK4586(X08, IC602)

Pin No.	Pin Name	I/O	Description
1	XTO	-	Unused.
2	XTI/EXTCLK	I	External clock input (12.268MHz).
3	DVDD	-	Digital power supply (+5.0V).
4	DVSS	-	Digital GND.
5	TVDD	-	Power supply for buffer (+3.3V).
6	TX	-	Unused.
7	MCKO	O	Master clock pin.
8	LRCK	I	Clock input pin.
9	BICK	I	Bit clock pin for audio serial data.
10	SDTO	O	Output pin for audio serial data.
11~13	SDTI (1~3)	I	Input pin of audio serial data for DAC.
14	INT0	O	Output pin for digital signal error.
15	INT1	-	Unused.
16	CAD1/CDTO	I	Control data input.
17	SDACDTI	I	Control data input.
18	SCL/CCLK	I	Clock input.
19	CAD0/CSN	I	Chip select.
20	DZF2/OVR	O	Overflow detection port for CODEC analog signal.
21	AVSS	-	Analog GND.
22	AVDD	-	Analog power supply (+5.0V).
23	VREFH	I	Reference voltage input.
24	VCOM	O	Output pin for common voltage.
25	DZF1	-	Zero input detection 1 pin (Unused).
26	C OUT	O	DAC Center channel output.
27	SW OUT	O	DAC SW channel output.
28	SL OUT	O	DAC SL channel output.
29	SR OUT	O	DAC SR channel output.
30	FL OUT	O	DAC FL channel output.
31	FR OUT	O	DAC FR channel output.
32	LIN	I	L channel analog (+) input.
33	RIN	I	R channel analog (+) input.
34	PVDD	-	Power supply (+5.0V).
35	R	-	Unused.
36	PVSS	-	GND
37	RX4	I	Unused.
38	SLAVE	-	GND
39	RX3	I	Optical input.
40	TST	-	Clock select 2 pin (GND).
41	RX2	I	VIDEO2 (COAX IN) input.
42	I2C	I	Control select pin (Unused) .
43	RX1	I	DVD (COAX IN) input.
44	PDN	I	CODEC power down.

CIRCUIT DESCRIPTION

5-2 FL Driver : MN12510 (X14, IC801)

Pin No.	Pin Name	I/O	Description
1	P21,P20	O	Segment 1,2 output.
3	P03	O	Unused.
4~6	P02~P00	O	Grid (1~3) output.
7~10	DGT(7~4)	O	Grid (4~7) output.
11	NC	-	Unused.
12~15	DGT(3~0)	O	Grid (8~10) output.
16	VPP	-	Power supply (-30V).
17	NC	-	Unused.
18	VDD	-	Power supply (+5V).
19	OSC1	-	Crystal (4MHz) connection port.
20	OSC2	-	Crystal (4MHz) connection port.
21	VSS	-	GND
22	NCS	I	Strobe input.
23	SCK	I	Clock input.
24	SDI	I	Data input.
25	SDO	O	Data output.
26	P30	-	Unused.
27~30	P(31~34)	I	Key return signal input.
31	SEG0	O	Segment (S16) output.
32	SEG1	O	Segment (S15)/key scan output.
33	SEG2	O	Segment (S14)/key scan output.
34	SEG3	O	Segment (S13)/key scan output.
35~38	SEG(4~7)	O	Segment (S12~S9) output.
39~42	P(10~13)	O	Segment (S8~S5) output.
43,44	P23,P24	O	Segment (S4,S3) output.

5-3 Power Amplifier

5-3-1 Front/Center Amp : STK443(X09,IC301) KRF-V4060D/V5060D/VR-605

Pin No.	Pin Name	Description
1	+VCC	Connection port for power supply (+B).
2	-VCC	Connection port for power supply (-B).
3	SUB GND	GND
4	+RE/CH1	FR ch (+) output.
5	-RE/CH1	FR ch (-) output.
6	-RE/CH2	FL ch (-) output.
7	+RE/CH2	FL ch (+) output.
8	-PRE	Connection port for pre power supply (-B).
9	+PRE	Connection port for pre power supply (+B).
10	IN/CH1	FR ch input.
11	NF/CH1	FR ch feedback.
12	BIAS	Bias connection port.
13	NF/CH2	FL ch feedback.
14	IN/CH2	FL ch input.
15	IN/CH3	Center ch input.
16	NF/CH3	Center ch feedback.
17	+RE/CH3	Center ch (+) output.
18	-RE/CH3	Center ch (-) output.

CIRCUIT DESCRIPTION

5-3-2 Surround Amp : STK442(X09,IC401) KRF-V4060D/V5060D/VR-605

Pin No.	Pin Name	Description
1	+VCC	Connection port for power supply (+B).
2	-VCC	Connection port for power supply (-B).
3	SUB GND	GND
4	+RE/CH1	Surround R ch (+) output.
5	-RE/CH1	Surround R ch (-) output.
6	-RE/CH2	Surround L ch (-) output.
7	+RE/CH2	Surround L ch (+) output.
8	-PRE	Connection port for pre power supply (-B).
9	+PRE	Connection port for pre power supply (+B).
10	IN/CH1	Surround Rch input.
11	NF/CH1	Surround R ch feedback.
12	BIAS	Bias connection port.
13	NF/CH2	Surround L ch feedback.
14	IN/CH2	Surround Lch input.

5-3-3 Front/Center Amp : STK413(X09,IC301) KRF-V5560D/VR-615

Pin No.	Pin Name	Description
1	+VH	Connection port for high power supply (+B).
2	+VL	Connection port for low power supply (+B).
3	+REF	Connection port for reference voltage (+B).
4	-REF	Connection port for reference voltage (-B).
5	-VL	Connection port for low power supply (-B).
6	-VH	Connection port for high power supply (-B).
7	SUB GND	GND
8	+RE/CH1	FR ch (+) output.
9	-RE/CH1	FR ch (-) output.
10	-RE/CH2	FL ch (-) output.
11	+RE/CH2	FL ch (+) output.
12	-PRE	Connection port for pre power supply (-B).
13	+PRE	Connection port for pre power supply (+B).
14	IN/CH1	FR ch input.
15	NF/CH1	FR ch feedback.
16	BIAS	Bias connection port.
17	NF/CH2	FL ch feedback.
18	IN/CH2	FL ch input.
19	IN/CH3	Center ch input.
20	NF/CH3	Center ch feedback.
21	+RE/CH3	Center ch (+) output.
22	-RE/CH3	Center ch (-) output.

5-3-4 Surround/S.W Amp : STK413(X09,IC401) KRF-V5560D/VR-615

Pin No.	Pin Name	Description
1	+VH	Connection port for high power supply (+B).
2	+VL	Connection port for low power supply (+B).
3	+REF	Connection port for reference voltage (+B).
4	-REF	Connection port for reference voltage (-B).
5	-VL	Connection port for low power supply (-B).
6	-VH	Connection port for high power supply (-B).
7	SUB GND	GND
8	+RE/CH1	Surround R ch (+) output.
9	-RE/CH1	Surround R ch (-) output.
10	-RE/CH2	Surround L ch (-) output.
11	+RE/CH2	Surround L ch (+) output.
12	-PRE	Connection port for pre power supply (-B).
13	+PRE	Connection port for pre power supply (+B).

CIRCUIT DESCRIPTION

Pin No.	Pin Name	Description
14	IN/CH1	Surround R ch input.
15	NF/CH1	Surround R ch feedback.
16	BIAS	Bias connection port.
17	NF/CH2	Surround L ch feedback.
18	IN/CH2	Surround L ch input.
19	IN/CH3	Surround ch input.
20	NF/CH3	Surround ch feedback.
21	+RE/CH3	Surround ch (+) output.
22	-RE/CH3	Surround ch (-) output.

5-4 Digital Audio Decoder: CS493264(X08,IC601)

Pin No.	Pin Name	I/O	Description
1,12,23	VD(1~3)	-	Digital power supply (+3.3V).
2,13,24	DGND(1~3)	-	Digital GND.
3	XMT958	0	SPDIF transmitter output (Open).
4	WR GP1010	I/O	Host write strobe.
5	RD EMOE	I/O	Read/write enable.
6	SCDIN	1	SPI serial control data.
7	SCCLK	I	Serial control clock.
8~11 14~17	EMA(D7~D0)	I/O	Data bit (7~0).
18	CS	I	Chip select.
19	SCDI0	I/O	Serial control data input/output.
20	INTREQ ABOUT	I/O	Control port interrupt request/automatic boot enable.
21	EXTMEM	I/O	External memory chip select.
22	SDATAN	I	PCM audio data input.
25	SCLKN	I/O	PCM audio input bit clock.
26	SLRCLKN	I/O	PCM audio input sample rate clock.
27	CMPDAT	I	PCM audio data input2.
28	CMPCLK	I/O	PCM audio input bit clock.
29	CMPREQ	I/O	PCM audio input sample rate clock.
30	CLKIN	I	Master clock input.
31	CLKSEL	I	DSP clock select.
32	FLT2	-	Phase lock loop filter.
33	FLT1	-	Phase lock loop filter.
34	VA	-	Analog power supply (+3.3V).
35	AGND	-	Analog GND.
36	RESET	I	Master reset port.
37	DD	I/O	Pull-up port.
38	DC	I	Pull-up port.
39~41	AUDAT(2~0)	O	Digital audio output (2~0).
42	LRCLK	I/O	Audio output sample rate clock.
43	SCLK	I/O	Audio output bit clock.
44	MCLK	I/O	Audio master clock.

PC BOARD (Component side view)

X14-7470-10/7480-10 A/2
(J70-1583-01)

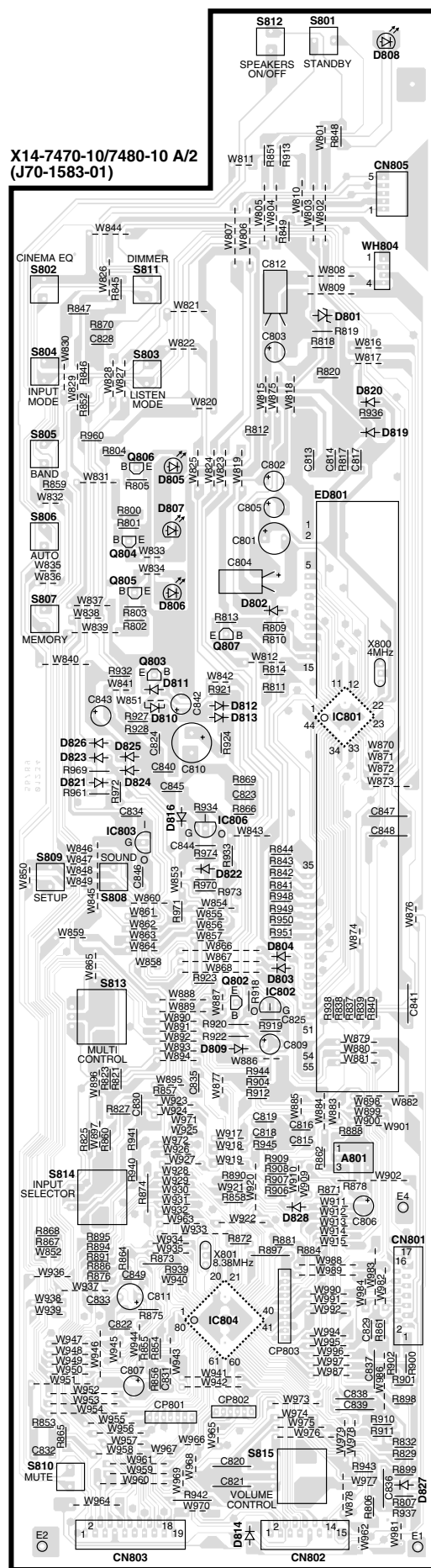

X14 B/2

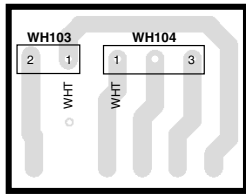

KRF-V4060D (X08-3160-10)			
DESTINATION	UNIT	DESTINATION	UNIT
COUNTRY	ABB. No.	COUNTRY	ABB. No.
EUROPE	E 0-10	EUROPE	E1 0-10
U.K.	T		

KRF-V4060DE (X08-3160-10)			
DESTINATION	UNIT	DESTINATION	UNIT
COUNTRY	ABB. No.	COUNTRY	ABB. No.
U.S.A.	K 0-10	U.S.A.	K 0-10
CANADA	P 0-10		

VR-605 (X08-3160-10)			
DESTINATION	UNIT	DESTINATION	UNIT
COUNTRY	ABB. No.	COUNTRY	ABB. No.
U.S.A.	K 0-10	U.S.A.	K 0-10
CANADA	P 0-10		

KRF-V5060D (X08-3160-XX)			
DESTINATION	UNIT	DESTINATION	UNIT
COUNTRY	ABB. No.	COUNTRY	ABB. No.
EUROPE	E3 0-10	EUROPE	E3 0-10
U.K.	T1 0-10		
AUSTRALIA	X 0-10		
GENERAL MARKET	M 0-21		

KRF-V5060DE (X08-3160-10)			
DESTINATION	UNIT	DESTINATION	UNIT
COUNTRY	ABB. No.	COUNTRY	ABB. No.
U.S.A.	K 0-10	U.S.A.	K 0-10
CANADA	P 0-10		

KRF-V5560D (X08-3160-XX)			
DESTINATION	UNIT	DESTINATION	UNIT
COUNTRY	ABB. No.	COUNTRY	ABB. No.
U.S.A.	K 0-10	U.S.A.	K 0-10
CANADA	P 0-10		

KRF-V5560D-S (X08-3160-XX)			
DESTINATION	UNIT	DESTINATION	UNIT
COUNTRY	ABB. No.	COUNTRY	ABB. No.
U.S.A.	K 0-10	U.S.A.	K 0-10
CANADA	P 0-10		

IC601 : CS493264-CLR			
IC602 : AK4586			
IC603 : TC7WU04FU			
IC604 : TC7WH123FU			
IC605 : TC74HCT7007AF			
IC606 : TC74HC07AF			

IC609 : XC62EP2502MR			
IC611 : BA03LBSG			
IC612 : BA05T			
IC701-703,707 : NUM4565MD			
IC705 : NUJ7311AM			

Q601,602 : DTC124EUA or UN5212			
Q606 : 2SB1375			
Q608 : 2SC4081(R,S) or 2SD1819A(Q,R)			
Q609 : 2SA1576A(R,S) or 2SB1218A(Q,R)			

D601,608,611-614 : MA111			
D602,605 : 1SS301 or DAN202U or MA142WK			
D603 : 1SS300 or DAF202U or MA142WA			
D604 : UDZ3.9B or HZU3.9(B2)			
D606,607 : UDZ5.6B or HZU5.6(B2)			
D609 : D2SBA20F03			
D610 : UDZ5.1B or HZU5.1(B2)			

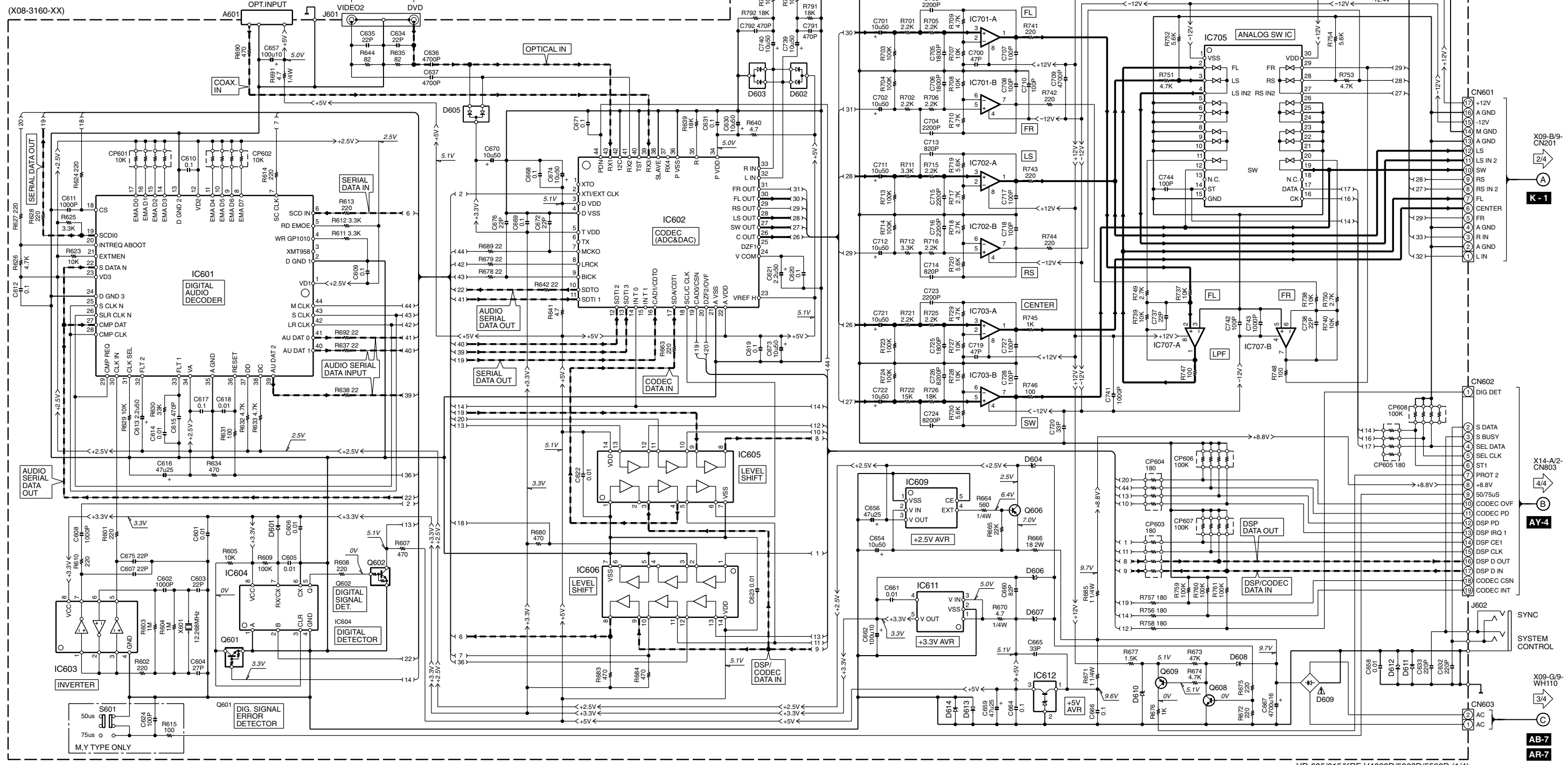
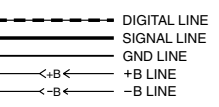

VR-605/615/KRF-V4060D/5060D/5560D (1/4)

CAUTION: For continued safety, replace safety critical components only with manufacturer's recommended parts (refer to parts list). Δ indicates safety critical components. For continued protection against risk of fire, replace only with same type and rating fuse(s). To reduce the risk of electric shock, leakage-current or resistance measurements shall be carried out (exposed parts are acceptably insulated from the supply circuit) before the appliance is returned to the customer.

The DC voltage is an actual reading measured with a high impedance type voltmeter with a cassette loaded at playback mode. The measurement value may vary depending on the measuring instruments used or on the product. Bias circuit DC voltage is measured while in the record mode.

KRF-V4060D/V5060D/V5560D/VR-605/615

KENWOOD

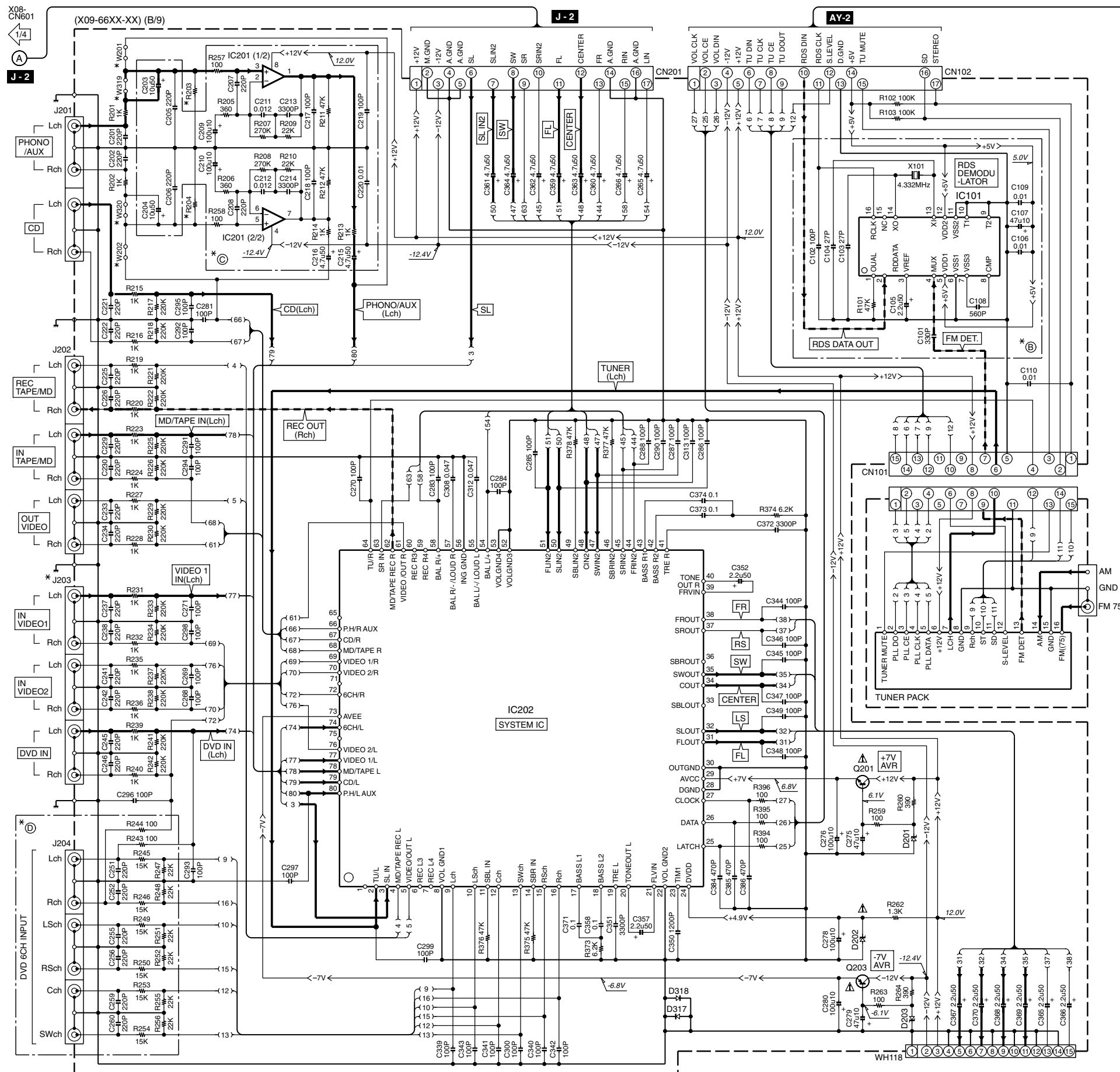

KRF-V4060D (X09-660X-XX)

DESTINATION	COUNTRY	ABB.	UNIT No.	(B)	(C)	(D)	J203	R203, 204	W201,202, 319,320
EUROPE	E	2-72		YES	NO		E63-1258-05	47K	YES
U.K.	T	0-52							

KRF-V4060D-S (X09-660X-XX)

DESTINATION	COUNTRY	ABB.	UNIT No.	(B)	(C)	(D)	J203	R203, 204	W201,202, 319,320
EUROPE	E3	2-72		YES	NO		E63-1258-05	47K	YES
U.K.	T1	0-52							
AUSTRALIA	X	0-72		NO	NO		E63-1258-05	47K	YES
GENERAL MARKET	M	0-22							

KRF-V4060DE (X09-6602-72)

DESTINATION	COUNTRY	ABB.	UNIT No.	(B)	(C)	(D)	J203	R203, 204	W201,202, 319,320
EUROPE	E1	2-72		YES	NO		E63-1258-05	47K	YES

KRF-V4060DE-S (X09-6602-72)

DESTINATION	COUNTRY	ABB.	UNIT No.	(B)	(C)	(D)	J203	R203, 204	W201,202, 319,320
EUROPE	E2	2-72		YES	NO		E63-1258-05	47K	YES

VR-605 (X09-6600-10)

DESTINATION	COUNTRY	ABB.	UNIT No.	(B)	(C)	(D)	J203	R203, 204	W201,202, 319,320
U.S.A.	K	0-10		NO	NO		E63-1258-05	47K	YES
CANADA	P								

KRF-V5060D (X09-660X-XX)

DESTINATION	COUNTRY	ABB.	UNIT No.	(B)	(C)	(D)	J203	R203, 204	W201,202, 319,320
EUROPE	E	2-71		YES	YES		E63-1256-05	30K	NO
U.K.	T	0-51							YES
PX	Y	2-91		NO				47K	NO

KRF-5060D-S (X09-660X-XX)

DESTINATION	COUNTRY	ABB.	UNIT No.	(B)	(C)	(D)	J203	R203, 204	W201,202, 319,320
EUROPE	E3	2-71		YES	YES		E63-1256-05	30K	NO
U.K.	T1	0-51							YES
AUSTRALIA	X	0-71		NO	YES		E63-1256-05	47K	YES
GENERAL MARKET	M	0-21							

KRF-5060DE (X09-6602-71)

DESTINATION	COUNTRY	ABB.	UNIT No.	(B)	(C)	(D)	J203	R203, 204	W201,202, 319,320
EUROPE	E1	2-71		YES	YES		E63-1256-05	30K	NO

VR-615 (X09-6610-10)

DESTINATION	COUNTRY	ABB.	UNIT No.	(B)	(C)	(D)	J203	R203, 204	W201,202, 319,320
U.S.A.	K	0-10		NO	YES		E63-1256-05	47K	YES
CANADA	P								

KRF-V5560D (X09-6612-XX)

DESTINATION	COUNTRY	ABB.	UNIT No.	(B)	(C)	(D)	J203	R203, 204	W201,202, 319,320
EUROPE	E	2-71		YES	NO		E63-1258-05	47K	YES
PX	Y	2-91		NO					

KRF-V5560D-S (X09-661X-XX)

DESTINATION	COUNTRY	ABB.	UNIT No.	(B)	(C)	(D)	J203	R203, 204	W201,202, 319,320
EUROPE	E3	2-71		YES			E63-1258-05	47K	YES
U.K.	T1	0-51							
AUSTRALIA	X	0-71		NO	NO		E63-1258-05	47K	YES
KOREA	H	4-11							
GENERAL MARKET	M	0-21							

- IC101 : BU1923
- IC201 : NJM4580L-D
- IC202 : M61516FP
- Q201 : 2SC1845(F,E)
- Q203 : 2SA992(F,E)
- D201,203 : MTZJ6.8(B) or HZS6.8N(B2)
- D202 : MTZJ5.1(B) or HZS5.1N(B2)
- D317,318 : 1SS133 or HSS104A

CAUTION: For continued safety, replace safety critical components only with manufacturer's recommended parts (refer to parts list). Δ indicates safety critical components. For continued protection against risk of fire, replace only with same type and rating fuse(s). To reduce the risk of electric shock, leakage-current or resistance measurements shall be carried out (exposed parts are acceptably insulated from the supply circuit) before the appliance is returned to the customer.

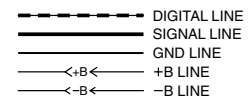

MODE	CARRIER	MODULATION		ANT INPUT
		FREQUENCY	DEVIATION	
FM	98MHz	1kHz	STEREO 67.5kHz 7.5kHz(Pilot)	60dB
AM	1000(999)kHz	400Hz	MONO 30% MOD	60dB

The DC voltage is an actual reading measured with a high impedance type voltmeter as the AM/FM signal generator is specified to the conditions as shown in the list below. The measurement value may vary depending on the measuring instruments used or on the product. The value shown in () is actual reading measured in the AM mode.

U-3
AJ-3

VR-605/615/KRF-V4060D/5060D/5560D (2/4)

U-3
AJ-3

KRF-V4060D/V5060D/V5560D/VR-605/615

Y05-4530-10

KENWOOD

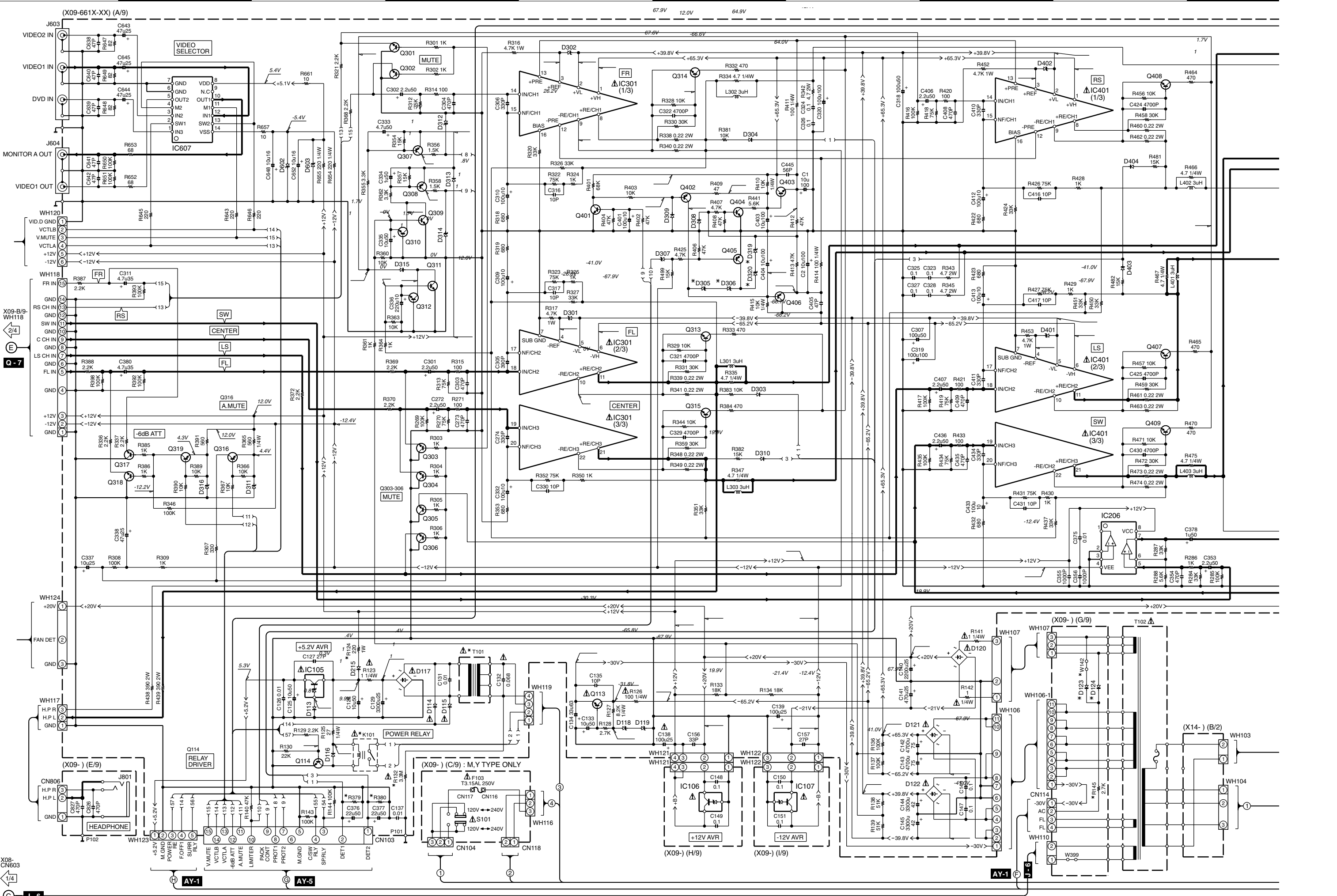

(X09-661x-xx) (A/9)

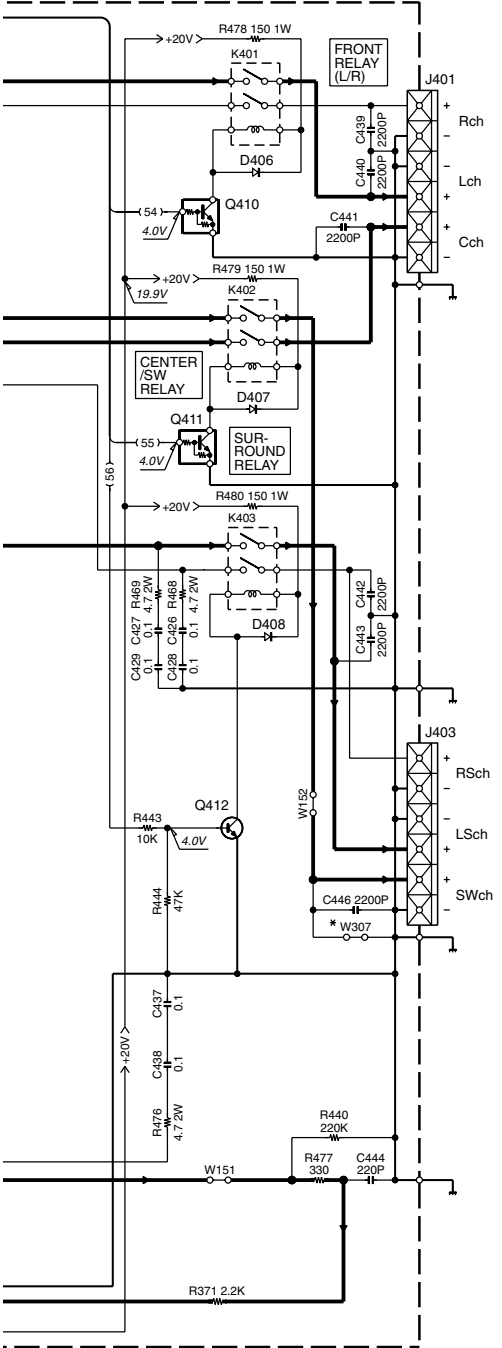

VR615 (X09-6610-10)

DESTINATION	UNIT ABB.	C130	CN106	CN112	D123	D305, 306	D319, 320	F101	F102	J205	J206	K101	R124, 132	R379, 380	R145	S102	T101	W321, 387	W142	W143	W144	W145	W146	W147	W148	W149	W150	W151	W152	W153	W154	W155	W156	W157	W158	W159	W160	W161	W162	W163	W164	W165	W166	W167	W168	W169	W170	W171	W172	W173	W174	W175	W176	W177	W178	W179	W180	W181	W182	W183	W184	W185	W186	W187	W188	W189	W190	W191	W192	W193	W194	W195	W196	W197	W198	W199	W200	W201	W202	W203	W204	W205	W206	W207	W208	W209	W210	W211	W212	W213	W214	W215	W216	W217	W218	W219	W220	W221	W222	W223	W224	W225	W226	W227	W228	W229	W230	W231	W232	W233	W234	W235	W236	W237	W238	W239	W240	W241	W242	W243	W244	W245	W246	W247	W248	W249	W250	W251	W252	W253	W254	W255	W256	W257	W258	W259	W260	W261	W262	W263	W264	W265	W266	W267	W268	W269	W270	W271	W272	W273	W274	W275	W276	W277	W278	W279	W280	W281	W282	W283	W284	W285	W286	W287	W288	W289	W290	W291	W292	W293	W294	W295	W296	W297	W298	W299	W300	W301	W302	W303	W304	W305	W306	W307	W308	W309	W310	W311	W312	W313	W314	W315	W316	W317	W318	W319	W320	W321	W322	W323	W324	W325	W326	W327	W328	W329	W330	W331	W332	W333	W334	W335	W336	W337	W338	W339	W340	W341	W342	W343	W344	W345	W346	W347	W348	W349	W350	W351	W352	W353	W354	W355	W356	W357	W358	W359	W360	W361	W362	W363	W364	W365	W366	W367	W368	W369	W370	W371	W372	W373	W374	W375	W376	W377	W378	W379	W380	W381	W382	W383	W384	W385	W386	W387	W388	W389	W390	W391	W392	W393	W394	W395	W396	W397	W398	W399	W400	W401	W402	W403	W404	W405	W406	W407	W408	W409	W410	W411	W412	W413	W414	W415	W416	W417	W418	W419	W420	W421	W422	W423	W424	W425	W426	W427	W428	W429	W430	W431	W432	W433	W434	W435	W436	W437	W438	W439	W440	W441	W442	W443	W444	W445	W446	W447	W448	W449	W450	W451	W452	W453	W454	W455	W456	W457	W458	W459	W460	W461	W462	W463	W464	W465	W466	W467	W468	W469	W470	W471	W472	W473	W474	W475	W476	W477	W478	W479	W480	W481	W482	W483	W484	W485	W486	W487	W488	W489	W490	W491	W492	W493	W494	W495	W496	W497	W498	W499	W500	W501	W502	W503	W504	W505	W506	W507	W508	W509	W510	W511	W512	W513	W514	W515	W516	W517	W518	W519	W520	W521	W522	W523	W524	W525	W526	W527	W528	W529	W530	W531	W532	W533	W534	W535	W536	W537	W538	W539	W540	W541	W542	W543	W544	W545	W546	W547	W548	W549	W550	W551	W552	W553	W554	W555	W556	W557	W558	W559	W560	W561	W562	W563	W564	W565	W566	W567	W568	W569	W570	W571	W572	W573	W574	W575	W576	W577	W578	W579	W580	W581	W582	W583	W584	W585	W586	W587	W588	W589	W590	W591	W592	W593	W594	W595	W596	W597	W598	W599	W600	W601	W602	W603	W604	W605	W606	W607	W608	W609	W610	W611	W612	W613	W614	W615	W616	W617	W618	W619	W620	W621	W622	W623	W624	W625	W626	W627	W628	W629	W630	W631	W632	W633	W634	W635	W636	W637	W638	W639	W640	W641	W642	W643	W644	W645	W646	W647	W648	W649	W650	W651	W652	W653	W654	W655	W656	W657	W658	W659	W660	W661	W662	W663	W664	W665	W666	W667	W668	W669	W670	W671	W672	W673	W674	W675	W676	W677	W678	W679	W680	W681	W682	W683	W684	W685	W686	W687	W688	W689	W690	W691	W692	W693	W694	W695	W696	W697	W698	W699	W700	W701	W702	W703	W704	W705	W706	W707	W708	W709	W710	W711	W712	W713	W714	W715	W716	W717	W718	W719	W720	W721	W722	W723	W724	W725	W726	W727	W728	W729	W730	W731	W732	W733	W734	W735	W736	W737	W738	W739	W740	W741	W742	W743	W744	W745	W746	W747	W748	W749	W750	W751	W752	W753	W754	W755	W756	W757	W758	W759	W760	W761	W762	W763	W764	W765	W766	W767	W768	W769	W770	W771	W772	W773	W774	W775	W776	W777	W778	W779	W780	W781	W782	W783	W784	W785	W786	W787	W788	W789	W790	W791	W792	W793	W794	W795	W796	W797	W798	W799	W800	W801	W802	W803	W804	W805	W806	W807	W808	W809	W810	W811	W812	W813	W814	W815	W816	W817	W818	W819	W820	W821	W822	W823	W824	W825	W826	W827	W828	W829	W830	W831	W832	W833	W834	W835	W836	W837	W838	W839	W840	W841	W842	W843	W844	W845	W846	W847	W848	W849	W850	W851	W852	W853	W854	W855	W856	W857	W858	W859	W860	W861	W862	W863	W864	W865	W866	W867	W868	W869	W870	W871	W872	W873	W874	W875	W876	W877	W878	W879	W880	W881	W882	W883	W884	W885	W886	W887	W888	W889	W890	W891	W892	W893	W894	W895	W896	W897	W898	W899	W900	W901	W902	W903	W904	W905	W906	W907	W908	W909	W910	W911	W912	W913	W914	W915	W916	W917	W918	W919	W920	W921	W922	W923	W924	W925	W926	W927	W928	W929	W930	W931	W932	W933	W934	W935	W936	W937	W938	W939	W940	W941	W942	W943	W944	W945	W946	W947	W948	W949	W950	W951	W952	W953	W954	W955	W956	W957	W958	W959	W960	W961	W962	W963	W964	W965	W966	W967	W968	W969	W970	W971	W972	W973	W974	W975	W976	W977	W978	W979	W980	W981	W982	W983	W984	W985	W986	W987	W988	W989	W990	W991	W992	W993	W994	W995	W996	W997	W998	W999	W1000
-------------	-----------	------	-------	-------	------	-----------	-----------	------	------	------	------	------	-----------	-----------	------	------	------	-----------	------	------	------	------	------	------	------	------	------	------	------	------	------	------	------	------	------	------	------	------	------	------	------	------	------	------	------	------	------	------	------	------	------	------	------	------	------	------	------	------	------	------	------	------	------	------	------	------	------	------	------	------	------	------	------	------	------	------	------	------	------	------	------	------	------	------	------	------	------	------	------	------	------	------	------	------	------	------	------	------	------	------	------	------	------	------	------	------	------	------	------	------	------	------	------	------	------	------	------	------	------	------	------	------	------	------	------	------	------	------	------	------	------	------	------	------	------	------	------	------	------	------	------	------	------	------	------	------	------	------	------	------	------	------	------	------	------	------	------	------	------	------	------	------	------	------	------	------	------	------	------	------	------	------	------	------	------	------	------	------	------	------	------	------	------	------	------	------	------	------	------	------	------	------	------	------	------	------	------	------	------	------	------	------	------	------	------	------	------	------	------	------	------	------	------	------	------	------	------	------	------	------	------	------	------	------	------	------	------	------	------	------	------	------	------	------	------	------	------	------	------	------	------	------	------	------	------	------	------	------	------	------	------	------	------	------	------	------	------	------	------	------	------	------	------	------	------	------	------	------	------	------	------	------	------	------	------	------	------	------	------	------	------	------	------	------	------	------	------	------	------	------	------	------	------	------	------	------	------	------	------	------	------	------	------	------	------	------	------	------	------	------	------	------	------	------	------	------	------	------	------	------	------	------	------	------	------	------	------	------	------	------	------	------	------	------	------	------	------	------	------	------	------	------	------	------	------	------	------	------	------	------	------	------	------	------	------	------	------	------	------	------	------	------	------	------	------	------	------	------	------	------	------	------	------	------	------	------	------	------	------	------	------	------	------	------	------	------	------	------	------	------	------	------	------	------	------	------	------	------	------	------	------	------	------	------	------	------	------	------	------	------	------	------	------	------	------	------	------	------	------	------	------	------	------	------	------	------	------	------	------	------	------	------	------	------	------	------	------	------	------	------	------	------	------	------	------	------	------	------	------	------	------	------	------	------	------	------	------	------	------	------	------	------	------	------	------	------	------	------	------	------	------	------	------	------	------	------	------	------	------	------	------	------	------	------	------	------	------	------	------	------	------	------	------	------	------	------	------	------	------	------	------	------	------	------	------	------	------	------	------	------	------	------	------	------	------	------	------	------	------	------	------	------	------	------	------	------	------	------	------	------	------	------	------	------	------	------	------	------	------	------	------	------	------	------	------	------	------	------	------	------	------	------	------	------	------	------	------	------	------	------	------	------	------	------	------	------	------	------	------	------	------	------	------	------	------	------	------	------	------	------	------	------	------	------	------	------	------	------	------	------	------	------	------	------	------	------	------	------	------	------	------	------	------	------	------	------	------	------	------	------	------	------	------	------	------	------	------	------	------	------	------	------	------	------	------	------	------	------	------	------	------	------	------	------	------	------	------	------	------	------	------	------	------	------	------	------	------	------	------	------	------	------	------	------	------	------	------	------	------	------	------	------	------	------	------	------	------	------	------	------	------	------	------	------	------	------	------	------	------	------	------	------	------	------	------	------	------	------	------	------	------	------	------	------	------	------	------	------	------	------	------	------	------	------	------	------	------	------	------	------	------	------	------	------	------	------	------	------	------	------	------	------	------	------	------	------	------	------	------	------	------	------	------	------	------	------	------	------	------	------	------	------	------	------	------	------	------	------	------	------	------	------	------	------	------	------	------	------	------	------	------	------	------	------	------	------	------	------	------	------	------	------	------	------	------	------	------	------	------	------	------	------	------	------	------	------	------	------	------	------	------	------	------	------	------	------	------	------	------	------	------	------	------	------	------	------	------	------	------	------	------	------	------	------	------	------	------	------	------	------	------	------	------	------	------	------	------	------	------	------	------	------	------	------	------	------	------	------	------	------	------	------	------	------	------	------	------	------	------	------	------	------	------	------	------	------	------	------	------	------	------	------	------	------	------	------	------	------	------	------	------	------	------	------	------	------	-------

KRF-V5560D (X09-6612-XX)

DESTINATION	UNIT ABB.	C130	CN106	CN112	D123	D305, 306	D319, 320	F101	F102	J205	J206	K101	R124, 145	R132	R133	R134	R135	R136	R137	R138	R139	R140	R141	R142	R143	R144	R145	R146	R147	R148	R149	R150	R151	R152	R153	R154	R155	R156	R157	R158	R159	R160	R161	R162	R163	R164	R165	R166	R167	R168	R169	R170	R171	R172	R173	R174	R175	R176	R177	R178	R179	R180	R181	R182	R183	R184	R185	R186	R187	R188	R189	R190	R191	R192	R193	R194	R195	R196	R197	R198	R199	R200	R201	R202	R203	R204	R205	R206	R207	R208	R209	R210	R211	R212	R213	R214	R215	R216	R217	R218	R219	R220	R221	R222	R223	R224	R225	R226	R227	R228	R229	R230	R231	R232	R233	R234	R235	R236	R237	R238	R239	R240	R241	R242	R243	R244	R245	R246	R247	R248	R249	R250	R251	R252	R253	R254	R255	R256	R257	R258	R259	R260	R261	R262	R263	R264	R265	R266	R267	R268	R269	R270	R271	R272	R273	R274	R275	R276	R277	R278	R279	R280	R281	R282	R283	R284	R285	R286	R287	R288	R289	R290	R291	R292	R293	R294	R295	R296	R297	R298	R299	R300	R301	R302	R303	R304	R305	R306	R307	R308	R309	R310	R311	R312	R313	R314	R315	R316	R317	R318	R319	R320	R321	R322	R323	R324	R325	R326	R327	R328	R329	R330	R331	R332	R333	R334	R335	R336	R337	R338	R339	R340	R341	R342	R343	R344	R345	R346	R347	R348	R349	R350	R351	R352	R353	R354	R355	R356	R357	R358	R359	R360	R361	R362	R363	R364	R365	R366	R367	R368	R369	R370	R371	R372	R373	R374	R375	R376	R377	R378	R379	R380	R381	R382	R383	R384	R385	R386	R387	R388	R389	R390	R391	R392	R393	R394	R395	R396	R397	R398	R399	R400	R401	R402	R403	R404	R405	R406	R407	R408	R409	R410	R411	R412	R413	R414	R415	R416	R417	R418	R419	R420	R421	R422	R423	R424	R425	R426	R427	R428	R429	R430	R431	R432	R433	R434	R435	R436	R437	R438	R439	R440	R441	R442	R443	R444	R445	R446	R447	R448	R449	R450
-------------	-----------	------	-------	-------	------	-----------	-----------	------	------	------	------	------	-----------	------	------	------	------	------	------	------	------	------	------	------	------	------	------	------	------	------	------	------	------	------	------	------	------	------	------	------	------	------	------	------	------	------	------	------	------	------	------	------	------	------	------	------	------	------	------	------	------	------	------	------	------	------	------	------	------	------	------	------	------	------	------	------	------	------	------	------	------	------	------	------	------	------	------	------	------	------	------	------	------	------	------	------	------	------	------	------	------	------	------	------	------	------	------	------	------	------	------	------	------	------	------	------	------	------	------	------	------	------	------	------	------	------	------	------	------	------	------	------	------	------	------	------	------	------	------	------	------	------	------	------	------	------	------	------	------	------	------	------	------	------	------	------	------	------	------	------	------	------	------	------	------	------	------	------	------	------	------	------	------	------	------	------	------	------	------	------	------	------	------	------	------	------	------	------	------	------	------	------	------	------	------	------	------	------	------	------	------	------	------	------	------	------	------	------	------	------	------	------	------	------	------	------	------	------	------	------	------	------	------	------	------	------	------	------	------	------	------	------	------	------	------	------	------	------	------	------	------	------	------	------	------	------	------	------	------	------	------	------	------	------	------	------	------	------	------	------	------	------	------	------	------	------	------	------	------	------	------	------	------	------	------	------	------	------	------	------	------	------	------	------	------	------	------	------	------	------	------	------	------	------	------	------	------	------	------	------	------	------	------	------	------	------	------	------	------	------	------	------	------	------	------	------	------	------	------	------	------	------	------	------	------	------	------	------	------	------	------	------

(X09-660X-XX) (A/9)

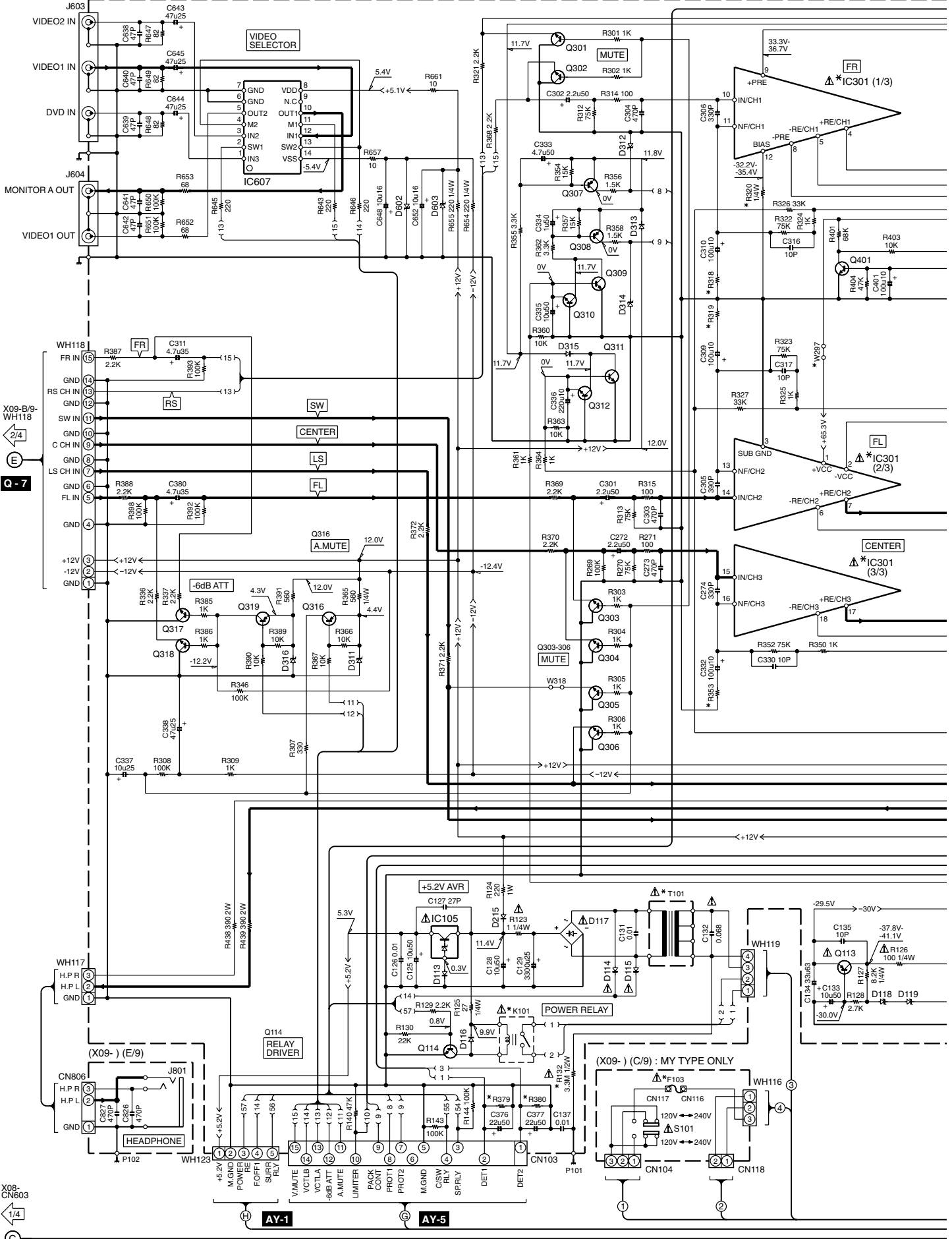

X08-CN603

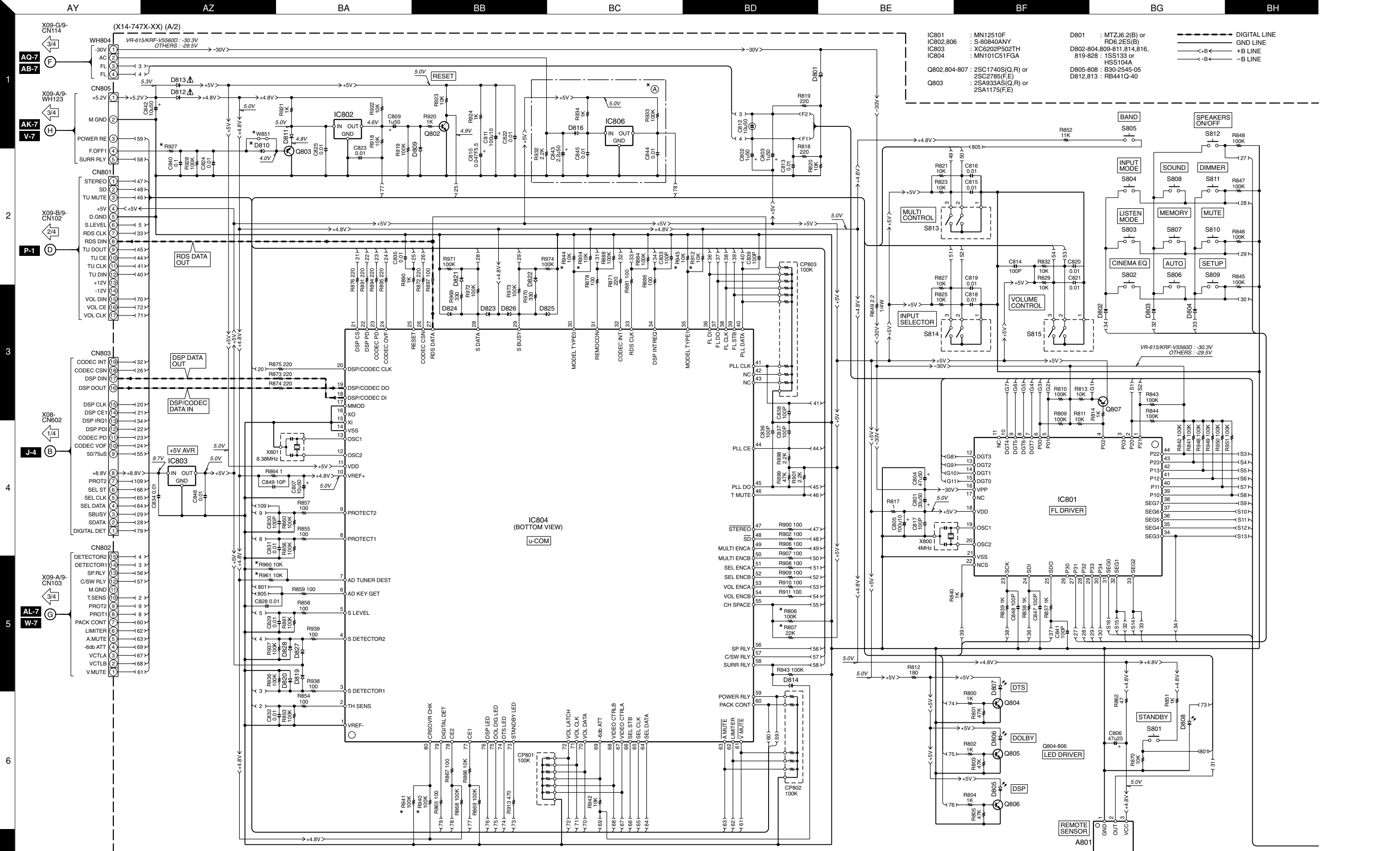

- | | | |
|------------------------|---|------------------|
| IC801 : MN12510F | D801 : MTZJ6.2(B) or RD6.2ES(B) | --- DIGITAL LINE |
| IC802,806 : S-80840ANY | D802-804,809-811,814,816, 819-828 : 1SS133 or HSS104A | --- GND LINE |
| IC803 : XC6202P502TH | D805-808 : B30-2545-05 | --- +B LINE |
| IC804 : MN101C51FGA | D812,813 : RB441Q-40 | --- -B LINE |
- Q802,804-807 : 2SC1740S(Q,R) or 2SC2785(F,E)
 Q803 : 2SA933AS(Q,R) or 2SA1175(F,E)

IC804 (BOTTOM VIEW)
u-COM

IC801
FL DRIVER

Q804-806
LED DRIVER

REMOTE SENSOR
A801

(X14-747X-XX) (A/2)

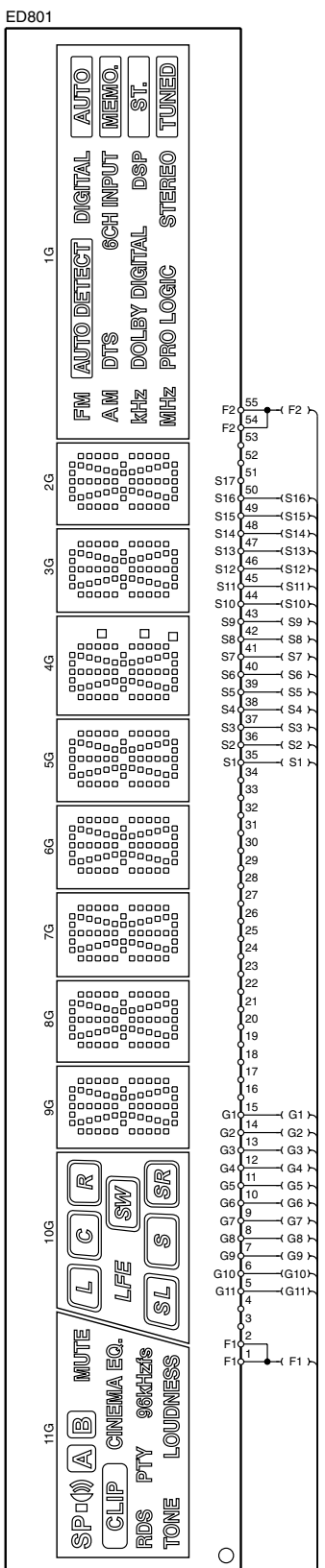

VR-605/615/KRF-V4060D/5060D/5560D (4/4)

KRF-V4060D (X14-7472-73)

DESTINATION	UNIT	(A)	D810	R806, 904, 941, 945, 961	R807, 866, 912, 940, 944, 960	R927	W851
COUNTRY	ABB. No.						
EUROPE	E		NO	NO	YES	NO	160K YES
U.K.	T	2-73					

KRF-V4060D-S (X14-747X-XX)

DESTINATION	UNIT	(A)	D810	R806, 940	R807, 866	R904, 941, 945, 961	R912, 944	R927	R960	W851
COUNTRY	ABB. No.									
GENERAL MARKET	M	0-23	YES	YES	NO	YES				NO
AUSTRALIA	X	0-73						62K 180K	YES	
EUROPE	E3		NO	NO	YES	NO	NO	160K	NO	YES
U.K.	T1	2-73								

KRF-V4060DE (X14-7472-73)

DESTINATION	UNIT	(A)	D810	R806, 904, 941, 945, 961	R807, 866, 912, 940, 944, 960	R927	W851
COUNTRY	ABB. No.						
EUROPE	E1	2-73	NO	NO	YES	NO	160K YES

KRF-V4060DE-S (X14-7472-73)

DESTINATION	UNIT	(A)	D810	R806, 904, 941, 945, 961	R807, 866, 912, 940, 944, 960	R927	W851
COUNTRY	ABB. No.						
EUROPE	E2	2-73	NO	NO	YES	NO	160K YES

VR605 (X14-7470-10)

DESTINATION	UNIT	(A)	D810	R806, 904, 941, 945, 960	R807, 866, 912, 940, 944, 960	R927	W851
COUNTRY	ABB. No.						
U.S.A	K	0-10	NO	YES	YES	NO	56K NO
CANADA	P						

KRF-V5060D (X14-747X-XX)

DESTINATION	UNIT	(A)	D810	R806, 945	R807, 866, 912, 960	R904, 940	R927	R941, 944, 961	W851
COUNTRY	ABB. No.								
PX	Y	0-21	YES	YES	NO	YES		62K	NO
EUROPE	E	2-71	NO	NO	YES	NO	NO	160K	YES
U.K.	T								YES

KRF-V5060D-S (X14-747X-XX)

DESTINATION	UNIT	(A)	D810	R806	R807, 866	R904, 940	R912	R927	R941, 944, 961	R945	R960	W851
COUNTRY	ABB. No.											
GENERAL MARKET	M	0-21	YES	YES	NO	YES			62K	NO	YES	NO
AUSTRALIA	X	0-71					YES		180K			
EUROPE	E3		NO	NO	YES	NO	NO	NO	160K	YES	NO	YES
U.K.	T1	2-71										

KRF-V5060DE (X14-7472-71)

DESTINATION	UNIT	(A)	D810	R806, 941, 944, 945, 961	R807, 866, 904, 912, 940, 960	R927	W851
COUNTRY	ABB. No.						
EUROPE	E1	2-71	NO	NO	YES	NO	160K YES

VR-615 (X14-7470-11)

DESTINATION	UNIT	(A)	D810	R806, 912, 940, 944, 960	R807, 866, 904, 941, 945, 961	R927	W851
COUNTRY	ABB. No.						
U.S.A	K	0-11	NO	YES	YES	NO	56K NO
CANADA	P						

KRF-V5560D (X14-747X-XX)

DESTINATION	UNIT	(A)	D810	R806	R807, 866, 960	R904, 941, 945, 961	R912, 940, 944	R927	W851
COUNTRY	ABB. No.								
PX	Y	0-22	YES	YES	NO	YES			62K NO
EUROPE	E	2-72	NO	NO	YES	NO	NO	160K	YES

KRF-V5560D-S (X14-747X-XX)

DESTINATION	UNIT	(A)	D810	R806	R807, 866	R904, 941, 945, 961	R912, 940, 944	R927	R960	W851
COUNTRY	ABB. No.									
GENERAL MARKET	M	0-22	YES	YES	NO	YES				NO
AUSTRALIA	X	0-72						62K 180K	YES	
EUROPE	E3		NO	NO	YES	NO	NO	160K	NO	YES
U.K.	T1	2-72								
KOREA	H									

	11G	10G	9G	8G	7G	6G	5G	4G	3G	2G	1G
P1	SPD(Ⓜ)	L	a	a	a	a	a	a	a	a	FM
P2	(A)	C	j	j	j	j	j	j	j	j	AM
P3	(B)	R	h	h	h	h	h	h	h	h	MHz
P4	MUTE	SL	k	k	k	k	k	k	k	k	kHz
P5	CLIP	S	b	b	b	b	b	b	b	b	AUTO
P6	CINEMA EQ.	SR	f	f	f	f	f	f	f	f	MEMO.
P7	-	LFE	g	g	g	g	g	g	g	g	ST.
P8	-	SW	m	m	m	m	m	m	m	m	TUNED
P9	RDS	(L)	c	c	c	c	c	c	c	c	AUTO DETECT
P10	PTY	(C)	e	e	e	e	e	e	e	e	DTS
P11	96kHz	(R)	r	r	r	r	r	r	r	r	DOLBY DIGITAL
P12	TOUR	(SL)	n	n	n	n	n	n	n	n	PRO LOGIC
P13	LOUDNESS	(S)	p	p	p	p	p	p	p	p	DIGITAL
P14	-	(SR)	d	d	d	d	d	d	d	d	6CH INPUT
P15	-	(SW)	-	-	-	-	-	-	-	-	DSP
P16	-	-	-	-	-	-	-	-	-	-	STEREO

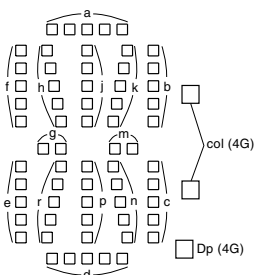

CAUTION: For continued safety, replace safety critical components only with manufacturer's recommended parts (refer to parts list). Δ indicates safety critical components. For continued protection against risk of fire, replace only with same type and rating fuse(s). To reduce the risk of electric shock, leakage-current or resistance measurements shall be carried out (exposed parts are acceptably insulated from the supply circuit) before the appliance is returned to the customer.

The DC voltage is an actual reading measured with a high impedance type voltmeter with a cassette loaded at playback mode. The measurement value may vary depending on the measuring instruments used or on the product. Bias circuit DC voltage is measured while in the record mode.

KRF-V4060D/V5060D/V5560D/VR-605/615

EXPLODED VIEW

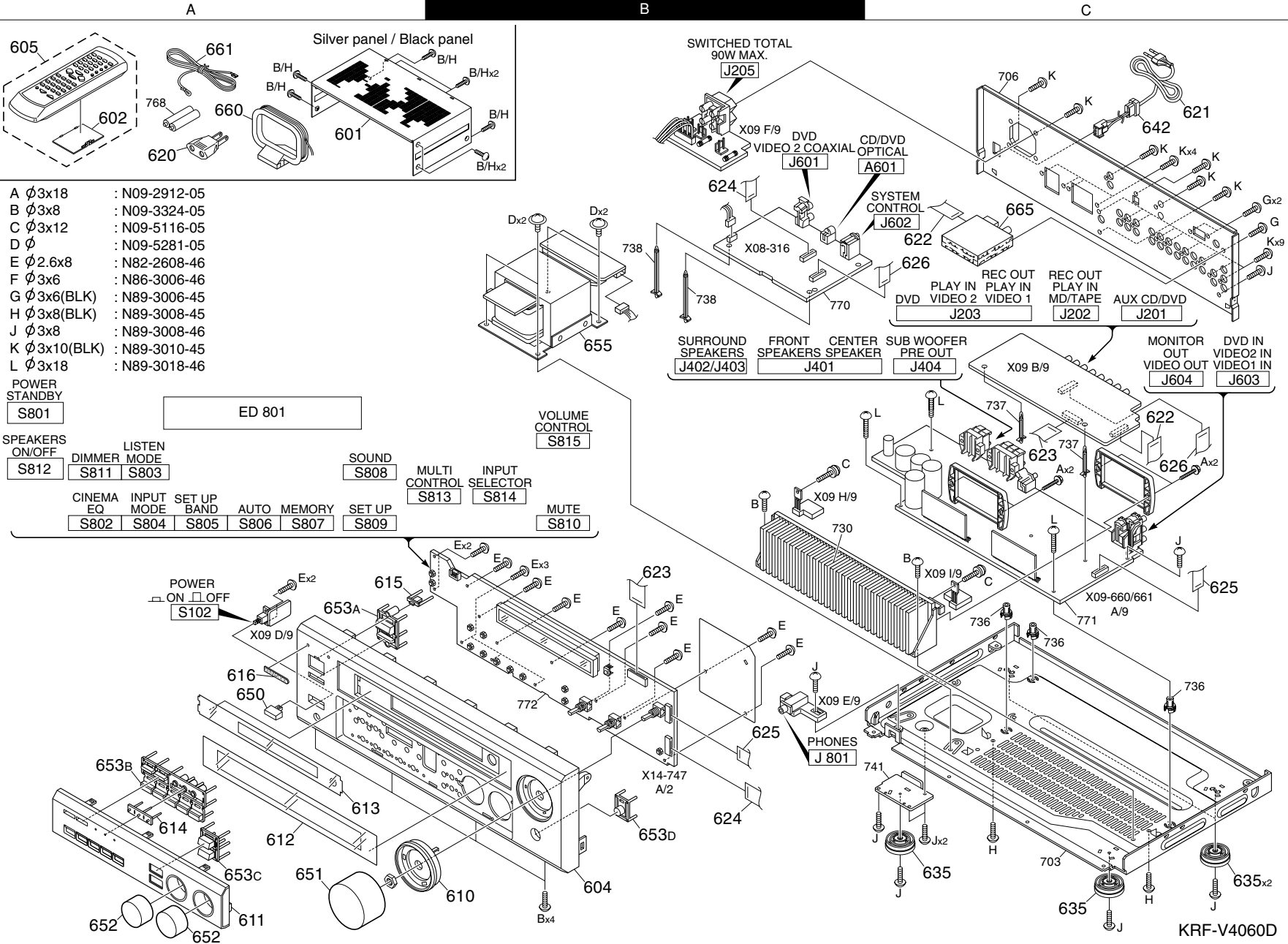

- A ϕ 3x18 : N09-2912-05
- B ϕ 3x8 : N09-3324-05
- C ϕ 3x12 : N09-5116-05
- D ϕ : N09-5281-05
- E ϕ 2.6x8 : N82-2608-46
- F ϕ 3x6 : N86-3006-46
- G ϕ 3x6(BLK) : N89-3006-45
- H ϕ 3x8(BLK) : N89-3008-45
- J ϕ 3x8 : N89-3008-46
- K ϕ 3x10(BLK) : N89-3010-45
- L ϕ 3x18 : N89-3018-46

POWER STANDBY

SPEAKERS ON/OFF

LISTEN DIMMER MODE

CINEMA EQ

ED 801

SOUND

MULTI CONTROL INPUT SELECTOR

VOLUME CONTROL

SET UP BAND AUTO MEMORY SET UP

MUTE

POWER ON OFF

PHONES

KRF-V4060D

* New Parts

Parts without **Parts No.** are not supplied.

Les articles non mentionnés dans le **Parts No.** ne sont pas fournis.

Teile ohne **Parts No.** werden nicht geliefert.

①

Ref. No	Add-ress	New Parts	Parts No.	Description	Desti-nation	Re-marks
KRF-V4060D						
601	1A		A01-3844-01	METALLIC CABINET	EE1T	
601	1A		A01-3848-01	METALLIC CABINET	E2E3M	
601	1A		A01-3848-01	METALLIC CABINET	XT1	
602	2B		A09-1178-08	BATTERY COVER		
604	2B		A60-2190-11	PANEL	EE1T	
604	2B		A60-2191-11	PANEL	E2E3M	
604	2B		A60-2191-11	PANEL	XT1	
605	1A		A70-1564-05	REMOTE CONTROLLER ASSY	MX	
605	1A		A70-1566-05	REMOTE CONTROLLER ASSY	EE1E2	
605	1A		A70-1566-05	REMOTE CONTROLLER ASSY	E3TT1	
610	2B		B07-2606-03	ESCUTCHEON	EE1T	
610	2B		B07-2607-03	ESCUTCHEON	E2E3M	
610	2B		B07-2607-03	ESCUTCHEON	XT1	
611	2A		B07-2610-01	ESCUTCHEON	EE1T	
611	2A		B07-2611-01	ESCUTCHEON	E2E3M	
611	2A		B07-2611-01	ESCUTCHEON	XT1	
612	2A	*	B10-3813-02	FRONT GLASS	MX	
612	2A	*	B10-3814-02	FRONT GLASS	EE1E2	
612	2A	*	B10-3814-02	FRONT GLASS	E3TT1	
613	2A		B11-1547-03	COLOR FILTER		
614	2A		B12-0448-04	INDICATOR		
615	2A		B12-0465-04	INDICATOR		
616	2A		B43-0314-04	KENWOOD BADGE		
-			B46-0096-53	WARRANTY CARD	X	
-			B46-0310-03	WARRANTY CARD	EE1E2	
-			B46-0310-03	WARRANTY CARD	E3TT1	
-			B58-0945-03	CAUTION CARD	TT1	
-			B58-0965-13	CAUTION CARD (PL)	XTT1	
-			B58-0966-13	CAUTION CARD (PL)	EE3M	
-			B58-1607-03	CAUTION CARD	E1E2	
-			B60-5197-00	INSTRUCTION MANUAL(EN)	E1E2M	
-			B60-5197-00	INSTRUCTION MANUAL(EN)	XTT1	
-			B60-5199-00	INSTRUCTION MANUAL(ES/FR/GE)	EE3	
-		*	B60-5200-00	INSTRUCTION MANUAL(PL/RU/CZ)	E1E2	
-			B60-5201-00	INSTRUCTION MANUAL(ES/TC)	M	
△ 620	1A		E03-0115-05	AC PLUG ADAPTER	M	
△ 621	1C		E30-2717-05	AC POWER CORD	X	
△ 621	1C		E30-2721-05	AC POWER CORD	TT1	
△ 621	1C		E30-2942-05	AC POWER CORD	EE1E2	
△ 621	1C		E30-2942-05	AC POWER CORD	E3M	
622	1C		E35-3197-15	FLAT CABLE		
623	2B,1C		E35-3198-15	FLAT CABLE		
624	1B,2B		E35-3199-15	FLAT CABLE		
625	2B,2C		E35-3200-15	FLAT CABLE		
626	1C		E35-3201-15	FLAT CABLE		
-			G10-0485-04	NON-WOVEN FABRIC		
-			H10-7804-01	POLYSTYRENE FOAMED FIXTURE		
-			H10-7805-01	POLYSTYRENE FOAMED FIXTURE		
-			H21-1515-04	PROTECTION SHEET		
-			H25-0232-04	PROTECTION BAG (235X350X0.03)		
-			H25-0391-04	PROTECTION BAG		
-		*	H50-4393-04	ITEM CARTON CASE	E	

L : Scandinavia K : USA P : Canada R : Mexico C : China I : Malaysia
 Y : PX(Far East,Hawaii) T : England E : Europe G : Germany V : China(Shanghai)
 Y : AAFES(Europe) X : Australia Q : Russia H : Korea M : Other Areas △ indicates safety critical components.

* New Parts

Parts without **Parts No.** are not supplied.

Les articles non mentionnés dans le **Parts No.** ne sont pas fournis.

Teile ohne **Parts No.** werden nicht geliefert.

②

Ref. No	Add-ress	New Parts	Parts No.	Description	Desti-nation	Re-marks
-		*	H50-4394-04	ITEM CARTON CASE	T	
-		*	H50-4395-04	ITEM CARTON CASE	E1	
-		*	H50-4396-04	ITEM CARTON CASE	M	
-		*	H50-4397-04	ITEM CARTON CASE	XT1	
-		*	H50-4399-04	ITEM CARTON CASE	E3	
-		*	H50-4401-04	ITEM CARTON CASE	E2	
△ 635	2C		J02-1464-03	FOOT		
△ 642	1C		J42-0083-05	POWER CORD BUSHING		
-			J61-0307-05	WIRE BAND		
650	2A		K27-2384-04	KNOB (BUTTON)	EE1T	
650	2A		K27-2481-04	KNOB (BUTTON)	E2E3M	
650	2A		K27-2481-04	KNOB (BUTTON)	XT1	
651	2A		K29-8103-04	KNOB	EE1T	
651	2A		K29-8104-04	KNOB	E2E3M	
651	2A		K29-8104-04	KNOB	XT1	
652	2A		K29-8105-04	KNOB	EE1T	
652	2A		K29-8106-04	KNOB	E2E3M	
652	2A		K29-8106-04	KNOB	XT1	
653	2A,2B		K29-8117-01	KNOB	EE1T	
653	2A,2B		K29-8119-01	KNOB	E2E3M	
653	2A,2B		K29-8119-01	KNOB	XT1	
△ 655	1B	*	L07-3167-15	POWER TRANSFORMER	EE1E2	
△ 655	1B	*	L07-3167-15	POWER TRANSFORMER	E3TT1	
△ 655	1B	*	L07-3168-15	POWER TRANSFORMER	M	
△ 655	1B	*	L07-3169-15	POWER TRANSFORMER	X	
660	1A		T90-0852-05	LOOP ANTENNA		
661	1A		T90-0877-05	LEAD WIRE ANTENNA		
665	1C		W02-2889-05	TUNER ASSY	MX	
665	1C		W02-2890-05	TUNER ASSY	EE1E2	
665	1C		W02-2890-05	TUNER ASSY	E3TT1	
665	1C		W02-2891-05	TUNER ASSY	EE1E2	
665	1C		W02-2891-05	TUNER ASSY	E3TT1	
KRF-V5060D/VR-605						
601	1A	*	A01-3844-01	METALLIC CABINET	ETE1	
601	1A	*	A01-3844-01	METALLIC CABINET	KPY	
601	1A	*	A01-3848-01	METALLIC CABINET	MXE3T1	
602	1A		A09-1178-08	BATTERY COVER		
604	2B	*	A60-2186-11	PANEL	KP	
604	2B	*	A60-2190-11	PANEL	YETE1	
604	2B	*	A60-2191-11	PANEL	MXE3T1	
605	1A	*	A70-1563-05	REMOTE CONTROLLER ASSY	YMX	
605	1A	*	A70-1564-05	REMOTE CONTROLLER ASSY	KP	
605	1A	*	A70-1565-05	REMOTE CONTROLLER ASSY	ETE1	
605	1A	*	A70-1565-05	REMOTE CONTROLLER ASSY	E3T1	
610	2B	*	B07-2606-03	ESCUTCHEON	ETE1	
610	2B	*	B07-2606-03	ESCUTCHEON	KPY	
610	2B	*	B07-2607-03	ESCUTCHEON	MXE3T1	
611	2A	*	B07-2610-01	ESCUTCHEON	ETE1	
611	2A	*	B07-2610-01	ESCUTCHEON	KPY	

L : Scandinavia K : USA P : Canada R : Mexico C : China I : Malaysia
 Y : PX(Far East,Hawaii) T : England E : Europe G : Germany V : China(Shanghai)
 Y : AAFES(Europe) X : Australia Q : Russia H : Korea M : Other Areas △ indicates safety critical components.

PARTS LIST

KRF-V4060D/V5060D/V5560D/VR-605/615

* New Parts

Parts without **Parts No.** are not supplied.
 Les articles non mentionnés dans le **Parts No.** ne sont pas fournis.
 Teile ohne **Parts No.** werden nicht geliefert.

③

Ref. No	Add-ress	New Parts	Parts No.	Description	Desti-nation	Re-marks
611	2A	*	B07-2611-01	ESCUTCHEON	MXE3T1	
612	2A	*	B10-3805-02	FRONT GLASS	KP	
612	2A	*	B10-3808-02	FRONT GLASS	YMX	
612	2A	*	B10-3809-02	FRONT GLASS	ETE1	
612	2A	*	B10-3809-02	FRONT GLASS	E3T1	
613	2A	*	B11-1547-03	COLOR FILTER		
614	2A	*	B12-0448-04	INDICATOR		
615	2A	*	B12-0465-04	INDICATOR		
616	2A		B43-0314-04	KENWOOD BADGE		
			B46-0096-53	WARRANTY CARD	X	
			B46-0310-03	WARRANTY CARD	ETE1	
			B46-0310-03	WARRANTY CARD	E3T1	
			B46-0328-03	WARRANTY CARD	Y	
			B46-0330-03	WARRANTY CARD	K	
			B46-0347-03	WARRANTY CARD	P	
			B58-0513-04	CAUTION CARD (PRESET220-240)	Y	
			B58-0945-03	CAUTION CARD	TT1	
			B58-0964-13	CAUTION CARD (UL)	KY	
			B58-0965-13	CAUTION CARD (PL)	XTT1	
			B58-0966-13	CAUTION CARD (PL)	MEE3	
			B58-0967-03	CAUTION CARD (PL)	P	
			B58-1607-03	CAUTION CARD	E1	
			B58-1674-03	CAUTION CARD (P1,PRA,A4,1)	K	
			B59-1104-00	SERVICE DIRECTORY	Y	
		*	B60-5197-00	INSTRUCTION MANUAL(EN)	E1T1	
		*	B60-5197-00	INSTRUCTION MANUAL(EN)	KPY	
		*	B60-5197-00	INSTRUCTION MANUAL(EN)	MXT	
		*	B60-5198-00	INSTRUCTION MANUAL(FR)	P	
		*	B60-5199-00	INSTRUCTION MANUAL(ES/FR/GE)	EE3	
		*	B60-5200-00	INSTRUCTION MANUAL(PL/RU/CZ)	E1	
		*	B60-5201-00	INSTRUCTION MANUAL(ES/TC)	M	
△ 620	1A		E03-0115-05	AC PLUG ADAPTER	M	
△ 621	1C		E30-2605-05	AC POWER CORD	Y	
△ 621	1C		E30-2717-05	AC POWER CORD	X	
△ 621	1C		E30-2721-05	AC POWER CORD	TT1	
△ 621	1C		E30-2941-05	AC POWER CORD	KP	
△ 621	1C		E30-2942-05	AC POWER CORD	MEE1E3	
622	1C	*	E35-3197-15	FLAT CABLE		
623	2B,1C	*	E35-3198-15	FLAT CABLE		
624	1B,2B	*	E35-3199-15	FLAT CABLE		
625	2B,2C	*	E35-3200-15	FLAT CABLE		
626	1C	*	E35-3201-15	FLAT CABLE		
			G10-0485-04	NON-WOVEN FABRIC		
		*	H10-7804-01	POLYSTYRENE FOAMED FIXTURE		
		*	H10-7805-01	POLYSTYRENE FOAMED FIXTURE		
		*	H21-1515-04	PROTECTION SHEET		
			H25-0232-04	PROTECTION BAG (235X350X0.03)		
			H25-0391-04	PROTECTION BAG		
		*	H50-4376-04	ITEM CARTON CASE	KP	
		*	H50-4377-04	ITEM CARTON CASE	YT	
		*	H50-4378-04	ITEM CARTON CASE	E	
		*	H50-4380-04	ITEM CARTON CASE	E1	
		*	H50-4381-04	ITEM CARTON CASE	M	

L : Scandinavia K : USA P : Canada R : Mexico C : China I : Malaysia
 Y : PX(Far East,Hawaii) T : England E : Europe G : Germany V : China(Shanghai)
 Y : AAFES(Europe) X : Australia Q : Russia H : Korea M : Other Areas △ indicates safety critical components .

* New Parts

Parts without **Parts No.** are not supplied.
 Les articles non mentionnés dans le **Parts No.** ne sont pas fournis.
 Teile ohne **Parts No.** werden nicht geliefert.

④

Ref. No	Add-ress	New Parts	Parts No.	Description	Desti-nation	Re-marks
-		*	H50-4382-04	ITEM CARTON CASE	XT1	
-		*	H50-4383-04	ITEM CARTON CASE	E3	
635	2C		J02-1464-03	FOOT		
△ 642	1C		J42-0349-05	POWER CORD BUSHING		
-			J61-0307-05	WIRE BAND		
650	2A	*	K27-2384-04	KNOB (BUTTON)	YETE1	
650	2A	*	K27-2481-04	KNOB (BUTTON)	MXE3T1	
651	2A	*	K29-8103-04	KNOB	ETE1	
651	2A	*	K29-8103-04	KNOB	KPY	
651	2A	*	K29-8104-04	KNOB	MXE3T1	
652	2A	*	K29-8105-04	KNOB	ETE1	
652	2A	*	K29-8105-04	KNOB	KPY	
652	2A	*	K29-8106-04	KNOB	MXE3T1	
653	2A,2B	*	K29-8117-01	KNOB	ETE1	
653	2A,2B	*	K29-8117-01	KNOB	KPY	
653	2A,2B	*	K29-8119-01	KNOB	MXE3T1	
△ 655	1B	*	L07-2922-05	POWER TRANSFORMER	KP	
△ 655	1B	*	L07-2923-05	POWER TRANSFORMER	YM	
△ 655	1B	*	L07-2924-05	POWER TRANSFORMER	X	
△ 655	1B	*	L07-3210-05	POWER TRANSFORMER	ETE1	
△ 655	1B	*	L07-3210-05	POWER TRANSFORMER	E3T1	
660	1A		T90-0852-05	LOOP ANTENNA		
661	1A		T90-0877-05	LEAD WIRE ANTENNA		
665	1C	*	W02-2887-05	TUNER ASSY	KP	
665	1C	*	W02-2888-05	TUNER ASSY	KP	
665	1C	*	W02-2889-05	TUNER ASSY	YMX	
665	1C	*	W02-2890-05	TUNER ASSY	EE1E3	
665	1C	*	W02-2890-05	TUNER ASSY	TT1	
665	1C	*	W02-2891-05	TUNER ASSY	EE1E3	
665	1C	*	W02-2891-05	TUNER ASSY	TT1	
665	1C	*	W02-2907-05	TUNER ASSY	KP	
KRF-V5560D/VR-615						
601	1A		A01-3844-01	METALLIC CABINET	KPYE	
601	1A		A01-3848-01	METALLIC CABINET	MXE3	
601	1A		A01-3848-01	METALLIC CABINET	T1H	
602	1A		A09-1178-08	BATTERY COVER		
604	2B		A60-2186-11	PANEL	KP	
604	2B		A60-2190-11	PANEL	YE	
604	2B		A60-2191-11	PANEL	MXE3	
604	2B		A60-2191-11	PANEL	T1H	
605	1A		A70-1563-05	REMOTE CONTROLLER ASSY	KP	
605	1A		A70-1564-05	REMOTE CONTROLLER ASSY	YMXH	
605	1A		A70-1566-05	REMOTE CONTROLLER ASSY	EE3T1	
610	2B		B07-2606-03	ESCUTCHEON	KPYE	
610	2B		B07-2607-03	ESCUTCHEON	MXE3	
610	2B		B07-2607-03	ESCUTCHEON	T1H	
611	2A		B07-2610-01	ESCUTCHEON	KPYE	
611	2A		B07-2611-01	ESCUTCHEON	MXE3	

L : Scandinavia K : USA P : Canada R : Mexico C : China I : Malaysia
 Y : PX(Far East,Hawaii) T : England E : Europe G : Germany V : China(Shanghai)
 Y : AAFES(Europe) X : Australia Q : Russia H : Korea M : Other Areas △ indicates safety critical components .

PARTS LIST

KRF-V4060D/V5060D/V5560D/VR-605/615

* New Parts

Parts without **Parts No.** are not supplied.

Les articles non mentionnés dans le **Parts No.** ne sont pas fournis.

Teile ohne **Parts No.** werden nicht geliefert.

5

Ref. No	Add-ress	New Parts	Parts No.	Description	Desti-nation	Re-marks
611	2A		B07-2611-01	ESCUTCHEON	T1H	
612	2A		B10-3810-02	FRONT GLASS	KP	
612	2A		B10-3811-02	FRONT GLASS	YMXH	
612	2A		B10-3812-02	FRONT GLASS	EE3T1	
613	2A		B11-1547-03	COLOR FILTER		
614	2A		B12-0448-04	INDICATOR		
615	2A		B12-0465-04	INDICATOR		
616	2A		B43-0314-04	KENWOOD BADGE		
-			B46-0096-53	WARRANTY CARD	X	
-			B46-0310-03	WARRANTY CARD	EE3T1	
-			B46-0328-03	WARRANTY CARD	Y	
-			B46-0330-03	WARRANTY CARD	K	
-			B46-0333-03	WARRANTY CARD	H	
-			B46-0347-03	WARRANTY CARD	P	
-			B58-0513-04	CAUTION CARD (PRESET220-240)	Y	
-			B58-0945-03	CAUTION CARD	T1	
-			B58-0964-13	CAUTION CARD (UL)	KY	
-			B58-0965-13	CAUTION CARD (PL)	XT1	
-			B58-0966-13	CAUTION CARD (PL)	MEE3	
-			B58-0967-03	CAUTION CARD (PL)	P	
-			B58-1674-03	CAUTION CARD (P1,PRA,A4,1)	K	
-			B59-1104-00	SERVICE DIRECTORY	Y	
-			B60-5197-00	INSTRUCTION MANUAL(EN)	KPY	
-			B60-5197-00	INSTRUCTION MANUAL(EN)	MXT1	
-			B60-5198-00	INSTRUCTION MANUAL(FR)	P	
-			B60-5199-00	INSTRUCTION MANUAL(ES/FR/GE)	EE3	
-			B60-5201-00	INSTRUCTION MANUAL(ES/TC)	M	
△ 620	1A		E03-0115-05	AC PLUG ADAPTER	M	
△ 621	1C		E30-2605-05	AC POWER CORD	Y	
△ 621	1C		E30-2717-05	AC POWER CORD	X	
△ 621	1C		E30-2721-05	AC POWER CORD	T1	
△ 621	1C		E30-2941-05	AC POWER CORD	KP	
△ 621	1C		E30-2942-05	AC POWER CORD	MEE3	
△ 621	1C		E30-2950-05	AC POWER CORD	H	
622	1C		E35-3197-15	FLAT CABLE		
623	2B,1C		E35-3198-15	FLAT CABLE		
624	1B,2B		E35-3199-15	FLAT CABLE		
625	2B,2C		E35-3200-15	FLAT CABLE		
626	1C		E35-3201-15	FLAT CABLE		
-			G10-0485-04	NON-WOVEN FABRIC		
-			H10-7804-01	POLYSTYRENE FOAMED FIXTURE		
-			H10-7805-01	POLYSTYRENE FOAMED FIXTURE		
-			H21-1515-04	PROTECTION SHEET		
-			H25-0232-04	PROTECTION BAG (235X350X0.03)		
-			H25-0391-04	PROTECTION BAG		
-		*	H50-4385-04	ITEM CARTON CASE	KP	
-		*	H50-4386-04	ITEM CARTON CASE	Y	
-		*	H50-4387-04	ITEM CARTON CASE	E	
-		*	H50-4388-04	ITEM CARTON CASE	XT1	
-		*	H50-4389-04	ITEM CARTON CASE	MH	
-		*	H50-4391-04	ITEM CARTON CASE	E3	
635	2C		J02-1464-03	FOOT		

L : Scandinavia K : USA P : Canada R : Mexico C : China I : Malaysia
 Y : PX(Far East,Hawaii) T : England E : Europe G : Germany V : China(Shanghai)
 Y : AAFES(Europe) X : Australia Q : Russia H : Korea M : Other Areas △ indicates safety critical components .

* New Parts

Parts without **Parts No.** are not supplied.

Les articles non mentionnés dans le **Parts No.** ne sont pas fournis.

Teile ohne **Parts No.** werden nicht geliefert.

6

Ref. No	Add-ress	New Parts	Parts No.	Description	Desti-nation	Re-marks
△ 642	1C		J42-0349-05 J61-0307-05	POWER CORD BUSHING WIRE BAND		
650	2A		K27-2384-04	KNOB (BUTTON)		YE
650	2A		K27-2481-04	KNOB (BUTTON)		MXE3
650	2A		K27-2481-04	KNOB (BUTTON)		T1H
651	2A		K29-8103-04	KNOB		KPYE
651	2A		K29-8104-04	KNOB		MXE3
651	2A		K29-8104-04	KNOB		T1H
652	2A		K29-8105-04	KNOB		KPYE
652	2A		K29-8106-04	KNOB		MXE3
652	2A		K29-8106-04	KNOB		T1H
653	2A,2B		K29-8117-01	KNOB		KPYE
653	2A,2B		K29-8119-01	KNOB		MXE3
653	2A,2B		K29-8119-01	KNOB		T1H
△ 655	1B		L07-2922-05	POWER TRANSFORMER		KP
△ 655	1B		L07-2923-05	POWER TRANSFORMER		YM
△ 655	1B		L07-2924-05	POWER TRANSFORMER		X
△ 655	1B		L07-3210-05	POWER TRANSFORMER		EE3T1H
660	1A		T90-0852-05	LOOP ANTENNA		
661	1A		T90-0877-05	LEAD WIRE ANTENNA		
665	1C		W02-2887-05	TUNER ASSY		KP
665	1C		W02-2888-05	TUNER ASSY		KP
665	1C		W02-2889-05	TUNER ASSY		YMXH
665	1C		W02-2890-05	TUNER ASSY		EE3T1
665	1C		W02-2891-05	TUNER ASSY		EE3T1
665	1C		W02-2907-05	TUNER ASSY		KP
SURROUND (X08-3160-10)						
C601			CK73GB1H103K	CHIP C	0.010UF	K
C602			CK73GB1H102K	CHIP C	1000PF	K
C603			CC73GCH1H220J	CHIP C	22PF	J
C604			CC73GCH1H270J	CHIP C	27PF	J
C605,606			CK73GB1H103K	CHIP C	0.010UF	K
C607			CC73GCH1H220J	CHIP C	22PF	J
C608			CK73GB1H102K	CHIP C	1000PF	K
C609,610			CK73EB1E104K	CHIP C	0.10UF	K
C611			CK73GB1H102K	CHIP C	1000PF	K
C612			CK73EB1E104K	CHIP C	0.10UF	K
C613			CE04LW1H2R2M	ELECTRO	2.2UF	50WV
C614			CK73GB1H103K	CHIP C	0.010UF	K
C615			CC73GCH1H471J	CHIP C	470PF	J
C616			CE04LW1E470M	ELECTRO	47UF	25WV
C617			CK73EB1E104K	CHIP C	0.10UF	K
C618			CK73GB1H103K	CHIP C	0.010UF	K
C619,620			CK73EB1E104K	CHIP C	0.10UF	K
C621			CE04LW1H2R2M	ELECTRO	2.2UF	50WV
C622,623			CK73GB1H103K	CHIP C	0.010UF	K
C624			CC73GCH1H101J	CHIP C	100PF	J
C630			CE04LW1H100M	ELECTRO	10UF	50WV
C631			CK73EB1E104K	CHIP C	0.10UF	K
C632,633			CC73GCH1H221J	CHIP C	220PF	J

L : Scandinavia K : USA P : Canada R : Mexico C : China I : Malaysia
 Y : PX(Far East,Hawaii) T : England E : Europe G : Germany V : China(Shanghai)
 Y : AAFES(Europe) X : Australia Q : Russia H : Korea M : Other Areas △ indicates safety critical components .

PARTS LIST

KRF-V4060D/V5060D/V5560D/NR-605/615

* New Parts

Parts without **Parts No.** are not supplied.Les articles non mentionnés dans le **Parts No.** ne sont pas fournis.Teile ohne **Parts No.** werden nicht geliefert.

⑦

Ref. No	Add-ress	New Parts	Parts No.	Description	Desti-nation	Re-marks
C634,635			CC73GCH1H220J	CHIP C 22PF	J	
C636,637			CK73GB1H472K	CHIP C 4700PF	K	
C654			CE04LW1H100M	ELECTRO 10UF	50WV	
C656			CE04LW1E470M	ELECTRO 47UF	25WV	
C657			CE04LW1A101M	ELECTRO 100UF	10WV	
C658			CK73GB1H103K	CHIP C 0.010UF	K	
C659			CE04KW1A101M	ELECTRO 100UF	10WV	
C660			CC73GCH1H820J	CHIP C 82PF	J	
C661			CK73GB1H103K	CHIP C 0.010UF	K	
C662			CE04LW1A101M	ELECTRO 100UF	10WV	
C664			CK73EB1E104K	CHIP C 0.10UF	K	
C665			CC73GCH1H330J	CHIP C 33PF	J	
C666			CK73EB1E104K	CHIP C 0.10UF	K	
C667			CE04KW1C472M	ELECTRO 4700UF	16WV	
C668,669			CK73EB1E104K	CHIP C 0.10UF	K	
C670			CE04LW1H100M	ELECTRO 10UF	50WV	
C671			CK73EB1E104K	CHIP C 0.10UF	K	
C672			CC73GCH1H220J	CHIP C 22PF	J	
C673,674			CE04LW1H100M	ELECTRO 10UF	50WV	
C675,676			CC73GCH1H220J	CHIP C 22PF	J	
C700			CC73GCH1H470J	CHIP C 47PF	J	
C701,702			CE04LW1H100M	ELECTRO 10UF	50WV	
C703,704			CK73GB1H222K	CHIP C 2200PF	K	
C705,706			CK73GB1H182K	CHIP C 1800PF	K	
C707,708			CC73GCH1H101J	CHIP C 100PF	J	
C709			CK73GB1H472K	CHIP C 4700PF	K	
C710			CC73GCH1H101J	CHIP C 100PF	J	
C711,712			CE04LW1H100M	ELECTRO 10UF	50WV	
C713,714			CK73GB1H821K	CHIP C 820PF	K	
C715,716			CK73GB1H222K	CHIP C 2200PF	K	
C717,718			CC73GCH1H101J	CHIP C 100PF	J	
C719			CC73GCH1H470J	CHIP C 47PF	J	
C720			CC73GCH1H330J	CHIP C 33PF	J	
C721,722			CE04LW1H100M	ELECTRO 10UF	50WV	
C723			CK73GB1H222K	CHIP C 2200PF	K	
C724			CK73GB1H822K	CHIP C 8200PF	K	
C725			CK73GB1H182K	CHIP C 1800PF	K	
C726			CK73GB1H822K	CHIP C 8200PF	K	
C727,728			CC73GCH1H101J	CHIP C 100PF	J	
C737,738			CC73GCH1H220J	CHIP C 22PF	J	
C739,740			CE04LW1H100M	ELECTRO 10UF	50WV	
C741			CK73GB1H102K	CHIP C 1000PF	K	
C742			CC73GCH1H101J	CHIP C 100PF	J	
C743			CK73GB1H102K	CHIP C 1000PF	K	
C744			CC73GCH1H101J	CHIP C 100PF	J	
C791,792			CC73GCH1H471J	CHIP C 470PF	J	
CN601		*	E40-8482-05	FLAT CABLE CONNECTOR		
CN602			E40-8483-05	FLAT CABLE CONNECTOR		
CN603			E40-3246-05	PIN ASSY		
J601			E63-1080-05	PIN JACK		
J602			E11-0293-05	MINIATURE PHONE JACK(2P)		
X601			L77-2296-05	CRYSTAL RESONATOR(12.288MHZ)		
CP601,602			R90-0714-05	MULTI-COMP 10K X4		

L : Scandinavia K : USA P : Canada R : Mexico C : China I : Malaysia
 Y : PX(Far East,Hawaii) T : England E : Europe G : Germany V : China(Shanghai)
 Y : AAFES(Europe) X : Australia Q : Russia H : Korea M : Other Areas Δ indicates safety critical components .

* New Parts

Parts without **Parts No.** are not supplied.Les articles non mentionnés dans le **Parts No.** ne sont pas fournis.Teile ohne **Parts No.** werden nicht geliefert.

⑧

Ref. No	Add-ress	New Parts	Parts No.	Description	Desti-nation	Re-marks
CP603-605			R90-0728-05	MULTI-COMP 180 X4		
CP606-608			R90-0720-05	MULTI-COMP 100K X4		
R601,602			RK73GB1J221J	CHIP R 220	J	1/16W
R603,604			RK73GB1J105J	CHIP R 1.0M	J	1/16W
R605			RK73GB1J103J	CHIP R 10K	J	1/16W
R607			RK73GB1J471J	CHIP R 470	J	1/16W
R608			RK73GB1J221J	CHIP R 220	J	1/16W
R609			RK73GB1J104J	CHIP R 100K	J	1/16W
R610			RK73GB1J221J	CHIP R 220	J	1/16W
R611,612			RK73GB1J332J	CHIP R 3.3K	J	1/16W
R613,614			RK73GB1J221J	CHIP R 220	J	1/16W
R615			RK73GB1J101J	CHIP R 100	J	1/16W
R623			RK73GB1J103J	CHIP R 10K	J	1/16W
R624			RK73GB1J221J	CHIP R 220	J	1/16W
R625			RK73GB1J332J	CHIP R 3.3K	J	1/16W
R626			RK73GB1J472J	CHIP R 4.7K	J	1/16W
R627,628			RK73GB1J221J	CHIP R 220	J	1/16W
R629			RK73GB1J103J	CHIP R 10K	J	1/16W
R630			RK73GB1J333J	CHIP R 33K	J	1/16W
R631			RK73GB1J101J	CHIP R 100	J	1/16W
R632,633			RK73GB1J472J	CHIP R 4.7K	J	1/16W
R634			RK73GB1J471J	CHIP R 470	J	1/16W
R635			RK73GB1J820J	CHIP R 82	J	1/16W
R637,638			RK73GB1J220J	CHIP R 22	J	1/16W
R639			RK73GB1J183J	CHIP R 18K	J	1/16W
R640,641			RK73GB1J4R7J	CHIP R 4.7	J	1/16W
R642			RK73GB1J220J	CHIP R 22	J	1/16W
R644			RK73GB1J820J	CHIP R 82	J	1/16W
R663			RK73GB1J221J	CHIP R 220	J	1/16W
R664			R92-1993-05	METAL GLAZE 560	J	1/4W
R665			RK73GB1J223J	CHIP R 22K	J	1/16W
R666			RS14KB3D180J	FL-PROOF RS 18	J	2W
R670			RD14NB2E4R7J	RD 4.7	J	1/4W
R671			RD14NB2E1R0J	RD 1	J	1/4W
R672			RK73GB1J221J	CHIP R 220	J	1/16W
R673			RK73GB1J473J	CHIP R 47K	J	1/16W
R674			RK73GB1J472J	CHIP R 4.7K	J	1/16W
R675			RK73GB1J221J	CHIP R 220	J	1/16W
R676			RK73GB1J102J	CHIP R 1.0K	J	1/16W
R677			RK73GB1J152J	CHIP R 1.5K	J	1/16W
R678,679			RK73GB1J220J	CHIP R 22	J	1/16W
R680			RK73GB1J471J	CHIP R 470	J	1/16W
R683,684			RK73GB1J471J	CHIP R 470	J	1/16W
R685			R92-1945-05	METAL GLAZE 1	J	1/4W
R689			RK73GB1J220J	CHIP R 22	J	1/16W
R690			RK73GB1J471J	CHIP R 470	J	1/16W
R691			RD14NB2E4R7J	RD 4.7	J	1/4W
R692			RK73GB1J220J	CHIP R 22	J	1/16W
R701,702			RK73GB1J222J	CHIP R 2.2K	J	1/16W
R703,704			RK73GB1J104J	CHIP R 100K	J	1/16W
R705,706			RK73GB1J222J	CHIP R 2.2K	J	1/16W
R707,708			RK73GB1J103J	CHIP R 10K	J	1/16W
R709,710			RK73GB1J472J	CHIP R 4.7K	J	1/16W
R711,712			RK73GB1J332J	CHIP R 3.3K	J	1/16W
R713,714			RK73GB1J104J	CHIP R 100K	J	1/16W

L : Scandinavia K : USA P : Canada R : Mexico C : China I : Malaysia
 Y : PX(Far East,Hawaii) T : England E : Europe G : Germany V : China(Shanghai)
 Y : AAFES(Europe) X : Australia Q : Russia H : Korea M : Other Areas Δ indicates safety critical components .

PARTS LIST

KRF-V4060D/V5060D/V5560D/VR-605/615

* New Parts

Parts without **Parts No.** are not supplied.

Les articles non mentionnés dans le **Parts No.** ne sont pas fournis.

Teile ohne **Parts No.** werden nicht geliefert.



Ref. No	Add-ress	New Parts	Parts No.	Description	Desti-nation	Re-marks
R715,716			RK73GB1J222J	CHIP R 2.2K J 1/16W		
R717,718			RK73GB1J272J	CHIP R 2.7K J 1/16W		
R719,720			RK73GB1J562J	CHIP R 5.6K J 1/16W		
R721			RK73GB1J222J	CHIP R 2.2K J 1/16W		
R722			RK73GB1J153J	CHIP R 15K J 1/16W		
R723,724			RK73GB1J104J	CHIP R 100K J 1/16W		
R725			RK73GB1J222J	CHIP R 2.2K J 1/16W		
R726			RK73GB1J183J	CHIP R 18K J 1/16W		
R727,728			RK73GB1J103J	CHIP R 10K J 1/16W		
R729			RK73GB1J472J	CHIP R 4.7K J 1/16W		
R730			RK73GB1J562J	CHIP R 5.6K J 1/16W		
R735-740			RK73GB1J103J	CHIP R 10K J 1/16W		
R741-744			RK73GB1J221J	CHIP R 220 J 1/16W		
R745			RK73GB1J102J	CHIP R 1.0K J 1/16W		
R746-748			RK73GB1J101J	CHIP R 100 J 1/16W		
R749,750			RK73GB1J272J	CHIP R 2.7K J 1/16W		
R751			RK73GB1J472J	CHIP R 4.7K J 1/16W		
R752			RK73GB1J562J	CHIP R 5.6K J 1/16W		
R753			RK73GB1J472J	CHIP R 4.7K J 1/16W		
R754			RK73GB1J562J	CHIP R 5.6K J 1/16W		
R756-758			RK73GB1J181J	CHIP R 180 J 1/16W		
R759-761			RK73GB1J104J	CHIP R 100K J 1/16W		
R791,792			RK73GB1J183J	CHIP R 18K J 1/16W		
S601			S62-0034-05	SLIDE SWITCH	YM	
D601			MA111	DIODE		
D602			DAN202U	DIODE		
D602			MA142WK	DIODE		
D602			1SS301	DIODE		
D603			DAP202U	DIODE		
D603			MA142WA	DIODE		
D603			1SS300	DIODE		
D604			HZU3.9(B2)	ZENER DIODE		
D604			UDZ3.9B	ZENER DIODE		
D605			DAN202U	DIODE		
D605			MA142WK	DIODE		
D605			1SS301	DIODE		
D606,607			HZU5.6(B2)	ZENER DIODE		
D606,607			UDZ5.6B	ZENER DIODE		
D608			MA111	DIODE		
Δ D609			D2SBA20F03	DIODE		
D610			HZU5.1(B2)	ZENER DIODE		
D610			UDZ5.1B	ZENER DIODE		
D611-614			MA111	DIODE		
IC601		*	CS493264-CLR	MOS-IC		
IC602		*	AK4586	MOS-IC		
IC603			TC7WU04FU	MOS-IC		
IC604			TC7WH123FU	MOS-IC		
IC605			TC74HCT7007AF	MOS-IC		
IC606			TC74HC07AF	MOS-IC		
IC609			XC62EP2502MR	ANALOGUE IC		
IC611			BA033LBSG	ANALOGUE IC		
IC612			BA05T	ANALOGUE IC		
IC701-703			NJM4565MD	IC(OP AMP X2)		
IC705			NJU7311AM	MOS-IC		

L : Scandinavia K : USA P : Canada R : Mexico C : China I : Malaysia
 Y : PX(Far East,Hawaii) T : England E : Europe G : Germany V : China(Shanghai)
 Y : AAFES(Europe) X : Australia Q : Russia H : Korea M : Other Areas Δ indicates safety critical components .

* New Parts

Parts without **Parts No.** are not supplied.

Les articles non mentionnés dans le **Parts No.** ne sont pas fournis.

Teile ohne **Parts No.** werden nicht geliefert.



Ref. No	Add-ress	New Parts	Parts No.	Description	Desti-nation	Re-marks
IC707			NJM4565MD	IC(OP AMP X2)		
Q601,602			DTC124EUA	DIGITAL TRANSISTOR		
Q601,602			UN5212	DIGITAL TRANSISTOR		
Q606			2SB1375	TRANSISTOR		
Q608			2SC4081(R,S)	TRANSISTOR		
Q608			2SD1819A(Q,R)	TRANSISTOR		
Q609			2SA1576A(R,S)	TRANSISTOR		
Q609			2SB1218A(Q,R)	TRANSISTOR		
A601			W02-2802-05	OPTIC RECEIVING MODULE		
AUDIO (X09-6600-10)						
C1 ,2			CE04LW2A100M	ELECTRO 10UF 100WV		
C101			CC45FSL1H331J	CERAMIC 330PF J	EE1E2	
C101			CC45FSL1H331J	CERAMIC 330PF J	E3TT1	
C102			CC45FSL1H101J	CERAMIC 100PF J	EE1E2	
C102			CC45FSL1H101J	CERAMIC 100PF J	E3TT1	
C103,104			CC45FCH1H270J	CERAMIC 27PF J	EE1E2	
C103,104			CC45FCH1H270J	CERAMIC 27PF J	E3TT1	
C105			CE04KW1H2R2M	ELECTRO 2.2UF 50WV	EE1E2	
C105			CE04KW1H2R2M	ELECTRO 2.2UF 50WV	E3TT1	
C106			CK45FF1H103Z	CERAMIC 0.010UF Z	EE1E2	
C106			CK45FF1H103Z	CERAMIC 0.010UF Z	E3TT1	
C107			CE04KW1A470M	ELECTRO 47UF 10WV	EE1E2	
C107			CE04KW1A470M	ELECTRO 47UF 10WV	E3TT1	
C108			CK45FB1H561K	CERAMIC 560PF K	EE1E2	
C108			CK45FB1H561K	CERAMIC 560PF K	E3TT1	
C109			CK45FF1H103Z	CERAMIC 0.010UF Z	EE1E2	
C109			CK45FF1H103Z	CERAMIC 0.010UF Z	E3TT1	
C110			CK45FF1H103Z	CERAMIC 0.010UF Z		
C125			CE04KW1H100M	ELECTRO 10UF 50WV		
C126			CK45FF1H103Z	CERAMIC 0.010UF Z		
C127			CC45FSL1H270J	CERAMIC 27PF J		
C128			CE04KW1H100M	ELECTRO 10UF 50WV		
C129			CE04KW1E332M	ELECTRO 3300UF 25WV		
Δ C130			C91-1488-05	MF 6800PF 250VAC		
C131			CK45FF1H103Z	CERAMIC 0.010UF Z		
Δ C132			C91-1635-05	FILM 0.068UF 275WV		
C133			CE04KW1H100M	ELECTRO 10UF 50WV		
C134			CE04KW1J330M	ELECTRO 33UF 63WV		
C135			CC45FSL1H100D	CERAMIC 10PF D		
C137			CK45FF1H103Z	CERAMIC 0.010UF Z		
Δ C138,139			CE04KW1E101M	ELECTRO 100UF 25WV		
C140			CE04KW1E222M	ELECTRO 2200UF 25WV		
C141			CE04KW1E471M	ELECTRO 470UF 25WV		
C142,143		*	C90-5747-05	ELECTRO 4700UF 75WV		5
C144,145		*	C90-5746-05	ELECTRO 3300UF 42WV		5
C146,147			C91-1422-05	MP 0.10UF 250WV		5
C148-151			C91-1573-05	MP-C 0.10UF J		
C152,153			C91-1422-05	MP 0.10UF 250WV		
C154,155			CQ93FMG1H104J	MYLAR 0.10UF J		
C156			CC45FSL1H330J	CERAMIC 33PF J		
C157			CC45FSL1H270J	CERAMIC 27PF J		
C201,202			CC45FSL1H221J	CERAMIC 220PF J		
C203,204			CE04KW1H100M	ELECTRO 10UF 50WV	EE1E3	5
C203,204			CE04KW1H100M	ELECTRO 10UF 50WV	TT1	5

L : Scandinavia K : USA P : Canada R : Mexico C : China I : Malaysia
 Y : PX(Far East,Hawaii) T : England E : Europe G : Germany V : China(Shanghai)
 Y : AAFES(Europe) X : Australia Q : Russia H : Korea M : Other Areas Δ indicates safety critical components .

PARTS LIST

KRF-V4060D/V5060D/V5560D/NR-605/615

* New Parts

Parts without **Parts No.** are not supplied.Les articles non mentionnés dans le **Parts No.** ne sont pas fournis.Teile ohne **Parts No.** werden nicht geliefert.

11

Ref. No	Add-ress	New Parts	Parts No.	Description	Desti-nation	Re-marks
C205-208			CC45FSL1H221J	CERAMIC 220PF	J	EE1E3 5
C205-208			CC45FSL1H221J	CERAMIC 220PF	J	TT1 5
C209,210			CE04KW1A101M	ELECTRO 100UF	10WV	EE1E3 5
C209,210			CE04KW1A101M	ELECTRO 100UF	10WV	TT1 5
C211,212			CQ93FMG1H123J	MYLAR 0.012UF	J	EE1E3 5
C211,212			CQ93FMG1H123J	MYLAR 0.012UF	J	TT1 5
C213,214			CK45FB1H332K	CERAMIC 3300PF	K	EE1E3 5
C213,214			CK45FB1H332K	CERAMIC 3300PF	K	TT1 5
C215,216			CE04KW1H4R7M	ELECTRO 4.7UF	50WV	EE1E3 5
C215,216			CE04KW1H4R7M	ELECTRO 4.7UF	50WV	TT1 5
C217-219			CC45FSL1H101J	CERAMIC 100PF	J	EE1E3 5
C217-219			CC45FSL1H101J	CERAMIC 100PF	J	TT1 5
C220			CK45FF1H103Z	CERAMIC 0.010UF	Z	EE1E3 5
C220			CK45FF1H103Z	CERAMIC 0.010UF	Z	TT1 5
C221,222			CC45FSL1H221J	CERAMIC 220PF	J	
C225,226			CC45FSL1H221J	CERAMIC 220PF	J	
C229,230			CC45FSL1H221J	CERAMIC 220PF	J	
C233,234			CC45FSL1H221J	CERAMIC 220PF	J	
C237,238			CC45FSL1H221J	CERAMIC 220PF	J	
C241,242			CC45FSL1H221J	CERAMIC 220PF	J	
C245,246			CC45FSL1H221J	CERAMIC 220PF	J	
C251,252			CC45FSL1H221J	CERAMIC 220PF	J	EE1E3 5
C251,252			CC45FSL1H221J	CERAMIC 220PF	J	TT1YMX 5
C255,256			CC45FSL1H221J	CERAMIC 220PF	J	EE1E3 5
C255,256			CC45FSL1H221J	CERAMIC 220PF	J	TT1YMX 5
C259,260			CC45FSL1H221J	CERAMIC 220PF	J	EE1E3 5
C259,260			CC45FSL1H221J	CERAMIC 220PF	J	TT1YMX 5
C265,266			CE04RW1H4R7M	ELECTRO 4.7UF	50WV	
C268-271			CC45FSL1H101J	CERAMIC 100PF	J	
C272			CE04KW1H2R2M	ELECTRO 2.2UF	50WV	
C273			CK45FB1H471K	CERAMIC 470PF	K	
C274			CC45FSL1H331J	CERAMIC 330PF	J	
C275			CE04KW1A470M	ELECTRO 47UF	10WV	
C276			CE04KW1A101M	ELECTRO 100UF	10WV	
C278			CE04KW1A101M	ELECTRO 100UF	10WV	
C279			CE04KW1A470M	ELECTRO 47UF	10WV	
C280			CE04KW1A101M	ELECTRO 100UF	10WV	
C281			CC45FSL1H101J	CERAMIC 100PF	J	
C283-288			CC45FSL1H101J	CERAMIC 100PF	J	
C290-300			CC45FSL1H101J	CERAMIC 100PF	J	
C301,302			CE04KW1H2R2M	ELECTRO 2.2UF	50WV	
C303,304			CK45FB1H471K	CERAMIC 470PF	K	
C305			CK45FB1H391K	CERAMIC 390PF	K	
C306			CC45FSL1H331J	CERAMIC 330PF	J	
C307			CE04KW1H101M	ELECTRO 100UF	50WV	
C308			CQ93FMG1H473J	MYLAR 0.047UF	J	
C309,310			CE04KW1A101M	ELECTRO 100UF	10WV	
C311			CE04RW1V4R7M	ELECTRO 4.7UF	35WV	
C312			CQ93FMG1H473J	MYLAR 0.047UF	J	
C313			CC45FSL1H101J	CERAMIC 100PF	J	
C316,317			CC45FSL1H100D	CERAMIC 10PF	D	
C318			CE04KW1H101M	ELECTRO 100UF	50WV	
C319,320			CE04KW2A101M	ELECTRO 100UF	100WV	
C321,322			CK45FF1H472Z	CERAMIC 4700PF	Z	
C323-328			C91-1573-05	MP-C 0.10UF	J	

L: Scandinavia K: USA P: Canada R: Mexico C: China I: Malaysia
 Y: PX(Far East,Hawaii) T: England E: Europe G: Germany V: China(Shanghai)
 Y: AAFES(Europe) X: Australia Q: Russia H: Korea M: Other Areas Δ indicates safety critical components.

* New Parts

Parts without **Parts No.** are not supplied.Les articles non mentionnés dans le **Parts No.** ne sont pas fournis.Teile ohne **Parts No.** werden nicht geliefert.

12

Ref. No	Add-ress	New Parts	Parts No.	Description	Desti-nation	Re-marks
C329			CK45FF1H472Z	CERAMIC 4700PF	Z	
C330			CC45FSL1H100D	CERAMIC 10PF	D	
C332			CE04KW1A101M	ELECTRO 100UF	10WV	
C333			CE04KW1H4R7M	ELECTRO 4.7UF	50WV	
C334			CE04KW1H010M	ELECTRO 1.0UF	50WV	
C335			CE04LW1H100M	ELECTRO 10UF	50WV	
C336			CE04KW1A221M	ELECTRO 220UF	10WV	
C337			CE04HW1E100M	NP-ELEC 10UF	25WV	
C338			CE04KW1E470M	ELECTRO 47UF	25WV	
C339-349			CC45FSL1H101J	CERAMIC 100PF	J	
C350			CQ93FMG1H122J	MYLAR 1200PF	J	
C351			CQ93FMG1H332J	MYLAR 3300PF	J	
C352,353			CE04KW1H2R2M	ELECTRO 2.2UF	50WV	
C354			CK45FB1H471K	CERAMIC 470PF	K	
C355,356			CK45FB1H102K	CERAMIC 1000PF	K	
C357			CE04KW1H2R2M	ELECTRO 2.2UF	50WV	
C358			CQ93FMG1H104J	MYLAR 0.10UF	J	
C359-364			CE04KW1H4R7M	ELECTRO 4.7UF	50WV	
C365-370			CE04KW1H2R2M	ELECTRO 2.2UF	50WV	
C371			CQ93FMG1H104J	MYLAR 0.10UF	J	
C372			CQ93FMG1H332J	MYLAR 3300PF	J	
C373,374			CQ93FMG1H104J	MYLAR 0.10UF	J	
C375			CK45FF1H103Z	CERAMIC 0.010UF	Z	
C376,377			CE04LW1H220M	ELECTRO 22UF	50WV	
C378			CE04KW1H010M	ELECTRO 1.0UF	50WV	
C380			CE04RW1V4R7M	ELECTRO 4.7UF	35WV	
C384-386			CK45FB1H471K	CERAMIC 470PF	K	
C401			CE04KW1A101M	ELECTRO 100UF	10WV	
C403,404			CE04KW2A100M	ELECTRO 10UF	100WV	
C405			CC45FSL1H470J	CERAMIC 47PF	J	
C406,407			CE04KW1H2R2M	ELECTRO 2.2UF	50WV	
C408,409			CK45FB1H471K	CERAMIC 470PF	K	
C410,411			CC45FSL1H331J	CERAMIC 330PF	J	
C412,413			CE04KW1A101M	ELECTRO 100UF	10WV	
C416,417			CC45FSL1H100D	CERAMIC 10PF	D	
C424,425			CK45FF1H472Z	CERAMIC 4700PF	Z	
C426-429			C91-1573-05	MP-C 0.10UF	J	
C439-443			CK45FB1H222K	CERAMIC 2200PF	K	
C444			CC45FSL1H221J	CERAMIC 220PF	J	
C445			CC45FSL1H560J	CERAMIC 56PF	J	
C638-642			CC45FSL1H470J	CERAMIC 47PF	J	
C643-645			CE04KW1E470M	ELECTRO 47UF	25WV	
C648			CE04RW1C100M	ELECTRO 10UF	16WV	
C652			CE04RW1C100M	ELECTRO 10UF	16WV	
C826,827			CK45FB1H471K	CERAMIC 470PF	K	
CN101			E40-8481-05	FLAT CABLE CONNECTOR		
CN102			E40-8502-05	FLAT CABLE CONNECTOR		
CN103			E40-8481-05	FLAT CABLE CONNECTOR		
CN104			E40-4428-05	PIN ASSY	YM	
CN105			E40-4245-05	PIN ASSY		
CN112			E40-4245-05	PIN ASSY	EE1E3	
CN112			E40-4245-05	PIN ASSY	TT1KPX	
CN114			E40-3262-05	PIN ASSY		
CN115			E40-4245-05	PIN ASSY		
CN115			E40-4245-05	PIN ASSY	EE1E3	4 5

L: Scandinavia K: USA P: Canada R: Mexico C: China I: Malaysia
 Y: PX(Far East,Hawaii) T: England E: Europe G: Germany V: China(Shanghai)
 Y: AAFES(Europe) X: Australia Q: Russia H: Korea M: Other Areas Δ indicates safety critical components.

PARTS LIST

KRF-V4060D/V5060D/V5560D/VR-605/615

* New Parts

Parts without **Parts No.** are not supplied.

Les articles non mentionnés dans le **Parts No.** ne sont pas fournis.

Teile ohne **Parts No.** werden nicht geliefert.

13

Ref. No	Add-ress	New Parts	Parts No.	Description	Desti-nation	Re-marks
CN115			E40-4245-05	PIN ASSY	TT1YMX	
CN118			E40-4245-05	PIN ASSY	YM	
CN201		*	E40-8482-05	FLAT CABLE CONNECTOR		
CN806		*	E40-3247-05	PIN ASSY		
J201		*	E63-1256-05	PIN JACK		
J202		*	E63-1258-05	PIN JACK	EE1E3	5
J203		*	E63-1256-05	PIN JACK	TT1YMX	5
J203		*	E63-1256-05	PIN JACK		4
J203		*	E63-1258-05	PIN JACK	KP	5
J203		*	E63-1258-05	PIN JACK		
J204			E63-1260-05	PIN JACK	EE1E3	5
J204			E63-1260-05	PIN JACK	TT1YMX	5
J205			E03-0148-05	AC OUTLET	KPY	5
J206			E03-0149-05	AC OUTLET	EE1E2	
J206			E03-0149-05	AC OUTLET	E3M	
J206			E03-0310-05	AC OUTLET	TT1	
J206			E03-0325-05	AC OUTLET	XX	
J401		*	E70-0156-05	LOCK TERMINAL BOARD		
J402		*	E70-0155-05	LOCK TERMINAL BOARD		
J404			E63-1146-05	PIN JACK		
J603		*	E63-1254-05	PIN JACK		
J604		*	E63-1255-05	PIN JACK		
J801			E11-0271-05	PHONE JACK (METAL SLEEVE)		
F101			F05-2525-05	FUSE (SEMKO) (250V T2.5AL)		4
F101			F05-3121-05	FUSE (SEMKO) (250V T3.15AL)	EE1E3	5
F101			F05-3121-05	FUSE (SEMKO) (250V T3.15AL)	TT1YMX	
F101			F50-0077-05	FUSE(5X20)	KP	
F102			F06-1022-05	FUSE (SEMKO) (250V T1AL)		4
F102			F06-1022-05	FUSE (SEMKO) (250V T1AL)	EE1E3	5
F102			F06-1022-05	FUSE (SEMKO) (250V T1AL)	TT1MX	5
F103			F05-2525-05	FUSE (SEMKO) (250V T2.5AL)	M	4
F103			F05-3121-05	FUSE (SEMKO) (250V T3.15AL)	YM	5
CN108,109			J13-0075-05	FUSE CLIP	EE1E3	
CN108,109			J13-0075-05	FUSE CLIP	TT1MX	
CN110,111			J13-0075-05	FUSE CLIP		
CN116,117			J13-0075-05	FUSE CLIP	YM	
E11 -14			J11-0809-05	WIRE CLAMPER		
L301-303			L39-1373-05	PHASE COMPENSATION COIL		
L401,402			L39-1373-05	PHASE COMPENSATION COIL		
T101			L07-2758-05	POWER TRANSFORMER	EE1E2	
T101			L07-2758-05	POWER TRANSFORMER	E3TT1	
T101			L07-2758-05	POWER TRANSFORMER	KPX	
T101			L07-2761-05	POWER TRANSFORMER	EE1E2	
T101			L07-2761-05	POWER TRANSFORMER	E3TT1	
T101			L07-2761-05	POWER TRANSFORMER	KPX	
T101			L07-2805-05	POWER TRANSFORMER	YM	
X101			L77-2002-05	CRYSTAL RESONATOR(4.332MHZ)	EE1E2	
X101			L77-2002-05	CRYSTAL RESONATOR(4.332MHZ)	E3TT1	
R123			RD14NB2E1R0J	RD 1 1/4W		
R124			RS14KB3A221J	FL-PROOF RS 220 J 1W		
R125			RD14NB2E270J	RD 27 J 1/4W		
R126			RD14NB2E101J	RD 100 J 1/4W		
R127			RD14NB2E822J	RD 8.2K J 1/4W		

L : Scandinavia K : USA P : Canada R : Mexico C : China I : Malaysia
 Y : PX(Far East,Hawaii) T : England E : Europe G : Germany V : China(Shanghai)
 Y : AAFES(Europe) X : Australia Q : Russia H : Korea M : Other Areas Δ indicates safety critical components .

* New Parts

Parts without **Parts No.** are not supplied.

Les articles non mentionnés dans le **Parts No.** ne sont pas fournis.

Teile ohne **Parts No.** werden nicht geliefert.

14

Ref. No	Add-ress	New Parts	Parts No.	Description	Desti-nation	Re-marks
R132			R92-1844-05	CARBON 3.3M J 1/2W	KP	
R141,142			RD14NB2E1R0J	RD 1 J 1/4W		
R213,214			RD14BB2C102J	RD 1.0K J 1/6W	EE1E3	5
R316,317			RS14KB3A472J	FL-PROOF RS 4.7K J 1W		
R334,335			RD14NB2E4R7J	RD 4.7 J 1/4W		
R338-341			RS14KB3DR22J	FL-PROOF RS 0.22 J 2W		
R342,343			RS14KB3D4R7J	FL-PROOF RS 4.7 J 2W		
R345			RS14KB3D4R7J	FL-PROOF RS 4.7 J 2W		
R347			RD14NB2E4R7J	RD 4.7 J 1/4W		
R348,349			RS14KB3DR22J	FL-PROOF RS 0.22 J 2W		
R365			RD14NB2E561J	RD 560 J 1/4W		
R410			RD14NB2E103J	RD 10K J 1/4W		
R411			RD14NB2E101J	RD 100 J 1/4W		
R414			RD14NB2E101J	RD 100 J 1/4W		
R415			RD14NB2E103J	RD 10K J 1/4W		
R438,439			RS14KB3D391J	FL-PROOF RS 390 J 2W		
R452,453			RS14KB3A472J	FL-PROOF RS 4.7K J 1W		
R460-463			RS14KB3DR22J	FL-PROOF RS 0.22 J 2W		
R466,467			RD14NB2E4R7J	RD 4.7 J 1/4W		
R468,469			RS14KB3D4R7J	FL-PROOF RS 4.7 J 2W		
R478-480			RS14KB3A151J	FL-PROOF RS 150 J 1W		
K101			S76-0099-05	MAGNETIC RELAY	KP	
K101			S76-0102-05	MAGNETIC RELAY	EE1E2	
K101			S76-0102-05	MAGNETIC RELAY	E3TT1	
K101			S76-0102-05	MAGNETIC RELAY	YM	
K401-403			S76-0097-05	MAGNETIC RELAY		
S101			1.5.S62	SLIDE SWITCH	YM	
S102			S68-0107-05	PUSH SWITCH	EE1E2	
S102			S68-0107-05	PUSH SWITCH	E3TT1	
S102			S68-0107-05	PUSH SWITCH	YM	
D113			RB441Q-40	DIODE		
D114-116			HSS104A	DIODE		
D114-116			1SS133	DIODE		
D117			S1ZB20(4101)	DIODE		
D118			HZS16N(B2)	ZENER DIODE		
D118			MTZJ16(B)	ZENER DIODE		
D119			HZS15N(B2)	ZENER DIODE		
D119			MTZJ15(B)	ZENER DIODE		
D120			D2SBA20F03	DIODE		
D121			D5SBA20F03	DIODE		
D122			D5SBA20F03	DIODE		
D123,124			HSS104A	DIODE	YM	
D123,124			1SS133	DIODE	YM	
D201			HZS6.8N(B2)	ZENER DIODE		
D201			MTZJ6.8(B)	ZENER DIODE		
D202			HZS5.1N(B2)	ZENER DIODE		
D202			MTZJ5.1(B)	ZENER DIODE		
D203			HZS6.8N(B2)	ZENER DIODE		
D203			MTZJ6.8(B)	ZENER DIODE		
D215			HSS104A	DIODE		
D215			1SS133	DIODE		
D301,302			HZS15N(B2)	ZENER DIODE		
D301,302			MTZJ15(B)	ZENER DIODE		
D303,304			HSS104A	DIODE		

L : Scandinavia K : USA P : Canada R : Mexico C : China I : Malaysia
 Y : PX(Far East,Hawaii) T : England E : Europe G : Germany V : China(Shanghai)
 Y : AAFES(Europe) X : Australia Q : Russia H : Korea M : Other Areas Δ indicates safety critical components .

PARTS LIST

KRF-V4060D/V5060D/V5560D/NR-605/615

* New Parts
 Parts without **Parts No.** are not supplied.
 Les articles non mentionnés dans le **Parts No.** ne sont pas fournis.
 Teile ohne **Parts No.** werden nicht geliefert.



Ref. No	Add-ress	New Parts	Parts No.	Description	Desti-nation	Re-marks
D303,304			1SS133	DIODE		
D305,306			HZS10N(B2)	ZENER DIODE	EE1E2	
D305,306			HZS10N(B2)	ZENER DIODE	E3TT1	
D305,306			HZS10N(B2)	ZENER DIODE	YMX	
D305,306			HZS11N(B2)	ZENER DIODE	KP	
D305,306			MTZJ10(B)	ZENER DIODE	EE1E2	
D305,306			MTZJ10(B)	ZENER DIODE	E3TT1	
D305,306			MTZJ10(B)	ZENER DIODE	YMX	
D305,306			MTZJ11(B)	ZENER DIODE	KP	
D307			HZS3.9N(B2)	ZENER DIODE		
D307			MTZJ3.9(B)	ZENER DIODE		
D308-310			HSS104A	DIODE		
D308-310			1SS133	DIODE		
D311,312			HZS3.9N(B2)	ZENER DIODE		
D311,312			MTZJ3.9(B)	ZENER DIODE		
D313			HSS104A	DIODE		
D313			1SS133	DIODE		
D314			HZS3.9N(B2)	ZENER DIODE		
D314			MTZJ3.9(B)	ZENER DIODE		
D315			HSS104A	DIODE		
D315			1SS133	DIODE		
D316			HZS3.9N(B2)	ZENER DIODE		
D316			MTZJ3.9(B)	ZENER DIODE		
D317,318			HSS104A	DIODE		
D317,318			1SS133	DIODE		
D319			HZS11N(B2)	ZENER DIODE	EE1E3	5
D319			HZS11N(B2)	ZENER DIODE	TT1	5
D319			MTZJ11(B)	ZENER DIODE	EE1E3	5
D319			MTZJ11(B)	ZENER DIODE	TT1	5
D319,320			HZS15N(B2)	ZENER DIODE	KPYMX	5
D319,320			MTZJ15(B)	ZENER DIODE	KPYMX	5
D320			HZS13N(B2)	ZENER DIODE	EE1E3	5
D320			HZS13N(B2)	ZENER DIODE	TT1	5
D320			MTZJ13(B)	ZENER DIODE	EE1E3	5
D320			MTZJ13(B)	ZENER DIODE	TT1	5
D401,402			HZS15N(B2)	ZENER DIODE		5
D401,402			MTZJ15(B)	ZENER DIODE		5
D403,404			HSS104A	DIODE		
D403,404			1SS133	DIODE		
D406-408			HSS104A	DIODE		
D406-408			1SS133	DIODE		
D602,603			HZS5.6N(B2)	ZENER DIODE		
D602,603			MTZJ5.6(B)	ZENER DIODE		
D999			HSS104A	DIODE		
D999			1SS133	DIODE		
IC101			BU1923	ANALOGUE IC	EE1E2	
IC101			BU1923	ANALOGUE IC	E3TT1	
IC105			BA05T	ANALOGUE IC		
IC106			KIA7812API	ANALOGUE IC		
IC107			KIA7912PI	ANALOGUE IC		
IC201			NJM4580L-D	ANALOGUE IC	EE1E3	5
IC201			NJM4580L-D	ANALOGUE IC	TT1	5
IC202			M61516FP	ANALOGUE IC		
IC206			NJM4565D	ANALOGUE IC		
IC301			STK413-020A	HYBRID IC		5

L : Scandinavia K : USA P : Canada R : Mexico C : China I : Malaysia
 Y : PX(Far East,Hawaii) T : England E : Europe G : Germany V : China(Shanghai)
 Y : AAFES(Europe) X : Australia Q : Russia H : Korea M : Other Areas Δ indicates safety critical components.

* New Parts
 Parts without **Parts No.** are not supplied.
 Les articles non mentionnés dans le **Parts No.** ne sont pas fournis.
 Teile ohne **Parts No.** werden nicht geliefert.



Ref. No	Add-ress	New Parts	Parts No.	Description	Desti-nation	Re-marks
IC301		*	STK413-220A	HYBRID IC		5
IC301			STK443-070	HYBRID IC		4
IC401			STK412-020A	HYBRID IC		5
IC401		*	STK412-220A	HYBRID IC		5
IC401		*	STK442-070	HYBRID IC		4
IC607			NJM2279D	ANALOGUE IC		
Q113			2SB1640	TRANSISTOR		
Q114			2SC1740S(Q,R)	TRANSISTOR		
Q114			2SC2785(F,E)	TRANSISTOR		
Q201			2SC1845(F,E)	TRANSISTOR		
Q203			2SA992(F,E)	TRANSISTOR		
Q301-306			2SC2878(B)	TRANSISTOR		
Q307,308			2SA992(F,E)	TRANSISTOR		
Q309-315			2SC1845(F,E)	TRANSISTOR		
Q316			2SA992(F,E)	TRANSISTOR		
Q317,318			2SC2878(B)	TRANSISTOR		
Q319			2SA992(F,E)	TRANSISTOR		
Q401			2SC1845(F,E)	TRANSISTOR		
Q402			2SA1535A	TRANSISTOR		
Q403			2SC3944A	TRANSISTOR		
Q404			2SC1845(F,E)	TRANSISTOR		
Q405			2SA992(F,E)	TRANSISTOR		
Q406			2SB1640	TRANSISTOR		
Q407,408			2SC1845(F,E)	TRANSISTOR		
Q410,411			DTC113ZSA	DIGITAL TRANSISTOR		
Q410,411			UN4219	DIGITAL TRANSISTOR		
Q412			2SC1740S(Q,R)	TRANSISTOR		
Q412			2SC2785(F,E)	TRANSISTOR		
AUDIO (X09-6610-10)						
C1_2			CE04LW2A100M	ELECTRO	10UF	100WV
C101			CC45FSL1H331J	CERAMIC	330PF	J
C102			CC45FSL1H101J	CERAMIC	100PF	J
C103,104			CC45FCH1H270J	CERAMIC	27PF	J
C105			CE04KW1H2R2M	ELECTRO	2.2UF	50WV
C106			CK45FF1H103Z	CERAMIC	0.010UF	Z
C107			CE04KW1A470M	ELECTRO	47UF	10WV
C108			CK45FB1H561K	CERAMIC	560PF	K
C109			CK45FF1H103Z	CERAMIC	0.010UF	Z
C110			CK45FF1H103Z	CERAMIC	0.010UF	Z
C125			CE04KW1H100M	ELECTRO	10UF	50WV
C126			CK45FF1H103Z	CERAMIC	0.010UF	Z
C127			CC45FSL1H270J	CERAMIC	27PF	J
C128			CE04KW1H100M	ELECTRO	10UF	50WV
C129			CE04KW1E332M	ELECTRO	3300UF	25WV
C130			C91-1488-05	MF	6800PF	250VAC
C131			CK45FF1H103Z	CERAMIC	0.010UF	Z
C132			C91-1635-05	FILM	0.068UF	275WV
C133			CE04KW1H100M	ELECTRO	10UF	50WV
C134			CE04KW1J330M	ELECTRO	33UF	63WV
C135			CC45FSL1H100D	CERAMIC	10PF	D
C137			CK45FF1H103Z	CERAMIC	0.010UF	Z
C138,139			CE04KW1E101M	ELECTRO	100UF	25WV
C140			CE04KW1E222M	ELECTRO	2200UF	25WV
C141			CE04KW1E471M	ELECTRO	470UF	25WV

L : Scandinavia K : USA P : Canada R : Mexico C : China I : Malaysia
 Y : PX(Far East,Hawaii) T : England E : Europe G : Germany V : China(Shanghai)
 Y : AAFES(Europe) X : Australia Q : Russia H : Korea M : Other Areas Δ indicates safety critical components.

* New Parts

Parts without **Parts No.** are not supplied.

Les articles non mentionnés dans le **Parts No.** ne sont pas fournis.

Teile ohne **Parts No.** werden nicht geliefert.



Ref. No	Add-ress	New Parts	Parts No.	Description	Desti-nation	Re-marks
C142,143			C90-5747-05	ELECTRO 4700UF	75WV	
C144,145			C90-5746-05	ELECTRO 3300UF	42WV	
C146,147			C91-1422-05	MP 0.10UF	250WV	
C148-151			C91-1573-05	MP-C 0.10UF	J	
C156			CC45FSL1H330J	CERAMIC 33PF	J	
C157			CC45FSL1H270J	CERAMIC 27PF	J	
C201,202			CC45FSL1H221J	CERAMIC 220PF	J	
C221,222			CC45FSL1H221J	CERAMIC 220PF	J	
C225,226			CC45FSL1H221J	CERAMIC 220PF	J	
C229,230			CC45FSL1H221J	CERAMIC 220PF	J	
C233,234			CC45FSL1H221J	CERAMIC 220PF	J	
C237,238			CC45FSL1H221J	CERAMIC 220PF	J	
C241,242			CC45FSL1H221J	CERAMIC 220PF	J	
C245,246			CC45FSL1H221J	CERAMIC 220PF	J	
C251,252			CC45FSL1H221J	CERAMIC 220PF	J	KP
C255,256			CC45FSL1H221J	CERAMIC 220PF	J	KP
C259,260			CC45FSL1H221J	CERAMIC 220PF	J	KP
C265,266			CE04RW1H4R7M	ELECTRO 4.7UF	50WV	
C268-271			CC45FSL1H101J	CERAMIC 100PF	J	
C272			CE04KW1H2R2M	ELECTRO 2.2UF	50WV	
C273			CK45FB1H471K	CERAMIC 470PF	K	
C274			CC45FSL1H331J	CERAMIC 330PF	J	
C275			CE04KW1A470M	ELECTRO 47UF	10WV	
C276			CE04KW1A101M	ELECTRO 100UF	10WV	
C278			CE04KW1A101M	ELECTRO 100UF	10WV	
C279			CE04KW1A470M	ELECTRO 47UF	10WV	
C280			CE04KW1A101M	ELECTRO 100UF	10WV	
C281			CC45FSL1H101J	CERAMIC 100PF	J	
C283-288			CC45FSL1H101J	CERAMIC 100PF	J	
C290-300			CC45FSL1H101J	CERAMIC 100PF	J	
C301,302			CE04KW1H2R2M	ELECTRO 2.2UF	50WV	
C303,304			CK45FB1H471K	CERAMIC 470PF	K	
C305			CK45FB1H391K	CERAMIC 390PF	K	
C306			CC45FSL1H331J	CERAMIC 330PF	J	
C307			CE04KW1H101M	ELECTRO 100UF	50WV	
C308			CQ93FMG1H473J	MYLAR 0.047UF	J	
C309,310			CE04KW1A101M	ELECTRO 100UF	10WV	
C311			CE04RW1V4R7M	ELECTRO 4.7UF	35WV	
C312			CQ93FMG1H473J	MYLAR 0.047UF	J	
C313			CC45FSL1H101J	CERAMIC 100PF	J	
C316,317			CC45FSL1H100D	CERAMIC 10PF	D	
C318			CE04KW1H101M	ELECTRO 100UF	50WV	
C319,320			CE04KW2A101M	ELECTRO 100UF	100WV	
C321,322			CK45FF1H472Z	CERAMIC 4700PF	Z	
C323-328			C91-1573-05	MP-C 0.10UF	J	
C329			CK45FF1H472Z	CERAMIC 4700PF	Z	
C330			CC45FSL1H100D	CERAMIC 10PF	D	
C332			CE04KW1A101M	ELECTRO 100UF	10WV	
C333			CE04KW1H4R7M	ELECTRO 4.7UF	50WV	
C334			CE04KW1H010M	ELECTRO 1.0UF	50WV	
C335			CE04LW1H100M	ELECTRO 10UF	50WV	
C336			CE04KW1A221M	ELECTRO 220UF	10WV	
C337			CE04HW1E100M	NP-ELEC 10UF	25WV	
C338			CE04KW1E470M	ELECTRO 47UF	25WV	
C339-349			CC45FSL1H101J	CERAMIC 100PF	J	

L: Scandinavia Y: PX(Far East,Hawaii) Y: AAFES(Europe) K: USA T: England X: Australia P: Canada E: Europe Q: Russia R: Mexico G: Germany H: Korea C: China V: China(Shanghai) M: Other Areas I: Malaysia A indicates safety critical components.

* New Parts

Parts without **Parts No.** are not supplied.

Les articles non mentionnés dans le **Parts No.** ne sont pas fournis.

Teile ohne **Parts No.** werden nicht geliefert.



Ref. No	Add-ress	New Parts	Parts No.	Description	Desti-nation	Re-marks
C350			CQ93FMG1H122J	MYLAR 1200PF	J	
C351			CQ93FMG1H332J	MYLAR 3300PF	J	
C352,353			CE04KW1H2R2M	ELECTRO 2.2UF	50WV	
C354			CK45FB1H471K	CERAMIC 470PF	K	
C355,356			CK45FB1H102K	CERAMIC 1000PF	K	
C357			CE04KW1H2R2M	ELECTRO 2.2UF	50WV	
C358			CQ93FMG1H104J	MYLAR 0.10UF	J	
C359-364			CE04KW1H4R7M	ELECTRO 4.7UF	50WV	
C365-370			CE04KW1H2R2M	ELECTRO 2.2UF	50WV	
C371			CQ93FMG1H104J	MYLAR 0.10UF	J	
C372			CQ93FMG1H332J	MYLAR 3300PF	J	
C373,374			CQ93FMG1H104J	MYLAR 0.10UF	J	
C375			CK45FF1H103Z	CERAMIC 0.010UF	Z	
C376,377			CE04LW1H220M	ELECTRO 22UF	50WV	
C378			CE04KW1H010M	ELECTRO 1.0UF	50WV	
C380			CE04RW1V4R7M	ELECTRO 4.7UF	35WV	
C384-386			CK45FB1H471K	CERAMIC 470PF	K	
C401			CE04KW1A101M	ELECTRO 100UF	10WV	
C403,404			CE04KW2A100M	ELECTRO 10UF	100WV	
C405			CC45FSL1H470J	CERAMIC 47PF	J	
C406,407			CE04KW1H2R2M	ELECTRO 2.2UF	50WV	
C408,409			CK45FB1H471K	CERAMIC 470PF	K	
C410,411			CC45FSL1H331J	CERAMIC 330PF	J	
C412,413			CE04KW1A101M	ELECTRO 100UF	10WV	
C416,417			CC45FSL1H100D	CERAMIC 10PF	D	
C424,425			CK45FF1H472Z	CERAMIC 4700PF	Z	
C426-429			C91-1573-05	MP-C 0.10UF	J	
C430			CK45FF1H472Z	CERAMIC 4700PF	Z	
C431			CC45FSL1H100D	CERAMIC 10PF	D	
C433			CE04KW1A101M	ELECTRO 100UF	10WV	
C434			CC45FSL1H331J	CERAMIC 330PF	J	
C435			CK45FB1H471K	CERAMIC 470PF	K	
C436			CE04KW1H2R2M	ELECTRO 2.2UF	50WV	
C437,438			C91-1573-05	MP-C 0.10UF	J	
C439-443			CK45FB1H222K	CERAMIC 2200PF	K	
C444			CC45FSL1H221J	CERAMIC 220PF	J	
C445			CC45FSL1H560J	CERAMIC 56PF	J	
C446			CK45FB1H222K	CERAMIC 2200PF	K	
C638-642			CC45FSL1H470J	CERAMIC 47PF	J	
C643-645			CE04KW1E470M	ELECTRO 47UF	25WV	
C648			CE04RW1C100M	ELECTRO 10UF	16WV	
C652			CE04RW1C100M	ELECTRO 10UF	16WV	
C826,827			CK45FB1H471K	CERAMIC 470PF	K	
CN101			E40-8481-05	FLAT CABLE CONNECTOR		
CN102			E40-8502-05	FLAT CABLE CONNECTOR		
CN103			E40-8481-05	FLAT CABLE CONNECTOR		
CN104			E40-4428-05	PIN ASSY		YM
CN105			E40-4245-05	PIN ASSY		
CN112			E40-4245-05	PIN ASSY		EE3T1
CN112			E40-4245-05	PIN ASSY		KPXH
CN114			E40-3262-05	PIN ASSY		
CN115			E40-4245-05	PIN ASSY		EE3T1
CN115			E40-4245-05	PIN ASSY		YMXH
CN118			E40-4245-05	PIN ASSY		YM

L: Scandinavia Y: PX(Far East,Hawaii) Y: AAFES(Europe) K: USA T: England X: Australia P: Canada E: Europe Q: Russia R: Mexico G: Germany H: Korea C: China V: China(Shanghai) M: Other Areas I: Malaysia A indicates safety critical components.

PARTS LIST

KRF-V4060D/V5060D/V5560D/NR-605/615

* New Parts

Parts without **Parts No.** are not supplied.Les articles non mentionnés dans le **Parts No.** ne sont pas fournis.Teile ohne **Parts No.** werden nicht geliefert.

19

Ref. No	Add-ress	New Parts	Parts No.	Description	Desti-nation	Re-marks
CN201		*	E40-8482-05	FLAT CABLE CONNECTOR		
CN806			E40-3247-05	PIN ASSY		
J201		*	E63-1256-05	PIN JACK		
J202		*	E63-1258-05	PIN JACK		
J203		*	E63-1256-05	PIN JACK	KP	
J203		*	E63-1258-05	PIN JACK	EE3T1	
J203		*	E63-1258-05	PIN JACK	YMXH	
J204		*	E63-1260-05	PIN JACK	KP	
△ J205			E03-0148-05	AC OUTLET	KPY	
△ J206			E03-0149-05	AC OUTLET	MEE3	
△ J206			E03-0310-05	AC OUTLET	T1	
△ J206			E03-0325-05	AC OUTLET	XH	
J401		*	E70-0156-05	LOCK TERMINAL BOARD		
J403		*	E70-0154-05	LOCK TERMINAL BOARD		
J603		*	E63-1254-05	PIN JACK		
J604		*	E63-1255-05	PIN JACK		
J801			E11-0271-05	PHONE JACK (METAL SLEEVE)		
△ F101			F05-3121-05	FUSE (SEMKO) (250V T3.15AL)	EE3T1	
△ F101			F05-3121-05	FUSE (SEMKO) (250V T3.15AL)	YMXH	
△ F101			F50-0077-05	FUSE(5X20)	KP	
△ F102			F06-1022-05	FUSE (SEMKO) (250V T1AL)	EE3T1	
△ F102			F06-1022-05	FUSE (SEMKO) (250V T1AL)	MX	
△ F103			F05-3121-05	FUSE (SEMKO) (250V T3.15AL)	YM	
CN108,109			J13-0075-05	FUSE CLIP	EE3T1	
CN108,109			J13-0075-05	FUSE CLIP	MX	
CN110,111			J13-0075-05	FUSE CLIP		
CN116,117			J13-0075-05	FUSE CLIP	YM	
E11 -14			J11-0809-05	WIRE CLAMPER		
L301-303			L39-1373-05	PHASE COMPENSATION COIL		
L401-403			L39-1373-05	PHASE COMPENSATION COIL		
△ T101			L07-2758-05	POWER TRANSFORMER	EE3T1	
△ T101			L07-2758-05	POWER TRANSFORMER	KPXH	
△ T101			L07-2761-05	POWER TRANSFORMER	EE3T1	
△ T101			L07-2761-05	POWER TRANSFORMER	KPXH	
△ T101			L07-2805-05	POWER TRANSFORMER	YM	
X101			L77-2002-05	CRYSTAL RESONATOR(4.332MHZ)	EE3T1	
△ R123			RD14NB2E1R0J	RD 1 1/4W		
R124			RS14KB3A221J	FL-PROOF RS 220 J 1W	KPYM	
R125			RD14NB2E270J	RD 27 J 1/4W		
△ R126			RD14NB2E101J	RD 100 J 1/4W		
R127			RD14NB2E822J	RD 8.2K J 1/4W		
△ R132			R92-1844-05	CARBON 3.3M J 1/2W	KPH	
△ R141,142			RD14NB2E1R0J	RD 1 J 1/4W		
R316,317			RS14KB3A472J	FL-PROOF RS 4.7K J 1W		
R334,335			RD14NB2E4R7J	RD 4.7 J 1/4W		
R338-341			RS14KB3DR22J	FL-PROOF RS 0.22 J 2W		
R342,343			RS14KB3D4R7J	FL-PROOF RS 4.7 J 2W		
R345			RS14KB3D4R7J	FL-PROOF RS 4.7 J 2W		
R347			RD14NB2E4R7J	RD 4.7 J 1/4W		
R348,349			RS14KB3DR22J	FL-PROOF RS 0.22 J 2W		
R365			RD14NB2E561J	RD 560 J 1/4W		
R410			RD14NB2E103J	RD 10K J 1/4W		
R411			RD14NB2E101J	RD 100 J 1/4W		

L : Scandinavia K : USA P : Canada R : Mexico C : China I : Malaysia
 Y : PX(Far East,Hawaii) T : England E : Europe G : Germany V : China(Shanghai)
 Y : AAFES(Europe) X : Australia Q : Russia H : Korea M : Other Areas △ indicates safety critical components .

* New Parts

Parts without **Parts No.** are not supplied.Les articles non mentionnés dans le **Parts No.** ne sont pas fournis.Teile ohne **Parts No.** werden nicht geliefert.

20

Ref. No	Add-ress	New Parts	Parts No.	Description	Desti-nation	Re-marks
R414			RD14NB2E101J	RD 100 J 1/4W		
R415			RD14NB2E103J	RD 10K J 1/4W		
R438,439			RS14KB3D391J	FL-PROOF RS 390 J 2W		
R452,453			RS14KB3A472J	FL-PROOF RS 4.7K J 1W		
R460-463			RS14KB3DR22J	FL-PROOF RS 0.22 J 2W		
R466,467			RD14NB2E4R7J	RD 4.7 J 1/4W		
R468,469			RS14KB3D4R7J	FL-PROOF RS 4.7 J 2W		
R473,474			RS14KB3DR22J	FL-PROOF RS 0.22 J 2W		
R475			RD14NB2E4R7J	RD 4.7 J 1/4W		
R476			RS14KB3D4R7J	FL-PROOF RS 4.7 J 2W		
R478-480			RS14KB3A151J	FL-PROOF RS 150 J 1W		
△ K101			S76-0099-05	MAGNETIC RELAY	KP	
△ K101			S76-0102-05	MAGNETIC RELAY	EE3T1	
△ K101			S76-0102-05	MAGNETIC RELAY	YMXH	
K401-403			S76-0097-05	MAGNETIC RELAY		
△ S101			S62-0001-05	SLIDE SWITCH	YM	
△ S102			S68-0107-05	PUSH SWITCH	EE3T1	
△ S102			S68-0107-05	PUSH SWITCH	YMXH	
D113		*	RB441Q-40	DIODE		
△ D114-116			HSS104A	DIODE		
△ D114-116			1SS133	DIODE		
△ D117			S1ZB20(4101)	DIODE		
D118			HZS16N(B2)	ZENER DIODE		
D118			MTZJ16(B)	ZENER DIODE		
D119			HZS15N(B2)	ZENER DIODE		
D119			MTZJ15(B)	ZENER DIODE		
△ D120			D2SBA20F03	DIODE		
△ D121,122			D5SBA20F03	DIODE		
D123,124			HSS104A	DIODE		
D123,124			1SS133	DIODE	YM	
D201			HZS6.8N(B2)	ZENER DIODE	YM	
D201			MTZJ6.8(B)	ZENER DIODE		
△ D202			HZS5.1N(B2)	ZENER DIODE		
△ D202			MTZJ5.1(B)	ZENER DIODE		
D203			HZS6.8N(B2)	ZENER DIODE		
D203			MTZJ6.8(B)	ZENER DIODE		
D215			HSS104A	DIODE		
D215			1SS133	DIODE		
D301,302			HZS15N(B2)	ZENER DIODE		
D301,302			MTZJ15(B)	ZENER DIODE		
D303,304			HSS104A	DIODE		
D303,304			1SS133	DIODE		
D305,306			HZS10N(B2)	ZENER DIODE	EE3T1	
D305,306			HZS10N(B2)	ZENER DIODE	YMXH	
D305,306			HZS11N(B2)	ZENER DIODE	KP	
D305,306			MTZJ10(B)	ZENER DIODE	EE3T1	
D305,306			MTZJ10(B)	ZENER DIODE	YMXH	
D305,306			MTZJ11(B)	ZENER DIODE	KP	
D307			HZS3.9N(B2)	ZENER DIODE		
D307			MTZJ3.9(B)	ZENER DIODE		
D308-310			HSS104A	DIODE		
D308-310			1SS133	DIODE		
D311,312			HZS3.9N(B2)	ZENER DIODE		

L : Scandinavia K : USA P : Canada R : Mexico C : China I : Malaysia
 Y : PX(Far East,Hawaii) T : England E : Europe G : Germany V : China(Shanghai)
 Y : AAFES(Europe) X : Australia Q : Russia H : Korea M : Other Areas △ indicates safety critical components .

PARTS LIST

KRF-V4060D/V5060D/V5560D/VR-605/615

* New Parts

Parts without **Parts No.** are not supplied.

Les articles non mentionnés dans le **Parts No.** ne sont pas fournis.

Teile ohne **Parts No.** werden nicht geliefert.

21

Ref. No	Add-ress	New Parts	Parts No.	Description	Desti-nation	Re-marks
D311,312			MTZJ3.9(B)	ZENER DIODE		
D313			HSS104A	DIODE		
D313			1SS133	DIODE		
D314			HZS3.9N(B2)	ZENER DIODE		
D314			MTZJ3.9(B)	ZENER DIODE		
D315			HSS104A	DIODE		
D315			1SS133	DIODE		
D316			HZS3.9N(B2)	ZENER DIODE		
D316			MTZJ3.9(B)	ZENER DIODE		
D317,318			HSS104A	DIODE		
D317,318			1SS133	DIODE		
D319			HZS11N(B2)	ZENER DIODE	EE3T1H	
D319			HZS15N(B2)	ZENER DIODE	KPYMX	
D319			MTZJ11(B)	ZENER DIODE	EE3T1H	
D319			MTZJ15(B)	ZENER DIODE	KPYMX	
D320			HZS13N(B2)	ZENER DIODE	EE3T1H	
D320			HZS15N(B2)	ZENER DIODE	KPYMX	
D320			MTZJ13(B)	ZENER DIODE	EE3T1H	
D320			MTZJ15(B)	ZENER DIODE	KPYMX	
D401,402			HZS15N(B2)	ZENER DIODE		
D401,402			MTZJ15(B)	ZENER DIODE		
D403,404			HSS104A	DIODE		
D403,404			1SS133	DIODE		
D406-408			HSS104A	DIODE		
D406-408			1SS133	DIODE		
D602,603			HZS5.6N(B2)	ZENER DIODE		
D602,603			MTZJ5.6(B)	ZENER DIODE		
D999			HSS104A	DIODE		
D999			1SS133	DIODE		
IC101			BU1923	ANALOGUE IC	EE3T1	
△ IC105			BA05T	ANALOGUE IC		
△ IC106			KIA7812API	ANALOGUE IC		
△ IC107			KIA7912PI	ANALOGUE IC		
△ IC202			M61516FP	ANALOGUE IC		
△ IC206			NJM4565D	ANALOGUE IC		
△ IC301			STK413-020A	HYBRID IC		
△ IC301		*	STK413-220A	HYBRID IC		
△ IC401			STK413-020A	HYBRID IC		
△ IC401		*	STK413-220A	HYBRID IC		
△ IC607			NJM2279D	ANALOGUE IC		
△ Q113			2SB1640	TRANSISTOR		
△ Q114			2SC1740S(Q,R)	TRANSISTOR		
△ Q114			2SC2785(F,E)	TRANSISTOR		
△ Q201			2SC1845(F,E)	TRANSISTOR		
△ Q203			2SA992(F,E)	TRANSISTOR		
Q301-306			2SC2878(B)	TRANSISTOR		
Q307,308			2SA992(F,E)	TRANSISTOR		
Q309-315			2SC1845(F,E)	TRANSISTOR		
Q316			2SA992(F,E)	TRANSISTOR		
Q317,318			2SC2878(B)	TRANSISTOR		
Q319			2SA992(F,E)	TRANSISTOR		
Q401			2SC1845(F,E)	TRANSISTOR		
Q402			2SA1535A	TRANSISTOR		
Q403			2SC3944A	TRANSISTOR		
Q404			2SC1845(F,E)	TRANSISTOR		

L : Scandinavia K : USA P : Canada R : Mexico C : China I : Malaysia
 Y : PX(Far East,Hawaii) T : England E : Europe G : Germany V : China(Shanghai)
 Y : AAFES(Europe) X : Australia Q : Russia H : Korea M : Other Areas △ indicates safety critical components .

* New Parts

Parts without **Parts No.** are not supplied.

Les articles non mentionnés dans le **Parts No.** ne sont pas fournis.

Teile ohne **Parts No.** werden nicht geliefert.

22

Ref. No	Add-ress	New Parts	Parts No.	Description	Desti-nation	Re-marks
Q405			2SA992(F,E)	TRANSISTOR		
Q406			2SB1640	TRANSISTOR		
Q407-409			2SC1845(F,E)	TRANSISTOR		
Q410,411			DTC113ZSA	DIGITAL TRANSISTOR		
Q410,411			UN4219	DIGITAL TRANSISTOR		
Q412			2SC1740S(Q,R)	TRANSISTOR		
Q412			2SC2785(F,E)	TRANSISTOR		
DISPLAY (X14-7470-10)						
D805-808			B30-2545-05	LED(RED3(160))		
C801			CE04RW1H330M	ELECTRO	33UF	50WV
C802,803			CE04RW1H010M	ELECTRO	1.0UF	50WV
C804			CE04LW1H470M	ELECTRO	47UF	50WV
C805			CE04RW1A101M	ELECTRO	100UF	10WV
C806			CE04RW1E470M	ELECTRO	47UF	25WV
C807			CE04PW1H100M	ELECTRO	10UF	50WV
C809			CE04RW1H010M	ELECTRO	1.0UF	50WV
C810			C90-1826-05	BACKUP-C	0.047F	5.5WV
C811			CE04RW1A101M	ELECTRO	100UF	10WV
C812			CE04HW1H100M	NP-ELEC	10UF	50WV
C813			CK45FF1H103Z	CERAMIC	0.010UF	Z
C814			CC45FSL1H101J	CERAMIC	100PF	J
C815,816			CK45FF1H103Z	CERAMIC	0.010UF	Z
C817			CC45FSL1H101J	CERAMIC	100PF	J
C818,819			CK45FF1H103Z	CERAMIC	0.010UF	Z
C820,821			C91-0769-05	CERAMIC	0.010UF	K
C822-825			CK45FF1H103Z	CERAMIC	0.010UF	Z
C828,829			CK45FF1H103Z	CERAMIC	0.010UF	Z
C830			CC45FSL1H101J	CERAMIC	100PF	J
C831,832			CK45FF1H103Z	CERAMIC	0.010UF	Z
C833			CC45FSL1H101J	CERAMIC	100PF	J
C834			CQ93FMG1H103J	MYLAR	0.010UF	J
C835			CK45FF1H103Z	CERAMIC	0.010UF	Z
C836-839			C91-0745-05	CERAMIC	100PF	K
C840			CQ93FMG1H104J	MYLAR	0.10UF	J
C841			C91-0745-05	CERAMIC	100PF	K
C842			CE04PW1H100M	ELECTRO	10UF	50WV
C843			CE04LW1H2R2M	ELECTRO	2.2UF	50WV
C844,845			CK45FF1H103Z	CERAMIC	0.010UF	Z
C846			CQ93FMG1H103J	MYLAR	0.010UF	J
C847,848			C91-0745-05	CERAMIC	100PF	K
C849			CC45FSL1H100D	CERAMIC	10PF	D
CN801			E40-8502-05	FLAT CABLE CONNECTOR		
CN802			E40-8501-05	FLAT CABLE CONNECTOR		
CN803			E40-8503-05	FLAT CABLE CONNECTOR		
CN805			E40-3263-05	PIN ASSY		
E1			J11-0808-05	WIRE CLAMPER		
E2			J11-0809-05	WIRE CLAMPER		
E4			J11-0808-05	WIRE CLAMPER		
X800		*	L78-0747-05	RESONATOR	(4MHZ)	
X801			L78-0725-05	RESONATOR	(8.38MHZ)	
CP801			R90-0500-05	MULTI-COMP	100KX6	J 1/4W
CP802			R90-0855-05	MULTI-COMP	100KX5	J

L : Scandinavia K : USA P : Canada R : Mexico C : China I : Malaysia
 Y : PX(Far East,Hawaii) T : England E : Europe G : Germany V : China(Shanghai)
 Y : AAFES(Europe) X : Australia Q : Russia H : Korea M : Other Areas △ indicates safety critical components .

PARTS LIST

KRF-V4060D/V5060D/V5560D/NR-605/615

PARTS LIST

* New Parts
 Parts without **Parts No.** are not supplied.
 Les articles non mentionnés dans le **Parts No.** ne sont pas fournis.
 Teile ohne **Parts No.** werden nicht geliefert.

Ref. No	Add-ress	New Parts	Parts No.	Description	Desti-nation	Re-marks
CP803 R849			R90-0493-05 RD14NB2E2R2J	MULTI-COMP 100KX9 J 1/6W RD 2.2 J 1/4W		
S801-812 S801-812			S70-0031-05 S70-0086-05	TACT SWITCH TACT SWITCH		
S813.814 S815			T99-0666-05 T99-0664-05	ROTARY ENCODER ROTARY ENCODER		
D801 D801 D802-804 D802-804 D809			MTZJ6.2(B) RD6.2ES(B) HSS104A 1SS133 HSS104A	ZENER DIODE ZENER DIODE DIODE DIODE DIODE		
D809 D810 D810 D811 D811			1SS133 HSS104A 1SS133 HSS104A 1SS133	DIODE DIODE DIODE DIODE DIODE	KPYM KPYP	
Δ D812.813 D814 D814 D816 D816			RB441Q-40 HSS104A 1SS133 HSS104A 1SS133	DIODE DIODE DIODE DIODE DIODE	YM YM	
D819-828 D819-828 ED801 IC801 IC802			HSS104A 1SS133 * 11MT129GNK * MN12510F S-80840ANY	DIODE DIODE FLUORESCENT INDICATOR TUBE MOS-IC ANALOGUE IC		
IC803 IC804 IC806 Q802 Q802			* XC6202P502TH * MN101C51FGA S-80840ANY 2SC1740S(Q,R) 2SC2785(F,E)	MOS-IC MI-COM IC ANALOGUE IC TRANSISTOR TRANSISTOR	YM	
Q803 Q803 Q804-807 Q804-807			2SA1175(F,E) 2SA933AS(Q,R) 2SC1740S(Q,R) 2SC2785(F,E)	TRANSISTOR TRANSISTOR TRANSISTOR TRANSISTOR		
A801			W02-2759-05	ELECTRIC CIRCUIT MODULE		

L : Scandinavia K : USA P : Canada R : Mexico C : China I : Malaysia
 Y : PX(Far East,Hawaii) T : England E : Europe G : Germany V : China(Shanghai)
 Y : AAFES(Europe) X : Australia Q : Russia H : Korea M : Other Areas Δ indicates safety critical components .

KRF-V4060D/V5060D/V5560D/VR-605/615

PARTS LIST

PCB # vs Model

MALYSIA MADE					INDONESIA MADE				
KRF-V4060D	E	X08-3180-10	X09-6622-72	X14-7482-73	KRF-V4060D	E	X08-3160-10	X09-6602-72	X14-7472-73
KRF-V4060DE	E1	X08-3180-10	X09-6622-72	X14-7482-73	KRF-V4060DE	E1	X08-3160-10	X09-6602-72	X14-7472-73
KRF-V4060D-S	E3	X08-3180-10	X09-6622-72	X14-7482-73	KRF-V4060D-S	E3	X08-3160-10	X09-6602-72	X14-7472-73
KRF-V4060DE-S	E2	X08-3180-10	X09-6622-72	X14-7482-73	KRF-V4060DE-S	E2	X08-3160-10	X09-6602-72	X14-7472-73
KRF-V4060D-S	M	X08-3180-21	X09-6620-22	X14-7480-23	KRF-V4060D-S	M	X08-3160-21	X09-6600-22	X14-7470-23
KRF-V4060D-S	X	X08-3180-10	X09-6620-72	X14-7480-73	KRF-V4060D-S	X	X08-3160-10	X09-6600-72	X14-7470-73
KRF-V4060D	T	X08-3180-10	X09-6620-52	X14-7482-73	KRF-V4060D	T	X08-3160-10	X09-6600-52	X14-7472-73
KRF-V4060D-S	T1	X08-3180-10	X09-6620-52	X14-7482-73	KRF-V4060D-S	T1	X08-3160-10	X09-6600-52	X14-7472-73
VR-605	K	X08-3180-10	X09-6620-10	X14-7480-10	VR-605	K	X08-3160-10	X09-6600-10	X14-7470-10
VR-605	P	X08-3180-10	X09-6620-10	X14-7480-10	VR-605	P	X08-3160-10	X09-6600-10	X14-7470-10
KRF-V5060D	Y	X08-3180-21	X09-6622-91	X14-7480-21	KRF-V5060D	Y	X08-3160-21	X09-6602-91	X14-7470-21
KRF-V5060D-S	M	X08-3180-21	X09-6620-21	X14-7480-21	KRF-V5060D-S	M	X08-3160-21	X09-6600-21	X14-7470-21
KRF-V5060D-S	X	X08-3180-10	X09-6620-71	X14-7480-71	KRF-V5060D-S	X	X08-3160-10	X09-6600-71	X14-7470-71
KRF-V5060D	E	X08-3180-10	X09-6622-71	X14-7482-71	KRF-V5060D	E	X08-3160-10	X09-6602-71	X14-7472-71
KRF-V5060D	T	X08-3180-10	X09-6620-51	X14-7482-71	KRF-V5060D	T	X08-3160-10	X09-6600-51	X14-7472-71
KRF-V5060DE	E1	X08-3180-10	X09-6622-71	X14-7482-71	KRF-V5060DE	E1	X08-3160-10	X09-6602-71	X14-7472-71
KRF-V5060D-S	E3	X08-3180-10	X09-6622-71	X14-7482-71	KRF-V5060D-S	E3	X08-3160-10	X09-6602-71	X14-7472-71
KRF-V5060D-S	T1	X08-3180-10	X09-6620-51	X14-7482-71	KRF-V5060D-S	T1	X08-3160-10	X09-6600-51	X14-7472-71
VR-615	K	X08-3180-10	X09-6630-10	X14-7480-11	VR-615	K	X08-3160-10	X09-6610-10	X14-7470-11
VR-615	P	X08-3180-10	X09-6630-10	X14-7480-11	VR-615	P	X08-3160-10	X09-6610-10	X14-7470-11
KRF-V5560D	Y	X08-3180-21	X09-6632-91	X14-7480-22	KRF-V5560D	Y	X08-3160-21	X09-6612-91	X14-7470-22
KRF-V5560D-S	M	X08-3180-21	X09-6630-21	X14-7480-22	KRF-V5560D-S	M	X08-3160-21	X09-6610-21	X14-7470-22
KRF-V5560D-S	X	X08-3180-10	X09-6630-71	X14-7480-72	KRF-V5560D-S	X	X08-3160-10	X09-6610-71	X14-7470-72
KRF-V5560D	E	X08-3180-10	X09-6632-71	X14-7482-72	KRF-V5560D	E	X08-3160-10	X09-6612-71	X14-7472-72
KRF-V5560D-S	E3	X08-3180-10	X09-6632-71	X14-7482-72	KRF-V5560D-S	E3	X08-3160-10	X09-6612-71	X14-7472-72
KRF-V5560D-S	T1	X08-3180-10	X09-6630-51	X14-7482-72	KRF-V5560D-S	T1	X08-3160-10	X09-6610-51	X14-7472-72
KRF-V5560D-S	H	X08-3180-10	X09-6634-11	X14-7482-72	KRF-V5560D-S	H	X08-3160-10	X09-6614-11	X14-7472-72

HOW TO READ THE PARTS LIST

ABBREVIATION OF MODEL AND MASS PRODUCTION'S DESTINATIONS

MODEL	ABB.	Australia	Canada	China	England	Europe	Germany	Korea	Malaysia
KRF-V4060D	4	-	-	-	T	E	-	-	-
KRF-V4060DE	4	-	-	-	-	E1	-	-	-
KRF-V4060DE-S	4	-	-	-	-	E2	-	-	-
KRF-V4060D-S	4	X	-	-	T1	E3	-	-	-
KRF-V5060D	5	-	-	-	T	E	-	-	-
KRF-V5060DE	5	-	-	-	-	E1	-	-	-
KRF-V5060D-S	5	X	-	-	T1	E3	-	-	-
VR-605	5	-	P	-	-	-	-	-	-
KRF-V5560D	6	-	-	-	-	E	-	-	-
KRF-V5560D-S	6	X	-	-	T1	E3	-	H	-
VR-615	6	-	P	-	-	-	-	-	-
MODEL	ABB.	Mexico	PX/AAFES	Russia	Scandinavia	Shanghai	USA	Other area	
KRF-V4060D	4	-	-	-	-	-	-	-	
KRF-V4060DE	4	-	-	-	-	-	-	-	
KRF-V4060DE-S	4	-	-	-	-	-	-	-	
KRF-V4060D-S	4	-	-	-	-	-	-	M	
KRF-V5060D	5	-	Y	-	-	-	-	-	
KRF-V5060DE	5	-	-	-	-	-	-	-	
KRF-V5060D-S	5	-	-	-	-	-	-	M	
VR-605	5	-	-	-	-	-	K	-	
KRF-V5560D	6	-	Y	-	-	-	-	-	
KRF-V5560D-S	6	-	-	-	-	-	-	M	
VR-615	6	-	-	-	-	-	K	-	

KRF-V4060D/V5060D/V5560D/VR-605/615

SPECIFICATIONS

For the U.S.A and Canada

AUDIO section (VR-605/615)

Rated power output during STEREO operation

100 watts per channel minimum RMS, both channels driven, at 8Ω from 40 Hz to 20 kHz with no more than 0.7% total harmonic distortion. (FTC)

Effective power output during SURROUND operation	
FRONT (40 ~ 20 kHz, 0.7% T.H.D. at 8Ω one channel driven)	100 W + 100 W
CENTER (40 ~ 20 kHz, 0.7% T.H.D. at 8Ω one channel driven)	100 W
SURROUND (40 ~ 20 kHz, 0.7% T.H.D. at 8Ω one channel driven)	100 W + 100 W
SUBWOOFER (80 Hz, 0.7% T.H.D. at 8Ω one channel driven) (VR-615)	100 W
Total harmonic distortion	0.05% (1 kHz, 50 W, 8Ω)
Frequency response	CD 20 Hz ~ 70 kHz, +0 dB, -3.0 dB
Signal to noise ratio (IHF'66)	CD 95 dB
Input sensitivity / impedance	CD 550 mV / 47 kΩ DVD/6CH INPUT (VR-615) 550 mV / 47 kΩ
Output level / impedance	TAPE REC 550 mV / 1 kΩ PRE OUT (SUBWOOFER) (VR-605) 1.5 V / 2.2 kΩ
Tone control	BASS ±10 dB (at 100 Hz) TREBLE ±10 dB (at 10 kHz)
Loudness control	VOLUME at -30dB level +8 dB (at 100 Hz)

For other countries

AUDIO section (KRF-V5060D/V5560D)

Rated power output during STEREO operation

100 watts per channel minimum RMS, both channels driven, at 8Ω from 40 Hz to 20 kHz with no more than 0.7% total harmonic distortion. (FTC)

Effective power output during SURROUND operation	
FRONT (1 kHz, 0.7% T.H.D. at 8Ω one channel driven)	100 W + 100 W
CENTER (1 kHz, 0.7% T.H.D. at 8Ω one channel driven)	100 W
SURROUND (1 kHz, 0.7% T.H.D. at 8Ω one channel driven)	100 W + 100 W
SUBWOOFER (80 Hz, 0.7% T.H.D. at 8Ω one channel driven) (KRF-V5560D)	100 W
Total harmonic distortion	0.05% (1 kHz, 50 W, 8Ω)
Frequency response	CD 20 Hz ~ 70 kHz, +0 dB, -3.0 dB
Signal to noise ratio (IHF'66)	CD, TUNER, AUX, TAPE 95 dB
Input sensitivity / impedance	CD 550 mV / 47 kΩ DVD/6CH INPUT (KRF-V5060D) 550 mV / 10 kΩ
Output level / impedance	TAPE REC 550 mV / 1 kΩ PRE OUT (SUBWOOFER) (KRF-V5060D) 1.5 V / 2.2 kΩ
Tone control	BASS ±10 dB (at 100 Hz) TREBLE ±10 dB (at 10 kHz)
Loudness control	VOLUME at -30dB level +8 dB (at 100 Hz)

AUDIO section (KRF-V4060D)

Effective power output during STEREO operation
1 kHz, 0.7% T.H.D., at 8Ω 50 W + 50 W
Rated power output during STEREO operation

40 watts per channel minimum RMS, both channels driven, at 8Ω from 40 Hz to 20 kHz with no more than 0.7% total harmonic distortion. (FTC)

Effective power output during SURROUND operation	
FRONT (1 kHz, 0.7% T.H.D. at 8Ω one channel driven)	50 W + 50 W
CENTER (1 kHz, 0.7% T.H.D. at 8Ω one channel driven)	50 W

SURROUND (1 kHz, 0.7% T.H.D. at 8Ω one channel driven)	50 W + 50 W
Total harmonic distortion	0.15% (1 kHz, 20 W, 8Ω)
Frequency response	CD 20 Hz ~ 70 kHz, +0 dB, -3.0 dB
Signal to noise ratio (IHF'66)	CD, TUNER, AUX, TAPE 95 dB
Input sensitivity / impedance	CD 400 mV / 47 kΩ
Output level / impedance	TAPE REC 400 mV / 1 kΩ PRE OUT (SUBWOOFER) 1.5 V / 2.2 kΩ
Tone control	BASS ±10 dB (at 70 Hz) TREBLE ±10 dB (at 10 kHz)
Loudness control	VOLUME at -30dB level +8 dB (at 100 Hz)

DIGITAL AUDIO section

Sampling frequency	32 kHz, 44.1 kHz, 48 kHz, 96 kHz
Input level / impedance	Optical (-15 dBm ~ -21 dBm), 660 nm ±30 nm Coaxial 0.5 Vp-p / 75 Ω

VIDEO section

VIDEO inputs / outputs	VIDEO (composite) 1 Vp-p / 75 Ω
------------------------	---------------------------------------

FM tuner section

Tuning frequency range	87.5 MHz ~ 108.0 MHz
Usable sensitivity (MONO)	VR-605/615 1.3 μV (75 Ω) / 13.2 dBf (75 kHz DEV., SINAD 30 dB) KRF-V5060D/V4060D/V5560D 1.6 μV (75 Ω) / 15.2 dBf (75 kHz DEV., SINAD 30 dB)
50dB quieting sensitivity	STEREO 28 μV (75 Ω) / 40.2 dBf
Total harmonic distortion (1 kHz)	MONO 0.5% (71.2 dBf input) STEREO 0.7% (71.2 dBf input)
Signal to noise ratio (1 kHz, 75 kHz DEV.)	MONO 75 dB (71.2 dBf input) STEREO 68 dB (71.2 dBf input)
Stereo separation (1 kHz)	40 dB
Selectivity (±400 kHz)	VR-605/615 70 dB KRF-V5060D/V4060D/V5560D 50 dB
Frequency response	(30 Hz ~ 15kHz), +0.5 dB, -3.0 dB

AM tuner section

Tuning frequency range	10 kHz step (VR-605/615) 530 kHz ~ 1,700 kHz 10 kHz step (KRF-V5060D/V4060D/V5560D) 530 kHz ~ 1,610 kHz 9 kHz step (KRF-V5060D/V4060D/V5560D) 531 kHz ~ 1,602 kHz
Usable sensitivity (30% mod., S/N 20dB) (VR-606/615)	16 μV / (600 μV/m)
Usable sensitivity (KRF-V5060D/V5560D/V4060D)	16 μV / (600 μV/m)
Signal to noise ratio (30% mod. 1 mV input)	50 dB

GENERAL

Power consumption	VR-605/615 2.2 A KRF-V5060D/V5560D 280W KRF-V4060D 200W
-------------------	---

AC outlet	SWITCHED
VR-605/615	(total 150 W, 1.25 A max.)
KRF-V5060D/V4060D/V5560D	(total 90 W max.)
Dimensions	W : 440 mm (17-5/16") H : 143 mm (5-5/8") D : 303 mm (11-15/16")

Weight (Net)	VR-605/615 7.7 kg (17.00 lb) KRF-V5060D/V5560D 8.8 kg (19.40 lb) KRF-V4060D 7.9 kg (17.41 lb)
--------------	---

KRF-V4060D/V5060D/V5560D/VR-605/615

SPECIFICATIONS

For the U.K and Europe

AUDIO section (KRF-V5060D)

Rated power output during STEREO operation DIN/IEC (63 Hz ~ 12.5 kHz, 0.7% T.H.D., at 6Ω)	100 W + 100 W
Effective power output during SURROUND operation	100 W + 100 W
FRONT (1 kHz, 0.7% T.H.D. at 6Ω one channel driven)	100 W + 100 W
CENTER (1 kHz, 0.7% T.H.D. at 6Ω one channel driven)	100 W
SURROUND (1 kHz, 0.7% T.H.D. at 6Ω one channel driven)	100 W + 100 W
Total harmonic distortion	0.05% (1kHz, 50 W, 6Ω)
Frequency response (IHF'66)	20 Hz ~ 70 kHz, +0 dB, -3.0 dB
CD	20 Hz ~ 70 kHz, +0 dB, -3.0 dB
Signal to noise ratio (IHF'66)	74 dB
PHONO (MM)	74 dB
CD	95 dB
Input sensitivity / impedance	6.0 mV / 27 kΩ
PHONO (MM)	6.0 mV / 27 kΩ
CD	500 mV / 47 kΩ
DVD/6CH INPUT	500 mV / 47 kΩ
Output level / impedance	500 mV / 1 kΩ
TAPE REC	500 mV / 1 kΩ
PRE OUT (SUBWOOFER)	1.5 V / 2.2 kΩ
Tone control	
BASS	±10 dB (at 100 Hz)
TREBLE	±10 dB (at 10 kHz)
Loudness control	
VOLUME at -30dB level	+8 dB (at 100 Hz)

AUDIO section (KRF-V4060D)

Rated power output during STEREO operation (DIN 1 kHz 0.7% T.H.D., at 6Ω)	50 W + 50 W
Effective power output during SURROUND operation	50 W + 50 W
FRONT (1 kHz, 0.7% T.H.D. at 6Ω one channel driven)	50 W + 50 W
CENTER (1 kHz, 0.7% T.H.D. at 6Ω one channel driven)	50 W
SURROUND (1 kHz, 0.7% T.H.D. at 6Ω one channel driven)	50 W + 50 W
Total harmonic distortion	0.15% (1 kHz, 20 W, 6Ω)
Frequency response (IHF'66)	20 Hz ~ 70 kHz, +0 dB, -3.0 dB
CD	20 Hz ~ 70 kHz, +0 dB, -3.0 dB
Signal to noise ratio (IHF'66)	95 dB
CD	95 dB
Input sensitivity / impedance	400 mV / 47 kΩ
CD	400 mV / 47 kΩ
Output level / impedance	400 mV / 1 kΩ
TAPE REC	400 mV / 1 kΩ
PRE OUT (SUBWOOFER)	1.5 V / 2.2 kΩ

Notes

1. KENWOOD follows a policy of continuous advancements in development. For this reason specifications may be changed without no tice.
2. The full performance may not be exhibited in an extremely cold location (under a water-freezing temperature).

Tone control	
BASS	±10 dB (at 100 Hz)
TREBLE	±10 dB (at 10 kHz)
Loudness control	
VOLUME at -30dB level	+8 dB (at 100 Hz)

DIGITAL AUDIO section

Sampling frequency	32 kHz, 44.1 kHz, 48 kHz, 96kHz
Input level / impedance / wave length	
Optical	(-15 dBm ~ -21 dBm), 660 nm ±30nm
Coaxial	0.5 Vp-p / 75 Ω

VIDEO section

VIDEO inputs / outputs	
VIDEO (composite)	1 Vp-p / 75 Ω

FM tuner section

Tuning frequency range	87.5 MHz ~ 108.0 MHz
Usable sensitivity (DIN at 75 Ω)	
MONO	1.3 μV / 13.2 dBf (40 kHz DEV., S/N 26 dB)
STEREO	45 μV / 42.1 dBf (46 kHz DEV., S/N 46 dB)
Total harmonic distortion (1 kHz)	
MONO	0.2% (71.2 dBf input)
STEREO	0.8% (71.2 dBf input)
Signal to noise ratio (DIN weighted)	
MONO	65 dB (40 kHz DEV. 71.2 dBf input)
STEREO	60 dB (46 kHz DEV. 71.2 dBf input)
Stereo separation (DIN 1 kHz)	36 dB
Selectivity (DIN ±300 kHz)	64 dB
Frequency response	(30 Hz ~ 15 kHz), +0.5 dB, -3.0 dB

AM tuner section

Tuning frequency range	531 kHz ~ 1,602 kHz
Usable sensitivity	16 μV / (600 μV/m)
Signal to noise ratio (30% mod. 1 mV input)	50 dB

GENERAL

Power consumption	
KRF-V5060D	280W
KRF-V4060D	200W
AC outlet	
SWITCHED	(total 90 W max.)
Dimensions	W : 440 mm H : 143 mm D : 303 mm
Weight (Net)	7.8 kg

KENWOOD CORPORATION

14-6,Dogenzaka 1-chome, Shibuya-ku, Tokyo, 150-8501 Japan

KENWOOD SERVICE CORPORATION

P.O BOX 22745, 2201 East Dominguez St., Long Beach, CA 90801-5745, U.S.A.

KENWOOD ELECTRONICS CANADA INC.

6070 Kestrel Road, Mississauga, Ontario, Canada L5T 1S8

KENWOOD ELECTRONICS LATIN AMERICA S.A.

P.O.BOX 55-2791, Piso 6 plaza Chase, Cl.47 y Aquilino de la Guardia Panama, Republic de Panama

KENWOOD ELECTRONICS BRASIL LTDA.

Alameda Ministro Rocha Azevedo No. 456, Edifício Jaú, 10o Andar, Cerqueira César, Cep 0140-001, São Paulo-SP-Brasil

KENWOOD ELECTRONICS U.K. LIMITED

KENWOOD House, Dwight Road, Watford, Herts., WD1 8EB., United Kingdom

KENWOOD ELECTRONICS BELGIUM N.V.

Leuvensesteenweg 248 J, 1800 Vilvoorde, Belgium

KENWOOD ELECTRONICS DEUTSCHLAND GMBH

Rembrücker Str. 15, 63150 Heusenstamm, Germany

KENWOOD ELECTRONICS FRANCE S.A.

13 Boulevard Ney, 75018 Paris, France

KENWOOD ELECTRONICS ITALIA S.p.A.

Via G. Sirtori, 7/9 20129, Milano, Italy

KENWOOD IBÉRICA S.A.

Bolivia, 239-08020 Barcelona, Spain

KENWOOD ELECTRONICS AUSTRALIA PTY. LTD.

(A.C.N. 001 499 074)
16 Giffnock Avenue, North Ryde, N.S.W. 2113, Australia

KENWOOD ELECTRONICS (HONG KONG) LTD.

Unit 3712-3724, Level 37, Tower 1, Metroplaza, 223 Hing Fong Road, Kwai Fong N.T., Hong Kong

KENWOOD ELECTRONICS GULF FZE

P.O.Box 61318, Jebel Ali, Dubai, U.A.E.

KENWOOD ELECTRONICS SINGAPORE PTE LTD.

No. 1 Genting Lane #02-02, KENWOOD Building, Singapore, 349544

KENWOOD ELECTRONICS (MALAYSIA) SDN BHD.

#4.01 Level 4, Wisma Academy Lot 4A, Jalan 19/1 46300 Petaling Jaya Selangor Darul Ehsan Malaysia

KENWOOD ELECTRONICS (THAILAND) CO., LTD.

2019 New Pechburi Road, Bangkok, Huaykwang, Bangkok, 10320 Thailand