

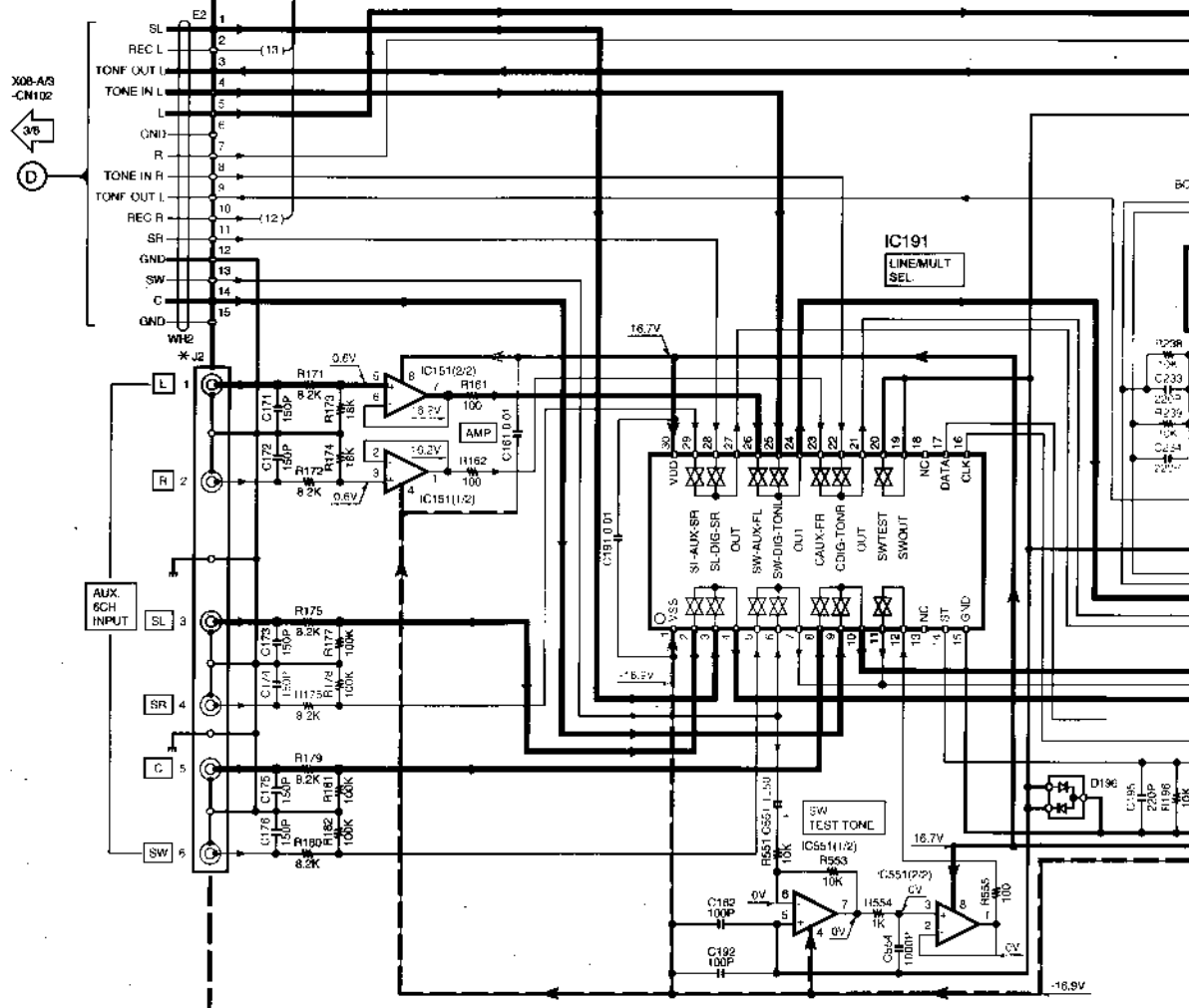





(X08-274X-XX) (B/3)





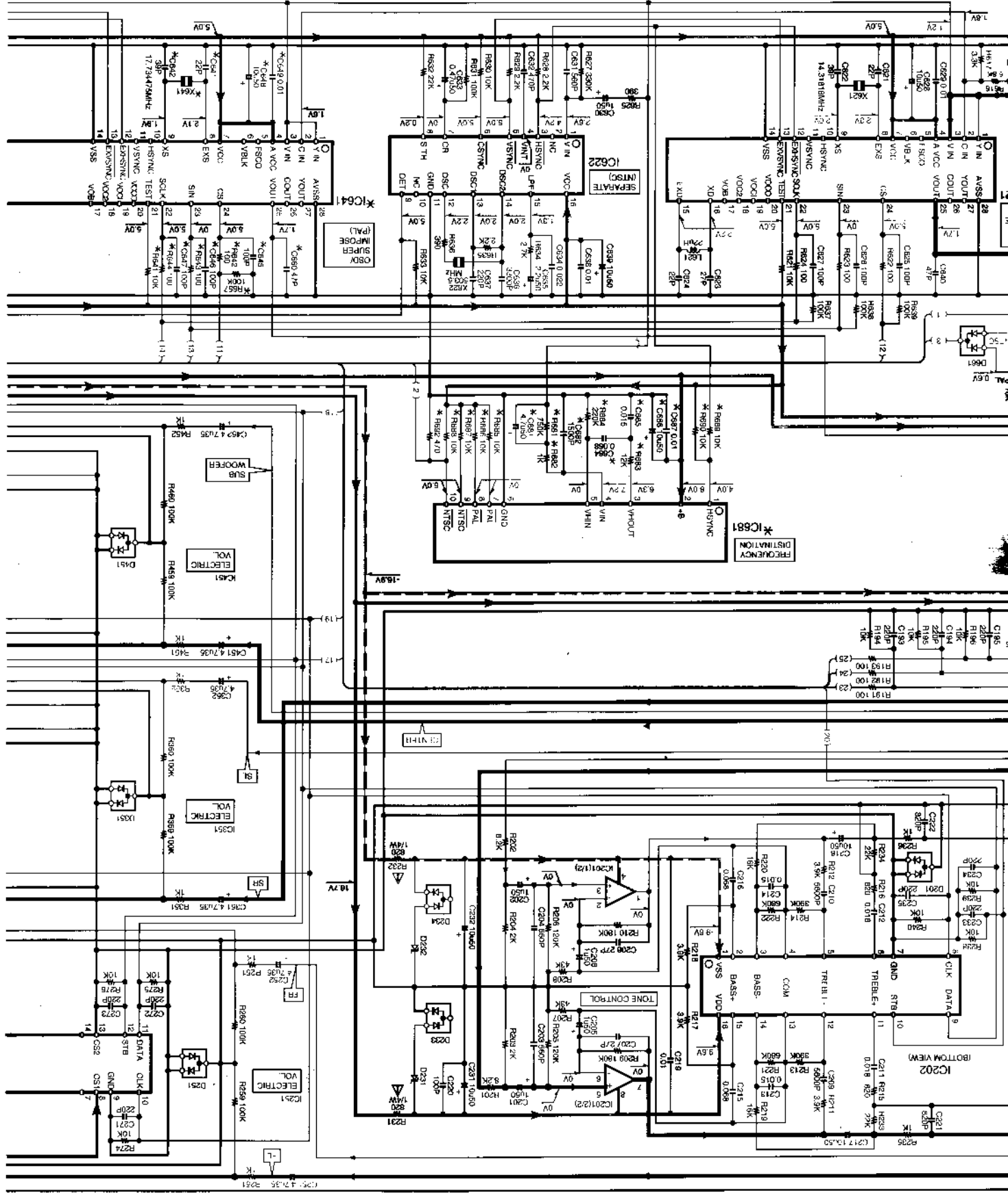

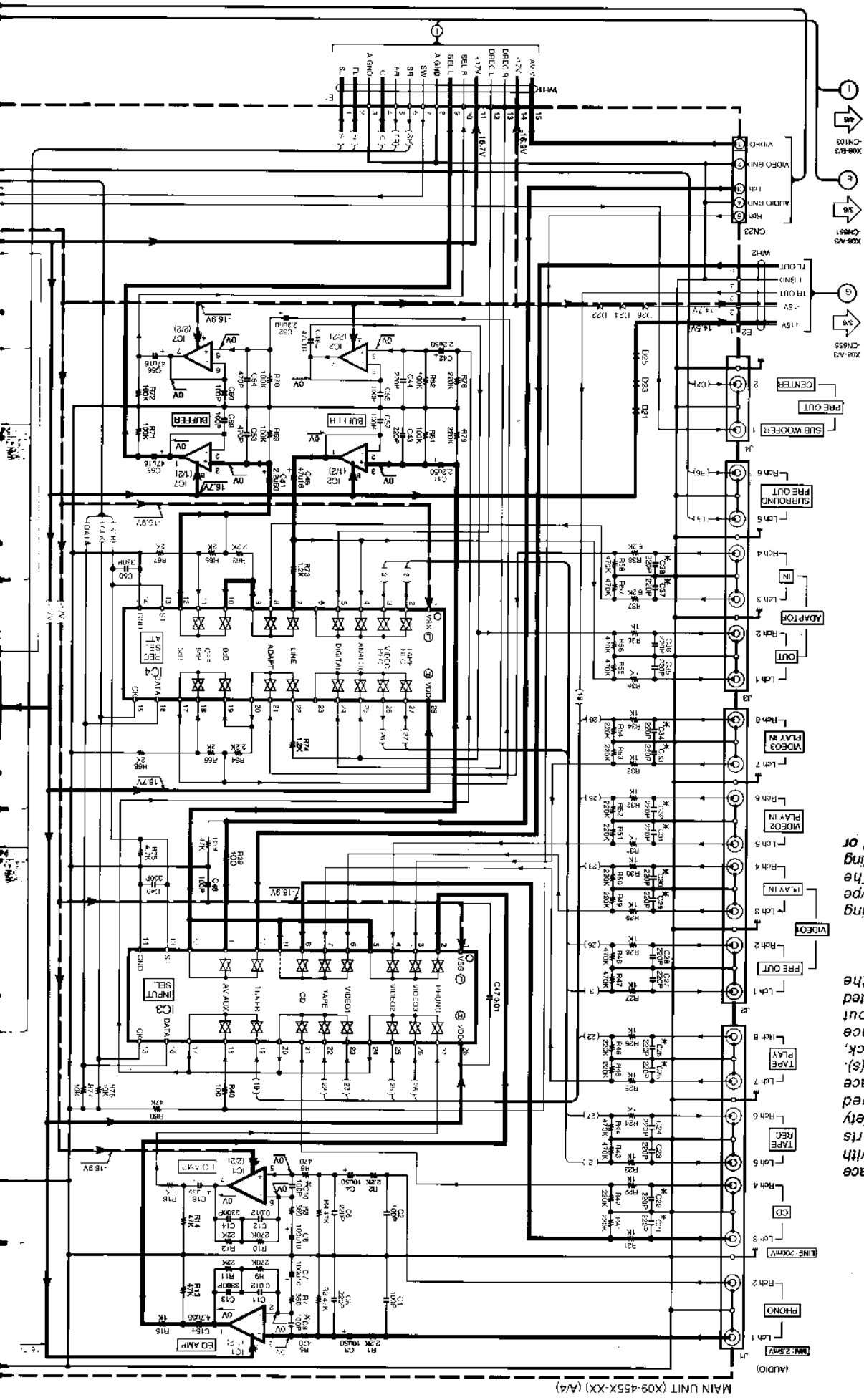

**CAUTION:** For continued safety, replace safety critical components only with manufacturer's recommended parts (refer to parts list).  $\Delta$  indicates safety critical components. For continued protection against risk of fire, replace only with same type and rating fuses(s). To reduce the risk of electric shock, leakage-current or resistance measurements shall be carried out (exposed parts are acceptably insulated from the supply circuit) before the appliance is returned to the customer.

The DC voltage is an actual reading measured with a high impedance type voltmeter with no signal input. The measurement value may vary depending on the product.

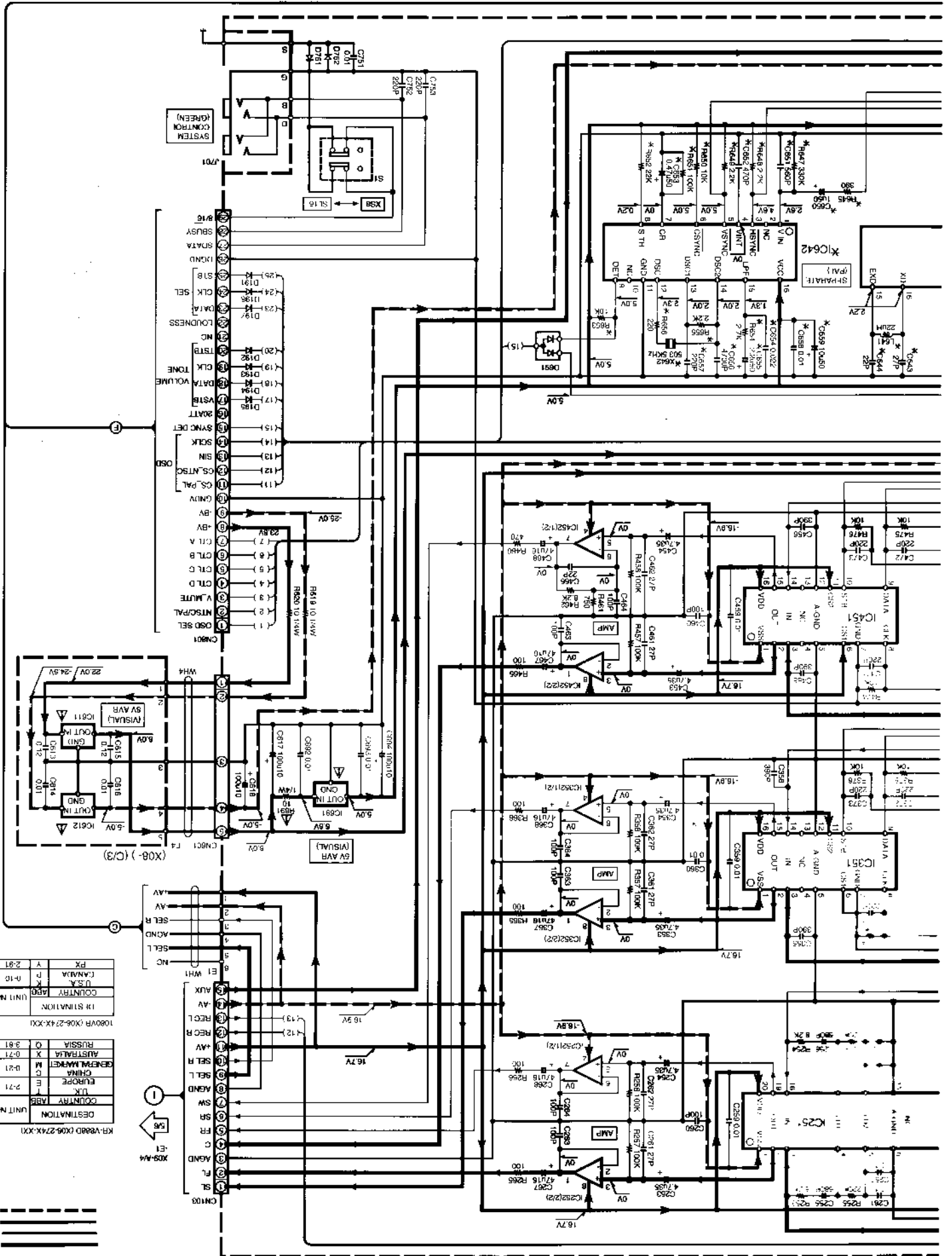

KRV888D (X06-274X-XX)		KR-988D (X06-274X-XX)	
DESTINATION	UNIT No.	DESTINATION	UNIT No.
U.K.	E	U.K.	E
EUROPE	J	EUROPE	J
CHINA	M	CHINA	M
GENERAL MARKET	C	GENERAL MARKET	C
AUSTRALIA	X	AUSTRALIA	X
RUSSIA	Q	RUSSIA	Q
FX	Y	FX	Y
2-81		2-81	
1080VR (X06-274X-XX)		1080VR (X06-274X-XX)	
DESTINATION	UNIT No.	DESTINATION	UNIT No.
U.S.A.	K	U.S.A.	K
CANADA	P	CANADA	P
R-10		R-10	
YES		YES	

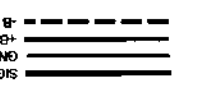



SIGNAL LINE  
 GND LINE  
 +B LINE  
 -B LINE

**CAUTION:** For continued safety, replace safety critical components only with manufacturer's recommended parts (refer to parts list).  $\Delta$  indicates safety critical components. For continued protection against risk of fire, replace only with same type and rating fuse(s). To reduce the risk of electric shock, leakage-current or resistance measurements shall be carried out (exposed parts are acceptably insulated from the supply circuit) before the appliance is returned to the customer.

The DC voltage is an actual reading measured with a high impedance type voltmeter with no signal input. The measurement value may vary depending on the measuring instruments used or on the product.

IC641, 642	IC681	Q692 664 665 669	Q641 690 692 693 694 695	R641 645 647 657 652 654 655 673 677 681 690	R692 632	L641	X641 642	J2
YES	YES	YES	YES	YES	NO	YES	YES	YES
	NO							NO
								YES

IC641, 642, 681	Q692 664 665 669	Q641 690 692 693 694 695	R641 645 647 657 652 654 655 673 677 681 690	R692 632	L641	X641 642	J2
NO	NO	NO	NO	YES	NO	NO	NO
YES	YES	YES	YES	NO	YES	YES	YES

- (X08-1) (B3WC3)
- IC181,201,252,352,452,551  
 NJM4565M
- IC181 NJU7311AM  
 IC202 TC9184AP  
 IC251 TC9412AP  
 IC351,451 TC9413P  
 IC801 SN761200N  
 IC811 TA7805S  
 IC812 TA79005S  
 IC821,841 MB90009PF-108  
 IC822,842 MM1067KF  
 IC801 LA7808  
 IC811 TA7808B or MPC7805AHF
- Q61,1,201,202,203,251,351,451  
 DA204U or 1SS302 or MA143A
- D191,195,197,198,662,751,752  
 MA111
- O231,232 UDZ8.2B
- O661 DAN202U or 1SS301 or MA142WK
- O691 DAP202U or 1SS300 or MA142WA

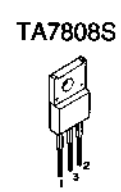
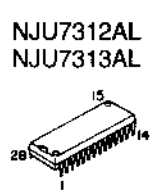
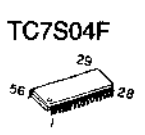
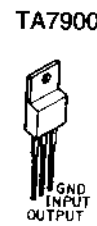
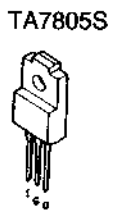
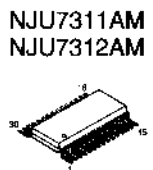
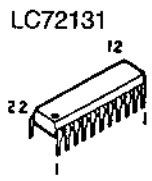
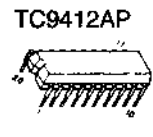
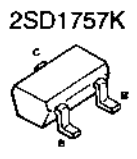
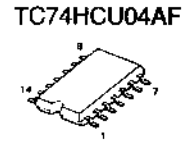
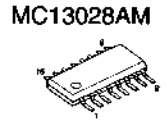
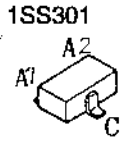
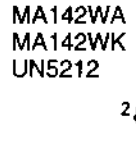
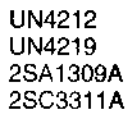
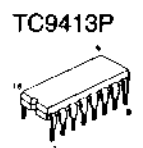
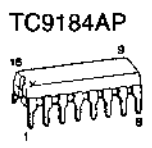
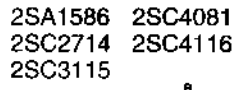
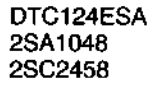
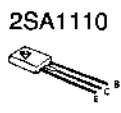

**KR-V888D/1080VF**

**KENWOOD**

Y05-3310-10