

KENWOOD
HI/FI STEREO COMPONENTS

SERVICE MANUAL

KT-413
(KT-4133)

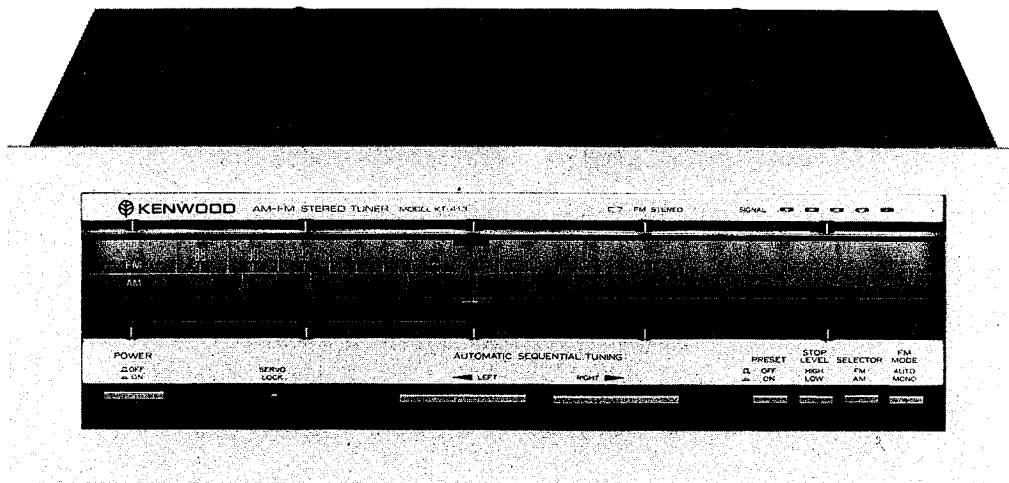

AM-FM STEREO TUNER

CONTENTS

EXTERNAL VIEW	3
INTERNAL VIEW	4
BLOCK DIAGRAM	4
DISASSEMBLY FOR REPAIR	5
DIAL CORD STRINGING	5
CIRCUIT DESCRIPTION	6
EXPLODED VIEW	12
EXPLODED VIEW PARTS LIST	13
PARTS LIST	14
ADJUSTMENT	
ADJUSTMENT	17
RÉGLAGES	21
ABGLEICH	25
SEMICONDUCTOR SUBSTITUTIONS	28
PC BOARD	28
SCHEMATIC DIAGRAM	31
SPECIFICATIONS	31
ALTERNATE SCHEMATIC DIAGRAMS	32

Note:

Component and circuitry are subject to modification to insure best operation under differing local conditions. This manual is based on the U.S. (K) standard, and provides information on regional circuit modification through use of alternate schematic diagrams, and information on regional component variations through use of parts list.

Region	Code
U.S.A.	K
Canada	P
PX	U
Australia	X
Europe & Scandinavia	E
England	T
South Africa	S
Other Areas	M
Audio Club (KT-4133)	H

EXTERNAL VIEW

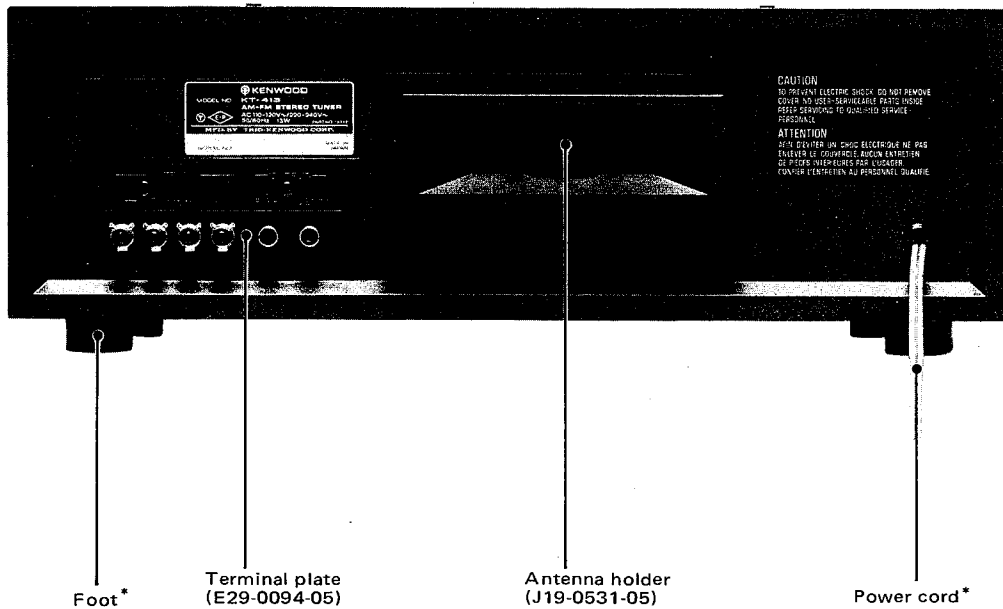
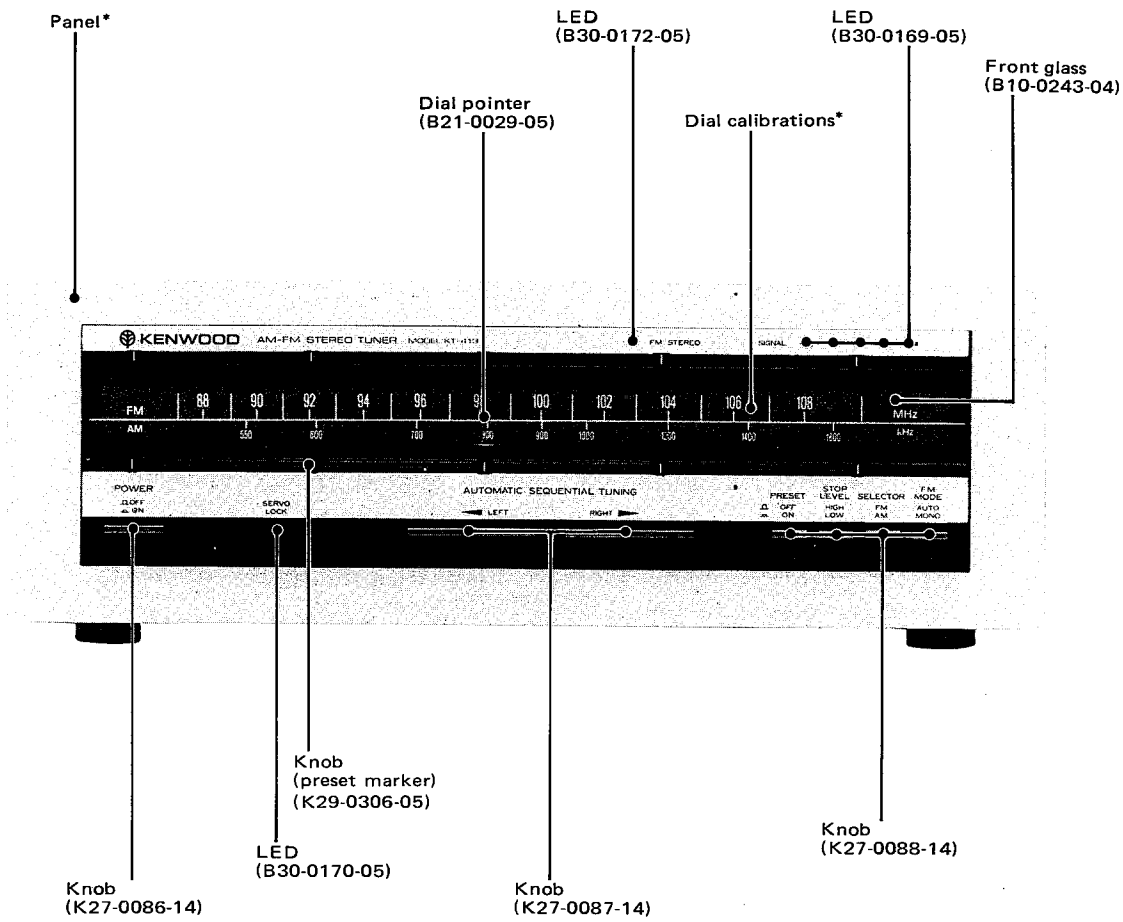

INTERNAL VIEW / BLOCK DIAGRAM

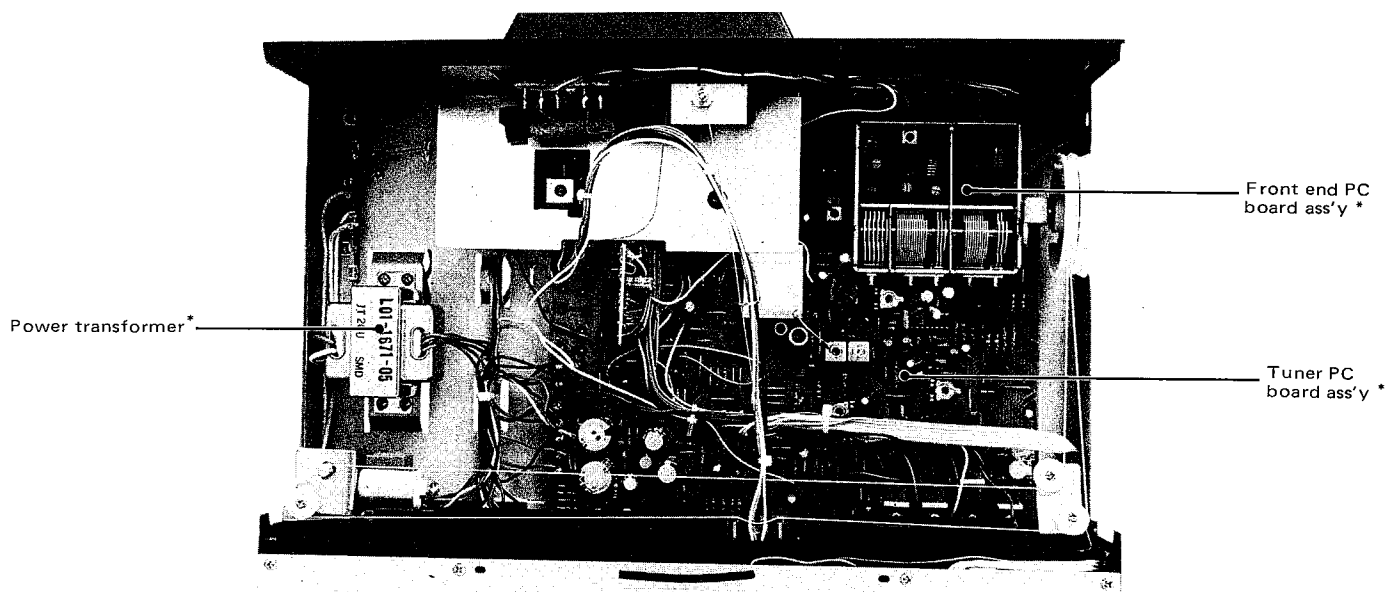

* Refer to Parts List.

BLOCK DIAGRAM

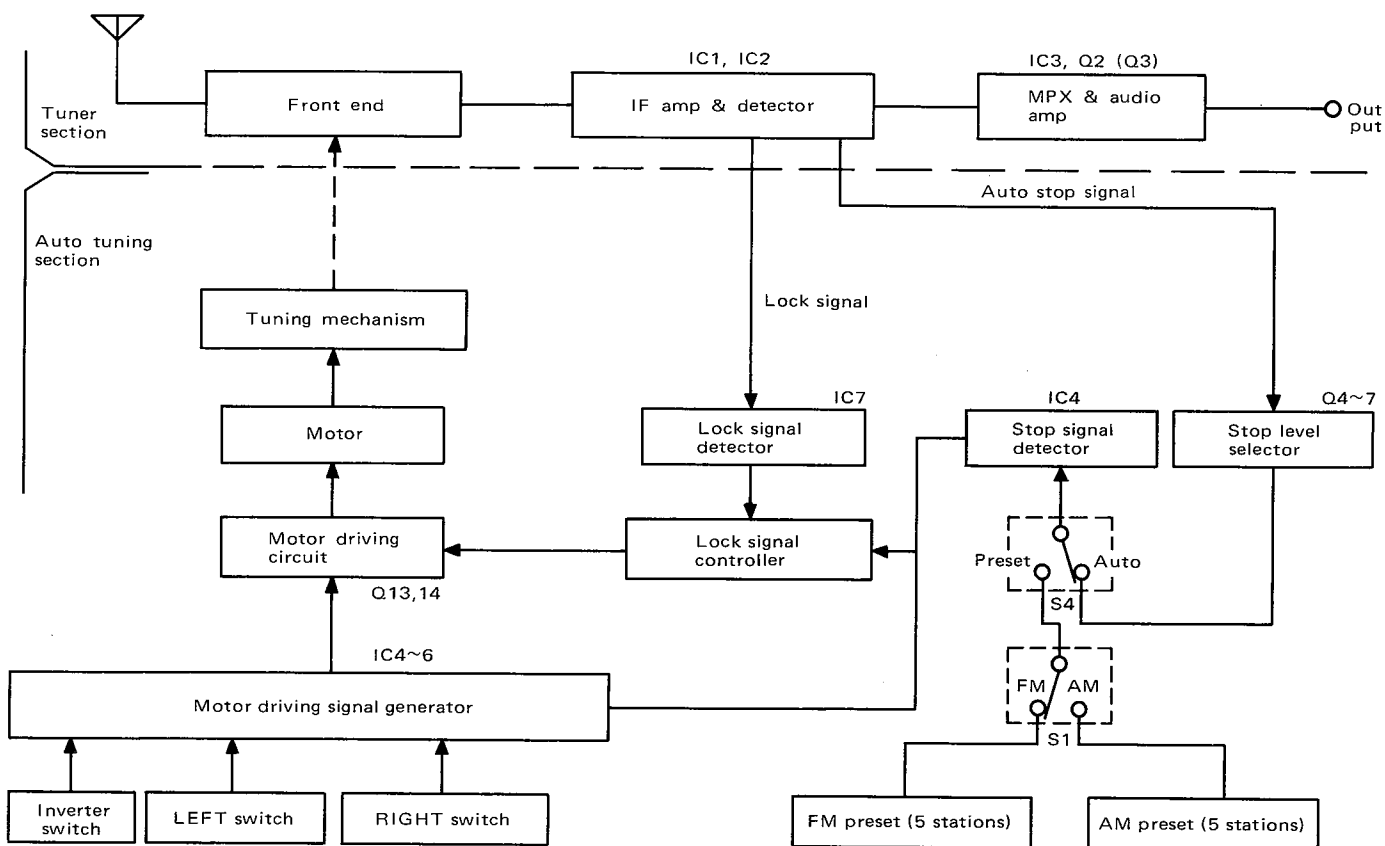

DISASSEMBLY FOR REPAIR / DIAL CORD STRINGING

DISASSEMBLY FOR REPAIR

Dial pointer is replaced as follows.

1. Remove the panel.
2. Remove the front glass.
3. Remove the rails.
4. Remove the gear assembly in the direction of the arrow.
5. Now the dial pointer can be removed from the left end.
6. Replace the entire dial pointer assembly (including the photo transistor)
7. The leaf switch can be removed by moving in the direction of the arrow.

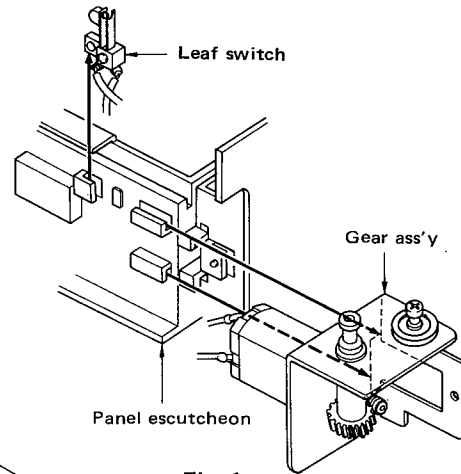

Fig. 1

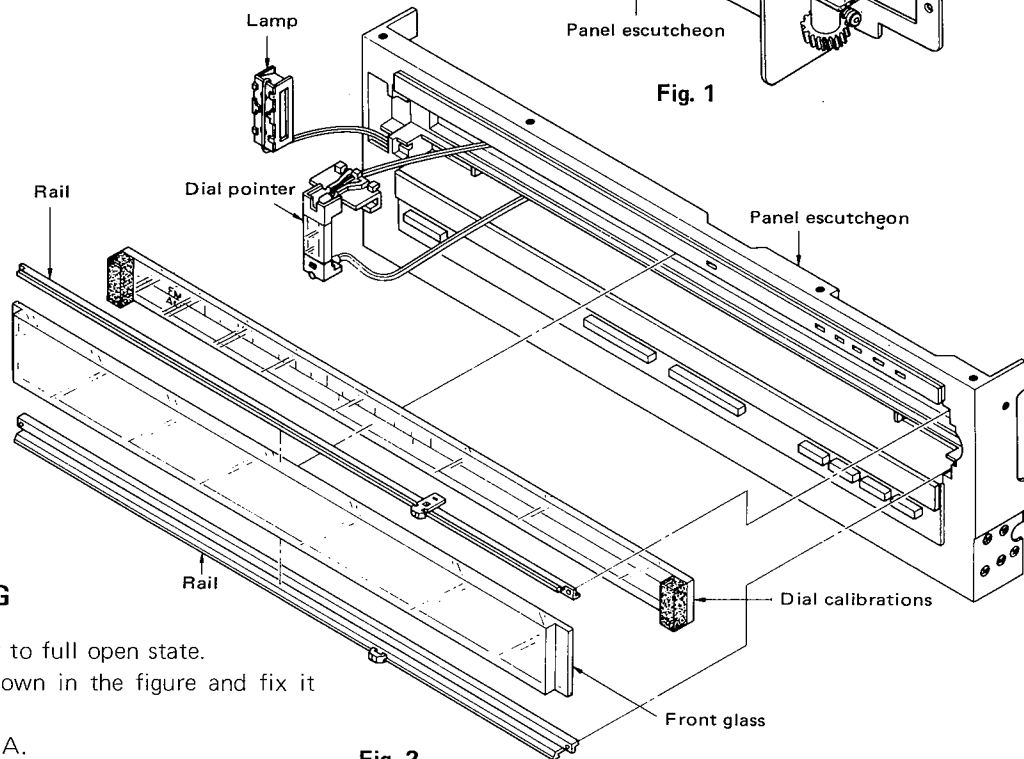

Fig. 2

DIAL CORD STRINGING

1. Set the variable capacitor to full open state.
2. Set the dial pulley as shown in the figure and fix it with the screw.
3. Tie the dial cord to boss A.
4. String the dial cord in the sequence of 1 ~ 6.
5. Wind the dial cord (a few turns) on boss B.
6. Fix the dial pointer so that its center line comes at the position shown in the figure.

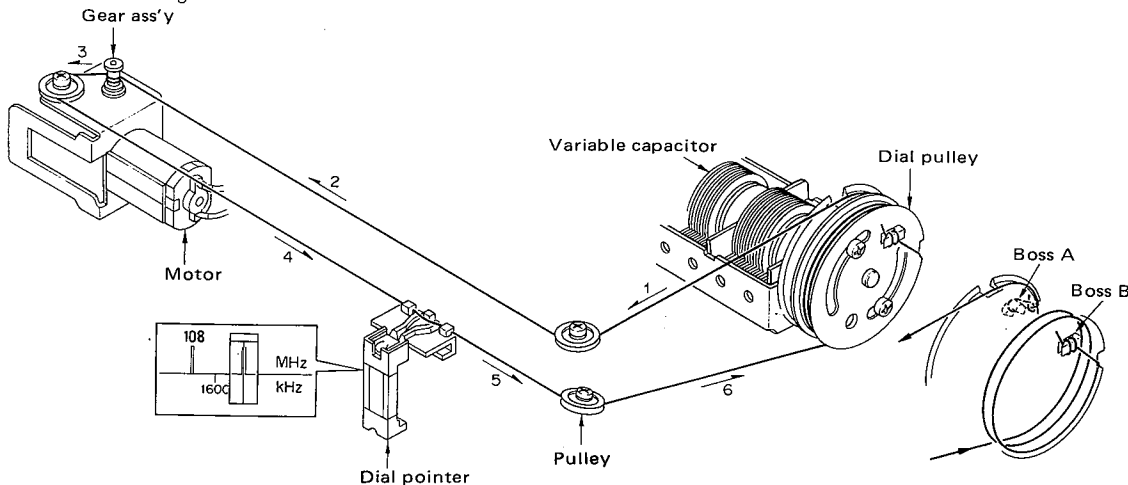

Fig. 3

CIRCUIT DESCRIPTION

1. MOTOR OPERATION

1.1 DRIVING POWER

The motor runs clockwise (the pointer moves to the left) when +B is supplied to terminal 21; and counterclockwise (the pointer moves to the right) when -B is supplied to the same terminal.

Pins 2 and 3 of IC7 are motor drive control signal input terminals, which are both at 0 when the motor is not running. Pin 1 is naturally at 0, and the bases of Q13 and Q14 are not biased so that no voltage will be supplied to terminal 21, and the motor will not run. (Because Pins 3 and 4 of IC6 are at 0.) When the right switch S5 is depressed, Pin 3 of IC6 goes high (while Pin 4 remains low), and Pin 2 of IC7, which is connected to it, will be at about 4.6 V. As Pin 2 is an inverter input terminal, Pin 1 will be at about 12.7 V, which energizes Q14 and supplies -B to terminal 21. When the left switch S6 is depressed, Pin 4 of IC6 goes high (while Pin 3 remains low), and Pin 3 of IC7, which is connected to it, will be at about 14 V. As Pin 3 is a non-inverter input terminal, Pin 1 will be at about 13 V, which energizes Q13, and supplies +B to terminal 21.

S3 is a stop level selector. When it is at LOW, it connects the bases of Q13 and Q14 to GND with R156, and changes the quiescent point to change the levels of ±B to be supplied to terminal 21. The motor runs slowly at LOW, and fast at HIGH.

Table 1 DC Voltages on Pins (Reference values)

Pin Condition	IC7-1	IC7-2	IC7-3	Bases of Q13, Q14	Emitters of Q13, Q14
Stop	0	0	0	-0.7 V	-2.0 V
Clockwise run (Low)	-12.7 V	4.6 V	0	-7.3 V	-6.8 V
Clockwise run (High)	-13 V	4.8 V	0	-12.1 V	-11.5 V
Counterclockwise run (Low)	13 V	4.6 V	14 V	7.7 V	7.2 V
Counterclockwise run (High)	13 V	4.8 V	14 V	12.5 V	12 V

1.2 INITIAL SETTING OF CONTROL CIRCUITS IC4, IC5 AND IC6

The logic values of the pins of IC4, IC5 and IC6 immediately after the power is switched on are set as mentioned below. Pins 8 and 9 of IC6 are connected to the ground via a resistor so that these pins are low. Pin 10 of IC6 is high because it is an inverter output. Therefore, Pin 12 of IC6 and Pin 8 of IC5 also go high. Since all Pins 1, 2 and 8 of IC5 are high, Pin 9 of IC5 is low.

Q16 is off immediately after the power is turned on so its collector potential is high. Thus Pin 13 of IC6 is high. At this instant, Pin 11 of IC6 goes low, and so does Pin 12 of IC5. Regardless of the condition of Pin 11 of IC6, therefore, Pin 10 of IC5 goes high. At the same time, Pin 4 of IC5 goes low, so Pin 6 of IC5 goes high.

Both the Q and \bar{Q} outputs of the 3-input NAND flip-flops, which are composed of Pins 10 to 13 of IC5 and Pins 3 to 6 of IC5, are set high.

Since Pins 6 and 10 of IC5 are high, Pins 3 and 4 of IC6 go low, and as a result, Pins 2 and 3 of IC7 also go low. Thus, the motor will not run.

Pin 11 of IC6 is connected to Pin 13 of IC4, Pin 12 of IC4 is high, and Pin 13 of IC6 is held high via D6 so that, even if the collector potential of Q16 goes low, Pin 11 of IC6 is held low.

It is in this way that the control circuits are set to initial levels, which correspond to the stop voltages shown in the logic table. Pin 5 of IC4 is high if the power is switched on during reception; or goes low if the power is turned on during non-reception. If Pins 12 and 13 of IC6 are not high at the same time, the circuitry is considered faulty.

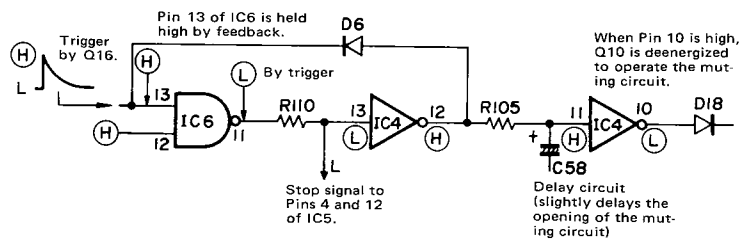

Fig. 2 Stop Signal Generator Circuit (Initial Setting)

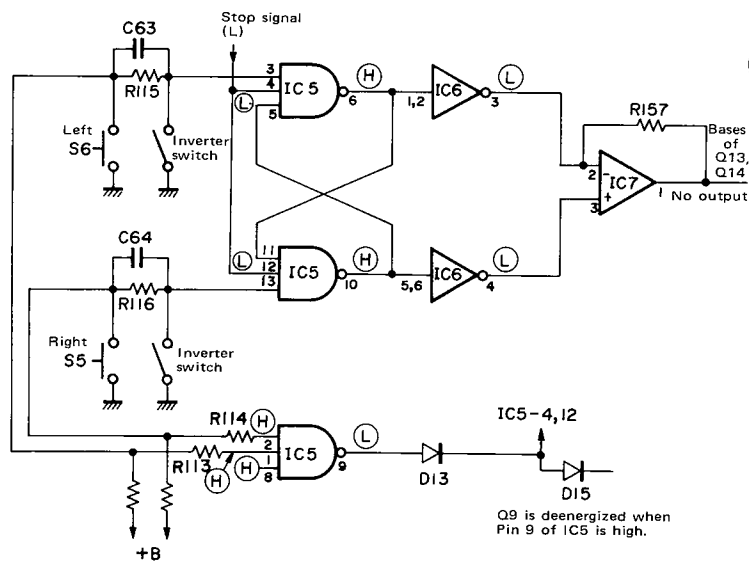

Fig. 3 3-Input NAND Flip-Flops (Initial Setting)

CIRCUIT DESCRIPTION

Table 2 Logic Table for Pins of IC4, IC5, IC6



IC 4

H = 5 ~ 14 V Check with oscilloscope
L = 0 V at DC position.



SELECTOR: FM
STOP LEVEL: LOW
FM MODE: AUTO

pin Condition	1	2	3	4	5	6	7	8	9	10	11	12	13	14
Stopping	FM preset position (L).	FM preset position (H).	AM preset position (L).	AM preset position (H).	H	L	VSS	L	H	L	H	H	L	VDD
Running (between stations).	H	L	H	L	L	H	VSS	L except for received moment when it goes high.	H except for received moment when it goes low.	H, but returns to low after reception.	L, but returns to high after reception.	L	H	VDD

IC 5

Stopping	H	H	H	L	H	H	VSS	H	L	H	H	L	H	VDD
Running to left.	L	H	 Momentarily goes low when the switch is depressed.	H	L, but goes high when the dial pointer has changed its course at the corner.	H, but goes low when the dial pointer has changed its course at the corner.	VSS	 Momentarily goes low when the switch is depressed.	H, while the switch being depressed.	L, but goes high when the dial pointer has changed its course at the corner.	H, but goes low when the dial pointer has changed its course at the corner.	H	H, but momentarily goes low when the dial pointer changes its course at the corner.	VDD
Running to right.	H	L	H, but momentarily goes low when the dial pointer changes its course at the corner.	H	Goes low when the dial pointer has changed its course at the corner.	Goes high when the dial pointer has changed its course at the corner.	VSS	Same as above.	Same as above.	H, but goes low when the dial pointer has changed its course at the corner.	L, but goes high when the dial pointer has changed its course at the corner.	H	 Momentarily goes low when the switch is depressed.	VDD

IC 6

Stopping	H	H	L	L	H	H	VSS	L	L	H	L	H	H	VDD
Running to left.	H	H	L	H	L	L	VSS	 Momentarily goes high when the switch is depressed.	Same as left.	 Momentarily goes low when the switch is depressed.	H	 Momentarily goes low when the switch is depressed.	L	VDD
Running to right.	L	L	H	L	H	H	Same as above.	Same as above.	Same as left.	Same as above.	Same as above.	Same as above.	Same as above.	VDD

CIRCUIT DESCRIPTION

1.3 RUNNING TO RIGHT

When the right switch S5 is depressed, Pin 2 of IC5 goes low; Pin 9 of IC5 goes high, Pin 11 of IC5 remains high, Pin 12 of IC5 goes high, Pin 13 of IC5 is made momentarily low by C64 and R116 but returns to high; Pin 10 of IC5 goes low, Pin 4 of IC6 goes high, and Pin 1 of IC7 produces a positive output, thus starting the motor counterclockwise and the dial pointer to the right.

When Pin 9 of IC5 goes high, Pins 8 and 9 of IC6 are made momentarily high via C65, Pin 10 of IC6 goes low to make Pin 12 of IC6 low, and the logic of the stop signal generator circuit is inverted, and kept in that condition. As a result, the stop signal continues high, and Pin 10 of IC5 remains low as the pointer continues running to the right. The same applies to leftward operation.

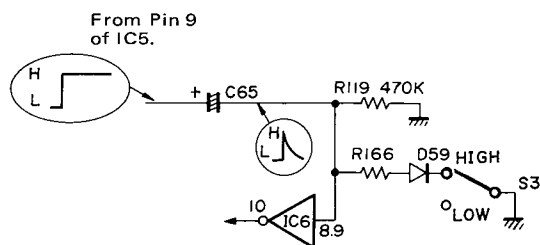

Fig. 4 Pulse Generation by C65

Note:

When S3 is at LOW, charge or discharge time depends on C65 and R119; and when S3 is at HIGH, charge time depends on C65 and R119//R166; and discharge time on C65 and R119.

The rise at HIGH is improved to prevent erroneous operation.

1.4 DIRECTION REVERSING OPERATION

When the pointer running to the right hits the right extremity, the inverting switch operates to make Pin 13 of IC5 low. Then Pin 10 of IC5 goes high, Pin 4 of IC6 goes low, Pin 5 of IC5 goes high, Pin 4 of IC5 remains high, Pin 3 of IC5 remains high, Pin 6 of IC5 goes low, Pin 3 of IC6 goes high, and Pin 1 of IC7 produces a negative output in this sequence, thus driving the motor clockwise, and reversing the pointer to the left.

2. STOP SIGNAL (PRESET OFF)

If the tuner has a sufficient signal input and is accurately tuned in, Q7 is deenergized. And the motor stops by operations of IC4, IC5 and IC6.

2.1 INPUT SIGNAL LEVEL DETECTION

(See the description of sub unit operation.)

In FM, the noise amplifier output (S3 low) and linear level indicator output (S3 high) are used as the stop signals; and in AM, the linear level indicator output is used as a stop signal.

(a) FM-LOW

Q4 is a 120 kHz tuned amplifier which amplifies noise between stations. The amplified noise is rectified by D24 and D25 to energize Q5. Q6 is deenergized, and the collector of Q7 goes low. The noise amplifier rectified voltage falls to 0 near a station (within the S-curve range), Q5 is deenergized, Q6 is energized with its collector going low, and Q7 is controlled by an accurate tuning detecting signal.

(b) FM-HIGH

The input level which deenergizes Q5 rises when S3 is HIGH. Pins 1, 2, 6, 7, and 8 of IC8 are low (0.9 V) when the respective LEDs are ON; but go high (about 10 V) when the LEDs are OFF. Pin 7 of IC8 goes low when the LED second from the left lights. That is, when only one LED is lit, Q5 is energized; and when two or more LEDs are lit, Q5 is deenergized. When a broadcast is received, Pin 11 of IC6 goes low so that the voltage on Pin 7 of IC8 is divided by D48 and R163, making it possible to lower the input level at which Q5 will be deenergized, and permit tuning in to a wider range of stations. The voltage on Pin 7 of IC8 (or any other pin of it) will not be 0.9 V depending on input level even if the LED is lit.

(c) AM

The output of Pin 6 of IC8 (output for the left-most LED) is used for low as a stop signal; and the output of Pin 7 of IC8 for high as a stop signal.

CIRCUIT DESCRIPTION

2.2 ACCURATE TUNING SIGNAL DETECTION

Pin 7 of IC7 produces an S-curve output.

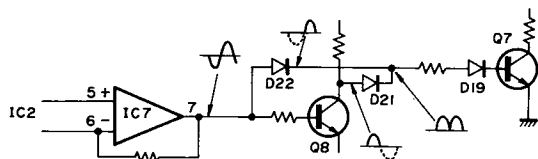

Fig. 5

As shown in Fig. 5, the S-curve is converted into an M-curve by D22 and Q8 (D21). At the center of the S-curve (accurate tuning point), the M-curve goes low, D19 is cut off, and Q7 is controlled by the signal input level. At other than the center of the S-curve, the M-curve goes high, Q7 is energized via D19, and the collector of Q7 goes low.

2.3 STOP SIGNAL GENERATING OPERATION

When Q7 is off, its collector potential goes high. That is, Pin 5 of IC4 goes high via D39, and Pin 6 of IC4 goes low. Pin 9 of IC4 goes momentarily low via C60, and Pin 8 of IC4 goes high. This makes Pin 13 of IC6 high via D42. As Pin 12 of IC6 is high, the stop signal generator circuit is set at the same logic level as in initial setting, and sends a stop signal to Pins 4 and 12 of IC5.

3. LOCK SIGNAL

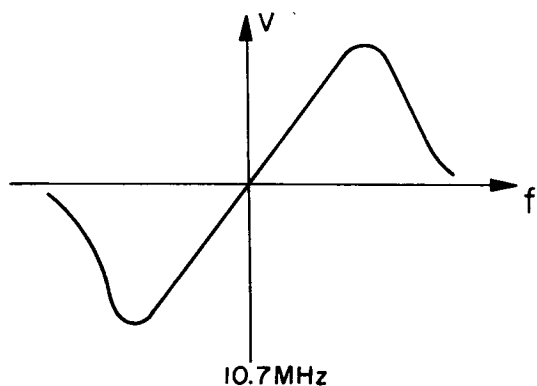

Fig. 6

3.1 FM

The S-curve of the FM detector is shown in Fig. 6. When the tuner is detuned leftward from the tuning point, a negative voltage relative to the DC potential at the center frequency is generated as a detector output; and when the tuner is detuned rightward, a positive voltage relative to the same is generated. When HA1137W is used for an IF circuit, a T-meter is connected across Pins 7 and 10 of it to detect a potential difference, which causes the meter pointer to move.

Table 3 DC Voltages on Pins (Reference values)

Pin Condition	Pin 7	Pin 10	T-meter
Tuned in	5.6 V	5.6 V	Center
Detuned to left.	2.9 to 5.6 V	5.6 V	Pointer moves to left.
Detuned to right.	5.6 to 8.7 V	5.6 V	Pointer moves to right.

A set which uses HA1137W operates as shown in the table above. (Since the KT-413 is an auto-tuning type, it is difficult to measure the Pin 7 voltage.) The KT-413 uses Pins 5 to 7 of the error amplifier IC7 to generate lock signals for the motor.

Suppose the motor is about to be stopped by a control signal from IC6. (Near a station), Pin 9 of IC5 goes low, D15 is cut off, and Q9 is energized. (D14 and D16 is cut off already.)

When Q9 is energized, Q12 is energized (and so are Q2 and Q3), and the S-curve output from Pin 7 of IC7 is sent via S1 to Pin 2 of IC7. Pin 7 of IC7 is at 0 when the set is tuned in, but generates a negative voltage if the set is detuned to the right; or a positive voltage if it is detuned to the left. If a station is approached from the left, Pin 7 of IC7 will have a positive potential, which is applied to Pin 2 of IC7 to keep the motor running clockwise to accurately tune the set in to the station even if IC6 ceases sending signals. When the pointer reaches the accurate tuning point, Pin 2 of IC7 produces no output so that the motor stops running, and the tuner is best tuned in. If the station is approached from the right, the opposite operation takes place.

CIRCUIT DESCRIPTION

3.2 AM

An intermediate frequency (IF) signal is taken out of L3, and applied to Pin 1 of IC2; and by quadrature detection, an S-curve is obtained in the same way as in FM.

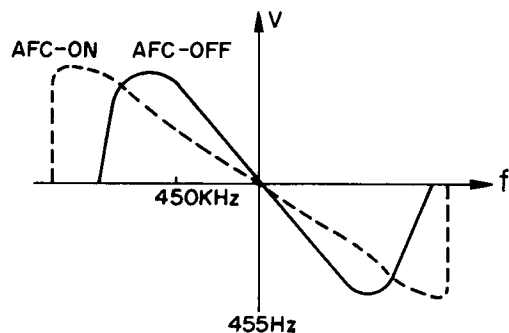

Fig. 7

	Broadcasting station
Antenna tuning circuit:	800 kHz → 845 kHz → 850 kHz
Local oscillator frequency:	1,255 kHz → 1,300 kHz → 1,305 kHz

In AM, the local oscillator frequency is the receiving frequency f plus 455 kHz. Suppose the dial is set at 845 kHz when tuning in to the station broadcasting on 850 kHz. In this case, the local oscillator frequency will be 1,300 kHz. The intermediate frequency of 450 kHz is obtained by mixing the desired station frequency of 850 kHz and 1,300 kHz. As a result, a positive voltage is generated for 455 kHz. This voltage controls the variable capacitance diode D1 to accurately lock the set at the accurate tuning point.

The KT-413 adjusts the quadrature coils to obtain an S-curve opposite to that shown in the figure in order to match it with the S-curve of FM. In AM, L9, L6 and L5 are the quadrature coils because Q1 is switched off by S1 during AM operation.

Q20 is a gain control for IC7. In FM, Q20 is shorted to decrease the gain; and in AM, it cuts off to increase the gain. (The sensitivity is raised for easy tuning in.)

4. PRESETTING

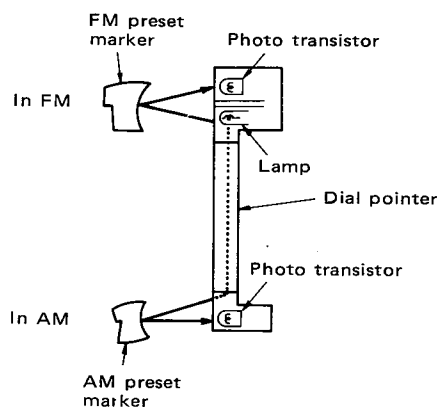

Fig. 8

If the dial pointer comes to the preset position as shown in Fig. 8, light reaches the photo transistor by reflection from the marker so that the photo transistor is energized, Pin 1 of IC4 goes low (or Pin 3 of IC4 goes low in case of AM), and Pin 2 of IC4 goes high. Q22 is used for stabilizing the pointer lamp voltage. The subsequent operation is the same as in preset off, and the motor is stopped.

5. OTHERS

5.1 STEREO LED LIGHTING OPERATION

When Pin 7 of IC8 is low, Pin 12 of IC3 goes low, and the lamp circuit of IC3 (HA1196) operates to light the stereo LED.

5.2 LOCK LED LIGHTING OPERATION

When the tuner is receiving signals with the dial pointer at the preset position, or in the auto mode, the base of Q21 is high so Q21 is on. As a result, the lock LED lights. If the tuner is not receiving with the dial pointer at the preset position, the LED lights dimly.

5.3 +3 SWITCH FOR LED

Q11 is the +B switch for LED. When the motor is not running, Q10 and Q11 are energized to supply +B to the anode of LED. Q10 also energizes Q2 and Q3 simultaneously to release the muting.

CIRCUIT DESCRIPTION

5.4 Q17

Since S1 is a short type switch, its both ends are shorted, and Q17 is energized when FM is changed over to AM or vice versa. In this case, the base of Q16 is connected to the ground via D5, thus deenergizing Q16. The collector Q16 goes high to stop the motor, and simultaneously deenergizes Q10, and Q2 and Q3.

6. SUB UNIT OPERATION

This circuit uses the muting (Pin 12) function of IC2 HA-1137W at FM low.

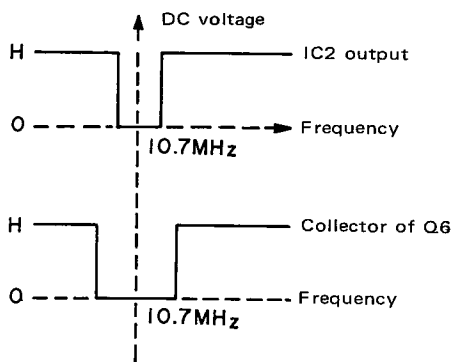
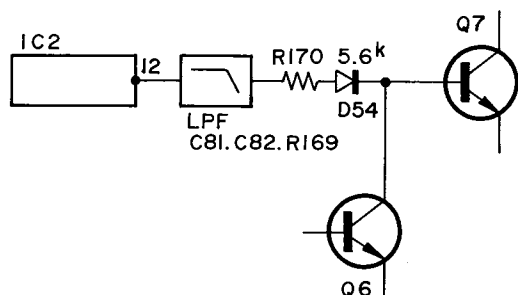

Fig. 9

Q7 is energized when the tuner is accurately tuned in, and is normally controlled by the noise amplifier output (the collector of Q6). At FM low, an OR of the output from Pin 12 of IC2 and the collector output of Q6 is generated so that the range wherein Q7 is energized is widened. In other words, smooth tuning in is made possible even at low input level by narrowing the positive tuning range.

At FM high, the output from Pin 12 of IC2 is grounded via D52 so that no further operation takes place. The sub unit operation is approximately as follows. If the tuner gets within the band zone of the noise amplifier while selecting an FM station (when the collector of Q6 is low), a trigger input is sent to the base of Q24 via C84 and D56. Q24 is energized, and its collector goes low so that the output from Pin 12 of IC2 is grounded via D55 and thus no longer affects the operation. The moment the station is tuned in to, Pin 8 of IC4 goes high, energizing Q23 via R172, which deenergizes Q24 and cuts off D55. This condition is kept by R173.

Selection of a separate station can be made with smoothness because the output from Pin 12 of IC2 is already disconnected from the ground and applied to the base of Q7, and the range of accurate tuning point is narrowed. In AM, the output from Pin 12 of IC2 is grounded via D53.

EXPLODED VIEW

A

B

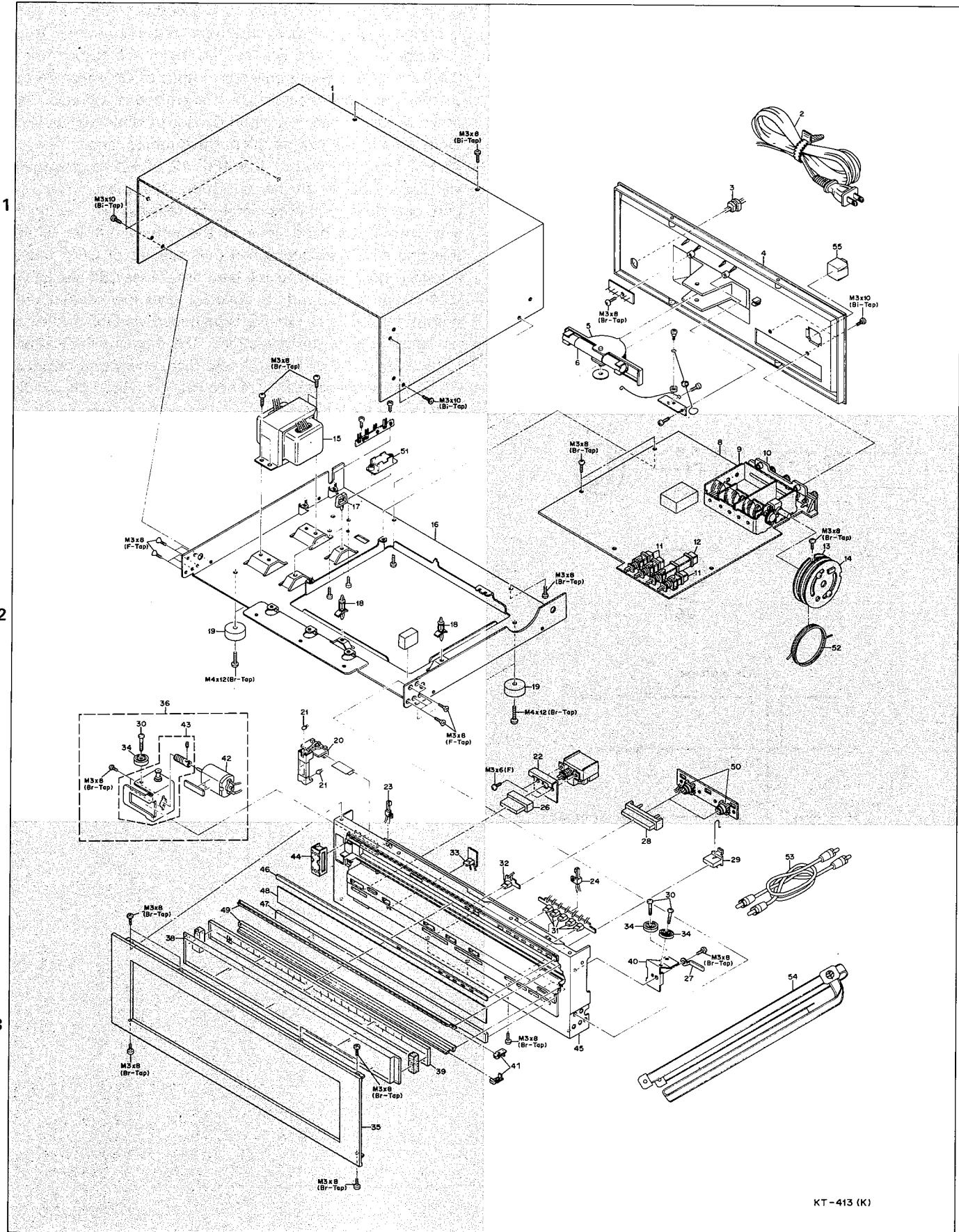

EXPLODED VIEW PARTS LIST

☆ : New parts ★ : Refer to Parts List.

Fig. No.	Parts No.	Description	Re- marks
1	A01-0350-03	Case	1A ☆
2	★	Power cord	1B
3	★	Power cord bushing	1B
4	—	Rear panel	1B
5	J19-0531-05	Antenna holder	1B ☆
6	T90-0092-05	AM bar antenna	1B
7	G09-0019-04	Spring for dial pointer	1B ☆
8	★	Tuner PC board ass'y	2B ☆
9	★	Front end PC board ass'y	2B ☆
10	E29-0094-05	Terminal plate	2B
11	S40-2093-05	Push switch	2B ☆
12	S40-8004-05	Push switch	2B ☆
13	D15-0155-13	Dial pulley	2B
14	D15-0156-13	Dial pulley	2B
15	★	Power transformer	2A ☆
16	—	Chassis	2A
17	J61-0023-05	Wire clamper	2A
18	J19-0515-05	PC board supporter	
19	★	Foot	2A
20	B21-0029-05	Dial pointer	2A ☆
21	V08-0275-10	Photo transistor PT-350(S)	2A ☆
22	—	Switch holder	2B
23	S46-1008-05	Leaf switch (L)	2A ☆
24	S46-1009-05	Leaf switch (R)	3B ☆
25	★	Push switch (Power)	2B ☆
26	K27-0086-04	Knob	2B ☆
27	J19-0306-05	Lead holder	3B
28	K27-0087-04	Knob (Tuning)	3B ☆
29	K27-0088-04	Knob S1 ~ 4	3B ☆
30	N09-0293-05	Screw for pulley	3B
31	B30-0169-05	LED D34 ~ 38	3B ☆
32	B30-0172-05	LED	3B ☆
33	B30-0170-05	LED	3A ☆
34	D15-0170-14	Pulley	3B
35	★	Panel	3A ☆
36	T49-0011-03	DC motor ass'y	2A ☆
37	—	—	
38	B10-0243-04	Front glass	3A ☆
39	★	Dial calibrations	3A ☆
40	—	Pulley holder	3B
41	K29-0306-04	Knob (Preset)	3B ☆
42	T42-0005-05	DC motor	2A ☆
43	D13-0056-03	Gear ass'y	2A ☆
44	B30-0137-05	Lamp	3A
45	—	Panel escutcheon	3A
46	—	Dress panel (Signal meter)	3A
47	—	Dress panel	3A
48	—	Dress board	3A
49	—	Rail	3A
50	S40-1007-05	Push switch	2B ☆
51	S31-2050-05	Slide switch	2A
52	G01-0314-04	Dial spring	2B
53	E30-0505-05	Audio cord	3B
54	T90-0202-05	FM indoor antenna	3B
55	E04-0004-05	Antenna connector	1B

Fig. No.	Parts No.
M3 x 8 (Br-Tap)	N87-3008-46
M4 x 12 (Br-Tap)	N87-4012-46
M4 x 10 (Br-Tap)	N87-4010-46
M3 x 8 (Bi-Tap)	N89-3008-45
M3 x 10 (Bi-Tap)	N89-3010-45
M3 x 6 (F)	N32-3006-46
M3 x 8 (F-Tap)	N88-3008-46

PARTS LIST

TOTAL

☆ : New parts

Ref. No.	Parts No.	Description	Re- marks	Ref. No.	Parts No.	Description	Re- marks
1	A01-0350-03	Case		28	K27-0087-04	Knob x 2 (Tuning)	☆
35	A20-1348-03	Panel	☆	29	K27-0088-04	Knob x 4	☆
45&47	B01-0129-03	Panel escutcheon ass'y	K,P,M,S,X,U,E ☆	41	K29-0306-04	Knob x 10 (Preset)	☆
45&47	B01-0133-03	Panel escutcheon ass'y	T ☆	15	L01-1671-05	Power transformer	K ☆
45&47	B01-0139-03	Panel escutcheon ass'y	H ☆	15	L01-1674-05	Power transformer	M,S,T,X,U,E,H ☆
38	B10-0243-04	Front glass	☆	15	L01-1677-05	Power transformer	P ☆
39	B20-0430-04	Dial calibrations	K,P,M,T,X,U,H ☆	30	N09-0293-05	Screw for pulley x 3	
39	B20-0431-04	Dial calibrations	S ☆	R1	R92-0173-05	Carbon resistor 2.2MΩ 1/2W K,P	
39	B20-0440-04	Dial calibrations	E ☆	51	S31-2050-05	Slide switch (Power supply voltage selector)	M,S,X,U,E,H ☆
20	B21-0029-05	Dial pointer	☆	25	S40-1004-05	Push switch (Power) S10	K,P ☆
44	B30-0137-05	Lamp	☆	25	S40-1008-05	Push switch (Power) S10	M,S,X,U,H ☆
-	B42-0009-04	Passed sticker		25	S40-2092-05	Push switch (Power) S10	T,E ☆
-	B46-0055-20	Warranty card	P	23	S46-1008-05	Leaf switch (L)	☆
-	B46-0060-00	Warranty card	T	24	S46-1009-05	Leaf switch (R)	☆
-	B46-0061-20	Warranty card	K	42	T42-0005-05	DC motor	☆
-	B46-0062-20	Warranty card	U,H	36	T49-0011-03	DC motor ass'y	☆
-	B46-0063-00	Warranty card	U	6	T90-0092-05	AM bar antenna	
-	B46-0064-00	Warranty card	X	54	T90-0202-05	FM indoor antenna	
-	B50-1797-00	Instruction manual	K,S,X,U ☆	21	V08-0275-10	Photo transistor PT-350S Q31,32	☆
-	B50-1798-00	Instruction manual	P,M ☆	8	X05-1600-11	Tuner PC board ass'y	K,P,M ☆
-	B50-1799-00	Instruction manual	T ☆	8	X05-1600-41	Tuner PC board ass'y	S ☆
-	B50-1800-00	Instruction manual	E ☆	8	X05-1600-61	Tuner PC board ass'y	T,E ☆
-	B50-1863-00	Instruction manual	H ☆	8	X05-1600-71	Tuner PC board ass'y	X ☆
-	B59-0018-00	Kenwood service stations' list	U	8	X05-1600-81	Tuner PC board ass'y	U,H ☆
C1,2	C54-3310-39	Ceramic capacitor x 2 0.01μF DC 2kV	T,E	-	351-0003-14	Dial cord	
C1	C90-0145-05 or C91-0001-05	Film capacitor 0.01μF AC 125V	K				
C1	C91-0023-05	Ceramic capacitor 0.01μF AC250V	M,S,X,U,H				
C1	C91-0025-05	Film capacitor 0.01μF AC125V	P				
43	D13-0056-03	Gear ass'y	☆				
13	D15-0155-13	Dial pulley					
14	D15-0156-13	Dial pulley					
34	D15-0170-14	Pulley x 3					
55	E04-0004-05	Antenna connector	E				
2	E30-0181-05	Power cord	K,P				
2	E30-0185-05	Power cord	X				
2	E30-0459-05	Power cord	E,H				
	E30-0505-05	Audio cord					
2	E30-0602-05	Power cord	S,T				
2	E30-1007-05	Power cord	M,U				
52	G01-0314-04	Dial spring					
7	G09-0019-04	Spring for dial pointer	☆				
-	H01-1852-04	Carton box	K,M,S,X,U,E ☆				
-	H01-1853-04	Carton box	P ☆				
-	H01-1854-04	Carton box	T ☆				
-	H10-1523-02	Polystyrene foamed fixture					
-	H20-0417-04	Polyethylene cover	M				
-	H20-0451-04	Polyethylene cover	K,P,S,T,X,U,E,H				
-	H25-0078-04	Polyethylene bag (235 x 315)					
-	H25-0148-04	Polyethylene bag (110 x 230)					
-	H40-0004-04	Anti-rust paper	M				
19	J02-0049-14	Foot x 4	P,M,S,T,X,U,E,H				
19	J02-0073-04	Foot x 4	K				
27	J19-0306-05	Lead holder x 2					
18	J19-0515-05	PC board supporter					
5	J19-0531-05	Antenna holder					
3	J41-0017-05	Power cord bushing	E,H				
3	J42-0072-05	Power cord bushing	K,P,M,U				
3	J42-0074-05	Power cord bushing	S,T,X				
17	J61-0023-05	Wire clamper x 2					
-	J61-0045-15	Combex x 5					
26	K27-0086-04	Knob (Power)	☆				

PARTS LIST

TUNER (X05-1600-11,-41,-61,-71,-81)

RD: Carbon film resistor
RC: Carbon composition resistor
RS: Metal oxide film resistor

Ref. No.	Parts No.	Description	Re- marks
CAPACITOR			
C1,2	C55-1710-38	Ceramic 0.01μF +80%, -20%	
C3,4	C55-1722-38	Ceramic 0.022μF +80%, -20%	
C5	C71-1747-06	Ceramic 47pF ±10%	
C6,7	C24-1722-51	Electrolytic 2.2μF 50WV	
C8~10	C55-1710-38	Ceramic 0.01μF +80%, -20%	
C11	C46-1768-36	Mylar 0.068μF ±10%	
C12~14	C55-1747-38	Ceramic 0.047μF +80%, -20%	
C15	C24-1710-51	Electrolytic 1μF 50WV	
C16	C71-1733-16	Ceramic 330pF ±10%	
C17	C24-1710-51	Electrolytic 1μF 50WV	
C18	C24-1247-61	Electrolytic 47μF 16WV	
C19	C55-1747-38	Ceramic 0.047μF +80%, -20%	
C20	C24-1710-51	Electrolytic 1μF 50WV	
C21	C55-1747-38	Ceramic 0.047μF +80%, -20%	
C22	C24-1222-61	Electrolytic 22μF 16WV	
C23,24	C24-1210-61	Electrolytic 10μF 16WV	
C25,26	C46-1718-25	Mylar 1800pF ±5%	-11,81
	C46-1712-25	Mylar 1200pF ±5%	-41,-61,-71
C27	C71-1718-16	Ceramic 180pF ±10%	
C28,29	C24-1710-51	Electrolytic 1μF 50WV	
C30	C46-1747-36	Mylar 0.047μF ±10%	
C31	C46-1712-25	Mylar 1200pF ±5%	
C32	C48-1736-15	Polystyrene 360pF ±5%	
C33	C25-6533-57	Electrolytic 3.3μF 35WV	
C34	C25-6522-57	Electrolytic 2.2μF 35WV	
C35	C25-1733-47	Electrolytic 0.33μF 50WV	
C36	C63-1707-02	Ceramic 7pF ±0.5pF	
C37	C63-1781-05	Ceramic 18pF ±5%	
C38	C48-1736-15	Polystyrene 360pF ±5%	
C39,40	C55-1722-38	Ceramic 0.022μF +80%, -20%	
C41	C55-1710-38	Ceramic 0.01μF +80%, -20%	
C42	C25-1210-67	Electrolytic 10μF 16WV	
C43	C55-1722-38	Ceramic 0.022μF +80%, -20%	
C45	C48-1712-15	Polystyrene 120pF ±5%	
C46	C46-1747-26	Mylar 0.0047μF ±10%	
C47	C46-1722-36	Mylar 0.022μF ±10%	
C48	C24-1710-51	Electrolytic 1μF 50WV	
C49	C24-1747-41	Electrolytic 47μF 50WV	
C50	C55-1710-38	Ceramic 0.01μF +80%, -20%	
C51,52	C24-1410-89	Electrolytic 1000μF 25WV	
C53	C24-1410-71	Electrolytic 100μF 25WV	
C54,55	C24-1247-71	Electrolytic 470μF 16WV	
C56	C71-1710-16	Ceramic 100pF ±10%	
C57	C25-1410-67	Electrolytic 10μF 25WV	
C58	C25-1710-57	Electrolytic 1μF 50WV	
C60	C25-1722-47	Electrolytic 0.22μF 50WV	
C63,64	C55-1710-38	Ceramic 0.01μF +80%, -20%	
C65	C25-1710-57	Electrolytic 1μF 50WV	
C66	C25-1722-47	Electrolytic 0.22μF 50WV	
C67	C24-1210-61	Electrolytic 10μF 16WV	
C68,69	C54-2710-39	Ceramic 0.01μF +100%, -0%	
C70	C24-6547-51	Electrolytic 4.7μF 35WV	
C71	C24-1210-61	Electrolytic 10μF 16WV	
C72	C24-1222-71	Electrolytic 220μF 16WV	
C73	C24-1210-71	Electrolytic 100μF 16WV	
C74	C24-1710-51	Electrolytic 1μF 50WV	
C75	C24-1210-61	Electrolytic 10μF 16WV	
C76	C25-1722-47	Electrolytic 0.22μF 50WV	
C77	C24-1710-51	Electrolytic 1μF 50WV	
C78	C55-1710-38	Ceramic 0.01μF +80%, -20%	
C79	C24-1710-57	Electrolytic 1μF 50WV	
C80	C46-1733-49	Mylar 0.33μF ±5%	
C81,82	C55-1747-38	Ceramic 0.047μF +80%, -20%	
C83	C26-1722-47	Electrolytic 0.22μF 50WV	
C84	C25-1710-57	Electrolytic 1μF 50WV	
C85,86	C54-2710-39	Ceramic 0.01μF +100%, -0%	
C87	C24-1210-61	Electrolytic 10μF 16WV	
C88	C46-1710-45	Mylar 0.1μF ±5%	

Ref. No.	Parts No.	Description	Re- marks
RESISTOR			
R88	R40-8310-68	Flame-proof RC 10MΩ ±20% 1/2W	
R96	R43-1233-15	Flame-proof RD 330Ω ±5% 1/4W	-11,-61
R97	R43-1222-15	Flame-proof RD 220Ω ±5% 1/4W	-11,-61
R98	R47-5482-05	Flame-proof RS 82Ω ±5% 1W	
R140~142	R40-8310-68	Flame-proof RC 10MΩ ±20% 1/2W	
R143	R43-1210-15	Flame-proof RD 100Ω ±5% 1/4W	-11,-61
R144	R40-8310-68	Flame-proof RC 10MΩ ±20% 1/4W	
R154	R43-1256-05	Flame-proof RD 56Ω ±5% 1/4W	-11,-61
R158	R40-8310-68	Flame-proof RC 10MΩ ±20% 1/2W	
SEMICONDUCTOR			
Q1~3	V09-0127-40	FET 2SK105(H,J)	
	V09-0112-05	or 2SK68(M,N)	
Q4	V03-0416-05	Transistor 2SC1222(U)	
	V03-0508-05	or 2SC1681	
Q5~8	V03-0828-10	Transistor 2SC282A	
	V03-0270-05	or 2SC945(R,Q)	
Q9,10	V01-0564-30	Transistor 2SA564A(Q,R)	
	V01-0733-30	or 2SA733A(R,Q)	
Q11	V03-1735-10	Transistor 2SC1735(E)	
Q12	V09-0127-40	FET 2SK105(H,J)	
	V09-0112-05	or 2SK68(M,N)	
Q13	V03-1735-10	Transistor 2SC1735(E)	
Q14	V01-0850-10	Transistor 2SA850(E)	
Q15	V09-0127-40	FET 2SK105(H,J)	
	V09-0112-05	or 2SK68(M,N)	
Q16,17	V03-0828-10	Transistor 2SC282A	
	V03-0270-05	or 2SC945(R,Q)	
Q18	V03-0467-05	Transistor 2SC1567(R,Q)	
Q19	V03-0828-10	Transistor 2SC282A	
	V03-0270-05	or 2SC945(R,Q)	
Q20	V09-0127-40	FET 2SK105(H,J)	
	V09-0112-05	or 2SK68(M,N)	
Q21	V03-0828-10	Transistor 2SC282A	
	V03-0270-05	or 2SC945(R,Q)	
Q22	V01-0850-10	Transistor 2SA850(E)	
Q23,24	V03-0828-10	Transistor 2SC282A	
	V03-0270-05	or 2SC945(R,Q)	
IC1	V30-0270-20	IC AN217P(BB)	
IC2	V30-0133-08	IC HA1137W	
IC3	V30-0155-05	IC HA1196	
IC4	V30-0297-10	IC TC4069BP or μPD4069C or MC14069B	
IC5	V30-0301-60	IC TC4023BP or μPD4023C or MC14023B	
IC6	V30-0301-70	IC TC4011BP or μPD4011C or MC14011B	☆
IC7	V30-0248-10	IC NJM4558D	☆
IC8	V30-0295-10	IC M51903L	☆
D1	V11-0192-05	Variable capacitance diode 1S1658	☆
D2	V11-0051-05	Diode 1N60	
D3	V11-0273-05	Diode 1S2076A	
D4~25	V11-0271-05	Diode 1S2076	
	V11-0076-05	or 1S1555	
D26~29	V11-0295-05	Diode W06B	
D30	V11-0254-05	Zener diode YZ-140	
D31	V21-0006-05	Zener diode DZ-140	
D32	B30-0172-05	LED (Yellow)	☆
D33	B30-0170-05	LED (Green)	☆
D34~38	B30-0169-05	LED	☆
D39~49	V11-0271-05	Diode 1S2076	
	V11-0076-05	or 1S1555	
D50,51	V11-0339-05	Zener diode EQA01-06(R)	
D52~56	V11-0271-05	Diode 1S2076 or 1S1555	
D57	V11-4163-46	Zener diode XZ-080	
D58~60	V11-0271-05	Diode 1S2076 or 1S1555	
POTENTIOMETER			
VR1	R12-3030-05	PC trimming 10kΩ VCO	
VR2,3	R12-5019-05	PC trimming 100kΩ Separation, AFC Offset	

PARTS LIST

Ref. No.	Parts No.	Description	Re- marks
VR4	R12-0047-05	PC trimming 500Ω Level	
VR5	R12-6401-05	PC trimming 470kΩ S meter	
VR6	R12-5031-05	PC trimming 220kΩ Preset voltage (FM)	
VR7	R12-6401-05	PC trimming 470kΩ LED level	
VR8	R12-5031-05	PC trimming 220kΩ Preset voltage (AM)	
COIL/FILTER			
L1	L32-0186-05	AM OSC	
L2	L30-0307-05	AM IFT	
L3	L30-0283-05	AM IFT	
L4	L79-0073-05	9 kHz filter	-41,-61,-71,-81
L5	L40-2205-25	Inductor 22μH	
L6	L40-1835-21	Inductor 18mH	
L7	L30-0309-05	FM IFT	
L8	L30-0310-05	FM IFT	
L9	L30-0315-05	AM IFT	☆
L10	L79-0072-05	Low pass filter	
L11	L40-6825-64	Inductor 6.8mH	
L12	L40-2292-12	Inductor 2.2μH	
L13,14	L40-1092-11	Inductor 1μH	
CF1	L72-0069-05	AM ceramic filter	
CF2,3	L72-0068-05	FM ceramic filter	
SWITCH			
S1	S40-8004-05	Push switch	☆
S2~4	S40-2093-05	Push switch	☆
S5,6	S40-1007-05	Inverter switch	☆
MISCELLANEOUS			
—	E29-0094-05	Terminal plate	
—	W02-0017-05	Front end PC board ass'y	-11,-71,-81 ☆
—	W02-0018-05	Front end PC board ass'y	-41 ☆
—	W02-0020-05	Front end PC board ass'y	-61 ☆

ADJUSTMENT

No.	ALIGNMENT	TEST EQUIPMENTS		TUNER SETTING	OUTPUT INDICATOR	ADJUSTMENT POINTS	REMARKS
		CONNECTION	SETTING				
FM SECTION							
1	PRESET VOLTAGE	—	—	SELECTOR: FM STOP LEVEL: LOW PRESET: ON Dial pointer *1	DC voltmeter across terminal 3 of X05-1160 and GND.	VR6	11V *2
2a	TUNING CENTER	Ⓐ	95MHz 1kHz, 75kHz Dev OUTPUT *3	95MHz STOP LEVEL: LOW VR4: Turn fully clockwise	Ⓑ	—	*4
2b	TUNING CENTER	ditto	95MHz 1kHz, 75kHz Dev 60dB *5	ditto	DC voltmeter across R20 and R23 *6	L7	0V
3	AFC	ditto	Short the point where DC voltmeter is inserted (2b).	ditto	DC voltmeter across pin7 of IC7 and GND.	VR3	0V
4	NOISE AMP	ditto	95MHz 1kHz, 75kHz Dev OUTPUT *3	95MHz STOP LEVEL: LOW	Ⓒ	VR4	*7
5	LED LEVEL	ditto	95MHz 1kHz, 75kHz Dev 90dB *5	ditto	LEDs (Linear level indicator)	VR7	5 LEDs light
6a	TRACKING	ditto	90MHz 1kHz 75kHz Dev	90MHz STOP LEVEL: LOW	Position of dial pointer	TC5 (Front end)	*8
6b	TRACKING	ditto	106MHz 1kHz, 75kHz Dev	106MHz STOP LEVEL: LOW	Ⓒ	TC1,3 (Front end)	Maximum deflection *9
7	DISTORTION FACTOR	ditto	95MHz 1kHz 75kHz Dev 60dB *5	95MH STOP LEVEL: LOW	ditto	L8	Minimum distortion *10
8a	STOP LEVEL CONFIRMATION	ditto	95MHz 1kHz, 75kHz Dev 11~13dB *5	ditto	ditto	—	*11
8b	STOP LEVEL CONFIRMATION	ditto	95MHz 1kHz 75kHz Dev	95MHz STOP LEVEL: HIGH	ditto	—	*12
9	VCO	ditto	95MHz, 0 Dev 60dB *5	95MHz	*13	VR1	76kHz
10	SEPARATION	Ⓒ	95MHz *14 1kHz 60dB SELECTOR: L(R)	95MHz *15	Ⓒ	VR2	Minimum crosstalk *16
11	IFT	ditto	95MHz 1kHz, 68.25kHz Dev 60dB *5 SELECTOR : L+R	95MHz	ditto	T1 (Front end)	Mimum distortion (Slight adjustment)

ADJUSTMENT

No.	ALIGNMENT	TEST EQUIPMENT		TUNER SETTING	OUTPUT INDICATOR	ADJUSTMENT POINTS	REMARKS
		CONNECTION	SETTING				
AM SECTION							
1	PRESET VOLTAGE	—	—	SELECTOR: AM STOP LEVEL: LOW PRESET: ON Dial pointer *1	DC voltmeter across terminal 4 of X05-1160 and GND.	VR 8	more than 10V *17
2a	TRACKING	⊙	600kHz 400Hz, 30% Mod	600kHz STOP LEVEL: LOW	⊕	L1 AM bar antenna	*18
2b	TRACKING	ditto	1400kHz 400Hz, 30% Mod	1400kHz STOP LEVEL: LOW	ditto	TC2, TC4 front end)	*19
3	AFC	ditto	1400kHz 400Hz, 30% Mod 46dB *5	ditto	DC voltmeter across pin 7 of IC7 and GND.	L9	less than 0.3V *20
4	NOISE AMP	ditto	600kHz 400Hz, 30% Mod 27dB *5	600kHz STOP LEVEL: LOW	⊕	VR5	*21
5	BEAT	—	—	AM bar antenna: Position of Maximum sensitivity STOP LEVEL: LOW	—	—	*22
6	9kHz FILTER	⊙	1000kHz 9kHz, 30% Mod	1000kHz	⊕	L4	Minimum deflection *23
IFT has been accurately adjusted by sweep generator. No further adjustment is necessary except for replacement of IFT or IC. While a full-scale adjustment using a sweep generator is desired, a simplified adjustment may be made as mentioned in 7.							
7a	IFT	—	—	slightly above 600kHz STOP LEVEL: LOW	—	—	*24
7b	IFT	—	—	ditto	—	—	*25
7c	IFT	⊙	455kHz 400Hz, 30% Mod 80dB *5	ditto	⊕	L2,3	*26

ADJUSTMENT

TEST INSTRUMENTS

- Oscilloscope
- AM signal generator AM-SG
- FM signal generator FM-SG
- Audio generator AG
- Solid state voltmeter SSVM
- FM multiplex generator FM-MPX
- Frequency counter
- DC voltmeter

NOTE ON ADJUSTMENT

*** 1**
Set the dial pointer to the right end of the dial calibrations. Position the preset markers at other than the right end.

*** 2**
Make sure that the dial pointer stops at the position where the preset marker is set. Check terminal 3 that its voltage is less than 3 V when the dial pointer stops. If it is not less than 3 V, readjust VR6 until it falls to less than 3 V. Make sure that the terminal 3 voltage will not fall below 10 V under the condition mentioned in "1. PRESET VOLTAGE"

*** 3**
Level corresponding to monophonic usable sensitivity (IHF).

*** 4**
First, using a signal generator output of sufficient level, tune to 95 MHz, and then adjust the signal generator output to a level corresponding to monophonic usable sensitivity (IHF). Then adjust the dial pulley position so that output waveform noise can be seen equally at top and bottom.

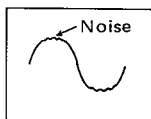

*** 5**
Means tuner input level. The loss of the dummy antenna, etc. must be taken into consideration for signal generator output level.

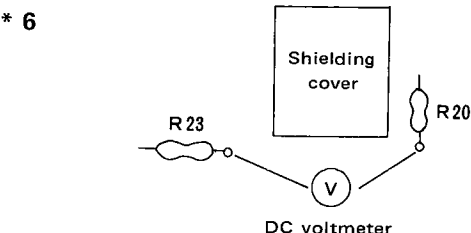

*** 7**
Turn VR4 counterclockwise until the output waveform disappears. Then turn VR4 clockwise until the output waveform appears again.

*** 8**
Install the dial pointer by referring to the paragraph of "Dial Cord Stringing". Adjust TC5 so that, when tuned from the left or right, the center line of the dial pointer will be within the range shown in the figure below regardless of tuning direction.

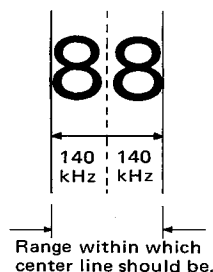

*** 9**
If 106 MHz frequency tuning cannot be correctly made, adjust the blade of the variable capacitor.

*** 10**
Check the output voltage that it is within the range of 0.8 to 1.2 V.

*** 11**
Check that the set is tuned to the SG signal in both directions, that the dial pointer stops there, and that the signal is received.

*** 12**
Check that the dial pointer stops when the set is tuned to an SG signal of 34,35 dB*⁵, and that the signal is received. At this time, two or more LEDs must light. When an SG signal of 60 dB*⁵ is received, check that four or more LEDs light.

*** 13**
Pinch the body of C32 with the clip on the positive end of SSVM, and apply the SSVM output to the frequency counter.

*** 14**
Set the selector on MPX-SG at L+R and adjust deviation to 68.25 kHz. When adjusting separation, move the selector to L or R.

ADJUSTMENT

* 15

Tune to 95 MHz from the lower side (left).

* 16

If crosstalk varies between L and R, adjust the L and R crosstalk values to a mean value of the two.

* 17

Check that the dial pointer stops where the preset marker is set. Check terminal 4 that its voltage is less than 3 V when the dial pointer stops. If it is not less than 3 V, readjust VR8 until it is less than 3 V. In this case, make sure that the terminal 4 voltage will not fall below 10 V under the condition mentioned in "1. PRESET VOLTAGE".

* 18

When making a tracking adjustment, forcibly stop the motor so that the dial pointer will not start moving unnecessarily. Stop the motor by grounding R94 in its front panel side (the base of Q13) and the crosspoint of R48 and R168. When the dial pointer need be moved, manually turn the dial pulley to move it.

Adjust L1 so that the maximum output point is 600 kHz. Then make the AM bar antenna parallel to the back panel, and move the bobbin until the output is at the maximum. The bobbin is fixed with wax so it need not be adjusted except in some special cases.

* 19

In the same way as 1a, adjust the maximum output point to 1,400 kHz.

* 20

Stop the motor as in tracking adjustment.

*21

Turn VR5 until the output waveform disappears. Then turn VR5 the other way until the output waveform appears again.

Also confirm the following:

- **LOW (1):** As the set is tuned to SG signal of "600 kHz, 400 Hz 30% modulation, 30 dB*5", the dial pointer stops, the set receives the signals, and two or more LEDs light.
- **LOW (2):** As the set is tuned to SG signal of "1,400 kHz, 400 Hz 30% modulation, 30 dB*5", the dial pointer stops, the set receives the signals, and two or more LEDs light.

- **HIGH (1):** As the set is tuned to SG signal of "600 kHz, 400 Hz 30% modulation, 42 to 46 dB*5", the dial pointer stops, the set receives the signals, and four or more LEDs light.

- **HIGH (2):** As the set is tuned to SG signal of "1,400 kHz, 400 Hz 30% modulation, 46 ~ 52 dB*5", the dial pointer stops, the set receives the signals, and four or more LEDs light.

- As an SG signal of 60 dB*5 is received, four or more LEDs must light.

* 22

The dial pointer must keep running. If it stops, it indicates beats are generated. In that case, raise the 27 dB*5 mentioned in "4. NOISE AMP" to 28 dB*, and make a readjustment.

* 23

Completely adjusted. No further adjustment is necessary except in some special cases.

* 24

Switch the power off when the dial pointer slightly passes 600 kHz.

* 25

Ground R94 in its front panel side (the base of Q13) and the crosspoint of R48 and R168 to prepare for stopping the motor, and then switch the power on.

* 26

Adjust L3 to obtain the largest good waveform. Set L2 at a point where the core is in by 1/10 from the largest good waveform.

RÉGLAGES

N°	ALIGNEMENT	APPAREILLAGE		RÉGLAGE DU TUNER	INDICATEUR DE SORTIE	POINTS DE RÉGLAGES	REMARQUES
		RACCORDEMENT	RÉGLAGE				
SECTION MF							
1	Voltage de Préréglage	—	—	SELECTOR: FM STOP LEVEL: LOW PRESET: ON aiguille du cadran *1.	Brancher le voltmètre cc aux points de réglages, 3 et GND, sur la plaque circuit imprimé du tuner (X05-1600)	VR 6	11V *2
2a	Accordage Central	Ⓐ	95MHz 1kHz (MODULATION) 75kHz (DÉVIATION) ENTRÉE ANT *3	95MHz STOP LEVEL: LOW VR4: tourner vers La droite à fond	Ⓑ	—	*4
2b	Accordage Central	idem	95MHz 1kHz (MODULATION) 75kHz (DÉVIATION) 60dB (ENTRÉE ANT)*5	idem	Brancher le voltmètre cc aux points de réglages, R20 et R23, sur la plaque circuit imprimé du tuner (X05-1600)	L7	0V
3	CAF	idem	Mettre en court-circuit le point auquel le voltmètre cc est relié (Voir 2b)	idem	Brancher le voltmètre cc aux points de réglages, 7 de IC7 et GND, sur la plaque circuit imprimé du tuner (X05-1600)	VR3	0V
4	Amplificateur de bruit	idem	95MHz 1kHz (MODULATION) 75kHz (DÉVIATION) ENTRÉE ANT*3	95MHz STOP LEVEL: LOW	Ⓑ	VR4	*7
5	Niveau de LED	idem	95MHz 1kHz (MODULATION) 75kHz (DÉVIATION) 90dB (ENTRÉE ANT) *5	idem	LEDs Indicateur de niveau linéaire	VR7	5 LED s'allument
6a	Alignement	idem	90MHz 1kHz (MODULATION) 75kHz (DÉVIATION)	90MHz STOP LEVEL: LOW	Position de l'aiguille du cadran	TC5	*8
6b	Alignement	idem	106MHz 1kHz (MODULATION) 75kHz (DÉVIATION)	106MHz STOP LEVEL: LOW	Ⓑ	TC1,3	Déviati on maximale *9
7	Distorsion	idem	95MHz 1kHz (MODULATION) 75kHz (DÉVIATION) 60dB (ENTRÉE ANT) *5	95MHz STOP LEVEL: LOW	idem	L8	Distorsion minimale *10
8a	Verificati on de niveau darrét	idem	95MHz 1kHz (MODULATION) 75kHz (DÉVIATION) 11 ~ 13dB (ENTRÉE ANT) *5	idem	idem	—	*11
8b	Verificati on niveau darrét	idem	95MHz 1kHz (MODULATION) 75kHz (DÉVIATION)	95MHz STOP LEVEL: HIGH	idem	—	*12
9	VCO Oscillateur Commandé en tension 76kHz	idem	95MHz 0(DÉVIATION) 60dB (ENTRÉE ANT) *5	95MHz	*13	VR1	76kHz
10	Séparati on	Ⓒ	95MHz *14 1kHz (MODULATION) 60dB (ENTRÉE ANT) LOUR (SELECTEUR)	95MHz *15	Ⓑ	VR2	Diaphonie minimale
11	TFI	idem	95MHz 1kHz (MODULATION) 68, 25kHz (DÉVIATION) 60dB (ENTRÉE ANT) L+R (SELECTEUR)	95MHz	idem	T1	Distorsion minimale

RÉGLAGES

N°.	ALIGNEMENT	APPAREILLAGE		RÉGLAGE DU TUNER	INDICATEUR DE SORTIE	POINTS DE RÉGLAGES	REMARQUES
		RACCORDEMENT	RÉGLAGE				
SECTION MA							
1	Voltage de pré réglage	—	—	SELECTOR:AM STOP LEVEL: LOW PRESET:ON aiguille du cardan *1	Brancher le voltmètre cc aux points de régl- ages 4 et GND, sur la plaque circuit imprimé du tuner (x05-1600)	VR8	*17
2a	Alignement	Ⓣ	600kHz 400Hz, 30% (MODULATION)	600kHz STOP LEVEL: LOW	Ⓣ	L1 antenne ferrite MA	*18
2b	Alignement	idem	1400kHz 400 Hz, 30% (MODULATION)	1400kHz STOP LEVEL: LOW	idem	TC2,4	*19
3	CAF	idem	1400Hz, 30% (MODULATION) 46dB (ENTRÉE ANT)*5	idem	Brancher le voltmètre cc aux points de régl- ages 7 de IC7 et GND, sur la plaque circuit imprimé du tuner (05-1600-)	L9	*20
4	Amplificateur de bruit	idem	600kHz 400Hz 30% Modulation 27dB (ENTRÉE ANT)*5	600kHz STOP LEVEL: LOW	Ⓣ	VR5	*21
5	Battement	—	—	antenne ferrite MA: STOP LEVEL: LOW	—	—	*22
6	Filtre 9KHz	Ⓣ	1000 KHz 9kHz, 30% (MODULATION)	1000kHz	Ⓣ	L4	Dévi- ation minimale
TFI a été réglé avec précision par le générateur de balayage, Aucun réglage supplémentaire n'est nécessaire sauf pour le remplacement de TFI ou IC. Bien qu'un réglage complet à l'aide d'un générateur de balayage soit désirable, un réglage simple peut être effectué comme indiqué dans 7.							
7a	TFI	—	—	Un peu au-dessus de 600kHz STOP LEVEL:LOW	—	—	*24
7b	TFI	—	—	idem	—	—	*25
7c	TFI	Ⓣ	455kHz 400Hz, 30% (MODULATION) 80dB (ENTRÉE ANT)*5	idem	Ⓣ	L2,3	*26

RÉGLAGES

APPAREILLAGE

Oscilloscope
 Générateur MAAM-SG
 Générateur MF FM-SG
 Générateur audio fréquences AG
 Voltmètre à transistor SSVM
 Générateur multiplex stéréo FM-MPX
 Fréquencemètre
 Voltmètre cc

REMARQUE SUR LE RÉGLAGE

*** 1**

Régler l'aiguille du cadran sur l'extrémité droite du cadran étalonné. Positionner les repères de préréglage sur un emplacement autre que l'extrémité droite.

*** 2**

S'assurer que l'aiguille du cadran s'arrête sur la position préréglée par les repères de préréglage. S'assurer que la tension à la borne 3 est inférieure à 3 V. Si elle est supérieure à 3 V, re-régler VR6 jusqu'à ce qu'elle tombe en dessous de 3 V. Puis s'assurer que la tension n'est pas inférieure à 10 V à la borne 3 sous les conditions indiquées dans "1. TENSION DE PRÉRÉGLAGE".

*** 3**

Le niveau de sortie correspond à la sensibilité monophonique utile (IHF).

*** 4**

D'abord accorder le tuner sur 95 MHz en appliquant une sortie de générateur simple d'un niveau correspondant à la sensibilité monophonique utile (IHF). Puis régler la position de la poulie du cadran en sorte que le bruit de forme d'onde de sortie puisse être vu de façon égale sur le haut et sur le bas.

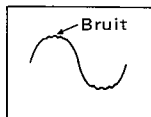

*** 5**

Niveau d'entrée du tuner.

La perte de l'antenne artificielle, etc. doivent être pris en considération lors du réglage du niveau de sortie du générateur de signal.

*** 6**

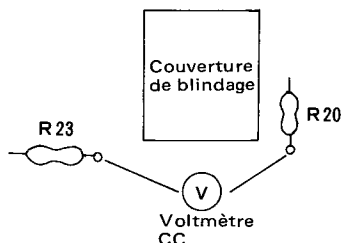

*** 7**

Tourner VR4 vers la gauche jusqu'à ce que la forme d'onde de sortie disparaisse. Puis tourner VR4 vers la droite jusqu'à ce que la forme d'onde de sortie apparaisse à nouveau.

*** 8**

Installer l'aiguille du cadran en se référant au paragraphe "Comment tendre la corde du cadran". Régler TC5 de sorte que l'axe de l'aiguille du cadran s'arrête à l'intérieur de la gamme montrée dans la figure quelle que soit la direction de l'accord.

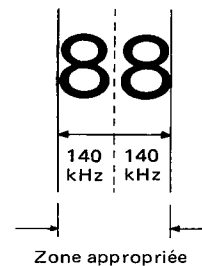

*** 9**

Si le signal de 106 MHz n'est pas accordé correctement, ajuster l'écart entre les lames du condensateur variable.

*** 10**

S'assurer que la tension de sortie est à l'intérieur de 0,8 à 1,2 V.

*** 11**

S'assurer que le signal SG est accordé dans les deux directions. L'aiguille du cadran s'arrête en la position où le signal est reçu.

*** 12**

S'assurer que l'aiguille du cadran s'arrête quand le signal 34 dB ou 35 dB est accordé et que deux LEDs ou plus s'allument. S'assurer également que quatre LEDs ou plus s'allument quand le signal de 60 dB est reçu.

*** 13**

Serrer le corps de C32 avec des pinces à la ligne positive de SSVM, et appliquer la sortie de SSVM à un fréquencemètre.

*** 14**

Placer le sélecteur L+R sur MPX-SG et régler les déviations sur 68,25 kHz. Lors du réglage de la séparation, tourner le sélecteur sur L ou R (G ou D).

*** 15**

Accorder sur 95 MHz à partir de la fréquence inférieure.

RÉGLAGES

* 16

Si la diaphonie varie entre L et R (G et D) régler les valeurs de diaphonie de L et de R (G et D) sur une valeur moyenne des deux.

* 17

S'assurer que l'aiguille du cadran s'arrête sur la position du repère du pré-réglage. Vérifier également la tension à la borne 4, qui devrait être inférieure à 3 V en cette position. Si elle excède 3 V, re-régler VR8 jusqu'à ce que la tension tombe jusqu'au dessous de 3 V.

Puis s'assurer que la tension n'est pas inférieure à 10 V à la borne 4 sous les conditions indiquées dans "1. TENSION DE PRÉRÉGLAGE".

* 18

Pour effectuer un réglage exact, il faut arrêter le moteur afin que l'aiguille du cadran ne bouge inutilement. Arrêter le moteur en mettant à la terre la borne du panneau avant de R94 (la base de Q13) et le point de couplage de R48 et R168. Quand il s'avère nécessaire de déplacer l'aiguille du cadran, tourner la poulie du cadran à la main.

Régler L1 en sorte que la sortie maximale soit obtenue à 600 kHz. Puis rendre l'antenne en ferrite articulée parallèle au panneau arrière, et déplacer la bobine jusqu'à ce que la sortie soit à son maximum. La bobine est fixée avec de la cire, de sorte qu'il n'est pas nécessaire de l'ajuster sauf dans certains cas spéciaux.

* 19

Régler TC2 et TC4 de sorte que la sortie maximale soit obtenue à 1.400 kHz.

* 20

Arrêter le moteur comme décrit pour le réglage exact.

* 21

Tourner VR5 jusqu'à ce que la forme d'onde de sortie disparaisse. Puis tourner VR5 dans l'autre sens jusqu'à ce que la forme d'onde apparaisse à nouveau.

Puis vérifier les points suivants:

- **LOW (1):** Quand l'appareil est accordé sur un signal SG de 600 kHz, 400 Hz, 30% de modulation et 30 dB, l'aiguille du cadran s'arrête, l'appareil reçoit le signal, et deux LEDs ou plus s'allument.
- **LOW (2):** Quand l'appareil est accordé sur un signal SG de 1.400 kHz, 400 Hz, 30% de modulation et 30 dB, l'aiguille du cadran s'arrête, l'appareil reçoit le signal, et deux LEDs ou plus s'allument.
- **HIGH (1):** Quand l'appareil est accordé sur un signal SG de 600 kHz, 400 Hz, 30% de modulation et 42 – 46 dB, l'aiguille du cadran s'arrête, l'appareil reçoit

le signal, et quatre LEDs ou plus s'allument.

- **HIGH (2):** Quand l'appareil est accordé sur un signal SG de 1.400 kHz, 400 Hz, 30% de modulation et 46 – 52 dB, l'aiguille du cadran s'arrête, l'appareil reçoit le signal, et quatre LEDs ou plus s'allument.
- Quatre LEDs ou plus s'allument quand un signal SG de 60 dB est reçu.

* 22

L'aiguille du cadran doit rester en mouvement. Son arrêt pourrait générer des battements dans le circuit intérieur. Si c'est le cas, élever les 27 dB indiqués dans "4. NOISE AMP" jusqu'à 28 dB, et effectuer un re-réglage.

* 23

Le réglage est achevé. Aucun réglage supplémentaire n'est nécessaire sauf pour certains cas spéciaux.

* 24

Débrancher l'alimentation quand l'aiguille du cadran a légèrement dépassé 600 kHz.

* 25

Mettre la borne du panneau avant de R94 (la base de Q13) et le point de couplage de R48 et R168 à la terre pour arrêter le moteur avant de brancher l'alimentation.

* 26

Régler L2 et L3 pour obtenir la forme d'onde maximale. Puis enfoncer en le vissant le noyau de L2 jusqu'à 1/10 de profondeur hors de la position dans laquelle la forme d'onde maximale est obtenue.

ABGLEICH

Nr.	ABGLEICH	PRÜFEINRICHTUNG		TUNER EINSTELLUNG	AUSGANGS- ANZEIGE	EINSTELL- PUNKT	BEMERKUNGEN
		ANSCHLÜSSE	EINSTELLUNG				
KW- EMPFANGSABTEILUNG							
1	VOREINGESTELLTE SPANNUNG	—	—	SELECTOR: FM STOP LEVEL: LOW PRESET: ON Skalenzeiger *1	Gleichspannungsmesser über Klemme 3 von X05-1600 und Erdklemme	VR6	11V *2
2a	ABSTIMMITTE	Ⓐ	95MHz 1kHz, ±75kHz (Hub) LEISTUNG *3	95MHz STOP LEVEL: LOW VR4: Bis zum Anschlag im Uhrzeigersinn drehen	ⓑ	—	*4
2b	ABSTIMMITTE	dito	95MHz 1kHz, ±75kHz (Hub) 60dB *5	dito	Gleichspannungsmesser über R20 und R23	L7	0V
3	AUTOMATISCHE FREQUENZREGELUNG	dito	Den Punkt Kurzschließen, an dem der Gleichspannungsmesser eingesetzt ist (2b)	dito	Gleichspannungsmesser über Stift 7 von IC 7 und Erdklemme	VR3	0V
4	GERÄUSCHVERSTÄRKER	dito	95MHz 1kHz, ±75kHz (Hub) LEISTUNG *3	95MHz STOP LEVEL: LOW	ⓑ	VR4	*7
5	LEUCHTDIODEN- DENPEGEL	dito	95MHz 1kHz, ±75kHz (Hub) 90dB *5	dito	Leuchtdioden (Linearpegelanzeige)	VR7	5 Leuchtdioden leuchten auf
6a	EMPFANGSBEREICH	dito	90MHz 1kHz, ±75kHz (Hub)	90MHz STOP LEVEL: LOW	Skalenzeiger	TC5 (Eingangsstufe)	*8
6b	EMPFANGSBEREICH	dito	106MHz 1kHz, ±75kHz (Hub)	106MHz STOP LEVEL: LOW	ⓑ	TC1, 3 Eingangsstufe)	Maximaler Ausschlag *9
7	KLIRRFAKTOR	dito	95MHz 1kHz, ±75kHz (Hub) 60dB *5	95MHz STOP LEVEL: LOW	dito	L8	Minimaler klirr *10
8a	STOPPEL- ÜBERPRÜFUNG	dito	95MHz 1kHz, ±75kHz (Hub) 11~13dB *5	dito	dito	—	*11
8b	STOPPEL- ÜBERPRÜFUNG	dito	95MHz 1kHz, ±75kHz (Hub)	95MHz STOP LEVEL: HIGH	dito	—	*12
9	SPANNUNGS- GEREGELTER OSZILLATOR	ⓒ	95MHz 0 (Hub) 60dB *5	95MHz	*13	VR1	76kHz
10	STEREO KANAL- TRENnung	dito	95MHz *14 1kHz 60dB *5 Wähler: L order R	95MHz *15	ⓑ	VR2	Minimaler Übersprechen
11	ZF-T	dito	95MHz, 1kHz ±68.25kHz (Hub) 60dB *5 Wähler: L+R	95MHz	dito	T1	Minimaler Klirr (Geringe Justierung)

ABGLEICH

Nr.	ABGLEICH	PRÜFEINRICHTUNG		TUNER EINSTELLUNG	AUSGANGS- ANZEIGE	EINSTELL- PUNKT	BEMERKUNGEN
		ANSCHLÜSSE	EINSTELLUNG				
MW-EMPFANGSABTEILUNG							
1	VOREINGESTELLTE SPANNUNG	—	—	SELECTOR: AM STOP LEVEL: LOW PRESET: ON Skalenzeiger *1	Gleichspannungsmesser über Klemme 4 von X05-1600 und Erdklemme	VR8	mehr als 10V *17
2a	EMFANGSBEREICH	⊙	600kHz 400Hz, 30% Modulation	600kHz STOP LEVEL: LOW	⊙	L1 MW-Ferritantenne	*18
2b	EMPFANGSBEREICH	dito	1400kHz 400Hz, 30% Modulation	1400kHz STOP LEVEL: LOW	dito	TC2, TC4 (Eingangsstufe)	*19
3	AUTOMATISCHE FREQUENZREGELUNG	dito	1400kHz 400Hz, 30% Modulation 46dB *5	dito	Gleichspannungsmesser über Stift 7 von IC 7 und Erdklemme	L9	weniger als 0, 3V
4	GERÄUSCHVERSTÄRKER	dito	600kHz 400Hz, 30% Modulation 27dB *5	600kHz STOP LEVEL: LOW	⊙	VR5	*21
5	ÜBERLAGERUNG	—	—	MW-Ferritantenne: Position für maximale Empfindlichkeit STOP LEVEL: LOW	—	—	*22
6	9kHz-FILTER	⊙	1000kHz 9kHz, 30% Modulation	1000kHz	⊙	L4	Minimaler Ausschlag *23
<p>ZF-T wurde durch den kippgenerator genau eingestellt. Mit Ausnahme der ZF-T — order IC — Auswechslungen ist keine weitere Einstellung erforderlich. Obwohl eine vollständige Einstellung mit Hilfe eines kippgenerators wünschenswert ist, kann eine vereinfachte Einstellung gemäß 7 vorgenommen werden.</p>							
7a	ZF-T	—	—	STOP LEVEL: LOW	—	—	*24
7b	ZF-T	—	—	dito	—	—	*25
7c	ZF-T	⊙	455kHz 400Hz, 30% Modulation 80dB *5	dito	⊙	L2, 3	*26

ABGLEICH

ABGLEICH

PRÜFINSTRUMENTE

Oszilloskop	
MW-Signalgenerator	AM-SG
UKW-Signalgenerator	FM-SG
NF-Signalgenerator	AG
Transistor-Voltmeter	SSVM
UKW-Multiplexgenerator	FM-MPX
Frequenzzähler	
Gleichspannungsmesser	

ANMERKUNGEN ZUR EINSTELLUNG

* 1

Den Skalenzeiger auf die rechte Seite der Skaleneichnung bewegen. Die Voreinstellmarken beliebig, jedoch nicht zum rechten Ende bewegen.

* 2

Darauf achten, daß der Skalenzeiger bei der Voreinstellmarke zum Stillstand kommt. Nachprüfen, ob die Spannung der Klemme 3 weniger als 3 V beträgt, wenn der Skalenzeiger zum Stillstand kommt. Falls die Spannung nicht weniger als 3 V beträgt, VR6 so verstellen, daß sie auf unter 3 V abfällt. In diesem Falle ist darauf zu achten, daß die Spannung der Klemme 3 bei dem im Abgleich "1. VOREINGESTELLTE SPANNUNG" auf nicht unter 10 V abfällt.

* 3

Pegel entsprechend der monotonen Nutzemfänglichkeit (IHF).

* 4

Zuerst mit Hilfe eines Signalgeneratorausgangs mit ausreichendem Pegel auf 95 MHz abstimmen, dann den Signalgeneratorausgang auf einen Pegel einregeln, der der monotonen Nutzemfänglichkeit (IHF) entspricht. Danach die Skalenschnurscheibenposition so einstellen, daß das Ausgangswellenformgeräusch oben und unten gleich erscheint.

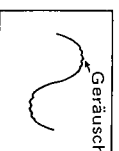

* 5

Bedeutet Tuner-Eingangsspegel. Beim Signalgenerator-Ausgangspegel muß der Verlust der Kunstantenna usw. berücksichtigt werden.

* 6

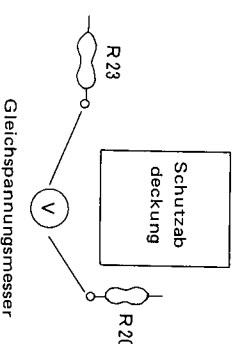

* 7

VR4 entgegen dem Uhrzeigersinn drehen, bis die Ausgangswellenform verschwindet. Dann VR4 im Uhrzeigersinn drehen, bis die Ausgangswellenform wieder erscheint.

* 8

Den Skalenzeiger gemäß dem Abschnitt "Spannen der Skalenschnur DIAL CORD STRINGING" anbringen. TC5 so einstellen, daß sich beim Abstimmen von links oder rechts die Mittellinie des Skalenzeigers ohne Rücksicht auf die Abstimmrichtung innerhalb des in der Abbildung gezeigten Bereiches befindet.

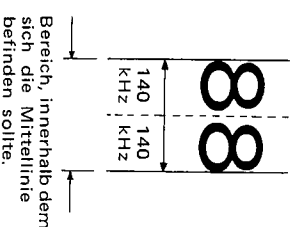

* 9

Falls die 106 MHz-Frequenzabstimmung nicht richtig vorgenommen werden kann, die Lamelle des Drehkondensators verstellen.

* 10

Nachprüfen, ob sich die Ausgangsspannung innerhalb des Bereiches von 0,8 bis 1,2 V befindet.

* 11

Nachprüfen, ob das Gerät auf das Signalgenerator-Signal in beiden Richtungen abgestimmt ist, ob der Skalenzeiger dort zum Stillstand kommt und ob das Signal empfangen wird.

* 12

Nachprüfen, ob der Skalenzeiger bei Abstimmung des Geräts auf ein Signalgenerator-Signal von 34 oder 35 dB*5 zum Stillstand kommt und ob das Signal empfangen wird. Dabei müssen zwei oder mehr Leuchtdioden aufleuchten. Wenn ein Signalgenerator-Signal von 60 dB*5 empfangen wird, nachprüfen, ob vier oder mehr Leuchtdioden aufleuchten.

* 13

Den Körper von C32 mit der Klemme am heißen Ende Transistor-Voltmeter (SSVM) festklemmen und den Transistor-Voltmeter-Ausgang dem Frequenzzähler zuleiten.

* 14

Den Wahlschalter am Multiplexgenerator auf L+R einstellen und der Hub auf 68,25 KHz einregeln.

Beim Einstellen der Trennung den Wahlschalter auf L oder R bewegen.

* 15

Von der unteren Seite (links) aus auf 95 MHz abstimmen.

* 16

Falls sich das Übersprechen zwischen L und R ändert, die L- und R-Übersprechwerte auf einen Mittelwert der beiden einregeln.

* 17

Nachprüfen, ob der Skalenzeiger an der Voreinstellmarke zum Stillstand kommt. Nachprüfen, ob die Spannung der Klemme 4 weniger als 3 V beträgt, wenn der Skalenzeiger zum Stillstand kommt. Falls die Spannung nicht weniger als 3 V beträgt, VR8 so verstellen, daß sie weniger als 3 V beträgt. In diesem Falle ist darauf zu achten, daß die Spannung der Klemme 4 bei dem im Abgleich "1. VOREINGESTELLTE SPANNUNG" auf nicht unter 10 V abfällt.

* 18

Bei einer Empfangsbereich den Motor abstellen, so daß sich nicht unnötig zu bewegen beginnt. Den Motor durch Erden des Frontplattenendes von R94 (Basis von Q13) und des Kreuzungspunktes von R48 und R168 abstellen. Wenn der Skalenzeiger bewegt werden muß, die Skalenschnurscheibe mit der Hand drehen. L1 so einstellen, daß der maximale Ausgang 600 KHz beträgt.

Danach die MW-Ferritantenna parallel zur Rückwand einstellen und die Spule bewegen, bis der maximale Ausgang erzielt wird. Die mit Wachs befestigte Spule braucht nur in besonderen Fällen verstellt zu werden.

* 19

Genauso wie bei la den maximalen Ausgang auf 1,400 KHz einstellen.

* 20

Den Motor wie bei der Empfangsbereich abstellen.

* 21

VR5 drehen, bis die Ausgangswellenform verschwindet.

Dann VR5 in die andere Richtung drehen, bis die Ausgangswellenform wieder erscheint.

Außerdem sind die folgenden Punkte zu überprüfen.

o **LOW (1):** Bei Abstimmung des Gerätes auf das Signalgenerator-Signal "600 KHz, 400 Hz 30% Modulation, 30 dB*5" kommt der Skalenzeiger zum Stillstand, das Gerät empfängt die Signale und zwei oder mehr Leuchtdioden leuchten auf.

o **LOW (2):** Bei Abstimmung des Gerätes auf das Signalgenerator-Signal "1,400 KHz, 400 Hz 30% Modulation, 30 dB*5" kommt der Skalenzeiger zum Stillstand, das Gerät empfängt die Signale und zwei oder mehr Leuchtdioden leuchten auf.

o **HIGH (1):** Bei Abstimmung des Gerätes auf das Signalgenerator-Signal "600 KHz, 400 Hz 30% Modulation, 42 bis 46 dB*5" kommt der Skalenzeiger zum Stillstand, das Gerät empfängt die Signale und vier oder mehr Leuchtdioden leuchten auf.

o **HIGH (2):** Bei Abstimmung des Gerätes auf das Signalgenerator-Signal "1,400 KHz, 400 Hz 30% Modulation, 46 bis 52 dB*5" kommt der Skalenzeiger zum Stillstand, das Gerät empfängt die Signale und vier oder mehr Leuchtdioden leuchten auf.

o Wenn ein Signalgenerator-Signal mit 60 dB*5 empfangen wird, müssen vier oder mehr Leuchtdioden aufleuchten.

* 22

Der Skalenzeiger muß ständig laufen. Wenn er zum Stillstand kommt, wird dadurch angezeigt, daß Überlagerungen erzeugt werden. In diesem Falle die in "4. GERÄUSCH-VERSTÄRKER" erwähnten 27 dB*5 auf 28 dB*5 erhöhen und eine Neueinstellung vornehmen.

* 23

Vollständig eingestellt. Außer in einigen Sonderfällen ist keine weitere Einstellung erforderlich.

* 24

Das Gerät ausschalten, wenn sich der Skalenzeiger etwas über 600 KHz bewegt.

* 25

Das Frontplattenende von R94 (Basis von Q13) sowie den Kreuzungspunkt von R48 und R168 als Vorbereitung zum Abstellen des Motors erden und dann das Gerät einschalten.

* 26

L3 so einstellen, daß die größte gute Wellenform erzielt wird.
L2 so einstellen, daß sich der Kern von der größten Wellenform aus um 1/10 innen befindet.

ADJUSTMENT/RÉGLAGE, ABGLEICH

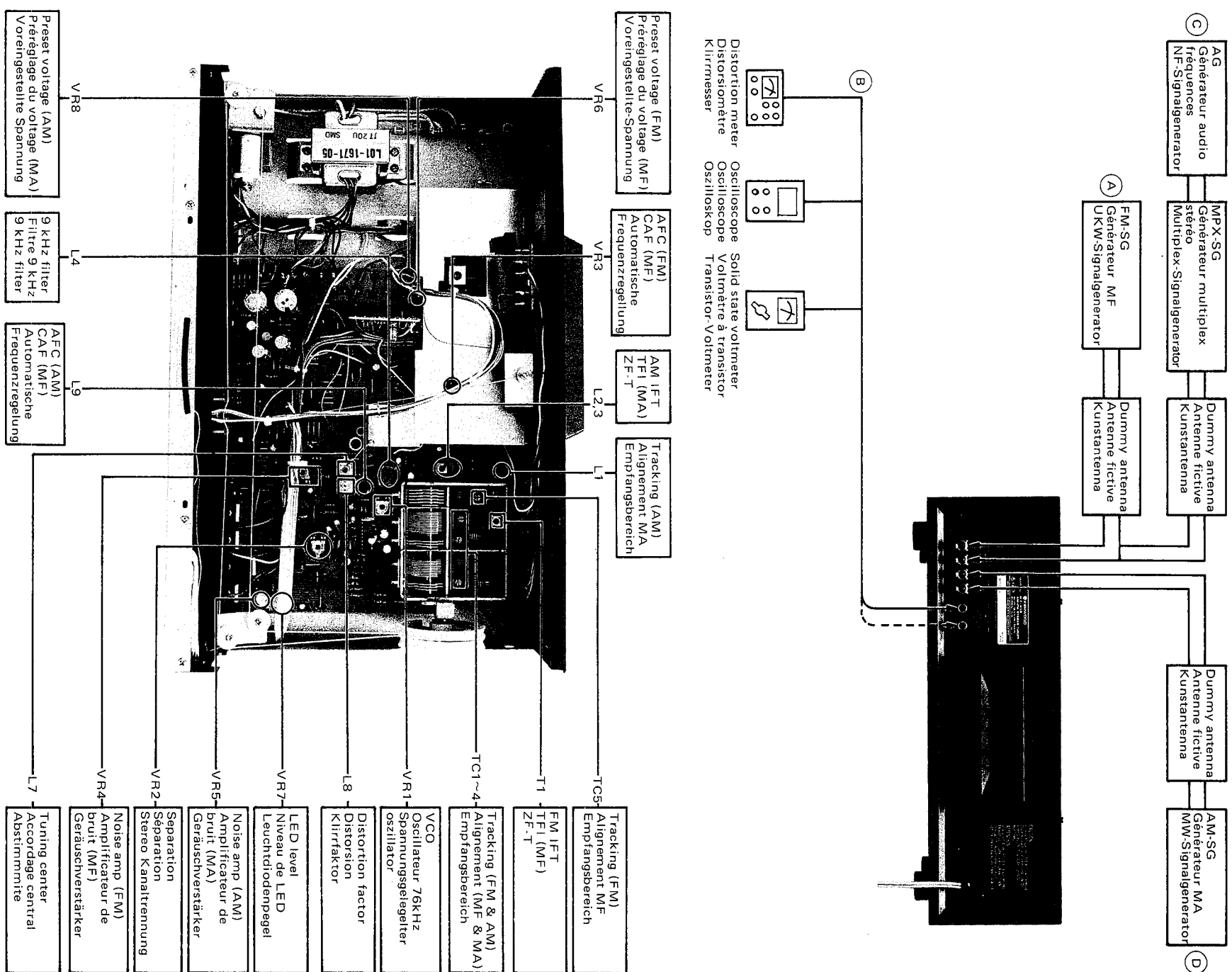

SEMICONDUCTOR SUBSTITUTIONS / PC BOARD

PC board ass'y	Ref. No.	Semiconductor Name	Semiconductor Substitutions
X05-1600-11	Q1~3, 12, 20	2SK105(H,J) or 2SK68(M,N)	2SK117, 2SK30A
	Q4	2SC1222(U) or 2SC1681	-
	Q5~8, 16, 17	2SC828A or 2SC945(P,Q)	2SC1890, 2SC734, 2SC1213A
	21, 23, 24	2SA564A(Q,R) or 2SA733A(R,Q)	2SA561, 2SB725
	Q9, 10	2SC1735(E)	2SC1567
	Q11, 13	2SA850(E)	2SA794, 2SA794A
	Q14, 22	2SC1567(R,Q)	PC ≥ 800 mW PC ≥ 1.2 W
	Q18	2SK55	2SK19
	Q1	2SC535	2SC381, 2SC785
	Q2	2SC535	-
Q3	2SC461	-	

PC BOARD

FRONT END (W02-0017-05)

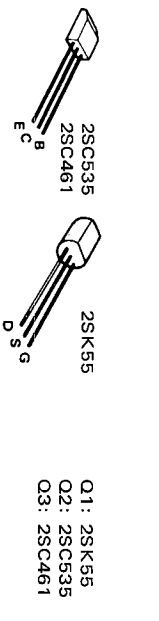
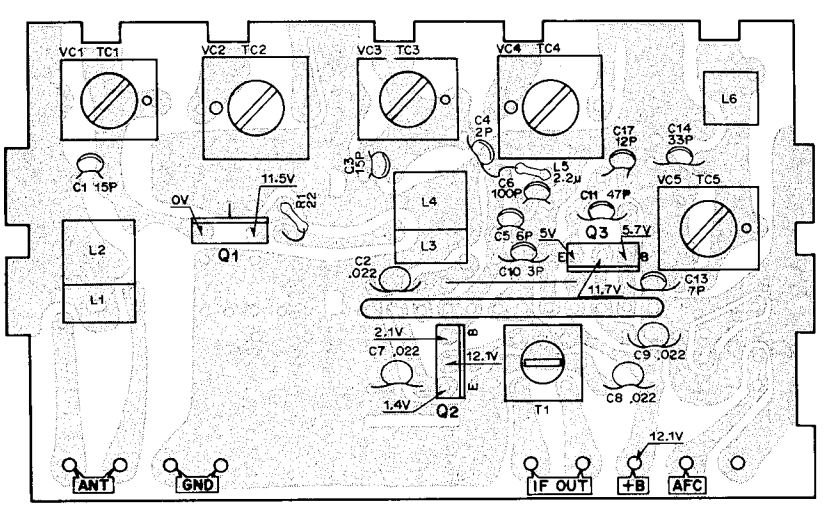

PC BOARD

PC BOARD

TUNER (X05-1600-11)

Serial No. : less than 930001

SUB PC Board Ass'y

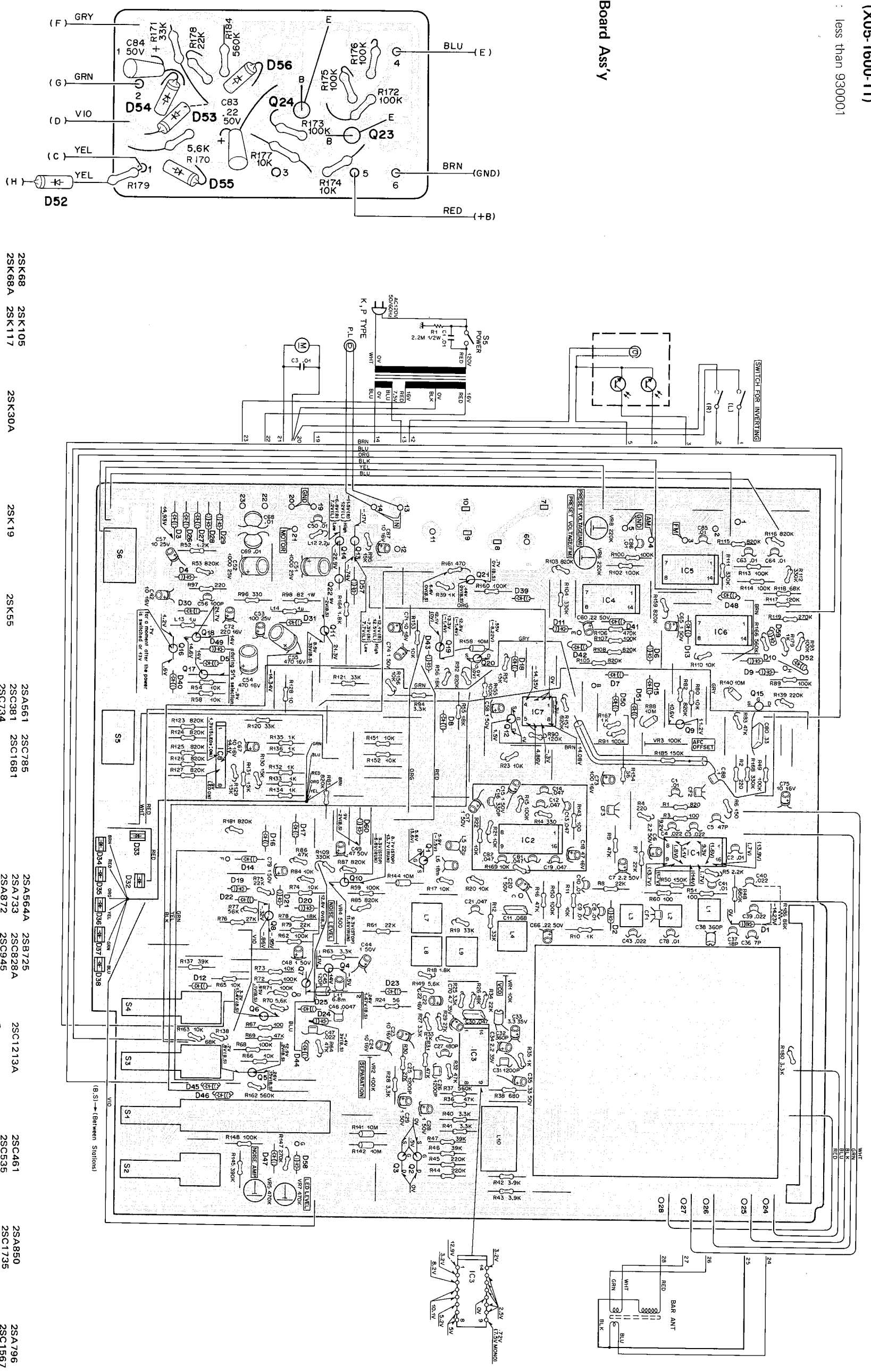

- 2SK68 2SK105
- 2SK68A 2SK117
- 2SK30A
- 2SK19
- 2SK55
- 2SA561 2SC785
- 2SC381 2SC1681
- 2SC734
- 2SA564A 2SB725
- 2SA733 2SC828A
- 2SC381 2SC945
- 2SA872 2SC1222
- 2SA954 2SC1755
- 2SA984K 2SC1890
- 2SA992
- 2SC1213A
- 2SC461 2SC535
- 2SC535
- 2SA850 2SC1735
- 2SC1735
- 2SA796 2SC1567
- 2SC1567

PC BOARD

PC BOARD

TUNER (X05-1600-11)

Serial No. : from 930001.

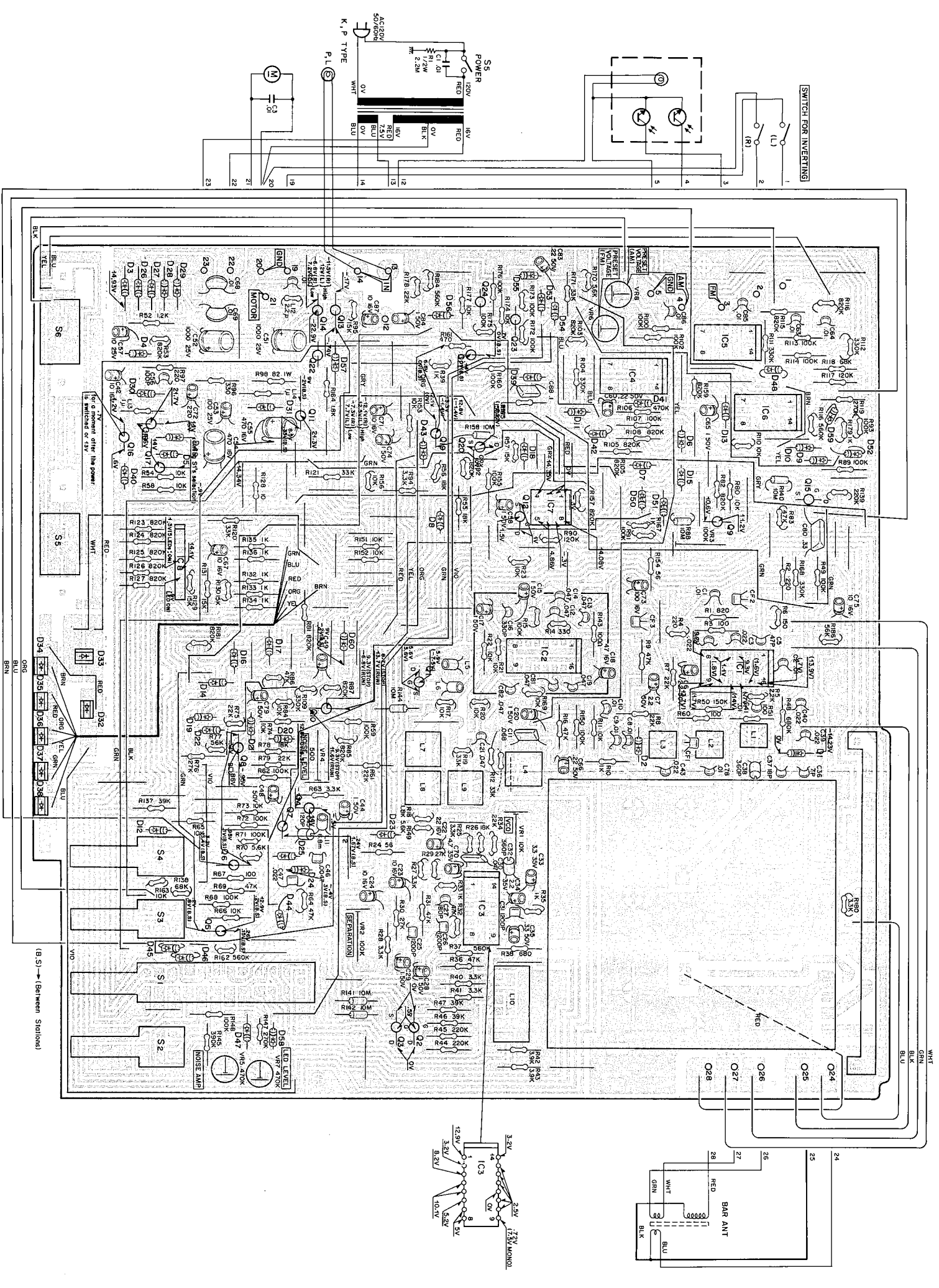

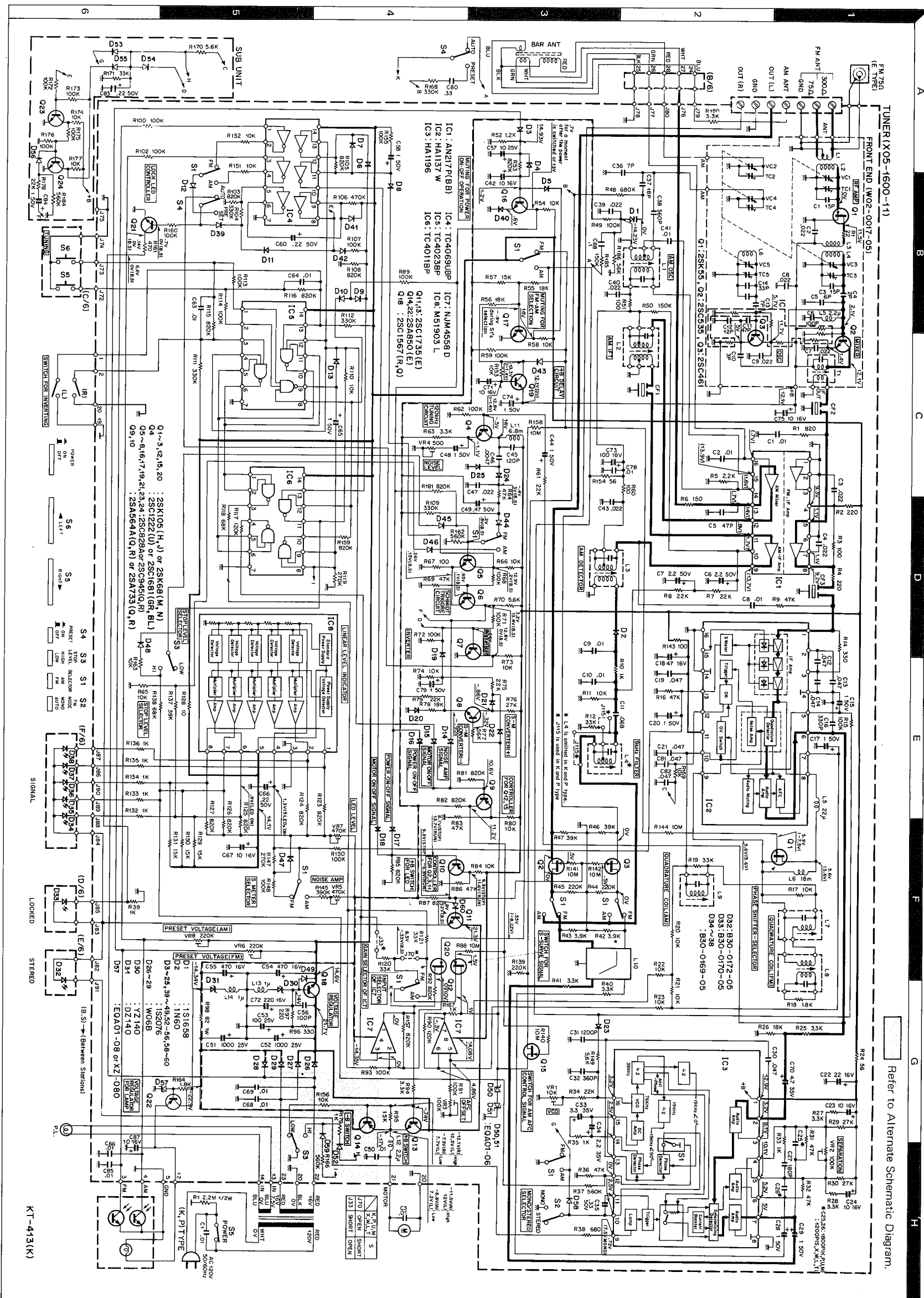

Refer to Alternate Schematic Diagram.

SPECIFICATIONS

FM TUNER SECTION	
Sensitivity (DIN)	0.9µV
Mono: S/N 28 dB, 40 kHz Dev.	0.9µV
Stereo: S/N 48 dB, 48 kHz Dev.	20µV
50 dB Quieting Sensitivity Mono (IHF)	40µV
Limiting Level	0.5µV
Frequency Response	30 Hz ~ 15 kHz ± 0.2 dB
Total Harmonic Distortion (DIN)	0.1%
Mono: 1 kHz, 40 kHz Dev.	0.15%
Stereo: 1 kHz, 48 kHz Dev.	0.15%
S/N Weighted (DIN)	75 dB
Mono: 40 kHz Dev., 1 mV Input	67 dB
Stereo: 48 kHz Dev., 1 mV Input	67 dB
S/N Unweighted (IHF)	77 dB
Mono: 75 kHz Dev., 1 mV Input	72 dB
Stereo: 75 kHz Dev., 1 mV Input	59 dB
Image Rejection Ratio	53 dB
Selectivity	80 dB
300 kHz, 20 dB Input	85 dB
IF Rejection Ratio	40 dB
AM Suppression Ratio	6.3 kHz
Splurture Response Ratio	12.5 kHz
AM TUNER SECTION	35 dB
Sensitivity S/N 20 dB	1.0 dB
S/N: 1 mV Input	16µV
Image Rejection Ratio	48 dB
GENERAL	45 dB
Power Consumption	13 watts
Dimensions	W 400 mm
	H 139 mm
	D 280 mm
Weight (Net)	4.2 kg

Note: Kenwood follows a policy of continuous advancements in development. For this reason specifications may be changed without notice.

- 2SK68 2SK105
- 2SK68A 2SK117
- 2SK30A
- 2SK19
- 2SK55
- 2SA61 2SC785
- 2SC81 2SC1681
- 2SC34
- 2SA64 2SB725
- 2SA73 2SC28A
- 2SA87 2SC945
- 2SA94 2SC1222
- 2SA98A 2SC1755
- 2SA992 2SC1890
- 2SC1213A
- 2SC461 2SC535
- 2SA850 2SC1735
- 2SA796 2SC1567

KT-413(K)

ALTERNATE SCHEMATIC DIAGRAMS

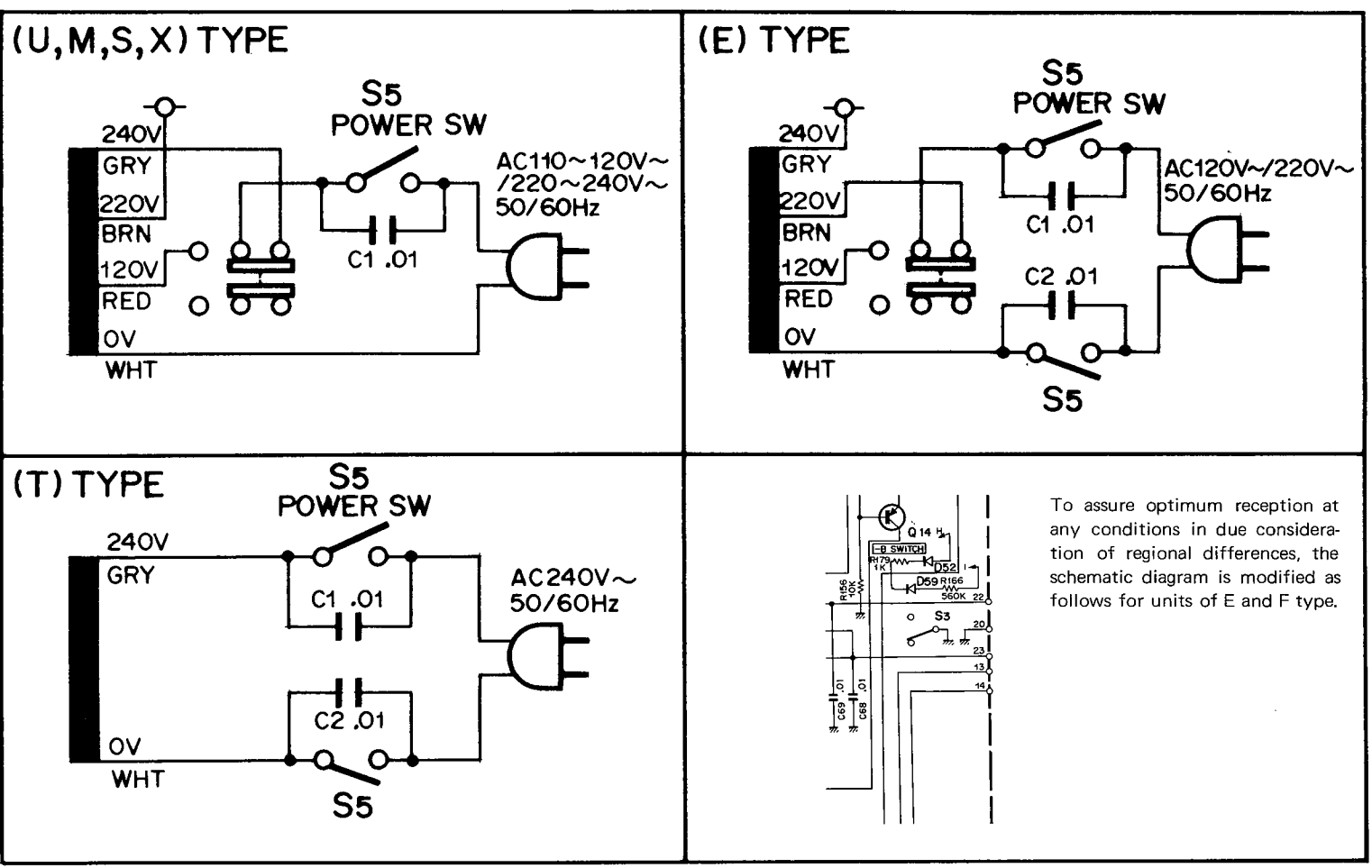

TRIO-KENWOOD CORPORATION
 A product of
 6-17, 3-chome, Aobadai, Meguro-ku, Tokyo 153, Japan

- KENWOOD ELECTRONICS, INC.**
 1315 E. Watsoncenter Rd, Carson, California 90745
- TRIO-KENWOOD ELECTRONICS, N.Y.**
 75 Seaview Drive, Secaucus, New Jersey 07094, U.S.A.
- TRIO-KENWOOD ELECTRONICS GmbH**
 Leuvenessesteenweg 184 B-1930 Zaventem, Belgium
- TRIO-KENWOOD FRANCE S.A.**
 Rudolf-Bras-Str. 20, 6056 Heusenstamm, West Germany
- TRIO-KENWOOD SVENSKA AB**
 5, Boulevard Ney, 75018 Paris, France
- TRIO-KENWOOD (AUSTRALIA) PTY. LTD.**
 Kennisvagen 10A, S-183 21 Täby, Sweden
- TRIO-KENWOOD (AUSTRALIA) PTY. LTD.**
 30 Whiting St., Artarmon, N.S.W. 2064, Australia
- KENWOOD & LEE ELECTRONICS, LTD.**
 Room 501, Wang Kee Building, 5th Floor, 34-37, Connaught Road, Central, Hong Kong