

IC1, 2	8401
IC3	LM7001
IC4	LA1266
IC5, 9	M5218P
IC6, 13, 14, 21	M5223P
IC7, 8, 23, 24	μPCT8L102
IC10	LA3401
IC12, 26	NM4860D
IC16	μPD4069UBC
IC20	μPD4013BC
IC22	LA7910
IC25	μPC1163HA
IC27	μPCT805HF

Q1, 2	35K122(L1)
Q3	25K241(GR)
Q4, 6	25C1923(R, O)
Q5	25K2651(T, GR)
Q7, 8	25K105(F, M)
Q9, 21, 22, 43	25K733(AHQ, PI) or 25A9355(I, R)
Q10	25K364(GR, BL)
Q19, 20, 28, 31, 32, 46	25C843(AHQ, PI) or 25C17405(I, R)
Q14	DT144ES
Q15	DT144ES
Q25	25D1286(I, P)
Q26, 27	25D863(E, F)

Q41, 42	25D30215(T)
Q44, 45	25A611(F, GR)
Q47	25A63(M)
D1 - 3, 8	μA320-4
Q4 - 6, 13, 18	1, 36, 38, 43-45, 70-74, 85-89
92-96, 99	102-111, 113, 155155 or M55104
D10	μA234-22
Q20-25, 26	27, 32, 33, 40
255KAB	
Q24	μA115(B) or M254.7(NB)
Q25	μA115(B2) or M255.15(B2)
D34, 35	μA115(B2) or M255.1(NB2)
D97, 98	N4C
D14	E-272

D100 : R08.2
D101 : K1V222

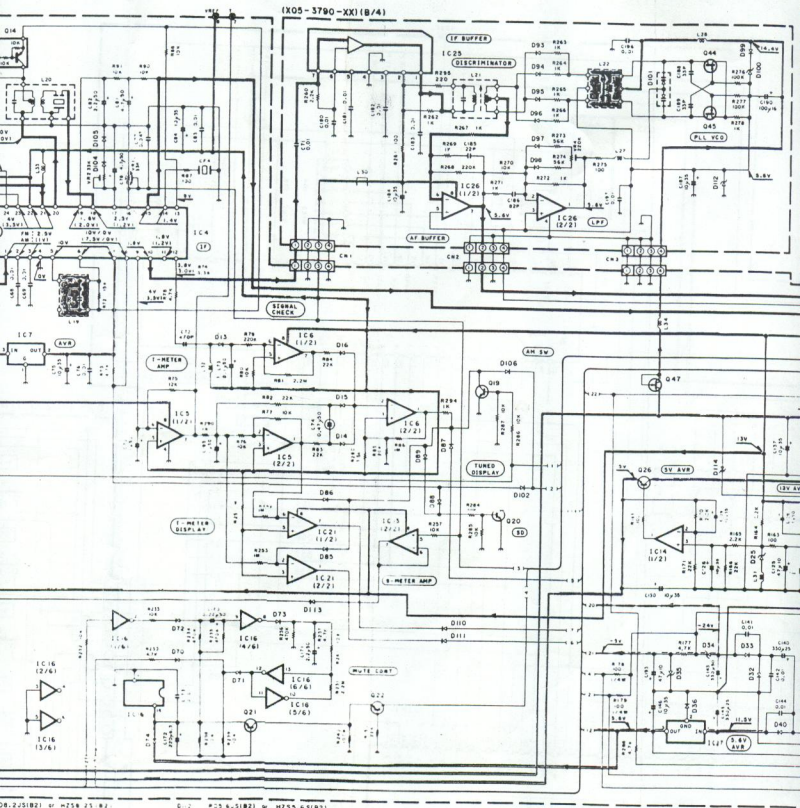

D8.2.51821 W H258.25.82
V1226.1X1

D.2 K25.4.51821 W H255.6.51821

DC voltages are as measured with a high-impedance voltmeter during reception of the FM broadcast signal (with a signal strength of 60 dB at the ANT terminal). Values may vary slightly due to variations between individual instruments or/and units. Values in parentheses are as measured during reception of the AM broadcast signal (with a signal strength of 60 dB at the ANT terminal).

Les tensions c.c. données sont mesurées à haute impédance pendant la réception du signal de programme FM (avec une force de signal de 60 dB à la borne d'antenne). Les valeurs entre parenthèses sont mesurées pendant la réception du signal de programme AM (avec une force de signal de 60 dB à la borne d'antenne).

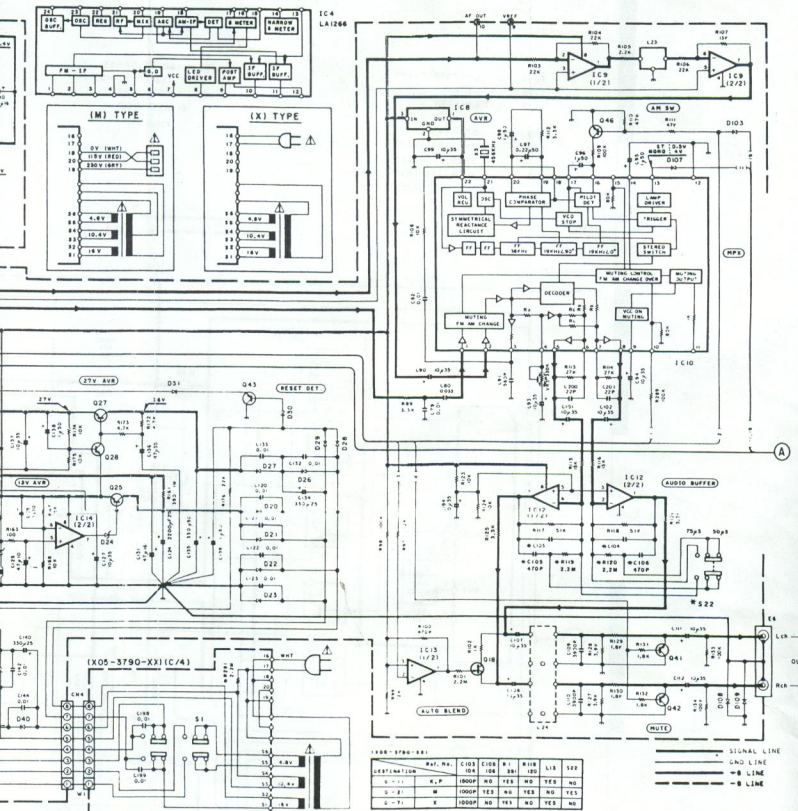

... c.c. doivent être mesurées avec un volt-impédance pendant la réception d'un programme FM (avec une force de signal la borne ANT). Les valeurs peuvent différer du fait des variations inhérentes aux aux instruments de mesure individuels.

entre parenthèses doivent être mesurées la réception d'un signal de programme AM de signal de 60 dB à la borne ANT).

Die angegebenen Gleichspannungswerte wurden mit einem hochohmigen Spannungsmesser bei Empfang eines UKW-Signals (mit einer Feldstärke von 60 dB am Antennenanschluß) gemessen. Dabei schwanken die Meßwerte aufgrund von Unterschieden zwischen einzelnen Instrumenten oder Geräten u.U. geringfügig. Die eingeklammerten Gleichspannungswerte wurden bei Empfang eines MW-Signals (mit einer Feldstärke von 60 dB am Antennenanschluß) gemessen.

CAUTION: For continued safety, replace safety critical components only with manufacturer's recommended parts (refer to parts list). **⚠** Indicates safety critical components. To reduce the risk of electric shock, leakage-current or resistance measurements shall be carried out (exposed parts are acceptably insulated from the supply circuit) before the appliance is returned to the customer.

KENWOOD

AM/FM STEREO TUNER

KT-5020/KT-5020L

INSTRUCTION MANUAL

KENWOOD CORPORATION

B50-9842-10 (JA) (K, P, E, T, M, X) (G)
90/12 11 10 9 8 7 6 5 4 3 2 1

⚠ Caution: Read this page carefully to keep your safety.

Introduction

Your choice of this product indicates that you are a devotee of excellence in sound reproduction.

We appreciate your patronage and take pride in the long tradition of quality components that our company represents.

So that you can get the most out of your unit, we suggest that you take the time to read through this manual before you hook up and operate your system. This will acquaint you with the operating features and system-connection considerations, so that your listening pleasure will be enhanced right from the start. You will notice that in all aspects of planning, engineering, styling, operating convenience and adaptability, we have sought to anticipate your needs and desires.

Keep this manual handy for future reference.

For your records

Record the serial number, found on the back of the unit, in the spaces designated on the warranty card, and in the space provided below. Refer to the model and serial numbers whenever you call upon your dealer for information or service on this product.

Model _____ Serial Number _____

Unpacking

Unpack the unit carefully and make sure that all accessories are put aside so they will not be lost.





Examine the unit for any possibility of shipping damage. If your unit is damaged or fails to operate, notify your dealer immediately. If your unit was shipped to you directly, notify the shipping company without delay. Only the consignee (the person or company receiving the unit) can file a claim against the carrier for shipping damage.

We recommend that you retain the original carton and packing materials for use should you transport or ship the unit in the future.

Note to CATV system installer:

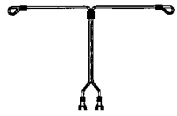
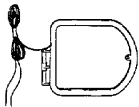
This reminder is provided to call to the CATV system installer's attention to Article 820-22 of the NEC that provides guidelines for proper grounding and, in particular, specifies that the cable ground shall be connected to the grounding system of the building, as close to the point of cable entry as practical.

Accessories

FM indoor antenna 1	AM loop antenna 1
	
75 ohm/300 ohm antenna adaptor 1	Loop antenna holder 1
	
System control cord (Except for some areas.) 1	Audio cord 1
	

Contents

Caution: Read the following pages marked in ⚠ carefully to keep your safety.

Introduction	2	Controls and Indicators	8
⚠ Before applying power	3	Operating instructions	9
⚠ Safety precautions	3	In case of difficulty	11
⚠ IMPORTANT SAFEGUARDS	4	Specifications	12
System connections	6		

⚠ Caution: Read this page carefully to keep your safety.

Before applying power

For the U.S.A. and Canada

Important!

Units shipped to the U.S.A. and Canada are designed for operation on 120 volts AC only.

Safety precaution for a Polarized AC plug

CAUTION: TO PREVENT ELECTRIC SHOCK DO NOT USE THIS (POLARIZED) PLUG WITH AN EXTENSION CORD, RECEPTACLE OR OTHER OUTLET UNLESS THE BLADES CAN BE FULLY INSERTED TO PREVENT BLADE EXPOSURE.

For the United Kingdom

Important!

Units shipped to the U.K. are designed for operation on 240 volts AC only.

The mains plug must be removed from the wall socket prior to any internal examination.

The wires in this mains lead are coloured in accordance with the following code:

Blue Neutral
Brown Live

The wires in this mains lead must be connected to the terminals in the plug as follows:

Wire colour	Plug terminal marking
Blue	N or Black
Brown	L or Red

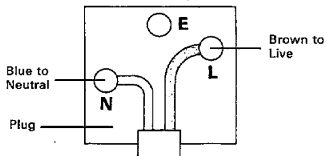

Notes:

1. If a 13-amp plug is used, this must be fitted with a 5-amp fuse.
2. If a 3-pin plug with earthing contact is used, no wire must be connected to the E terminal.

For Australia and Europe

Important!

Units shipped to Australia are designed for operation on 240 V AC only.
Units shipped to Europe are designed for operation on 220 V AC only.

For other countries

Important!

Units shipped to countries other than the above countries are equipped with an AC voltage selector switch on the rear panel. Refer to the following paragraph for the proper setting of this switch.

AC voltage selection

This unit operates on 110-120 or 220-240 volts AC. The AC voltage selector switch on the rear panel is set to the voltage that prevails in the area to which the unit is shipped. Before connecting the power cord to your AC outlet, make sure that the setting position of this switch matches your line voltage. If not, it must be set to your voltage in accordance with the following direction.

Note:

Our warranty does not cover damage caused by excessive line voltage due to improper setting of the AC voltage selector switch.

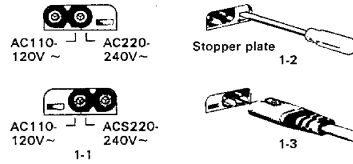





Fig. 1

1. Before plugging in this unit, make sure that the position of the AC voltage selector conforms to your line (mains) voltage. If not, it must be reset. See Fig. 1-1.
2. To reset the selector, slide the stopper plate to the opposite side with a screwdriver or other pointed tool. See Fig. 1-2.
3. Insert the power cord securely. See Fig. 1-3.

Safety precautions

WARNING: TO PREVENT FIRE OR SHOCK HAZARD, DO NOT EXPOSE THIS APPLIANCE TO RAIN OR MOISTURE.

 CAUTION RISK OF ELECTRIC SHOCK DO NOT OPEN 	<p>CAUTION: TO REDUCE THE RISK OF ELECTRIC SHOCK, DO NOT REMOVE COVER (OR BACK). NO USER-SERVICEABLE PARTS INSIDE. REFER SERVICING TO QUALIFIED SERVICE PERSONNEL.</p>
	<p>THE LIGHTNING FLASH WITH ARROWHEAD SYMBOL, WITHIN AN EQUILATERAL TRIANGLE, IS INTENDED TO ALERT THE USER TO THE PRESENCE OF UNINSULATED "DANGEROUS VOLTAGE" WITHIN THE PRODUCT'S ENCLOSURE THAT MAY BE OF SUFFICIENT MAGNITUDE TO CONSTITUTE A RISK OF ELECTRIC SHOCK TO PERSONS.</p>
	<p>THE EXCLAMATION POINT WITHIN AN EQUILATERAL TRIANGLE IS INTENDED TO ALERT THE USER TO THE PRESENCE OF IMPORTANT OPERATING AND MAINTENANCE (SERVICING) INSTRUCTIONS IN THE LITERATURE ACCOMPANYING THE APPLIANCE.</p>

⚠ Caution: Read this page carefully to ensure safe operation.

IMPORTANT SAFEGUARDS

Please read all of the safety and operating instructions before operating this unit. For best results, follow all warnings placed on the unit and adhere to the operating and use instructions. These safety and operating instructions should be retained for future reference.

1. Power sources – The unit should be connected to a power supply only of the type described in the operating instructions or as marked on the appliance.

2. Power-cord protection – Power-supply cords should be routed so that they are not likely to be walked on or pinched by items placed upon or against them, pay particular attention to cords at plugs, convenience receptacles, and the point where they exit from the unit.

Never pull or stretch the cord.

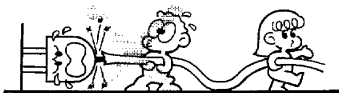

3. Grounding or polarization – The precautions should be taken so that the grounding or polarization means of this unit is not defeated.

4. Ventilation – The unit should be situated so that its location or position does not interfere with its proper ventilation.

To maintain good ventilation, do not put records or a table-cloth on the unit. Place the unit at least 10 cm away from the walls.

Do not use the unit on a bed, sofa, rug or similar surface that may block the ventilation openings.

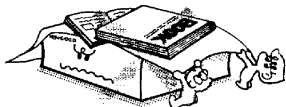

5. Water and moisture – The unit should not be used near water - for example, near a bathtub, washbowl, kitchen sink, laundry tub, in a wet basement, or near a swimming pool, etc.

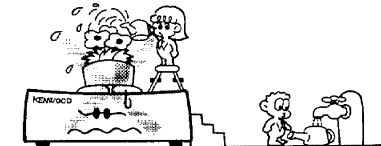

6. Temperature – The unit may not function properly if used at extremely low, or freezing temperatures. The ideal ambient temperature is above +5°C (41°F).

7. Heat – The unit should be situated away from heat sources such as radiators, heat registers, stoves, or other units (including amplifiers) that produce heat.

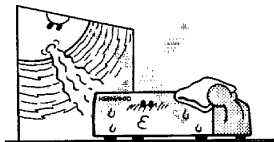

8. Electric shock – Care should be taken so that objects do not fall and liquid is not spilled into the enclosure through openings. If a metal object, such as a hair pin or a needle, comes into contact with the inside of this unit, a dangerous electric shock may result. For families with children, never permit children to put anything, especially metal, inside this unit.

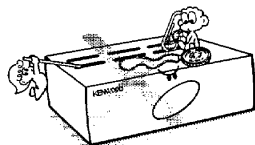

9. Enclosure removal – Never remove the enclosure. If the internal parts are touched accidentally, a serious electric shock might occur.

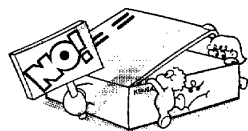

10. Magnetic fields – Keep the unit away from sources of magnetic fields such as TV sets, speaker systems, radios, motorized toys or magnetized objects.

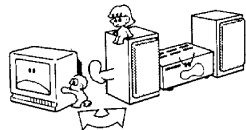

11. Cleaning – Do not use volatile solvents such as alcohol, paint thinner, gasoline, or benzine, etc. to clean the cabinet. Use a clean dry cloth.



⚠ Caution: Read this page carefully to ensure safe operation.

- 12. Carts and stands** – An appliance and cart combination should be moved with care. Quick stops, excessive force, and uneven surfaces may cause the appliance and cart combination to overturn.



- 13. Nonuse periods** – The power cord of the unit should be unplugged from the outlet when left unused for a long period of time.

- 14. Abnormal smell** – If an abnormal smell or smoke is detected, immediately turn the power OFF and pull out the power cord. Contact your dealer or nearest service center.

POWER OFF!

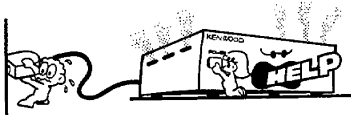

- 15. Damage requiring service** – The unit should be serviced by qualified service personnel when:
- A. The power-supply cord or the plug has been damaged; or
 - B. Objects have fallen, or liquid has been spilled into the unit; or
 - C. The unit has been exposed to rain; or
 - D. The unit does not appear to operate normally or exhibits a marked change in performance; or
 - E. The unit has been dropped, or the enclosure damaged.

- 16. Servicing** – The user should not attempt to service the unit beyond that described in the operating instructions. All other servicing should be referred to qualified service personnel.

- 17. Outdoor antenna grounding** – If an outside antenna is connected to the receiver, be sure the antenna system is grounded so as to provide some protection against voltage surges and built up static charges. Section 810 of the National Electrical Code, ANSI/NFPA No. 70 – 1984, provides information with respect to proper grounding of the mast and supporting structure, grounding of the lead-in wire to an antenna discharge unit, size of grounding conductors, location of antenna-discharge unit, connection to grounding electrodes, and requirements for the grounding electrode. See Figure.

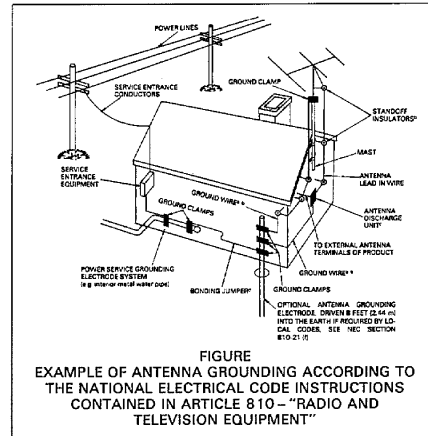

^a Use No.10 AWG (5.3 mm²) copper, No.8 AWG (8.4 mm²) aluminum, No.17 AWG (1.0 mm²) copper-clad steel or bronze wire, or larger, as a ground wire.

^b Secure antenna lead-in and ground wires to house with stand-off insulators spaced from 4 – 6 feet (1.22 – 1.83 m) apart.

^c Mount antenna discharge unit as close as possible to where lead-in enters house.

^d Use jumper wire not smaller than No.6 AWG (13.3 mm²) copper, or the equivalent, when a separate antenna-grounding electrode is used. See NEC Section 810-21 (j).

- 18. Power lines** – An outdoor antenna should be located away from power lines.

- 19. AC outlets** – Do not connect other audio equipment with a power consumption larger than that specified to the AC outlet on the rear panel. Never connect other electrical units, such as an iron or toaster, to it to prevent fire or electric shock.

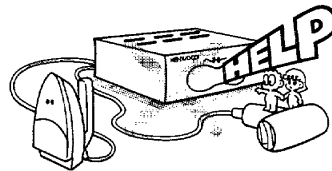

Notes:

1. Item 3 is not required except for grounded or polarized equipment.
2. Item 17 and 18 are not required except for units provided with antenna terminals.
3. Item 17 complies with UL-1270 in the U.S.A.
4. Item 19 is not required except for units provided with AC outlets.

System connections

Make connections as shown in the diagram below.
Do not plug the power cord into the wall outlet until all connections have been completed.

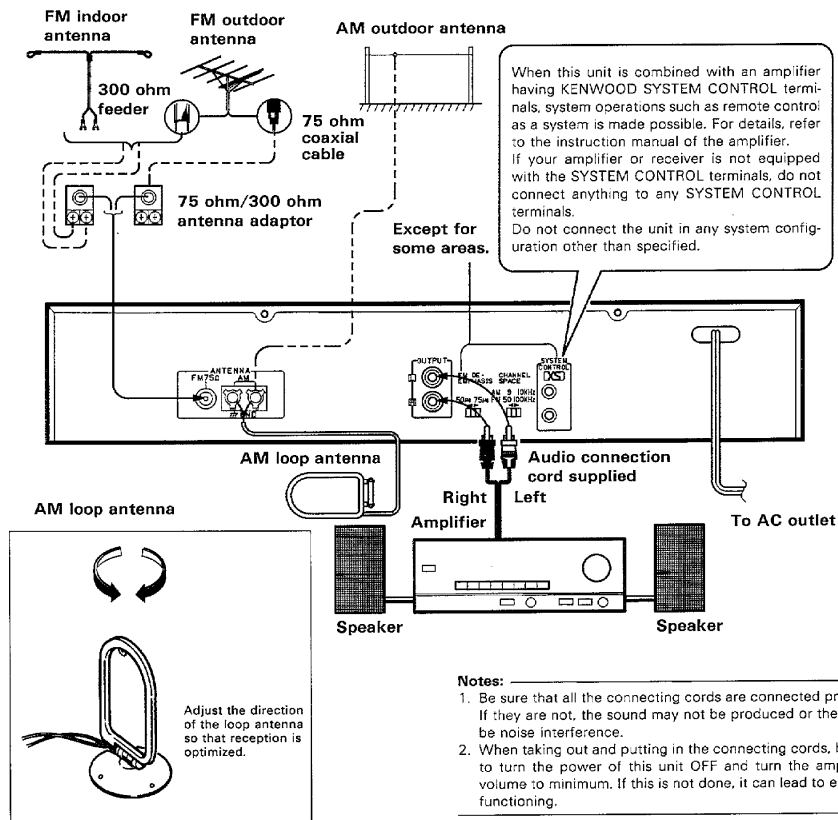

■ System operation

① System operation via system control connection with an amplifier.

The SYSTEM CONTROL jacks on KENWOOD amplifiers are marked with either "OSC" or "DS".

By connecting the SYSTEM CONTROL jack of this unit with that of a KENWOOD amplifier, the following system operations are possible.

When connected to an "OSC" jack: This unit can be controlled as part of the entire system with the remote control unit provided with the amplifier.

When connected to an "DS" jack: This unit can be controlled as part of the entire system with the remote control unit provided with the amplifier for easy operation. For details, refer to the instruction manual provided with your amplifier.

■ AM loop antenna setting

Insert the supplied AM loop indoor antenna into the supplied loop antenna stand.

Place the stand on a stable surface, for example on a shelf, or install it on a rack or wall with wood screws.

Note:

Place the AM loop indoor antenna as apart as possible from the TV, speaker cords, power cords and system control cords.

■ AM outdoor antenna

In steel buildings or at a great distance from the transmitter, it may be necessary to install an outside longwire antenna. The end of this wire should be stripped of insulation and connected to the AM terminal. At this time, keep the loop antenna connected.

■ FM outdoor antenna

Consult with your dealer or service man about the best method of selecting and erecting an outdoor FM antenna. The choice of lead-in (feeder) wire is also important. The flat ribbon-shaped twin lead performs well electrically, is cheaper and is somewhat easier to handle in routing through windows and around rooms. Coaxial cable is more expensive, does a much better job of minimizing interference, is less prone to the effects of weather and close-by metal objects, and is nearly as good a signal conductor as the ribbon type wire. The latter is particularly true of foam-type coaxial cables. Coaxial cable is somewhat more difficult to install at the point where the cable enters the building.

■ FM outdoor antenna setting

- To minimize auto-ignition noise, locate the antenna as far from heavy traffic as possible.
- Keep the feeder or coaxial cable as short as possible. Do not bundle or roll up excess cable.
- The antenna should be placed at least two meters (6.6 feet) from reinforced concrete walls or metal structures.

■ T-shaped FM indoor antenna

The T-shaped FM antenna shall be used as a preliminary for the period before a dedicated FM outdoor antenna is installed.

■ Connection of coaxial cable

<p>① Arrange the coaxial cable as illustrated.</p> <p>Outer shield (Braid) Inner conductor</p> <p>RG-59 (3C-2V) 6 4 (mm) 16 mm</p> <p>RG-6 (5C-2V) 6 4 (mm) 10 mm</p>	<p>② Open the 75 ohm/300 ohm antenna adaptor.</p> <p>Press the claws in the direction of the arrows with the fingers to release the lock and pull out the cover.</p>	<p>③ Detach the ring from the antenna adaptor.</p> <p>Then put the ring on the pole in the cover.</p> <p>Pole (Cover) Ring</p> <p>(Antenna adaptor)</p>
<p>④ Remove the band and insert the inner conductor to the slit.</p> <p>Band Slit</p>	<p>⑤ Fasten the band with screws, using a screwdriver.</p>	<p>⑥ Close the cover.</p> <p>Connect the adaptor to the antenna terminal.</p>

■ Connection of 300-ohm feeder cable

<p>①</p> <p>Supplied FM indoor antenna</p> <p>3. To tighten screw 1. To loosen screw</p> <p>2. Insert antenna cable Antenna adapter</p>	<p>②</p> <p>Rear panel of unit</p> <p>Plug securely into FM ANTENNA jack.</p>	<p>③</p> <p>1. Find the position that provides best reception.</p> <p>2. Fix two ends.</p> <p>Set to receiving mode.</p> <p>unit</p>
---	---	--

Controls and indicators

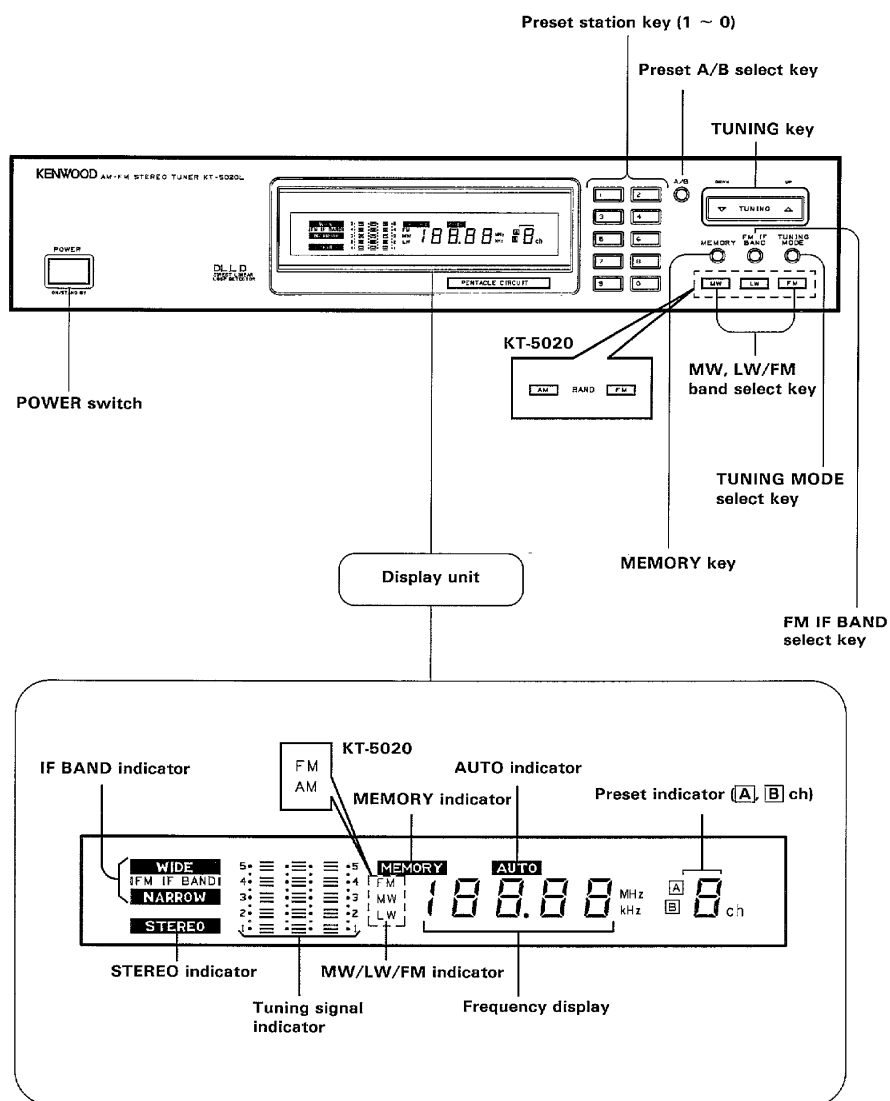

Operating instructions

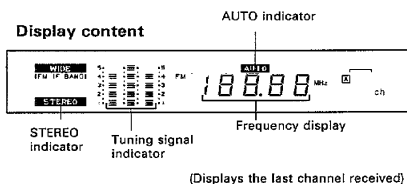

*Last station

As the memory of this unit is backed up, the frequency received before the power is turned off is memorized. This is referred to as the last station frequency. When the power is turned on again, the unit tunes in the last station frequency.

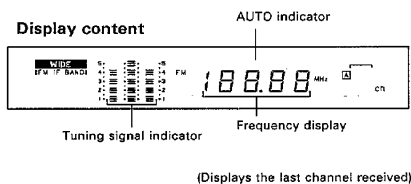

TUNING SIGNAL indicators

As a station is being tuned in, a left or right indicator lights in red, and the number of lighting points increases as the signal strength increases. Then, when the correct tuning is very near, the white points in the center start to light and increase in number. The station is tuned most precisely when the number of white points is at a maximum.

In detuning, the above steps will be reversed.

In AM (MW/LW) reception, the center white indicator lights when a station is tuned in.

Note:

If the signal strength of the electric field is insufficient, the left and right indicators will not light more than 4 RED points, or the indication becomes asymmetrical.

FM DE-EMPHASIS switch (Except some areas)

This switch has been set to the correct position for a given market area. However, check to see that this switch is set correctly before operating your unit. An incorrect setting will adversely affect high-frequency performance.

Europe and Oceania 50 μ s
Other countries 75 μ s

Auto tuning reception

1. Set the input selector of the amplifier to TUNER.
2. Press the POWER switch.
3. Select the desired band by pressing one of the band select keys.
 - To listen to AM (MW/LW) stations, press the AM (MW/LW) SELECTOR switch. The frequency display shows the last AM (MW/LW) station.
 - To listen to FM stations, press the FM SELECTOR switch. The frequency display shows the last FM station.
4. Set the TUNING MODE key so that the AUTO indicator lights.
5. Press the TUNING keys to tune in a station.
 - Press the TUNING Δ key to tune in a station with a higher frequency than the current received frequency, or TUNING ∇ key to tune in a frequency with a lower frequency.
 - The stations are automatically scanned.
6. Adjust the volume and tone of your amplifier.

Manual tuning

(The reception mode is forced to monaural even when a FM stereo station is received.)

The manual tuning is to be used for receiving a weak station which cannot be received by auto tuning.

1. Perform procedures 1 ~ 3 above.
2. Press the TUNING MODE select key so that the AUTO indicator goes off.
3. Press the TUNING key to tune in the desired broadcasting station.
 - If the TUNING key is held depressed, the frequencies will change continuously until the key is released.
4. Adjust the volume and tone of your amplifier.

AM/FM CHANNEL SPACE switch (Except some areas)

The CHANNEL SPACE switch on the rear panel is set to the correct setting that prevails in the area to which the unit is shipped. However, if the channel space setting is not matched to the area where the unit is to be used; for instance, when you moved from area 1 to area 2 or vice versa, desired reception of AM/FM broadcasts is not expected. In this case, change the CHANNEL SPACE setting in accordance with the area corresponding to the table shown below.

Area	Channel Space Frq.
1. U.S.A., Canada Hawaii, and Guam	FM: 100 kHz
	AM*: 10 kHz
2. European countries Far East countries	FM: 50 kHz
	AM: 9 kHz

Channel space table

Note:

When changing the setting of the AM/FM CHANNEL SPACE switch, first unplug the AC power cord, then operate the switch, and finally insert the AC power cord again.

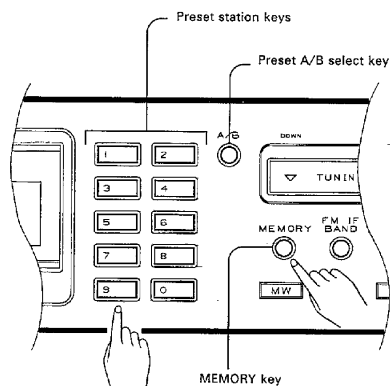
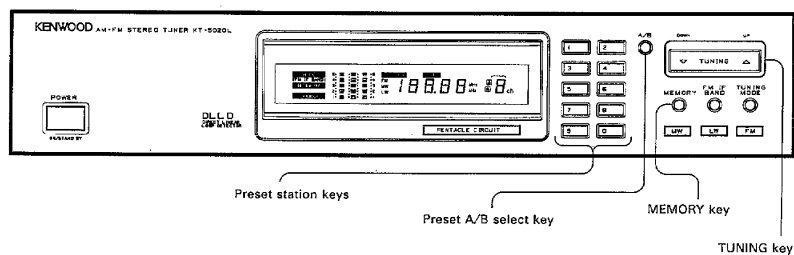

Press the desired preset station key.

- Select preset group A or B by the A/B select key.

■ Preset tuning

1. Receive a station either by auto tuning or manual tuning.
2. Select preset group A or B with the preset A/B select key.
 - A total of 20 stations can be preset in memory; 10 in group A, and 10 in group B.
3. Press the MEMORY key.
 - The MEMORY indicator lights for about 5 seconds.
4. While the MEMORY indicator lights, press one of the preset station keys.

The MEMORY indicator goes off, the preset indicator lights up, and the frequency of the received station is preset under the selected key.

■ How to receive a preset station

1. Select preset group A or B with the preset A/B select key.
2. Press the preset station keys under which the frequency of the desired station has been preset.
3. Adjust the volume and tone on the amplifier.

The preset memory contents are backed up for at least three days even after the power cord is disconnected.

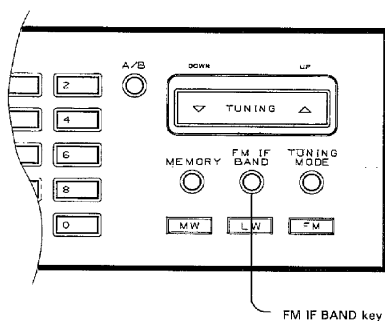

■ FM IF BAND key

This key switches the intermediate frequency passing band between "WIDE" and "NARROW". When listening in an area where there is no radio interference, press the key so that the "FM IF BAND" indicator lights to indicate the WIDE mode: High-quality sound without distortion can be recording.

When interference is noticed, set the switch off for the NARROW mode: The radio wave selectivity is improved, thereby resulting interference free reception.

In case of difficulty

If your tuner should not perform as expected, consult the table below to see if the problem can be corrected before seeking help from your dealer or service representative.

General

Symptom	Cause	Remedy
Sound is not produced.	1. Antennas are not connected. 2. Amplifier is not connected. 3. No broadcast station is turned in.	1. Connect the loop antenna for AM and outdoor or T-shaped antenna for FM. 2. Connect the amplifier using an audio cord. 3. Tune in a station.
Tuning signal indicators light unstably.	Antenna is not connected properly.	Check for disconnection or bad contact.
Sound is interrupted when a switch is pressed.	Muting is applied temporarily to prevent shock noise due to switching.	This is not a malfunction.

Occurs during FM reception only

Symptom	Cause	Remedy
Hiss that gets worse in stereo reception.	Very weak antenna input signal.	Consider an outdoor antenna installation. In areas remote from the transmitter a 5 to 8 element antenna designed exclusively for FM is suggested.
Rhythmic static or popping noises.	Automobile ignition noise, especially evident when receiving weak signals.	Review antenna installation. Site the antenna as far from the street as possible and use coaxial cable.
STEREO indicator does not light and reception is monaural although the station is being broadcast in stereo.	Radio wave is so weak that the tuner forces monaural reception.	Install a dedicated FM outdoor antenna to ensure sufficient radio wave reception.

Occurs during AM reception only

Symptom	Cause	Remedy
Continuous noise sounding "zzz" interferes reception specially in the evening or night.	Noise from an electrical appliance (fluorescent lamp, etc.) or atmospheric noise is entering the antenna.	The noise can be reduced by installing an outdoor AM lead antenna and providing grounding to the tuner. However, it is difficult to eliminate such noise completely.
Humming noise (tuning hum) is heard only when a specific station is tuned in.	1. The noise may be due to the direction in which the power plug is inserted into the outlet. 2. It may be due to the condition of the local area where the tuner is used.	1. Insert the power plug so that the blades are plugged in the different power outlet slots from before. 2. It is not avoidable that hum noise interferes with specific stations as long as AC power supply is used.
Continuous, high-tone noise sounding "tweet" or "shoo" interferes and increases.	1. The noise may be generated from a TV. 2. It may be a beat noise due to cross-interference between AM stations.	1. Switch off the TV. (Also remember that the noise could be due to another TV in your neighbors.) 2. It cannot be eliminated because it is based on the characteristics inherent to AM radio system.

Troubles specific to synthesizer tuners

Symptom	Cause	Remedy
No station is tuned in when a preset station key is pressed.	No station frequency has not been preset under that key.	Check the frequency of desired station and preset it securely.
The whole of the memory stored under the preset station keys has disappeared.	Memory backup could not function because the power was not supplied through the power cord.	The power cord must be connected to a wall outlet or an "unswitched" power outlet.

Specifications

For other Countries

FM tuner Section

Tuning frequency range	87.5 MHz - 108 MHz
Usable sensitivity (MONO)	0.95 μ V/10.8 dBf
50 dB quieting sensitivity	
MONO	1.8 μ V/16.2 dBf
STEREO	24 μ V/38.8 dBf
Total harmonic distortion (at 1 kHz)	
MONO	0.04% (WIDE)
STEREO	0.06% (WIDE)
Signal to noise ratio (at 1 kHz, 85 dBf input)	
MONO	88 dB
STEREO	82 dB
Stereo separation	
1 kHz	55 dB (WIDE)
Captuer ratio	1.0 dB (WIDE), 2.5 dB (NARROW)
Alternate channel selectivity	
(\pm 400 kHz)	60 dB (WIDE)
Image rejection ratio (at 98 MHz)	82 dB
IF rejection ratio (at 98 MHz)	110 dB
Spurious rejection ratio (at 98 MHz)	105 dB
AM suppression ratio	76 dB
Frequency response	
(20 Hz - 15 kHz)	+0.5 dB, -0.5 dB
Output level/Impedance	
(at 1 kHz, 100% dev.)	0.6V/3.3k Ω

AM Tuner Section

Tuning frequency range	
531 kHz - 1,602 kHz	9 kHz step
530 kHz - 1,610 kHz	10 kHz step
Usable sensitivity	10 μ V (350 μ V/m)
Signal to noise ratio	
(at 30% mod, 1mV input)	52 dB
Total harmonic distortion	0.3%
Image rejection ratio (Loop)	40 dB
Selectivity	30 dB
Output level/Impedance	
(at 30% mod.)	0.18 V/3.3 k Ω

General

Power consumption	15 W
Dimension	
W: 440 mm (17-5/16")	
H: 98 mm (3-7/8")	
D: 318 mm (12-1/2")	
Weight	4.3 kg (9.46 lb)

For Europe type

FM tuner Section

Tuning frequency range	87.5 MHz - 108 MHz
Usable sensitivity (DIN)	
MONO	0.7 μ V
STEREO	25 μ V
Limiting level (DIN at 75 Ω)	0.45 μ V
Total harmonic distortion (DIN at 1 kHz)	
MONO	0.07% (WIDE)
STEREO	0.2% (WIDE)
Signal to noise ratio	
(DIN weighted at 1 kHz, 65.2 dBf input)	
MONO	78 dB
STEREO	67 dB
Stereo separation (DIN)	
1 kHz	52 dB (WIDE)
6.3 kHz	42 dB (WIDE)
Captuer ratio	1.0 dB (WIDE), 2.5 dB (NARROW)
Alternate channel selectivity	
(DIN \pm 300 kHz)	75 dB (NARROW)
Image rejection ratio (at 98 MHz)	82 dB
IF rejection ratio (at 98 MHz)	110 dB
Spurious rejection ratio (at 98 MHz)	105 dB
AM suppression ratio	76 dB
Frequency response	
(20 Hz - 15 kHz)	+0.5 dB, -0.5 dB
Output level/Impedance	
(at 1 kHz, 100% dev.)	0.6V/3.3k Ω

MW Tuner Section

Tuning frequency range	531 kHz - 1,602 kHz
Usable sensitivity	10 μ V (350 μ V/m)
Signal to noise ratio	
(at 30% mod, 1mV input)	52 dB
Total harmonic distortion	0.3%
Image rejection ratio (Loop)	40 dB
Selectivity	30 dB
Output level/Impedance	
(at 30% mod.)	0.18 V/3.3 k Ω

LW Tuner Section

Tuning frequency range	153 kHz - 281 kHz
Usabel sensitivity	10 μ V (600 μ V/m)
Signal to noise ratio	
(at 30% mod, 1mV input)	50 dB
Total harmonic distortion	0.4%
Image rejection ratio (Loop)	40 dB
Selectivity	30 dB
Output level/Impedance	
(at 30% mod.)	0.18 V/3.3 k Ω

General

Power consumption	15 W
Dimension	
W: 440 mm	
H: 98 mm	
D: 318 mm	
Weight (Net)	4.3 kg

Note:

KENWOOD follows a policy of continuous advancements in development. For this reason specifications may be changed without notice.