

Metallic cabinet * (A01-)

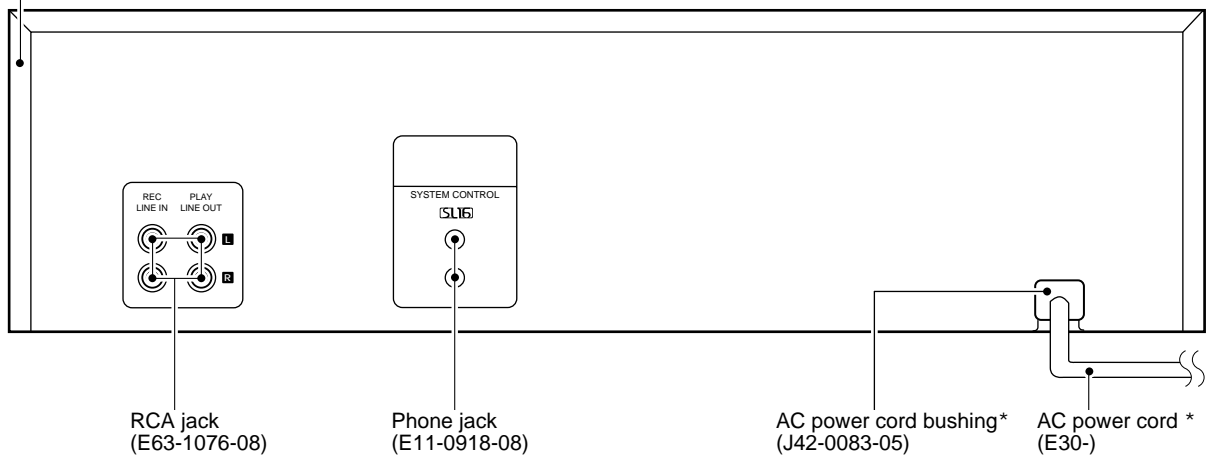

* Refer to parts list on page 18.



CT-405/KXF-W4030

CONTENTS / ACCESSORIES

Contents

CONTENTS / ACCESSORIES	2	PC BOARD	8
BLOCK DIAGRAM	3	SCHEMATIC DIAGRAM	11
CIRCUIT DESCRIPTION	4	EXPLODED VIEW	17
ADJUSTMENT	6	PARTS LIST	18
PARTS DESCRIPTIONS	7	SPECIFICATIONS	21

Accessories

Audio cord (2)
(E30-0505-05)



System control cord (1)
(E30-2816-05)

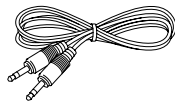

CT-405/KXF-W4030 BLOCK DIAGRAM

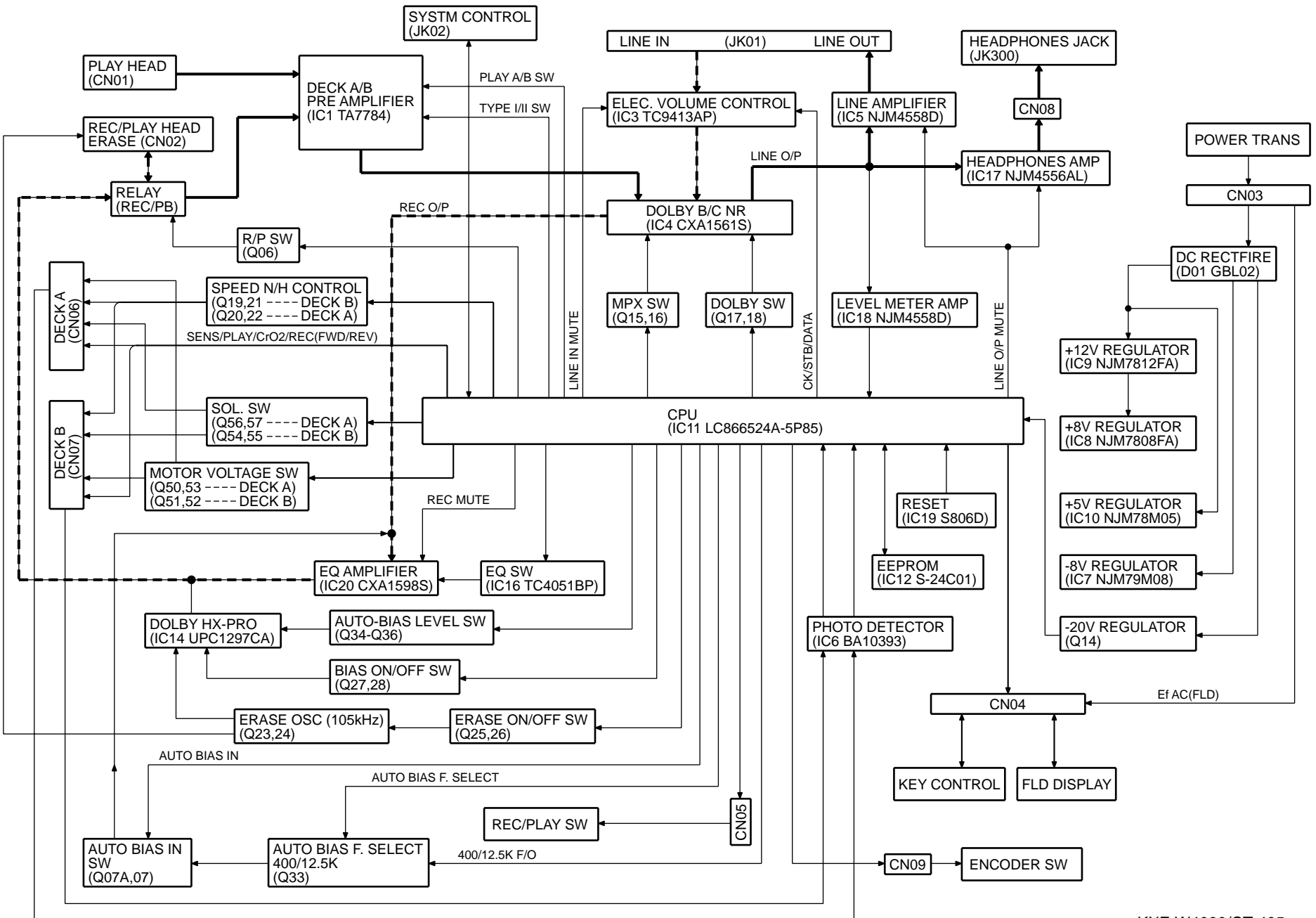

KXF-W4030/CT-405

CT-405/KXF-W4030

CIRCUIT DESCRIPTION

1. Pin description of microprocessor

Pin No.	Pin Name	I/O	Description	ACTIVE	
				H	L
1	AUTO BIAS IN	O	Auto bias control port.	A BIAS	Other
2	400/12.5K ,F/O	O	400Hz/12.5kHz freq. output.		
3	R/P HEAD	O	Control port for recording/playback.	Recording	Other
4	REC MUTE	O	Audio muting control on R/P for B deck.	Off	On
5	LINE/O MUTE	O	Audio muting control for line out.	Off	On
6	B MECH VCC	O	B mecha. solenoid control.	Other	Stop
7	A MECH VCC	O	A mecha. solenoid control.	Other	Stop
8	B SOL	O	B mecha. solenoid control.	On	Off
9	A SOL	O	A mecha. solenoid control.	On	Off
10	IN/MUTE	O	Audio muting control for input.	Off	On
11	AC CHK	I	Power failure input.	AC On	AC Off
12	RESET	I	Reset signal input.		○
13	NC	-	Unused.		
14	ENCODER IN B	I	Encoder input B.		
15	VSS	-	Connected to ground.		
16,17	CF 6MHz	-	Main clock(6.0MHz).		
18	VDD	-	Power supply.		
19-22	K1-K4	I	Key input(k1-k4).		
23	TIMER P/R SW	I	Timer Play/Rec switch input.		
24	CCRS LEVEL	O	CCRS level control port.		
25	LEVEL MTR L/IN	I	Level meter input (Lch).		
26	LEVEL MTR R/IN	I	Level meter input (Rch).		
27	NC	-	Unused.		
28	ENCODER IN A	I	Encoder input A.		
29	-	-	Connected to system cont. data.		
30-35	FLD 1G-6G	O	FLD grid control port(1G-6G).		
36-45	FLD P1-P10	O	FLD segment control port(S1-S10).		
46	VDD	-	Power supply.		
47-50	FLD P11-14	O	FLD segment control port(S11-S14).		
51	-VPP	-	FLD power supply(-26V).		
52-61	FLD P15-24	O	FLD segment control port(S15-S24).		
62	A CrO2 SW	I	A CrO2 switch input.	Type 2	Type1
63	A PLAY SW	I	A play switch input.	Stop	Play
64	A SENS. PULS	I	A photo sensor input.		
65	A PACK SW	I	A pack switch input.	Tape No	Tape Yes
66	B CrO2 SW	I	B CrO2 switch input.	Type 2	Type 1
67	B SENS. PULS	I	B photo sensor input.		
68	B PACK SW	I	B pack switch input.	Tape No	Tape Yes
69	B PLAY SW	I	B play switch input.	Stop	Play
70	REC FWD SW	I	Forward recording switch input.		
71	REC REV SW	I	Reverse recording switch input.		
72	VDD	-	Power supply.		
73	MPX FILTER	O	MPX filter ON/OFF control.		
74	REC FILTER	O	MPX filter ON/OFF control.		
75	REC EQ	O	Rec EQ.(I/II) Control.	I	II
76	SPEED N/H	O	B motor speed (normal/hi) control port.	Nor	Hi
77	DOLBY NR B/C	O	Control port for dolby NR(B/C).		
78	DOLBY NR ON/OFF	O	Dolby NR ON/OFF control port.		
79	A MOTOR SPEED	O	A motor speed (normal/hi) control port.	Nor	Hi
80	P.B EQ	O	P.B EQ. Control.		
81	MTR AMP GAIN A	O	Gain control of level meter amplifier.		
82	MTR AMP GAIN B	O	Gain control of level meter amplifier.		

CT-405/KXF-W4030

CIRCUIT DESCRIPTION

Pin No.	Pin Name	I/O	Description	ACTIVE	
				H	L
83	AUTO BIAS F SEL.	O	Auto bias frequency selection 8LPF).	400Hz	12.5kHz
84	ERASE OSC ON/OFF	O	Erase OSC(ON/OFF) control.	Recording	Other
85	BIAS OSC ON/OFF	O	Bias OSC(ON/OFF) control.		
86-88	BIAS L1-L3	O	Bias level control output.		
89	VSS	-	Connected to ground.		
90	VDD	-	Power supply.		
91	NC	-	Unused.		
92	PLAY A or B	O	A/B deck control port.	A Playback	Other
93	NC	-	Unused.		
94	EE PROM SCL	O	EE PROM SCL.		
95	EE PROM SDA	O	EE PROM SDA..		
96	SYSTEM CONT.BUSY	O	System control byusy.		
97	SYSTEM CONT.DATA	O	System control data.		
98	TC9413AP DATA/O	O	Data output to E. volume.		
99	TC9413AP STB/O	O	Strobe output to E. volume.		
100	TC9413AP SCK/O	O	Clock output to E. volume.		

2. Key matrix

() Microprocessor port

PORT	SW1	SW2	SW3	SW4	SW5	SW6
(PIN19) K1	A REV PLAY	A FWD PLAY	A REW	A FF	RESET A	-
(PIN20) K2	B REV PLAY	B FWD PLAY	B REW	B FF	REC/ REM	MODE
(PIN21) K3	A STOP	B STOP	PAUSE	CCRS	AUTO BIAS	RESET B
(PIN22) K4	DOLBY	REV MODE	NOR DUBBING	HI DUBBING	MPX FILTER	-

3. Description of R/P output for microprocessor.

Pin No.	Pin Name	Description
3	Rec/P.B	B Mecha. Recording Mode : H Other : L
4	Rec Mute	B Mecha. Recording /Playback Mode : H Other : L
5	Line Mute	A/B Playback or B Recording : H Other : L
80	P.B EQ. 70	Tape Type II : H Other : L
1	Rec Input Select	Auto Bias Recording : H Other : L
83	A. Bias F Select	Auto Bias 400Hz Recording : H Other : L
85	B OSC On/Off	Recording/Playback : H Other : L
81	M. Amp Gain 1	P.B/Recording/Dubb. : H Other : L
82	M. Amp Gain 1	Auto Bias : H Other : L

Pin No.	Pin Name	Rec.M.Fil On	Rec.M.Fil Off	Other
73	MPX Filter	L	H	H
74	REC Filter	L	L	H

Pin No.	Pin Name	Dolby C	Dolby B	Off
77	Dolby B/C	L	H	H
78	Dolby On/Off	L	L	H

* Filter off when dubbing mode.

Pin No.	Pin Name	Type I N.Sp	Type I H.Sp	Type II N.Sp	Type II H.Sp
75	Rec E.Q. I/II	H	H	L	L
76	Speed N/H	H	L	H	L

CT-405/KXF-W4030

ADJUSTMENT

No.	ITEM	INPUT SETTINGS	OUTPUT SETTINGS	CASSETTE DECK SETTINGS	ALIGNMENT POINT	ALIGN FOR	FIG.
CASSETTE DECK SECTION		TAPE: NORMAL, DOLBY: OFF, INPUT: LINE IN			0 dBs = 0.775 V		
I. REC/PLAY HEAD							
[1]	DEMAGNETIZATION	-	-	POWER OFF Remove the cassette door.	REC/PLAY head	Demagnetize the REC/PLAY head with a head demagnetizer.	
[2]	CLEANING	-	-	PLAY	REC/PLAY head, erase head, capstan pinch roller	Clean the REC/PLAY head, erase head, capstan and pinch roller using a cotton swab slightly damped with alcohol.	
[3]	AZIMUTH	(A) MTT-114, TCC-153 0 kHz, -10 dB	(B)	PLAY	Azimuth adjustment screw	Maximum output.	(a)
II. PC BOARD							
[1]	A DECK	NOR. SPEED	(A) MTT-111, TCC-110 3 kHz	(B)	PLAY	SFR 06	Adjust the tape speed so that a 3 kHz signal is produced at the center of the tape.
		HI. SPEED			HI DUBBING	SFR 08	
	B DECK	NOR. SPEED			PLAY	SFR 05	Adjust the tape speed so that a 3 kHz signal is produced at the center of the tape.
		HI. SPEED			Play first and short * TP2 to GND.	SFR 07	5.4 kHz
III. PC BOARD * TP2 (Q12, BASE)							
< 1 >	PLAYBACK LEVEL	MTT-150 400 Hz (200 nWb)	(B) DOLBY 0 dB LEVEL	PLAY	A SFR101 (L) SFR102 (R)	Output level : 0 dBs	
< 2 >	BIAS CURRENT	(A) 400 Hz, -20 dBs 12.5 kHz, -20 dBs	(B) 20 dBs	Adjust REC level VR so that the REC monitor output becomes -20 dBs at 400 Hz, then record and reproduce signal of 400 Hz and 12.5 kHz in alternation.	SFR11 (L) SFR12 (R)	Record 400 Hz and 12.5 kHz in alternation and adjust the variable resistors which control the bias current so that the same playback level is obtained.	
< 3 >	RECORD LEVEL	(A) 400 Hz, 123mV	(B) 0 dBs	Record and reproduce a 400 Hz, signal under the conditions set in < 3 >.	SFR09 (L) SFR10 (R)	Adjust for 0 dBs at line out.	

System connections

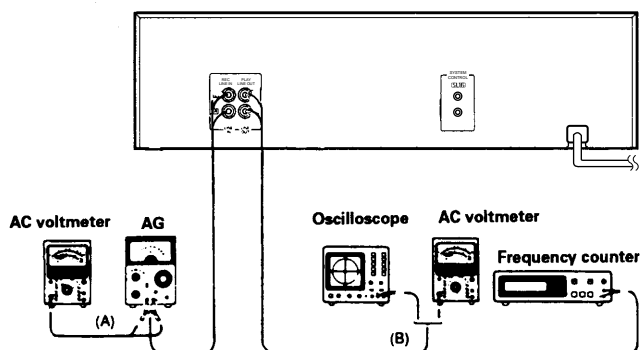

(a) Azimuth adjustment screw

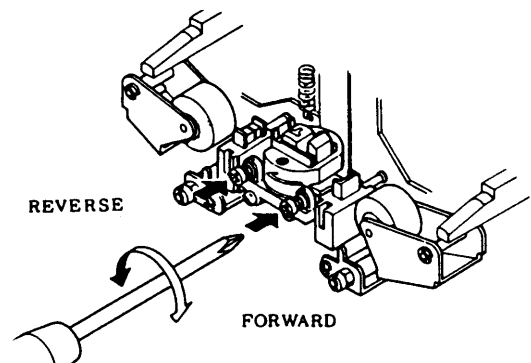

CT-405/KXF-W4030

PARTS DESCRIPTIONS

CAPACITORS

CC 45 TH 1H 220 J
 1 2 3 4 5 6

- 1 = Type ... ceramic, electrolytic, etc.
- 2 = Shape ... round, square, ect.
- 3 = Temp. coefficient
- 4 = Voltage rating
- 5 = Value
- 6 = Tolerance

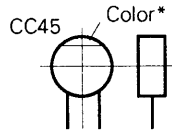

Capacitor value

- 010 = 1pF
- 100 = 10pF
- 101 = 100pF
- 102 = 1000pF = 0.001μF
- 103 = 0.01μF

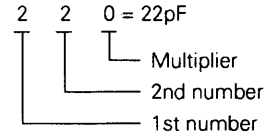

Temperature coefficient

1st Word	C	L	P	R	S	T	U
Color*	Black	Red	Orange	Yellow	Green	Blue	Violet
ppm/°C	0	-80	-150	-220	-330	-470	-750

2nd Word	G	H	J	K	L
ppm/°C	±30	±60	±120	±250	±500

Example : CC45TH = -470 ± 60ppm/°C

Tolerance (More than 10pF)

Code	C	D	G	J	K	M	X	Z	P	No code
(%)	±0.25	±0.5	±2	±5	±10	±20	+40 -20	+80 -20	+100 -0	More than 10μF -10 ~ +50 Less than 4.7μF -10 ~ +75

(Less than 10pF)

Code	B	C	D	F	G
(pF)	±0.1	±0.25	±0.5	±1	±2

Voltage rating

2nd word \ 1st word	A	B	C	D	E	F	G	H	J	K	V
0	1.0	1.25	1.6	2.0	2.5	3.15	4.0	5.0	6.3	8.0	-
1	10	12.5	16	20	25	31.5	40	50	63	80	35
2	100	125	160	200	250	315	400	500	630	800	-
3	1000	1250	1600	2000	2500	3150	4000	5000	6300	8000	-

Chip capacitors

(EX) C C 7 3 F S L 1 H 0 0 0 J
 1 2 3 4 5 6 7

(Chip) (CH, RH, UJ, SL)

(EX) C K 7 3 F F 1 H 0 0 0 Z
 1 2 3 4 5 6 7

(Chip) (B, F)

Refer to the table above.

- 1 = Type
- 2 = Shape
- 3 = Dimension
- 4 = Temp. coefficient
- 5 = Voltage rating
- 6 = Value
- 7 = Tolerance

Dimension (Chip capacitors)

Dimension code	L	W	T
Empty	5.6 ± 0.5	5.0 ± 0.5	Less than 2.0
A	4.5 ± 0.5	3.2 ± 0.4	Less than 2.0
B	4.5 ± 0.5	2.0 ± 0.3	Less than 2.0
C	4.5 ± 0.5	1.25 ± 0.2	Less than 1.25
D	3.2 ± 0.4	2.5 ± 0.3	Less than 1.5
E	3.2 ± 0.2	1.6 ± 0.2	Less than 1.25
F	2.0 ± 0.3	1.25 ± 0.2	Less than 1.25
G	1.6 ± 0.2	0.8 ± 0.2	Less than 1.0

RESISTORS

Chip resistor (Carbon)

(EX) R K 7 3 E B 2 B 0 0 0 J
 1 2 3 4 5 6 7

(Chip) (B, F)

Carbon resistor (Normal type)

(EX) R D 1 4 B B 2 C 0 0 0 J
 1 2 3 4 5 6 7

- 1 = Type
- 2 = Shape
- 3 = Dimension
- 4 = Temp. coefficient
- 5 = Rating wattage
- 6 = Value
- 7 = Tolerance

Dimension

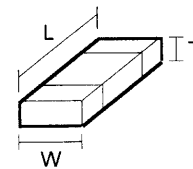

Dimension (Chip resistor)

Dimension code	L	W	T
E	3.2 ± 0.2	1.6 ± 0.2	1.0
F	2.0 ± 0.3	1.25 ± 0.2	1.0
G	1.6 ± 0.2	0.8 ± 0.2	0.5 ± 0.1

Rating wattage

Code	Wattage	Code	Wattage	Code	Wattage
1J	1/16W	2C	1/6W	3A	1W
2A	1/10W	2E	1/4W	3D	2W
2B	1/8W	2H	1/2W		

PC BOARD (Component side view)

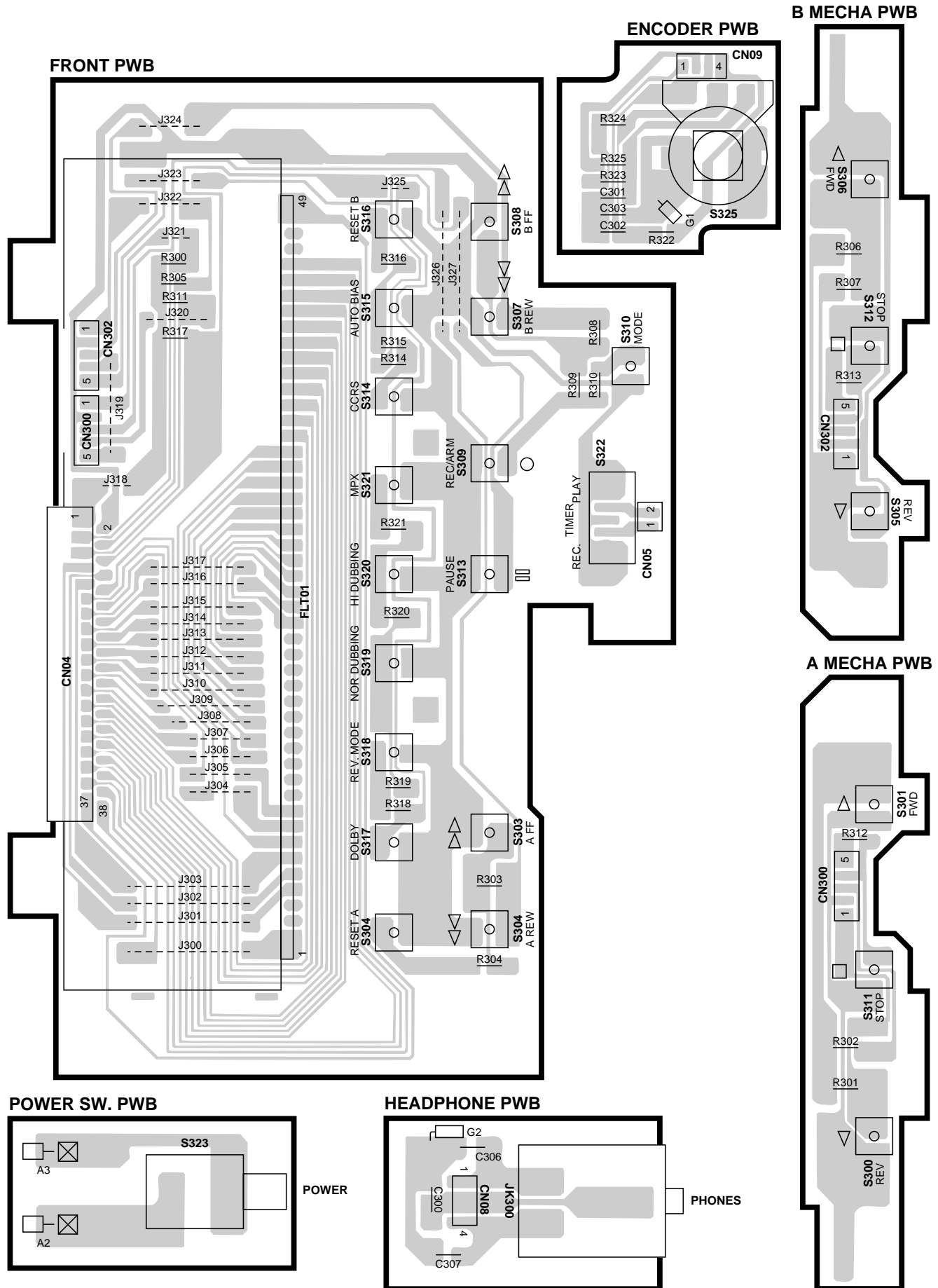

PC BOARD (Component side view)

TRANS PWB

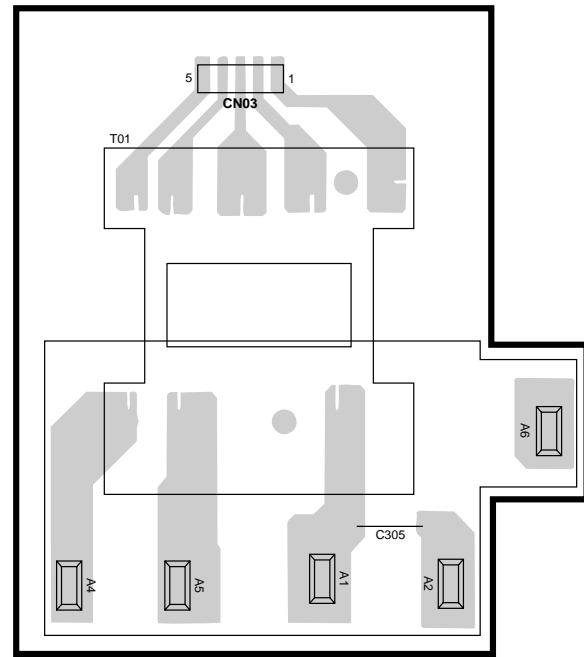

MAIN PWB

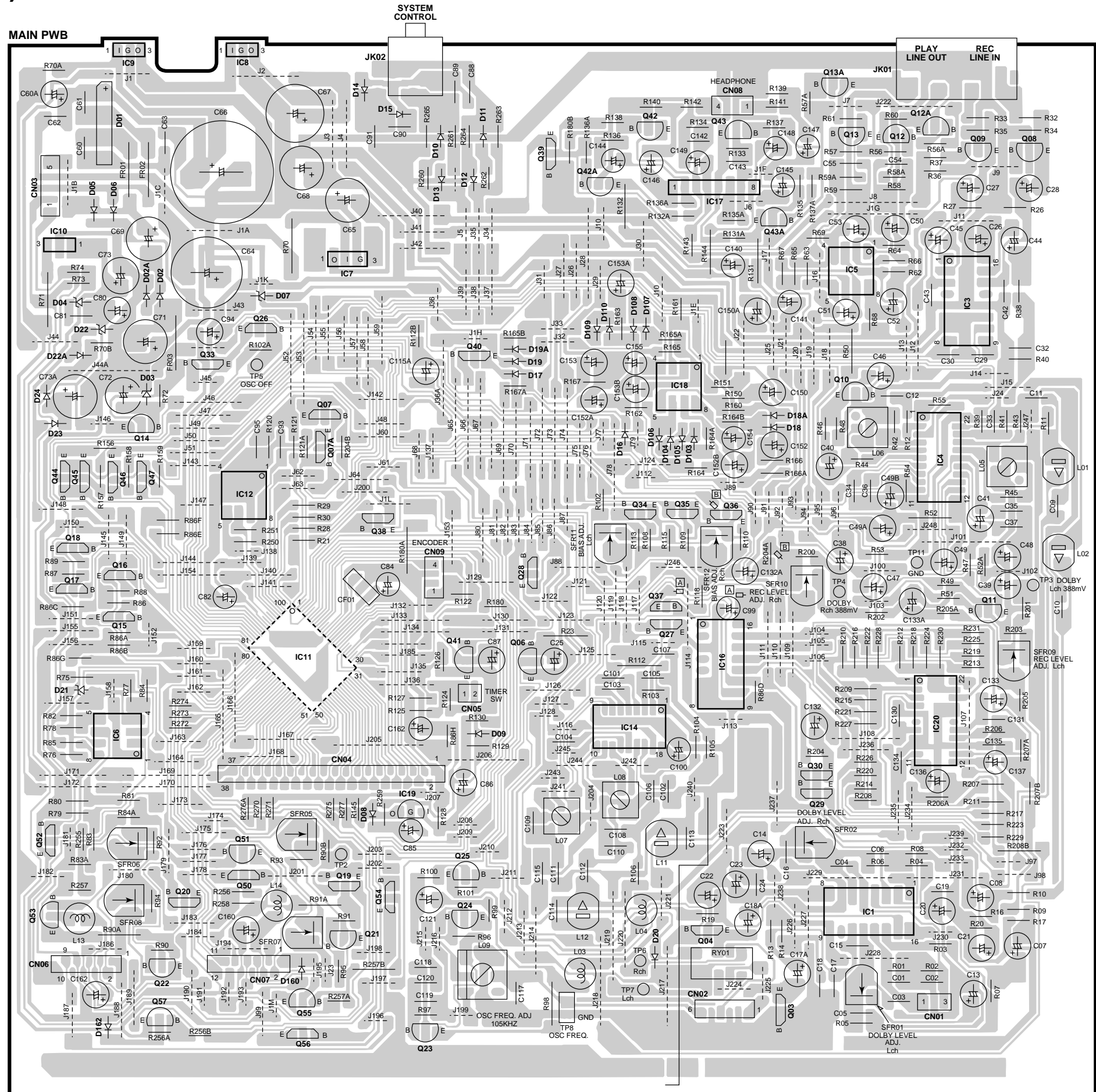

CAUTION: For continued safety, replace safety critical components only with manufacturer's recommended parts (refer to parts list). Δ indicates safety critical components. For continued protection against risk of fire, replace only with same type and rating fuse(s). To reduce the risk of electric shock, leakage-current or resistance measurements shall be carried out (exposed parts are acceptably insulated from the supply circuit) before the appliance is returned to the customer.

The DC voltage is an actual reading measured with a high impedance type voltmeter with a cassette loaded at playback mode. The measurement value may vary depending on the measuring instruments used or on the product. Bias circuit DC voltage is measured while in the record mode.

DOLBY and the double-D symbol are trademarks of Dolby Laboratories Licensing Corporation. Noise reduction circuit made under license from Dolby Laboratories Licensing Corporation.

2SA733
2SA934
2SC2878A
2SC945

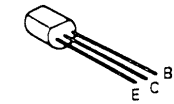

DTA124ES
DTC114TS
DTC124ES

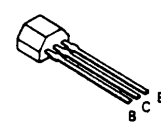

TA7784P
TC4051BP

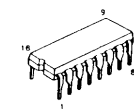

NJM4558DX

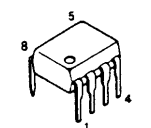

BA10393

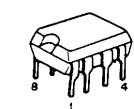

NJM4556AL

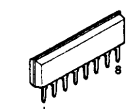

UPC1297CA

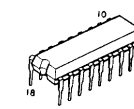

NJM78M05A

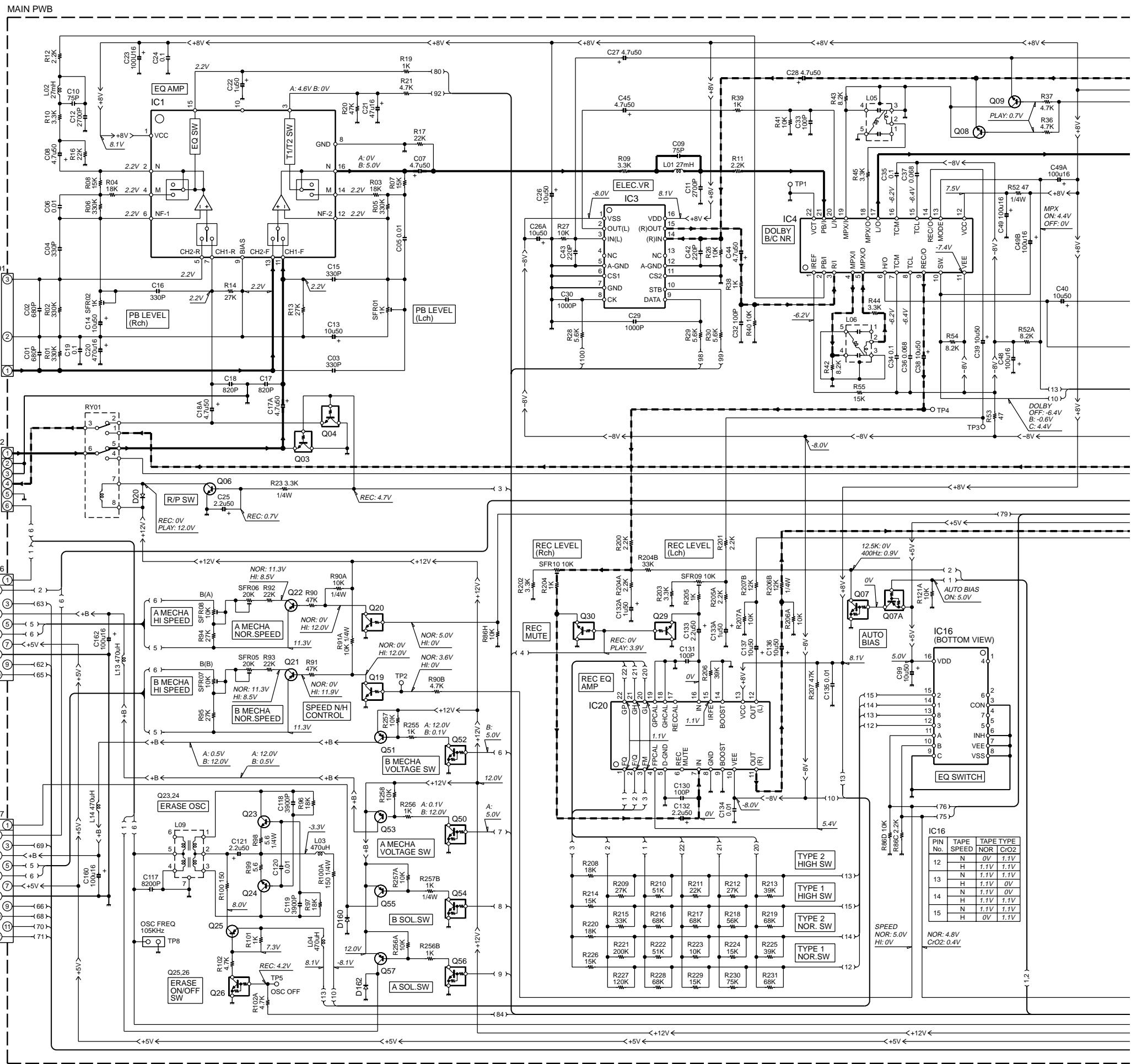
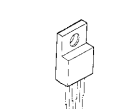

PIN No.	TAPE SPEED	TAPE TYPE	CRO2
12	N	0V	1.1V
	H	1.1V	1.1V
13	N	1.1V	1.1V
	H	1.1V	0V
14	N	1.1V	0V
	H	1.1V	1.1V
15	N	1.1V	1.1V
	H	0V	1.1V

SPEED
NOR: 5.0V
HI: 0V

NOR: 4.8V
CRO2: 0.4V

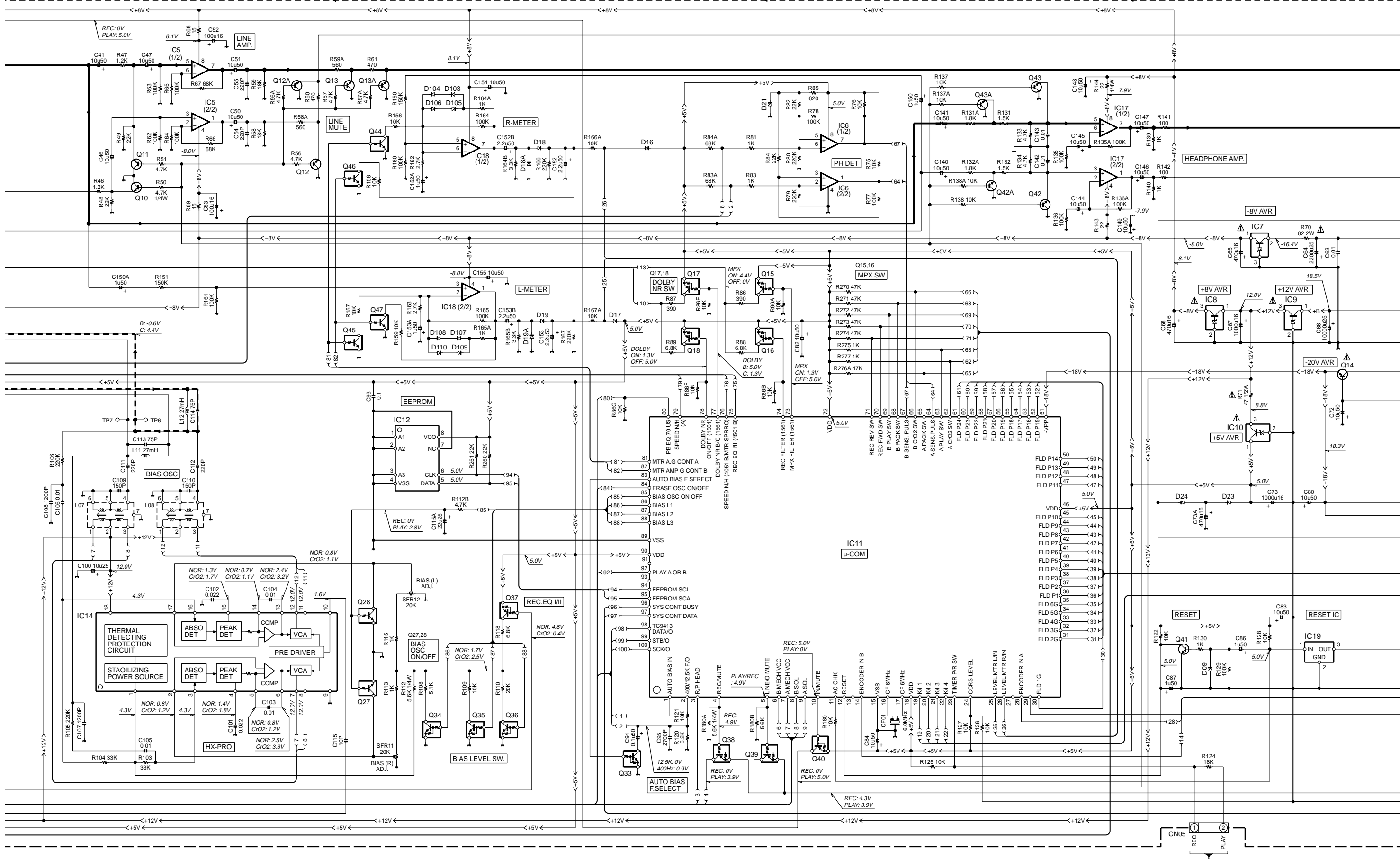

REC: 0V
PLAY: 5.0V

LINE AMP.

LINE MUTE

R-METER

L-METER

PH DET

HEADPHONE AMP.

-8V AVR

+8V AVR

+12V AVR

-20V AVR

+5V AVR

RESET

RESET IC

EEPROM

IC11
u-COM

IC14

HX-PRO

BIAS (L) ADJ.

BIAS (R) ADJ.

REC.EQ III

AUTO BIAS F.SELECT

REC: 5.0V
PLAY: 0V

REC: 4.9V

REC: 0V
PLAY: 3.9V

REC: 4.3V
PLAY: 3.9V

RESET

RESET IC

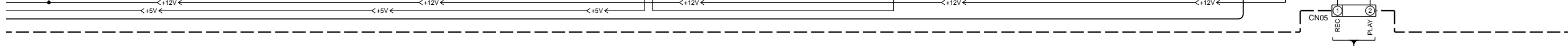

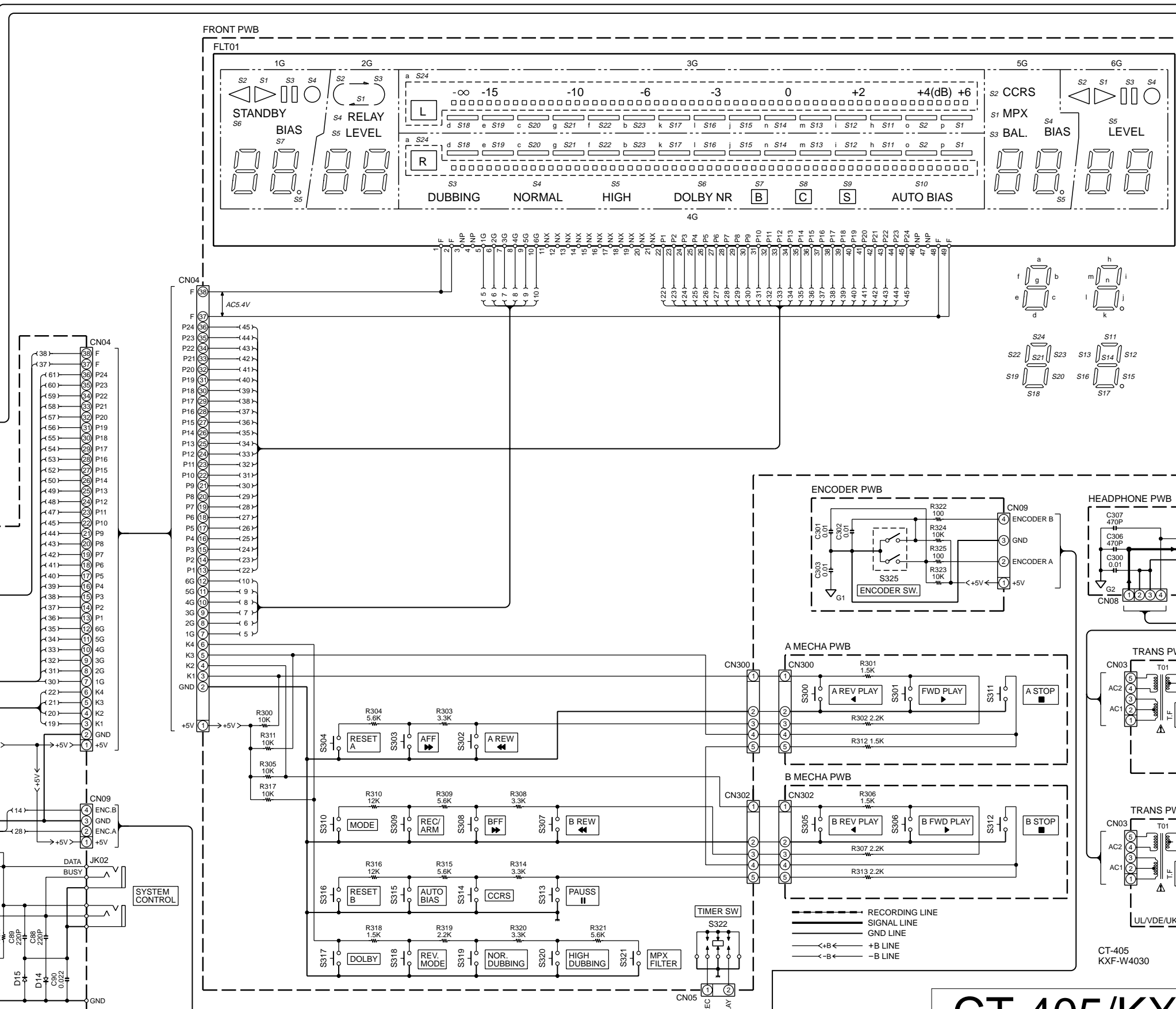
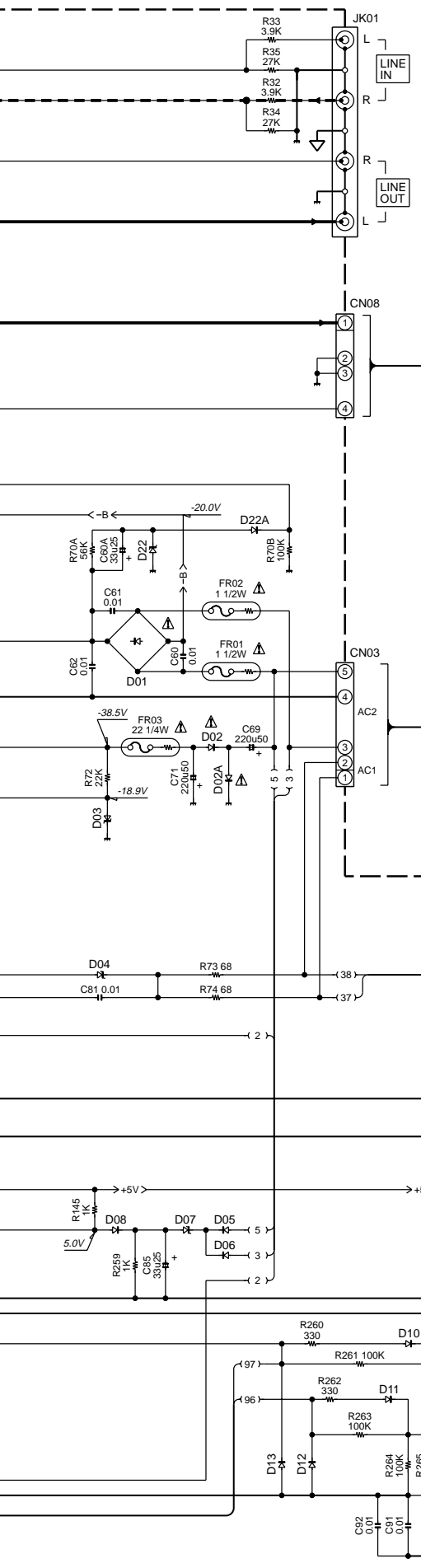

- IC1 : TA7784P
 - IC3 : TC9413AP
 - IC4 : CXA1561S
 - IC5,18 : NJM4558DX
 - IC6 : BA10393
 - IC7 : NJM79M08A
 - IC8 : NJM7808FA
 - IC9 : NJM7812FA
 - IC10 : NJM78M05A
 - IC11 : LC866524A-5P85
 - IC12 : S-24C01ADPX-01
 - IC14 : uPC1297CA
 - IC16 : TC4051BP
 - IC17 : NJM4556AL
 - IC19 : S8060
 - IC20 : CXA1598S
- Q03,04,19,20,27-30, 44-47 : DTC114TS
 - Q06 : 2SC2001L
 - Q07,26,33-36,50, 52,54,56 : DTC124ES
 - Q07A,15-18,37-40 : DTA124ES
 - Q08-13,12A,13A,42, 42A,43,43A : 2SC2878A
 - Q14,21,22 : 2SA733(P)
 - Q23,24 : 2SC2001L
 - Q25,51,53,55,57 : 2SA934
 - Q41 : 2SC945(P)
- D01 : GBL02
 - D02,02A,05,06,08-18,18A, 19,19A,20,22A,23,24, 103-110,160,162 : 1SS133
 - D03 : MTZJ20B
 - D04 : MTZJ5.6B
 - D07 : MTZJ6.8B
 - D21 : MTZJ2.7B
 - D22 : MTZJ3.9B

Y26-4480-10

CT-405/KXF-W4030

KENWOOD

* New Parts
Parts without **Parts No.** are not supplied.
Les articles non mentionnés dans le **Parts No.** ne sont pas fournis.
Teile ohne **Parts No.** werden nicht geliefert.



Ref. No	Add-ress	New Parts	Parts No.	Description	Desti-nation	Re-marks
CT-405/KXF-W4030						
601	1A	*	A01-3764-08	TOP COVER 100704003D	KPTEE2	
601	1A	*	A01-3765-08	TOP COVER 101904003D	S	
602	2A	*	A22-2211-08	CASS. HOLDER(A) 200204003D	KPTEE2	
602	2A	*	A22-2213-08	CASS. HOLDER(A) 201504003D	S	
603	2A	*	A22-2212-08	CASS. HOLDER(B) 200304003D	KPTEE2	
603	2A	*	A22-2214-08	CASS. HOLDER(B) 201604003D	S	
604	2A	*	A53-2226-08	CASS.DOOR(A)ASSY	KP	
604	2A	*	A53-2227-08	CASS.DOOR(A)ASSY	S	
604	2A	*	A53-2228-08	CASS.DOOR(A)ASSY	TEE2	
605	2A	*	A53-2229-08	CASS.DOOR(B)ASSY	KPTEE2	
605	2A	*	A53-2230-08	CASS.DOOR(B)ASSY	S	
606	2A	*	A60-1886-08	FRONT PANEL ASSY	KPTEE2	
606	2A	*	A60-1887-08	FRONT PANEL ASSY	S	
610	2A	*	B43-0302-04	BADGE 101404D430		
611	2A	*	B03-3869-08	DISPLAY PLATE 100604003D		
612	2A	*	B03-3870-08	DISPLAY WINDOW 100504003D		
620	2A,2B	*	D39-0325-08	GEAR DAMPER 2000001265		
621	1A	*	D40-1697-08	CASS. DECK(PB) 4380205340		
622	2B	*	D40-1698-08	CASS. DECK(R/P) 4380105330		
630	1C	*	E30-2952-08	AC CORD 463157W060	KP	
630	1C	*	E30-2953-08	AC CORD 463221W060	EE2S	
630	1C	*	E30-2963-08	AC CORD 463321A060	T	
631	1B,1C	*	E35-2664-08	FFC 38P 260M/M 5423826100		
632	1B,1C	*	E35-2665-08	FFC 10P 200M/M 5421020100		
633	2B,1C	*	E35-2666-08	FFC 12P 320M/M 5421232100		
634	1B	*	E30-0505-05	PATCH CORD 5620100051		
635	1B	*	E30-2816-05	3.5Q ST.PLUG AS 5620100063		
650	2A	*	G01-4222-08	DOOR SPRING(A) 200604003D		
651	2A	*	G01-4223-08	DOOR SPRING(B) 200704003D		
652	2C	*	G16-1210-08	FOOT RUBBER 200604D430		
653	1B,2B	*	G01-4224-08	EJECT SPRING 201004003D		
660	2C	*	J02-1480-08	FOOT 101004001B		
661	2C	*	J42-0083-05	CORD BUSHING 4580000024		
662	2C	*	J39-1015-08	PCB SUPPORT 2057068803		
663	1B,2B	*	J39-1017-08	EJECT COLLAR 201104003D		
670	2A	*	K27-2413-08	ROTARY KNOB 101404003D	KPTEE2	
670	2A	*	K27-2414-08	ROTARY KNOB 102404003D	S	
672	2B	*	K27-2425-08	CONTROL BUTTON 101104003D	KPTEE2	
672	2B	*	K27-2426-08	CONTROL BUTTON 102104003D	S	
673	2A	*	K27-2427-08	POWER KNOB 101204003D	KPTEE2	
673	2A	*	K27-2428-08	POWER KNOB 102204003D	S	
674	2B	*	K27-2429-08	TIMER KNOB 101304003D	KPTEE2	
674	2B	*	K27-2430-08	TIMER KNOB 102304003D	S	
675	2B	*	K27-2431-08	EJECT KNOB 101504003D		
-		*	B46-0310-03	WARRANTY CARD	TEE2S	
-		*	B46-0328-03	WARRANTY CARD	K	
-		*	B46-0347-03	WARRANTY CARD	P	
-		*	B60-4536-08	INST BOOK(EN) 9080026000	KPTEE2	
-		*	B60-4537-08	INST BOOK(FR) 9080026010	PES	
-		*	B60-4538-08	INST BOOK(GE) 9080026020	ES	
-		*	B60-4539-08	INST BOOK(NE) 9080026030	ES	
-		*	B60-4540-08	INST BOOK(IT) 9080026040	ES	

L: Scandinavia K: USA P: Canada R: Mexico C: China I: Malaysia
Y: PX(Far East,Hawaii) T: England E: Europe G: Germany V: China(Shanghai)
Y: AAFES(Europe) X: Australia Q: Russia H: Korea M: Other Areas indicates safety critical components.

18

* New Parts
Parts without **Parts No.** are not supplied.
Les articles non mentionnés dans le **Parts No.** ne sont pas fournis.
Teile ohne **Parts No.** werden nicht geliefert.



Ref. No	Add-ress	New Parts	Parts No.	Description	Desti-nation	Re-marks
-		*	B60-4541-08	INST BOOK(ES) 9080026050	ES	
-		*	B60-4543-08	INST BOOK(PL) 9080026070	E2	
-		*	B60-4544-08	INST BOOK(HU) 9080026080	E2	
-		*	B60-4545-08	INST BOOK(SC) 9080026090	E2	
-		*	H10-7675-08	POLY FOAM(L) 900404003D	T	
-		*	H10-7676-08	POLY FOAM(R) 900504003D	KPTEE2S	
-		*	H10-7677-08	POLY FOAM(L) 900104003D	KPTEE2S	
-		*	H10-7678-08	POLY FOAM(R) 900204003D		
-		*	H25-0000-08	POLY BAG 9906000604		
-		*	H25-1527-08	POLY BAG(I/B) 9902304049		
-		*	H50-3635-08	GIFT BOX 900604003D	T	
-		*	H50-3636-08	GIFT BOX 900804003D	E	
-		*	H50-3637-08	GIFT BOX 900904003D	E2	
-		*	H50-3638-08	GIFT BOX 901004003D	S	
-		*	H50-3640-08	GIFT BOX 900304003D	KP	
△ T01	1C	*	L07-2886-08	POWER TRANS 420F542250	KP	
△ T01	1C	*	L07-2887-08	POWER TRANS 420F544264	TEE2S	
MAIN PWB						
C01_02			C91-0755-05	CERAMIC	680PF	K
C03_04			C91-0751-05	CERAMIC	330PF	K
C05_06			C91-0769-05	CERAMIC	0.010UF	K
C07_08			CE04KW1H4R7M	ELECTRO	4.7UF	50WV
C09_10			CC45FSL1H750J	CERAMIC	75PF	J
C11_12			CK45FB1H272K	CERAMIC	2700PF	K
C13_14			CE04KW1H100M	ELECTRO	10UF	50WV
C15_16			C91-0751-05	CERAMIC	330PF	K
C17_18			C91-0756-05	CERAMIC	820PF	K
C17A,18A			CE04KW1H4R7M	ELECTRO	4.7UF	50WV
C19			CK45FB1H104Z	CERAMIC	0.10UF	Z
C20			CE04KW1C471M	ELECTRO	470UF	16WV
C21			CE04KW1C470M	ELECTRO	47UF	16WV
C22			CE04KW1H010M	ELECTRO	1.0UF	50WV
C23			CE04KW1C101M	ELECTRO	100UF	16WV
C24			CK45FB1H104Z	CERAMIC	0.10UF	Z
C25			CE04KW1H2R2M	ELECTRO	2.2UF	50WV
C26_26A			CE04KW1H100M	ELECTRO	10UF	50WV
C27_28			CE04KW1H4R7M	ELECTRO	4.7UF	50WV
C29_30			C91-0757-05	CERAMIC	1000PF	K
C32_33			C91-0745-05	CERAMIC	100PF	K
C34_35			CQ92FM1J104J	MYLAR	0.10UF	J
C36_37			CQ92FM1H683J	MYLAR	0.068UF	J
C38-41			CE04KW1H100M	ELECTRO	10UF	50WV
C42_43			C91-0749-05	CERAMIC	220PF	K
C44_45			CE04KW1H4R7M	ELECTRO	4.7UF	50WV
C46_47			CE04KW1H100M	ELECTRO	10UF	50WV
C48_49			CE04KW1C101M	ELECTRO	100UF	16WV
C49A			CE04KW1C101M	ELECTRO	100UF	16WV
C49B			CE04KW1C101M	ELECTRO	100UF	16WV
C50_51			CE04KW1H100M	ELECTRO	10UF	50WV
C52_53			CE04KW1C101M	ELECTRO	100UF	16WV
C54_55			C91-0749-05	CERAMIC	220PF	K
C60-63			CK45FB1H103Z	CERAMIC	0.010UF	Z
C60A			CE04KW1E330M	ELECTRO	33UF	25WV
C64			CE04KW1E222M	ELECTRO	2200UF	25WV

L: Scandinavia K: USA P: Canada R: Mexico C: China I: Malaysia
Y: PX(Far East,Hawaii) T: England E: Europe G: Germany V: China(Shanghai)
Y: AAFES(Europe) X: Australia Q: Russia H: Korea M: Other Areas indicates safety critical components.

CT-405/KXF-W4030

PARTS LIST

19

* New Parts
Parts without **Parts No.** are not supplied.
Les articles non mentionnes dans le **Parts No.** ne sont pas fournis.
Teile ohne **Parts No.** werden nicht geliefert.

3

Ref. No	Add-ress	New Parts	Parts No.	Description	Desti-nation	Re-marks
C65		*	CE04KW1C471M	ELECTRO 470UF 16WV		
C66			C91-1601-08	ELECTRO 1000UF 25WV		
C67			CE04KW1C102M	ELECTRO 1000UF 16WV		
C68			CE04KW1C471M	ELECTRO 470UF 16WV		
C69			CE04KW1H221M	ELECTRO 220UF 50WV		
C71			CE04KW1H221M	ELECTRO 220UF 50WV		
C72			CE04KW1H100M	ELECTRO 10UF 50WV		
C73			CE04KW1C102M	ELECTRO 1000UF 16WV		
C73A			CE04KW1C471M	ELECTRO 470UF 16WV		
C80			CE04KW1H100M	ELECTRO 10UF 50WV		
C81			C91-0769-05	CERAMIC 0.010UF K		
C82-84			CE04KW1H100M	ELECTRO 10UF 50WV		
C85			CE04KW1E330M	ELECTRO 33UF 25WV		
C86,87			CE04KW1H010M	ELECTRO 1.0UF 50WV		
C88,89			C91-0749-05	CERAMIC 220PF K		
C90			CK45FB1H223K	CERAMIC 0.022UF K		
C91,92			C91-0769-05	CERAMIC 0.010UF K		
C93			CK45FB1H104Z	CERAMIC 0.10UF Z		
C94			CE04KW1HOR1M	ELECTRO 0.1UF 50WV		
C95			CK45FB1H272K	CERAMIC 2700PF K		
C99			CE04KW1H100M	ELECTRO 10UF 50WV		
C100			CE04KW1E100M	ELECTRO 10UF 25WV		
C101,102			CK45FB1H223K	CERAMIC 0.022UF K		
C103-106			C91-0769-05	CERAMIC 0.010UF K		
C107,108			C91-0758-05	CERAMIC 1200PF M		
C109,110			C91-1476-05	FILM 150PF J		
C111,112			C91-1478-05	FILM 220PF J		
C113,114			CC45FSL1H750D	CERAMIC 75PF D		
C115			CC45FSL1H100J	CERAMIC 10PF J		
C115A			CE04KW1E220M	ELECTRO 22UF 25WV		
C117			CQ92FM2A822J	MYLAR 8200PF J		
C118,119			CQ92FM1H392J	MYLAR 3900PF J		
C120			CQ92FM2A103J	MYLAR 0.010UF J		
C121			CE04KW1H2R2M	ELECTRO 2.2UF 50WV		
C130,131			C91-0745-05	CERAMIC 100PF K		
C132,133			CE04KW1H2R2M	ELECTRO 2.2UF 50WV		
C132A,133A			CE04KW1H010M	ELECTRO 1.0UF 50WV		
C134,135			C91-0769-05	CERAMIC 0.010UF K		
C136,137			CE04KW1H100M	ELECTRO 10UF 50WV		
C140,141			CE04KW1H100M	ELECTRO 10UF 50WV		
C142,143			C91-0769-05	CERAMIC 0.010UF K		
C144-149			CE04KW1H100M	ELECTRO 10UF 50WV		
C150,150A			CE04KW1H010M	ELECTRO 1.0UF 50WV		
C152,152B			CE04KW1H2R2M	ELECTRO 2.2UF 50WV		
C152A,153A			CE04KW1H010M	ELECTRO 1.0UF 50WV		
C153,153B			CE04KW1H2R2M	ELECTRO 2.2UF 50WV		
C154,155			CE04KW1H100M	ELECTRO 10UF 50WV		
C160			CE04KW1C101M	ELECTRO 100UF 16WV		
C162			CE04KW1C101M	ELECTRO 100UF 16WV		
CN01		*	E40-8667-08	3P CON. ASSY C488031703		
CN02		*	E40-8668-08	6P CON. ASSY C488061930		
CN04		*	E40-8669-08	FFC 38P BASE 4493800263		
CN06		*	E40-8670-08	FFC 10P BASE 4491000263		
CN07		*	E40-8671-08	FFC 12P BASE 4491200263		

L : Scandinavia K : USA P : Canada R : Mexico C : China I : Malaysia
 Y : PX(Far East,Hawaii) T : England E : Europe G : Germany V : China(Shanghai)
 Y : AAFES(Europe) X : Australia Q : Russia H : Korea M : Other Areas Δ indicates safety critical components.

* New Parts
Parts without **Parts No.** are not supplied.
Les articles non mentionnes dans le **Parts No.** ne sont pas fournis.
Teile ohne **Parts No.** werden nicht geliefert.

4

Ref. No	Add-ress	New Parts	Parts No.	Description	Desti-nation	Re-marks
JK01	1C		E63-1076-08	4P RCA JACK 4500800421		
JK02	1C		E11-0918-08	2P JACK(3.5Q) 4500100492		
CF01			L78-0716-08	RESONATOR 416090600M		
L01,02		*	L39-1389-08	INDUCTOR 4329227311		
L03,04		*	L33-1604-08	MOTOR CHOKE 4328247187		
L05,06			L39-1329-08	MPX TRAP COIL 4360400720		
L07,08		*	L32-1030-08	OSC COIL 4330802200		
L09		*	L32-1031-08	BIAS COIL 4330802130		
L11,12		*	L39-1389-08	INDUCTOR 4329227311		
L13,14		*	L33-1605-08	MOTOR CHOKE 4328247187		
Δ FR01,02		*	R92-1966-08	FUSE RESIST 1 J 1/2W		
Δ FR03			R92-0508-05	FUSE RESIST 22 G 1/4W		
Δ R70			RS14GB3D820J	FL-PROOF RS 82 J 2W		
Δ R71			RD14BB2H470J	RD 47 J 1/2W		
SFR01,02		*	R32-0094-08	TRIMMING POT. 5226102170		
SRF05,06		*	R32-0095-08	TRIMMING POT. 5226203170		
SRF07-10		*	R32-0096-08	TRIMMING POT. 5226103170		
SRF11,12		*	R32-0095-08	TRIMMING POT. 5226203170		
RY01			S76-0109-08	RELAY P2-B 4390000068		
Δ D01			GBL02	DIODE		
D02,02A			1SS133	DIODE		
D03			MTZJ20B	ZENER DIODE		
D04			MTZJ5.6B	ZENER DIODE		
D05,06			1SS133	DIODE		
D07			MTZJ6.8B	ZENER DIODE		
D08-20			1SS133	DIODE		
D21			MTZJ2.7B	ZENER DIODE		
D22			MTZJ3.9B	ZENER DIODE		
D22A			1SS133	DIODE		
D23,24			1SS133	DIODE		
D103-110			1SS133	DIODE		
D160			1SS133	DIODE		
D162			1SS133	DIODE		
IC1			TA7784P	IC(PB AMP)		
IC3		*	TC9413AP	IC		
IC4		*	CXA1561S	IC		
IC5			NJM4558DX	IC(OP AMP X2)		
IC6			BA10393	IC(DUAL COMPALATOR)		
IC7		*	NJM79M08A	IC		
Δ IC8		*	NJM7808FA	IC		
IC9			NJM7812FA	IC(VOLTAGE REGULATOR/ +12V)		
IC10			NJM78M05A	IC(VOLTAGE REGULATOR/+5V)		
IC11		*	LC-866524A-5P85	IC		
IC12		*	S-24C01ADPX-01	IC		
IC14			UPC1297CA	IC(DOL HX PRO SYSTEM)		
IC16			TC4051BP	IC(8CH MPX/ DE-MPX)		
IC17			NJM4556AL	IC(OP AMP)		
IC18			NJM4558DX	IC(OP AMP X2)		
IC19			S806D	IC		
IC20			CXA1598S	IC		
Q03,04			DTC114TS	TRANSISTOR		
Q06			2SC2001L	TRANSISTOR		

L : Scandinavia K : USA P : Canada R : Mexico C : China I : Malaysia
 Y : PX(Far East,Hawaii) T : England E : Europe G : Germany V : China(Shanghai)
 Y : AAFES(Europe) X : Australia Q : Russia H : Korea M : Other Areas Δ indicates safety critical components.

CT-405/KXF-W4030
 PARTS LIST

* New Parts
 Parts without **Parts No.** are not supplied.
 Les articles non mentionnés dans le **Parts No.** ne sont pas fournis.
 Teile ohne **Parts No.** werden nicht geliefert.

5

Ref. No	Add-ress	New Parts	Parts No.	Description	Desti-nation	Re-marks
Q07 Q07A Q08 -13A Q14 Q15 -18			DTC124ES DTA124ES 2SC2878A 2SA733(P) DTA124ES	TRANSISTOR TRANSISTOR TRANSISTOR TRANSISTOR TRANSISTOR		
Q19 ,20 Q21 ,22 Q23 ,24 Q25 Q26			DTC114TS 2SA733(P) 2SC2001L 2SA934 DTC124ES	TRANSISTOR TRANSISTOR TRANSISTOR TRANSISTOR TRANSISTOR		
Q27 -30 Q33 -36 Q37 -40 Q41 Q42 ,42A			DTC114TS DTC124ES DTA124ES 2SC945(P) 2SC2878A	TRANSISTOR TRANSISTOR TRANSISTOR TRANSISTOR TRANSISTOR		
Q43 ,43A Q44 -47 Q50 Q51 Q52			2SC2878A DTC114TS DTC124ES 2SA934 DTC124ES	TRANSISTOR TRANSISTOR TRANSISTOR TRANSISTOR TRANSISTOR		
Q53 Q54 Q55 Q56 Q57			2SA934 DTC124ES 2SA934 DTC124ES 2SA934	TRANSISTOR TRANSISTOR TRANSISTOR TRANSISTOR TRANSISTOR		
FRONT PWB						
CN04		*	E40-8672-08	FFC 38P BASE	4493800265	
S302-304 S307-310 S313-321 S322	1B 1B,1C 1B,1C 1B		S68-0039-08 S68-0039-08 S68-0039-08 * S62-0096-08	TACT SW TACT SW TACT SW SLIDE SW	4400000156 4400000156 4400000156 4410301204	
FLT01	1B	*	SVA-D6MS09	VF DISPLAY	4110500273	
POWER SW PWB/TRANS PWB						
C305		*	C91-1594-08	SPARK KILLER	5106472141	
S323	2B		S68-0041-08	POWER SW	4430102450	
HEADPHONE PWB						
C300 C306,307 JK300			C91-0769-05 C91-0753-05 * E11-0925-08	CERAMIC CERAMIC H/P JACK	0.010UF 470PF 4500500496	K K
ENCODER PWB						
C301-303 S325			C91-0769-05 * R31-0107-08	CERAMIC ENCODER SW	0.010UF 4420131710	K
A MECHANISM PWB						
S300,301 S311	2A 2A		S68-0039-08 S68-0039-08	TACT SW TACT SW	4400000156 4400000156	
B MECHANISM PWB						

L : Scandinavia K : USA P : Canada R : Mexico C : China I : Malaysia
 Y : PX(Far East,Hawaii) T : England E : Europe G : Germany V : China(Shanghai)
 Y : AAFES(Europe) X : Australia Q : Russia H : Korea M : Other Areas ⚠ indicates safety critical components .

* New Parts
 Parts without **Parts No.** are not supplied.
 Les articles non mentionnés dans le **Parts No.** ne sont pas fournis.
 Teile ohne **Parts No.** werden nicht geliefert.

6

Ref. No	Add-ress	New Parts	Parts No.	Description	Desti-nation	Re-marks
S305,306 S312	2B 2B		S68-0039-08 S68-0039-08	TACT SW TACT SW	4400000156 4400000156	
CASSETTE MECHANISM						
BM BR	1B,2C 1B,2C		D16-0748-08 D16-0749-08	MAIN BELT R/F BELT		

L : Scandinavia K : USA P : Canada R : Mexico C : China I : Malaysia
 Y : PX(Far East,Hawaii) T : England E : Europe G : Germany V : China(Shanghai)
 Y : AAFES(Europe) X : Australia Q : Russia H : Korea M : Other Areas ⚠ indicates safety critical components .

HOW TO READ THE PARTS LIST

Destination column has the abbreviation for sale country and model.

ABBREVIATION OF MODEL AND MASS PRODUCTION'S DESTINATIONS

MODEL	CNT	Australia	Canada	China	England	Europe	Germany	Korea	Malaysia
ABB.		X	P	C	T	E	G	H	I
CT-405		-	P	-	-	-	-	-	-
KXF-W4030		-	-	-	T	E	-	-	-
KXF-W4030E		-	-	-	-	E2	-	-	-
KXF-W4030-S		-	-	-	-	S	-	-	-
MODEL	CNT	Mexico	PX/AAFES	Russia	Scandinavia	Shanghai	USA	Other area	
ABB.		R	Y	Q	L	V	K	M	
CT-405		-	-	-	-	-	K	-	
KXF-W4030		-	-	-	-	-	-	-	
KXF-W4030E		-	-	-	-	-	-	-	
KXF-W4030-S		-	-	-	-	-	-	-	

CT-405/KXF-W4030

SPECIFICATIONS

Track System	4 track, 2 channel stereo	Harmonic Distortion	Less than 1.2 %
Recording System	AC bias (Frequency: 105 kHz)	(at 315 Hz, 3rd H.D., 250 nWb/m, TYPE II tape)	
Heads	A DECK	Input sensitivity/Impedance	
	Playback head	LINE IN	122.8 mV/47 kΩ
	B DECK	Output Level/Impedance	
	Playback/recording heads..	LINE OUT	775 mV/1.0 kΩ
	Erasing head	Headphones	0.5 mW/32 Ω
Motors	A DECK	[General]	
	DC motor x 1	Power Consumption	20 W
	B DECK	Dimensions	W: 440 mm (15-3/4")
	DC motor x 1		H: 132 mm (5-3/16")
Wow and Flutter	±0.17 % (IEC)		D: 380 mm (14-15/16")
	±0.28 % (DIN)	Weight (Net)	5.3 kg (11.7 lb)
	0.1 % (W.R.M.S)		
Fast Winding Time	Approx. 110 seconds (C-60 tape)		
Frequency Response			
TYPE I tape	30 Hz to 18,000 Hz, ±3 dB		
TYPE II tape	30 Hz to 19,000 Hz, ±3 dB		
Signal to Noise Ratio			
Dolby NR OFF	56 dB		
(IEC, 250 nWb/m, TYPE II tape)			
Dolby NR OFF	59 dB		
Dolby B NR ON	68 dB		
Dolby C NR ON	75 dB		
(3rd, H.D., 3 %, TYPE II tape)			



1. KENWOOD follows a policy of continuous advancements in development. For this reason specifications may be changed without notice.
2. The full performance may not be exhibited in an extremely cold location (under a water-freezing temperature).

CT-405/KXF-W4030

Note:

Component and circuit are subject to modification to insure best operation under differing local conditions. This manual is based on Europe (E) standard, and provides information on regional circuit modification through use of alternate schematic diagrams, and information on regional component variations through use of parts list.

KENWOOD CORPORATION

14-6,Dogenzaka 1-chome, Shibuya-ku, Tokyo, 150-8501 Japan

KENWOOD SERVICE CORPORATION

P.O BOX 22745, 2201 East Dominguez St., Long Beach, CA 90801-5745, U.S.A.

KENWOOD ELECTRONICS CANADA INC.

6070 Kestrel Road, Mississauga, Ontario, Canada L5T 1S8

KENWOOD ELECTRONICS LATIN AMERICA S.A.

P.O BOX 55-2791, Piso 6 plaza Chase, Cl. 47 y Aquilino de la Guardia Panama, Republic de Panama

KENWOOD ELECTRONICS BRASIL LTDA.

Av. Moema, 170-17, Andar-Cobertura "B", Ed. Maximum Service Center, 04077-020 Moema, São Paulo-SP-Brasil

KENWOOD ELECTRONICS U.K. LIMITED

KENWOOD House, Dwight Road, Watford, Herts., WD1 8EB., United Kingdom

KENWOOD ELECTRONICS BELGUM N.V.

Meachelsesteenweg 418, B-1930 Zaventem, Belgium

KENWOOD ELECTRONICS DEUTSCHLAND GMBH

Rembrücker Str. 15, 63150 Heusenstamm, Germany

KENWOOD ELECTRONICS FRANCE S.A.

13 Boulevard Ney, 75018 Paris, France

KENWOOD ELECTRONICS ITALIA S.p.A.

Via G. Sirtori, 7/9 20129, Milano, Italy

KENWOOD IBÉRICA S.A.

Bolivia, 239-08020 Barcelona, Spain

KENWOOD ELECTRONICS AUSTRALIA PTY. LTD.

(A.C.N. 001 499 074)

16 Giffnock Avenue, North Ryde, N.S.W. 2113, Australia

KENWOOD ELECTRONICS (HONG KONG) LTD.

Unit 3712-3724, Level 37, Tower 1, Metroplaza, 223 Hing Fong Road, Kwai Fong N.T., Hong Kong

KENWOOD ELECTRONICS GULF FZE

P.O.Box 61318, Jebel Ali, Dubai, U.A.E.

KENWOOD ELECTRONICS SINGAPORE PTE LTD.

No. 1 Genting Lane #02-02, KENWOOD Building, Singapore, 349544

KENWOOD ELECTRONICS (MALAYSIA) SDN BHD.

#4.01 Level 4, Wisma Academy Lot 4A, Jalan 19/1 46300 Petaling Jaya Selangor Darul Ehsan Malaysia

KENWOOD ELECTRONICS (THAILAND) CO., LTD.

2019 New Pechburi Road, Bangkapi, Huaykwang, Bangkok, 10320 Thailand