

MULTIPLE CD PLAYER

# 103CD/104CD/1050CD DP-R797/R3090/R4090 SERVICE MANUAL

# KENWOOD

© 1997-01/B51-5269-00 (K/K) 3795

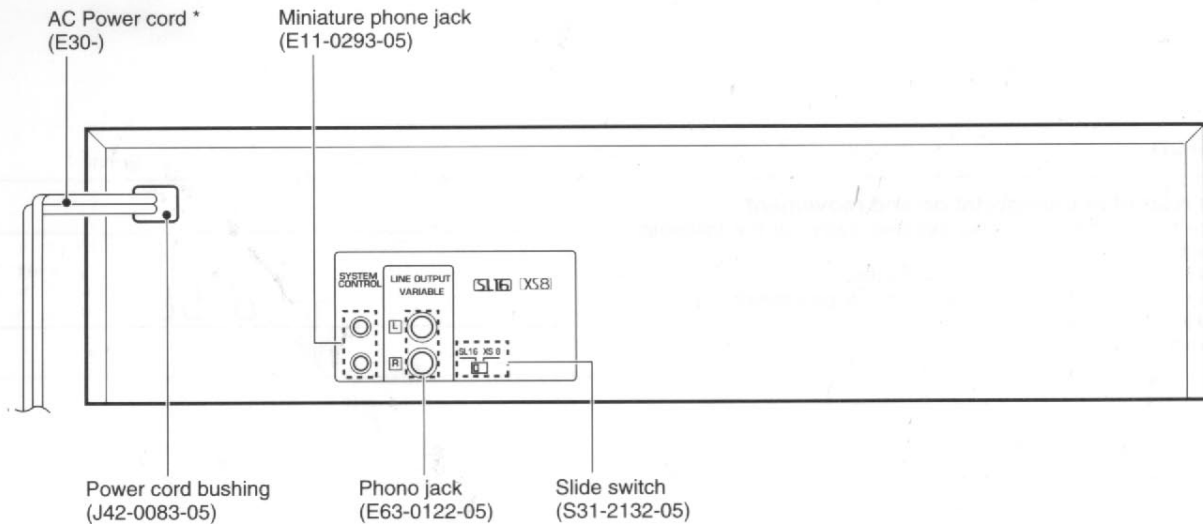
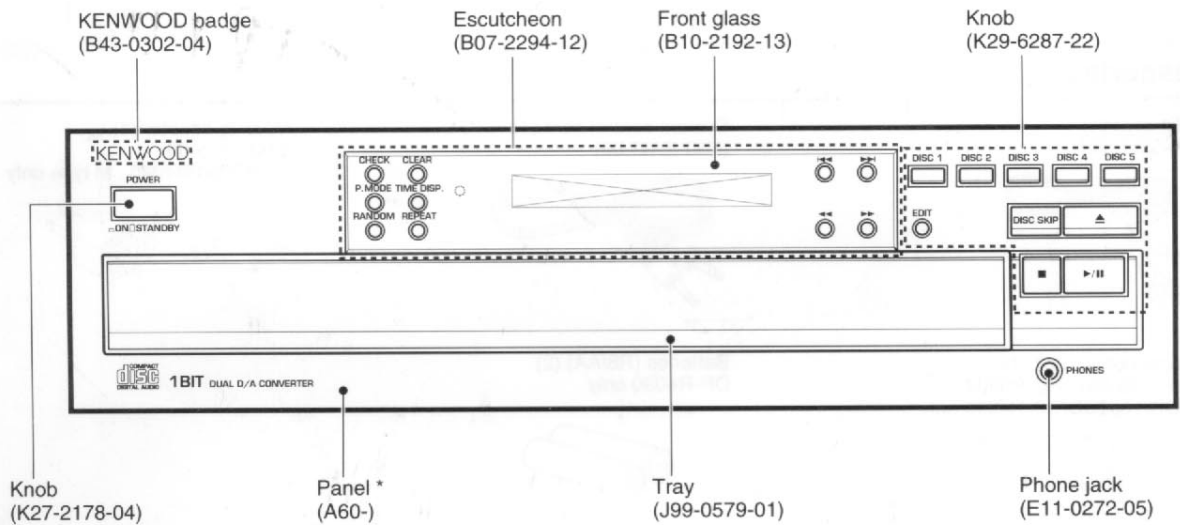

In compliance with Federal Regulations, following are reproductions of labels on, or inside the product relating to laser product safety.

KENWOOD-Corp. certifies this equipment conforms to DHHS Regulations No. 21 CFR 1040. 10, Chapter 1, Subchapter J.

**DANGER : Laser radiation when open and interlock defeated.  
AVOID DIRECT EXPOSURE TO BEAM.**

Illust is DP-R4090.

\* Refer to parts list on page 19.

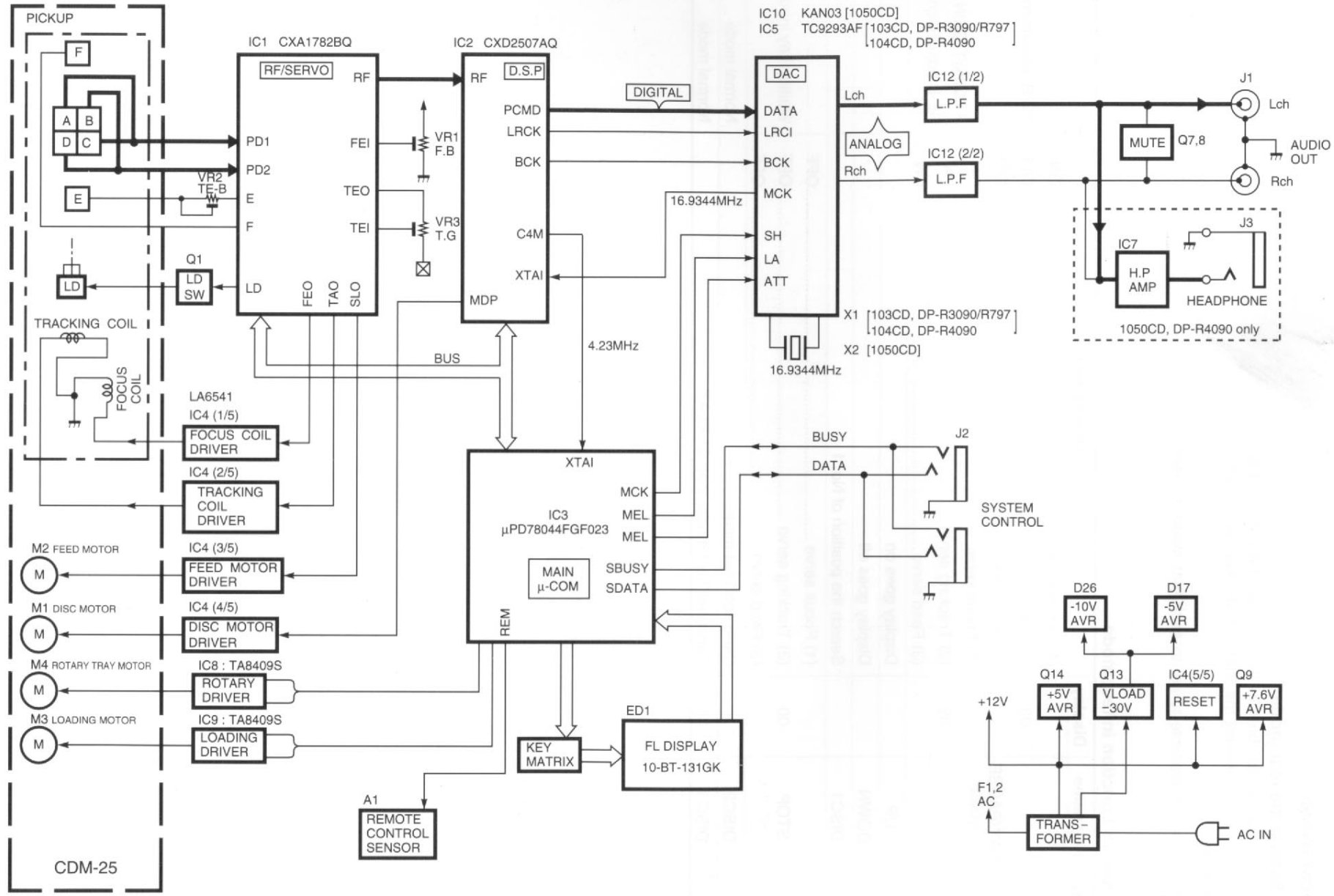

**103CD/104CD/1050CD/DP-R797/R3090/R4090**  
**BLOCK DIAGRAM**

# 103CD/104CD/1050CD/DP-R797/R3090/R4090

## ADJUSTMENT

No.	ITEM	INPUT SETTINGS	OUTPUT SETTINGS	PLAYER SETTINGS	ALIGNMENT POINTS	ALIGN FOR	FIG.
Open the tray (Normal mode), then turn the power off.							
1	LASER POWER	—	Apply the sensor section of optical power meter on the pickup lens.	While pressing the TIME DISP. key, turn the AC ON. (Test mode) Press the PLAY/PAUSE key, then confirm that the display is "03".	—	On the power from 0.08 to 0.15 mW, when the diffraction grating is correctly aligned with the RF level of 1.0 Vp-p or more.	(a)
1. Press the STOP key. 2. Press the OPEN key. 3. Load a disc, then press the CLOSE key. 4. Press the PLAY key. 5. Press the OPEN key to open the tray. 6. Turn the power off. (Player stops as the tray is opened while the disc clamped.) 7. While pressing the TIME DISP. key, turn the power ON to enter the Test mode.							
2	TRACKING ERROR BALANCE	Test disc Type 4	Connect an oscilloscope as follows. CH1 : RF (CN2 pin 1) CH2 : TE1 (CN2 pin 6)	Press the PLAY/PAUSE key, then confirm that the display is "03".	TE BALANCE VR2	Symmetry between upper and lower patterns	(c)
3	FOCUS ERROR BALANCE	Test disc Type 4	Connect an oscilloscope as follows. CH1 : RF (CN2 pin 1) CH2 : TE1 (CN2 pin 6)	Press the PLAY/PAUSE key, then confirm that the display is "05".	FE BALANCE VR1	Optimum eye pattern	(b) or (d)
4	TRACKING GAIN	Test disc Type 4 Apply signal of 1.2 kHz, 50mVrms to CN2 pin 5-6.	Connect a LPF to CN2 pin 5-6 to which you connect an oscilloscope or AC voltmeters.	Press the PLAY/PAUSE key, then confirm that the display is "05".	TRACKING GAIN VR3	Two VTVMs should read the same value.	(e)

**Note:**

Type 4 disc : SONY YEDS-18 Test Disc or equivalent.

LPF: Around 47 kΩ+ 390 pF or so.

Step 1-4 are in Test Mode.

**(a) Laser power**

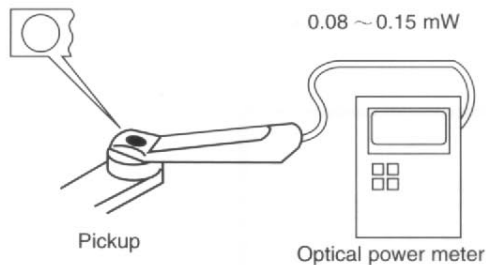

**(e) Tracking gain**

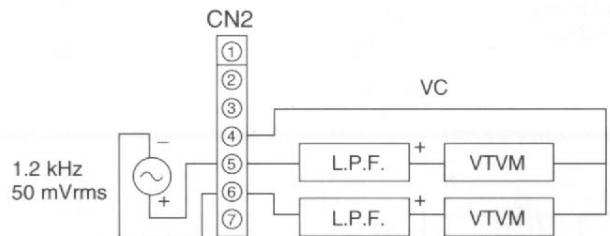

## ADJUSTMENT

FIG. (b)

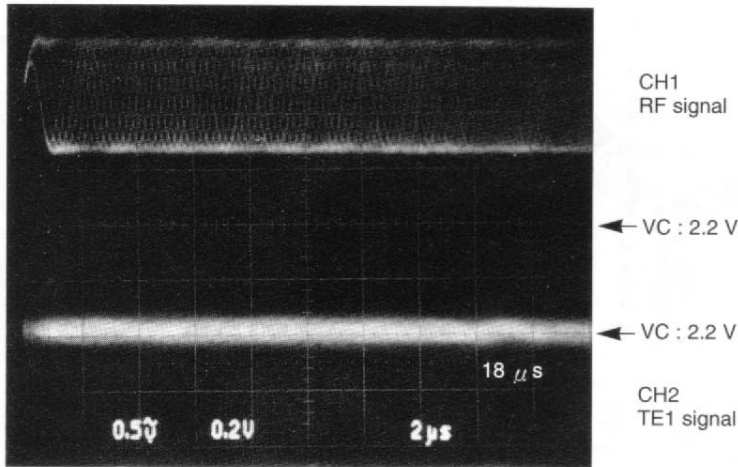

- RF signal and TE signal in test mode (PLAY).
- If the diffraction grating has been adjusted correctly, the influence of triggering is observed on the TE waveform of approx.  $18 \mu s$  from RF signal trigger point, in the form of a projection.

FIG. (c)

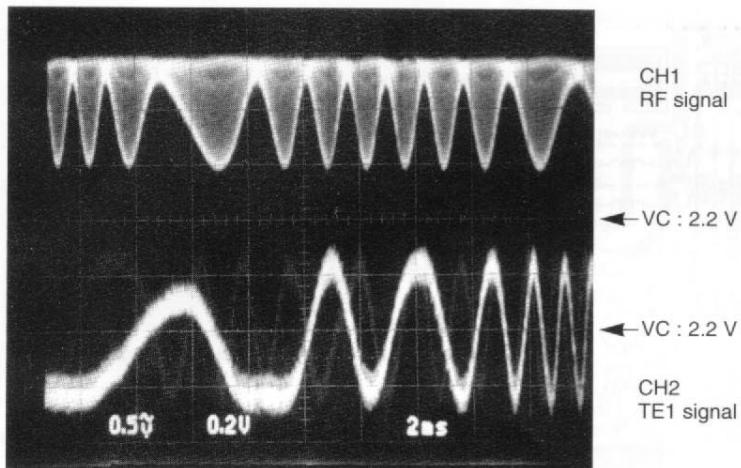

- RF signal and TE signal in test mode (Focusing servo ON / Tracking servo OFF). (Disc Type 4)
- Adjust TE signal so that the waveform is symmetrical in relation to VC. (TE BALANCE)

FIG. (d)

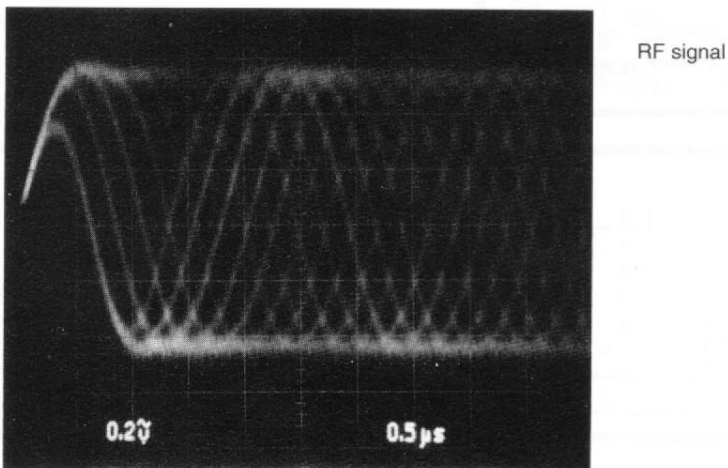

- RF signal in test mode (PLAY).
- Perform the tangential and focusing offset are focused into one point on the display. The crossing points above and below the center shall also be looked clearly. (FE BALANCE)



# PC BOARD(Component side view)

## CD player unit X32-328X-XX

- 0-10 : 1050CD (K, P) 0-
- 0-11 : 104CD (K, P) 0-
- 0-12 : 103CD (K, P) 0-
- DP-R797 (K, P)

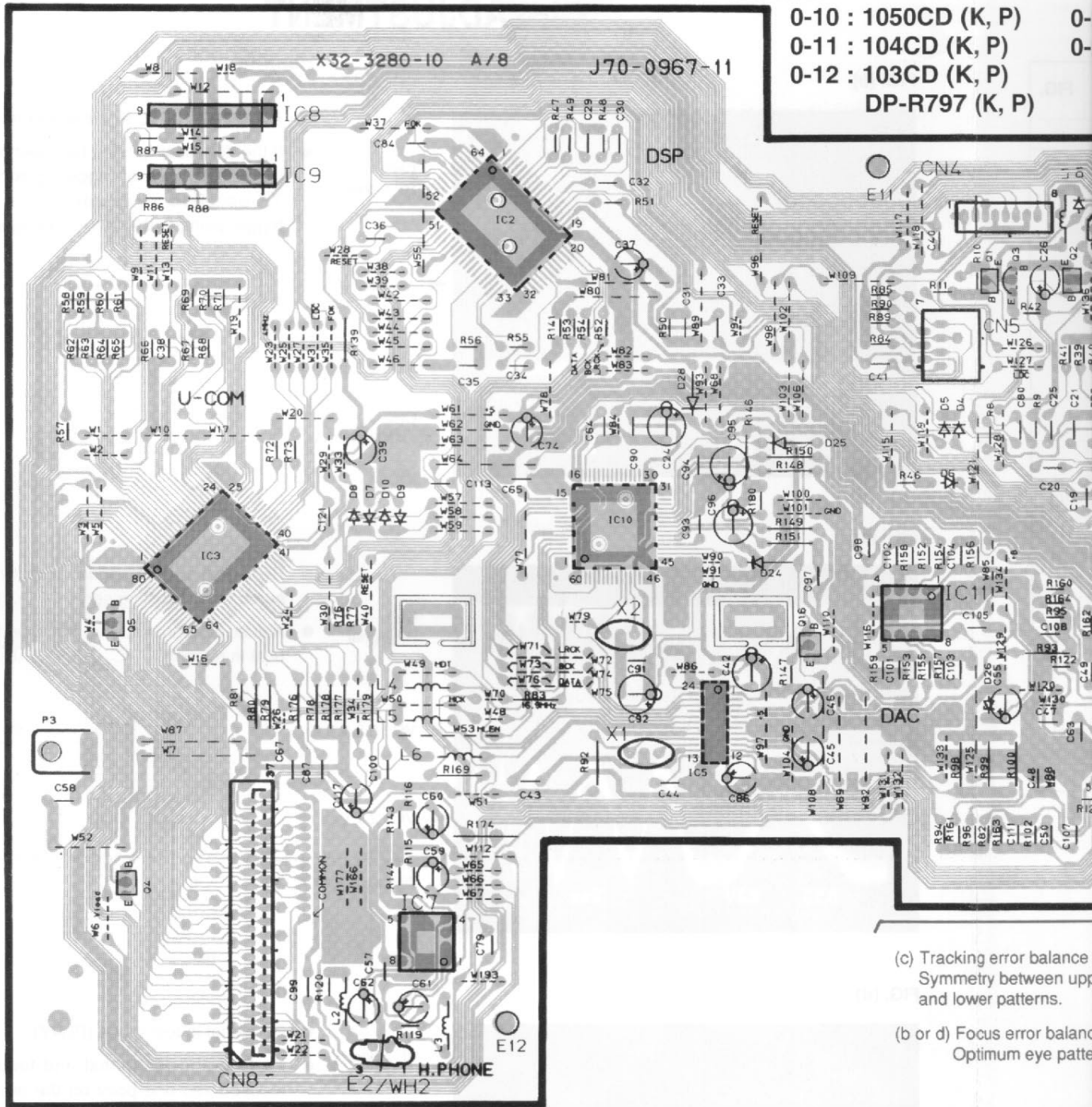

(c) Tracking error balance  
Symmetry between upper  
and lower patterns.

(b or d) Focus error balance  
Optimum eye pattern

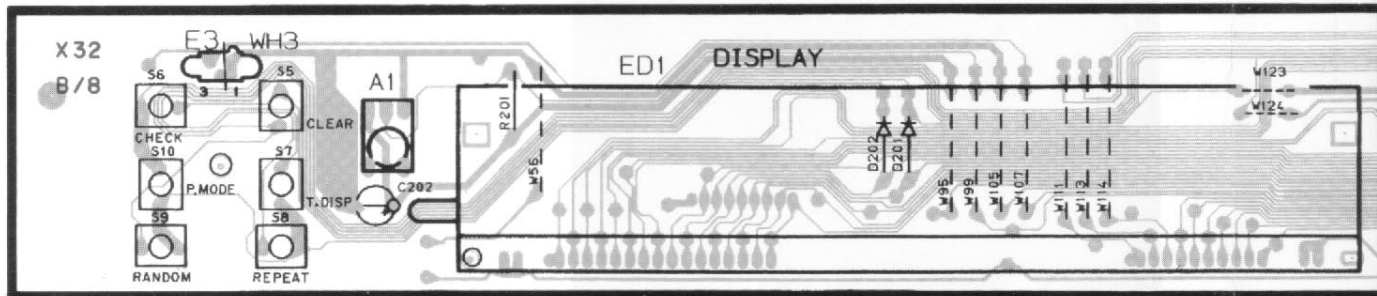

50CD (K, P)  
 4CD (K, P)  
 3CD (K, P)  
 P-R797 (K, P)

0-21 : 1050CD (Y)  
 0-22 : DP-R4090 (M)  
 104CD (Y)

0-23 : DP-R3090 (M)  
 103CD (Y)  
 DP-R797 (Y)

2-71 : DP-R4090 (E, T, X)  
 2-72 : DP-R3090 (E, T, X)

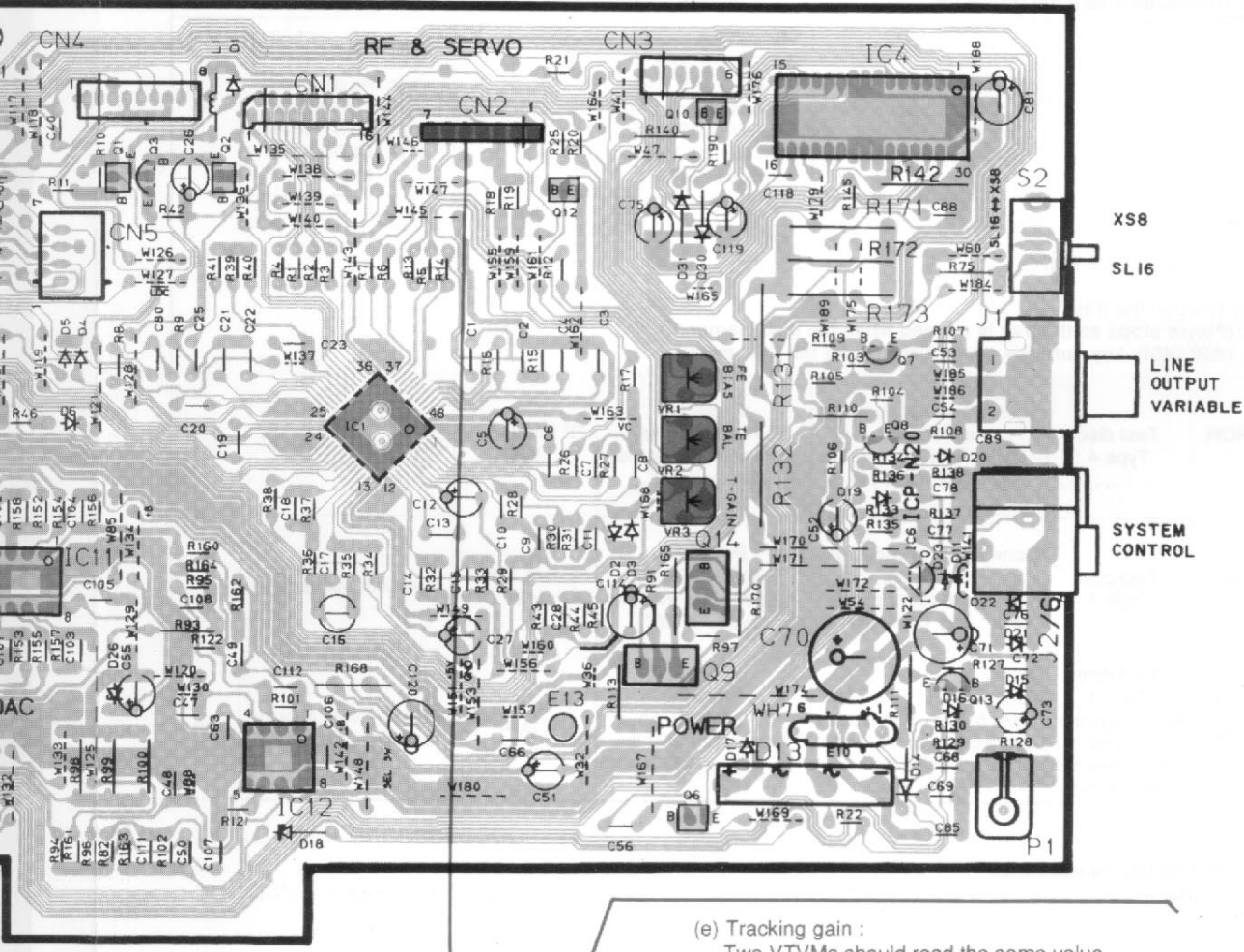

(c) Tracking error balance :  
 Symmetry between upper  
 and lower patterns.

(b) or (d) Focus error balance :  
 Optimum eye pattern.

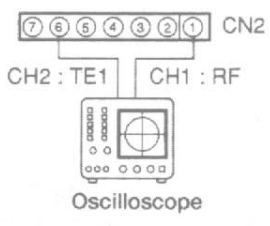

(e) Tracking gain :  
 Two VTVMs should read the same value.

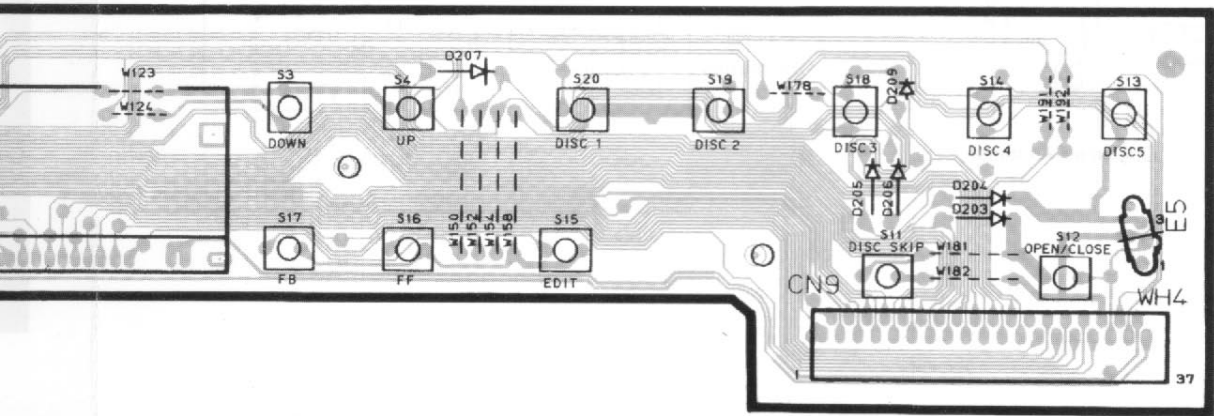
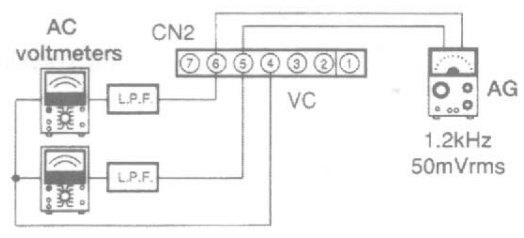

# PC BOARD(Component side view)

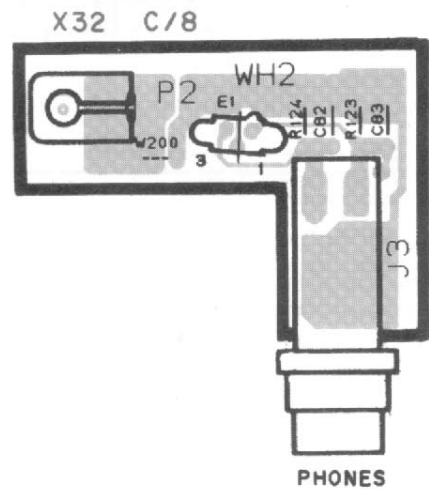
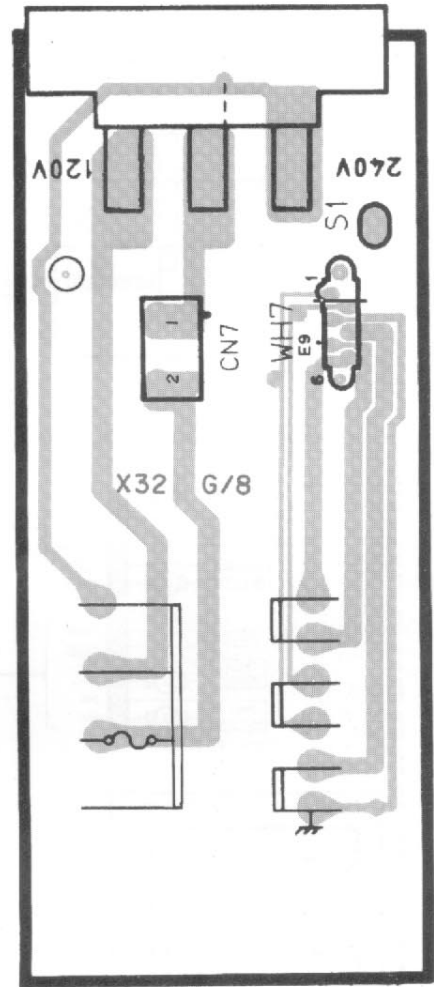
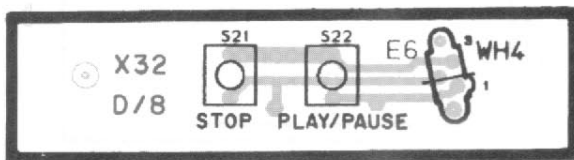
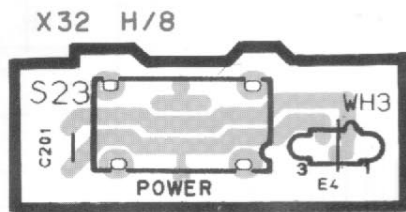
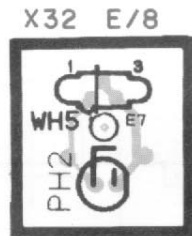
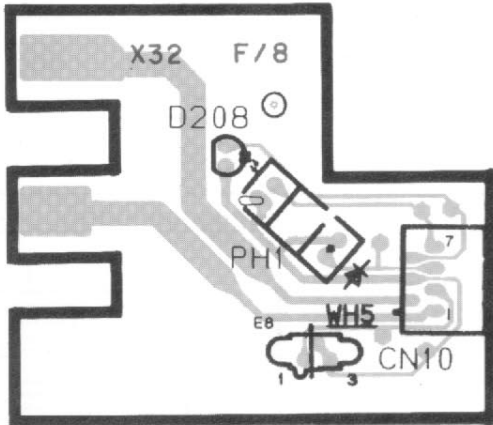

Refer to the schematic diagram for the value of resistors and capacitors.

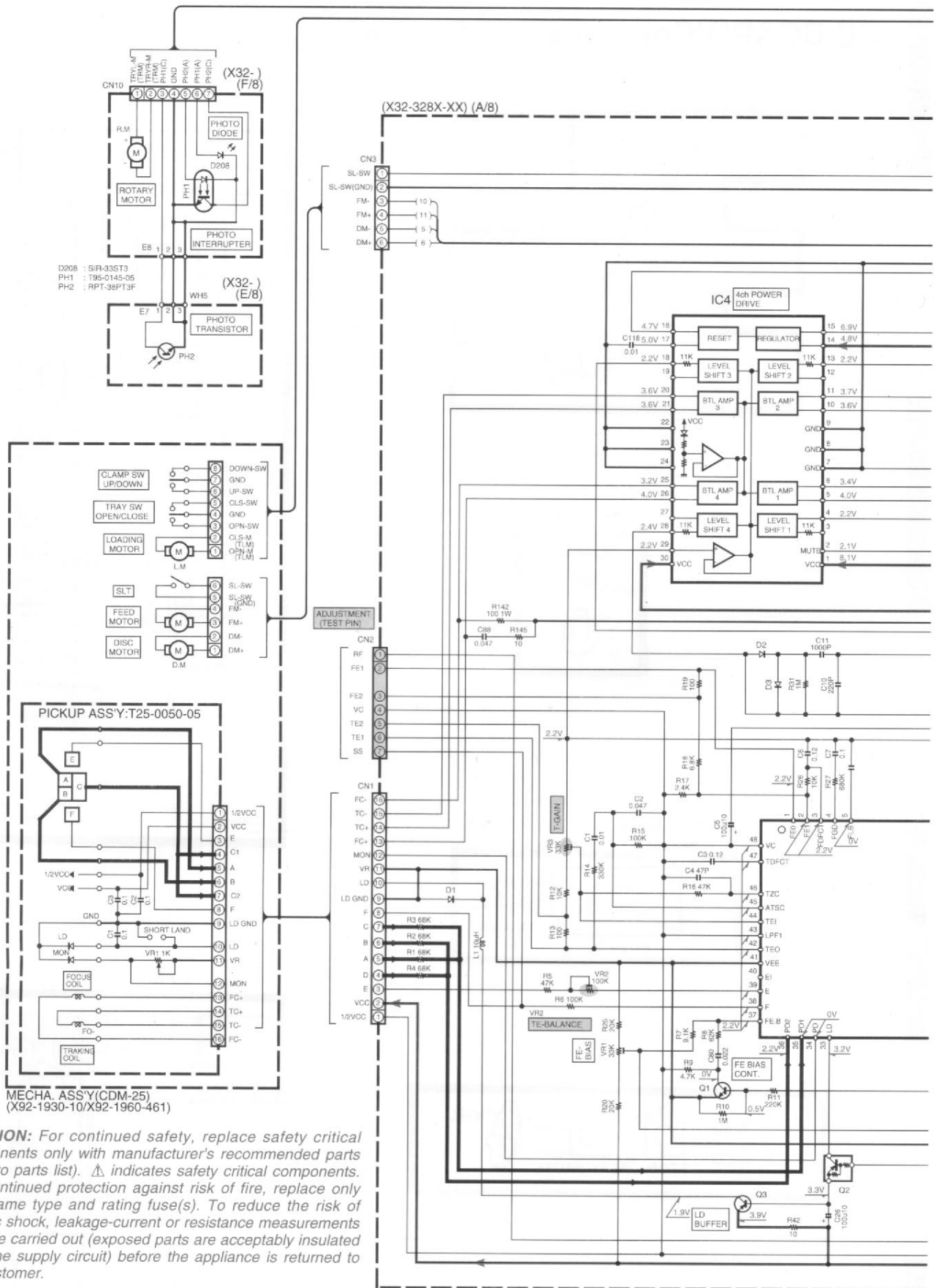

**CAUTION:** For continued safety, replace safety critical components only with manufacturer's recommended parts (refer to parts list).  $\Delta$  indicates safety critical components. For continued protection against risk of fire, replace only with same type and rating fuse(s). To reduce the risk of electric shock, leakage-current or resistance measurements shall be carried out (exposed parts are acceptably insulated from the supply circuit) before the appliance is returned to the customer.

The DC voltage is an actual reading measured with a high impedance type voltmeter. The measurement value may vary depending on the measuring instruments used or on the product. Refer to the voltage during PLAY unless otherwise specified; The value shown in ( ) is the voltage measured at the moment of STOP.

KAN03

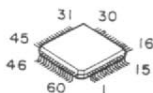

CXD2507AQ\*1

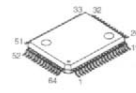

LA6541D

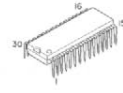



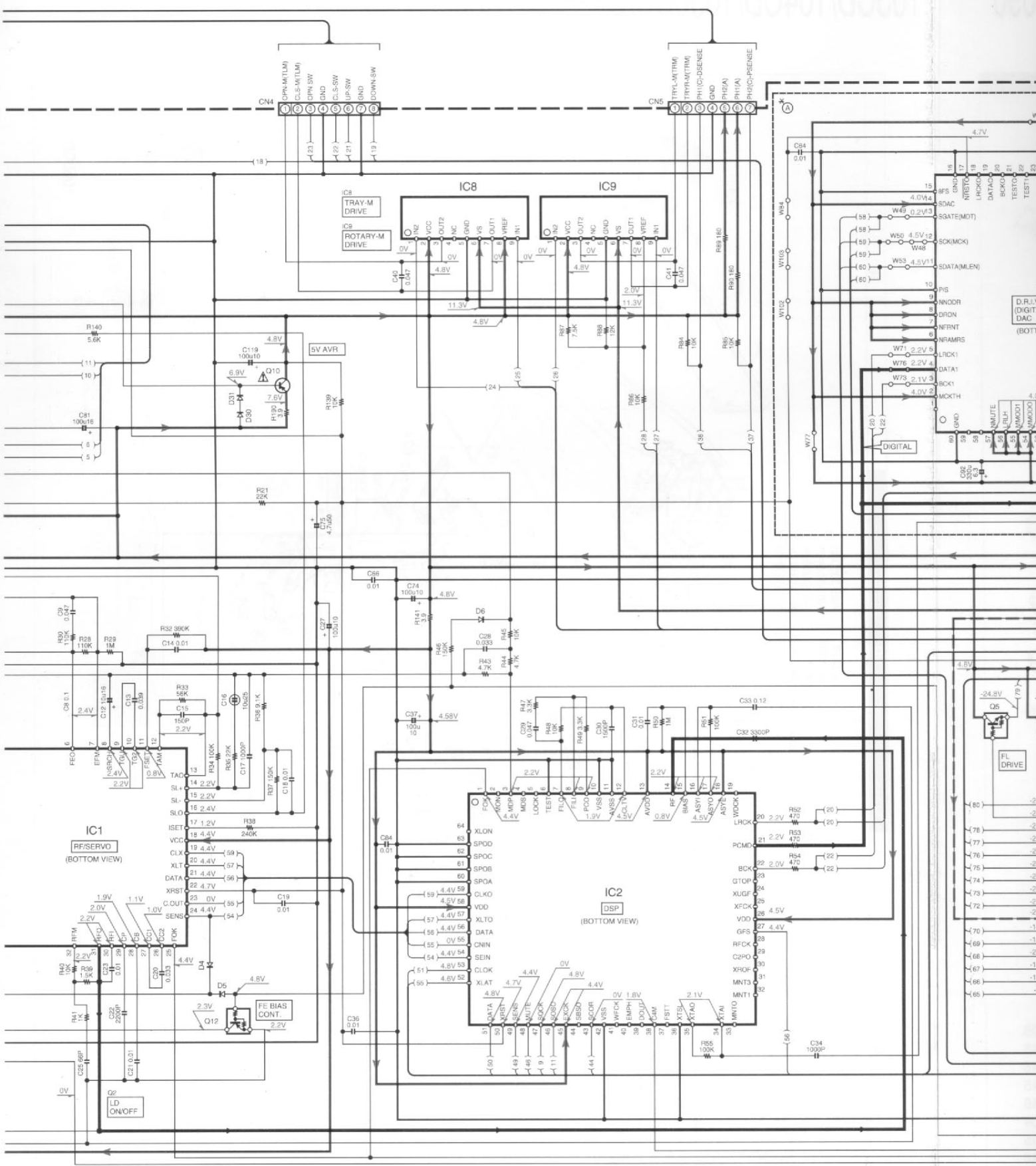

2SA1534A  
2SA954  
2SA992  
2SC2878

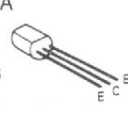

2SC2785



DTA124ESA  
DTC124ESA  
UN4112  
2SC1740S

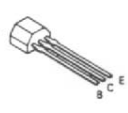

UN4212  
UN4219

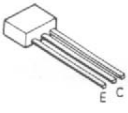

2SD2012



NJM4565D



TA84



1050CD  
X32-328X-XX

DESTINATION	COUNTRY	ABB	UNIT No.	A	B	C	IC3	IC6	D11	D23	S1	C99	R91, 97	E12	W122	W141	W197
U.S.A.	K	P	0-10	YES	NO	YES	uPD78044F-GF043	NO	NO	UZ-3.9BSB or MTJ3.9(B)	NO	NO	180	YES	YES	NO	YES
CANADA	K	P	0-10	YES	NO	YES	uPD78044F-GF043	NO	NO	UZ-3.9BSB or MTJ3.9(B)	NO	NO	180	YES	YES	NO	YES
PX	Y	X	0-21	YES	NO	YES	uPD78044F-GF043	NO	NO	UZ-3.9BSB or MTJ3.9(B)	NO	NO	180	YES	YES	NO	YES

104CD  
X32-328X-XX

DESTINATION	COUNTRY	ABB	UNIT No.	A	B	C	IC3	IC6	D11	
U.S.A.	K	P	0-11	YES	NO	YES	uPD78044F-GF023 or uPD78044F-GF043	NO	NO	UZ-3.9BSB or MTJ3.9(B)
CANADA	K	P	0-11	YES	NO	YES	uPD78044F-GF023 or uPD78044F-GF043	NO	NO	UZ-3.9BSB or MTJ3.9(B)
PX	Y	X	0-22	YES	NO	YES	uPD78044F-GF023 or uPD78044F-GF043	NO	NO	UZ-3.9BSB or MTJ3.9(B)
GENERAL MARKET	X	M	0-22	YES	NO	YES	uPD78044F-GF023 or uPD78044F-GF043	NO	NO	UZ-3.9BSB or MTJ3.9(B)
AUSTRALIA	X	T	0-21	YES	NO	YES	uPD78044F-GF023 or uPD78044F-GF043	NO	NO	UZ-3.9BSB or MTJ3.9(B)
U.K.	X	T	0-21	YES	NO	YES	uPD78044F-GF023 or uPD78044F-GF043	NO	NO	UZ-3.9BSB or MTJ3.9(B)
EUROPE	E	F	0-21	YES	NO	YES	uPD78044F-GF023 or uPD78044F-GF043	NO	NO	UZ-3.9BSB or MTJ3.9(B)

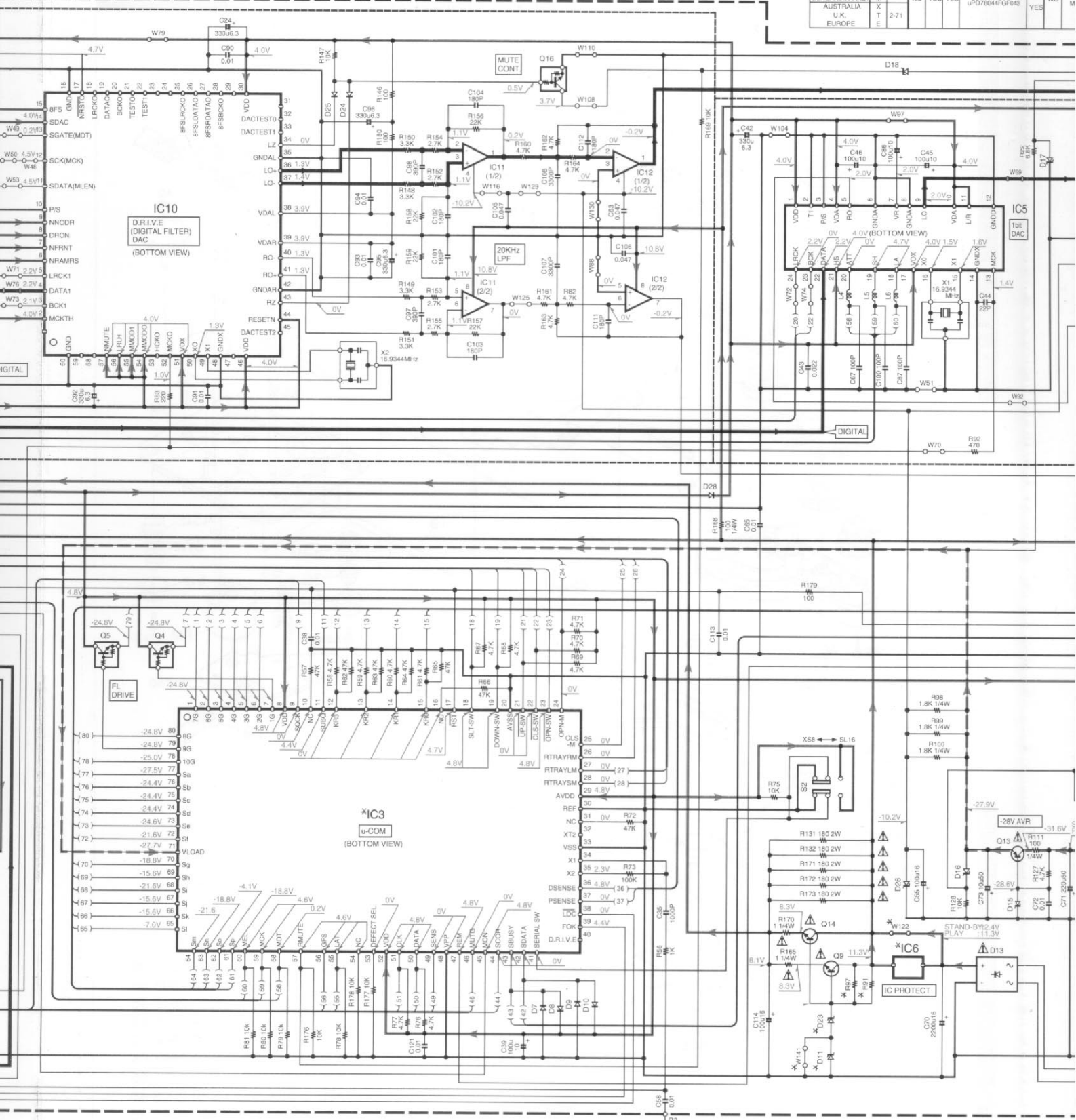

TA8409S

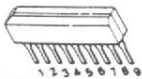

NJM4580D



TC9293AF

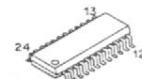

CXA1782BQ\*1

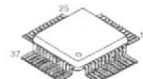

ICP-N20

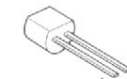

B	C	IC3	IC5	D11	D23	S1	C99	R91, 97	E12	W122	W141	W187
NO	NO	NO	NO	NO	NO	NO	NO	NO	NO	NO	NO	NO
YES	YES	UPD78044FGF023 or UPD78044FGF043	YES	NO	UZ-8.2BSB or MTZJ.8.2(B)	YES	YES	470	YES	NO	YES	NO
				YES		NO				NO		YES

103CD X32-328X-XX																	
DESTINATION	COUNTRY	ABB	UNIT No.	A	B	C	IC3	IC5	D11	D23	S1	C99	R91, 97	E12	W122	W141	W187
U.S.A.	U.S.A.	K	P	0-12				NO	NO		NO	NO					YES
CANADA	CANADA	K	P	0-12				NO	NO		NO	NO					YES
PX		Y		0-23				NO	NO	UZ-8.2BSB or MTZJ.8.2(B)	YES	YES	470	NO			NO
GENERAL MARKET		M			NO	YES	NO	UPD78044FGF023 or UPD78044FGF043	YES	NO	UZ-8.2BSB or MTZJ.8.2(B)	YES	YES	470	NO		NO
AUSTRALIA	AUSTRALIA	X	T	2-72					YES		NO	NO				YES	NO
U.K.	U.K.	X	T	2-72					NO		NO	NO					NO
EUROPE	EUROPE	E	E	2-72					NO		NO	NO					YES

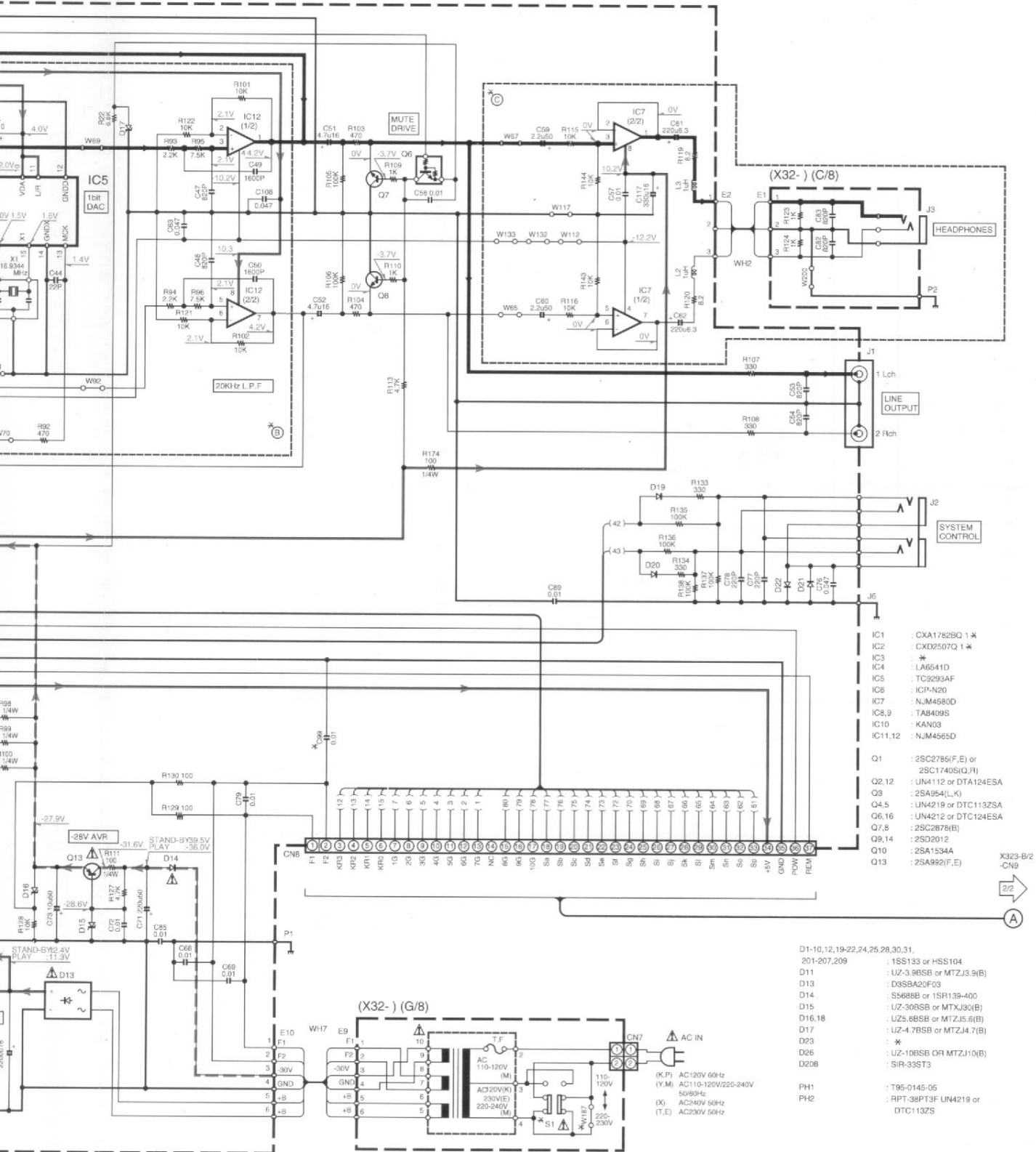

- IC1 : CXA1782B0 1 \*
- IC2 : CXD2507Q 1 \*
- IC3 : \*
- IC4 : LA6541D
- IC5 : TC9293AF
- IC6 : ICP-N20
- IC7 : NJM4580D
- IC8 : TA8409S
- IC10 : KAN03
- IC11,12 : NJM4565D
- Q1 : 2SC2785(F,E) or 2SC1740S(Q,F)
- Q2,12 : UN4112 or DTA124ESA
- Q3 : 2SA954(L,K)
- Q4,5 : UN4219 or DTC113ZSA
- O6,16 : UN4212 or DTC124ESA
- Q7,8 : 2SC2878(B)
- Q9,14 : 2SD2012
- Q10 : 2SA1534A
- Q13 : 2SA992(F,E)

- D1-10,12,19,22,24,25,28,30,31, 201-207,209 : 1S5133 or HSS104
- D11 : UZ-3.9BSB or MTZJ3.9(B)
- D13 : D3SBA20F03
- D14 : S5688B or 1SR139-400
- D15 : UZ-30BSB or MTZJ30(B)
- D16,18 : UZ5.8BSB or MTZJ5.8(B)
- D17 : UZ-4.7BSB or MTZJ4.7(B)
- D23 : \*
- D26 : UZ-10BSB OR MTZJ10(B)
- D208 : SIR-33S3
- PH1 : T95-0145-05
- PH2 : RPT-38PT3F UN4219 or DTC113ZS

1050CD/104CD/103CD(K) (1/2)

# 103CD/104CD/1050CD/DP-R797/R3090/R4090

Y22-4870-10

KENWOOD

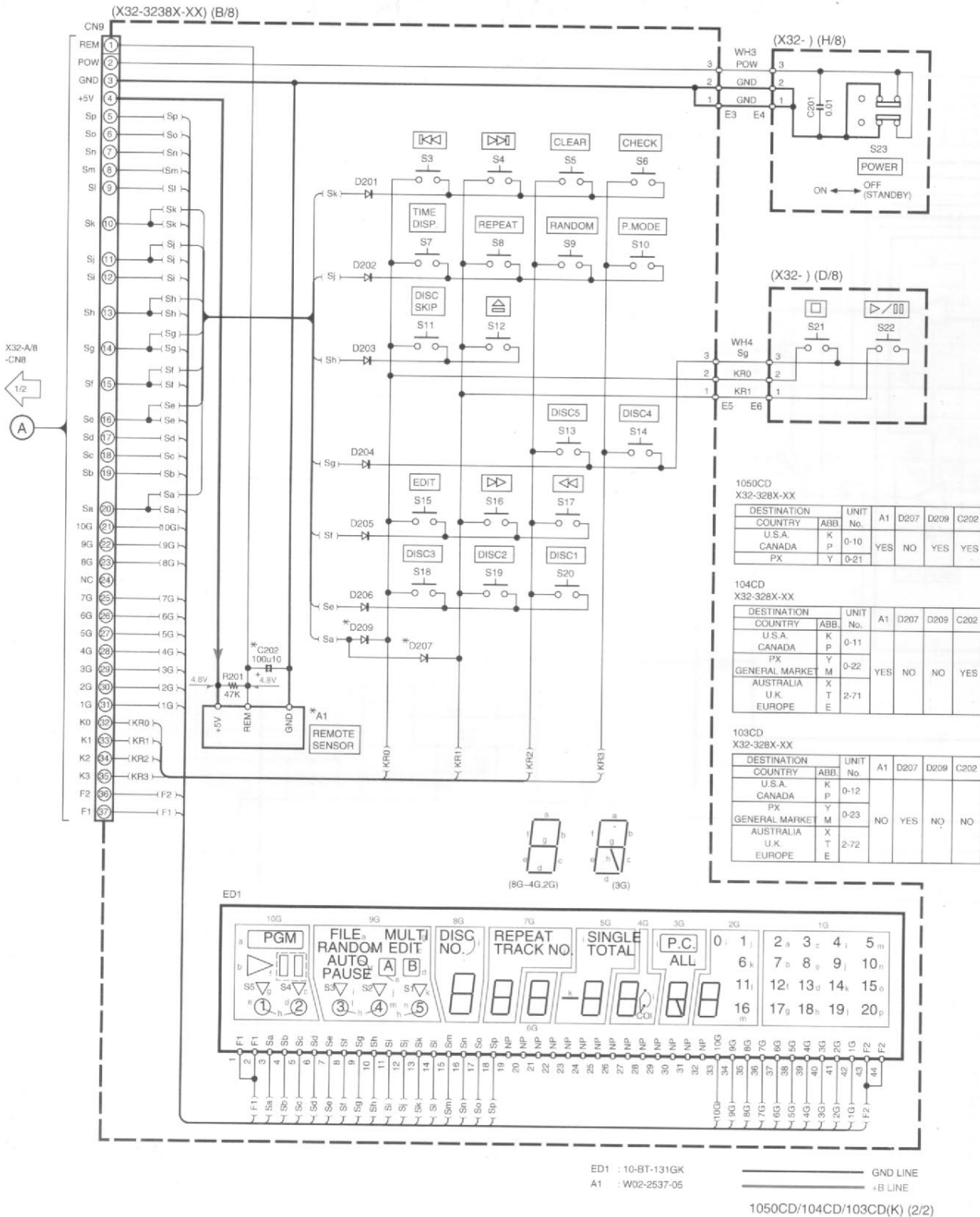

ED1 : 10-BT-131GK  
A1 : W02-2537-05

— GND LINE  
— +B LINE

1050CD/104CD/103CD(K) (2/2)

**CAUTION:** For continued safety, replace safety critical components only with manufacturer's recommended parts (refer to parts list).  $\Delta$  indicates safety critical components. For continued protection against risk of fire, replace only with same type and rating fuse(s). To reduce the risk of electric shock, leakage-current or resistance measurements shall be carried out (exposed parts are acceptably insulated from the supply circuit) before the appliance is returned to the customer.

The DC voltage is an actual reading measured with a high impedance type voltmeter. The measurement value may vary depending on the measuring instruments used or on the product. Refer to the voltage during PLAY unless otherwise specified; The value shown in ( ) is the voltage measured at the moment of STOP.

103CD/104CD/1050CD/DP-R797/R3090/R4090

Y22-4870-10

KENWOOD

## EXPLODED VIEW (UNIT)

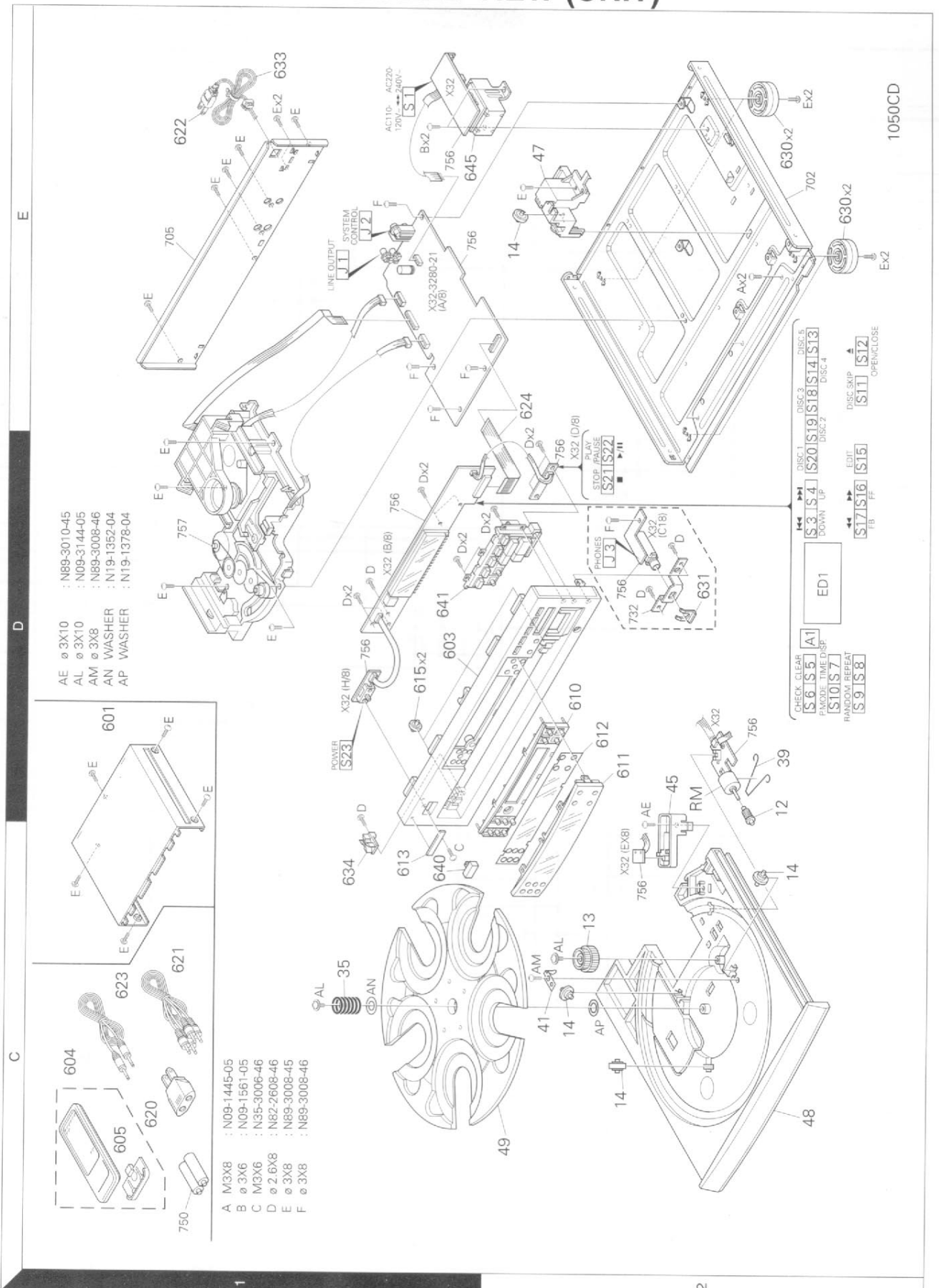

- AE  $\phi$  3X10 : N89-3010-45
- AL  $\phi$  3X10 : N09-3144-05
- AM  $\phi$  3X8 : N89-3008-46
- AN WASHER : N19-1352-04
- AP WASHER : N19-1378-04

- A M3X8 : N09-1445-05
- B  $\phi$  3X6 : N09-1561-05
- C M3X6 : N35-3006-46
- D  $\phi$  2.6X8 : N82-2608-46
- E  $\phi$  3X8 : N89-3008-45
- F  $\phi$  3X8 : N89-3008-46

CHECK CLEAR [S6] [S5] [A1]  
 PAUSE TIME DISP. [S10] [S7]  
 REPEAT [S9] [S8]

DOWN [S3] [S4]  
 UP [S20] [S19] [S18] [S14] [S13]

DISC 1 [S21] [S22]  
 DISC 2  
 DISC 3  
 DISC 4

DISC SKIP [S11] [S12]  
 OPEN/CLOSE [S17] [S16] [S15]

EJECT [S17] [S16] [S15]

ED1

1050CD



EXPLODED VIEW (MECHANISM)

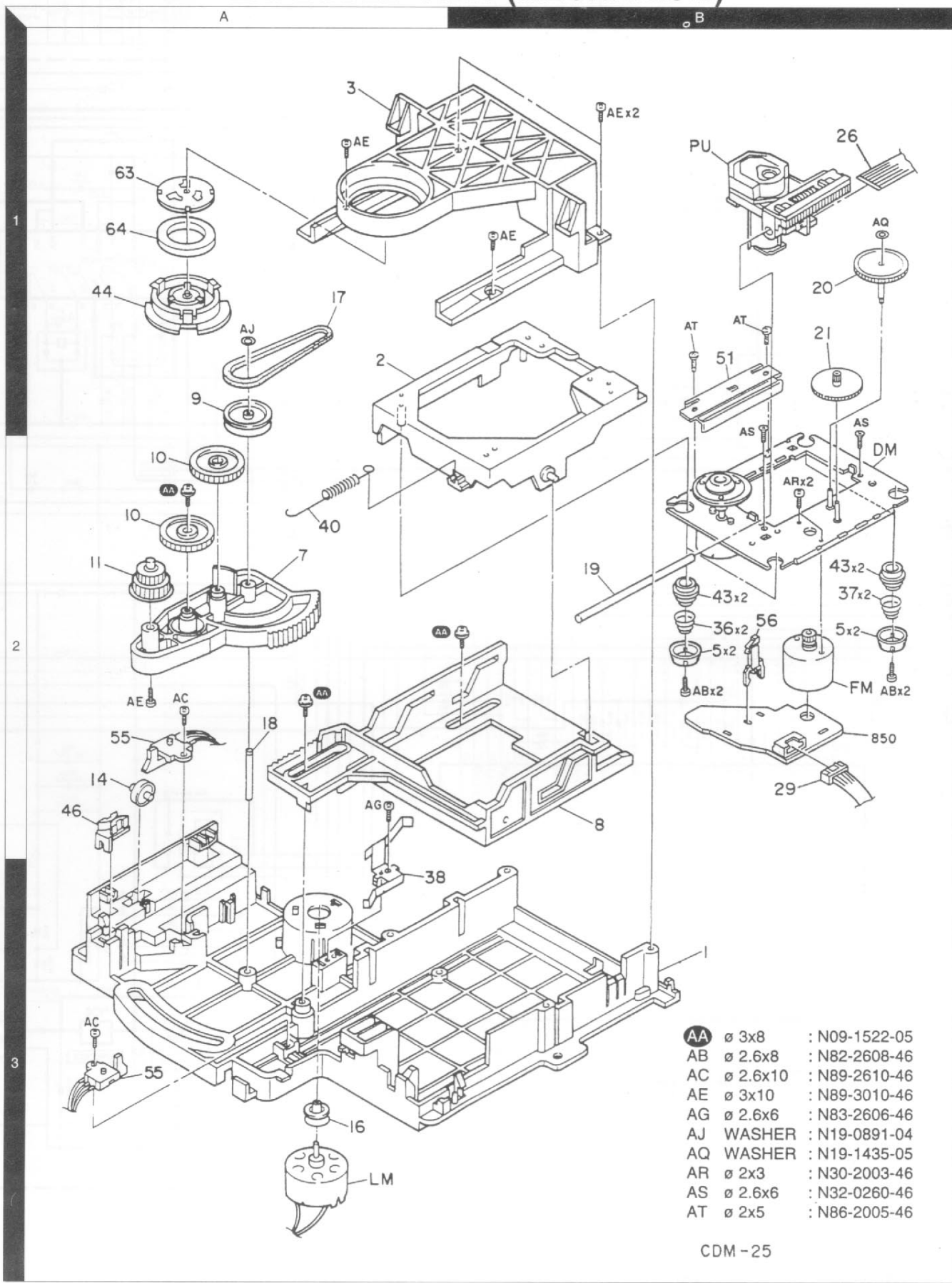

- AA  $\varnothing$  3x8 : N09-1522-05
- AB  $\varnothing$  2.6x8 : N82-2608-46
- AC  $\varnothing$  2.6x10 : N89-2610-46
- AE  $\varnothing$  3x10 : N89-3010-46
- AG  $\varnothing$  2.6x6 : N83-2606-46
- AJ WASHER : N19-0891-04
- AQ WASHER : N19-1435-05
- AR  $\varnothing$  2x3 : N30-2003-46
- AS  $\varnothing$  2.6x6 : N32-0260-46
- AT  $\varnothing$  2x5 : N86-2005-46

CDM - 25

# 103CD/104CD/1050CD/DP-R797/R3090/R4090

## SPECIFICATIONS

### [Format]

System ..... Compact disc digital audio system  
Laser ..... Semiconductor laser

### [D/A Convertors]

D/A Conversion ..... 1Bit  
Oversampling ..... 8 fs (352.8 kHz)

### [Audio]

Frequency response ..... 4 Hz ~ 20 kHz,  $\pm 0.5$  dB  
Signal to noise ratio ..... More than 95 dB  
Dynamic range ..... More than 95 dB  
Total harmonic distortion +noise  
..... Less than 0.008 % (at 1 kHz)  
Wow & flutter ..... Unmeasurable Limit  
Output level / impedance  
Fixed (DP-R3090) ..... 2.0 V / 0.8 k $\Omega$   
Variable (DP-R4090) ..... (max.) 2.0 V / 0.8 k $\Omega$   
Headphone output (max.)  
(DP-R4090 only) ..... 20 mW (32  $\Omega$ )

### [General]

Power consumption ..... 13 W  
Dimensions ..... W : 440 mm (17-5/16")  
H : 125 mm (4-15/16")  
D : 397 mm (15-5/8")  
Weight (Net) ..... 5.0 kg (11.0 lb)

### Note :

We follow a policy of continuous advancements in development. For this reason specifications may be changed without notice.

### Note:

Component and circuitry are subject to modification to insure best operation under differing local conditions. This manual is based on Europe (E) standard, and provides information on regional circuit modification through use of alternate schematic diagrams, and information on regional component variations through use of parts list.

## KENWOOD CORPORATION

14-6, Dogenzaka 1-chome, Shibuya-ku, Tokyo, 150 Japan

### KENWOOD SERVICE CORPORATION

P.O. BOX 22745, 2201 East Dominguez St., Long Beach, CA 90801-5745, U.S.A.

### KENWOOD ELECTRONICS CANADA INC.

6070 Kestrel Road, Mississauga, Ontario, Canada L5T 1S8

### KENWOOD ELECTRONICS LATIN AMERICA S.A.

P.O. BOX 55-2791, Piso 6 plaza Chase, Cl. 47 y Aquilino de la Guardia Panama, Republic de Panama

### KENWOOD ELECTRONICS U.K. LIMITED

KENWOOD House, Dwight Road, Watford, Herts., WD1 8EB., United Kingdom

### KENWOOD ELECTRONICS BENELUX N.V.

Meachelsesteenweg 418, B-1930 Zaventem, Belgium

### KENWOOD ELECTRONICS DEUTSCHLAND GMBH

Rembrücker Str. 15, 63150 Heusenstamm, Germany

### KENWOOD ELECTRONICS FRANCE S.A.

13 Boulevard Ney, 75018 Paris, France

### KENWOOD ELECTRONICS ITALIA S.p.A.

Via G. Sirtori, 7/9 20129, Milano, Italy

### KENWOOD IBÉRICA S.A.

Bolivia, 239-08020 Barcelona, Spain

### KENWOOD ELECTRONICS AUSTRALIA PTY. LTD.

(A.C.N. 001499 074)

P.O. Box 504, 8 Figtree Drive, Australia Centre, Homebush, N.S.W. 2140, Australia

### KENWOOD & LEE ELECTRONICS, LTD.

Unit 3712-3724, Level 37, Tower 1, Metroplaza, 223 Hing Fong Road, Kwai Fong N.T., Hong Kong

### KENWOOD ELECTRONICS GULF FZE

P.O. Box 61318, Jebel Ali, Dubai, U.A.E.

### KENWOOD ELECTRONICS SINGAPORE PTE LTD.

No. 1 Genting Lane #02-02, KENWOOD Building, Singapore, 349544

### KENWOOD ELECTRONICS (MALAYSIA) SDN BHD.

#4.01 Level 4, Wisma Academy Lot 4A, Jalan 19/1 46300 Petaling Jaya Selangor Darul Ehsan Malaysia