

STEREO INTEGRATED AMPLIFIER/TUNER R-SE7/SE-7(G) SERVICE MANUAL

(HM-701)

KENWOOD



KENW-04836

©1997-10/B51-5373-00 (K/K) 3191

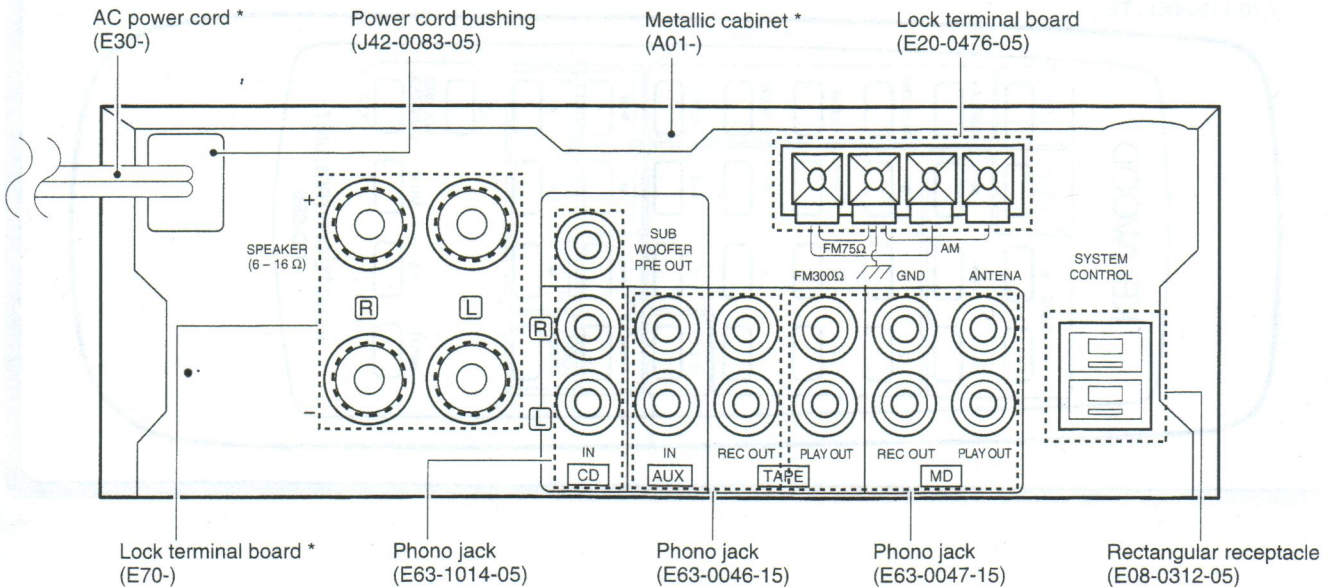
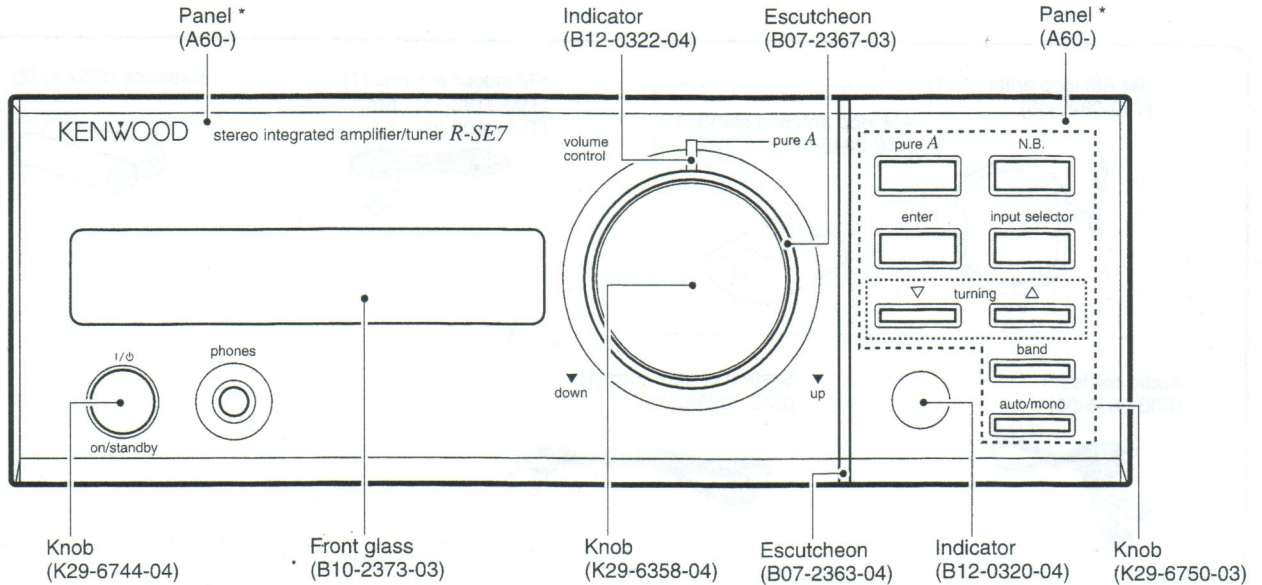

* Refer to parts list on page 25.

PRECAUTIONS FOR REPAIR

- For the SERIAL TEST CODE LIST of the circuit description, see Service manual (B51-5210-00) of R-SA7.
- No connection of ground line if disassemble the unit.
- Please connection the ground line on rear panel, PCBs, Chassis and some others.

R-SE7/SE-7(G)

PARTS LIST

* New Parts
Parts without **Parts No.** are not supplied.
Les articles non mentionnés dans le **Parts No.** ne sont pas fournis.
Teile ohne **Parts No.** werden nicht geliefert.

Ref. No	Add-ress	New Parts	Parts No.	Description	Desti-nation	Re-marks
637	1B		J19-3331-05	UNIT HOLDER		
638	1C		J42-0083-05	POWER CORD BUSHING		
639	1A		J19-3645-05	ANTENNA STAND		
			J61-0307-05	WIRE BAND		
640	2A		K29-6358-04	VR		
641	2A		K29-6744-04	POWER		
642	3B		K29-6750-03	KNOB		
645	2C		L07-2386-05	POWER TRANSFORMER		T1 T2E
645	2C		L07-2415-05	POWER TRANSFORMER		M
645	2C		L07-2493-05	POWER TRANSFORMER		K
650	1A		T90-0182-15	LEAD WIRE ANTENNA		KM
650	1A		T90-0806-05	LEAD WIRE ANTENNA		ET1 T2
651	1A		T90-0820-05	LOOP ANTENNA		
TUNER UNIT (X05-4600-XX)						
C1	2		CK73FB1H103K	CHIP C		
C3			CK73FCH1H040C	CHIP C		
C4			CK73FB1H103K	CHIP C		
C5			CK73FB1H102K	CHIP C		
C8			CK73FB1H103K	CHIP C		
C9			CE04KW1C100M	ELECTRO		16WV
C10			CK73FB1H473K	CHIP C		0.047UF
C11			CE04KW1H010M	ELECTRO		50WV
C12			CE04KW1H2R2M	ELECTRO		2.2UF
C13			CK73FB1H102K	CHIP C		1000PF
C14			CE04KW1H010M	ELECTRO		1.0UF
C15			CC73FCH1H220J	CHIP C		22PF
C16			CE04KW1C100M	ELECTRO		1.0UF
C17			CK73FB1H562K	CHIP C		5600PF
C18			CK73FB1H102K	CHIP C		1000PF
C19			CE04HW1E4R7M	NP-ELEC		25WV
C20			CK73FB1E104K	CHIP C		0.10UF
C21	22		CQ93FMG1H113J	MYLAR		0.011UF
C21	22		CQ93FMG1H163J	MYLAR		0.016UF
C23			CE04KW1H010M	ELECTRO		1.0UF
C25			CE04KW1C100M	ELECTRO		16WV
C26			CE04KW1C470M	ELECTRO		16WV
C27			CE04KW1H010M	ELECTRO		1.0UF
C28			CQ93FMG1H223J	MYLAR		0.022UF
C29			CE04KW1H2R2M	ELECTRO		50WV
C30			CE04KW1C101M	ELECTRO		16WV
C31			CE04KW1A470M	ELECTRO		10WV
C32			CK73FB1H103K	CHIP C		0.010UF
C33			CK73FSL1H101J	CHIP C		1000PF
C34	35		CK73FB1H102K	CHIP C		1000PF
C36			CC73FCH1H270J	CHIP C		27PF
C37			CC73FCH1H220J	CHIP C		22PF
C38			CK73FB1H471K	CHIP C		470PF
C38			CK73FB1H470J	CHIP C		47PF
C57	60		CE04KW1C100M	ELECTRO		10UF
C63			CC73FCH1H220J	CHIP C		22PF
CN1			E40-4609-05	PIN ASSY		
J1			E20-0476-05	LOCK TERMINAL BOARD(4P)		

A

* New Parts
Parts without **Parts No.** are not supplied.
Les articles non mentionnés dans le **Parts No.** ne sont pas fournis.
Teile ohne **Parts No.** werden nicht geliefert.

Ref. No	Add-ress	New Parts	Parts No.	Description	Desti-nation	Re-marks
R-SE7						
601	1B		A01-3471-11	METALLIC CABINET	MET1 T2	
603	1B	*	A01-3541-01	METALLIC CABINET	K	
604	2B		A22-1783-11	SUB PANEL	M	
604	2A	*	A60-1207-03	PANEL	T1 T2E	
604	2A	*	A60-1209-03	PANEL		
604	2A	*	A60-1347-03	PANEL	K	
605	2A		A60-1208-03	PANEL	MET1 K	
605	2A		A60-1302-03	PANEL	T2	
606	1A		A70-1154-05	REMOTE CONTROLLER ASSY(RC-SE9)	MK	
606	1A		A70-1155-05	REMOTE CONTROL ASSY RC-SE9(E)	T1 T2E	
607	1A		A09-0374-08	BATTERY COVER		
610	2A		B07-2363-04	ESCUTCHEON		
611	2A		B07-2367-03	ESCUTCHEON	VR	
612	2A		B10-2373-03	FRONT GLASS	PURE A	
613	2A		B12-0320-04	INDICATOR		
614	2A		B12-0322-04	INDICATOR		
			B46-0197-00	QUESTIONNAIRE CARD		
			B46-0310-03	WARRANTY CARD	T1 T2E	
			B46-0328-03	WARRANTY CARD	K	
		*	B58-0965-13	CAUTION CARD (PL)	T1 T2	
		*	B58-0966-13	CAUTION CARD (PL)	ME	
		*	B58-1562-04	CAUTION CARD		
		*	B60-3330-00	INSTRUCTION MANUAL(ENG)	T1 T2	
		*	B60-3331-00	INSTRUCTION MANUAL(FRN)	E	
		*	B60-3332-00	INSTRUCTION MANUAL(GRM)	E	
		*	B60-3333-00	INSTRUCTION MANUAL(NTH)	E	
		*	B60-3334-00	INSTRUCTION MANUAL(ITA)	E	
		*	B60-3335-00	INSTRUCTION MANUAL(JPN)	E	
		*	B60-3412-00	INSTRUCTION MANUAL(TWN)	M	
		*	B60-3668-00	INSTRUCTION MANUAL(ENG)	K	
619	1A		E03-0115-05	AC PLUG ADAPTER		
620	1A		E30-0615-05	AUDIO CORD	M	
621	1C		E30-2592-15	AC POWER CORD	ME	
621	1C		E30-2650-05	AC POWER CORD	K	
621	1C		E30-2721-05	AC POWER CORD	T1 T2	
622	1A		E30-2628-05	CORD WITH CONNECTOR		
623	1B		E35-1972-05	FLAT CABLE 19P	T1 T2E	
623	1B		E35-2007-05	FLAT CABLE	MK	
624	2B		E35-1973-05	FLAT CABLE 15P		
630	2B		G11-2342-04	CUSHION		
			H10-7363-02	POLYSTYRENE FOAMED FIXTURE		
			H10-7364-02	POLYSTYRENE FOAMED FIXTURE		
			H12-2356-04	PACKING FIXTURE	T1 T2	
			H25-1579-04	PROTECTION BAG	MEK	
			H25-1581-04	PROTECTION BAG	T1 T2	
			H25-1595-04	PROTECTION BAG		
			H50-2508-04	ITEM CARTON CASE	MEK	
			H50-2509-04	ITEM CARTON CASE	T1	
			H50-2681-04	ITEM CARTON CASE	T2	
635	2C		J02-0370-05	FOOT		
636	2B		J19-3323-05	UNIT HOLDER		

A

L : Scandinavia
Y : PX(Far East, Hawaii)
V : AAFES(Europe)

K : USA
T : Europe
X : Australia

P : Canada
E : Europe
M : Other Areas

R : Mexico
G : Germany

T1 : GRAY
T2 : GOLD

Δ indicates safety critical components.

R-SE7/SE-7(G)

EXPLODED VIEW (UNIT)

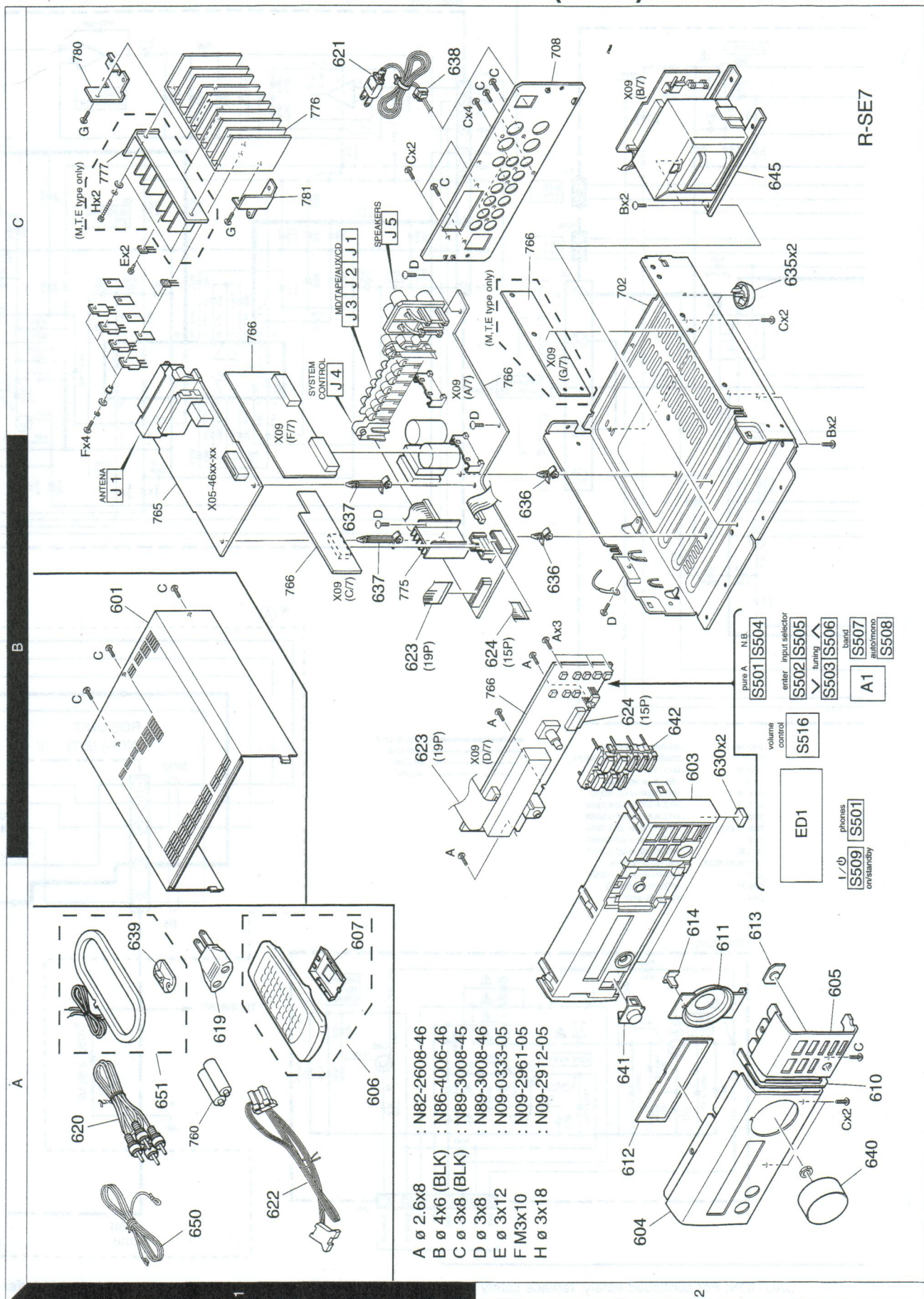

DISTINATION		UNIT NO	C51, 52	C53, 54	E/7	C61-64	R49, 50	R159	F1	J5	WH4	W2, 3	Ⓐ	Ⓑ	C526, 528 529	D518	D519	IC11	C41,42	R700	P1	
GENERAL MARKET	M	0-21	0.047μ	NO	NO	NO	100	YES	800mA L 250V	E70-0061-05	NO	YES	NO	NO	NO	YES	NO	UPD78045 FGF057	YES		NO	NO
UK	T	2-71	0.1μ	YES	YES	YES	1K	NO	400mA L 250V		NO	NO	YES	YES	NO	NO	YES		NO		NO	NO
EUROPE	E	2-71	0.1μ	YES	YES	YES	1K	NO	400mA L 250V		NO	NO	YES	YES	NO	NO	YES		NO		NO	NO
USA	K	0-11	0.047μ	NO	NO	NO	100	YES	1A 125V	E70-0034-05	YES	YES	NO	NO	NO	YES	NO	UPD78045FGF059	YES		YES	YES

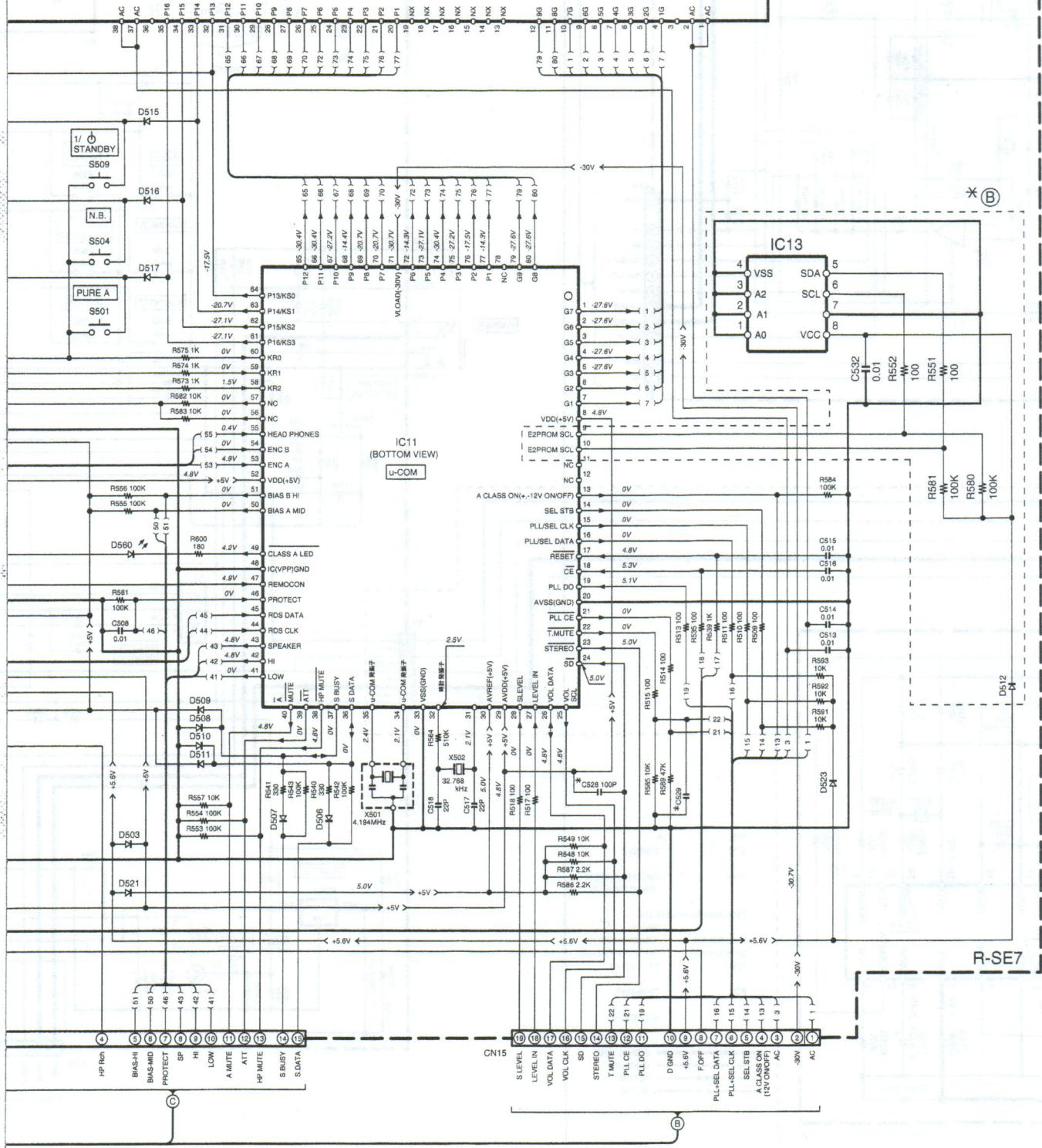
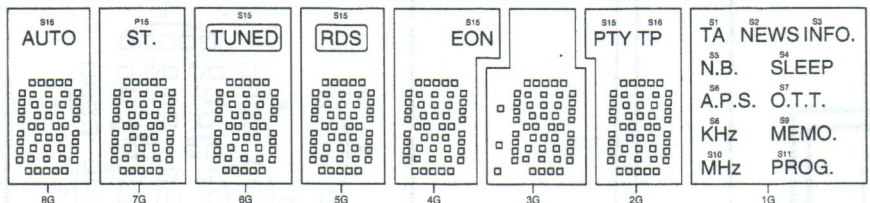

R-SE7/SE-7(G)
Y05-3480-11
KENWOOD

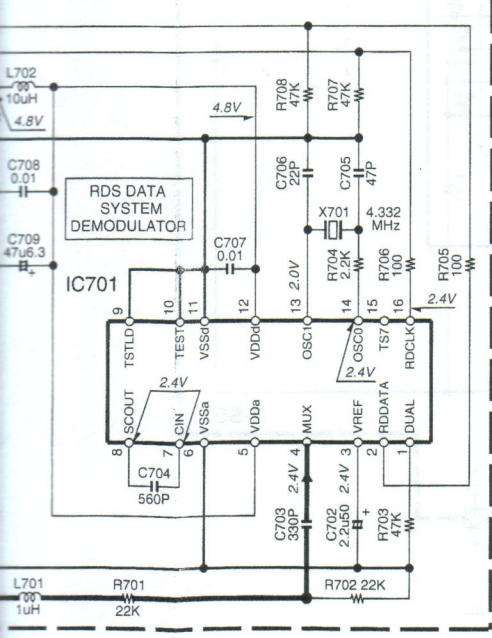
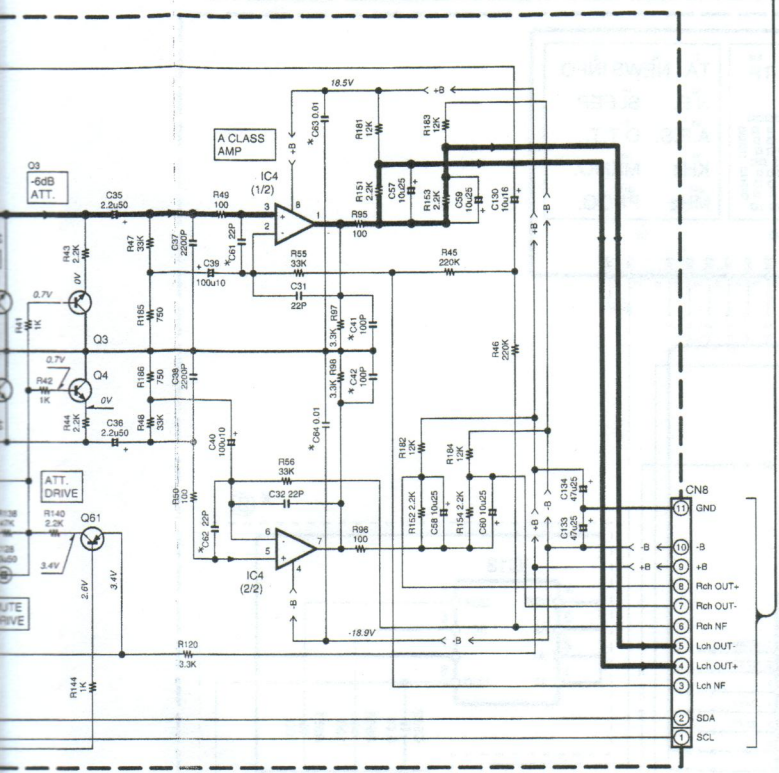

- IC11 : *
 - IC12 : S-806D-Z
 - Q504 : 2SC4116(Y,GR) or 2SC4177(L5,L6)
 - D502,504-511,513,514,523 : MA111
 - D503,521,522 : 1SS133 or HSS104
 - D515-519,520 : 1SS131 or HSS104A
 - D560 : B90-2521-05
 - ED1 : FIP9GM6R
 - A1 : W02-2561-05
- SIGNAL LINE
 ——— GND LINE
 ——— +B LINE
 ——— -B LINE

DISPLAY UNIT
(X09-469x-xx) (D/7)

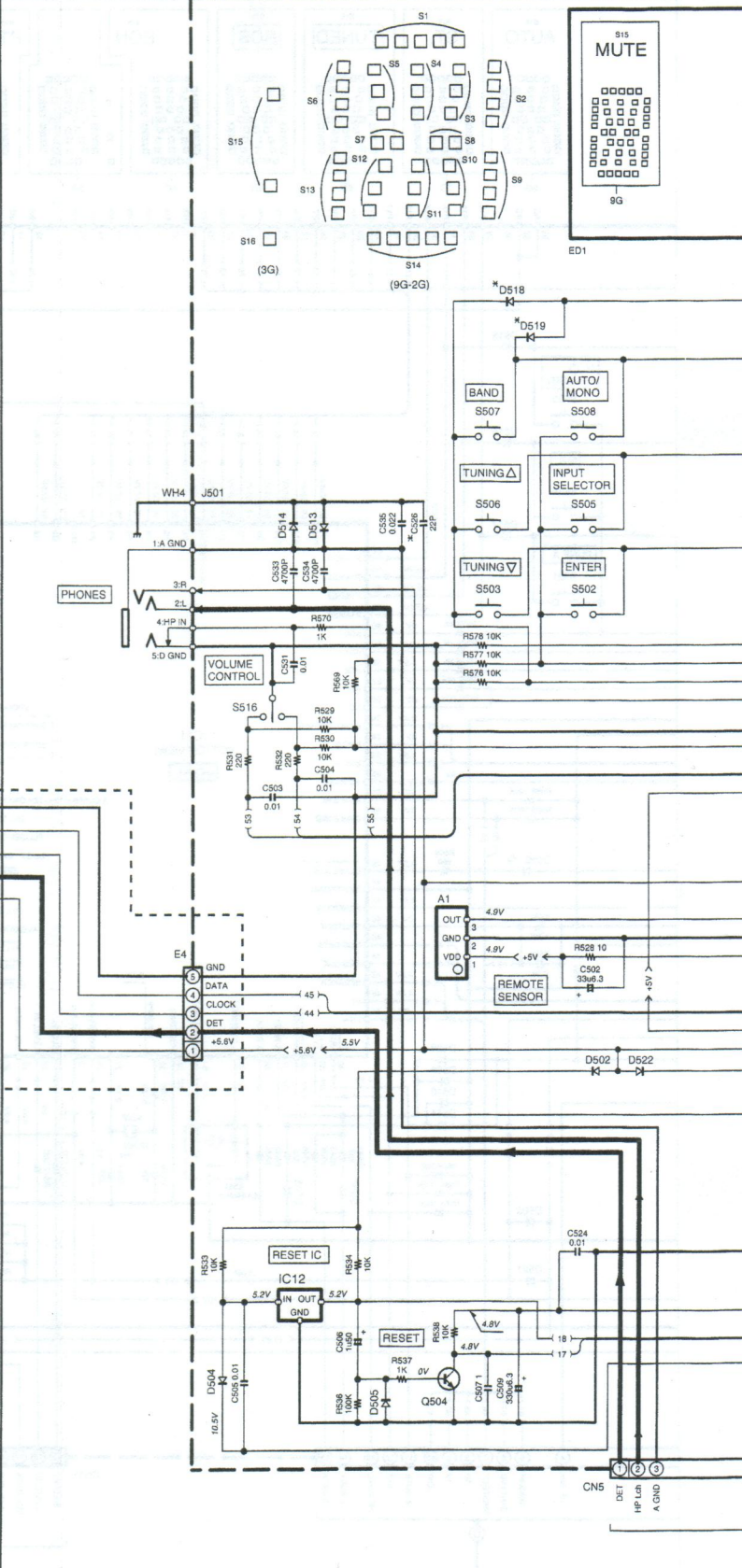

parts list). Δ indicates safety critical of electric shock, leakage-current or damage is returned to the customer.

The DC voltage is an actual reading measured with a high impedance test voltmeter with a cassette loaded at playback mode. The measurement value may vary depending on the measuring instruments used or on the product. Bias circuit DC voltage is measured while in the record mode.

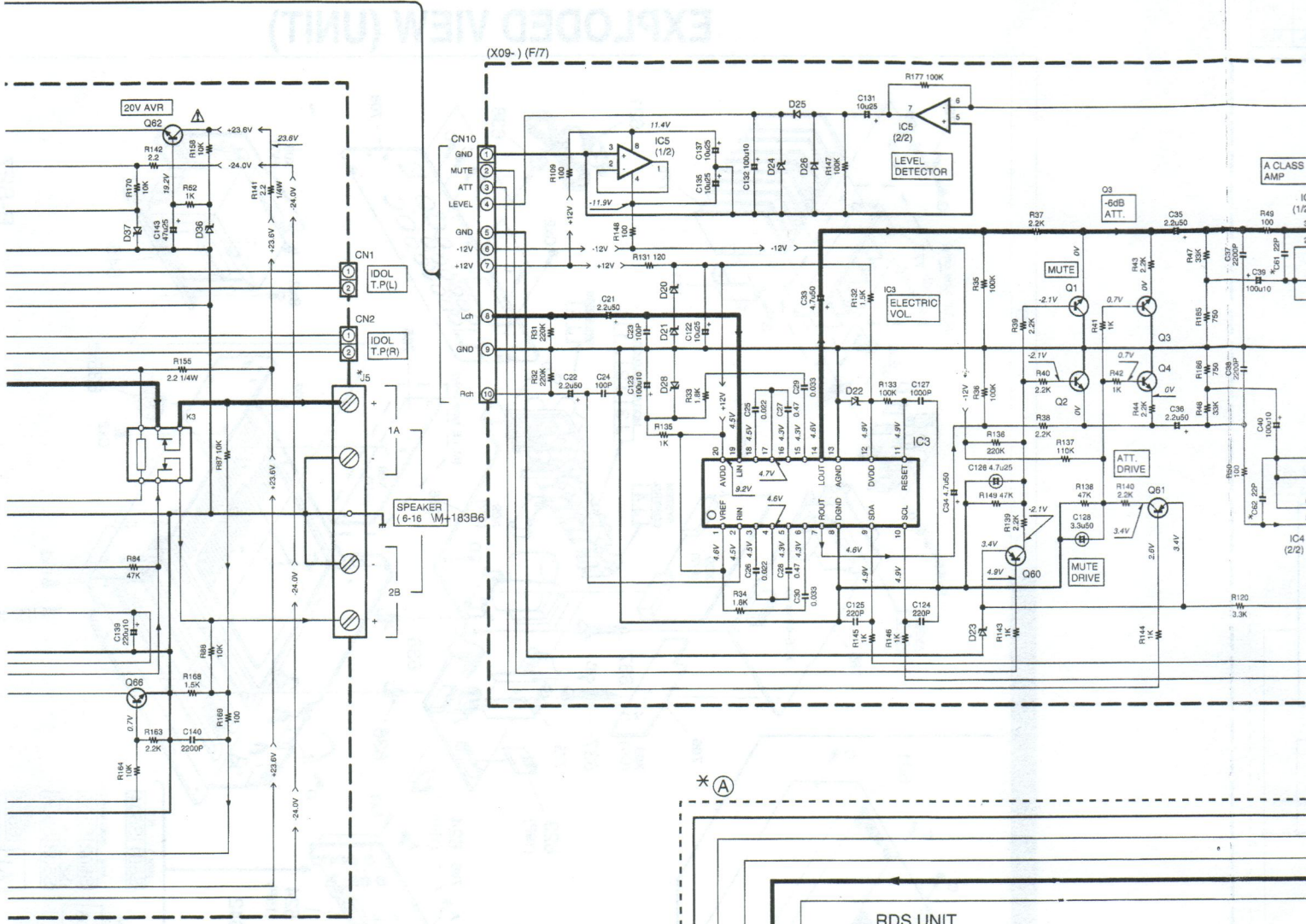

- D10-14 : S5688B or 1SR139-400
- D6 : D3SBA20F03 or RBV-402LFA
- D6,7,31 : MA111
- D8,9 : 1SS131 or HSS104A
- D15,16 : MTZJ16(B) or UZ-16B8B
- D17,19 : MTZJ6.2(B) or UZ-6.2B8B
- D18 : MTZJ6.9(B) or UZ-6.8B8B
- D20,21,24,28,33 : MTZJ4.7(B) or UZ-4.7B8B
- D22 : MTZJ5.1(B) or UZ-5.1B8B
- D23,39 : MTZJ3.9(B) or UZ-3.9B8B
- D25,26,29,30,32 : 1SS133 or HSS104
- D27 : MTZJ11(B) or UZ-11B8B
- D36,37 : MTZJ20 or UZ-20BS
- D40 : KBP02ML-6127

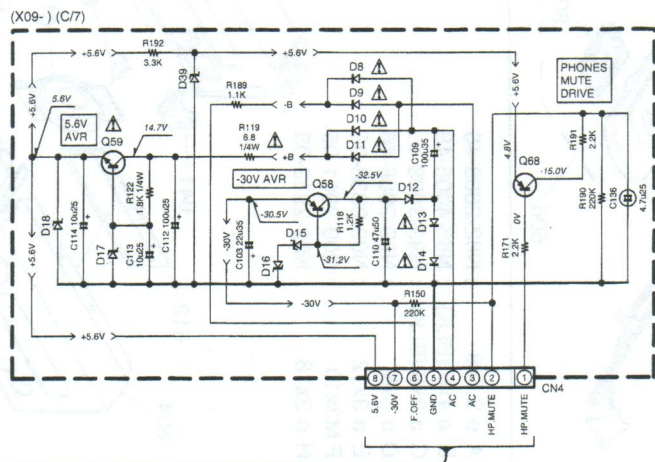
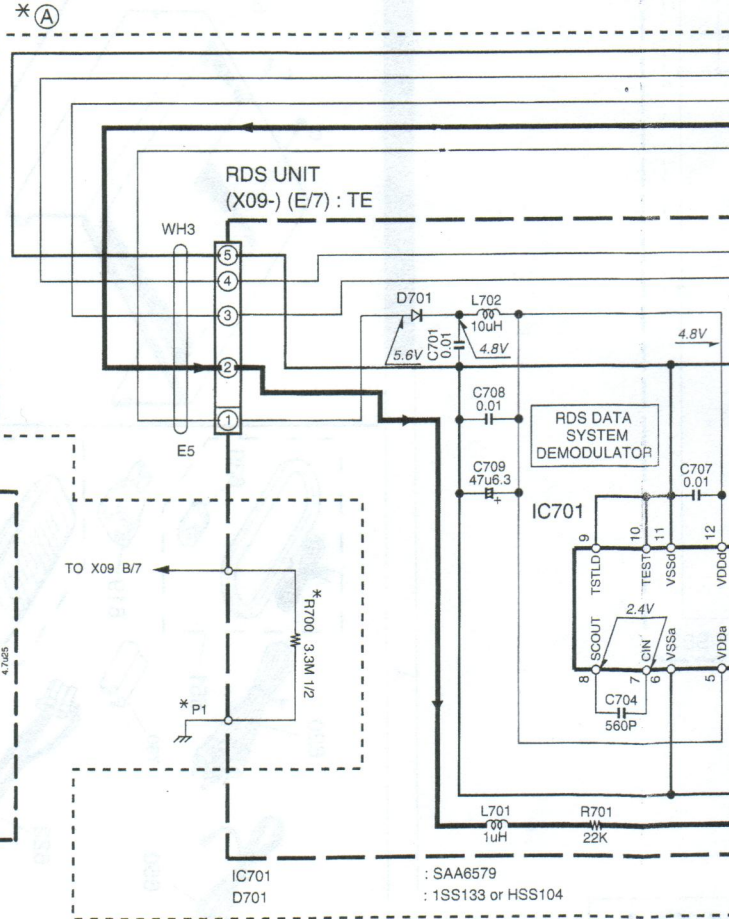
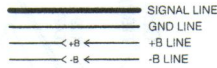

CAUTION: For continued safety, replace safety critical components only with manufacturer's recommended parts (refer to parts list). Δ indicates safety critical components. For continued protection against risk of fire, replace only with same type and rating fuse(s). To reduce the risk of electric shock, leakage-current and resistance measurements shall be carried out (exposed parts are acceptably insulated from the supply circuit) before the appliance is returned to the customer.

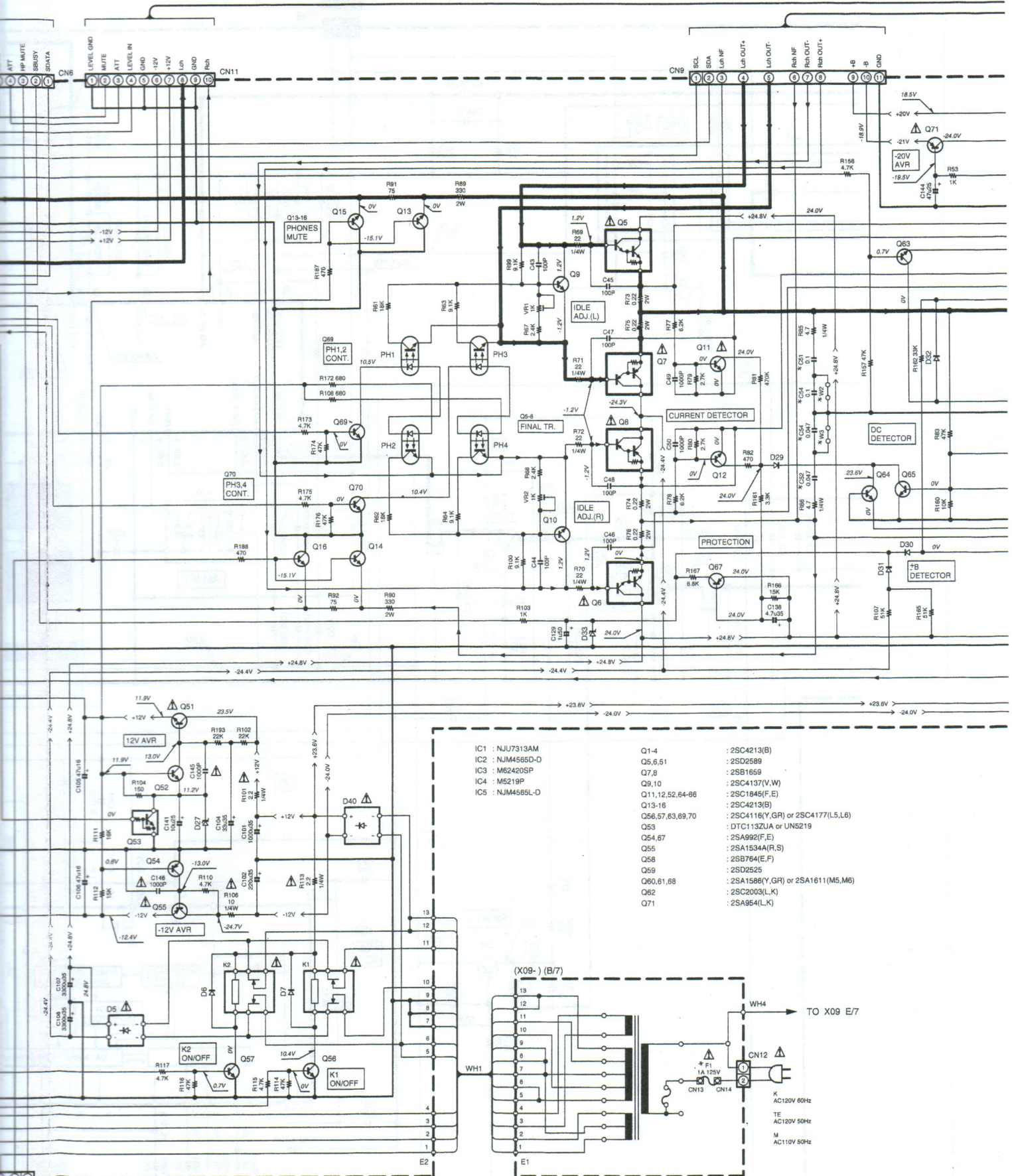

- | | |
|------------------|---|
| IC1 : NJU7313AM | Q1-4 : 2SC4213(B) |
| IC2 : NJM4565D | Q5,6,51 : 2SD2589 |
| IC3 : M62420SP | Q7,8 : 2SB1659 |
| IC4 : M5219P | Q9,10 : 2SC4137(V,W) |
| IC5 : NJM4565L-D | Q11,12,52,64-66 : 2SC1845(F,E) |
| | Q13-16 : 2SC4213(B) |
| | Q56,57,63,69,70 : 2SC4116(Y,GR) or 2SC4177(L5,L6) |
| | Q63 : DTC113ZUA or UN5219 |
| | Q64,67 : 2SA992(F,E) |
| | Q65 : 2SA1534A(R,S) |
| | Q68 : 2SB784(E,F) |
| | Q69 : 2SD2525 |
| | Q60,61,68 : 2SA1586(Y,GR) or 2SA1611(M5,M6) |
| | Q62 : 2SC2003(L,K) |
| | Q71 : 2SA954(L,K) |

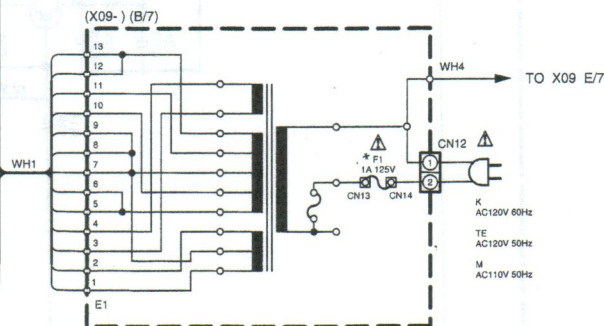

AUDIO UNIT
(X09-4690-00) (A7)

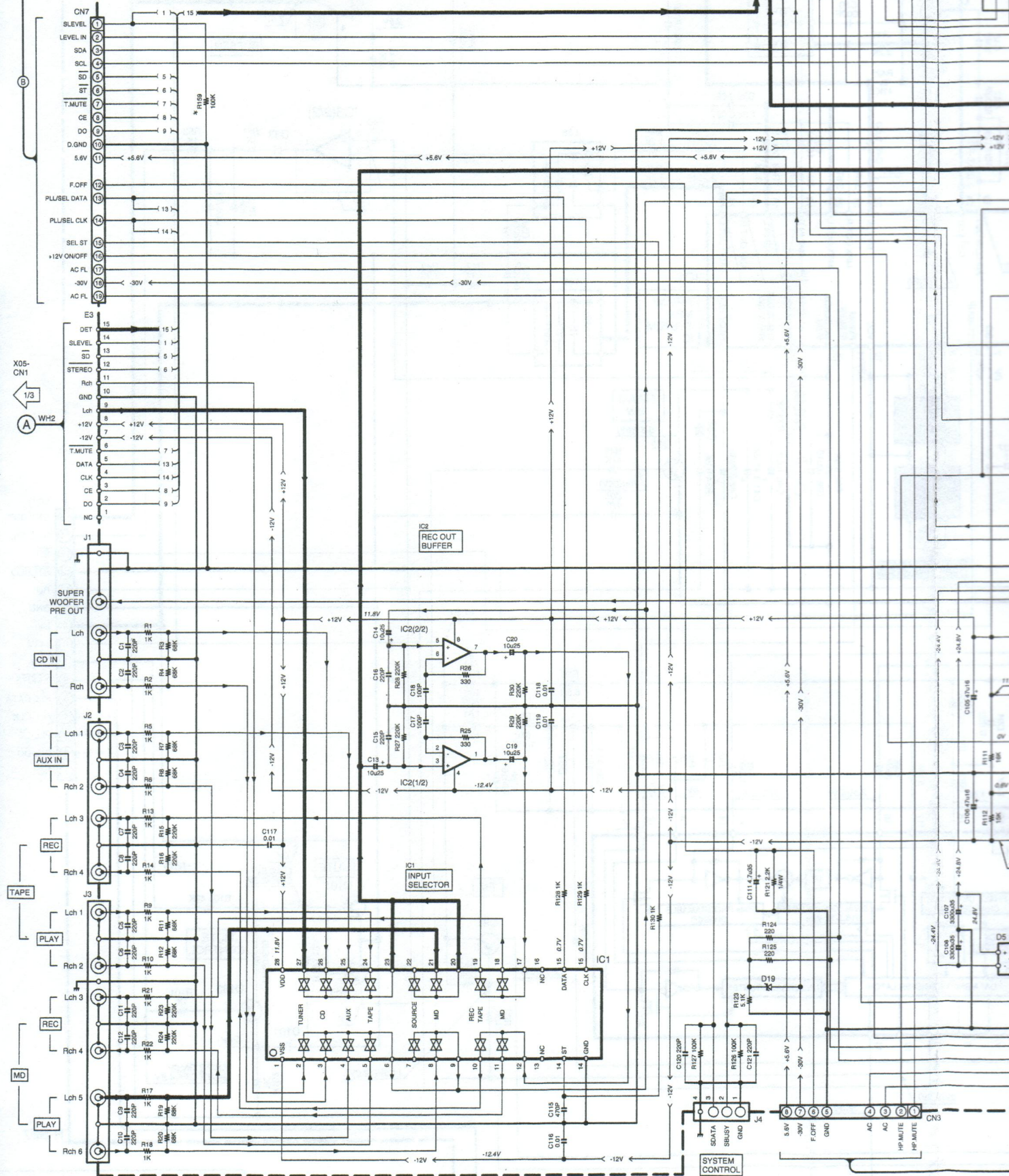

1
2
3
4
5
6
7

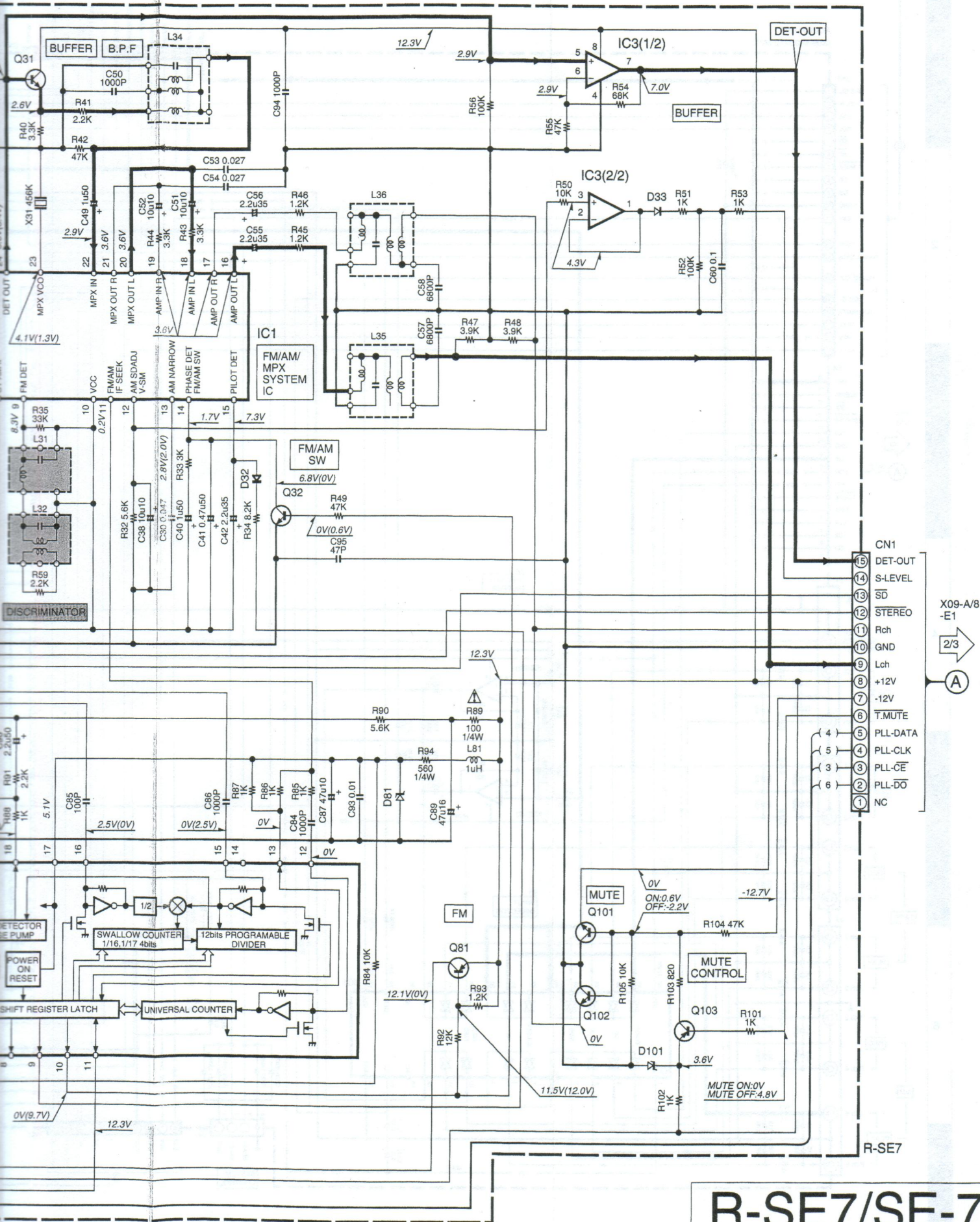

R-SE7/SE-7(G)

Y05-3480-11

KENWOOD

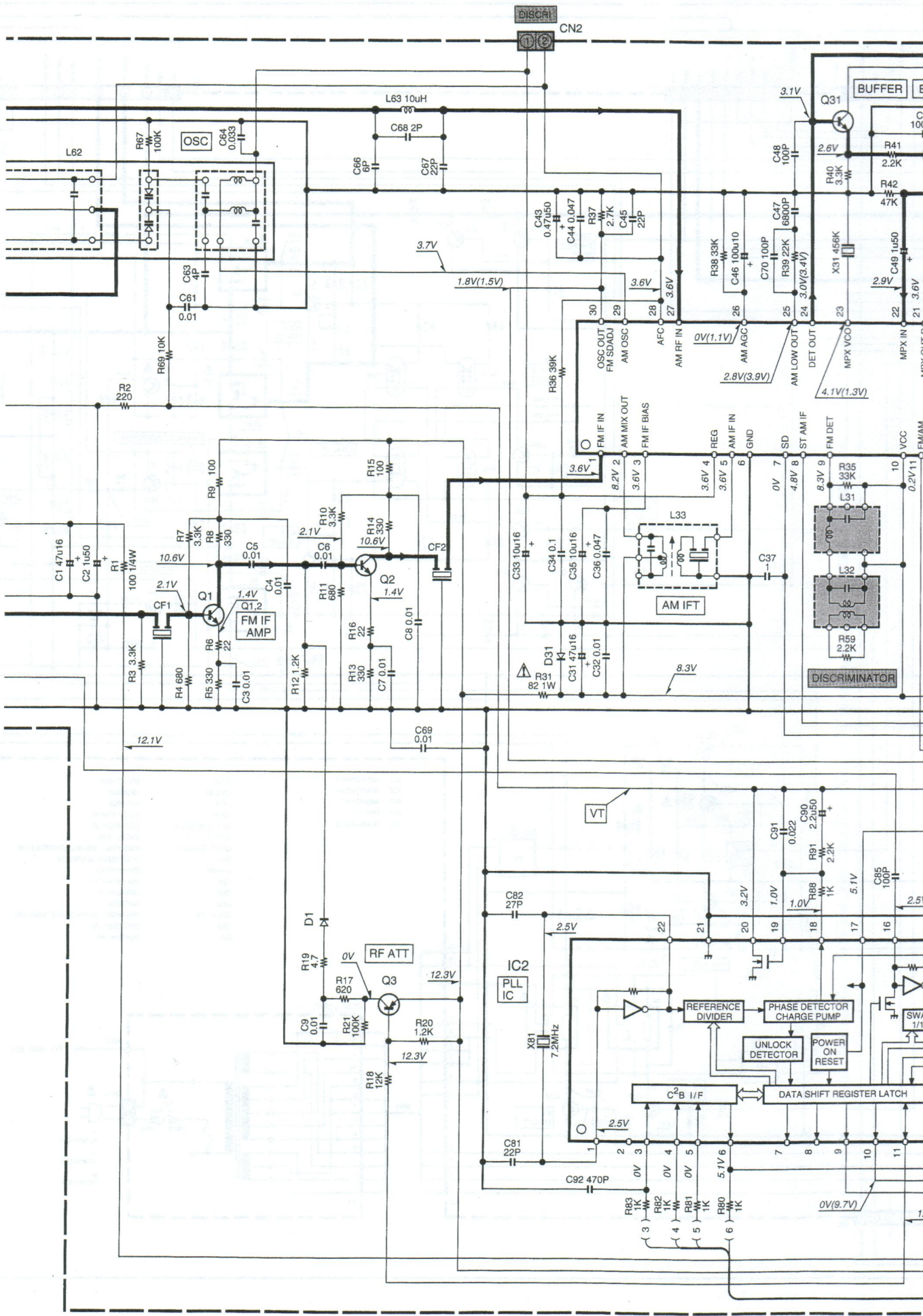

TUNER UNIT (X05-4622-71) : TE

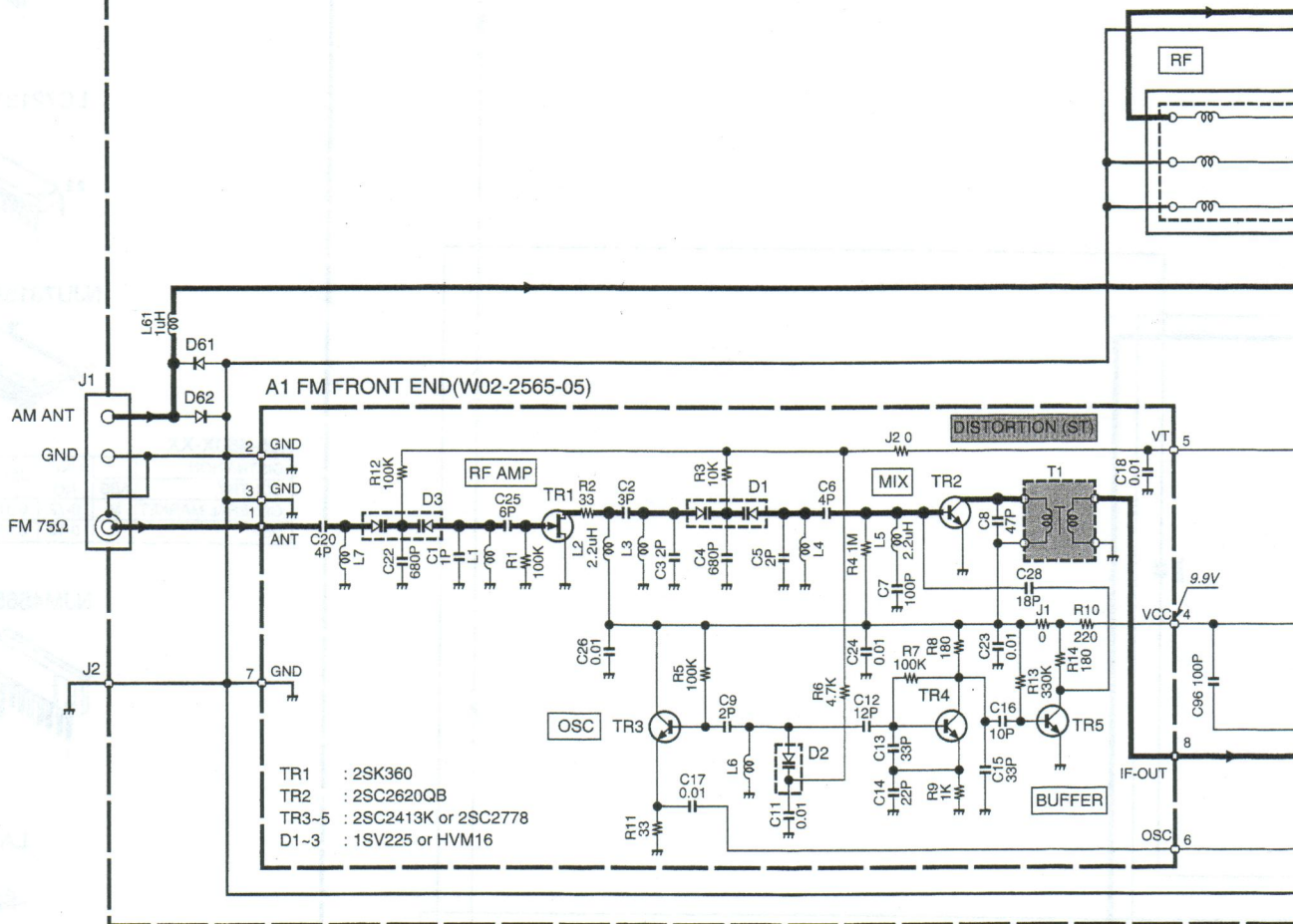

- TR1 : 2SK360
- TR2 : 2SC2620QB
- TR3-5 : 2SC2413K or 2SC2778
- D1-3 : 1SV225 or HVM16

- IC1 : LA1836
- IC2 : LC72131
- IC3 : M5223FP

VT VOLTAGE
 LF: LOW FREQUENCY
 HF: HIGH FREQUENCY

BAND	FREQ.	VOLTAGE(VT)
FM	LF	2.1V
	HF	7.5V
AM	LF	1.1V
	HF	4.6V

- Q1,2 : 2SC2714(R,O)
- Q3,81,103 : 2SA1586(Y,GR) or 2SA1611(M5,M6)
- Q31,32 : 2SC4116(Y,GR) or 2SC4177(L5,L6)
- Q101,102 : 2SD1757K

- D1,33,61,62 : 1SS133 or HSS104
- D31 : MTZJ8.2(B) or UZ-8.2BSB
- D32 : MA111
- D81 : MTZJ5.1(B) or UZ-5.1BSB
- D101 : MTZJ3.3(B) or UZ-3.3BSB

CAUTION: For continued safety, replace safety critical components only with manufacturer's recommended parts (refer to parts list). Δ indicates safety critical components. For continued protection against risk of fire, replace only with same type and rating fuse(s). To reduce the risk of electric shock, leakage-current or resistance measurements shall be carried out (exposed parts are acceptably insulated from the supply circuit) before the appliance is returned to the customer.



The DC voltage is an actual reading measured with a high impedance type voltmeter as the AM/FM signal generator is specified to the conditions as shown in the list below. The measurement value may vary depending on the measuring instruments used or on the product. The value shown in () is actual reading measured in the AM mode.

MODE	CARRIER	MODULATION		ANT INPUT
		FREQUENCY	DEVIATION	
FM	98MHz	1kHz	STEREO 67.5kHz 7.5kHz(Pilot)	60dB
AM	1000(999)kHz	400Hz	MONO 30% MOD	60dB

K

L

M

N

O

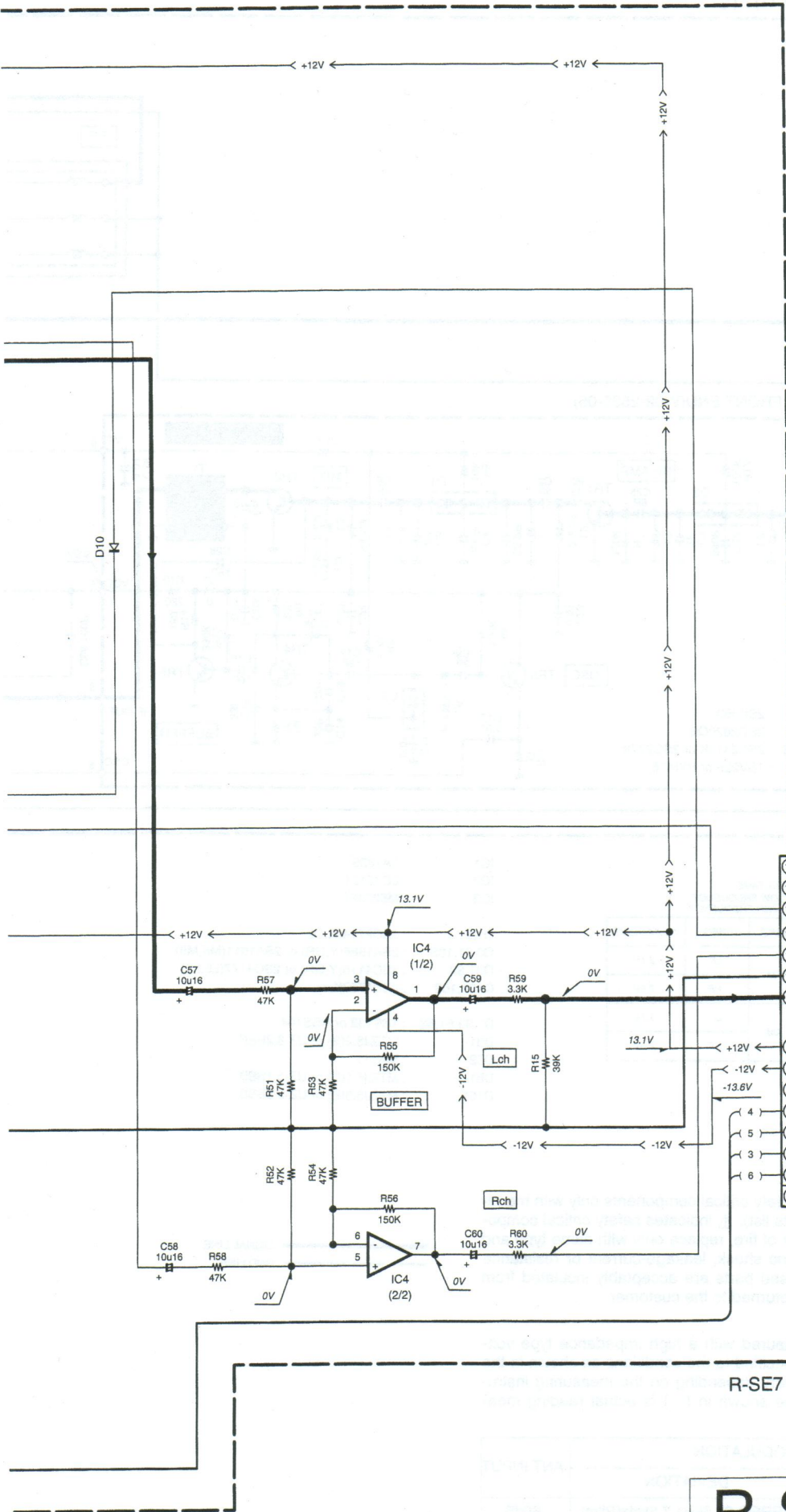

LA1836

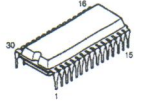

LC72131

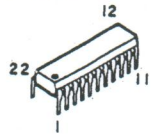

NJU7313AM

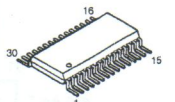

X05-460X-XX

DISTINATION	CONTRY	ABB	UNIT NO	C21, 22
GENERAL MARKET	USA	M	0-72	0.011μ
		K	0-12	0.016μ

NJM4565L-D

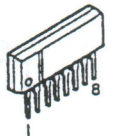

LA1832

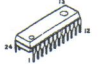

X24C04S

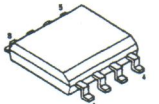

- 15 DET
- 14 S-LEVEL
- 13 SD
- 12 STEREO
- 11 Rch
- 10 GND
- 9 Lch
- 8 +12V
- 7 -12V
- 6 T.MUTE
- 5 PLLDATA
- 4 PLLCLK
- 3 PLLCE
- 2 PLLDO
- 1 CH SPACE

X09-A/B

E3

2/3

A

R-SE7

R-SE7/SE-7(G)

Y05-3480-11

KENWOOD

F

G

H

I

J

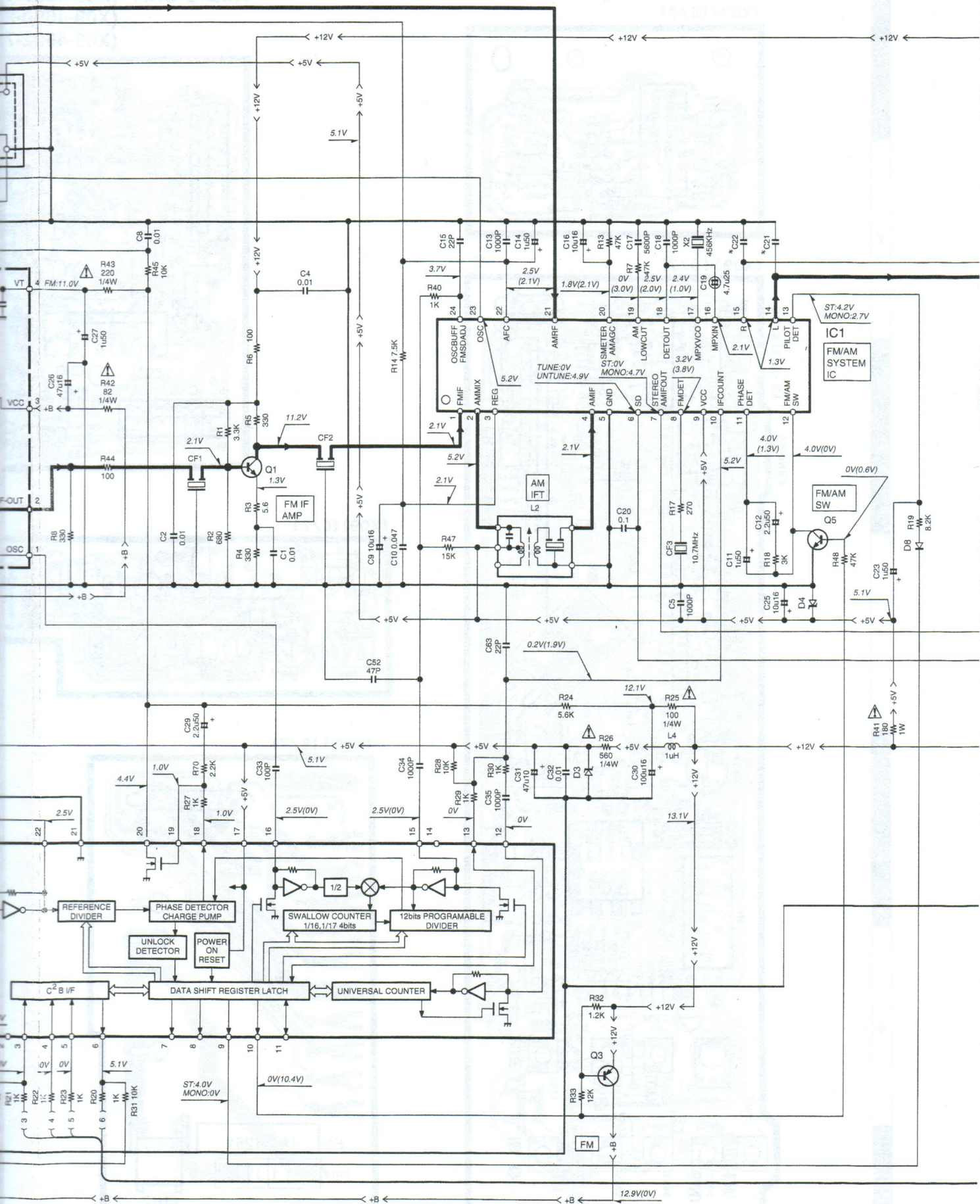

TUNER UNIT (X05-4600-xx)

2SA1534A
2SA954
2SA992
2SB764
2SC1845
2SC2003

2SC4137

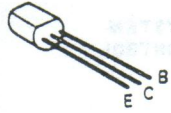

2SB1659
2SD2589

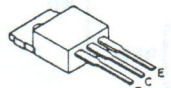

UN5219
2SA1586
2SC2714
2SC4116

2SD1757K

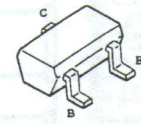

NJM4565D-D

M62420SP

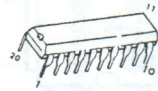
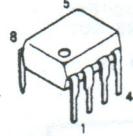

SAA6579

M5219P

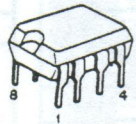
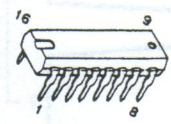

NJM4565M

M5223FP

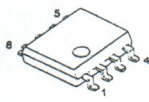

- IC1 : LA1832
- IC2 : LC72131
- IC4 : NJM4565M
- Q1 : 2SC2714(R,O)
- Q3 : 2SA1586(Y,GR) or 2SA1611(M5,M6)
- Q5 : 2SC4116(Y,GR) or 2SC4177(C5,C6)
- D1,2,8 : 1SS133 or HSS104
- D3,4 : MTZJ5.1(B) or UZ-5.1BSB
- D10 : MA111

VT VOLTAGE
LF:LOW FREQUENCY
HF:HIGH FREQUENCY

BAND	FREQ.	VT VOLTAGE
FM	LF	1.7V
	HF	4.1V
AM	LF	1.2V
	HF	4.7V

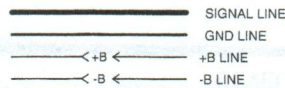

CAUTION: For continued safety, replace safety critical components only with manufacturer's recommended parts (refer to parts list). Δ indicates safety critical components. For continued protection against risk of fire, replace only with same type and rating fuse(s). To reduce the risk of electric shock, leakage-current or resistance measurements shall be carried out (exposed parts are acceptably insulated from the supply circuit) before the appliance is returned to the customer.

The DC voltage is an actual reading measured with a high impedance type voltmeter as the AM/FM signal generator is specified to the conditions as shown in the list below. The measurement value may vary depending on the measuring instruments used or on the product. The value shown in () is actual reading measured in the AM mode.

MODE	CARRIER	MODULATION		ANT INPUT
		FREQUENCY	DEVIATION	
FM	98MHz	1kHz	STEREO 67.5kHz 7.5kHz(Pilot)	60dB
AM	1000(999)kHz	400Hz	MONO 30% MOD	60dB

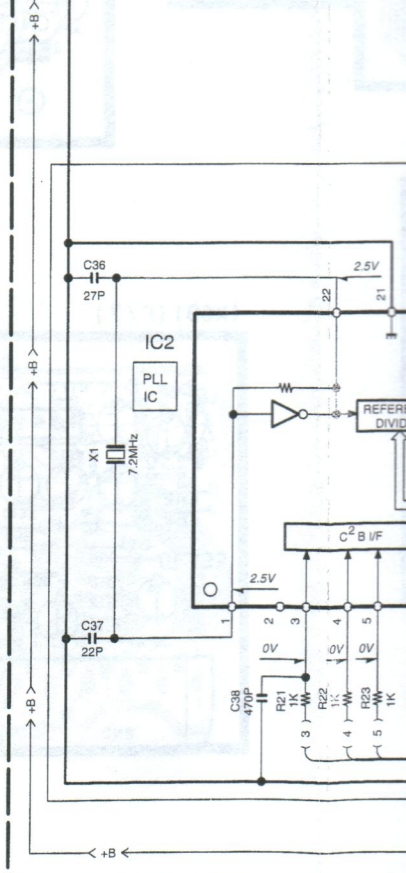
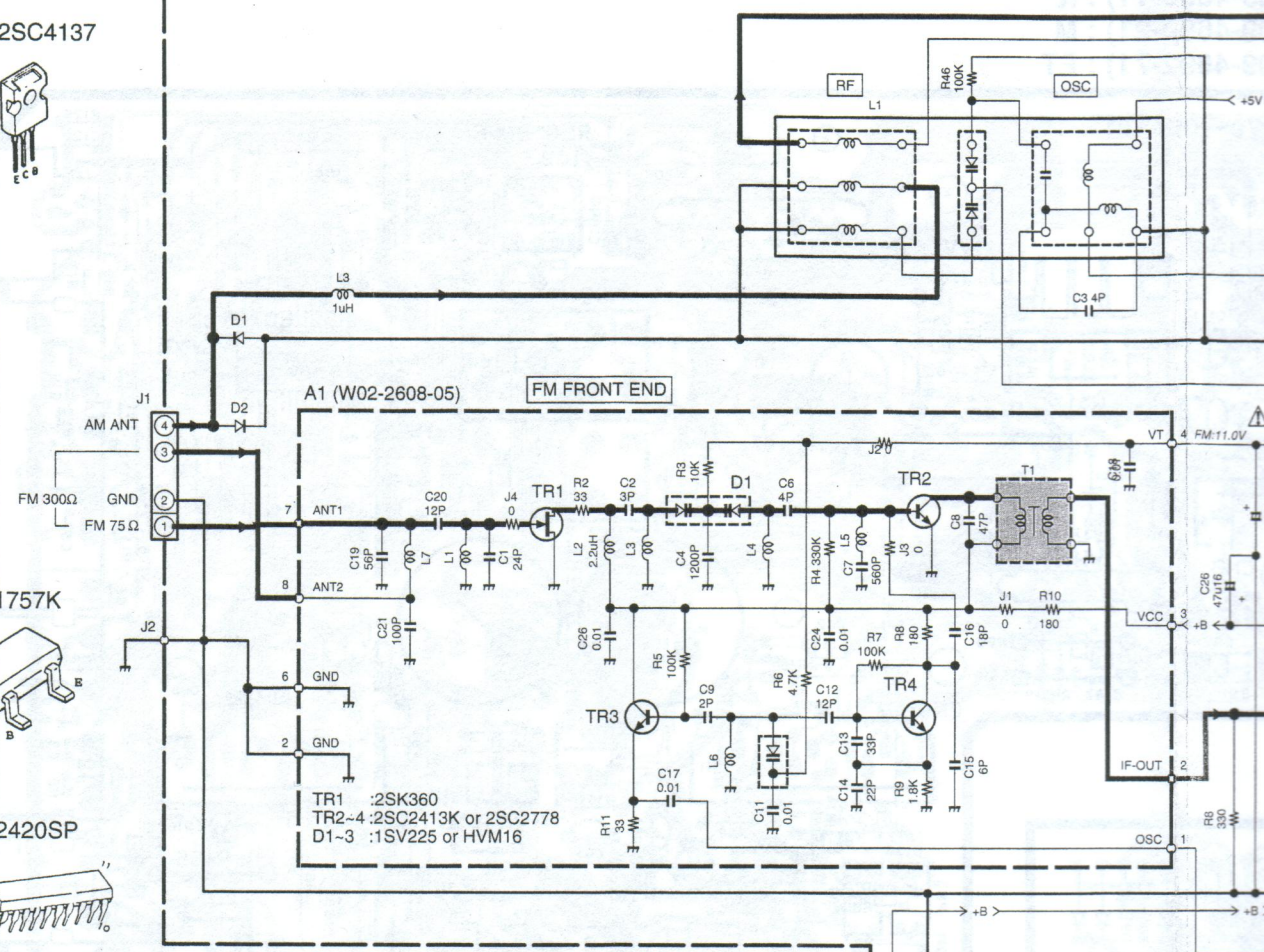

1
2
3
4
5
6
7

PC BOARD(Component side view)

TUNER UNIT (X05-4600-12) : K
 (X05-4600-72) : M

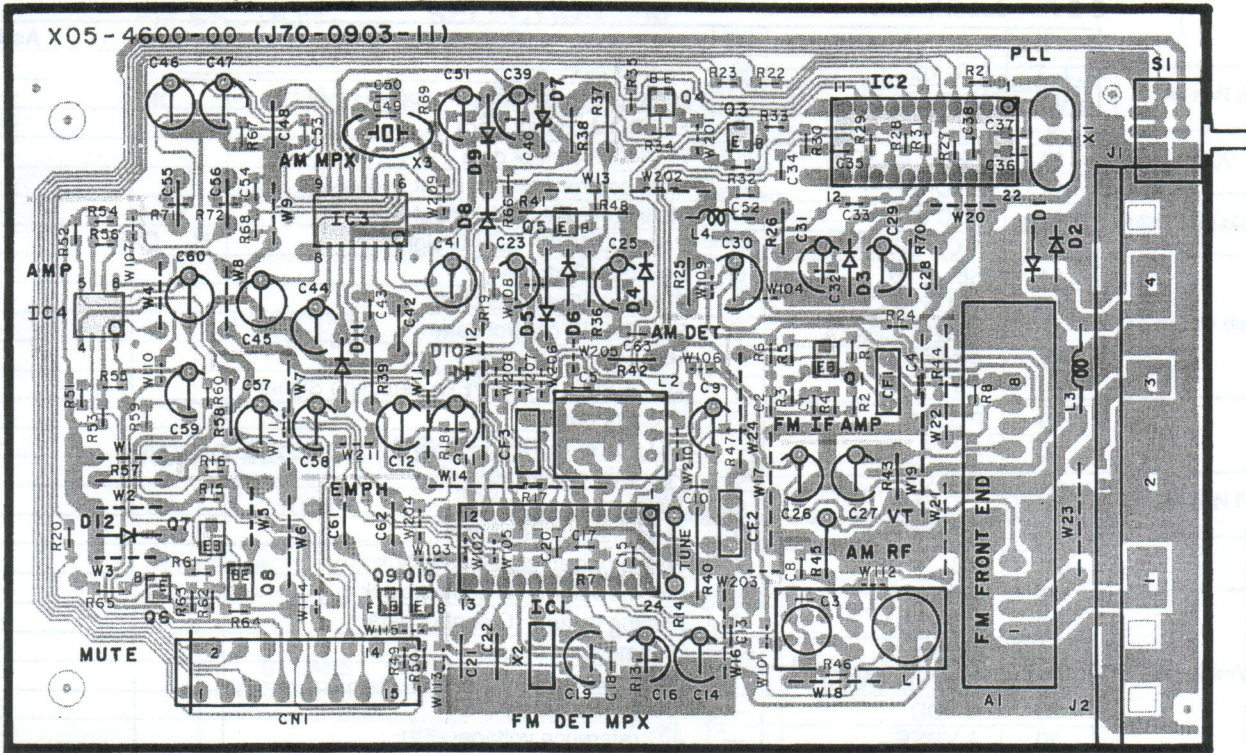

TUNER UNIT (X05-4622-71) : ET

Discriminator : 0V

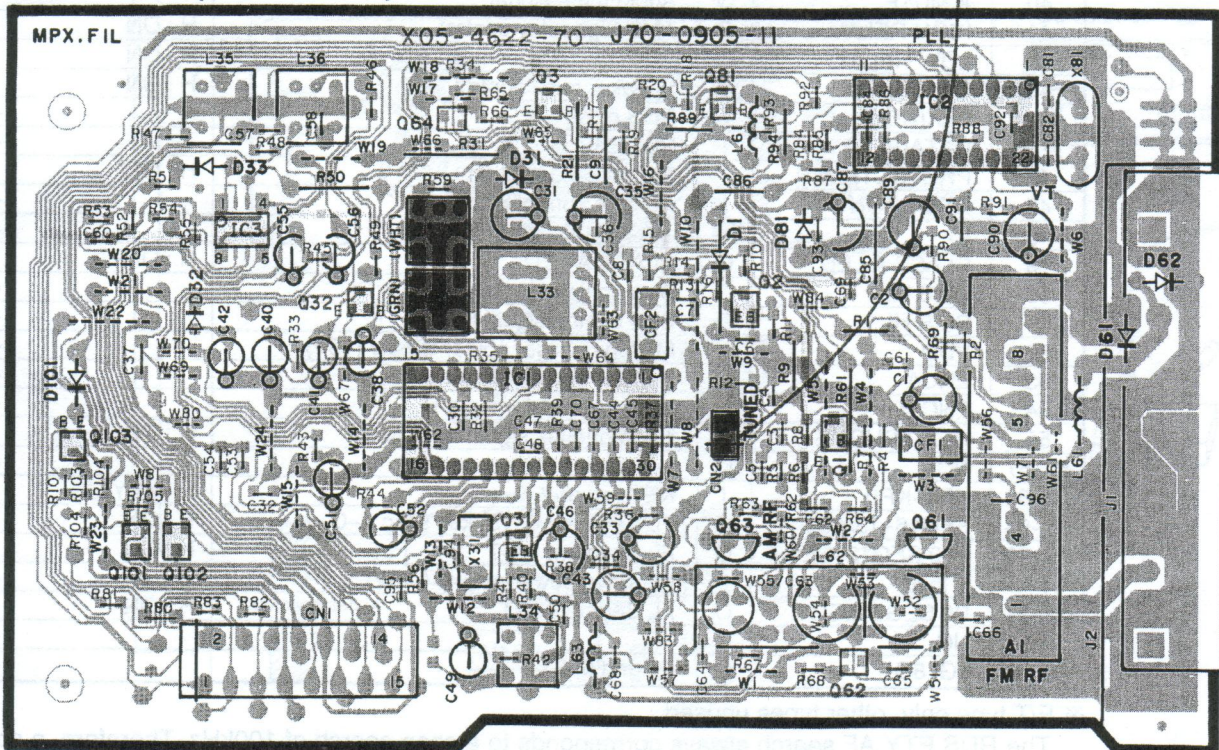
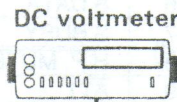

11) : K
 21) : M
 71) : ET

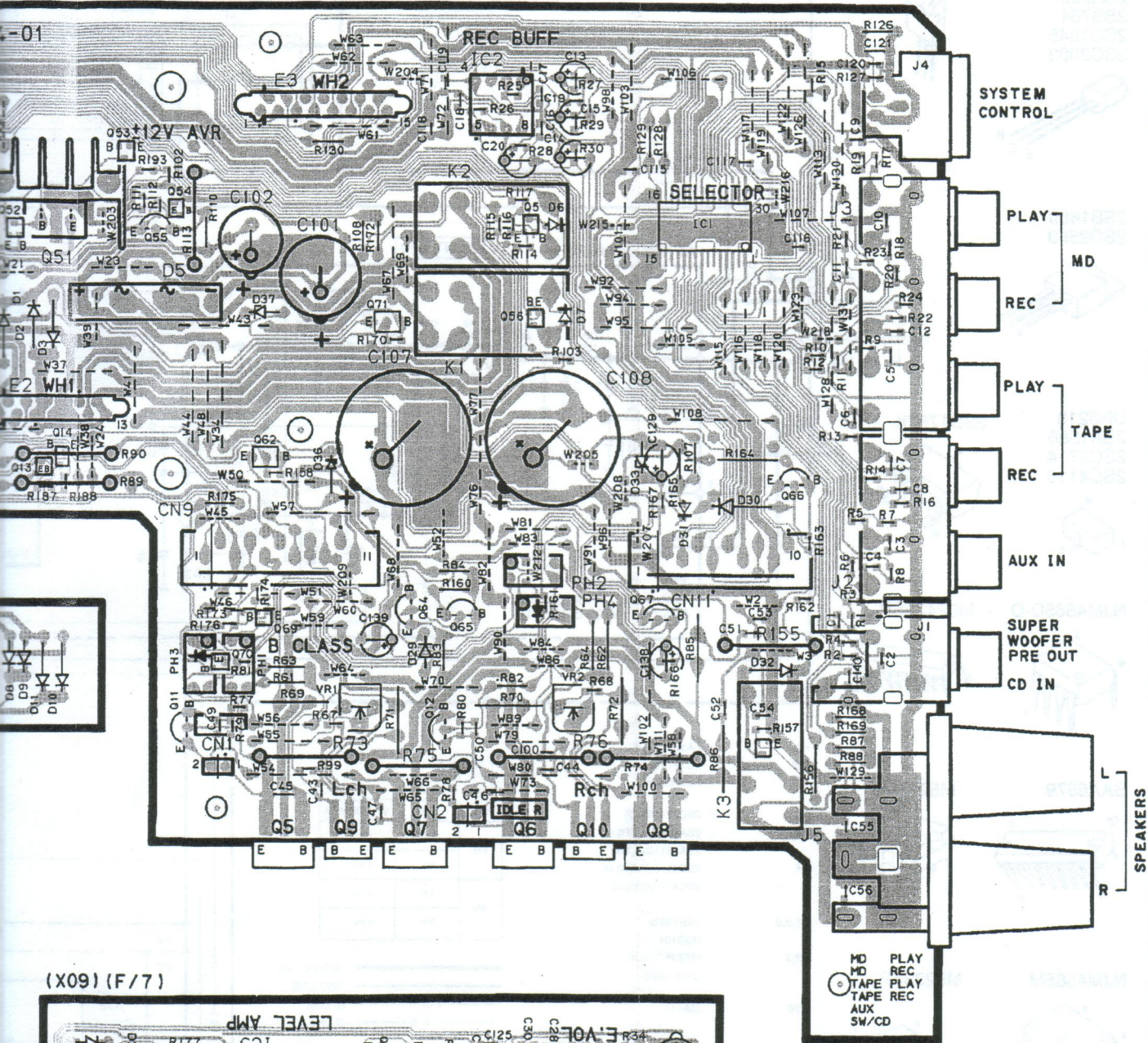

(X09) (F/7)

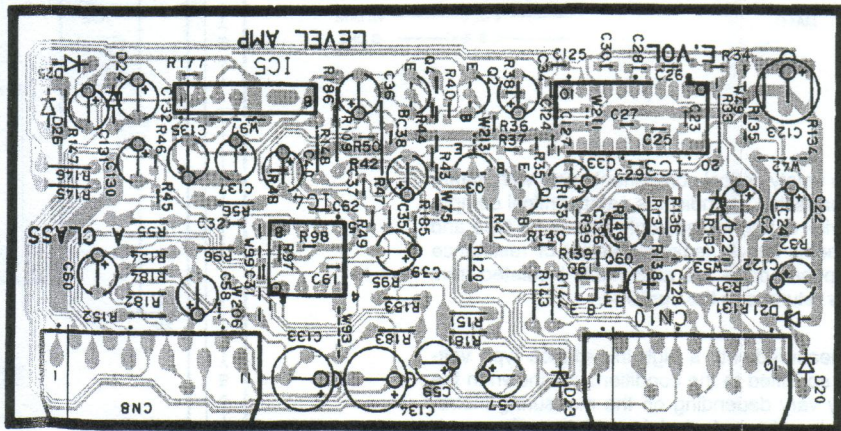

PC BOARD(Component side view)

(X09) (E/7)

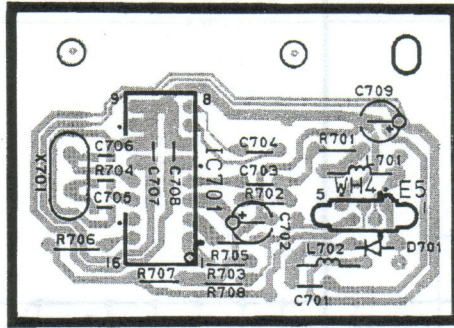

(X09) (D/7)

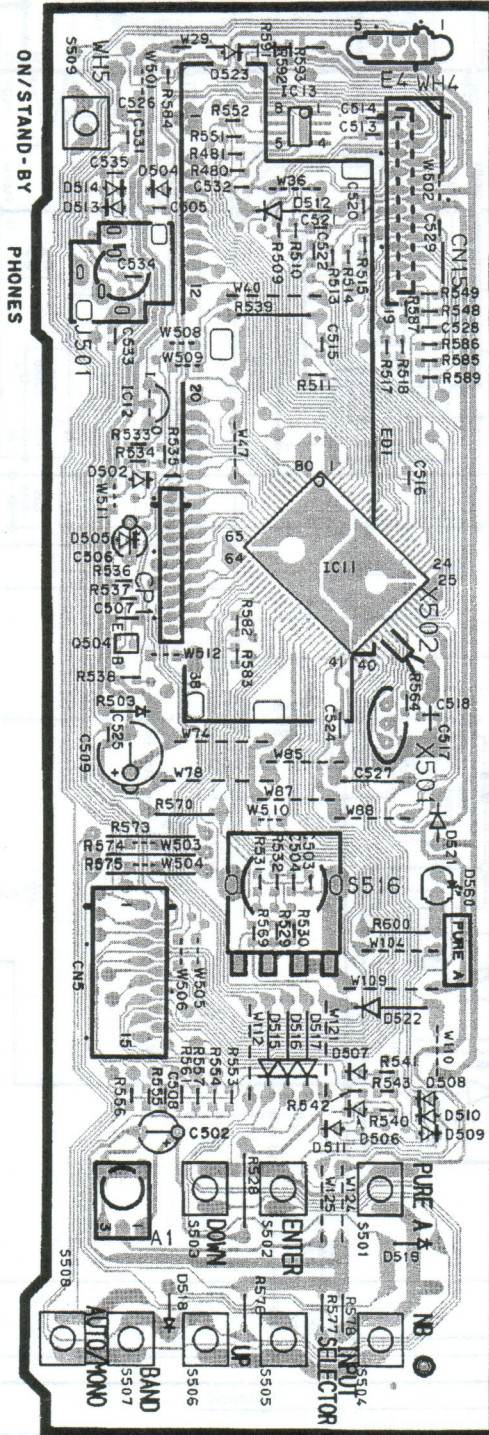

AUDIO UNIT (X09-4690-
(X09-4690-
(X09-4692-

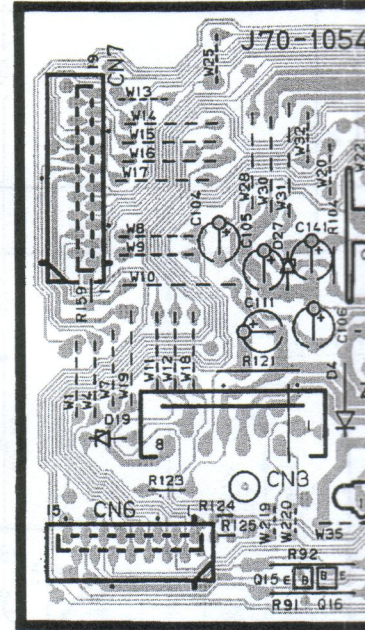

(X09) (C/7)

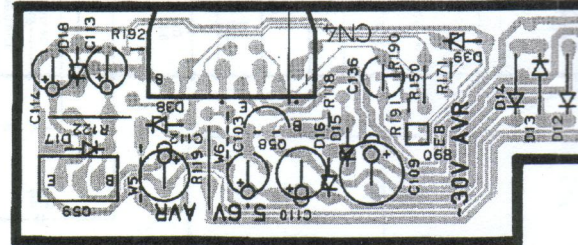

(X09) (B/7)

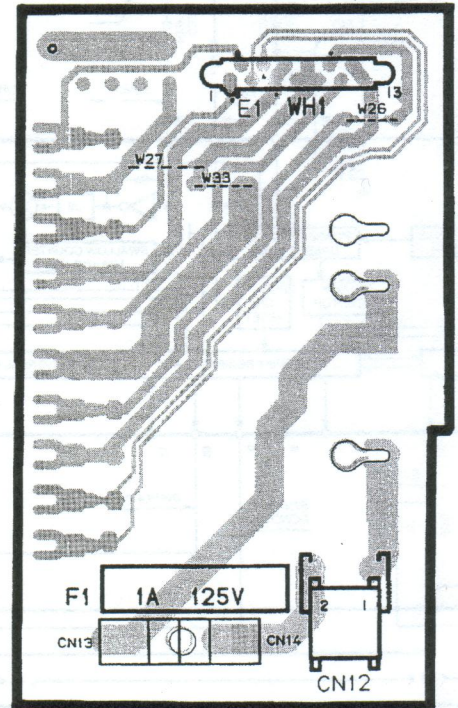

Refer to the schematic diagram for the value of resistors and capacitors.

R-SE7/SE-7(G)

PARTS DESCRIPTIONS

CAPACITORS

CC 45 TH 1H 220 J
 1 2 3 4 5 6

- 1 = Type ... ceramic, electrolytic, etc.
- 2 = Shape ... round, square, ect.
- 3 = Temp. coefficient
- 4 = Voltage rating
- 5 = Value
- 6 = Tolerance

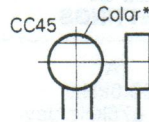

Capacitor value

- 010 = 1pF
- 100 = 10pF
- 101 = 100pF
- 102 = 1000pF = 0.001μF
- 103 = 0.01μF

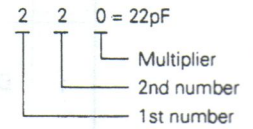

Temperature coefficient

1st Word	C	L	P	R	S	T	U
Color*	Black	Red	Orange	Yellow	Green	Blue	Violet
ppm/°C	0	-80	-150	-220	-330	-470	-750

2nd Word	G	H	J	K	L
ppm/°C	±30	±60	±120	±250	±500

Example : CC45TH = -470 ± 60ppm/°C

Tolerance (More than 10pF)

Code	C	D	G	J	K	M	X	Z	P	No code
(%)	±0.25	±0.5	±2	±5	±10	±20	+40 -20	+80 -20	+100 -0	More than 10μF -10 ~ +50 Less than 4.7μF -10 ~ +75

(Less than 10pF)

Code	B	C	D	F	G
(pF)	±0.1	±0.25	±0.5	±1	±2

Voltage rating

2nd word \ 1st word	A	B	C	D	E	F	G	H	J	K	V
0	1.0	1.25	1.6	2.0	2.5	3.15	4.0	5.0	6.3	8.0	-
1	10	12.5	16	20	25	31.5	40	50	63	80	35
2	100	125	160	200	250	315	400	500	630	800	-
3	1000	1250	1600	2000	2500	3150	4000	5000	6300	8000	-

Chip capacitors

(EX) C C 7 3 F S L 1 H 0 0 0 J
 1 2 3 4 5 6 7

(Chip) (CH, RH, UJ, SL)

(EX) C K 7 3 F F 1 H 0 0 0 Z
 1 2 3 4 5 6 7

(Chip) (B, F)

Refer to the table above.

- 1 = Type
- 2 = Shape
- 3 = Dimension
- 4 = Temp. coefficient
- 5 = Voltage rating
- 6 = Value
- 7 = Tolerance

Dimension (Chip capacitors)

Dimension code	L	W	T
Empty	5.6 ± 0.5	5.0 ± 0.5	Less than 2.0
A	4.5 ± 0.5	3.2 ± 0.4	Less than 2.0
B	4.5 ± 0.5	2.0 ± 0.3	Less than 2.0
C	4.5 ± 0.5	1.25 ± 0.2	Less than 1.25
D	3.2 ± 0.4	2.5 ± 0.3	Less than 1.5
E	3.2 ± 0.4	1.6 ± 0.2	Less than 1.25
F	2.0 ± 0.3	1.25 ± 0.2	Less than 1.25
G	1.6 ± 0.2	0.8 ± 0.2	Less than 1.0

RESISTORS

Chip resistor (Carbon)

(EX) R K 7 3 E B 2 B 0 0 0 J
 1 2 3 4 5 6 7

(Chip) (B, F)

Carbon resistor (Normal type)

(EX) R D 1 4 B B 2 C 0 0 0 J
 1 2 3 4 5 6 7

- 1 = Type
- 2 = Shape
- 3 = Dimension
- 4 = Temp. coefficient
- 5 = Rating wattage
- 6 = Value
- 7 = Tolerance

Dimension

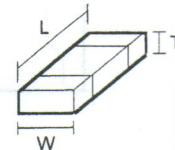

Dimension (Chip resistor)

Dimension code	L	W	T
E	3.2 ± 0.2	1.6 ± 0.2	1.0
F	2.0 ± 0.3	1.25 ± 0.2	1.0
G	1.6 ± 0.2	0.8 ± 0.2	0.5 ± 0.1

Rating wattage

Code	Wattage	Code	Wattage	Code	Wattage
1J	1/16W	2C	1/6W	3A	1W
2A	1/10W	2E	1/4W	3D	2W
2B	1/8W	2H	1/2W		

(G) R-SE7/SE-7(G)

ADJUSTMENT

FM SECTION SELECTION : FM X05-4622-71 (E/T TYPE)

NO.	ITEM	INPUT SETTINGS	OUTPUT SETTINGS	TUNER SETTINGS	ALIGNMENT POINTS	ALIGN FOR	FIG.
1	DISCRIMINATOR	(A) 98.0kHz 1kHz, ± 75 kHz dev. 60dB μ (ANT input)	Connect a DC voltmeter between Pin 1 and Pin 2 of CN 2.	MONO 98.0MHz	L 31	0V	(a)
					L 32	Minimum distortion.	
2	DISTORTION (STEREO)	(C) 98.0MHz 1kHz, ± 68.25 kHz dev. Pilot: ± 6.75 kHz dev. 60dB μ (ANT input)	(B)	AUTO 98.0MHz	IFT (A1)	Minimum distortion.	(a)

AUDIO SECTION (X09-469x-xx)

NO.	ITEM	INPUT SETTINGS	OUTPUT SETTINGS	AMP SETTINGS	ALIGNMENT POINTS	ALIGN FOR	FIG.
POWER: ON SELECTOR : AUX							
1	B CLASS IDLE CURRENT	—	Connect a DC voltmeter across CN1(L) CN2(R) (X09, A/7)	PURE A : OFF Volume : 0	VR1(L) VR2(R) (X09, A/7)	20mV	(b)

SYSTEM CONNECTIONS

(a)

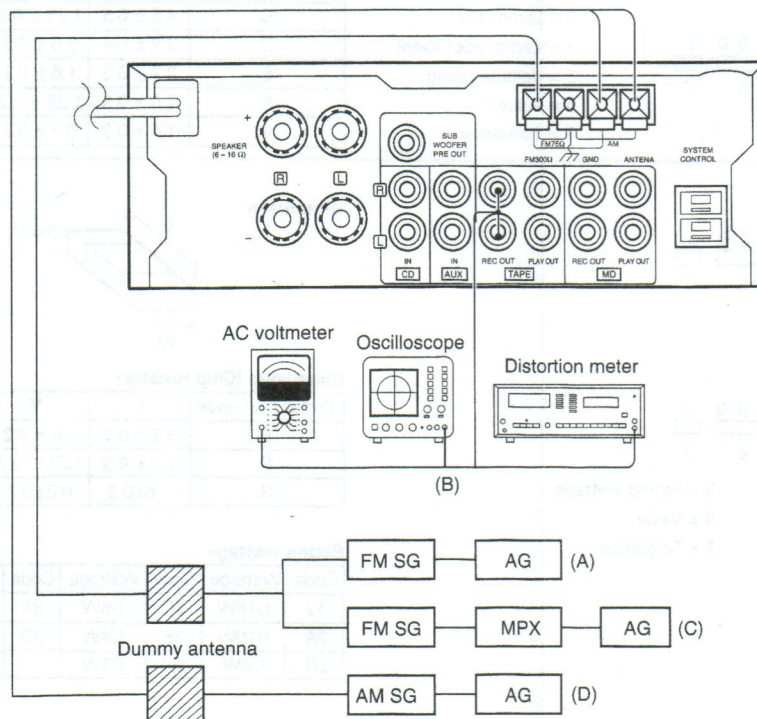

(b)

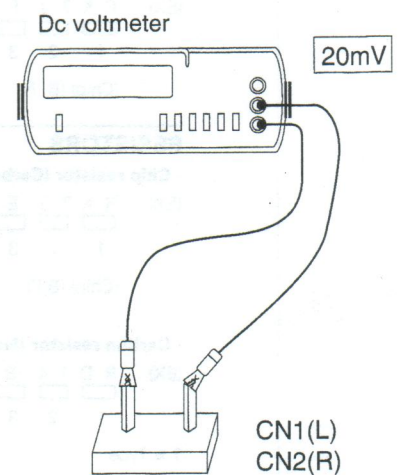

R-SE7/SE-7(G)

CIRCUIT DESCRIPTION

5-2 Pin description

Pin No.	Name	I/O	Description	Active	
1~7	7G~1G	O	FL grid 7~1	—	
8	VDD	—	Micro processor power supply (+5V)	—	
9	E2PROM SCL	O	E2PROM control clock	—	
10	E2PROM SDA	I/O	E2PROM control data	—	
11	ENC C	—	Multi control encoder input A	—	
12	ENC D	—	Multi control encoder input B	—	
13	A CLASS ON	O	Power ON/OFF control signal	H : OFF	L : ON
14	SEL STB	O	Selector IC strobe	—	
15	SEL/PLL CLK	O	SEL/PLL IC control clock	—	
16	SEL/PLL DATA	O	SEL/PLL IC control data	—	
17	RESET	I	Microprocessor reset	L : RESET ON	
18	CE	I	AC OFF(MAIN POWER) detection Signal	L : AC OFF	
19	PLL DO	O	IF count data	—	
20	AVSS	—	A/D power SUPPLY (GND)	—	
21	PLL CE	O	PLL chip enable control	L : CE	
22	T MUTE	O	Tuner mute signal	L : MUTE ON	
23	STEREO	I	Stereo signal detection	L : STEREO ON	
24	SD	I	Synchronized signal detection	—	
25	VOL SCL	O	Electric volume IC control clock	—	
26	VOL SDA	O	Electric volume IC control data	—	
27	LEVEL IN	I	Volume level input	—	
※ 28	S.LEVEL(RDS)	I	Signal level	—	
29	A VDD	—	A/D power supply (+5V)	—	
30	A VREF	—	A/D reference voltage(+5V)	—	
31, 32	OSC	—	32kHz oscillator	—	
33	Vss	—	Microprocessor power supply (GND)	—	
34, 35	OSC	—	4.19MHz oscillator	—	
36	S.DATA	I/O	16bit system data	—	
37	S.BUSY	I/O	16 bit system busy	H : BUSY	L : READY
38	H.P. MUTE	O	Head phones mute signal	L : ON	
39	ATT	O	CLASS A control signal	H : A CLASS	L : AB CLASS
40	A MUTE	O	Audio mute signal	L : ON	
41	HIGH RELAY	O	AMP high relay control	H : ON	L : OFF
42	LOW RELAY	O	AMP low relay control	H : ON	L : OFF
43	SP RELAY	O	Speaker relay control	H : ON	L : OFF
※ 44	CLK(RDS)	I	RDS clock	—	
※ 45	DATA(RDS)	I	RDS data	—	
46	PROTECTION	I	Protection detection	H : ON	L : OFF
47	REMOCON	I	Remote control input	—	
48	IC	—	—	—	
49	CLASS A LED	O	CLASS A LED	H : OFF	L : ON
50	BIAS MID	O	Bias control signal MID	—	
51	BIAS HI	O	Bias control signal HI	—	
52	VDD	—	Microprocessor power supply (+5V)	—	
53	ENCA	I	Volume encoder in put A	—	
54	ENC B	I	Volume encoder input B	—	
55	HEAD PHONE	I	Head phones signal detection	H : ON	L : OFF
56, 57	NC	O	—	—	
58~60	KR2~KR0	I	KEY return 2~0	H : KEY ON	
61~64	SEG16~13/KS3~0	O	FL Segment 6~13 /key scan 3~0	H : ON	
65~70	P12 SEG12~SEG7	O	FL Segment 12~7	H : ON	
71	V load	—	FL drive power supply (-30V)	—	
72~77	P6 SEG6~SEG1	O	FL Segment 6~1	H : ON	
78	NC	O	—	—	
79, 80	9G, 8G	O	FL grid 9, 8	—	

※ E/T type only, other types unused.

The RDS PTY AF search always corresponds to a span search of 100kHz. Therefore, a span search of 50 KHz cannot be performed.

R-SE7/SE-7(G)

CIRCUIT DESCRIPTION

5. Microprocessor : uPD78045FGF057 (X14 : IC1)

5-1 Microprocessor periphery block diagram

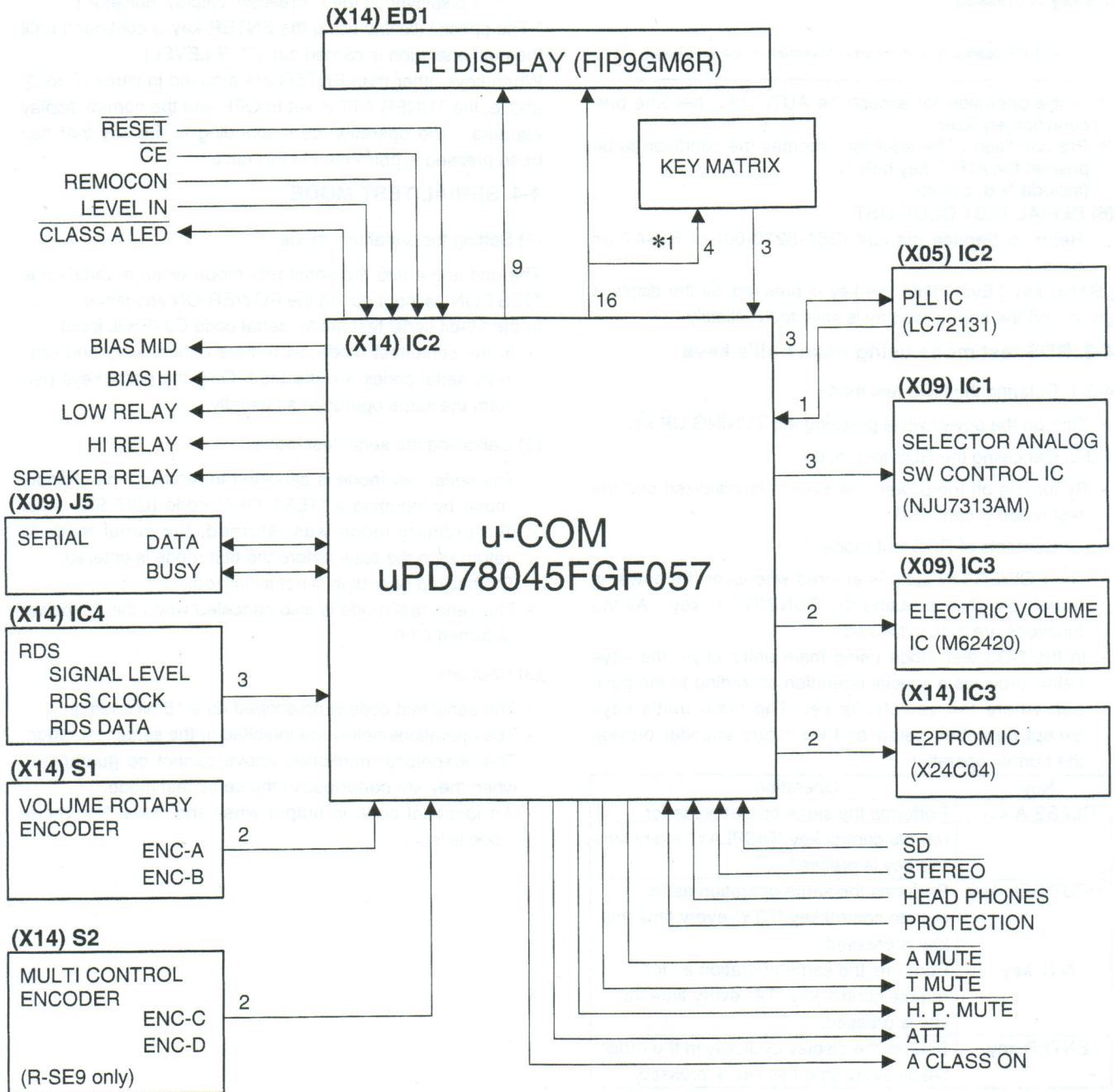

Key matrix

No. of ○ : u-COM port No.

	⑥0 KR0	⑤9 KR1	⑤8 KR2
⑥4 KS0	DSW0	DSW1 (D158)	DSW2 (D159)
⑥3 KS1	POWER	AUTO / MONO	BAND
⑥2 KS2	N. B. CIRCUIT	(R-SE7) INPUT SEL. (R-SE9) MODE	(R-SE7) TUNING UP (R-SE9) No. use
⑥1 KS3	pure A	ENTER	(R-SE7) TUNING DOWN (R-SE9) No use

R-SE7/SE-7(G)

CIRCUIT DESCRIPTION

[AUTO key] Selects the MUTE operation and equalizer cyclically in the order below for operation display every time this key is pressed.

[-> MUTE operation -> Minimum -> Maximum -> *Pre-condition]

- ※ In the operation for except the AUTO key, become pre-condition equalizer .
- ※ Pre condition : The equalizer becomes the condition to be pushed the AUTO key before (include N.B. circuit).

(6) SERIAL TEST CODE LIST

Refer to Service manual (B51-5210-00) of R-SA7 on page 7.

[BAND key] Every time this key is pressed, all the displays go off and the normal display is selected cyclically.

4-3. RDS test mode using main unit's keys

4-3-1. Entering the RDS test mode

- Turn on the power while pressing the TUNING UP key.

4-3-2. Canceling the RDS test mode

- By turning off the power, the system is initialized and the test mode is canceled.

4-3-3. Contents of RDS test mode

- The POWER ON state is entered whenever the power is turned on while pressing the TUNING UP key. All the functions are then initialized.
- In the RDS test mode using main unit's keys, the keys below provides a special operation according to the position where the selector is set. The main unit's keys except described below and the rotary encoder provide the normal operation.

Key	Operation
CLASS A key	Performs the same operation as for remote control key "DISPLAY" every time this key is pressed.
INPUT SEL. key	Performs the same operation as for remote control key "PTY" every time this key is pressed.
N.B. key	Performs the same operation as for remote control key "TA" every time this key is pressed.
ENTER key	Selects the display cyclically in the order below every time this key is pressed.

- ① Write data in the unused area of EEPROM, then read the written data. If the read data is the same as the written data, "RAM OK" is displayed in the fluorescent display indicator. If the former is different from the latter, "RAM NG" is displayed.
- ② Set the TUNER ATT to OFF and display the S level in hexadecimal when the ENTER key is pressed. ("ATT OFF ***" is displayed in the fluorescent display indicator.)

- ③ Set the TUNER ATT to ON and display the S level in hexadecimal when the ENTER key is pressed. ("ATT ON ***" is displayed in the fluorescent display indicator.)

* The special display using the ENTER key is continued until the next operation is carried out. (**: S LEVEL)

When keys other than ENTER are pressed in items ① to ③ above, the TUNER ATT is set to OFF and the normal display appears. The operation corresponding to the key that has been pressed is performed in this case.

4-4. SERIAL TEST MODE

(1) Setting the serial test mode

The unit is put into the serial test mode when a serial code "TEST ON" is input during the POWER-ON sequence.

In the 16-bit serial test mode, serial code C27FH is input.

- In the serial test mode, all remote control keys and ordinary serial codes are disabled. Only the panel keys perform the same operation as usually.

(2) Canceling the serial test mode

- The serial test mode is canceled to return to the ordinary mode by inputting a "TEST OFF" code (C27 EH). After the ordinary mode was returned, the serial mode is returned to the state before the test mode is entered. The backup operation is not initialized.
- The serial test mode is also canceled when the AC power is turned OFF.

(3) Cautions

- The serial test code is prescribed as a 16-bit code only.
- The operations below are inhibited in the serial test mode. The operations mentioned above cannot be guaranteed when they are performed in the serial test mode.
- An identical code is output when the serial test mode code is input.

R-SE7/SE-7(G)

CIRCUIT DESCRIPTION

3. DESTINATION LIST OF TUNER

3-1 Destination List of Tuner

Desti- nation	BAND	Receive frequency range	Channel space	1F	PLL reference frequency	DIODE SW	
						DSW1 D518	DSW2 D519
K1	FM	87.5MHz~ 108.0MHz	100kHz	+10.7MHz	25kHz	1	1
	AM	530kHz~ 1700kHz	10kHz	+450kHz	10kHz		
E1	FM	87.5MHz~ 108.0MHz	50kHz	+10.7MHz	25kHz	0	1
	AM	531kHz~ 1602kHz	9kHz	+450kHz	9kHz		
E3 (RDS)	FM	87.5MHz~ 108.0MHz	50kHz	+10.7MHz	25kHz	1	0
	AM	531kHz~ 1602kHz	9kHz	+450kHz	9kHz		
M	K2 or E1 is changed the setting "DSW1". (DSW1=1 : K2, 0 = E1)					X	1

0 : NO DIODE 1 : DIODE X : SWITCHING TRANSISTOR

4. TEST MODE

4-1. Initializing

The system is initialized when the power is turned on while pressing the on/standby key.

(1) Contents of operation

- All the functions are initialized.

4-2. AMP test mode using main unit's keys

4-2-1. Entering the AMP test mode

- Turn on the power while pressing the BAND key.

4-2-2. Canceling the AMP test mode

- By turning off the power, the system is initialized and the test mode is canceled.

4-2-3. Contents of AMP test mode

(1) Automatic on/standby ON

- The POWER ON state is entered whenever the power is turned on while pressing the BAND key. All functions are then initialized and activated in the all-lighting mode.
- Sub-clock oscillation diagnosis function
The oscillation diagnosis (existence of oscillation and measurement of period) of a sub-clock is performed before the test mode is entered. If the diagnosis result is OK, the system enters the test mode.
If the diagnosis result is NG, the oscillation of the sub-clock is diagnosed again. If the result is OK, the system enters the test mode. If the diagnosis result is continuously NG five times, the system stops with ERR 1 and ERR 2 displayed.

(2) All-lighting mode

- All the fluorescent display indicators and LED lamps light when the power is turned on while pressing the BAND key.

- After that, the all-lighting mode is canceled when any main unit's key is pressed. The normal display obtained when the selector is set to TUNER then appears.

(3) Others

- The AMP test mode is not terminated even if the selector is set to positions other than TUNER.
- In the AMP test mode, the muting during mode selection is not controlled. However, the operation during the power-on sequence is the same as the normal operation.
- The SP protection operation is also the same as the normal operation.
- In the AMP test mode using main unit's keys, the keys below provide a special operation according to the position where the selector is set. The main unit's keys except described below and the rotary encoder provide the normal operation.

(4) When selector is set to TUNER

Key	Operation
PURE A key	Increments the P.CALL every time this key is pressed.
N.B. key	Decrement the P.CALL every time this key is pressed.
ENTER key	Selects the display cyclically in the order below every time this key is pressed.

- Write data in the unused area of E2PROM, then read the written data. If the read data is the same as the written data, "RAM OK" is displayed in the fluorescent display indicator. If the former is different from the latter, "RAM NG" is displayed.
- Set the TUNER ATT to OFF and display the S level in hexadecimal when the ENTER key is pressed. ("ATT OFF ***" is displayed in the fluorescent display indicator.)
- Set the TUNER ATT to ON and display the S level in hexadecimal when the ENTER key is pressed. ("ATT ON ***" is displayed in the fluorescent display indicator.)

* The special display using the ENTER key is continued until the next operation is carried out. (**: S LEVEL)
When keys other than ENTER are pressed in items ① to ③ above, the TUNER ATT is set to OFF and the normal display appears. The operation corresponding to the key that has been pressed is performed in this case.

(5) When selector is set to positions other than TUNER [ENTER key] Every time this key is pressed, master VOLUME level is selected cyclically.

INITIALIZE level → MAX → MID → MIN →

Value of Master VOLUME	Press the ENTER key.	Press the PURE A key, then press the ENTER key.
MAX	86	16.00
MID	40	8.00
MIN	1	0.20
INITIALIZE	7	1.40

R-SE7/SE-7(G)

CIRCUIT DESCRIPTION

1. INITIAL STATE

(1) AMP-related block

• POWER	OFF
• SELECTOR SOURCE	TUNER
• DISPLAY	SELECTOR
• N.B. CIRCUIT	OFF
• A CLASS VOLUME VALUE	1.40 STEP
• AB CLASS VOLUME VALUE	7 STEP
• PURE MODE	NORMAL (AB CLASS)
• AUTO POWER SAVE	OFF
• MULTI CONTROL MODE	INPUT SEL.(R-SE9 only)

(2) TUNER-related block

• BAND	FM
• FREQUENCY	Lower-limit value of receiving frequency.
FM	87.5 MHz
AM	531 kHz
• AUTO/MANUAL	AUTO
• P.CH MEMORY	Last frequency
• Last P.CH	01ch
• RDS DATA TABLE MEMORY	NO DATA

(3) TIMER-rated block

• CLOCK	STOP (AM12:00)
• PROGRAM	WORKING MODE OFF
CONTENTS OF PROGR.	ON=AM 12:00
	OFF=AM 12:00
	PLAY MODE=PLAY
	SELECTOR=TUNER(1ch)
	REC MODE OFF
• O.T.T	WORKING MODE OFF
OTT ON TIME	AM 7:00

(4) TEST PRESET FREQUENCY

Channel	BAND	E TYPE	Channel	BAND	E TYPE
01ch	FM	87.50MHz	11ch	FM	90.00MHz
02ch	FM	97.50MHz	12ch	FM	98.00MHz
03ch	FM	108.00MHz	13ch	FM	98.50MHz
04ch	AM	630kHz	14ch	FM	106.00MHz
05ch	AM	990kHz	15ch	AM	531kHz
06ch	AM	1440kHz	16ch	AM	990kHz
07ch	FM	87.50MHz	17ch	AM	1602kHz
08ch	FM	87.50MHz	18ch	FM	87.50MHz
09ch	FM	87.50MHz	19ch	FM	87.50MHz
10ch	FM	89.10MHz	20ch	FM	87.50MHz

※ The initial setting is performed in a following event :

1. When backup memory data is destroyed when reset is applied to the microprocessor.
2. When the power cord is plugged in to the AC wall outlet while pressing the on/standby key.

2. BACKUP

This function holds the current state of the unit even if the AC power of the receiver is turned OFF.

(1) Operation outline

The backup state set command signal (CE) of a microcomputer is set low when the AC power is turned OFF. The microcomputer detects the signal and enters the stop state.

The microcomputer is reset when the AC power is turned ON. The data for backup state confirmation is checked by reset processing.

The microcomputer is initialized when the data was destroyed. If it is not destroyed, the microcomputer is started in the backup state.

- The data for backup state confirmation is written in a RAM area.
- The microcomputer is set to the STOP mode so as to save the power consumption.
- A backup state set command signal is detected by a timer interrupt of 1 msec.
- The backup guarantee period is set in a circuit.

(2) Backup state setting

- The data (A596, 5A69H) for backup state confirmation is written in a RAM area.

(3) Contents of backup data to be held

--- AMP ---

- POWER ON/OFF
- DISPLAY MODE
- SELECTOR SOURCE
- N.B. CIRCUIT MODE
- A CLASS VOLUME VALUE
- AB CLASS VOLUME VALUE
- PURE A MODE

--- TUNER ---

- LAST BAND
- PRESET CHANNEL/RECEIVING STATION FREQUENCY/PI/TA/PTY/PS
- LAST RECEIVING STATION FREQUENCY AND PRESET CHANNEL (AM/FM)
- PRESET MEMORY data (1ch~40ch)
- AUTO/MANUAL

--- CLOCK/TIMER ---

- LAST CLOCK DATA
- PROGRAMMED CONTENTS/PROGRAM TIMER WORKING MODE ON/OFF
- O.T.T. SETTING TIME/O.T.T. WORKING MODE ON/OFF

R-SE7/SE-7(G)

CONTENTS / ACCESSORIES

Contents

CONTENTS / ACCESSORIES	2	SCHEMATIC DIAGRAM	13
CIRCUIT DESCRIPTION	3	EXPLODED VIEW	24
ADJUSTMENT	8	PARTS LIST	25
PC BOARD	10	SPECIFICATIONS	Back cover

Accessories

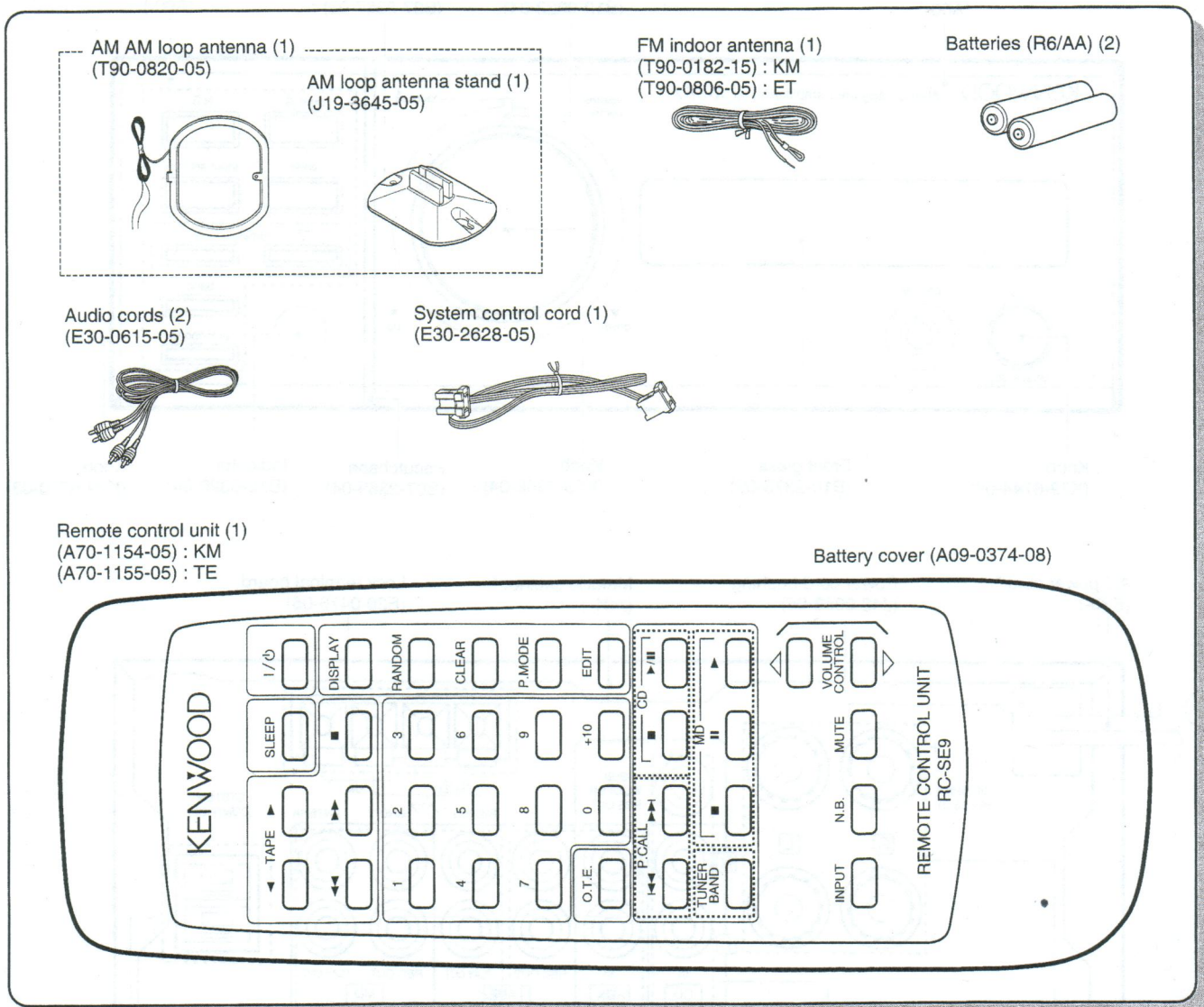

System configuration

SYSTEM NAME	AMP/TUNER	CD PLAYER	SPEAKER
HM-701	R-SE7	DP-SE7	LS-SE7