

RXD-A850DV/DV50/DV70

SERVICE MANUAL

(XD-A850DV~DV70)**

© 2001-9 PRINTED IN KOREA
B51-5751-00 (K/K) 3186

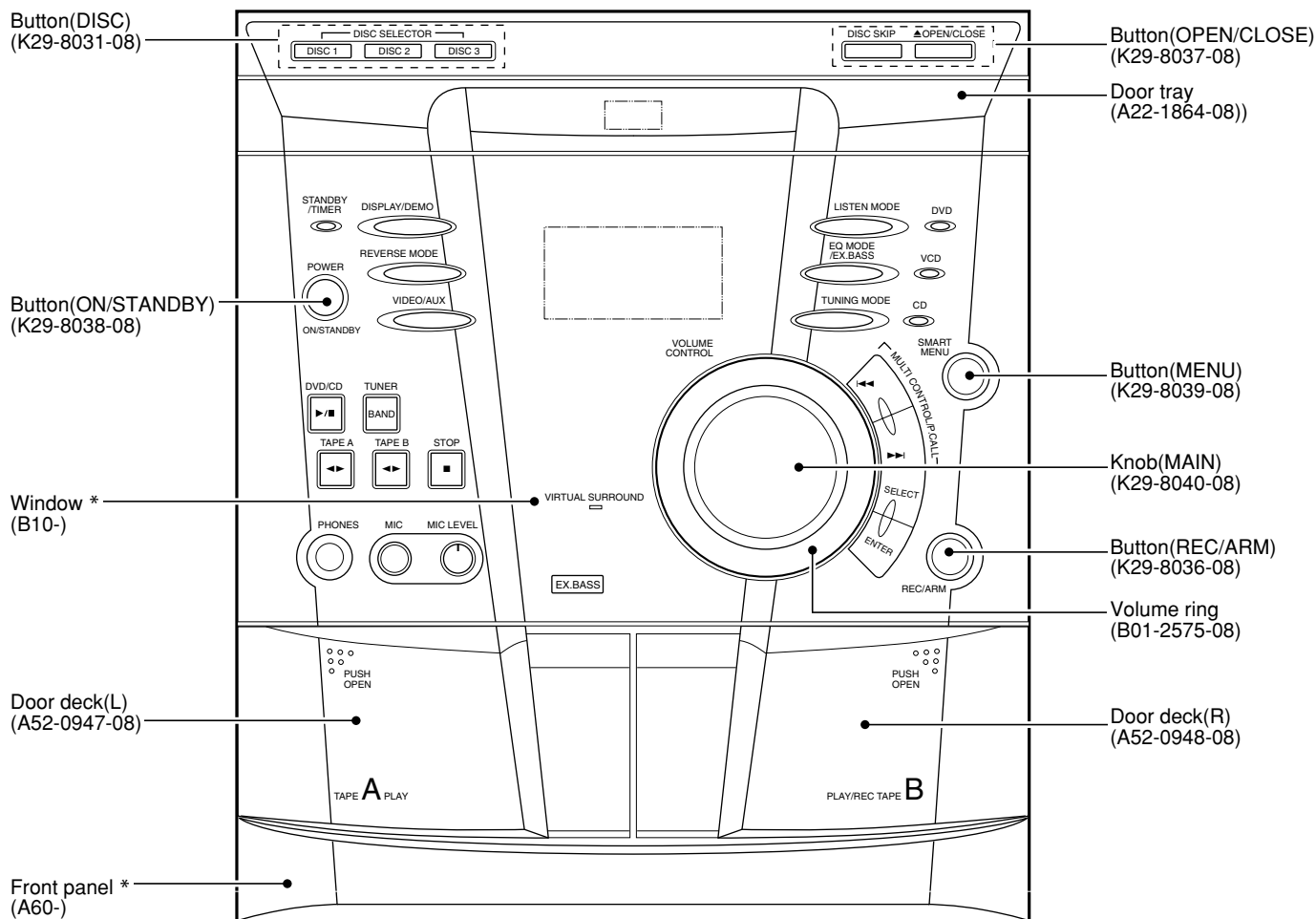

M and M2 types are available for MIC circuit.
****Refer to page 2 if you want to know system configuration.**

In compliance with Federal Regulations, following are reproduction of labels on, or inside the product relating to laser product safety.

*** Refer to parts list on page 28 .**

KENWOOD-Corp. certifies this equipment conforms to DHHS Regulations No.21 CFR 1040. 10, Chapter 1, subchapter J.

DANGER : Laser radiation when open and interlock defeated. AVOID DIRECT EXPOSURE TO BEAM.



RXD-A850DV/DV50/DV70

CONTENTS / ACCESSORIES / CAUTIONS

Contents

CONTENTS / ACCESSORIES / CAUTIONS.....	2	SCHEMATIC DIAGRAM	13
EXTERNAL VIEW	3	EXPLODED VIEW	26
ADJUSTMENT	4	PARTS LIST.....	28
PC BOARD	5	SPECIFICATIONS	36

Accessories

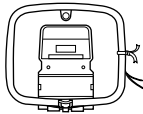
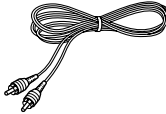
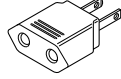
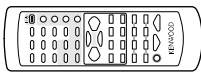
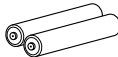
<p>FM indoor antenna (1) (T90-0881-08)</p> 	<p>Loop antenna (1) (T90-0882-08)</p> 	<p>Video cord (1) (E30-7235-08)</p> 	<p>*AC plug adaptor (1) (E03-0115-05)</p>  <p>* Use to adapt the plug on the power cord to the shape of the wall outlet. (Accessory only for regions where use is necessary.)</p>
<p>Remote control unit (1) (A70-1533-08):KYX (A70-1534-08):TE (A70-1535-08):MM2</p> 	<p>Batteries (R6/AA) (2)</p> 		

System configurations

SYSTEM	MAIN UNIT	DESTINATION	SPEAKER
XD-A850DV	RXD-A805DV	K	LS-N50V-H
XD-DV50	RXD-DV50	MXET	LS-N50V
XD-DV50(M2)	RXD-DV50(M2)	M2	LS-N50V
XD-DV60	RXD-DV70	MX	LS-N70V
XD-DV60(M2)	RXD-DV70(M2)	M2	LS-N70V
XD-DV70	RXD-DV70	MX	LS-N90V

Cautions

The marking of products using lasers (Except for some areas)



The marking is located on the rear panel and says that the component uses laser beams that have been classified as Class 1. It means that the unit is utilizing laser beams that are of a weaker class. There is no danger of hazardous radiation outside the unit.

Operation to reset

The microcomputer may fall into malfunction (impossibility to operate, erroneous display, etc.) when the power cord is unplugged while power is ON or due to an external factor. In this case, execute the following procedure to reset the microcomputer and return it to normal condition.

Set the POWE key to ON. Then press the VIDEO/AUX key while holding the TUNING MODE key down.

- Please note that resetting the microcomputer clears the contents stored in and returns and to condition when it left the factory.

RXD-A850DV/DV50/DV70

EXTERNAL VIEW

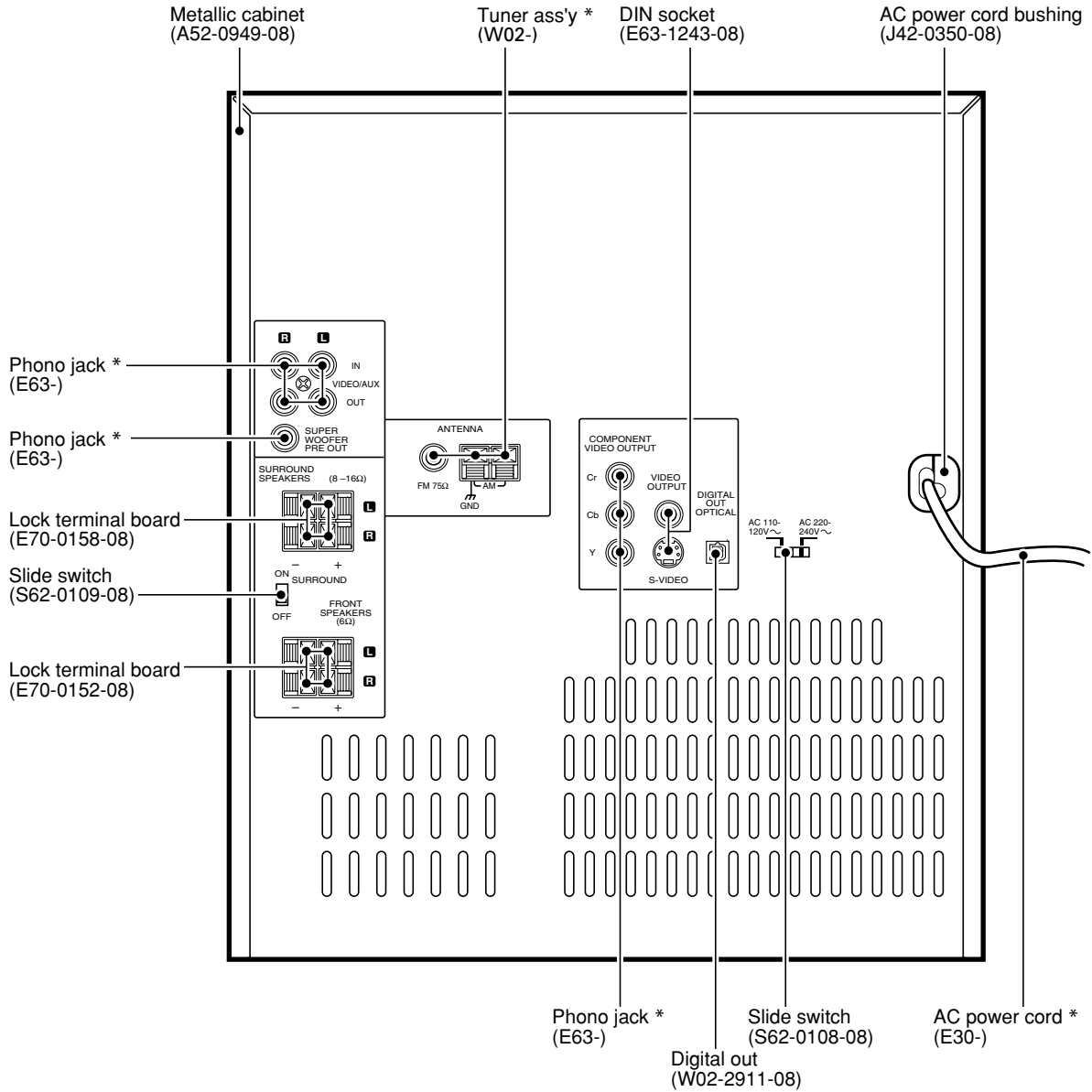

* Refer to parts list on page 28 .

RXD-A850DV/DV50/DV70

ADJUSTMENT

CASSETTE DECK SECTION

NO	ITEM	INPUT SETTINGS	OUTPUT SETTINGS	CASSETTE TAPE DECK SETTINGS	ALIGNMENT POINT	ALIGN FOR
1. Cassette mechanism section (REC/PB head adjustment)						0dB = 400mV
[1]	Demagnetization and cleaning	-	-	Power OFF demagnetization, cleaning play	REC/PB head, erase head, capstan, pinch roller	Demagnetize the REC/PB head by head eraser. Clean the REC/PB head, erase head capstan and pinch roller with a cotton swab immersed in alcohol.
[2]	azimuth REC/PB Head azimuth	MTT-114 TCC-153 10KHz, -10dB	AUX OUTPUT	PLAY	Azimuth adjustment screw	Adjust the output to maximum and adjust the azimuth adjustment screw for the Lissajours waveform pattern of the oscilloscope to become close to a 45° straight line.
2. PC board adjustment						
[1]	Tape speed	MTT-111 TCC-100 3KHz, -4dB	AUX OUTPUT	PLAY	VR901	Adjust the tape speed so that 3kHz is obtained at the center of the tape. (Frequency of 3KHz +/- 40Hz)
[2]	PLAY BACK LEVEL	MTT-130	AUX OUTPUT	PLAY	-	Playback output to 400mV +/- 50mV
[3]	REC BIAS Frequency	REC/PB TEST TAPE AC-224	AUX OUTPUT	REC	T901	CN902 Pin1 and Pin2(GND) Ensure that the Frequency Counter Adjust T901 to obtain this of 105KHz +/- 5KHz
[4]	REC BIAS Current	REC/PB TEST TAPE AC-224 AUX IN: 50mV 400Hz	AUX OUTPUT	REC REC	VR903(L-CH) VR904(R-CH)	Record 400Hz and 10.0kHz alternately, and adjust the bias current adjustment 1. TP1(+) and TP2(GND) Adjust VR903(L-CH) to obtain this of 3.5mV 2. TP3(+) and TP4(GND) Adjust VR904(R-CH) to obtain this of 3.5mV * potentiometer for the playback levels to become the same. (Spec.: +/-5dB)

AMPLIFIER SECTION

NO	ITEM	INPUT SETTING	OUTPUT SETTING	AMPLIFIER SETTING	ALIGNMENT POINT	ALIGN FOR
[1]	IDLE CURRENT	NO SIGNAL VR(Min.)	-	AUX FUNCTION	VR201 VR202	1. R234 Side Pin1 and Pin3 Adjust VR201 to obtain this of +8 mV 1. R301 Side Pin1 and Pin3 Adjust VR202 to obtain this of +8 mV (Spec.: +8mV +/-3mV) # Idle Current: 20mA

Measurement Equipment Connections

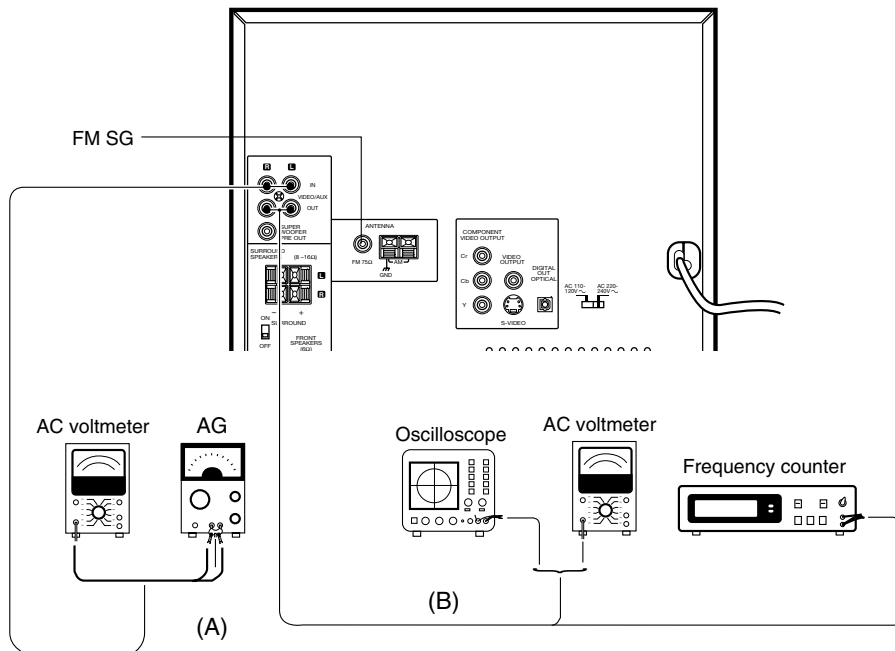

PC BOARD (Component side view)

STANDBY-VIDEO BOARD

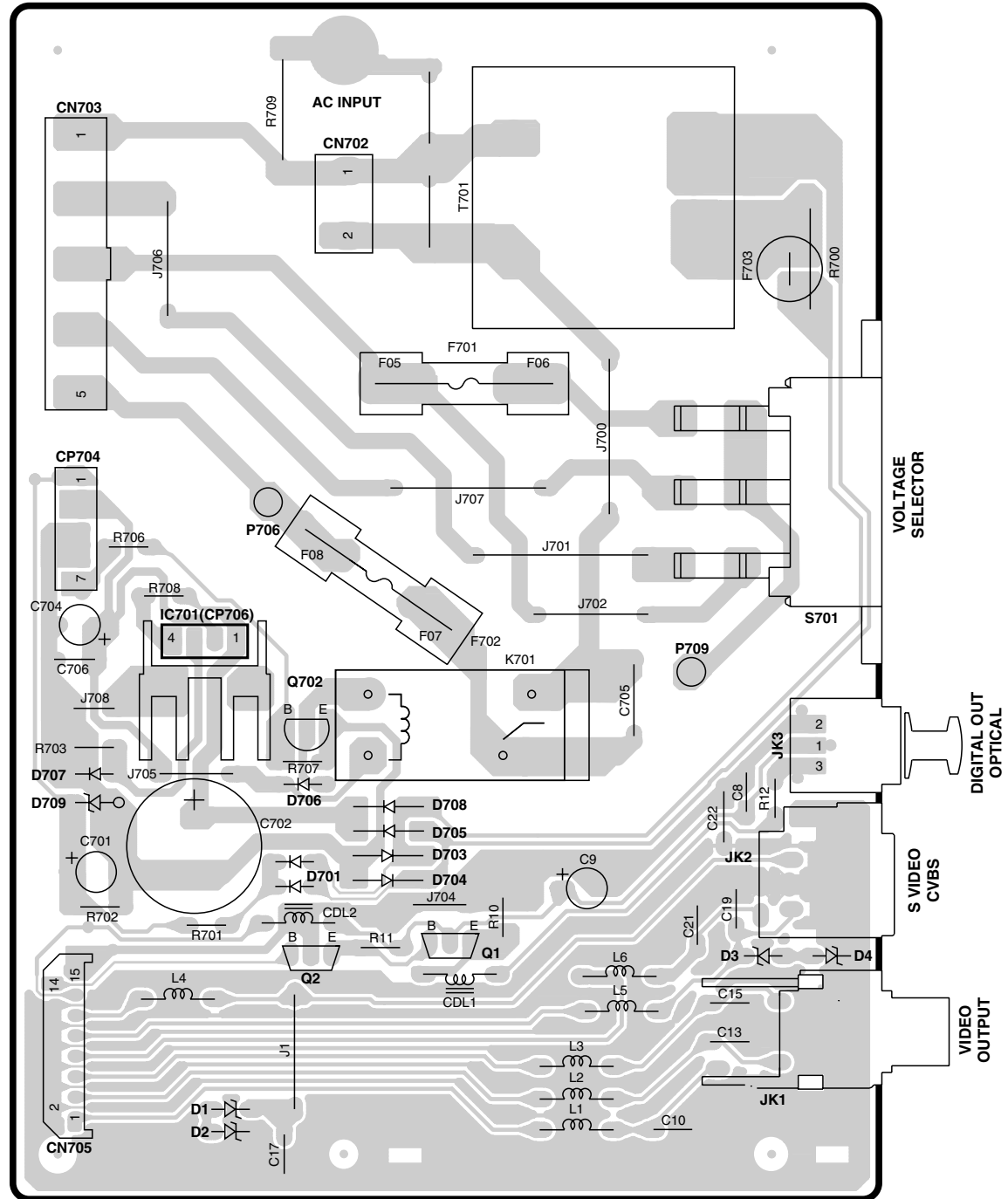

SENSOR BOARD

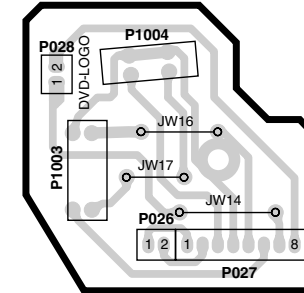

CONTROL BOARD

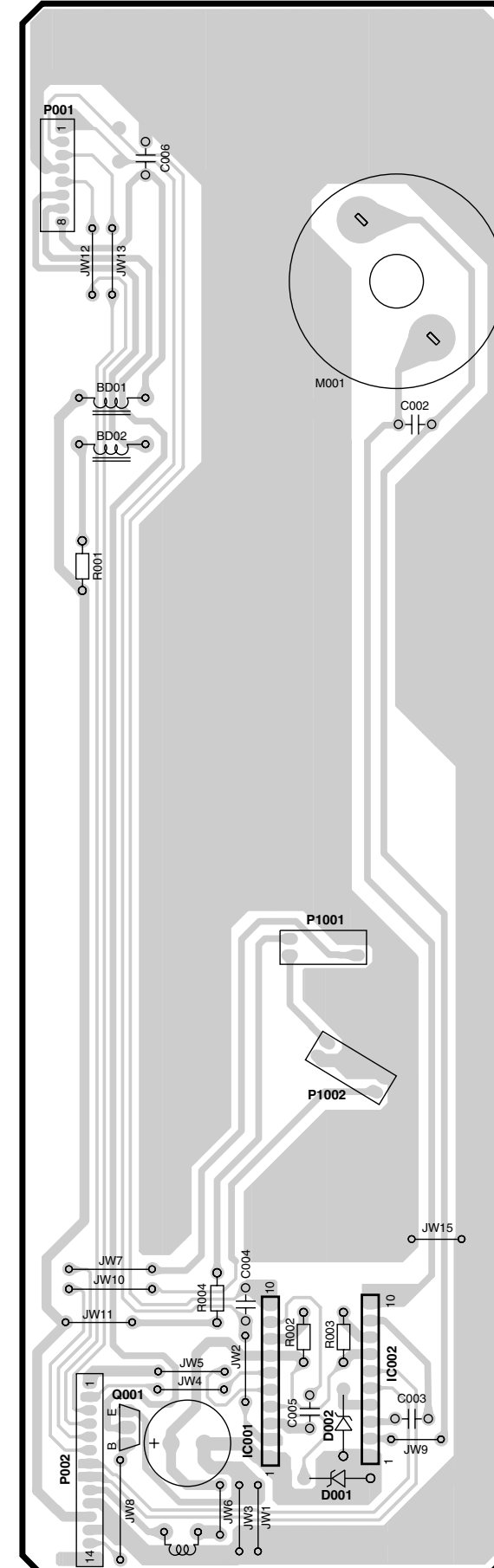

Refer to the schematic diagram for the value of resistors and capacitors.

PC BOARD (Component side view)

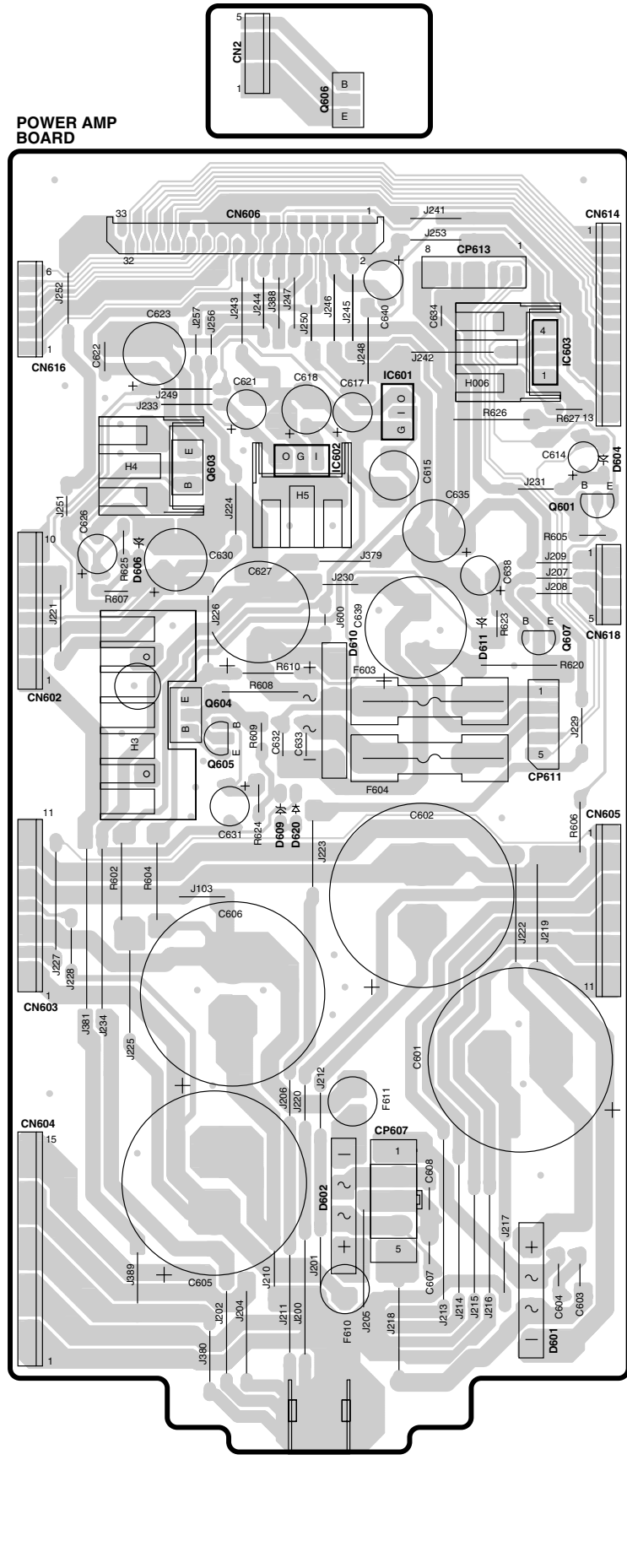
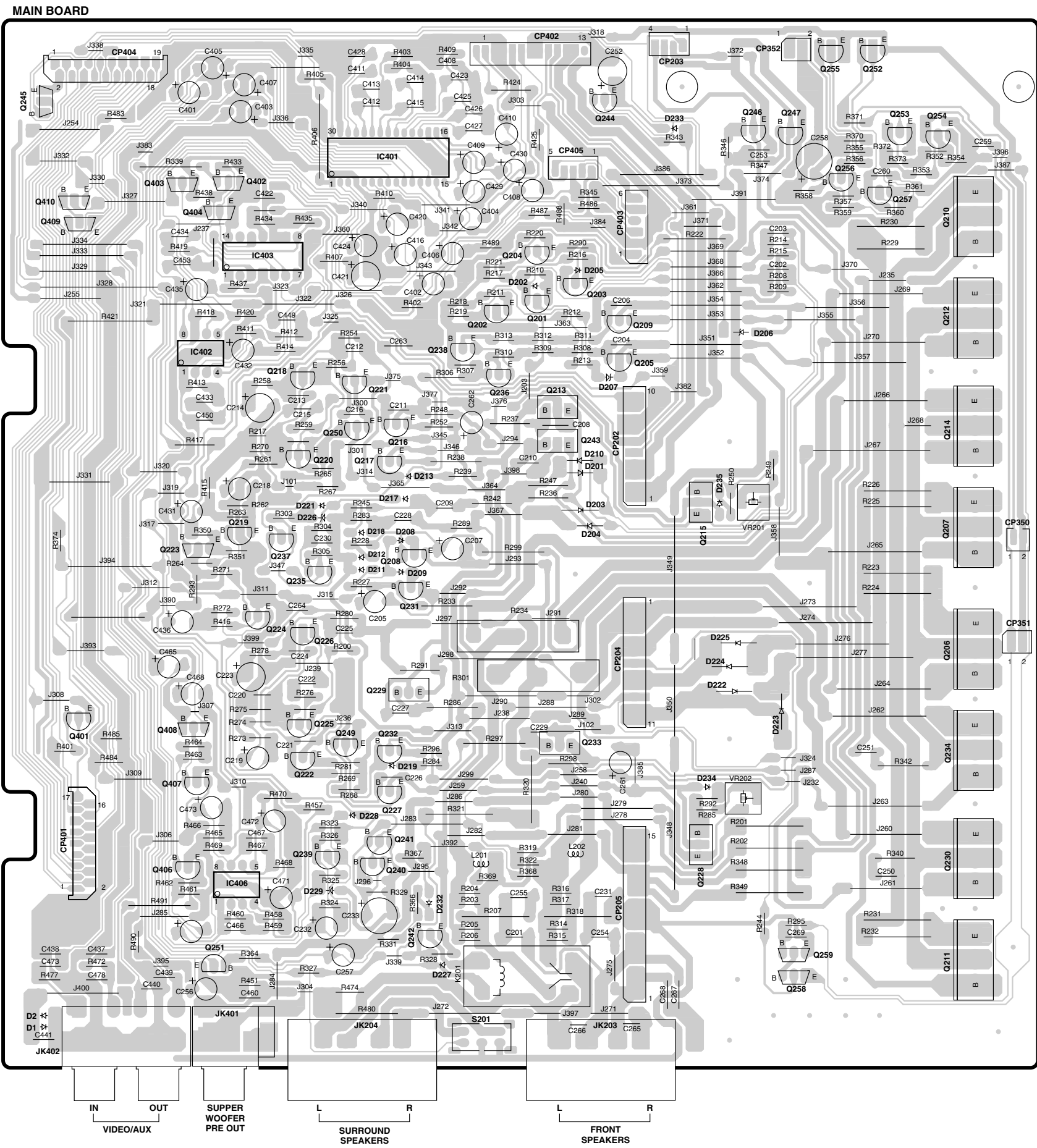

Refer to the schematic diagram for the value of resistors and capacitors.

PC BOARD (Component side view)

DECK BOARD

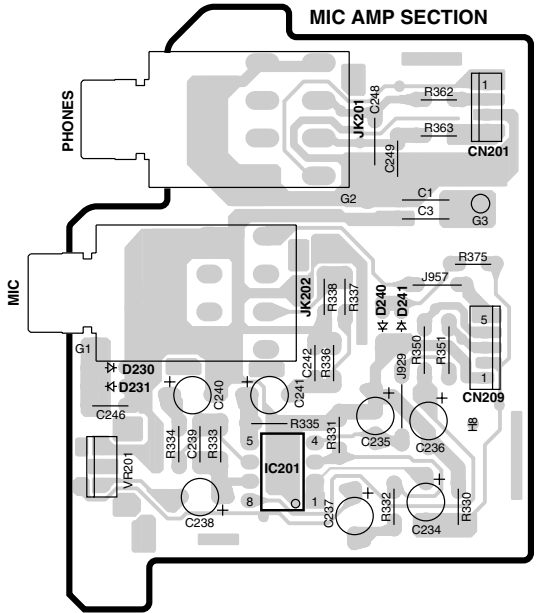
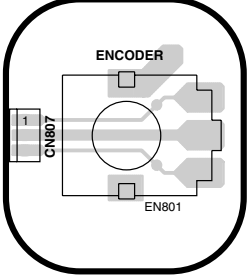
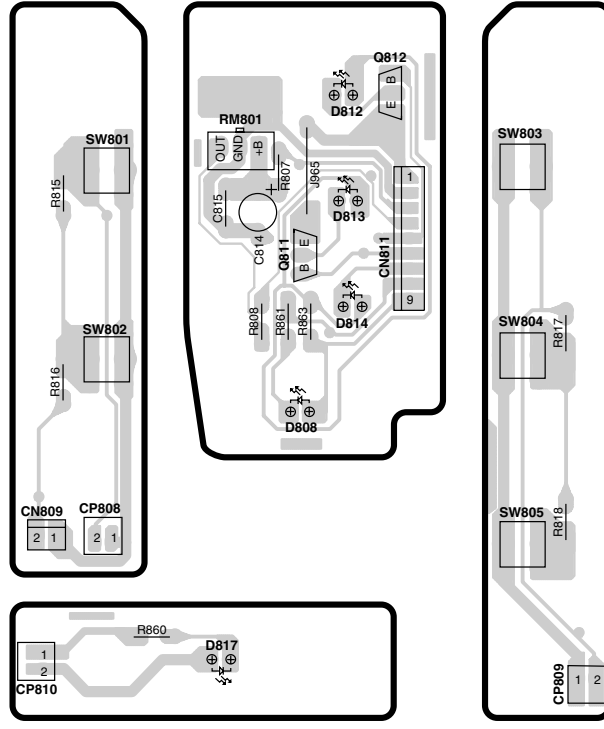
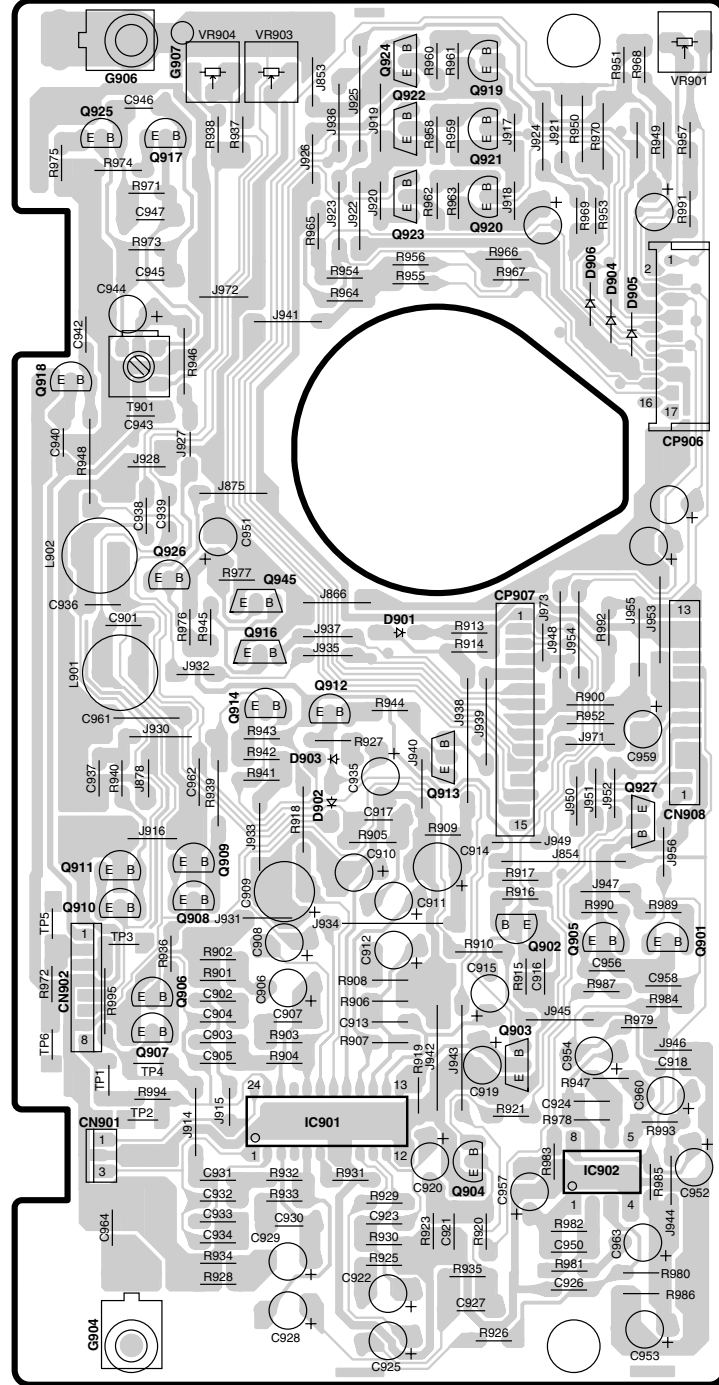

FRONT BOARD

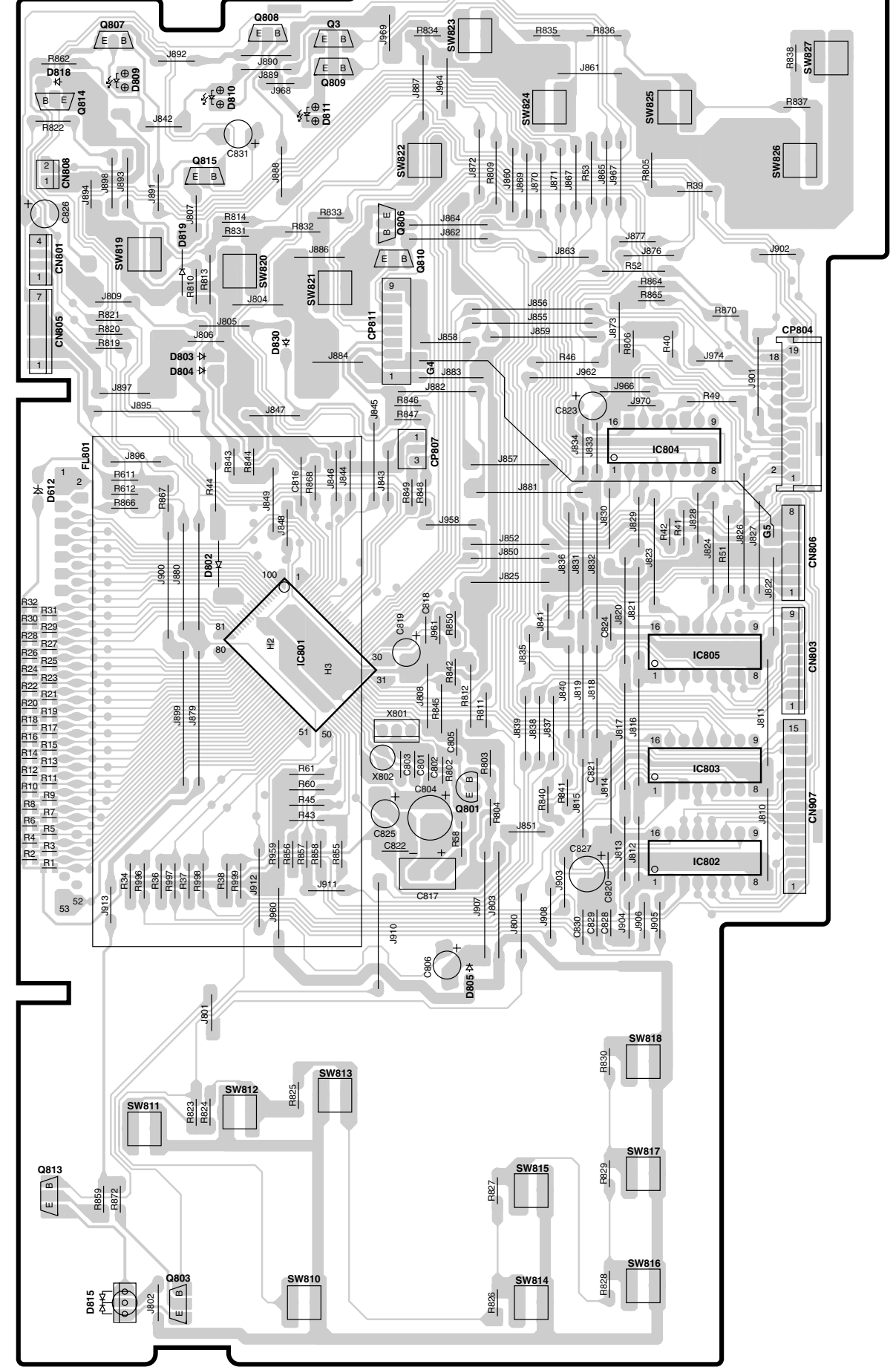

PC BOARD (Component side view)

DVD BOARD

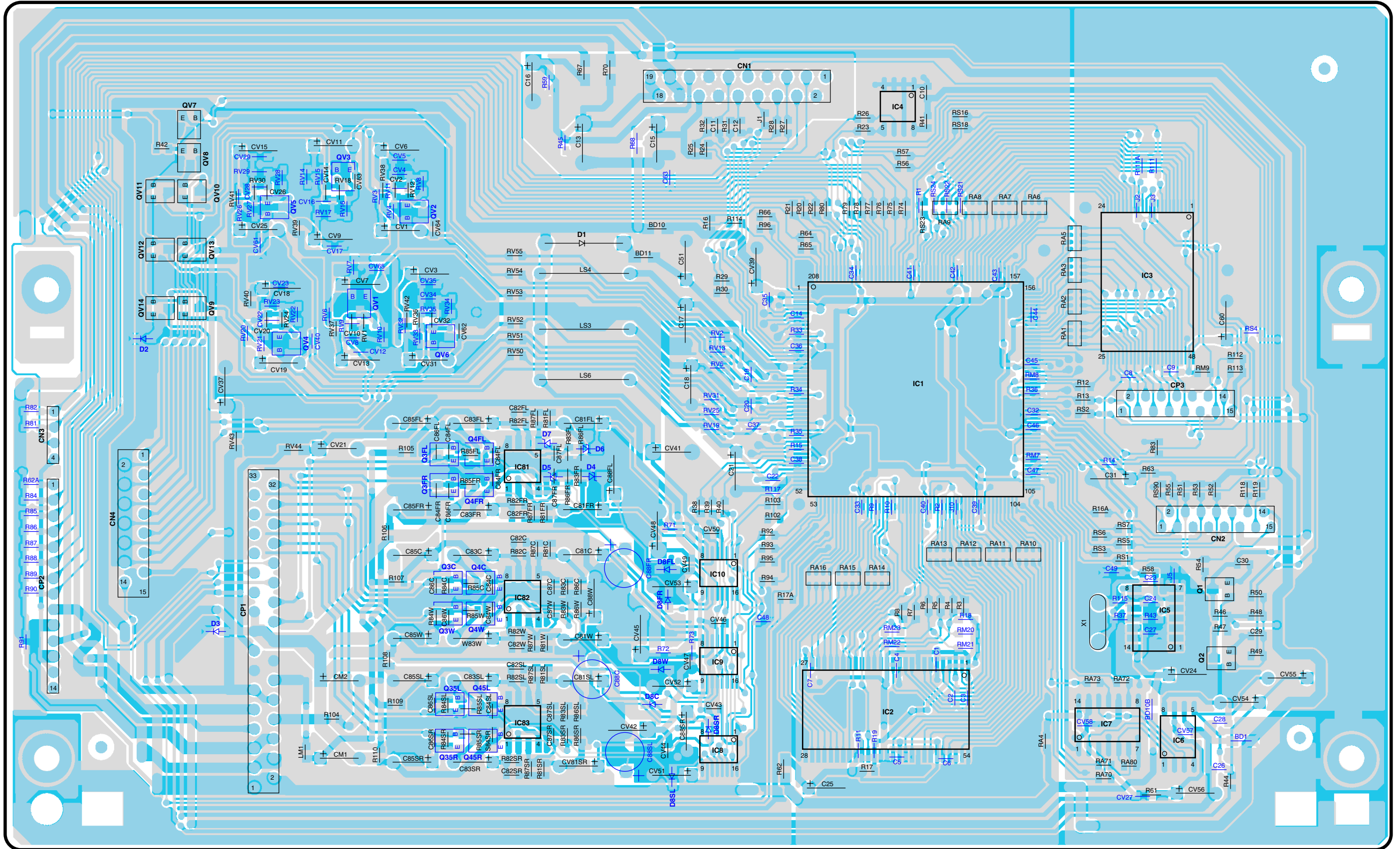

Refer to the schematic diagram for the value of resistors and capacitors.

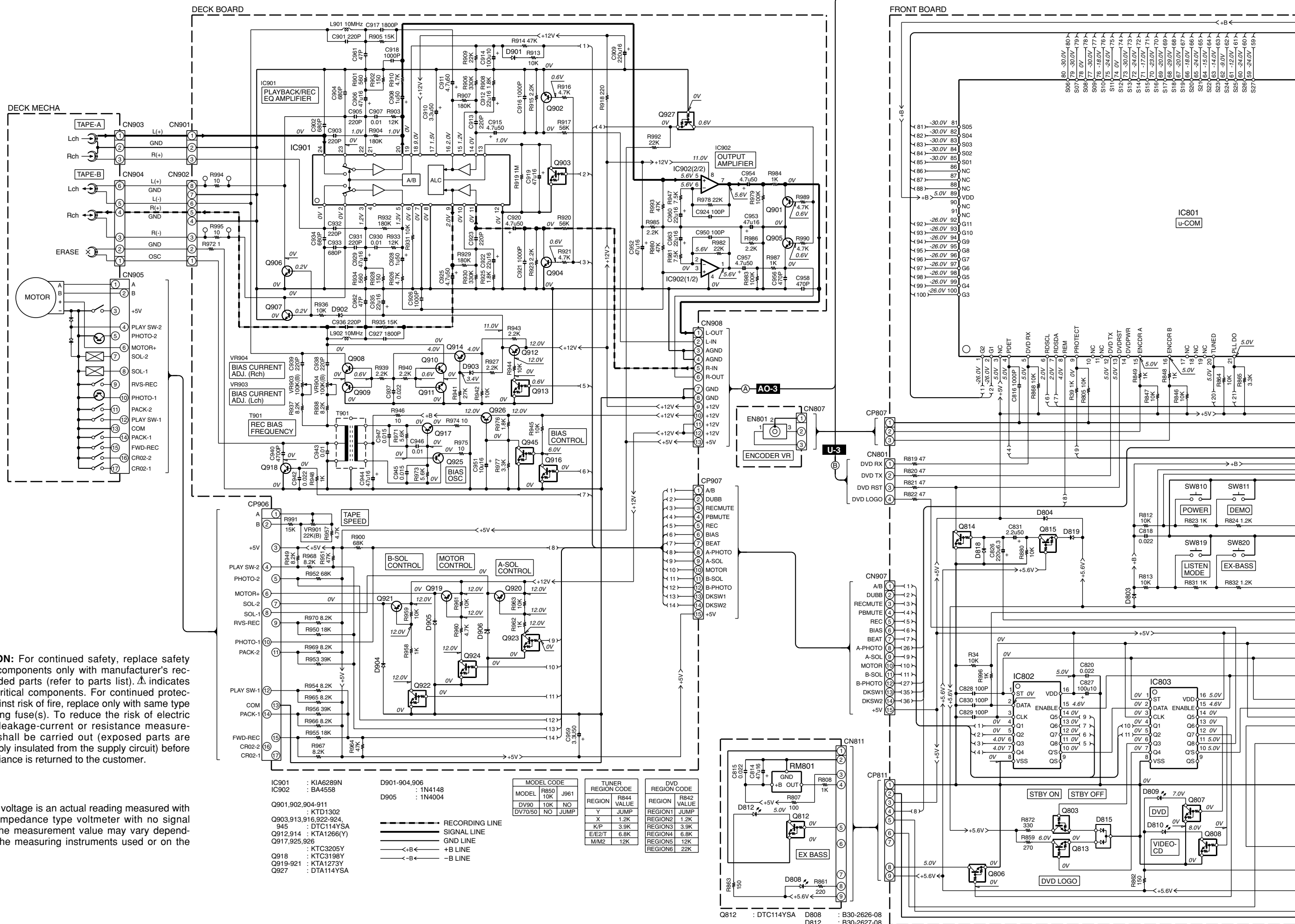

CAUTION: For continued safety, replace safety critical components only with manufacturer's recommended parts (refer to parts list). Δ indicates safety critical components. For continued protection against risk of fire, replace only with same type and rating fuse(s). To reduce the risk of electric shock, leakage-current or resistance measurements shall be carried out (exposed parts are acceptably insulated from the supply circuit) before the appliance is returned to the customer.

The DC voltage is an actual reading measured with a high impedance type voltmeter with no signal input. The measurement value may vary depending on the measuring instruments used or on the product.

IC901 : KIA6289N
 IC902 : BA4558
 Q901,902,904-911 : KTD1302
 Q903,913,916,922-924, 945 : DTC114YSA
 Q912,914 : KTA1266(Y)
 Q917,925,926 : KTC3205Y
 Q918 : KTC3198Y
 Q919-921 : KTA1273Y
 Q927 : DTA114YSA

D901-904,906 : 1N4148
 D905 : 1N4004

--- RECORDING LINE
 --- SIGNAL LINE
 --- GND LINE
 --- +B LINE
 --- -B LINE

MODEL CODE	
MODEL	R844 VALUE
DV90	10K
DV70/50	NO

TUNER REGION CODE	
REGION	R844 VALUE
Y	JUMP
X	1.2K
K/P	3.9K
E/E/Z	6.8K
M/M2	12K

DVD REGION CODE	
REGION	R842 VALUE
REGION1	JUMP
REGION2	1.2K
REGION3	3.9K
REGION4	6.8K
REGION5	12K
REGION6	22K

Q812 : DTC114YSA D808 : B30-2626-08
 D812 : B30-2627-08

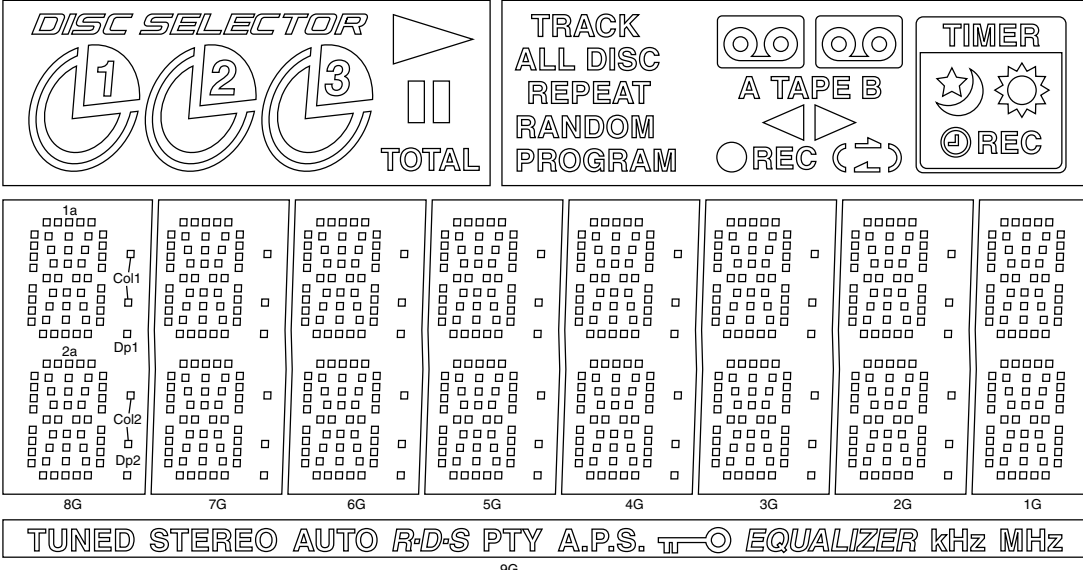
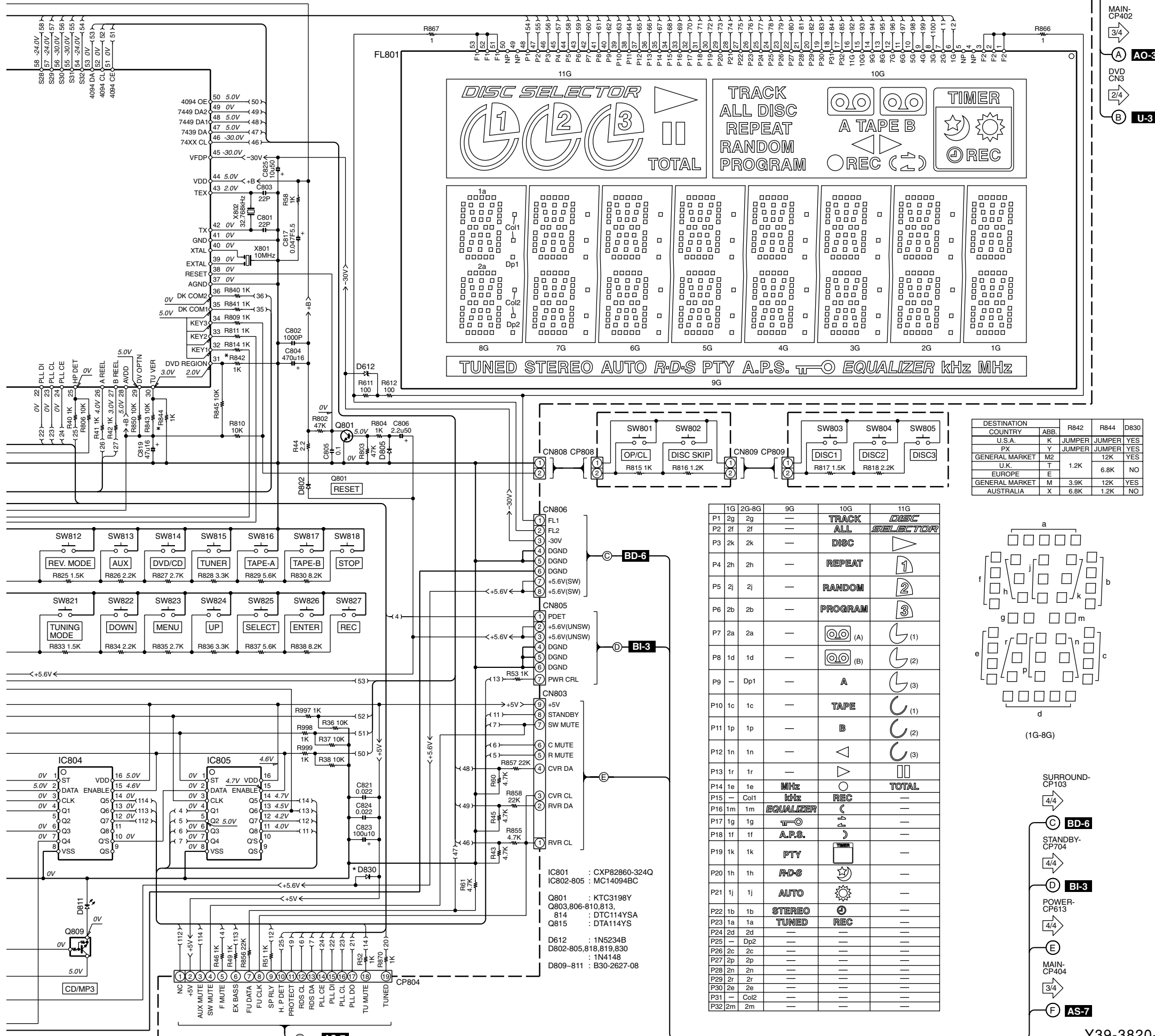

DESTINATION	COUNTRY	ABB.	R842	R844	D830
U.S.A.	K	JUMPER	JUMPER	JUMPER	YES
PX	Y	JUMPER	JUMPER	JUMPER	YES
GENERAL MARKET	M2		12K		YES
U.K.	T		1.2K		
EUROPE	E			6.8K	NO
GENERAL MARKET	M		3.9K	12K	YES
AUSTRALIA	X		6.8K	1.2K	NO

	1G	2G-8G	9G	10G	11G
P1	2g	2g	—	TRACK	DISC SELECTOR
P2	2f	2f	—	ALL	
P3	2k	2k	—	DISC	
P4	2h	2h	—	REPEAT	1
P5	2j	2j	—	RANDOM	2
P6	2b	2b	—	PROGRAM	3
P7	2a	2a	—	(A)	(1)
P8	1d	1d	—	(B)	(2)
P9	—	Dp1	—	A	(3)
P10	1c	1c	—	TAPE	(1)
P11	1p	1p	—	B	(2)
P12	1n	1n	—		(3)
P13	1r	1r	—		
P14	1e	1e	—	MHz	TOTAL
P15	—	Col1	—	kHz	REC
P16	1m	1m	—	EQUALIZER	
P17	1g	1g	—	A.P.S.	
P18	1f	1f	—	PTY	
P19	1k	1k	—	R-D-S	
P20	1h	1h	—	AUTO	
P21	1j	1j	—	STEREO	
P22	1b	1b	—	TUNED	REC
P23	1a	1a	—		
P24	2d	2d	—		
P25	—	Dp2	—		
P26	2c	2c	—		
P27	2p	2p	—		
P28	2n	2n	—		
P29	2r	2r	—		
P30	2e	2e	—		
P31	—	Col2	—		
P32	2m	2m	—		

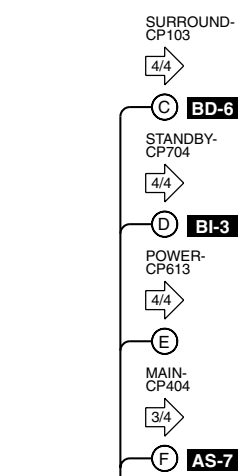
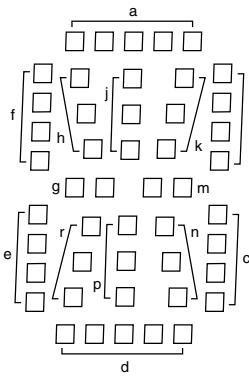

RXD-A850DV/DV50/DV70

Y39-3820-11

KENWOOD

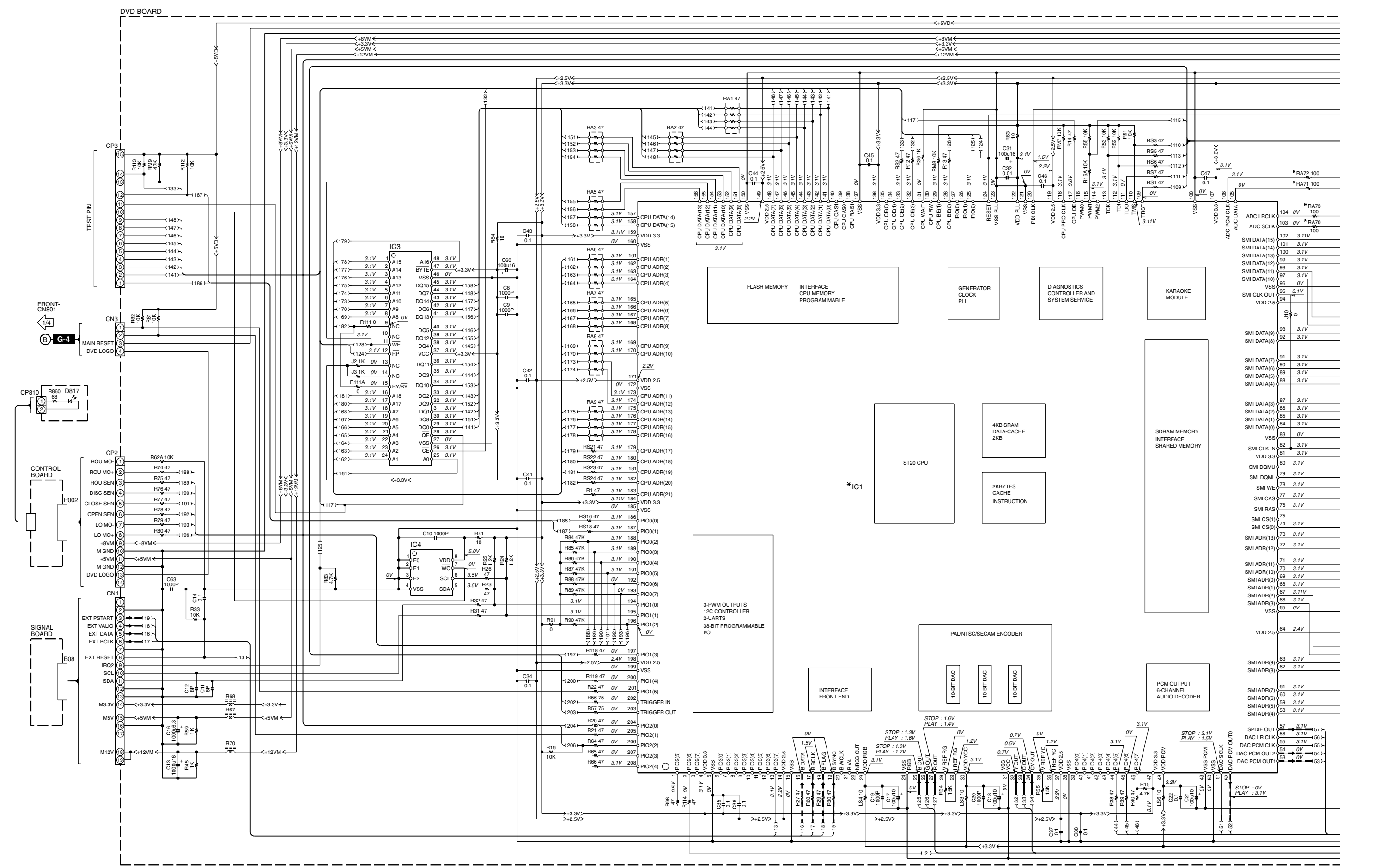

CAUTION: For continued safety, replace safety critical components only with manufacturer's recommended parts (refer to parts list). Δ indicates safety critical components. For continued protection against risk of fire, replace only with same type and rating fuse(s). To reduce the risk of electric shock, leakage-current or resistance measurements shall be carried out (exposed parts are acceptably insulated from the supply circuit) before the appliance is returned to the customer.

The DC voltage is an actual reading measured with a high impedance type voltmeter with no signal input. The measurement value may vary depending on the measuring instruments used or on the product.

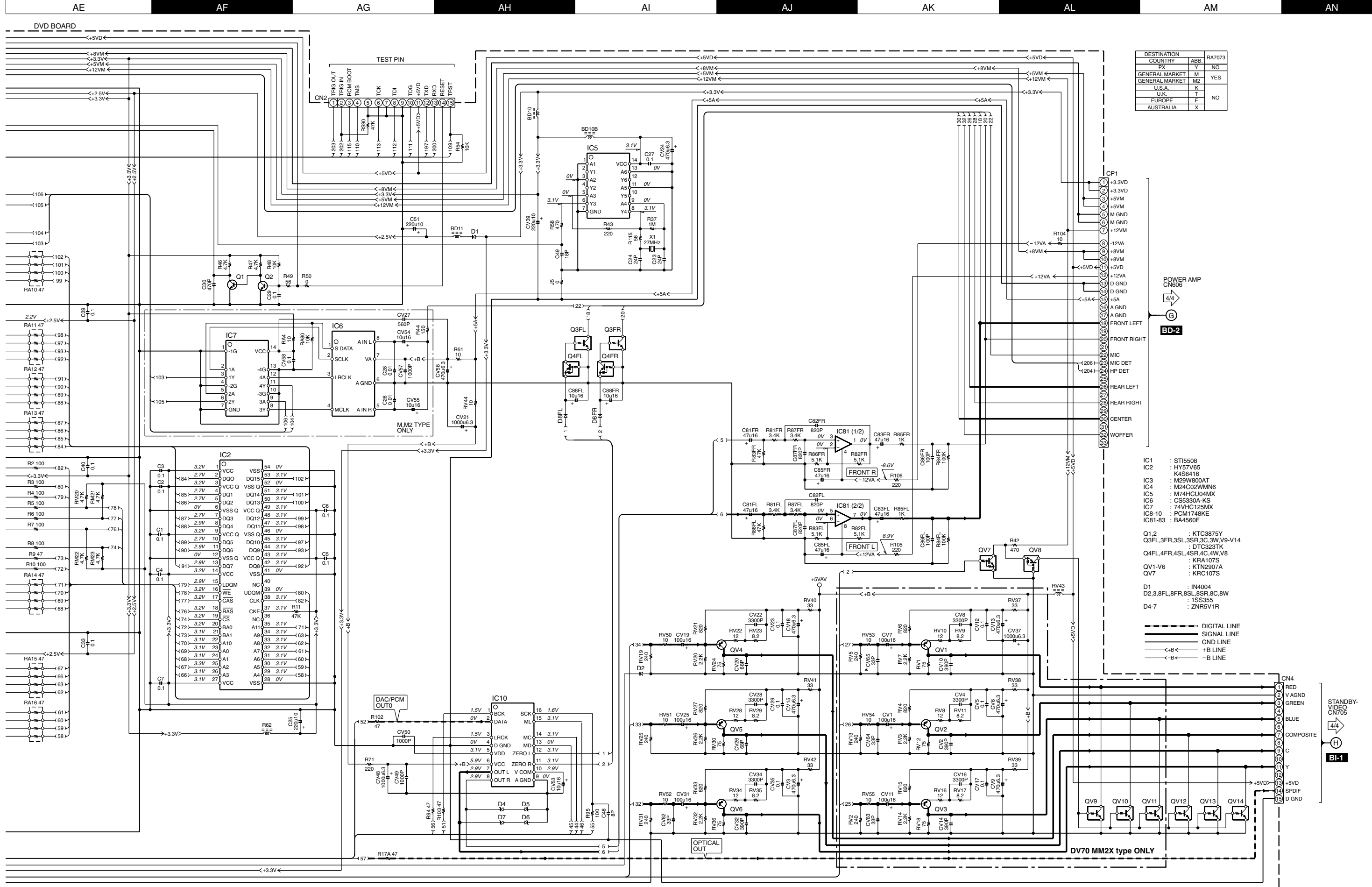

DESTINATION COUNTRY	ABB.	RA7073
PX	Y	NO
GENERAL MARKET	M	YES
GENERAL MARKET	M2	
U.S.A.	K	
U.K.	T	
EUROPE	E	NO
AUSTRALIA	X	

- IC1 : ST1508
- IC2 : HY57V65
K4S6416
- IC3 : M29W800AT
- IC4 : M24C02WMN6
- IC5 : M74HC04MX
- IC6 : CS5330A-KS
- IC7 : 74VHC125MX
- IC8-10 : PCM1748KE
- IC81-83 : BA4560F
- Q1,2 : KTC3875Y
- Q3FL,3FR,3SL,3SR,3C,3W,V9-V14 : DTC323TK
- Q4FL,4FR,4SL,4SR,4C,4W,V8 : KRA107S
- QV1-V6 : KTN2907A
- QV7 : KRC107S
- D1 : IN4004
- D2,3,8FL,8FR,8SL,8SR,8C,8W : 1SS355
- D4-7 : ZNR5V1R

--- DIGITAL LINE
 — SIGNAL LINE
 ... GND LINE
 <+B< +B LINE
 <-B< -B LINE

RXD-A850DV/DV50/DV70 (2/4)

RXD-A850DV/DV50/DV70

Y39-3820-11

KENWOOD

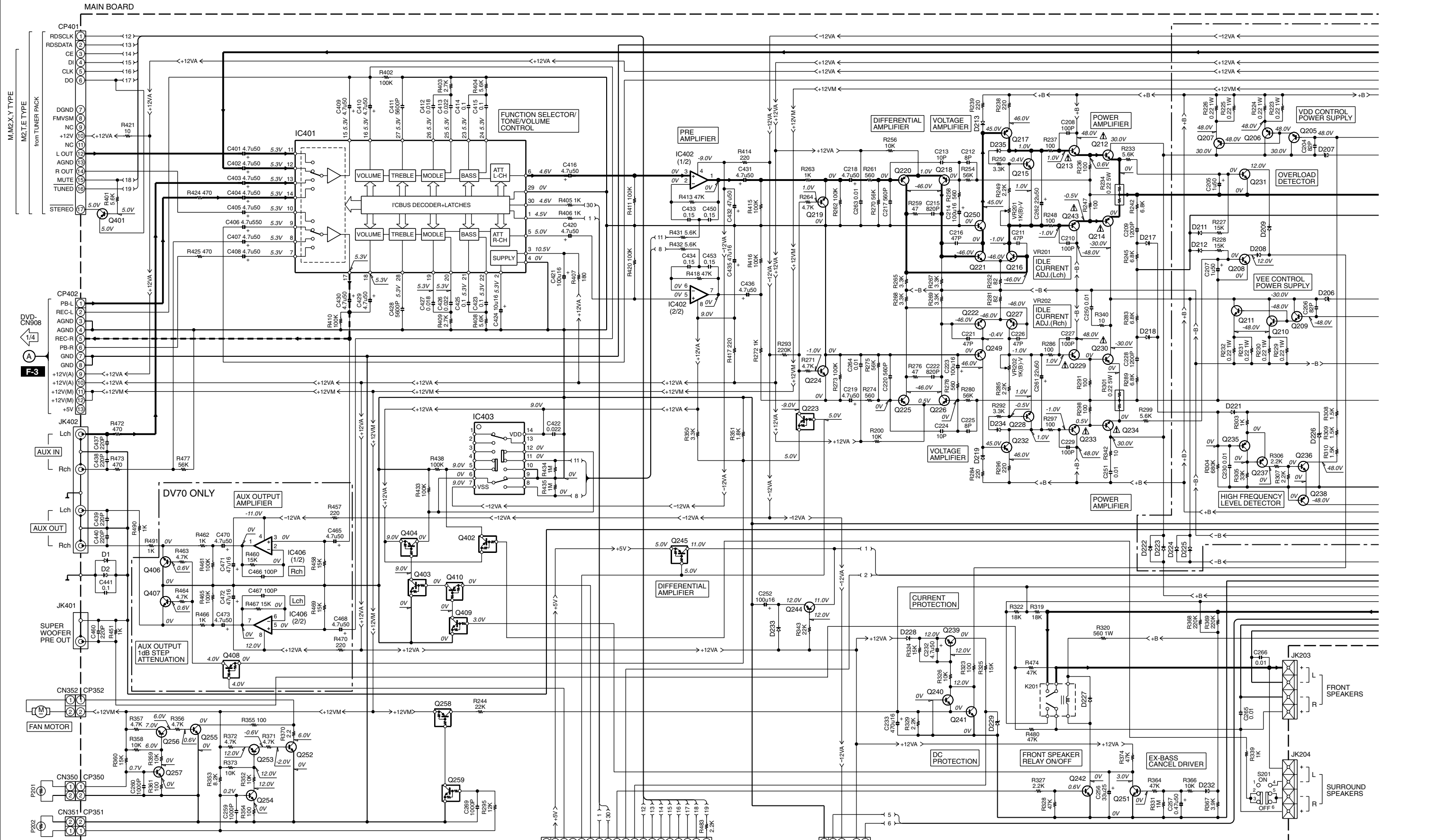

FRONT-CP804

RECORDING LINE
 SIGNAL LINE
 GND LINE
 +B LINE
 -B LINE

CP404

CP405

IC401 : TDA7439D	Q201,202,236,252,255 : KTC3205Y	Q210,211 : 2SC5198	Q223,245,258,404,408,410 : DTA114YSA	D1 : 2.202,205,208,209, 211-213,217-219,221, 227,228,232-235 : 1N4148
IC402,406 : BA4558	Q203,204,217,232,235, 237,238 : KTA1024	Q212,234 : 2SC5200	Q229,243 : 2SA1837	D201,203,204,210 : 1N4004
IC403 : MC14066	Q205 : KTB631K	Q213,233 : 2SC4793	Q239,244,253,256 : KTA1266(Y)	D206,207,229 : MTZ5.1J(B)
	Q206,207 : 2SA1941	Q214,230 : SA1943	Q240,241,251,254,257 : KTA1268	D222-225 : 1N5402
	Q208,216,221,222,227,231, 242,249,250 : KTC3200GR	Q215,228 : 2SC4883A	Q251 : KTC3198Y	D226 : MTZ13J(C)
	Q209 : KTD600K	Q218,220,225,226 : KTA1268	Q259,403,409 : DTC114YSA	
		Q219,224,246,247, 406,407 : KTD1302	Q401 : KTA1266(Y)	

MAIN BOARD

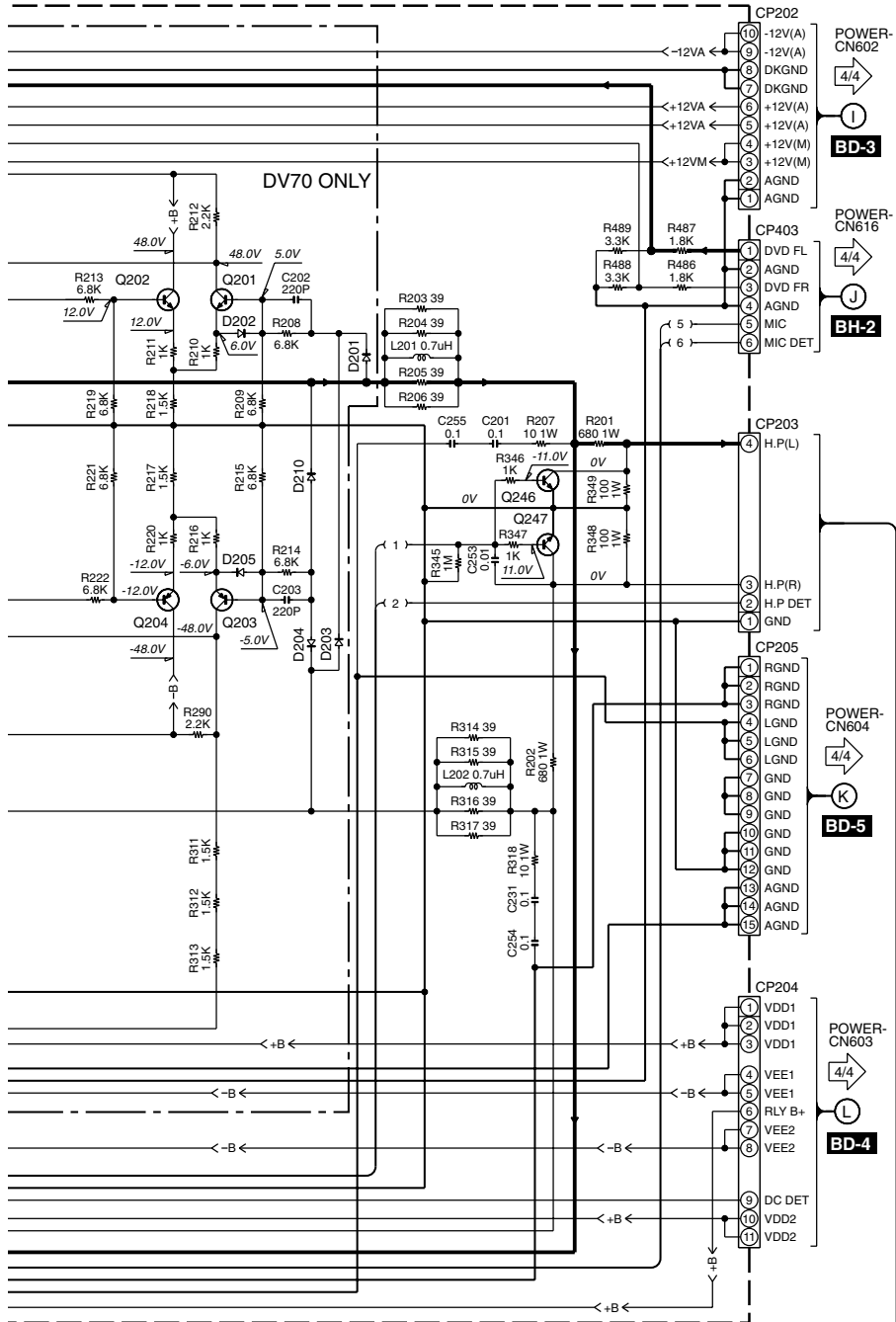

CAUTION: For continued safety, replace safety critical components only with manufacturer's recommended parts (refer to parts list). Δ indicates safety critical components. For continued protection against risk of fire, replace only with same type and rating fuse(s). To reduce the risk of electric shock, leakage-current or resistance measurements shall be carried out (exposed parts are acceptably insulated from the supply circuit) before the appliance is returned to the customer.

The DC voltage is an actual reading measured with a high impedance type voltmeter with no signal input. The measurement value may vary depending on the measuring instruments used or on the product.

MIC AMP SECTION

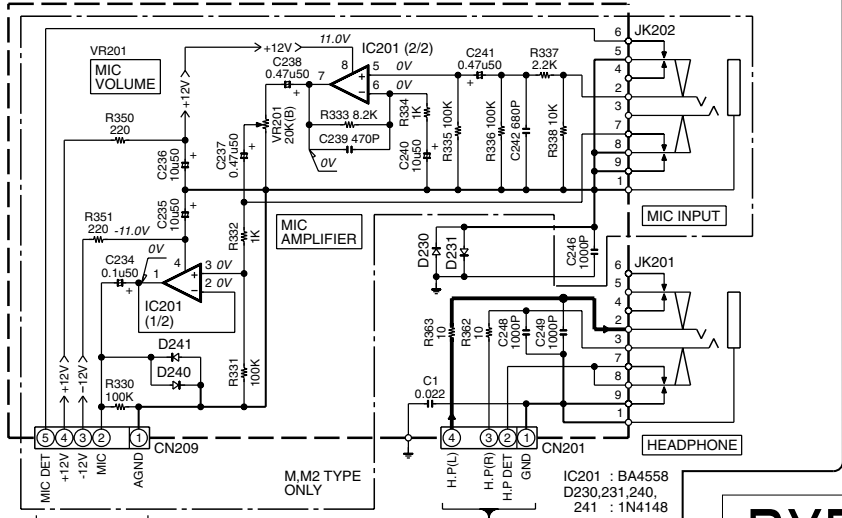

RXD-A850DV/DV50/DV70 (3/4)

RXD-A850DV/DV50/DV70

POWER AMP BOARD

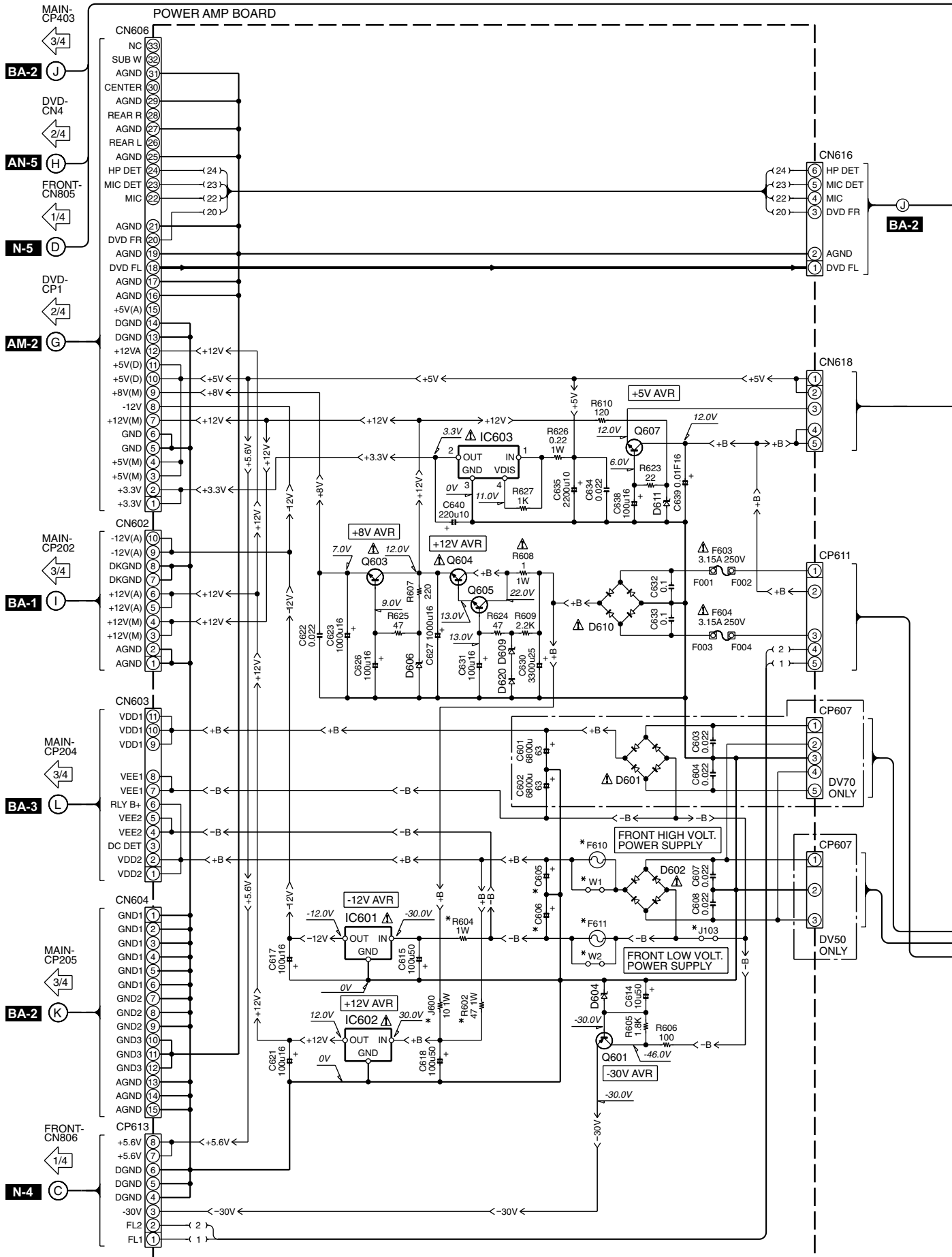

CAUTION: For continued safety, replace safety critical components only with manufacturer's recommended parts (refer to parts list). Δ indicates safety critical components. For continued protection against risk of fire, replace only with same type and rating fuse(s). To reduce the risk of electric shock, leakage-current or resistance measurements shall be carried out (exposed parts are acceptably insulated from the supply circuit) before the appliance is returned to the customer.

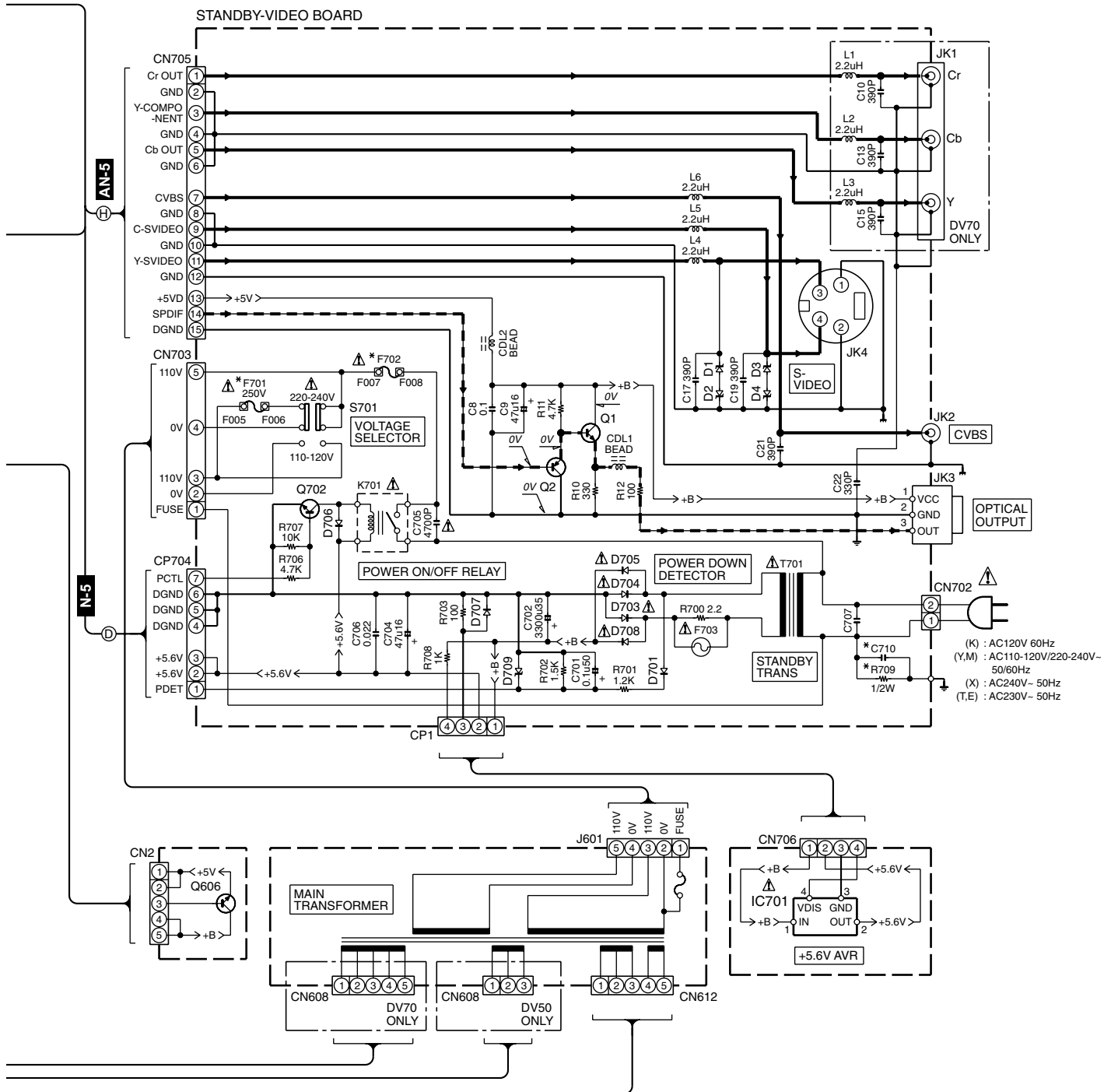

(K) : AC120V 60Hz
 (Y,M) : AC110-120V/220-240V-50/60Hz
 (X) : AC240V- 50Hz
 (T,E) : AC230V- 50Hz

- IC601 : 79M12
- IC602 : 78M12
- IC603 : KA78R33
- IC701 : KA78R05
- Q1,605,607 : KTC3198
- Q2 : KTA1266
- Q601 : KTA1273
- Q603,604,606 : KTD2058
- Q702 : KTC3200
- D1-4,709 : UZ5V1
- D620,701,706,707 : 1SS133
- D601,602 : BU8-04F
- D604 : UZ30V
- D606 : UZ9V1
- D609 : UZ13V
- D610 : BU6-04F
- D611 : UZ6V2
- D703-705,708 : UZV5
- D707 : 1N4004

- DIGITAL LINE
- SIGNAL LINE
- ... GND LINE
- ←+B← +B LINE
- ←-B← -B LINE

RXD-DV50/70 (4/4)

RXD-DV70

DESTINATION COUNTRY	ABB.	C605, 606	C710	F610, 611	F701	F703	F702	J103, 600	R602	R604	R700	R709	S701	W1, 2
PX	Y													
GENERAL MARKET	M				T2.5L	YES	T5.0L 250V 250V						YES	
GENERAL MARKET	M2	4700u50	YES	YES				NO	YES	560		NO	NO	NO
AUSTRALIA	X													
U.K.	T						T2.5L 250V				YES		NO	
EUROPE	E													

RXD-DV50

DESTINATION COUNTRY	ABB.	C605, 606	C710	F610, 611	F701	F703	F702	J103, 600	R602	R604	R700	R709	S701	W1, 2
PX	Y													
GENERAL MARKET	M				T2.0L	YES	T4.0L 250V 250V					NO	NO	YES
GENERAL MARKET	M2	6800u63	NO	NO			S4.0A 125V	YES	NO	1K		3.3M	NO	YES
U.S.A.	K												NO	NO
AUSTRALIA	X													
U.K.	T						T2.0L 250V				YES		YES	
EUROPE	E													

The DC voltage is an actual reading measured with a high impedance type voltmeter with no signal input. The measurement value may vary depending on the measuring instruments used or on the product.

RXD-A850DV/DV50/DV70

EXPLODED VIEW(MECHANISM)

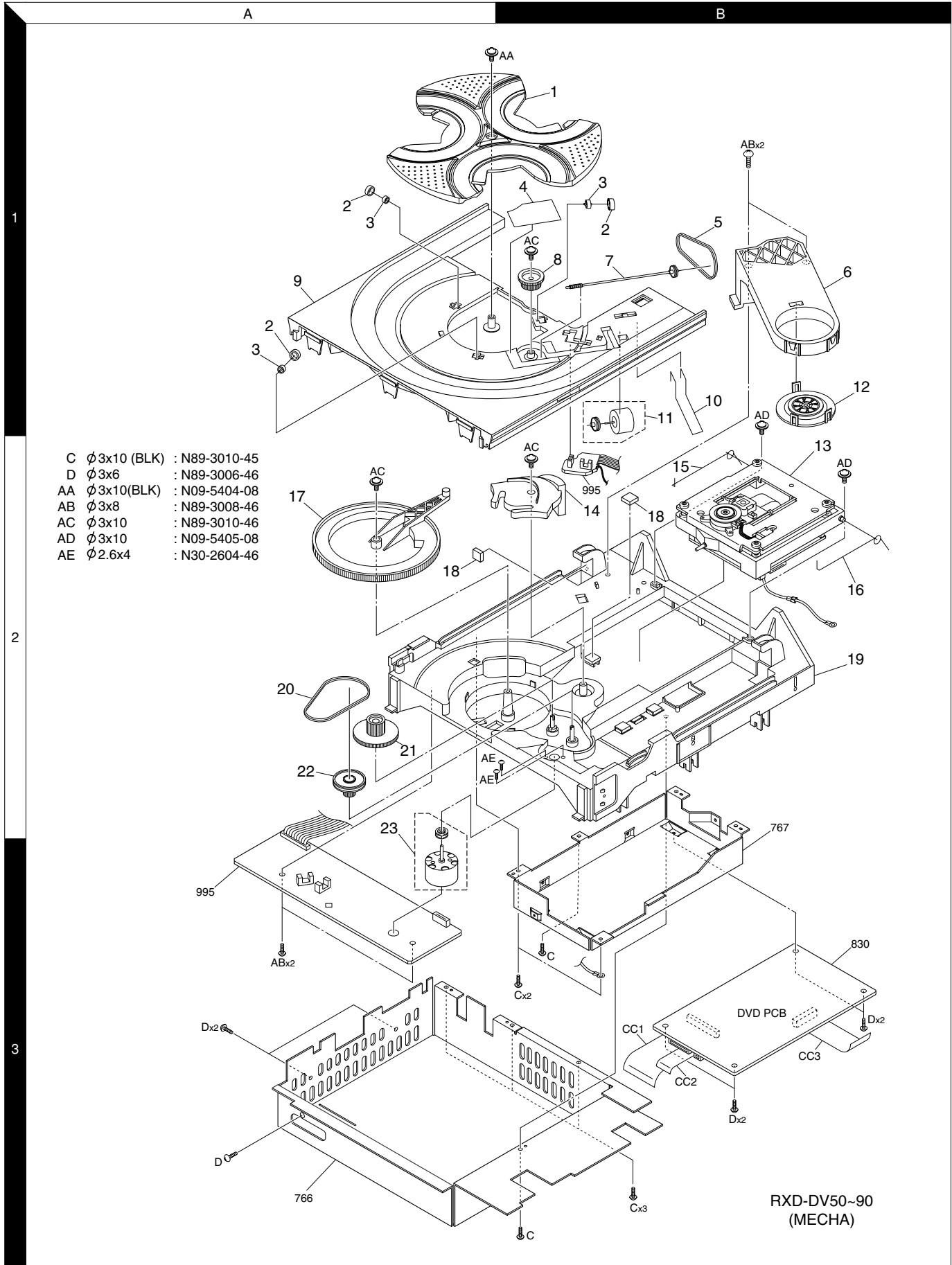

Parts with exploded numbers larger than 700 are not supplied.

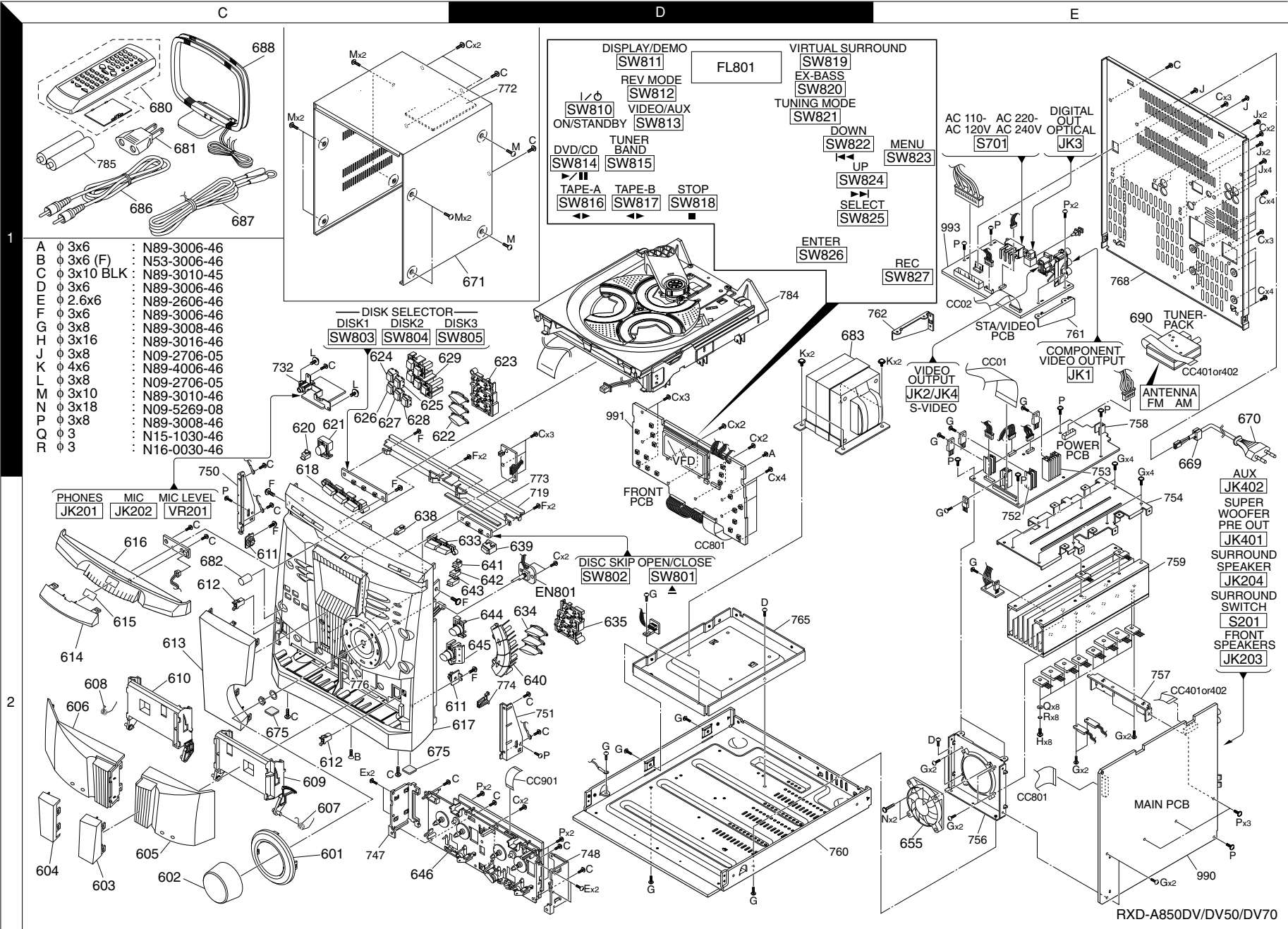

EXPLODED VIEW(UNIT)

RXD-A850DV/DV50/DV70

RXD-A850DV/DV50/DV70

* New Parts
Parts without **Parts No.** are not supplied.
Les articles non mentionnés dans le **Parts No.** ne sont pas fournis.
Teile ohne **Parts No.** werden nicht geliefert.

①

Ref. No	Add-ress	New Parts	Parts No.	Description	Desti-nation	Re-marks
RXD-A850DV/DV50/DV70						
601	2C	*	B01-2575-08	RING VOLUME J85400050000		
602	2C	*	K29-8040-08	KNOB MAIN J85100027000		
603	2C	*	B10-3742-08	WINDOW DECK R DJ85300029010	K	5
603	2C	*	B10-3743-08	WINDOW DECK R DJ85300029020	MM2XTE	
604	2C	*	B10-3740-08	WINDOW DECK L DJ85300028010	K	5
604	2C	*	B10-3741-08	WINDOW DECK L DJ85300028020	MM2XTE	
605	2C	*	A52-0948-08	DOOR DECK R DVDJ85600020000		
606	2C	*	A52-0947-08	DOOR DECK L DVDJ85600019000		
607	2C	*	G02-1739-08	SPRING DECK R DJ65540001400		
608	2C	*	G02-1738-08	SPRING DECK L DJ65540001300		
609	2C	*	A53-2266-08	LID CASSETTE R J85800004000		
610	2C	*	A53-2265-08	LID CASSETTE L J85800003000		
611	2C,2D	*	D39-0356-08	AC ASY GEAR DAM20688960XX		
612	2C	*	J19-6244-08	LATCH PUSH 024AJ6570000100		
613	2C	*	B10-3734-08	WINDOW VFD A850J85300027211	K	5
613	2C	*	B10-3735-08	WINDOW VFD DV50J85300027230	MM2X	5
613	2C	*	B10-3736-08	WINDOW VFD DV50J85300027240	TE	5
613	2C	*	B10-3737-08	WINDOW VFD DV50J85300027250	Y	5
613	2C	*	B10-3824-08	WINDOW VFD DV70J85300027130	MM2X	7
613	2C	*	B10-3825-08	WINDOW VFD DV70J85300027140	T	7
614	2C	*	B10-3738-08	WINDOW DOOR DV9J85400052010	K	5
614	2C	*	B10-3739-08	WINDOW DOOR DV9J85400052020	MM2XTE	
615	2C	*	B19-1637-08	SHEET DVD LOGO J85500009000		
616	2C	*	A22-1864-08	DOOR TRAY DV90 J85600018000		
617	2D	*	A60-2116-08	PANEL FRONT DV7J85000026100	MM2	7
617	2D	*	A60-2208-08	PANEL FRONT DV5J85000026050	K	5
617	2D	*	A60-2209-08	PANEL FRONT DV7J85000026040	YXTE	7
618	2C	*	K29-8031-08	BTN DISC SEL. 3J85200132000		
620	1C	*	B19-1638-08	INDICATOR STBYTJ85400046000	K	5
621	1C	*	K29-8038-08	BTN ON/STANDBY J85200128000	MM2XTE	
622	1C	*	B07-2574-08	CAP DEMO 3KEY J85400045000	K	5
623	1D	*	K29-8033-08	BTN DEMO 3KEY J85200133000	MM2XTE	
624	1C	*	K29-8125-08	DECO FUNCTION-AJ85400051010		
625	1C	*	K29-8092-08	DECO FUNCTION-BJ85400051020		
626	1C	*	K29-8093-08	DECO FUNCTION-CJ85400051030		
627	1C	*	K29-8094-08	DECO FUNCTION-DJ85400051040		
628	1C	*	K29-8095-08	DECO FUNCTION-EJ85400051050		
629	1C	*	K29-8126-08	BTN FUNCTION 5KJ85200131010		
633	2D	*	K29-8037-08	BTN OPEN/CLOSE J85200127000		
634	2D	*	B07-2573-08	CAP LISTEN MODEJ85400044000		
635	2D	*	K29-8034-08	BTN LISTEN MODEJ85200130000	MM2X	7
638	2C	*	B12-0451-08	INDICATOR-VIRTUJ85400047030		
639	2D	*	B12-0452-08	INDI.BASS/BOOSTJ85400049000		
640	2D	*	K29-8032-08	BTN ROUND 4KEYJ85200134000		
641	2D	*	B12-0453-08	INDICATOR-DVD J85400048010		
642	2D	*	B12-0454-08	INDICATOR-VCD J85400048020		
643	2D	*	B12-0455-08	INDICATOR-CD J85400048030		
644	2D	*	K29-8039-08	BTN MENU 1KEY J85200129000	YXTE	
645	2D	*	K29-8036-08	BTN REC 1KEY J85200126000		
646	2C	*	D40-1740-08	DECK MECHA (CMAJ57112001002)		
655	2E	*	T43-0076-08	FAN RDH6015S C155157770XX		
669	1E	*	J42-0350-08	BUSHING-AC CORDJ65100000100		
670	1E	*	E30-2991-08	CORD POWER UL SJ43730100100	KY	

L : Scandinavia K : USA P : Canada R : Mexico C : China I : Malaysia
Y : PX(Far East,Hawaii) T : England E : Europe G : Germany V : China(Shanghai)
Y : AAFES(Europe) X : Australia Q : Russia H : Korea M : Other Areas Δ indicates safety critical components .

* New Parts
Parts without **Parts No.** are not supplied.
Les articles non mentionnés dans le **Parts No.** ne sont pas fournis.
Teile ohne **Parts No.** werden nicht geliefert.

②

Ref. No	Add-ress	New Parts	Parts No.	Description	Desti-nation	Re-marks
Δ 670	1E	*	E30-2992-08	CORD POWER EU 2J43731100000	MM2E	
Δ 670	1E	*	E30-2994-08	CORD POWER AU CJ43733100100	X	
Δ 670	1E	*	E30-7249-08	WIRE-MCRDM 0.7055175210XX	T	
671	1D	*	A52-0949-08	COVER TOP DV90 J60100011000		
675	2C	*	J02-1537-08	RUBBER FOOT J85900508000		
680	1C	*	A70-1533-08	REMOCON DV90K J54000001800	KYX	
680	1C	*	A70-1534-08	REMOCON DV90E J54000001900	TE	
680	1C	*	A70-1535-08	REMOCON DV90M J54000002000	MM2	
681	1C	*	E03-0115-05	ADDPTR AC PLUGJ44291200109	MM2	
682	2C	*	K29-8041-08	KNOB MIC LEVEL J85100028000	MM2	
Δ 683	1D	*	L07-3121-08	POWER TRANS 110J2801710031X	YMM2	5
Δ 683	1D	*	L07-3131-08	POWER TRANS 110J2801710021X	MM2	7
Δ 683	1D	*	L07-3162-08	PWR TRANS 120/6J2801210021X	K	5
Δ 683	1D	*	L07-3163-08	POWER TRANS 230J2801410031X	T	5
Δ 683	1D	*	L07-3164-08	PWR TRANS 230/5J2801410041X	TE	5
Δ 683	1D	*	L07-3165-08	POWER TRANS 240J2801510031X	X	7
Δ 683	1D	*	L07-3166-08	PWR TRANS 240/5J2801510041X	X	5
686	1C	*	E30-1427-05	CORD RCA 1P Y 1J94310009000		
687	1C	*	T90-0881-08	ANTENNA WIRE CT55127480NR		
688	1C	*	T90-0882-08	ANTENNA WIRE CT55127470NR		
690	1E	*	W02-2908-08	TUNER KST-MB011J4099100260X	KY	
690	1E	*	W02-2909-08	TUNER KST-MB011J4099100270X	MM2X	
690	1E	*	W02-2910-08	TUNER KST-MB114J4099100280X	TE	
-	-	*	B60-4908-08	INST MANUAL(SC)J90200018100	M	
-	-	*	B60-4909-08	INST MANUAL(AR)J90200018110	M2	
-	-	*	B60-4910-08	INST MANUAL(ES)J90200018120	E	
-	-	*	B60-4911-08	INST MANUAL(EN)J90200018130	KMM2XT	
-	-	*	B60-4912-08	INST MANUAL(PL)J90200018140	KE	
-	-	*	B60-4913-08	INST MANUAL(HU)J90200018150	E	
-	-	*	B60-4914-08	INST MANUAL(CZ)J90200018160	E	
-	-	*	B60-4915-08	INST MANUAL(RU)J90200018170	E	
-	-	*	H25-1712-08	POLY BAG PE T0.J97000002000		
-	-	*	H50-3962-08	BOX OUT DV50M J96000037310	M	5
-	-	*	H50-3963-08	BOX OUT DV50M2 J96000037320	M2	5
-	-	*	H50-3965-08	BOX OUT DV50E J96000037350	E	5
-	-	*	H50-3966-08	BOX OUT DV50X J96000037330	X	5
-	-	*	H50-3967-08	BOX OUT DV70M J96000037170	M	7
-	-	*	H50-3968-08	BOX OUT DV70M2 J96000037180	M2	7
-	-	*	H50-3971-08	BOX OUT DV70X J96000037200	X	7
-	-	*	H50-4026-08	BOX OUT DV50K J96000037290	K	5
-	-	*	H50-4027-08	BOX OUT DV50T J96000037340	T	5
N	-	-	N09-5269-08	SCREW TAP 3.0*1J80600031810		
MAIN/POWER AMP						
C201			CQ93FMG1H104J	MYLAR 0.10UF	J	
C202,203			C91-0749-05	CERAMIC 220PF	K	7
C204			CC45FCH1H820J	CERAMIC 82PF	K	7
C205			CE04LW1H010M	ELECTRO 1.0UF	50WV	
C206			CC45FCH1H820J	CERAMIC 82PF	K	7
C207			CE04LW1H010M	ELECTRO 1.0UF	50WV	
C208			CK45FB1H101K	CERAMIC 100PF	K	
C209			CQ93FMG1H122J	MYLAR 1200PF	J	7
C210			CK45FB1H101K	CERAMIC 100PF	K	
C211			C91-0737-05	CERAMIC 47PF	J	

L : Scandinavia K : USA P : Canada R : Mexico C : China I : Malaysia
Y : PX(Far East,Hawaii) T : England E : Europe G : Germany V : China(Shanghai)
Y : AAFES(Europe) X : Australia Q : Russia H : Korea M : Other Areas Δ indicates safety critical components .

PARTS LIST

RXD-A850DV/DV50/DV70

* New Parts
Parts without **Parts No.** are not supplied.
Les articles non mentionnés dans le **Parts No.** ne sont pas fournis.
Teile ohne **Parts No.** werden nicht geliefert.

3

Ref. No	Add-ress	New Parts	Parts No.	Description	Desti-nation	Re-marks
C212			CC45FCH1H080D	CERAMIC 8.0PF	D	
C213			C91-0721-05	CERAMIC 10PF	J	
C214			CE04LW1C101M	ELECTRO 100UF	16WV	
C215			CK45FB1H821K	CERAMIC 820PF	K	
C216			C91-0737-05	CERAMIC 47PF	J	
C217			CK45FB1H561K	CERAMIC 560PF	K	
C218,219			CE04LW1H4R7M	ELECTRO 4.7UF	50WV	
C220			CK45FB1H561K	CERAMIC 560PF	K	
C221			C91-0737-05	CERAMIC 47PF	J	
C222			CK45FB1H821K	CERAMIC 820PF	K	
C223			CE04LW1C101M	ELECTRO 100UF	16WV	
C224			C91-0721-05	CERAMIC 10PF	J	
C225			CC45FCH1H080D	CERAMIC 8.0PF	D	
C226			C91-0737-05	CERAMIC 47PF	J	
C227			CK45FB1H101K	CERAMIC 100PF	K	
C228			CQ93FMG1H122J	MYLAR 1200PF	J	7
C229			CK45FB1H101K	CERAMIC 100PF	K	
C230			C91-0769-05	CERAMIC 0.010UF	K	7
C231			CQ93FMG1H104J	MYLAR 0.10UF	J	
C232			CE04LW1H4R7M	ELECTRO 4.7UF	50WV	
C233			CE04LW1C471M	ELECTRO 470UF	16WV	
C250,251			C91-0769-05	CERAMIC 0.010UF	K	7
C250,251			JUMPER WIRE	BCL 0.5MM TIN A20330130XX		5
C252			CE04LW1C101M	ELECTRO 100UF	16WV	
C253			C91-0769-05	CERAMIC 0.010UF	K	
C254,255			CQ93FMG1H104J	MYLAR 0.10UF	J	
C256			CE04LW1E330M	ELECTRO 33UF	25WV	
C257			CE04LW1HR47M	ELECTRO 0.47UF	50WV	
C259,260			C91-0757-05	CERAMIC 1000PF	K	
C261,262			CE04LW1H220M	ELECTRO 22UF	50WV	
C263,264			C91-0769-05	CERAMIC 0.010UF	K	
C265,266			CK45FB1H103K	CERAMIC 0.010UF	K	
C269			CK45FB1H102K	CERAMIC 1000PF	K	
C401-410			CE04LW1H4R7M	ELECTRO 4.7UF	50WV	
C411			CQ93FM1H562K	MYLAR 5600PF	K	
C412			CQ93FMG1H183J	MYLAR 0.018UF	J	
C413			CQ93FM1H223K	MYLAR 0.022UF	K	
C414,415			CQ93FMG1H104J	MYLAR 0.10UF	J	
C416			CE04LW1H4R7M	ELECTRO 4.7UF	50WV	
C420			CE04LW1H4R7M	ELECTRO 4.7UF	50WV	
C421			CE04LW1C101M	ELECTRO 100UF	16WV	
C422			CK45FB1E223Z	CERAMIC 0.022UF	Z	
C423			CQ93FMG1H104J	MYLAR 0.10UF	J	
C424			CE04LW1C100M	ELECTRO 10UF	16WV	
C425			CQ93FMG1H104J	MYLAR 0.10UF	J	
C426			CQ93FM1H223K	MYLAR 0.022UF	K	
C427			CQ93FMG1H183J	MYLAR 0.018UF	J	
C428			CQ93FM1H562K	MYLAR 5600PF	K	
C429-431			CE04LW1H4R7M	ELECTRO 4.7UF	50WV	
C432			CE04LW1C470M	ELECTRO 47UF	16WV	
C432			CE04LW1H4R7M	ELECTRO 4.7UF	50WV	7
C433,434			CQ93FMG1H154J	MYLAR 0.15UF	J	
C435			CE04LW1C470M	ELECTRO 47UF	16WV	
C436			CE04LW1H4R7M	ELECTRO 4.7UF	50WV	
C437-440			C91-0749-05	CERAMIC 220PF	K	

L : Scandinavia K : USA P : Canada R : Mexico C : China I : Malaysia
Y : PX(Far East,Hawaii) T : England E : Europe G : Germany V : China(Shanghai)
Y : AAFES(Europe) X : Australia Q : Russia H : Korea M : Other Areas Δ indicates safety critical components.

* New Parts
Parts without **Parts No.** are not supplied.
Les articles non mentionnés dans le **Parts No.** ne sont pas fournis.
Teile ohne **Parts No.** werden nicht geliefert.

4

Ref. No	Add-ress	New Parts	Parts No.	Description	Desti-nation	Re-marks
C441			CK45FB1E104Z	CERAMIC 0.10UF	Z	
C449			CQ93FM1H223K	MYLAR 0.022UF	K	
C450			CQ93FM1H154K	MYLAR 0.15UF	K	
C453			CQ93FM1H154K	MYLAR 0.15UF	K	
C460			C91-0749-05	CERAMIC 220PF	K	
C465			CE04LW1H4R7M	ELECTRO 4.7UF	50WV	7
C466,467			C91-0745-05	CERAMIC 100PF	K	7
C468			CE04LW1H4R7M	ELECTRO 4.7UF	50WV	7
C470			CE04LW1H4R7M	ELECTRO 4.7UF	50WV	7
C471,472			CE04LW1C470M	ELECTRO 47UF	16WV	7
C473			CE04LW1H4R7M	ELECTRO 4.7UF	50WV	7
C601,602		*	C90-5743-08	ELECTRO 6800UF	63WV	5
C603,604		*	C91-1644-08	CP MET 0.1UF	250V	
C605,606		*	C90-5743-08	ELECTRO 6800UF	63WV	
C605,606		*	C90-5744-08	ELECTRO 4700UF	50WV	7
C607,608			CQ93FM1H223K	MYLAR 0.022UF	K	
C614,615			CE04LW1H101M	ELECTRO 100UF	50WV	
C617,618			CE04LW1C101M	ELECTRO 100UF	16WV	
C621			CE04LW1C101M	ELECTRO 100UF	16WV	
C622			CK45FB1E223Z	CERAMIC 0.022UF	Z	
C623			CE04KW1C102M	ELECTRO 1000UF	16WV	
C626			CE04LW1C101M	ELECTRO 100UF	16WV	
C627			CE04KW1C102M	ELECTRO 1000UF	16WV	
C630			CE04KW1E332M	ELECTRO 3300UF	25WV	
C631			CE04LW1C101M	ELECTRO 100UF	16WV	
C632,633			CQ93FM1H223K	MYLAR 0.022UF	K	
C634			CK45FB1E223Z	CERAMIC 0.022UF	Z	
C635			CE04LW1A222M	ELECTRO 2200UF	10WV	
C638			CE04LW1C101M	ELECTRO 100UF	16WV	
C639		*	C90-5748-08	CE SHL 10000UF/J3420610336X		
C640			CE04LW1A221M	ELECTRO 220UF	10WV	
CC401	1E,2E	*	E35-3203-08	FPC CABLE 17P 1J4112171701X	TE	
CC402	1E,2E	*	E35-3016-08	FPC CABLE 15P 1J4112151501X	KYMM2X	
CN606		*	E35-3017-08	CON(FPC) 1.25MM 55129060XX		
CP401		*	E41-0797-08	CON(FPC) 1.25MM55124800XX	KYMM2X	
CP401		*	E41-0798-08	CON(FPC) 1.25MM55124810XX	TE	
CP404		*	E41-0799-08	CON(FPC)1.25MM 55129010XX		
F610,611			JUMPER WIRE	20441270XX		7
JK203		*	E70-0152-08	CONN-SPE WP-41355149540XX		
JK204		*	E70-0158-08	CONN-SPE WP-41255149530XX		7
JK401		*	E63-1241-08	CON PHONO SCKT 55088170XX		
JK402		*	E63-1240-08	CON PHONO SCKT 55149460XX		7
JK402		*	E63-1245-08	CON PHONO SCKT 55168680XX		5
W1 ,2			JUMPER WIRE	20441270XX		5
Δ F603,604			F05-3121-05	FUSE T 3.15A /220828800NR		
L201,202			L39-1624-08	COIL SPRING - S21070690NR		
R201,202			RS14KB3A681J	FL-PROOF RS 680 J 1W		
R207			RS14AB3A100J	FL-PROOF RS 10 J 1W		
R223-226			RS14AB3AR22J	FL-PROOF RS 0.22 J 1W		7
R229-232			RS14AB3AR22J	FL-PROOF RS 0.22 J 1W		7
R234			R90-0840-05	RD 0.22 5W		
R301			R90-0840-05	RD 0.22 5W		

L : Scandinavia K : USA P : Canada R : Mexico C : China I : Malaysia
Y : PX(Far East,Hawaii) T : England E : Europe G : Germany V : China(Shanghai)
Y : AAFES(Europe) X : Australia Q : Russia H : Korea M : Other Areas Δ indicates safety critical components.

* New Parts
Parts without **Parts No.** are not supplied.
Les articles non mentionnés dans le **Parts No.** ne sont pas fournis.
Teile ohne **Parts No.** werden nicht geliefert.

5

Ref. No	Add-ress	New Parts	Parts No.	Description	Desti-nation	Re-marks
R318			RS14AB3A100J	FL-PROOF RS 10 J 1W		
R320			RS14KB3A561J	FL-PROOF RS 560 J 1W		
R321			JUMPER WIRE	20441260XX		7
R321			RS14KB3A561J	FL-PROOF RS 560 J 1W		5
R340			JUMPER WIRE	BCL 0.5MM TIN A20441180XX		5
R342			JUMPER WIRE	BCL 0.5MM TIN A20441250XX		5
R348,349			RS14KB3A101J	FL-PROOF RS 100 J 1W		
R602			J3010101620X	RES OXIDE/TAP 1J3010101620X		7
R604			RS14KB3A102J	FL-PROOF RS 1.0K J 1W		5
R604			RS14KB3A561J	FL-PROOF RS 560 J 1W		7
△ R608			RS14KB3A1R0J	FL-PROOF RS 1 J 1W		
R610			RS14AB2H121K	FL-PROOF RS 120 K 1/2W		
R620			JUMPER WIRE	20441250XX		
R626			RS14KB3AR22J	FL-PROOF RS 0.22 J 1W		
VR201,202		*	R12-1616-08	PR 1K0 OHM +30%55159950NR		
K201		*	S76-0127-08	RELAY OSA-SS-21J5512400020X		
S201		*	S62-0109-08	SWISLIDE VERTIC55149560XX		
D1_2			1N4148	D-SLP 7043654016		
D201			1N4004	D-SR 2041506016		7
D202			1N4148	D-SLP 7043654016		7
D203,204			1N4004	D-SR 2041506016		7
D205			1N4148	D-SLP 7043654016		7
D206,207			MTZ5.1J(B)	D-ZENER 2052696016		
D208,209			1N4148	D-SLP 7043654016		
D210			1N4004	D-SR 2041506016		7
D211-213			1N4148	D-SLP 7043654016		
D217-219			1N4148	D-SLP 7043654016		
D219			1N4148	D-SLP 7043654016		
D221			1N4148	D-SLP 7043654016		7
D222-225			1N5402	D-SRSHC 5504164016		7
D226			MTZ5.1J(B)	D-ZENER 2052696016		7
D227,228			1N4148	D-SLP 7043654016		
D229			MTZ5.1J(B)	D-ZENER 2052696016		
D232-235			1N4148	D-SLP 7043654016		
△ D601,602		*	BU8-04F	DIODE BU8-04F J1253000005X		
D604			MTZJ30C	D-ZENER 2047534016		
D606			1N5239B	D-ZENER 2045463016		
△ D609			MTZ13J(C)	D-ZENER 2052687016		
△ D610		*	BU6-04F	B-D BU6-04F J1253000006X		
D611			MTZJ6.2C	D-Z 0.5W 6.2V MJ2221462534X		
D620			1N4148	D-SLP 7043654016		
IC401		*	TDA7439D	IC-LOWFREQ 55041290NR		
IC402			BA4558	IC(OP AMP X2) 20323370NR		
IC403		*	MC14066	IC-LOGIC MC 20771300NR		
IC406			BA4558	IC(OP AMP X2) 20323370NR		
△ IC601		*	KIA7912PI-1	IC(ANALOGUE IC) 55094440NR		
△ IC602		*	KIA7812API-1	IC(ANALOGUE IC) 55094390NR		
△ IC603		*	KA278R33	IC-REGPOSFXD 55129810NR		
P201		*	P42T5D300BW18	POSISTOR 2P 180J2431400092X		
P202		*	P42T7D100BW18	POSISTOR 2P 180J2431400102X		
Q201,202			KTC3205Y	TR-SLPLF 2049552056		7
Q203,204		*	KTA1024	TR-SLPLF 5513326056		7
Q205			KTB631K	TR-SHPLF KTB63155134740NR		7

L: Scandinavia K: USA P: Canada R: Mexico C: China I: Malaysia
Y: PX(Far East,Hawaii) T: England E: Europe G: Germany V: China(Shanghai)
Y: AAFES(Europe) X: Australia Q: Russia H: Korea M: Other Areas △ indicates safety critical components .

* New Parts
Parts without **Parts No.** are not supplied.
Les articles non mentionnés dans le **Parts No.** ne sont pas fournis.
Teile ohne **Parts No.** werden nicht geliefert.

6

Ref. No	Add-ress	New Parts	Parts No.	Description	Desti-nation	Re-marks
Q206,207		*	2SA1941	TR PNP 2SA1941-J2002500203X		7
Q208			KTC3200GR	TR-SHPLF 2055660056		
Q209			KTD600K	TR-SHPLF KTD60055134750NR		7
Q210,211			2SC5198	TR NPN 2SC5198-J2002520203X		7
Q212		*	2SC5200	TR NPN J2002520003X		
△ Q213			2SC4793	TR PNP J2002520403X		
△ Q214		*	2SA1943	TR PNP J2002500003X		
Q215			2SC4883A	TR NPN J2021520302X		
Q216			KTC3200GR	TR-SHPLF 2055660056		
Q217		*	KTA1024	TR-SLPLF 5513326056		
Q218			KTA1268	TR-SLPLF 5513323056		
Q219			KTD1302	TR-SLPLF 5513329056		
Q220			KTA1268	TR-SLPLF 5513323056		
Q221,222			KTC3200GR	TR-SHPLF 2055660056		
Q223		*	DTA114YSA	TR-SLPLF 5513322056		
Q224			KTD1302	TR-SLPLF 5513329056		
Q225,226			KTA1268	TR-SLPLF 5513323056		
Q227			KTC3200GR	TR-SHPLF 2055660056		
Q228			2SC4883A	TR NPN J2021520302X		
△ Q229			2SA1837	TR PNP J2002540103X		
△ Q230		*	2SA1943	TR PNP J2002500003X		
Q231			KTC3200GR	TR-SHPLF 2055660056		
Q232		*	KTA1024	TR-SLPLF 5513326056		
△ Q233			2SC4793	TR PNP J2002520403X		
△ Q234		*	2SC5200	TR NPN J2002520003X		
Q235		*	KTA1024	TR-SLPLF 5513326056		7
Q236			KTC3205Y	TR-SLPLF 2049552056		7
Q237,238		*	KTA1024	TR-SLPLF 5513326056		7
Q239			KTA1266(Y)	TR-SLPLF 2050821056		
Q240,241			KTC3198Y	TR-SLPLF 2050808056		
Q242			KTC3200GR	TR-SHPLF 2055660056		
△ Q243			2SA1837	TR PNP J2002540103X		
Q244			KTA1266(Y)	TR-SLPLF 2050821056		
Q245		*	DTA114YSA	TR-SLPLF 5513322056		
Q246,247			KTD1302	TR-SLPLF 5513329056		
Q249,250			KTC3200GR	TR-SHPLF 2055660056		
Q251			KTC3198Y	TR-SLPLF 2050808056		
Q252			KTC3205Y	TR-SLPLF 2049552056		
Q253			KTA1266(Y)	TR-SLPLF 2050821056		
Q254			KTC3198Y	TR-SLPLF 2050808056		
Q255			KTC3205Y	TR-SLPLF 2049552056		
Q256			KTA1266(Y)	TR-SLPLF 2050821056		
Q257			KTC3198Y	TR-SLPLF 2050808056		
Q258		*	DTA114YSA	TR-SLPLF 5513322056		
Q259		*	DTC114YSA	TR-SLPLF 5513321056		
Q401			KTA1266(Y)	TR-SLPLF 2050821056		
Q402			DTA114YSA	TR-SLPLF 5513322056		
Q403		*	DTC114YSA	TR-SLPLF 5513321056		
Q404		*	DTA114YSA	TR-SLPLF 5513322056		
Q406,407			KTD1302	TR-SLPLF KTD1305513329056		7
Q408		*	DTA114YSA	TR-SLPLF DTA1145513322056		7
Q409		*	DTC114YSA	TR-SLPLF 5513321056		
Q410		*	DTA114YSA	TR-SLPLF 5513322056		
Q601			KTA1273Y	TR-SLPHF 2049548056		
△ Q603,604		*	KTD2058	TR-SHPLF 55133280NR		

L: Scandinavia K: USA P: Canada R: Mexico C: China I: Malaysia
Y: PX(Far East,Hawaii) T: England E: Europe G: Germany V: China(Shanghai)
Y: AAFES(Europe) X: Australia Q: Russia H: Korea M: Other Areas △ indicates safety critical components .

PARTS LIST

RXD-A850DV/DV50/DV70

* New Parts
Parts without **Parts No.** are not supplied.
Les articles non mentionnés dans le **Parts No.** ne sont pas fournis.
Teile ohne **Parts No.** werden nicht geliefert.

7

Ref. No	Add-ress	New Parts	Parts No.	Description	Desti-nation	Re-marks
Q605			KTC3198Y	TR-SLPLF 2050808056		
Q606			KTD2058Y	TR-SHPLF 55133280NR		
Q607			KTC3198Y	TR-SLPLF 2050808056		
FRONT/DECK						
C1			CK45FB1E223Z	CERAMIC 0.022UF	Z	5
C3			CK45FB1E223Z	CERAMIC 0.022UF	Z	
C234			CE04LW1H0R1M	ELECTRO 0.1UF	50WV	
C235,236			CE04LW1H100M	ELECTRO 10UF	50WV	
C237,238			CE04LW1HR47M	ELECTRO 0.47UF	50WV	
C239			CK45FB1H471K	CERAMIC 470PF	K	
C240			CE04LW1H100M	ELECTRO 10UF	50WV	
C241			CE04LW1HR47M	ELECTRO 0.47UF	50WV	
C242			C91-0755-05	CERAMIC 680PF	K	
C246			C91-0757-05	CERAMIC 1000PF	K	
C248,249			C91-0757-05	CERAMIC 1000PF	K	
C801			C91-0729-05	CERAMIC 22PF	J	
C802			C91-0757-05	CERAMIC 1000PF	K	
C803			C91-0729-05	CERAMIC 22PF	J	
C804			CE04KW1A471M	ELECTRO 470UF	10WV	
C805			CK41FB1E104Z	CYLND CHIP C 0.10UF	Z	
C806			CE04LW1H2R2M	ELECTRO 2.2UF	50WV	
C814			CE04LW1C470M	ELECTRO 47UF	16WV	
C815			CK45FB1E223Z	CERAMIC 0.022UF	Z	
C816			C91-0757-05	CERAMIC 1000PF	K	
C817			C90-5745-08	BACKUP-C 0.047F	5.5WV	
C818			CK45FB1E223Z	CERAMIC 0.022UF	Z	
C819			CE04LW1C470M	ELECTRO 47UF	16WV	
C820,821			CK45FB1E223Z	CERAMIC 0.022UF	Z	
C823			CE04LW1A101M	ELECTRO 100UF	10WV	
C824			CK45FB1E223Z	CERAMIC 0.022UF	Z	
C825			CE04LW1H100M	ELECTRO 10UF	50WV	
C826			CE04KW0J221M	ELECTRO 220UF	6.3WV	
C827			CE04LW1A101M	ELECTRO 100UF	10WV	
C828-830			C91-0745-05	CERAMIC 100PF	K	
C831			CE04LW1H2R2M	ELECTRO 2.2UF	50WV	5
C832			CK45FB1E473Z	CERAMIC 0.047UF	Z	
C901			C91-0749-05	CERAMIC 220PF	K	
C902			C91-0755-05	CERAMIC 680PF	K	
C903			C91-0749-05	CERAMIC 220PF	K	
C904			C91-0755-05	CERAMIC 680PF	K	
C905			C91-0749-05	CERAMIC 220PF	K	
C906			CE04LW1C470M	ELECTRO 47UF	16WV	
C907			CQ93FMG1H103J	MYLAR 0.010UF	J	
C908			CE04LW1H010M	ELECTRO 1.0UF	50WV	
C909			CE04LW1C221M	ELECTRO 220UF	16WV	
C910			CE04LW1H3R3M	ELECTRO 3.3UF	50WV	
C911			CE04LW1H4R7M	ELECTRO 4.7UF	50WV	
C912			CE04LW1C220M	ELECTRO 22UF	16WV	
C913			C91-0749-05	CERAMIC 220PF	K	
C914			CE04LW1A101M	ELECTRO 100UF	10WV	
C915			CE04LW1H4R7M	ELECTRO 4.7UF	50WV	
C916			C91-0757-05	CERAMIC 1000PF	K	
C917			CQ93FMG1H182J	MYLAR 1800PF	J	
C918			C91-0757-05	CERAMIC 1000PF	K	

L : Scandinavia K : USA P : Canada R : Mexico C : China I : Malaysia
Y : PX(Far East,Hawaii) T : England E : Europe G : Germany V : China(Shanghai)
Y : AAFES(Europe) X : Australia Q : Russia H : Korea M : Other Areas Δ indicates safety critical components.

* New Parts
Parts without **Parts No.** are not supplied.
Les articles non mentionnés dans le **Parts No.** ne sont pas fournis.
Teile ohne **Parts No.** werden nicht geliefert.

8

Ref. No	Add-ress	New Parts	Parts No.	Description	Desti-nation	Re-marks
C919			CE04LW1C470M	ELECTRO 47UF	16WV	
C920			CE04LW1H4R7M	ELECTRO 4.7UF	50WV	
C921			C91-0757-05	CERAMIC 1000PF	K	
C922			CE04LW1C220M	ELECTRO 22UF	16WV	
C923			C91-0749-05	CERAMIC 220PF	K	
C924			C91-0745-05	CERAMIC 100PF	K	
C925			CE04LW1H4R7M	ELECTRO 4.7UF	50WV	
C926			C91-0757-05	CERAMIC 1000PF	K	
C927			CQ93FMG1H182J	MYLAR 1800PF	J	
C928			CE04LW1H010M	ELECTRO 1.0UF	50WV	
C929			CE04LW1C470M	ELECTRO 47UF	16WV	
C930			CQ93FMG1H103J	MYLAR 0.010UF	J	
C931,932			C91-0749-05	CERAMIC 220PF	K	
C933,934			C91-0755-05	CERAMIC 680PF	K	
C935			CE04LW1C220M	ELECTRO 22UF	16WV	
C936			C91-0749-05	CERAMIC 220PF	K	
C937			CK14FB1E223Z	CERAMIC 0.022UF	Z	
C938,939			C91-0749-05	CERAMIC 220PF	K	
C940			CQ93FMG1H472J	MYLAR 4700PF	J	
C942			CK45FB1E223Z	CERAMIC 0.022UF	Z	
C943			CQ93FMG1H103J	MYLAR 0.010UF	J	
C944			CE04LW1C470M	ELECTRO 47UF	16WV	
C945			CQ93FMG1H153J	MYLAR 0.015UF	J	
C946			CQ93FMG1H103J	MYLAR 0.010UF	J	
C947			CQ93FMG1H153J	MYLAR 0.015UF	J	
C950			C91-0745-05	CERAMIC 100PF	K	
C951			CE04LW1C100M	ELECTRO 10UF	16WV	
C952,953			CE04LW1C470M	ELECTRO 47UF	16WV	
C954			CE04LW1H4R7M	ELECTRO 4.7UF	50WV	
C956			C91-0753-05	CERAMIC 470PF	K	
C957			CE04KW1H4R7M	ELECTRO 4.7UF	50WV	
C958			C91-0753-05	CERAMIC 470PF	K	
C959			CE04LW1H3R3M	ELECTRO 3.3UF	50WV	
C960			CE04LW1C220M	ELECTRO 22UF	16WV	
C961,962			C91-0737-05	CERAMIC 47PF	J	
C963			CE04LW1C220M	ELECTRO 22UF	16WV	
C964			CK45FB1E223Z	CERAMIC 0.022UF	Z	
CC801	2D,2E	*	E35-3013-08	FPC CABLE 19P 2J4112192001X		
CC901	2D	*	E35-3014-08	FPC CABLE 17P 6J4112170601X		
CP804		*	E41-0800-08	CON(FPC) 1.25MM55124760XX		
CP906		*	E41-0801-08	CON(FPC) 1.25MM55124750XX		
JK201		*	E11-0951-08	CONN-PHJAC 6.3555176280XX		
JK202		*	E11-0951-08	CONN-PHJAC 6.3555176280XX	MM2	
L901,902		*	L33-1645-08	COIL CHOKE RA 1J2612210323X		
T901		*	L32-1054-08	COIL BIAS OSC 7J3923150011X		
X801		*	L77-2355-08	CRESONATOR 10M055126140NR		
X802		*	L77-2356-08	FILQZ 32K768 HZ55093470NR		
EN801		*	R39-0046-08	ENCODER EC 16E J32616100001		
R375			JUMPER WIRE	20330130XX	MM2	
R842			JUMPER WIRE	20441180XX	KY	
R844			JUMPER WIRE	20330130XX	Y	
VR201		*	R32-0105-08	VOLUM RK09K12A J32214000401	MM2	
VR901		*	R12-3129-08	PR 22K0 OHM +3055150940NR		

L : Scandinavia K : USA P : Canada R : Mexico C : China I : Malaysia
Y : PX(Far East,Hawaii) T : England E : Europe G : Germany V : China(Shanghai)
Y : AAFES(Europe) X : Australia Q : Russia H : Korea M : Other Areas Δ indicates safety critical components.

* New Parts
 Parts without **Parts No.** are not supplied.
 Les articles non mentionnés dans le **Parts No.** ne sont pas fournis.
 Teile ohne **Parts No.** werden nicht geliefert.



Ref. No	Add-ress	New Parts	Parts No.	Description	Desti-nation	Re-marks
VR903,904		*	R12-5059-08	PR 100K0 OHM +355150920NR		
SW801-805		*	S70-0092-08	SWITACT HOR 50M20404680NR		
SW810-827		*	S70-0092-08	SWITACT HOR 50M20404680NR		
D230,231			1N4148	D-SLP 7043654016	MM2	
D240,241			1N4148	D-SLP 7043654016	MM2	
D612			MTZ13J(C)	D-ZENER 2052697016		
D802-805			1N4148	D-SLP 7043654016		
D808		*	B30-2626-08	D-LEM MVL-582HB55054040NR		
D809-812		*	B30-2627-08	D-LEM LTL-1CHPE55129160NR		
D815		*	B30-2625-08	LED RED/GREEN 3J2302210012X		
D817			B30-2630-08	D-LEM LTL-42CB65136330NR		
D818,819			1N4148	D-SLP 7043654016	YMM2	
D830			1N4148	D-SLP 7043654016		
D901-904			1N4148	D-SLP 7043654016		
D905			1N4004	D-SR 2041506016		
D906			1N4148	D-SLP 7043654016		
FL801		*	HNA-11LS02	DISPLAY HNA-11L55129170NR		
IC201			BA4558	IC(OP AMP X2) 20323370NR	MM2	
IC801		*	CXP82860-324Q	IC-MICROCONT 55128930NR		
IC802-805			MC14094BC	IC-LOGIC 20509810NR		
IC901			KIA6289N	IC VOL J2115222001X		
IC902			BA4558	IC(OP AMP X2) 20323370NR		
Q801			KTC3198Y	TR-SLPLF 2050808056		
Q803			DTC114YSA	TR-SLPLF 5513321056		
Q806-809			DTC114YSA	TR-SLPLF 5513321056		
Q812-914			DTC114YSA	TR-SLPLF 5513321056		
Q815			DTA114YSA	TR-SLPLF 5513322056		
Q901, 902			KTD1302	TR-SLPLF 5513329056		
Q903			DTC114YSA	TR-SLPLF 5513321056		
Q904-911			KTD1302	TR-SLPLF 5513329056		
Q912			KTA1266(Y)	TR-SLPLF 2050821056		
Q913		*	DTC114YSA	TR-SLPLF 5513321056		
Q914			KTA1266(Y)	TR-SLPLF 2050821056		
Q916		*	DTC114YSA	TR-SLPLF 5513321056		
Q917			KTC3205Y	TR-SLPLF 2049552056		
Q918			KTC3198Y	TR-SLPLF 2050808056		
Q919-921			KTA1273Y	TR-SLPHF 2049548056		
Q922-924		*	DTC114YSA	TR-SLPLF 5513321056		
Q925,926			KTC3205Y	TR-SLPLF 2049552056		
Q927		*	DTA114YSA	TR-SLPLF 5513322056		
Q945		*	DTC114YSA	TR-SLPLF 5513321056		
RM801			W02-2801-08	S-REMOTE 38KHZ J2411120014X		

STANDBY/VIDEO

C8			CK14FB1E104Z	CERAMIC	0.10UF	Z		
C9			CE04LW1C470M	ELECTRO	47UF	16WV		
C10			C91-0752-05	CERAMIC	390PF	K	MM2TE	
C13			C91-0752-05	CERAMIC	390PF	K	MM2TE	
C15			C91-0752-05	CERAMIC	390PF	K	MM2TE	
C17			C91-0752-05	CERAMIC	390PF	K		
C19			C91-0752-05	CERAMIC	390PF	K		
C21			C91-0752-05	CERAMIC	390PF	K		
C22			C91-0751-05	CERAMIC	330PF	K		
C701			CE04LW1H0R1M	ELECTRO	0.1UF	50WV		

L : Scandinavia K : USA P : Canada R : Mexico C : China I : Malaysia
 Y : PX(Far East,Hawaii) T : England E : Europe G : Germany V : China(Shanghai)
 Y : AAFES(Europe) X : Australia Q : Russia H : Korea M : Other Areas Δ indicates safety critical components .

* New Parts
 Parts without **Parts No.** are not supplied.
 Les articles non mentionnés dans le **Parts No.** ne sont pas fournis.
 Teile ohne **Parts No.** werden nicht geliefert.



Ref. No	Add-ress	New Parts	Parts No.	Description	Desti-nation	Re-marks
C702			CE04LW1V332M	ELECTRO 3300UF 35WV		
C704			CE04LW1C470M	ELECTRO 47UF 16WV		
C705			C91-1645-08	CC 4N7F +20% -255095470NR		
C706			CK45FB1E223Z	CERAMIC 0.022UF Z		
CN705		*	E41-0797-08	CON(FPC) 1.25MM55124800XX		
JK1		*	E63-1242-08	CON PHONO SCKT 55149420XX	MM2	7
JK1		*	E63-1242-08	CON PHONO SCKT 55149420XX	X	7
JK2		*	E63-1243-08	CON DIN SCKT MI55149520XX		
F701		Δ	F05-2525-05	FUSE T 2.5A /2502403850NR	MM2	7
F701		Δ	F06-2021-05	FUSE T 2A /250V55015620NR	YMM2	5
F702		Δ	F05-2525-05	FUSE T 2.5A /2502403850NR	XTE	7
F702		Δ	F05-4025-05	FUSE T 4A /250V20828850NR	YMM2	5
F702		Δ	F05-5025-05	FUSE T 5A /250V55126910NR	MM2	7
F702		Δ	F06-2021-05	FUSE T 2A /250V55015620NR	XTE	5
F702		Δ	F50-0073-05	FUSE T 4A /125V20828770NR	K	5
F703		Δ	F53-0263-08	FUSULSLWBL 500M55167150NR	YMM2	
CDL1,2		*	L92-0017-05	BEAD AXIAL 6MM J2631200012X		
L1 -3			L40-2291-17	LF 2U2H +10% 1.2107562016		7
L4 -6			L40-2291-17	LF 2U2H +10% 1.2107562016		
T701		*	L07-3120-08	ST/BY TRANS 110J2801710041X	KYMM2	
T701		*	L07-3158-08	ST/BY TRANS 230J2812420042X	XTE	
R709			R92-1844-05	3M3 OHM 1/2W 1504110016	K	5
K701		*	S76-0126-08	RELAY SDT-S-105J5511610030X		
S701		*	S62-0108-08	SW VOL.(SDKGA41J46100000701)	YMM2	
D1 -4			MTZ5.1J(B)	D-ZENER 2052696016		
D701			1N4148	D-SLP 7043654016		
D703-705			1N4004	D-SR 2041506016		
D706,707			1N4148	D-SLP 7043654016		
D708			1N4004	D-SR 2041506016		
D709			MTZ5.1J(B)	D-ZENER 2052696016		
IC701		Δ	KA78R05	IC REG J2112532002X		
Q1			KTC3198Y	TR-SLPLF KTC3192050808056		
Q2			KTA1266(Y)	TR-SLPLF KTA1262050821056		
Q702			KTC3200GR	TR-SHPLF KTC3202055660056		
JK3		*	W02-2911-08	D-LEM TOTX178B 55125440NR		

DVD

C1 -7			CK73GB1E104Z	CHIP C	0.10UF	Z		
C8 ,9			CC73GCH1H102J	CHIP C	1000PF	J		
C10			CC73GCH1H102J	CHIP C	1000PF	J		7
C13			CE04LW1C102M	ELECTRO	1000UF	16WV		
C14			CK73GB1E104Z	CHIP C	0.10UF	Z		
C15			CE04KW1C101M	ELECTRO	100UF	16WV		7
C16			CE04KW0J102M	ELECTRO	1000UF	6.3WV		
C17 ,18			CE04KW1A101M	ELECTRO	100UF	10WV		
C19 ,20			CC73GCH1H102J	CHIP C	1000PF	J		
C21			CE04KW1A101M	ELECTRO	100UF	10WV		
C22			CK73GB1E104Z	CHIP C	0.10UF	Z		
C23 ,24			CC73GCH1H240J	CHIP C	24PF	J		
C25			CE04LW1A221M	ELECTRO	220UF	10WV		
C26			CK73GB1E103K	CHIP C	0.010UF	K	MM2	
C27			CK73GB1E104Z	CHIP C	0.10UF	Z		
C28			CK73GB1E103K	CHIP C	0.010UF	K	MM2	

L : Scandinavia K : USA P : Canada R : Mexico C : China I : Malaysia
 Y : PX(Far East,Hawaii) T : England E : Europe G : Germany V : China(Shanghai)
 Y : AAFES(Europe) X : Australia Q : Russia H : Korea M : Other Areas Δ indicates safety critical components .

PARTS LIST

RXD-A850DV/DV50/DV70

* New Parts
Parts without **Parts No.** are not supplied.
Les articles non mentionnés dans le **Parts No.** ne sont pas fournis.
Teile ohne **Parts No.** werden nicht geliefert.

11

Ref. No	Add-ress	New Parts	Parts No.	Description	Desti-nation	Re-marks
C29			CK73GB1E104Z	CHIP C	0.10UF	Z
C30			CC73GCH1H471J	CHIP C	470PF	J
C31			CE04LW1C101M	ELECTRO	100UF	16WV
C32			CK73GB1E103K	CHIP C	0.010UF	K
C48			CC73GCH1H080D	CHIP C	8.0PF	D
C49			CC73GCH1H180J	CHIP C	18PF	J
C51			CE04LW1A221M	ELECTRO	220UF	10WV
C60			CE04LW1C101M	ELECTRO	100UF	16WV
C63			CC73GCH1H102J	CHIP C	1000PF	J
C81FL			CE04LW1C470M	ELECTRO	47UF	16WV
C81FR			CE04LW1C470M	ELECTRO	47UF	16WV
C82FL			CC73GCH1H821J	CHIP C	820PF	J
C82FR			CC73GCH1H821J	CHIP C	820PF	J
C83FL			CE04LW1C470M	ELECTRO	47UF	16WV
C83FR			CE04LW1C470M	ELECTRO	47UF	16WV
C85FL			CE04LW1C470M	ELECTRO	47UF	16WV
C85FR			CE04LW1C470M	ELECTRO	47UF	16WV
C86FL			CC73GCH1H101J	CHIP C	100PF	J
C86FR			CC73GCH1H101J	CHIP C	100PF	J
C87FL			CC73GCH1H821J	CHIP C	820PF	J
C87FR			CC73GCH1H821J	CHIP C	820PF	J
C88FL			CE04LW1C100M	ELECTRO	10UF	16WV
C88FR			CE04LW1C100M	ELECTRO	10UF	16WV
C11,12			CC73GCH1H080J	CHIP C	8.0PF	J
CM1,2			CE04LW1C101M	ELECTRO	100UF	16WV
CV2			CC73GCH1H391J	CHIP C	390PF	J
CV3			CE04LW0J471M	ELECTRO	470UF	6.3WV
CV4			CK73GB1H332K	CHIP C	3300PF	K
CV5			CK73GB1E104Z	CHIP C	0.10UF	Z
CV6			CE04LW0J471M	ELECTRO	470UF	6.3WV
CV7			CE04LW1C101M	ELECTRO	100UF	16WV
CV8			CK73GB1H332K	CHIP C	3300PF	K
CV9			CE04LW0J471M	ELECTRO	470UF	6.3WV
CV10			CC73GCH1H391J	CHIP C	390PF	J
CV11			CE04LW1C101M	ELECTRO	100UF	16WV
CV12			CK73GB1E104Z	CHIP C	0.10UF	Z
CV13			CE04LW0J471M	ELECTRO	470UF	6.3WV
CV14			CC73GCH1H391J	CHIP C	390PF	J
CV15			CE04LW0J471M	ELECTRO	470UF	6.3WV
CV16			CK73GB1H332K	CHIP C	3300PF	K
CV17			CK73GB1E104Z	CHIP C	0.10UF	Z
CV18			CE04LW0J471M	ELECTRO	470UF	6.3WV
CV19			CE04LW1C101M	ELECTRO	100UF	16WV
CV20			CC73GCH1H680J	CHIP C	68PF	J
CV21			CE04LW0J102M	ELECTRO	1000UF	6.3WV
CV23			CK73GB1E104Z	CHIP C	0.10UF	Z
CV24			CE04LW0J471M	ELECTRO	470UF	6.3WV
CV25			CE04LW1C101M	ELECTRO	100UF	16WV
CV26			CC73GCH1H680J	CHIP C	68PF	J
CV27			CC73GCH1H561J	CHIP C	560PF	J
CV28			CK73GB1H332K	CHIP C	3300PF	K
CV29			CK73GB1E104Z	CHIP C	0.10UF	Z
CV31			CE04LW1C101M	ELECTRO	100UF	16WV
CV32			CC73GCH1H391J	CHIP C	390PF	J
CV34			CK73GB1H332K	CHIP C	3300PF	K

L: Scandinavia K: USA P: Canada R: Mexico C: China I: Malaysia
Y: PX(Far East,Hawaii) T: England E: Europe G: Germany V: China(Shanghai)
Y: AAFES(Europe) X: Australia Q: Russia H: Korea M: Other Areas Δ indicates safety critical components.

* New Parts
Parts without **Parts No.** are not supplied.
Les articles non mentionnés dans le **Parts No.** ne sont pas fournis.
Teile ohne **Parts No.** werden nicht geliefert.

12

Ref. No	Add-ress	New Parts	Parts No.	Description	Desti-nation	Re-marks
CV35			CK73GB1E104Z	CHIP C	0.10UF	Z
CV37			CE04LW0J102M	ELECTRO	1000UF	6.3WV
CV39			CE04LW1A221M	ELECTRO	220UF	10WV
CV41			CE04LW0J102M	ELECTRO	1000UF	6.3WV
CV48			CE04LW0J102M	ELECTRO	1000UF	6.3WV
CV49,50			CK73GB1H105Z	CHIP C	1.0UF	Z
CV53-55			CE04LW1C100M	ELECTRO	10UF	16WV
CV56			CE04LW0J471M	ELECTRO	470UF	6.3WV
CV57			CC73GCH1H102J	CHIP C	1000PF	J
CV58			CK73GB1E104Z	CHIP C	0.10UF	Z
CV65			CC73GCH1H330J	CHIP C	33PF	J
CC1	3B	*	E35-3204-08	FPC CABLE 33P	3J4114333501X	
CC2	3B	*	E35-3019-08	FPC CABLE 15P	2J4112152501X	
CC3	3B	*	E35-3205-08	FPC CABLE 19P	1J4114319301X	
CN1		*	E41-0802-08	CON(FPC) 1.25MM	55129010XX	
CN4		*	E41-0803-08	CON(FPC) 1.25MM	55124890XX	
CP1		*	E35-3017-08	CON(FPC) 1.25MM	55129060XX	
BD10,11			L92-0551-08	FBEAD SURFACE	M5512673050	
BD10B			L92-0551-08	FBEAD SURFACE	M5512673050	
R67,68			L92-0551-08	FBEAD SURFACE	M5512673050	
R70			L92-0551-08	FBEAD SURFACE	M5512673050	
X1			L77-2354-08	FILQZ 27M0 HZ	+55128980NR	
D1			1N4004	DIODE	2041506016	
D2,3			1S5355	D-SLP	20496510NR	
D4,7			ZNR5V1B	D-CHIP	J2242451514X	
D8FL			1S5355	D-SLP	20496510NR	
D8FR			1S5355	D-SLP	20496510NR	
J5			RK73GB1J000J	CHIP R	0	J 1/16W
J10			RK73GB1J000J	CHIP R	0	J 1/16W
LM1			RK73GB1J100J	CHIP R	10	J 1/16W
R1			RK73GB1J470J	CHIP R	47	J 1/16W
R2 -8			RK73GB1J101J	CHIP R	100	J 1/16W
R9			RK73GB1J470J	CHIP R	47	J 1/16W
R10			RK73GB1J101J	CHIP R	100	J 1/16W
R11			RK73GB1J473J	CHIP R	47K	J 1/16W
R12 -14			RK73GB1J470J	CHIP R	47	J 1/16W
R15			RK73GB1J472J	CHIP R	4.7K	J 1/16W
R16			RK73GB1J103J	CHIP R	10K	J 1/16W
R16A			RK73GB1J103J	CHIP R	10K	J 1/16W
R17A			RK73GB1J470J	CHIP R	47	J 1/16W
R20 -23			RK73GB1J470J	CHIP R	47	J 1/16W
R24,25			RK73GB1J122J	CHIP R	1.2K	J 1/16W
R26 -32			RK73GB1J470J	CHIP R	47	J 1/16W
R33			RK73GB1J103J	CHIP R	10K	J 1/16W
R34,35			RK73GB1J153J	CHIP R	15K	J 1/16W
R36			RK73GB1J102J	CHIP R	1.0K	J 1/16W
R37			RK73GB1J105J	CHIP R	1.0M	J 1/16W
R38 -40			RK73GB1J470J	CHIP R	47	J 1/16W
R41			RK73GB1J100J	CHIP R	10	J 1/16W
R42			RK73GB1J471J	CHIP R	470	J 1/16W
R43			RK73GB1J221J	CHIP R	220	J 1/16W
R44			RK73GB1J151J	CHIP R	150	J 1/16W
R46,47			RK73GB1J472J	CHIP R	4.7K	J 1/16W

L: Scandinavia K: USA P: Canada R: Mexico C: China I: Malaysia
Y: PX(Far East,Hawaii) T: England E: Europe G: Germany V: China(Shanghai)
Y: AAFES(Europe) X: Australia Q: Russia H: Korea M: Other Areas Δ indicates safety critical components.

* New Parts
Parts without **Parts No.** are not supplied.
Les articles non mentionnés dans le **Parts No.** ne sont pas fournis.
Teile ohne **Parts No.** werden nicht geliefert.

13

Ref. No	Add-ress	New Parts	Parts No.	Description	Desti-nation	Re-marks
R48			RK73GB1J103J	CHIP R 10K J 1/16W		
R49			RK73GB1J560J	CHIP R 56 J 1/16W		
R50			RK73GB1J000J	CHIP R 0 J 1/16W		
R51 -55			RK73GB1J103J	CHIP R 10K J 1/16W		
R56 ,57			RK73GB1J750J	CHIP R 75 J 1/16W		
R58			RK73GB1J471J	CHIP R 470 J 1/16W		
R59			RK73GB1J102J	CHIP R 1.0K J 1/16W		
R61			RK73GB1J100J	CHIP R 10 J 1/16W		
R62		*	L92-0551-08	FBEAD SURFACE M5512673050		
R62A			RK73GB1J103J	CHIP R 10K J 1/16W		
R63			RK73GB1J100J	CHIP R 10 J 1/16W		
R64 -66			RK73GB1J470J	CHIP R 47 J 1/16W		
R71			RK73GB1J221J	CHIP R 220 J 1/16W		
R74 -80			RK73GB1J470J	CHIP R 47 J 1/16W		
R81 ,82			RK73GB1J103J	CHIP R 10K J 1/16W		
R81FL			RK73GB1J342F	CHIP R 3.4K F 1/16W		
R82FL			RK73GB1J512J	CHIP R 5.1K J 1/16W		
R82FR			RK73GB1J512J	CHIP R 5.1K J 1/16W		
R83			RK73GB1J472J	CHIP R 4.7K J 1/16W		
R83FL			RK73GB1J512J	CHIP R 5.1K J 1/16W		
R83FR			RK73GB1J512J	CHIP R 5.1K J 1/16W		
R84 -90			RK73GB1J473J	CHIP R 47K J 1/16W		
R84FL			RK73GB1J104J	CHIP R 100K J 1/16W		
R84FR			RK73GB1J104J	CHIP R 100K J 1/16W		
R85FL			RK73GB1J102J	CHIP R 1.0K J 1/16W		
R85FR			RK73GB1J102J	CHIP R 1.0K J 1/16W		
R86FL			RK73GB1J473J	CHIP R 47K J 1/16W		
R86FR			RK73GB1J473J	CHIP R 47K J 1/16W		
R87FL			RK73GB1J342F	CHIP R 3.4K F 1/16W		
R87FR			RK73GB1J342F	CHIP R 3.4K J 1/16W		
R91			RK73GB1J000J	CHIP R 0 J 1/16W		
R92 -94			RK73GB1J470J	CHIP R 47 J 1/16W		
R95			RK73GB1J101J	CHIP R 100 J 1/16W		
R96			RK73GB1J470J	CHIP R 47 J 1/16W		
R102,103			RK73GB1J470J	CHIP R 47 J 1/16W		
R104			RK73GB1J100J	CHIP R 10 J 1/16W		
R112,113			RK73GB1J103J	CHIP R 10K J 1/16W		
R114			RK73GB1J470J	CHIP R 47 J 1/16W		
R115			RK73GB1J560J	CHIP R 56 J 1/16W		
R118,119			RK73GB1J470J	CHIP R 47 J 1/16W		
RA1 -3		*	R90-1333-08	RCA 47R0 OHM +555129820NR		
RA4			RK73GB1J100J	CHIP R 10 J 1/16W	MM2	
RA5 -16		*	R90-1333-08	RCA 47R0 OHM +555129820NR		
RA70-73			RK73GB1J101J	CHIP R 100 J 1/16W	MM2	
RA80			RK73GB1J103J	CHIP R 10K J 1/16W	MM2	
RM7 ,8			RK73GB1J103J	CHIP R 10K J 1/16W		
RM9			RK73GB1J473J	CHIP R 47K J 1/16W		
RM20-23			RK73GB1J472J	CHIP R 4.7K J 1/16W		
RS1 -3			RK73GB1J470J	CHIP R 47 J 1/16W		
RS4			RK73GB1J100J	CHIP R 10 J 1/16W		
RS5 -7			RK73GB1J470J	CHIP R 47 J 1/16W		
RS16			RK73GB1J470J	CHIP R 47 J 1/16W		
RS18			RK73GB1J470J	CHIP R 47 J 1/16W		
RS21,22			RK73GB1J470J	CHIP R 47 J 1/16W		
RS24			RK73GB1J470J	CHIP R 47 J 1/16W		

L : Scandinavia K : USA P : Canada R : Mexico C : China I : Malaysia
Y : PX(Far East,Hawaii) T : England E : Europe G : Germany V : China(Shanghai)
Y : AAFES(Europe) X : Australia Q : Russia H : Korea M : Other Areas Δ indicates safety critical components .

* New Parts
Parts without **Parts No.** are not supplied.
Les articles non mentionnés dans le **Parts No.** ne sont pas fournis.
Teile ohne **Parts No.** werden nicht geliefert.

14

Ref. No	Add-ress	New Parts	Parts No.	Description	Desti-nation	Re-marks
RS90			RK73GB1J473J	CHIP R 47K J 1/16W		
RV1			RK73GB1J750J	CHIP R 75 J 1/16W	MM2X	7
RV2			RK73GB1J241J	CHIP R 240 J 1/16W		
RV3			RK73GB1J222J	CHIP R 2.2K J 1/16W	MM2X	7
RV4			RK73GB1J821J	CHIP R 820 J 1/16W	MM2X	7
RV5			RK73GB1J241J	CHIP R 240 J 1/16W		
RV6			RK73GB1J821J	CHIP R 820 J 1/16W	MM2X	7
RV7			RK73GB1J222J	CHIP R 2.2K J 1/16W	MM2X	7
RV8			RK73GB1J120J	CHIP R 12 J 1/16W	MM2X	7
RV9			RK73GB1J8R2J	CHIP R 8.2 J 1/16W	MM2X	7
RV10			RK73GB1J120J	CHIP R 12 J 1/16W	MM2X	7
RV11			RK73GB1J8R2J	CHIP R 8.2 J 1/16W	MM2X	7
RV12			RK73GB1J750J	CHIP R 75 J 1/16W	MM2X	7
RV13			RK73GB1J241J	CHIP R 240 J 1/16W		
RV14			RK73GB1J222J	CHIP R 2.2K J 1/16W	MM2X	7
RV15			RK73GB1J821J	CHIP R 820 J 1/16W	MM2X	7
RV16			RK73GB1J120J	CHIP R 12 J 1/16W	MM2X	7
RV17			RK73GB1J8R2J	CHIP R 8.2 J 1/16W	MM2X	7
RV18			RK73GB1J750J	CHIP R 75 J 1/16W	MM2X	7
RV20			RK73GB1J222J	CHIP R 2.2K J 1/16W		
RV21			RK73GB1J821J	CHIP R 820 J 1/16W		
RV22			RK73GB1J120J	CHIP R 12 J 1/16W		
RV23			RK73GB1J8R2J	CHIP R 8.2 J 1/16W		
RV24			RK73GB1J750J	CHIP R 75 J 1/16W		
RV25			RK73GB1J241J	CHIP R 240 J 1/16W		
RV26			RK73GB1J222J	CHIP R 2.2K J 1/16W		
RV27			RK73GB1J821J	CHIP R 820 J 1/16W		
RV28			RK73GB1J120J	CHIP R 12 J 1/16W		
RV29			RK73GB1J8R2J	CHIP R 8.2 J 1/16W		
RV30			RK73GB1J750J	CHIP R 75 J 1/16W		
RV31			RK73GB1J241J	CHIP R 240 J 1/16W		
RV32			RK73GB1J222J	CHIP R 2.2K J 1/16W		
RV33			RK73GB1J821J	CHIP R 820 J 1/16W		
RV34			RK73GB1J120J	CHIP R 12 J 1/16W		
RV35			RK73GB1J8R2J	CHIP R 8.2 J 1/16W		
RV36			RK73GB1J750J	CHIP R 75 J 1/16W		
RV37-39			RK73GB1J330J	CHIP R 33 J 1/16W	MM2X	7
RV40-42			RK73GB1J330J	CHIP R 33 J 1/16W		
RV43			L92-0551-08	FBEAD SURFACE M5512673050		
RV50-52			RK73GB1J100J	CHIP R 10 J 1/16W		
RV53-55			RK73GB1J100J	CHIP R 10 J 1/16W	MM2X	7
C33 -47			CK73GB1E104Z	CHIP C 0.10UF K		
CV1			CE04LW1C101M	ELECTRO 100UF 1 6WV	MM2X	7
CV22			CK73GB1H332K	CHIP C 3300PF K		
CV62-64			CC73GC1H330J	CHIP C 33PF J		
Q3FR			DTC323TK	TR-SSD 5503943092		
R45			RK73GB1J102J	CHIP R 1.0K J 1/16W		
R81FR			RK73GB1J342F	CHIP R 3.4K J 1/16W		
R105,106			RK73GB1J221J	CHIP R 220 J 1/16W		
RS23			RK73GB1J470J	CHIP R 47J J 1/16W		
RV19			RK73GB1J241J	CHIP R 240 J 1/16W		
RV44			RK73GB1J100J	CHIP R 10J 1/16W		
IC1		*	STI5508	IC-VIDEOPROC 55130350NR		

L : Scandinavia K : USA P : Canada R : Mexico C : China I : Malaysia
Y : PX(Far East,Hawaii) T : England E : Europe G : Germany V : China(Shanghai)
Y : AAFES(Europe) X : Australia Q : Russia H : Korea M : Other Areas Δ indicates safety critical components .

PARTS LIST

RXD-A850DV/DV50/DV70

* New Parts
Parts without **Parts No.** are not supplied.
Les articles non mentionnés dans le **Parts No.** ne sont pas fournis.
Teile ohne **Parts No.** werden nicht geliefert.

15

Ref. No	Add-ress	New Parts	Parts No.	Description	Desti-nation	Re-marks
IC2		*	HY57V65	IC-DRAM 55156290NR		
IC2		*	K4S6416	IC-DRAM 55156420NR		
IC3		*	M29W800AT	IC FLASH J2131007002X		
IC4		*	M24C02WMN6	IC-EEPROM 20940740NR		
IC5			M74HCU04M	IC-LOGIC 55133310NR		
IC6		*	CS5330A-KS	IC-CONV 55129680NR	MM2	
IC7		*	74VHC125MX	IC-LOGIC 55129000NR	MM2	
IC10			PCM1748KE	IC DAC J2133020002X		
IC81			BA4560F	IC-OPERAMP 55128990NR		
Q1 .2			KTC3875Y	TR-SLPSWA 2097046092		
Q3FL			DTC323TK	TR-SSD 5503943092		
Q4FL			KRA107S	TR-SSD 5505126092		
Q4FR			KRA107S	TR-SSD 5505126092		
QV1 -3		*	KTN2907A	TR-SLPSWA 5513783092	MM2X	7
QV4 -6		*	KTN2907A	TR-SLPSWA 5513783092		
QV7 ,8			KRC107S	TR-SSD 5505124092		
QV9 -11			DTC323TK	TR-SSD 5503943092	MM2X	7
QV12-14			DTC323TK	TR-SSD 5503943092		

DVD SUB

C001			CE04LW1C102M	ELECTRO 1000UF	16VV	
C002			CK45FB1H104K	CERAMIC 0.10UF	K	
C003			CK45FB1H220J	CERAMIC 22PF	J	
C004			CK45FB1H104K	CERAMIC 0.10UF	K	
C005			CK45FB1H220J	CERAMIC 22PF	J	
C006			CK45FB1H104K	CERAMIC 0.10UF	K	
BD01,02			L92-0017-05	BEAD AXIAL 6MM J2631200012X		
L001			L40-3901-17	LF 39UOH +10% 120833280NR		
M001			T42-1116-08	AD ASY MOTOR DC20581800XX		
D001,002			UZ5V6	D-ZENER 2041428016		
IC001,002			LB1641	IC(MOTOR DRIVER)0656300NR		
P1001-1003		*	T95-0188-08	D-PHOTO ITR960620586840NR		
P1004		*	GP2S28	D-PHOTO GP2S28 20556130NR		
Q001		*	DTC114YSA	TR-SLPLF DTC1145513321056		

DVD MECHANISM

1	1B	*	D02-0146-08	AC PLASTIC MLD 55087120XX		
2	1A,1B	*	D14-0819-08	AC RUBBER ROLLE20712120XX		
3	1A,1B	*	D14-0825-08	AC PLASTIC ROLL20712170XX		
4	1B	*	F19-1124-08	AC PUN COVER PV20923940XX		
5	1B	*	D16-0778-08	AC RUBBER RAW B20923950XX		
6	1B	*	J19-6294-08	AC MLD HOLDER A55154980XX		
7	1B	*	D15-0447-08	SHAFT ASSY 55111500XX		
10	1B	*	G09-0691-08	AC SPRING CLIP 20986670XX		
11	1B	*	T42-1115-08	AD ASY MOTOR DC20949030XX		
12	1B	*	J11-0883-08	AC METAL FELT M55104240XX		
13	2B	*	D40-1750-08	OK KIT TVK 13-110720510XX		
14	2B	*	D12-0164-08	AC PLASTIC MLD 20923920XX		
15	2B	*	G09-0692-08	AC SPRING BRACK55113630XX		
16	2B	*	G09-0693-08	AC SPRING BRACK55113640XX		
17	2A	*	D13-2583-08	AC PLASTIC GEAR20923910XX		
18	2A	*	A15-0113-08	AC RUBBER SPACE20689440XX		
19	2B	*	A15-0114-08	AC PLASTIC MLD 55075850XX		

L : Scandinavia K : USA P : Canada R : Mexico C : China I : Malaysia
Y : PX(Far East,Hawaii) T : England E : Europe G : Germany V : China(Shanghai)
Y : AAFES(Europe) X : Australia Q : Russia H : Korea M : Other Areas Δ indicates safety critical components .

* New Parts
Parts without **Parts No.** are not supplied.
Les articles non mentionnés dans le **Parts No.** ne sont pas fournis.
Teile ohne **Parts No.** werden nicht geliefert.

16

Ref. No	Add-ress	New Parts	Parts No.	Description	Desti-nation	Re-marks
20	2A	*	D16-0779-08	AC RUBBER RAW B55073350XX		
21	2A	*	D13-2584-08	AC MLD GEAR DRI20712240XX		
22	2A	*	D13-2585-08	AC MLD GEAR PUL20712250XX		
23	2A	*	T42-1116-08	AD ASY MOTOR DC20581800XX		
AA		*	N09-5404-08	SCREW WBT 3*10 J80600031030		
AD		*	N09-5405-08	SCREW-SPEC 3MM 20366370XX		

L : Scandinavia K : USA P : Canada R : Mexico C : China I : Malaysia
Y : PX(Far East,Hawaii) T : England E : Europe G : Germany V : China(Shanghai)
Y : AAFES(Europe) X : Australia Q : Russia H : Korea M : Other Areas Δ indicates safety critical components .

HOW TO READ THE PARTS LIST

ABBREVIATION OF MODEL AND MASS PRODUCTION'S DESTINATIONS

MODEL	CNT	Australia	Canada	China	England	Europe	Germany	Korea	Malaysia
ABB.		X	P	C	T	E	G	H	I
RXD-A850DV	5	-	-	-	-	-	-	-	-
RXD-DV50	5	X	-	-	T	E	-	-	-
RXD-DV50(M2)	5	-	-	-	-	-	-	-	-
RXD-DV70	7	X	-	-	-	-	-	-	-
RXD-DV70(M2)	7	-	-	-	-	-	-	-	-
MODEL	CNT	Mexico	PX/AAFES	Russia	Scandinavia	Shanghai	USA	Other area	Saudi Arabia
ABB.		R	Y	Q	L	V	K	M	M2
RXD-A850DV	5	-	-	-	-	-	K	-	-
RXD-DV50	5	-	-	-	-	-	-	M	-
RXD-DV50(M2)	5	-	-	-	-	-	-	-	M2
RXD-DV70	7	-	-	-	-	-	-	M	-
RXD-DV70(M2)	7	-	-	-	-	-	-	-	M2

RXD-A850DV/DV50/DV70

SPECIFICATIONS

XD-DV70

[for Europe and U.K.]

Rated output power during STEREO operation
(DIN) 1 kHz, 0.7 % T.H.D. at 6 Ω127 W + 127 W

Effective output power
(1 kHz, 10 % T.H.D. at 6 Ω) 150 W + 150 W
[for other countries]

Rated output power during STEREO operation
1 kHz, 0.7 % T.H.D. at 6 Ω130 W + 130 W

Effective output power
(1 kHz, 10 % T.H.D. at 6 Ω) 150 W + 150 W

Input sensitivity / impedance
VIDEO/AUX 400 mV / 35 kΩ
MIC (only some areas) 4.0 mV / 8.2 kΩ

Output level / impedance
VIDEO/AUX 400 mV / 1.0 kΩ
SUPER WOOFER PREOUT 2.0 V / 2.2 kΩ

XD-DV60

[for Europe and U.K.]

Rated output power during STEREO operation
(DIN) 1 kHz, 0.7 % T.H.D. at 6 Ω127 W + 127 W

Effective output power
(1 kHz, 10 % T.H.D. at 6 Ω) 150 W + 150 W
[for other countries]

Rated output power during STEREO operation
1 kHz, 0.7 % T.H.D. at 6 Ω130 W + 130 W

Effective output power
(1 kHz, 10 % T.H.D. at 6 Ω) 150 W + 150 W

Input sensitivity / impedance
VIDEO/AUX 400 mV / 35 kΩ
MIC (only some areas) 4.0 mV / 8.2 kΩ

Output level / impedance
VIDEO/AUX 400 mV / 1.0 kΩ
SUPER WOOFER PREOUT 2.0 V / 2.2 kΩ

XD-DV50

[for Europe and U.K.]

Rated output power during STEREO operation
(DIN) 1 kHz, 0.7 % T.H.D. at 6 Ω85 W + 85 W

Effective output power
(1 kHz, 10 % T.H.D. at 6 Ω) 100 W + 100 W
[for other countries]

Rated output power during STEREO operation
1 kHz, 0.7 % T.H.D. at 6 Ω88 W + 88 W

Effective output power
(1 kHz, 10 % T.H.D. at 6 Ω) 100 W + 100 W

Input sensitivity / impedance
VIDEO/AUX 400 mV / 35 kΩ
MIC (only some areas) 4.0 mV / 8.2 kΩ

Output level / impedance
VIDEO/AUX 400 mV / 1.0 kΩ
SUPER WOOFER PREOUT 2.0 V / 2.2 kΩ

XD-A850

Rated output power during STEREO operation
(FTC) 1 kHz, 0.7 % T.H.D. at 6 Ω80 W + 80 W

Effective output power
(1 kHz, 10 % T.H.D. at 6 Ω) 100 W + 100 W

Input sensitivity / impedance
VIDEO/AUX 400 mV / 35 kΩ
MIC (only some areas) 4.0 mV / 8.2 kΩ
Output level / impedance
VIDEO/AUX 400 mV / 1.0 kΩ
SUPER WOOFER PREOUT 2.0 V / 2.2 kΩ

[Tuner section]

FM tuner section
Tuning frequency range 87.5 MHz ~ 108 MHz
AM Tuner section
Tuning frequency range (for U.K., Europe and Australia)
..... 531 kHz ~ 1,602 kHz
Tuning frequency range (for U.S.A. and Canada)
..... 530 kHz ~ 1,700 kHz
Tuning frequency range (for other countries)
..... 531 kHz ~ 1,602 kHz / 530 kHz ~ 1,700 kHz

[Cassette deck section]

Track 4-track, 2-channel stereo
Recording system AC bias system
(Frequency: 105 kHz)
Heads
TAPE A Playback head 1
TAPE B Playback / recording head 1
Erasing head 1
Fast winding time Approx. 100 seconds (C-60 tape)

[DVD/CD/VIDEO CD player section]

Laser Semiconductor laser
Wow & Flutter Less than unmeasurable Limit
Video output format (for U.S.A. and Canada) NTSC
Video output format (for other countries) NTSC/PAL
VIDEO OUTPUT
Composit video output level/impedance 1 Vp-p (75 Ω)
S-video output
Y output level/impedance 1 Vp-p (75 Ω)
C output level/impedance
NTSC 0.286 Vp-p (75 Ω)
PAL 0.3 Vp-p (75 Ω)
Component video output (only for some areas)
Y output level/impedance 1 Vp-p (75 Ω)
C/b output level/impedance 0.7 Vp-p (75 Ω)
C/r output level/impedance 0.7 Vp-p (75 Ω)
Compression format MPEG1/MPEG2
Digital output -15 dBm ~ 21 dBm
(Wave length 660 nm)

[General]

Power consumption (XD-DV70/XD-DV60) 240 W
Power consumption (XD-DV50/XD-A850DV) 230 W
Dimensions W: 280 mm
H: 330 mm
D: 408 mm
Weight (net) (XD-DV70/XD-DV60) 13.1 kg
Weight (net) (XD-DV50/XD-A850DV) 12.0 kg



1. KENWOOD follows a policy of continuous advancements in development. For this reason specifications may be changed without notice.
2. Sufficient performance may not be possible at very low temperatures (0°C or less).

RXD-A850DV/DV50/DV70

Note:

Component and circuit are subject to modification to insure best operation under differing local conditions. This manual is based on Europe (E) standard, and provides information on regional circuit modification through use of alternate schematic diagrams, and information on regional component variations through use of parts list.

KENWOOD CORPORATION

14-6, Dogenzaka 1-chome, Shibuya-ku, Tokyo, 150-8501 Japan

KENWOOD SERVICE CORPORATION

P.O. BOX 22745, 2201 East Dominguez St., Long Beach, CA 90801-5745, U.S.A.

KENWOOD ELECTRONICS CANADA INC.

6070 Kestrel Road, Mississauga, Ontario, Canada L5T 1S8

KENWOOD ELECTRONICS LATIN AMERICA S.A.

P.O. BOX 55-2791, Piso 6 plaza Chase, Cl. 47 y Aquilino de la Guardia Panama, Republic de Panama

KENWOOD ELECTRONICS BRASIL LTDA.

Alameda Ministro Rocha Azevedo No. 456, Edificio Jaú, 10o Andar, Cerqueira César, Cep 0140-001, São Paulo-SP-Brasil

KENWOOD ELECTRONICS U.K. LIMITED

KENWOOD House, Dwight Road, Watford, Herts., WD1 8EB., United Kingdom

KENWOOD ELECTRONICS BELGIUM N.V.

Leuvensesteenweg 248 J, 1800 Vilvoorde, Belgium

KENWOOD ELECTRONICS DEUTSCHLAND GMBH

Rembrücker Str. 15, 63150 Heusenstamm, Germany

KENWOOD ELECTRONICS FRANCE S.A.

13 Boulevard Ney, 75018 Paris, France

KENWOOD ELECTRONICS ITALIA S.p.A.

Via G. Sirtori, 7/9 20129, Milano, Italy

KENWOOD IBÉRICA S.A.

Bolivia, 239-08020 Barcelona, Spain

KENWOOD ELECTRONICS AUSTRALIA PTY. LTD.

(A.C.N. 001 499 074)
16 Giffnock Avenue, North Ryde, N.S.W. 2113, Australia

KENWOOD ELECTRONICS (HONG KONG) LTD.

Unit 3712-3724, Level 37, Tower 1, Metroplaza, 223 Hing Fong Road, Kwai Fong N.T., Hong Kong

KENWOOD ELECTRONICS GULF FZE

P.O.Box 61318, Jebel Ali, Dubai, U.A.E.

KENWOOD ELECTRONICS SINGAPORE PTE LTD.

No. 1 Genting Lane #02-02, KENWOOD Building, Singapore, 349544

KENWOOD ELECTRONICS (MALAYSIA) SDN BHD.

#4.01 Level 4, Wisma Academy Lot 4A, Jalan 19/1 46300 Petaling Jaya Selangor Darul Ehsan Malaysia

KENWOOD ELECTRONICS (THAILAND) CO., LTD.

2019 New Pechburi Road, Bangkapi, Huaykwang, Bangkok, 10320 Thailand