

COMPACT DISC PLAYER

# DP-G7

## SERVICE MANUAL

(UD-705)

# KENWOOD

© 1996-4/B51-5176-00 (K/K) 2602

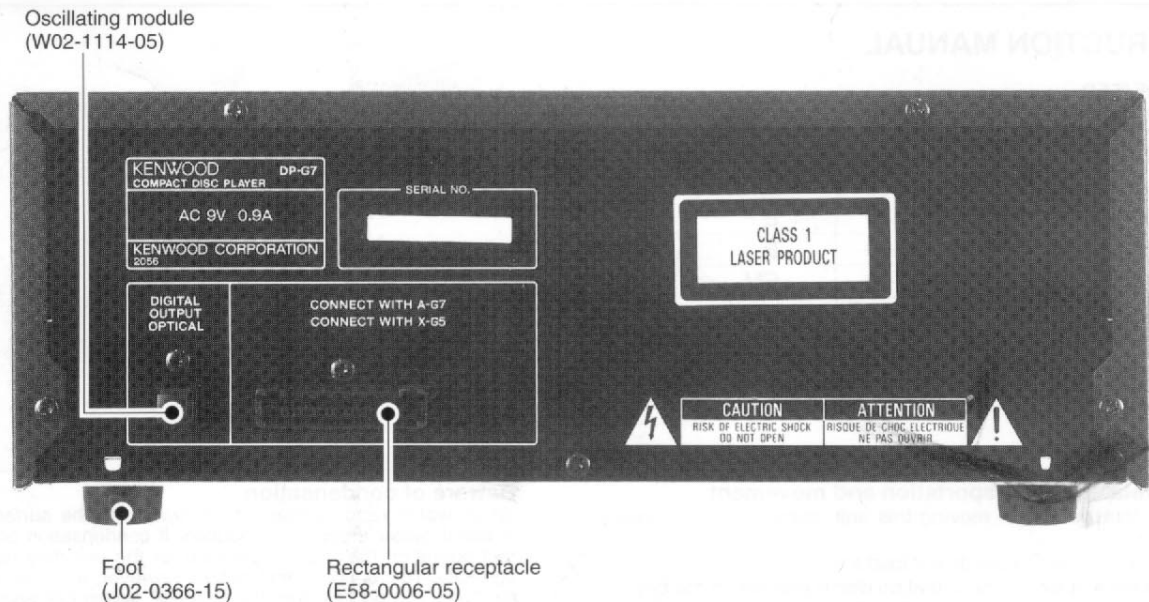
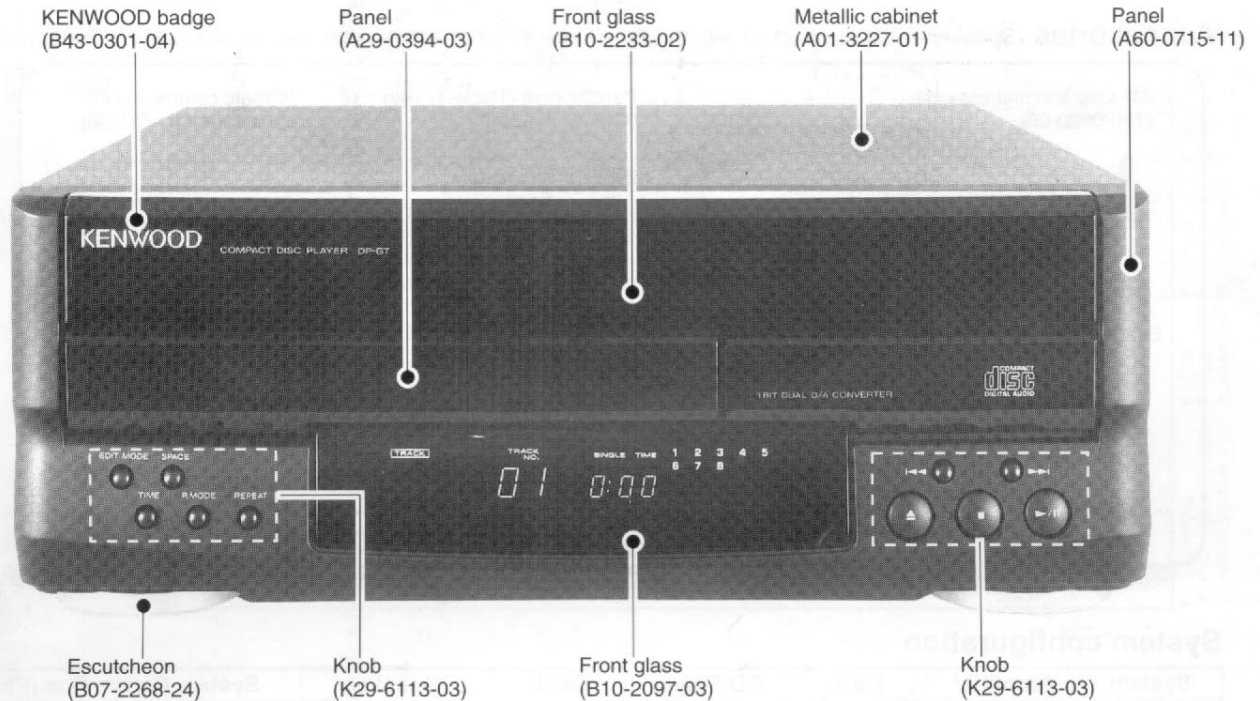

Refer to DP-F7 service manual (B51-5035-00), if you require Microprocessor  $\mu$ PD78044AGF097 in detail.

### PRECAUTIONS FOR REPAIR

DP-G7 does not have a power supply transformer. Use A-G7, or PS-94UA power supply to supply power.

In compliance with Federal Regulations, following are reproductions of labels on, or inside the product relating to laser product safety.

KENWOOD-Corp. certifies this equipment conforms to DHHS Regulations No. 21 CFR 1040. 10, Chapter 1, Subchapter J.

**DANGER : Laser radiation when open and interlock defeated. AVOID DIRECT EXPOSURE TO BEAM.**

## ADJUSTMENT

No.	ITEM	INPUT SETTINGS	OUTPUT SETTINGS	PLAYER SETTINGS	ALIGNMENT POINTS	ALIGN FOR	FIG.
1	LASER POWER	-	Apply the sensor section of optical power meter on the pickup lens.	While pressing the EDIT key, turn the AC ON. (Test mode) Press the DOWN key, then confirm that the display is "03".	-	On the power from 0.06 to 0.15 mW (When the diffraction grating is correctly aligned with the RF level of 1.0 Vp-p or more and the TE (servo open) level of 0.6 Vp-p or more, the pickup is acceptable.)	(a)
2	TRACKING ERROR BALANCE	Test disc Type 4	Connect an oscilloscope as follows. CH1:RF (CN3 pin 1) CH2:TE (CN3 pin 6)	Set the unit to test mode. Load the test disc. Press the DOWN key, then confirm that the display is "03".	TE BALANCE VR2	Symmetry between upper and lower patterns	(c)
3	FOCUS ERROR BALANCE	Test disc Type 4	Connect an oscilloscope as follows. CH1:RF (CN3 pin 1) CH2:TE (CN3 pin 6)	Set the unit to test mode. Press the PLAY key, then confirm that the display is "05".	FE BALANCE VR1	Optimum eye pattern	(d)
4	TRACKING GAIN	Test disc Type 4 Apply signal of 1.0 kHz, 50mVrms to CN3 pin 5-6.	Connect a LPF to CN3 pin 5-6 to which you connect an oscilloscope or AC voltmeters.	Set the unit to test mode. Press the PLAY key, then confirm that the display is "05".	TRACKING GAIN VR3	Two VTVMs should read the same value.	(e)

Note:  
Type 4 disc : SONY YEDS-18 Test Disc or equivalent.  
LPF: Around 47 kΩ+ 390 pF or so.  
Step 1~4 are in Test Mode.

(a) Laser power

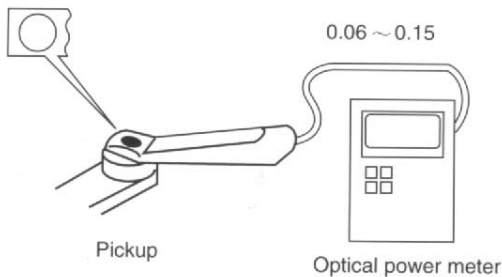

(e) Tracking gain

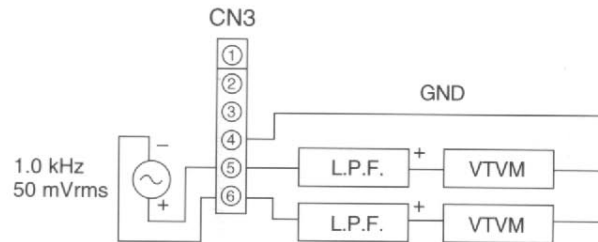

## ADJUSTMENT

FIG. (b)

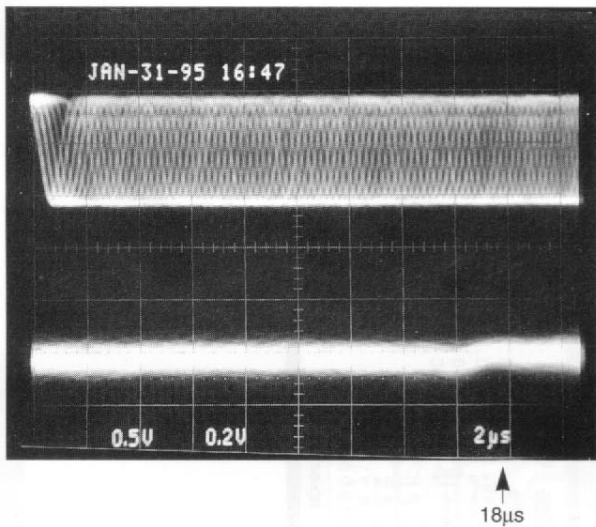

- RF signal and TE signal in test mode (PLAY).
- If the diffraction grating has been adjusted correctly, the influence of triggering is observed on the TE waveform of approx.  $18\mu\text{s}$  from RF signal trigger point, in the form of a projection.

FIG. (c)

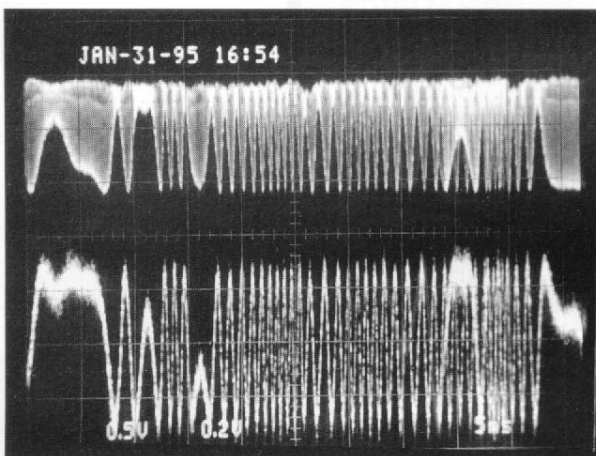

- RF signal and TE signal in test mode (Focusing servo ON / Tracking servo OFF). (Disc Type 4)
- Adjust TE signal so that the waveform is symmetrical in relation to VC. (TE BALANCE)

FIG. (d)

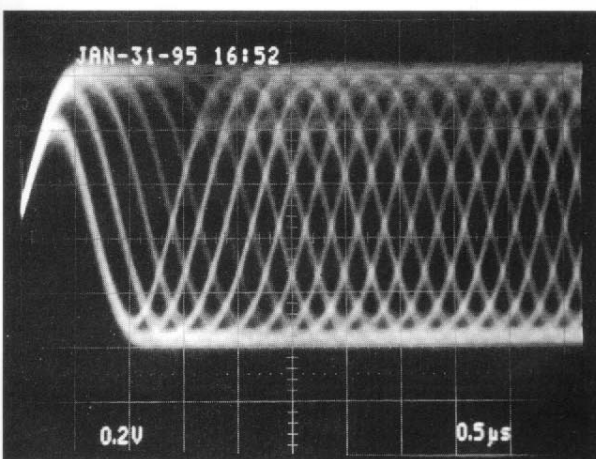

- RF signal in test mode (PLAY).
- Perform the tangential and focusing offset are focused into one point on the display. The crossing points above and below the center shall also be looked clearly. (FE BALANCE)

# PC BOARD (Component side view)

(c) Tracking error balance  
: Symmetry between  
upper and lower patterns

(d) Focus error balance  
: Optimum eye pattern

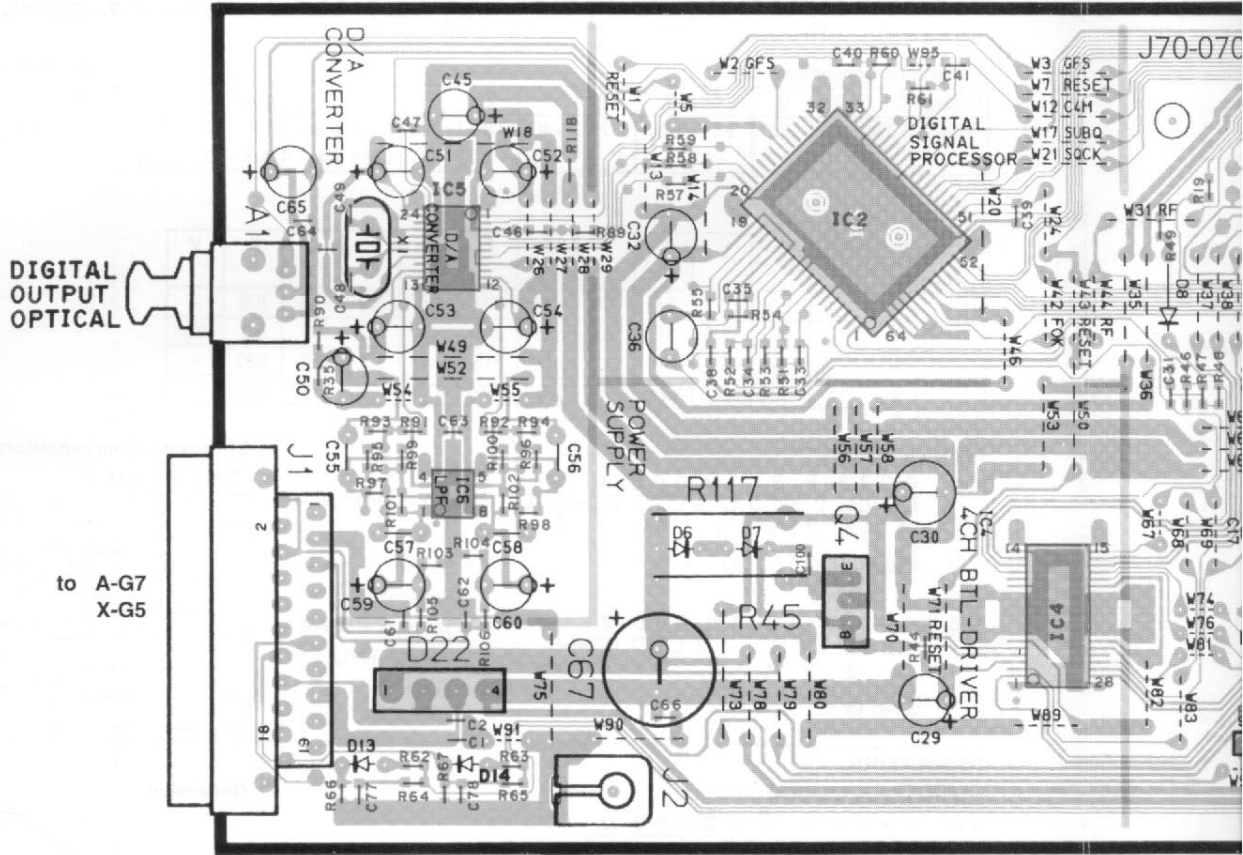
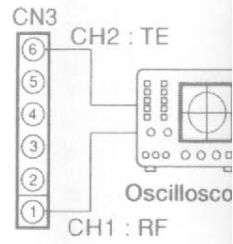
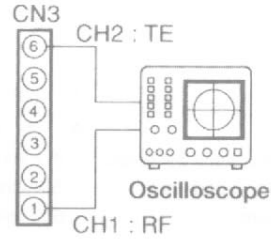

to A-G7  
X-G5

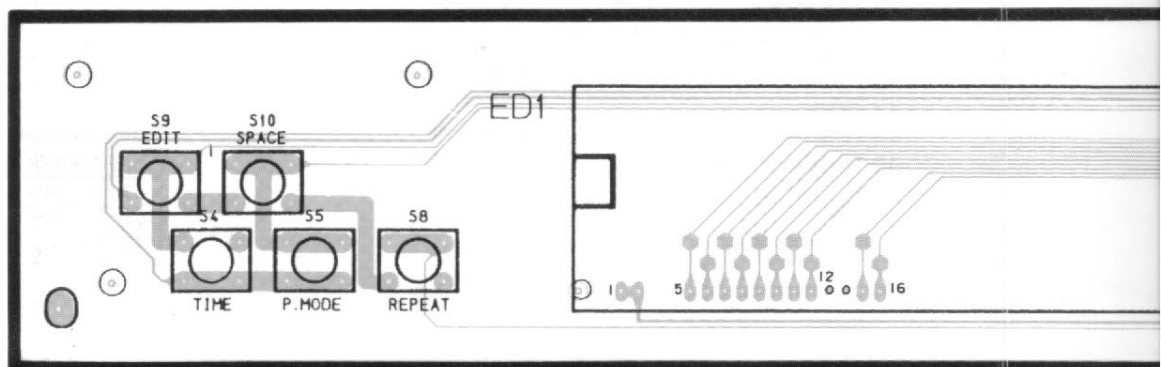

d) Focus error balance  
: Optimum eye pattern

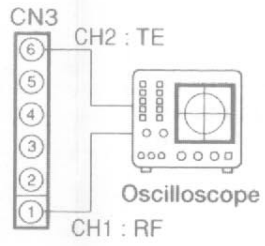

(e) Tracking gain :  
Two VTVMs should read the same value.

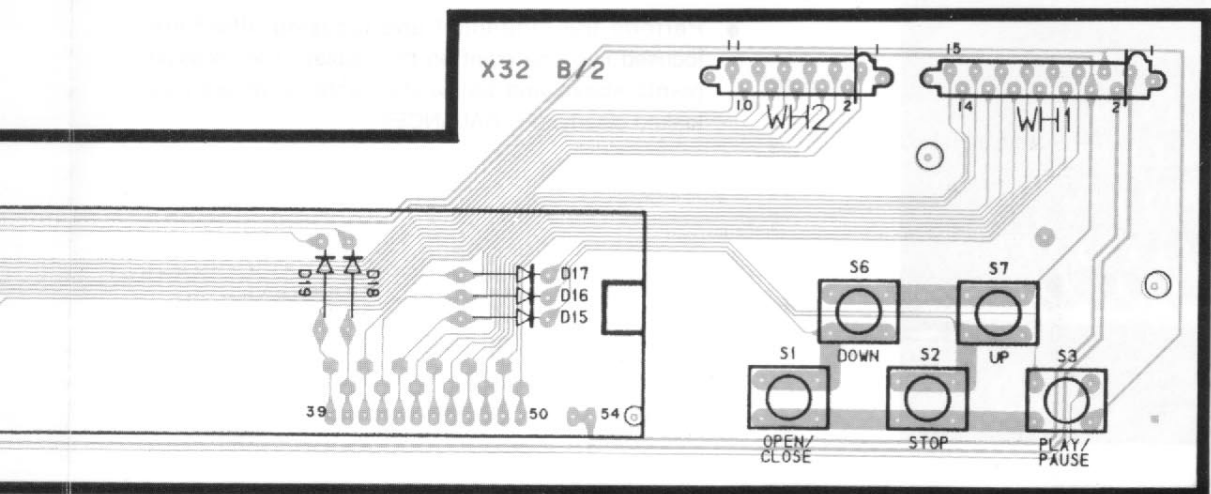
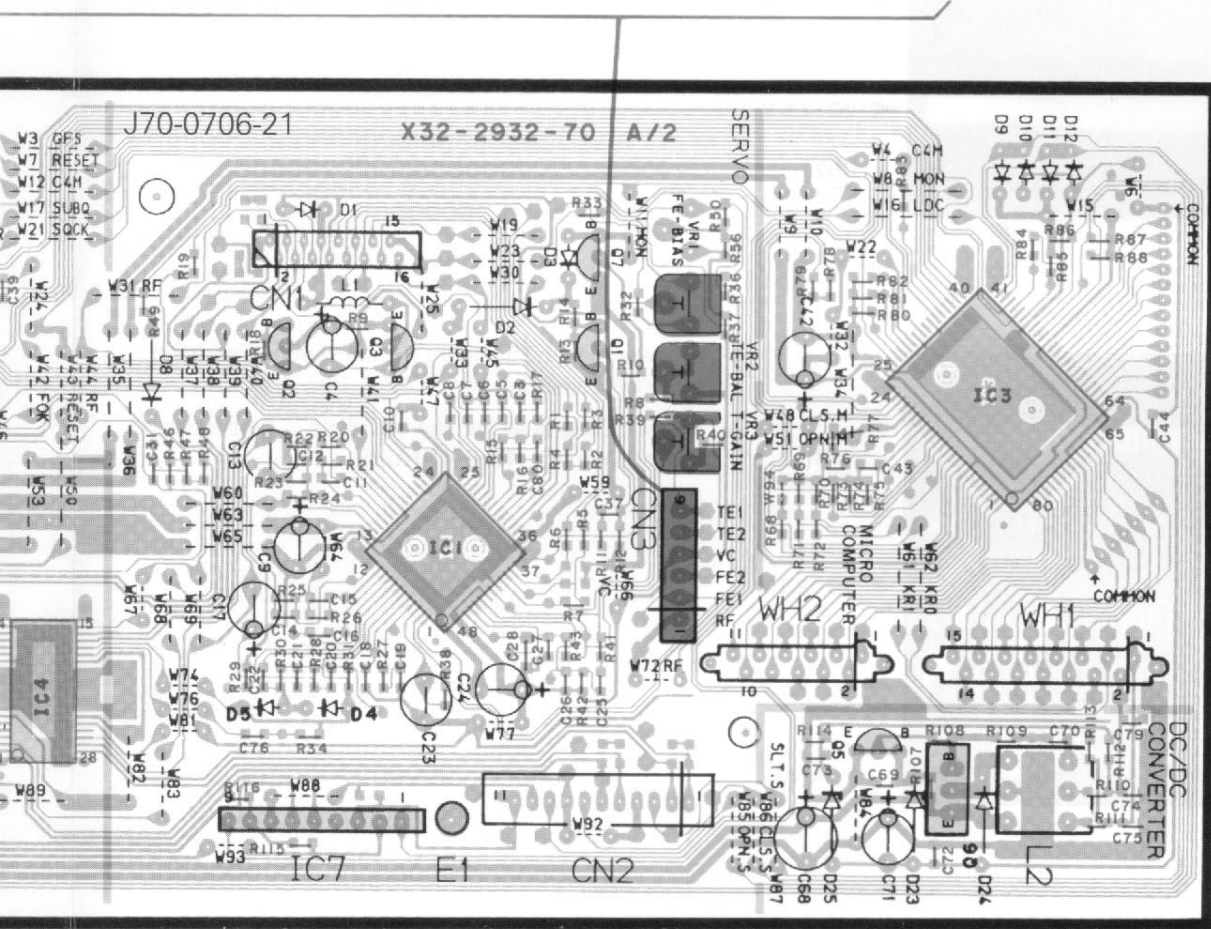
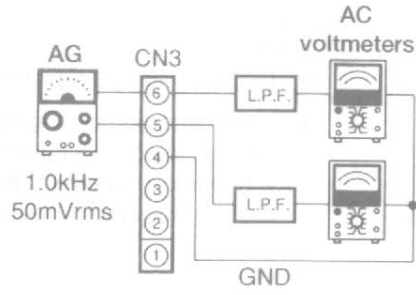

A

B

C

D

E

(X32-2932-70)(A/2)

MECHA. ASS'Y (CDM-22 (11) GS)

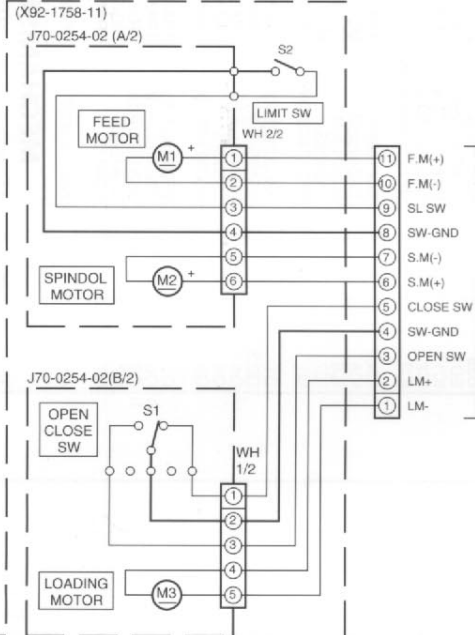

PICKUP: T25-0041-05 (KSS-213B)

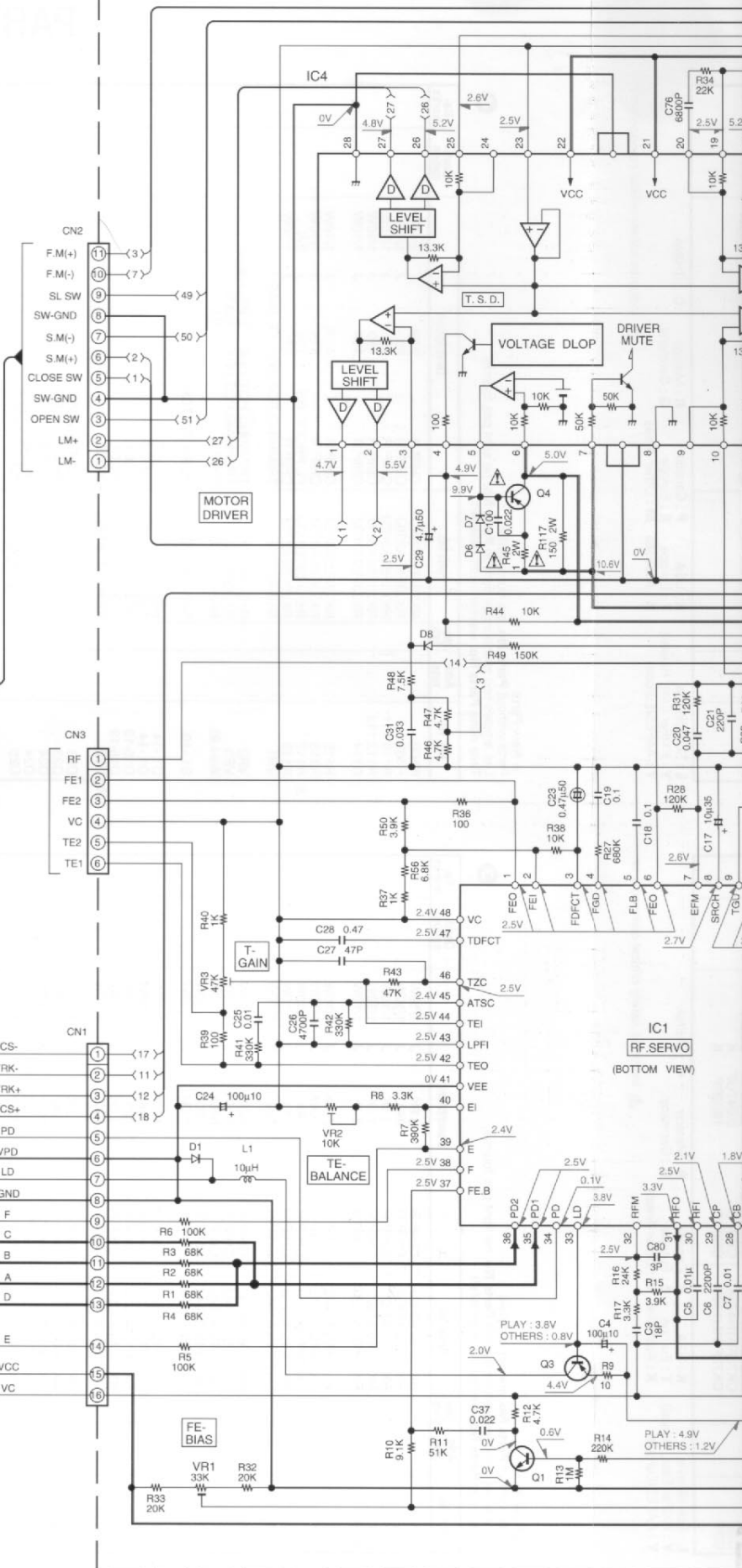
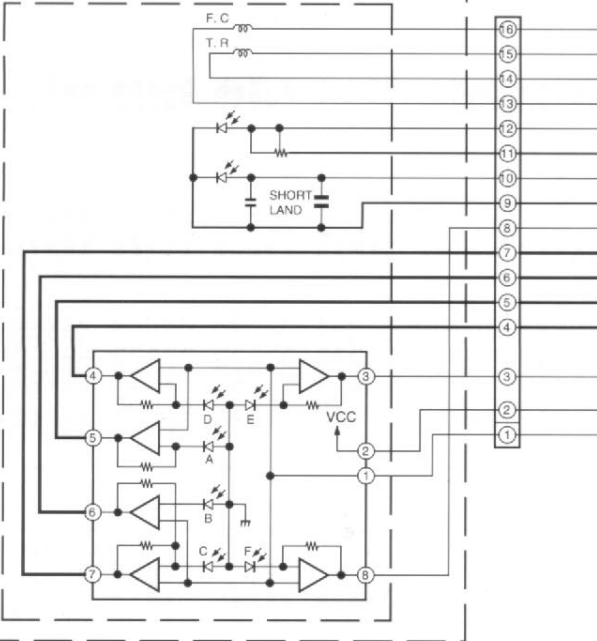

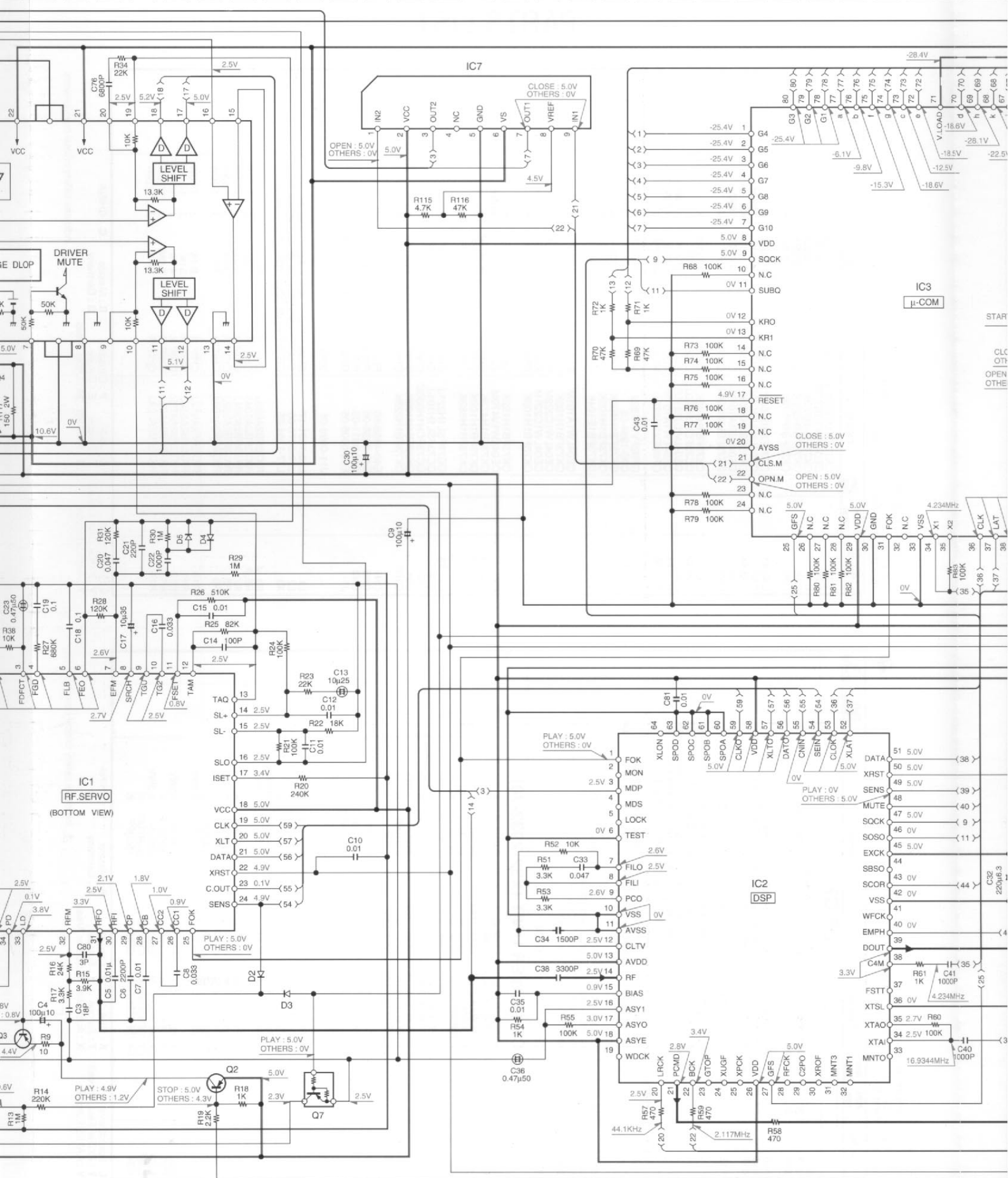

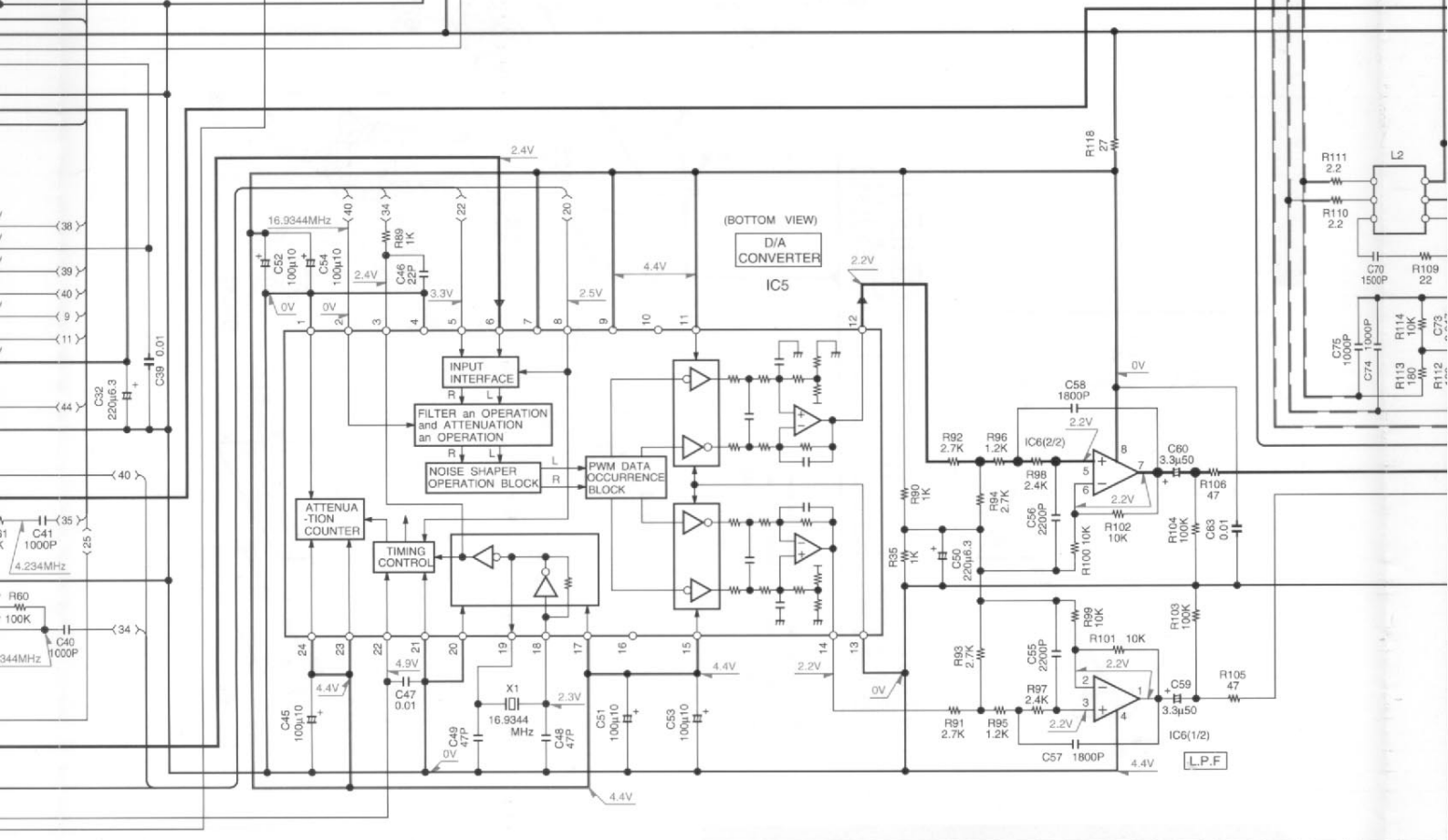
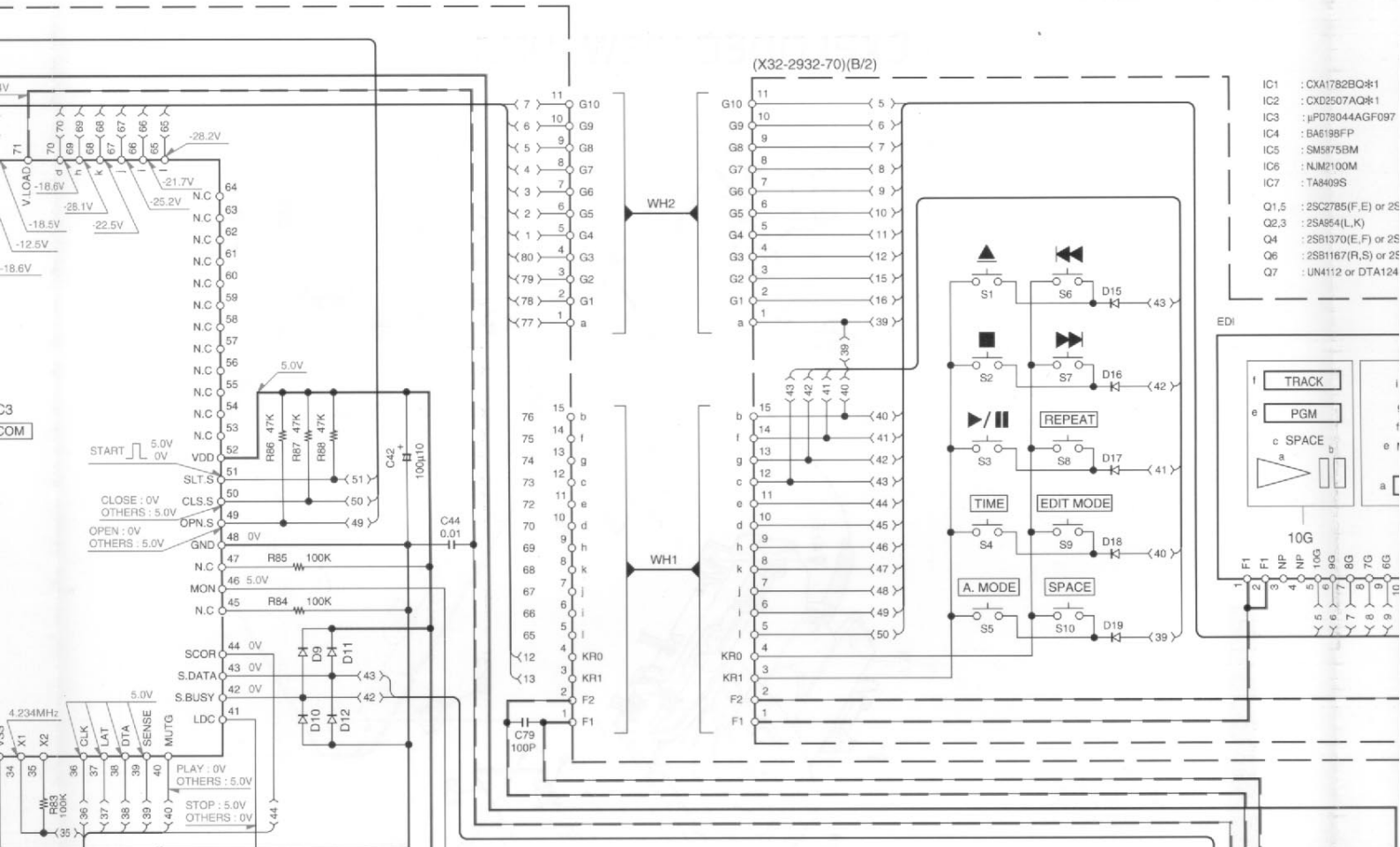



- C1 : CXA1782BQ\*1
- C2 : CXD2507AQ\*1
- C3 : μPD78044AGF097
- C4 : BA6198FP
- C5 : SM5875BM
- C6 : NJM2100M
- C7 : TA8409S
- D1-14 : 1SS133 or HSS104
- D15-19 : 1SS131 or HSS104A
- D22 : KBP02ML-6127
- D23 : UZ-30BS or MTZJ30(B)
- D24 : 1SS92 or 1S954
- D25 : UZ-6.8BSB or MTZJ6.B(B)

- D1-14 : 1SS133 or HSS104
- D15-19 : 1SS131 or HSS104A
- D22 : KBP02ML-6127
- D23 : UZ-30BS or MTZJ30(B)
- D24 : 1SS92 or 1S954
- D25 : UZ-6.8BSB or MTZJ6.B(B)

EDI : 10-BT-67GSK

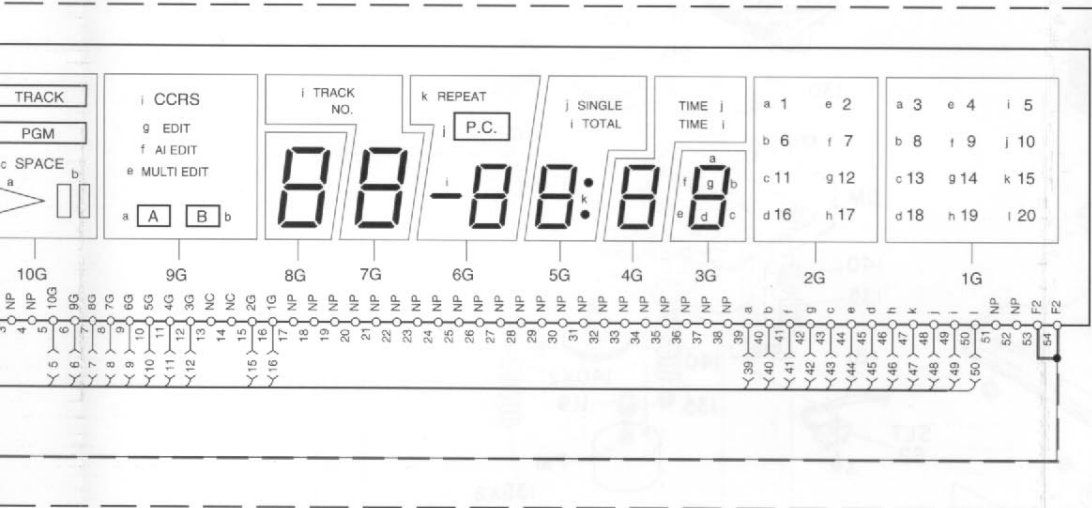

2SA954

2SC2785

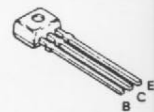
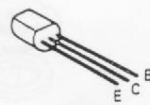

2SB1370

2SB1375



TA8409S

SM5875BM

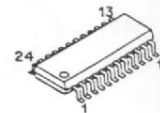
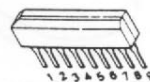

CXA1782BQ\*1

BA6198FP

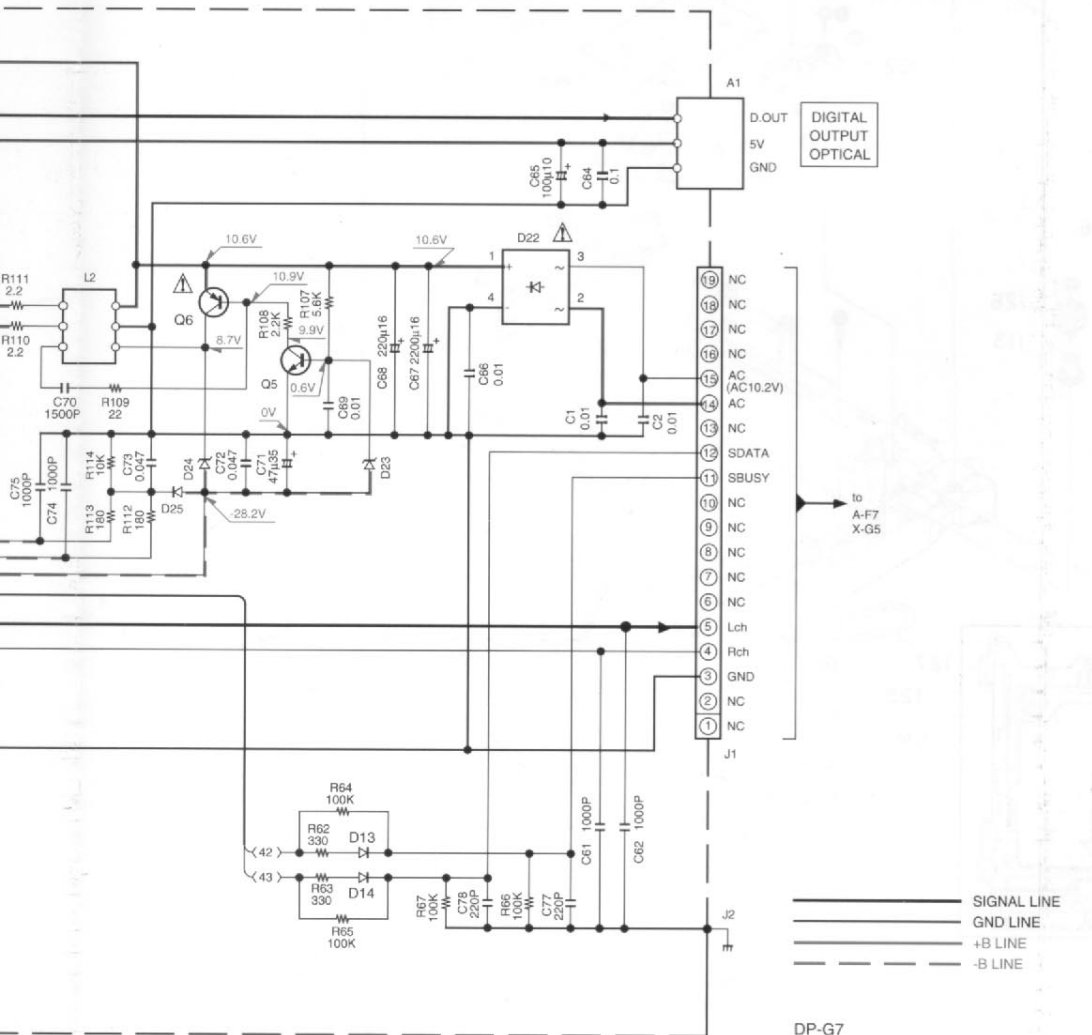
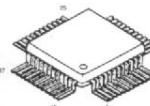

**CAUTION:** For continued safety, replace components only with manufacturer's recommendations to parts list).  $\Delta$  indicates safety critical protection against risk of fire same type and rating fuse(s). To reduce shock, leakage-current or resistance may be carried out (exposed parts are accepted the supply circuit) before the appliance customer.

The DC voltage is an actual reading measured with an impedance type voltmeter. The measurement vary depending on the measuring instrument used. Refer to the voltage during operation; The value shown in ( ) is measured at the moment of STOP.



DP-G7

- D1-14 : 1SS133 or HSS104
- D15-19 : 1SS131 or HSS104A
- D22 : KBP02ML-6127
- D23 : UZ-30BS or MTZJ30(B)
- D24 : 1SS92 or 1S954
- D25 : UZ-6.8BSB or MTZJ6.8(B)

EDI : 10-BT-67GSK

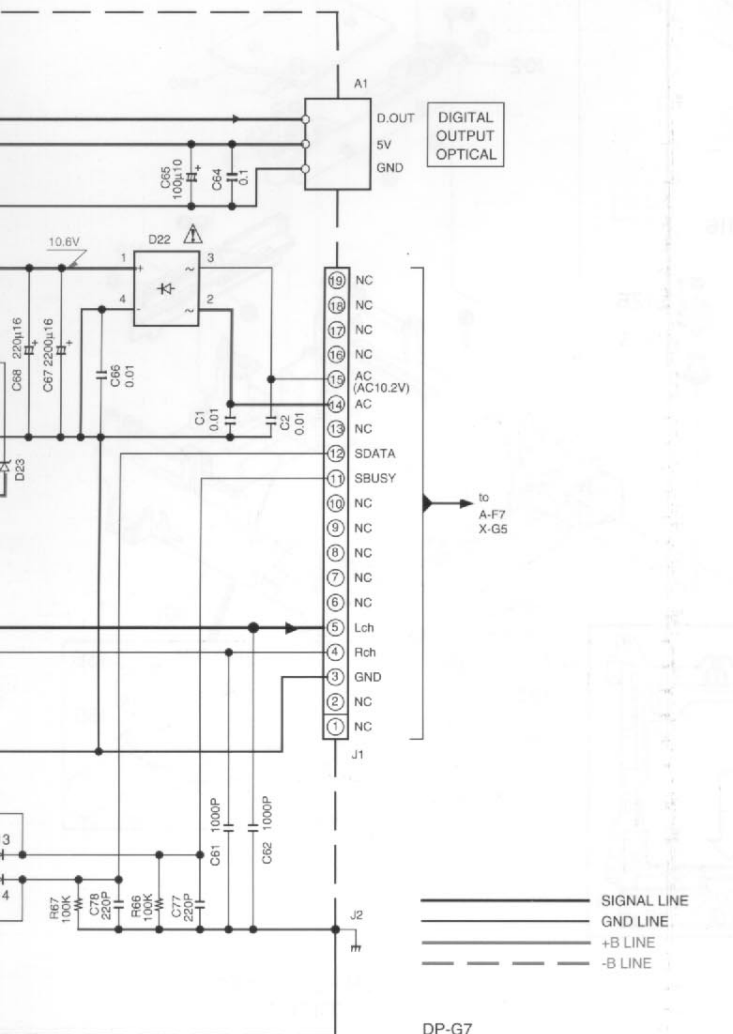
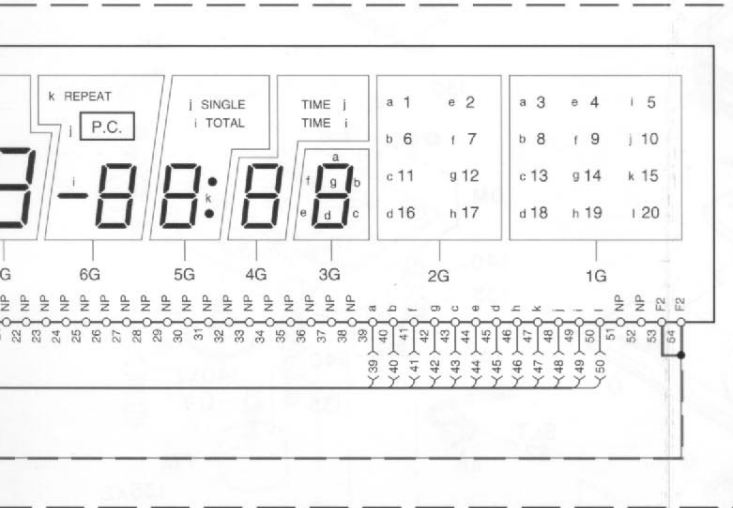

\_\_\_\_\_ SIGNAL LINE  
 \_\_\_\_\_ GND LINE  
 \_\_\_\_\_ +B LINE  
 \_\_\_\_\_ -B LINE

DP-G7

2SA954

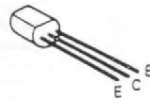

2SC2785

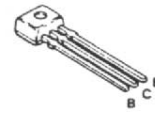

DTA124ES  
UN4112  
2SC1740S

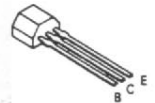

2SB1370



2SB1375



2SB1167  
2SB1168



TA8409S

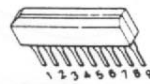

SM5875BM

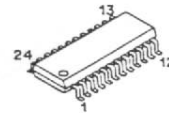

UPD78044AGF097

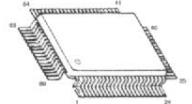

CXA1782BQ\*1

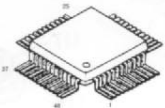

BA6198FP

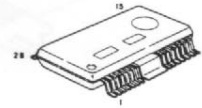

**CAUTION:** For continued safety, replace safety critical components only with manufacturer's recommended parts (refer to parts list).  $\Delta$  indicates safety critical components. For continued protection against risk of fire, replace only with same type and rating fuse(s). To reduce the risk of electric shock, leakage-current or resistance measurements shall be carried out (exposed parts are acceptably insulated from the supply circuit) before the appliance is returned to the customer.

The DC voltage is an actual reading measured with a high impedance type voltmeter. The measurement value may vary depending on the measuring instruments used or on the product. Refer to the voltage during PLAY unless otherwise specified; The value shown in ( ) is the voltage measured at the moment of STOP.

Y22-4532-70

**DP-G7**  
**KENWOOD**

## EXPLODED VIEW (MECHANISM)

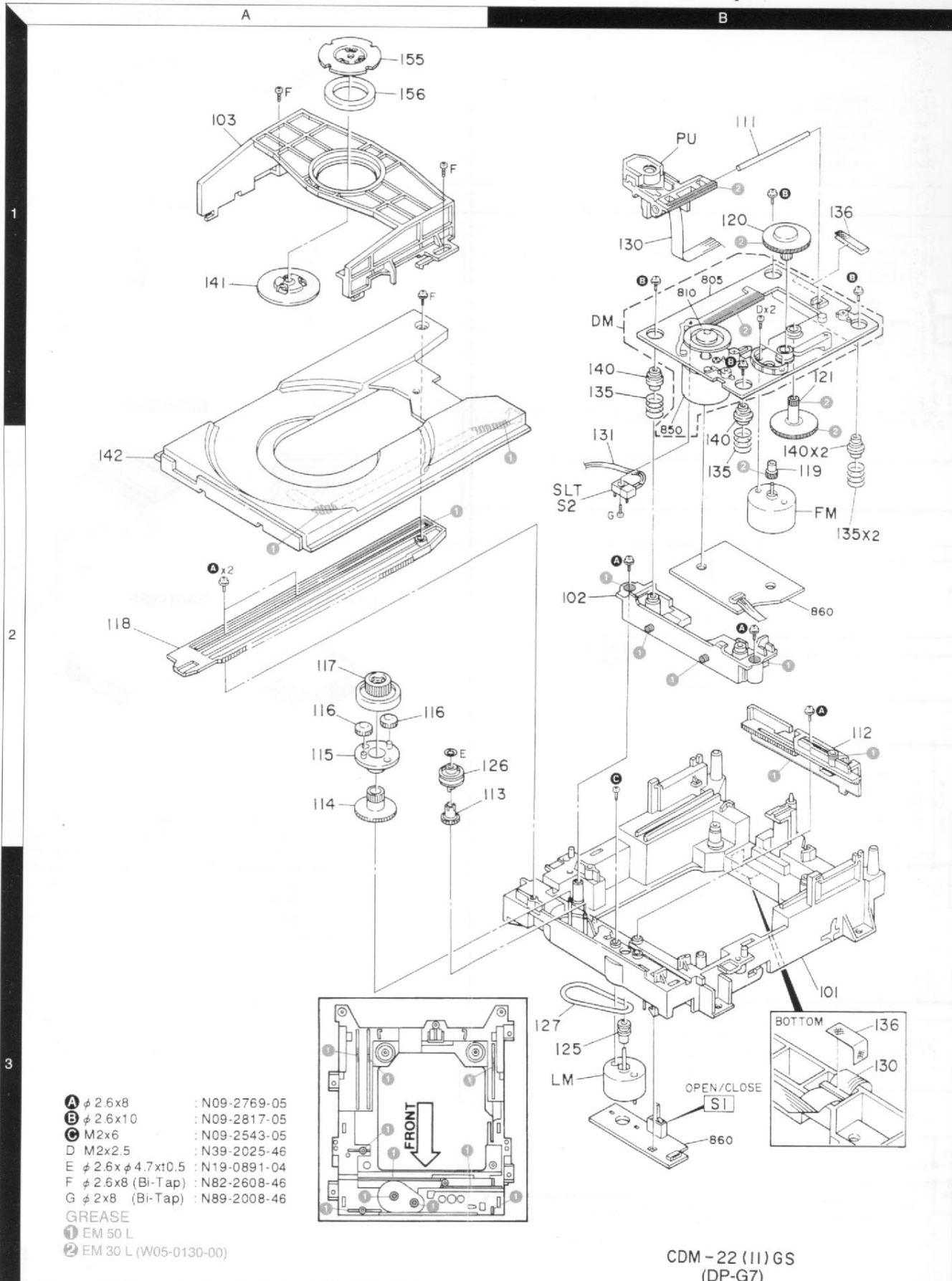

# DP-G7 DP-G7

## FRONT VIEW (MECHANISM)

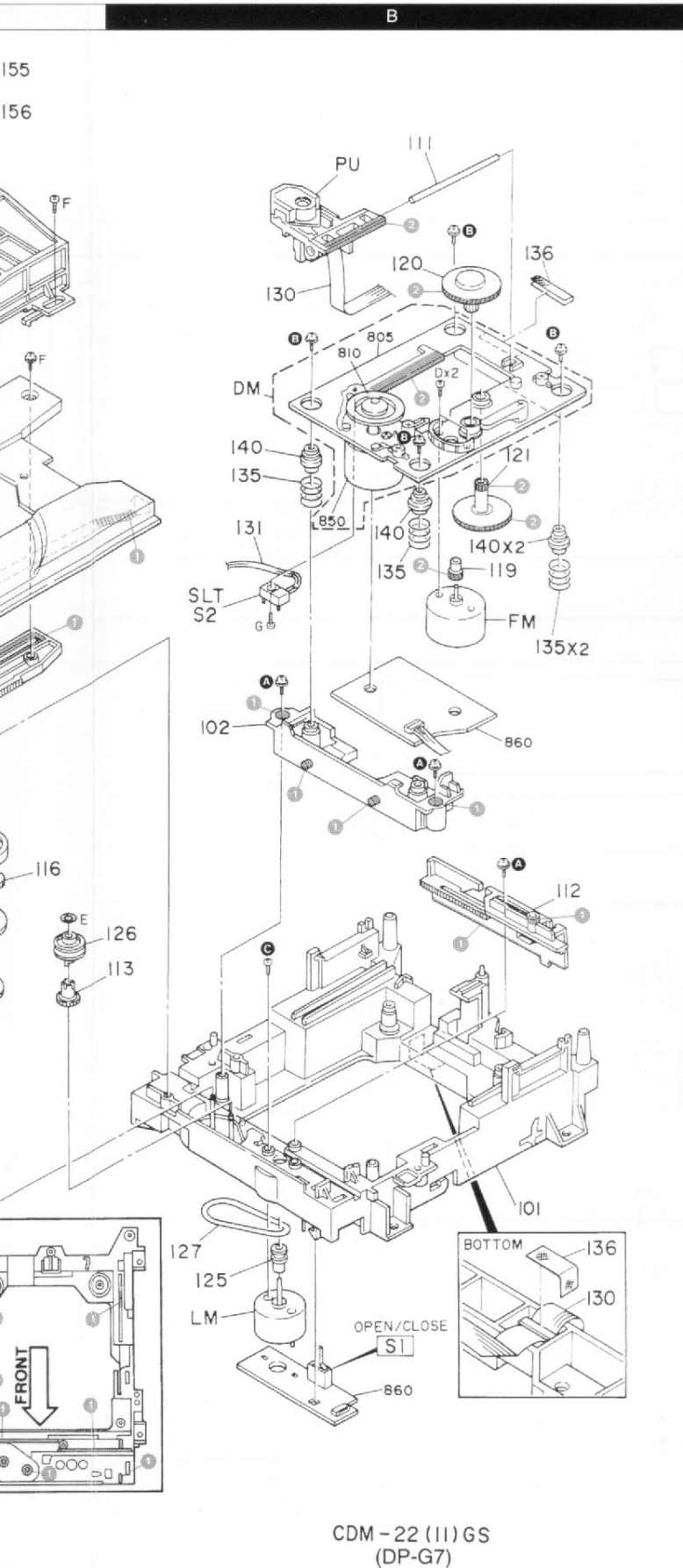

Parts with the exploded numbers larger than 700 are not supplied.

## EXPLODED VIEW (UNIT)

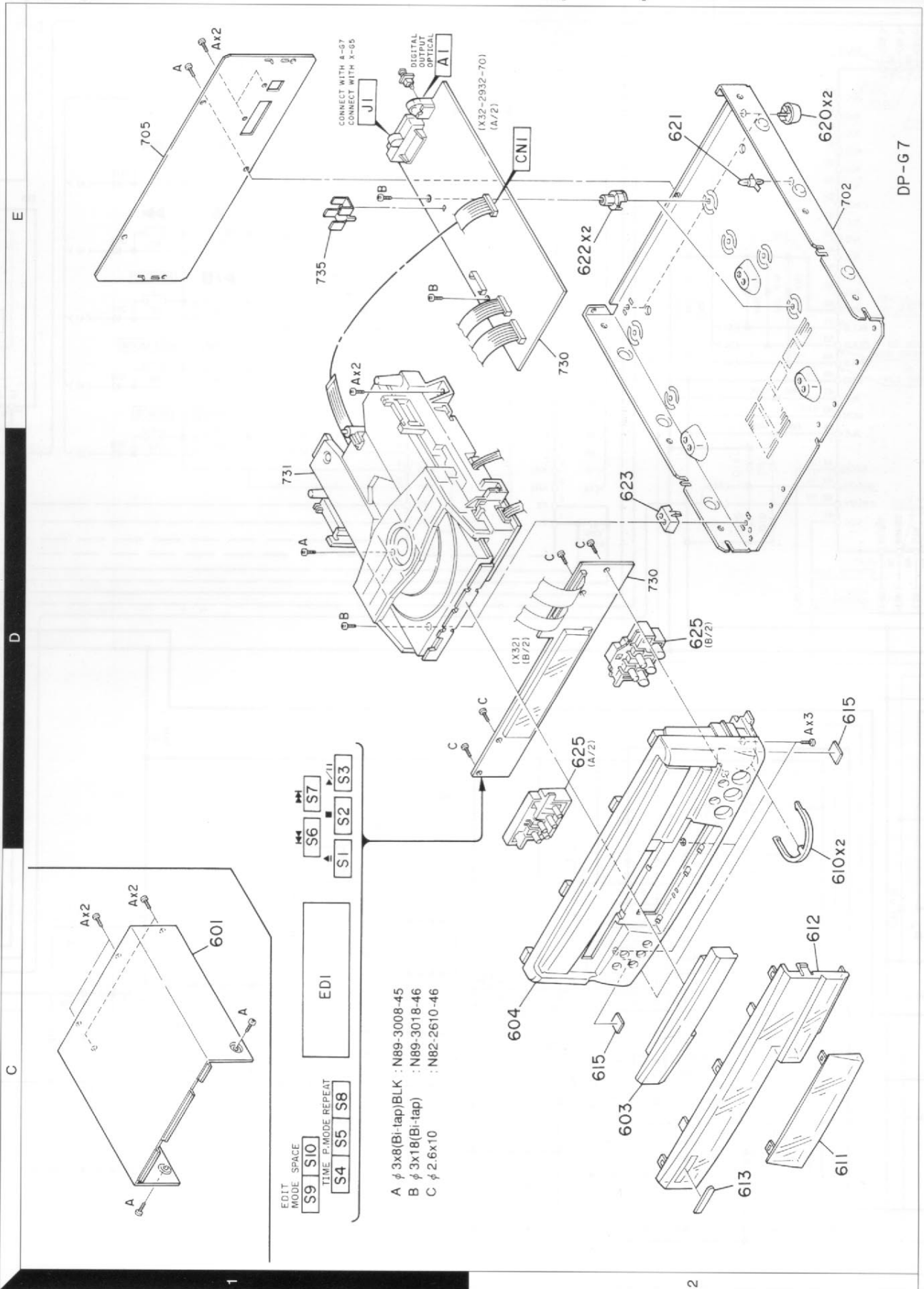

# DP-G7

## SPECIFICATIONS

Laser.....Semiconductor laser  
Playing rotation.....200 rpm ~ 500 rpm (CLV)  
Frequency response .....8 Hz ~ 20 kHz,  $\pm$  1.0 dB  
Signal to noise ratio .....More than 95 dB  
Total harmonic distortion  
.....Less than 0.007 % (at 1 kHz)  
Channel separation ..... More than 90 dB (at 1 kHz)  
Wow & Flutter.....Unmeasurable Limit  
Digital output optical  
.....-15 dBm~ -21 dBm(wave length 660 nm)

### [General]

Dimensions.....W : 270 mm (10 - 5 / 8")  
H : 104 mm (4 - 1 / 8")  
D : 320 mm (12 - 5 / 8")  
Weight (net) .....2.2 kg (4.9 lb)

KENWOOD follows a policy of continuous advancements in development.  
For this reason specifications may be changed without notice.

#### Note:

Component and circuitry are subject to modification to insure best operation under differing local conditions. This manual is based on the General Market (M) standard, and provides information on regional circuit modification through use of alternate schematic diagrams, and information on regional component variations through use of parts list.

## KENWOOD CORPORATION

14-6,Dogenzaka 1-chome, Shibuya-ku, Tokyo, 150 Japan

### KENWOOD SERVICE CORPORATION

P.O BOX 22745, 2201 East Dominguez St., Long Beach, CA 90801-5745, U.S.A.

### KENWOOD ELECTRONICS CANADA INC.

6070 Kestrel Road, Mississauga, Ontario, Canada L5T 1S8

### KENWOOD ELECTRONICS LATIN AMERICA S.A.

P.O BOX 55-2791, Piso 6 plaza Chase, Cl. 47 y Aquilino de la Guardia Panama, Republic de Panama

### KENWOOD ELECTRONICS U.K. LIMITED

KENWOOD House, Dwight Road, Watford, Herts., WD1 8EB., United Kingdom

### KENWOOD ELECTRONICS BENELUX N.V.

Meachelsesteenweg 418, B-1930 Zaventem, Belgium

### KENWOOD ELECTRONICS DEUTSCHLAND GMBH

Rembrücker Str. 15, 63150 Heusenstamm, Germany

### KENWOOD ELECTRONICS FRANCE S.A.

13 Boulevard Ney, 75018 Paris, France

### KENWOOD ELECTRONICS ITALIA S.p.A.

Via G. Sirtori, 7/9 20129, Milano, Italy

### KENWOOD IBÉRICA S.A.

Bolivia, 239-08020 Barcelona, Spain

### KENWOOD ELECTRONICS AUSTRALIA PTY. LTD. (A.C.N. 001499 074)

P.O Box 504, 8 Figtree Drive, Australia Centre, Homebush, N.S.W. 2140, Australia

### KENWOOD & LEE ELECTRONICS, LTD.

Unit 3712-3724, Level 37, Tower 1, Metroplaza, 223 Hing Fong Road, Kwai Fong N.T., Hong Kong

### KENWOOD ELECTRONICS SINGAPORE PTE LTD.

No. 1 Genting Lane #02-02, KENWOOD Building, Singapore, 349544

### KENWOOD ELECTRONICS (MALAYSIA) SDN BHD.

#4.01 Level 4, Wisma Academy Lot 4A, Jalan 19/1 46300 Petaling Jaya Selangor Darul Ehsan Malaysia