

KRF-V9992D

VR-3090/3100

SERVICE MANUAL

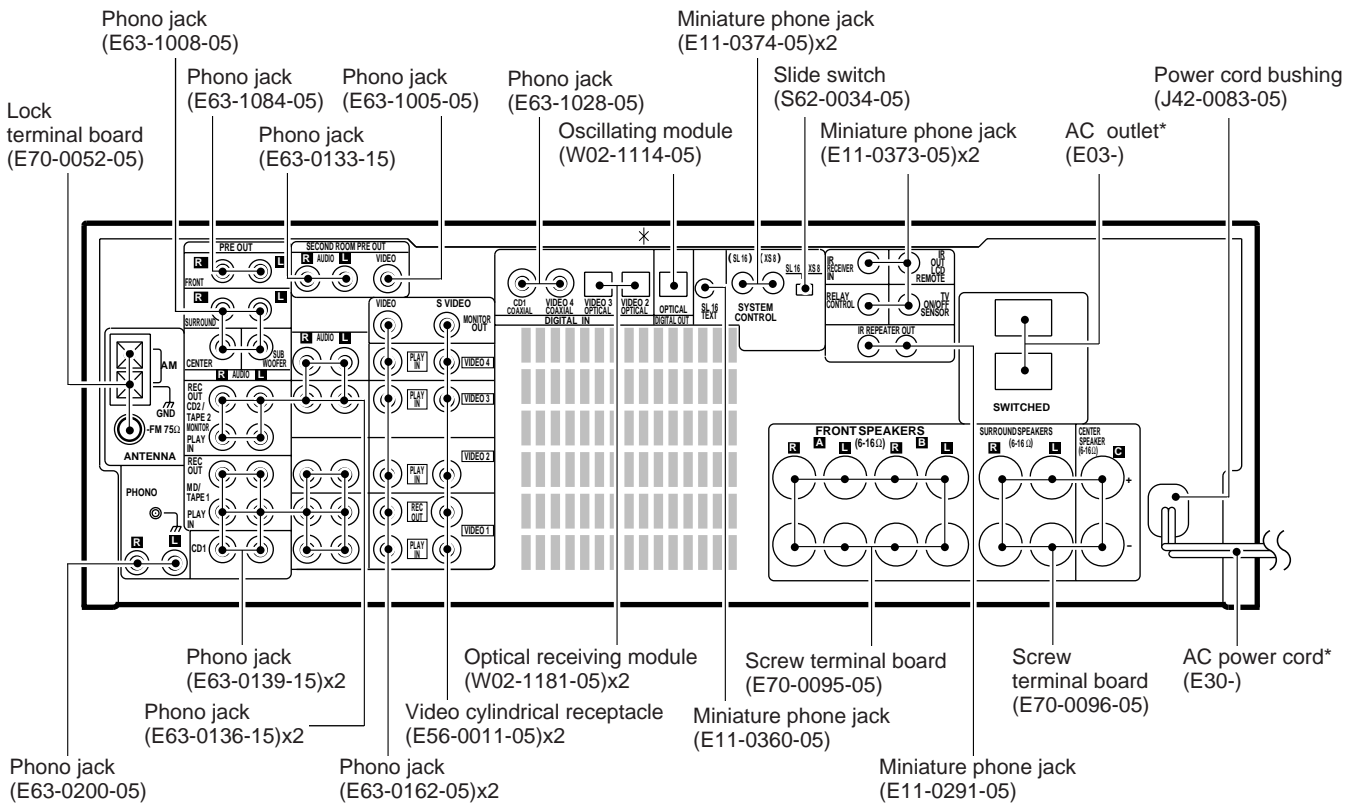
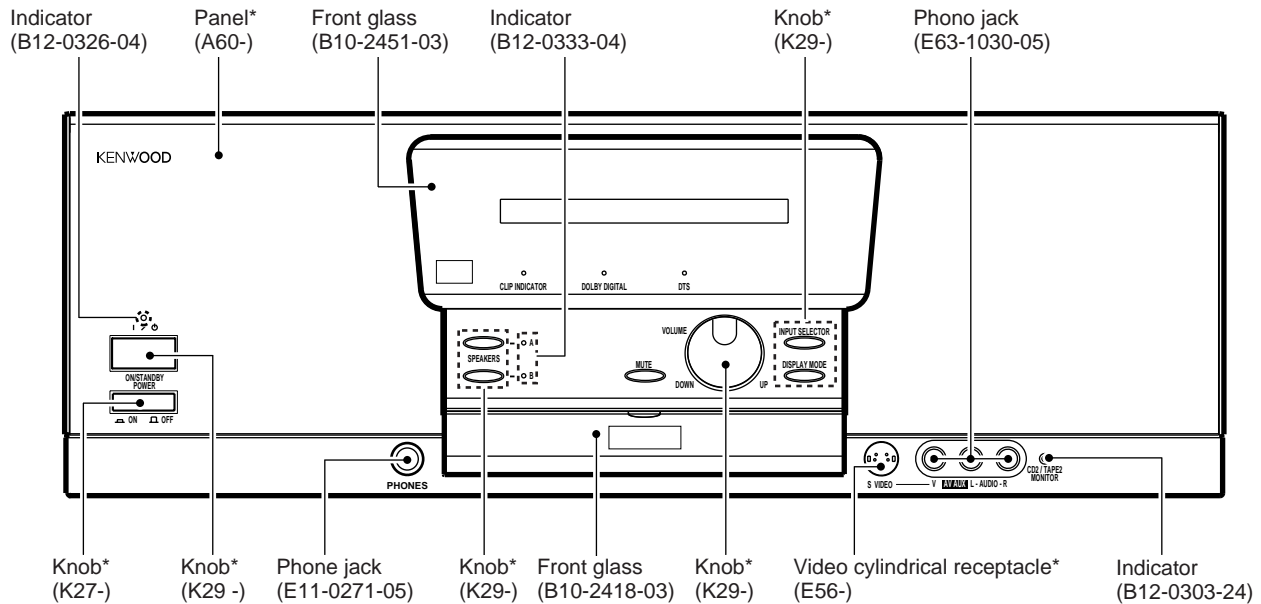

* Refer to parts list on page 42.

Note: Keep this manual with the previous manual (B51-5426-00).



KRF-V9992D/VR-3090/3100

CONTENTS / ACCESSORIES / CAUTIONS

Contents

CONTENTS / ACCESSORIES / CAUTIONS	2	EXPLODED VIEW	41
ADJUSTMENT	3	PARTS LIST	42
PC BOARD	5	SPECIFICATIONS	44
SCHEMATIC DIAGRAM	13		

CAUTION: This manual is not available for information's, disassembly for repair, circuit description, adjustment and wiring diagram. Please refer to KRF-V7771D service manual(B51-5426-00). Also parts list is written a different part from B51-5426-00 manual.

COMPARISON TABLE

	VR-2080	VR-3090	VR-2090	VR-3100	KRF-V8881D	KRF-V9992D
X07	X07-2940-10	X07-2940-10	X07-2940-10	X07-2940-10	X07-2940-21	X07-2940-21
X08	X08-2850-10	X08-2852-92	X08-2850-11	X08-2850-11	X08-2850-22	X08-2850-22
X11	X11-3800-10	X11-3803-81	X11-3800-11	X11-3802-91	X11-3800-21	X11-3800-71
X25	X25-6040-10	X25-6042-71	X25-6040-11	X25-6040-11	X25-6040-22	X25-6040-22

Accessories

Remote control unit (1)
(A70-1285-05)



(RC-R1008)
Battery cover(A09-1130-08)

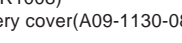

Batteries(R6/AA) (4)

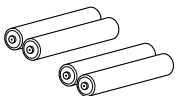

AM loop antenna (1) (T90-0833-05)

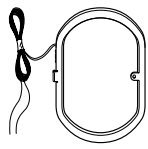

Loop antenna stand (1)
(J19-3645-05)

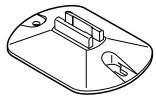

* AC plug adaptor (1)
(E03-0115-05)

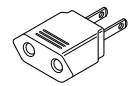

* Use to adapt the plug on the power cord to the shape of the wall outlet. (Accessory only for regions where use is necessary.)

FM indoor antenna (1)
(T90-0841-05)

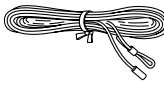

Cautions

How to reset the microcomputer

The microcomputer may malfunction (impossibility of operation, erroneous display, etc.) when the power cord is unplugged and plugged in again while the unit is in ON mode with the I/⏻ key pressed or due to other external causes. In this case, execute the procedure on the right to reset the microcomputer and return the unit to the normal condition.

- Resetting the microcomputer clears the memory you entered and returns it to the initial condition when the unit left the factory.

U.S.A. and Canada

- ① Unplug the power cord from the wall outlet.
- ② While holding the I/⏻ (ON/STANDBY) key depressed, plug the power cord into the wall outlet again.

Expect for U.S.A. and Canada

- ① With the power cord plugged in, turn the POWER key OFF.
- ② Whill holding down the ON/STANDBY key, press POWER key.

Memory backup function

Please note that the following items will be deleted from this unit's memory if the power cord is disconnected from the AC outlet for approximately three days.

- The input selection is cleared and the "Tuner" input is selected.
- The volume setting is cleared and the volume is set to "-66 dB".
- The receiving band setting is cleared and the "FM" band is selected.
- The frequency setting is cleared and 87.5 MHz is selected.
- The preset station memory is cleared.
- The surround setting is cleared and reset to the initial condition.

ADJUSTMENT

No.	ITEM	INPUT SETTINGS	OUTPUT SETTINGS	RECEIVER SETTINGS	ALIGNMENT POINTS	ALIGN FOR	FIG.
FM SECTION : Except M type		SELECTOR : FM		*Adjust NO.1 and NO.2 repeat.			
1	DISCRIMINATOR	(A) 98.0MHz 1kHz, ±75kHz dev. 70dBf (ANT. input)	Connect a DC voltmeter between CN12 ① and CN12 ② (X11)	MONO 98.0MHz	L604 (X11)	0V	
2	DISTORTION (MONO)	(A) 98.0MHz 1kHz, ±75kHz dev. MONO 70dBf (ANT. input)	(B)	MONO 98.0MHz	L605 (X11)	Minimum distortion	
3	DISTORTION (STEREO)	(C) 98.0MHz 1kHz, ±67.5kHz dev. Selector : L or R Pilot : ±7.5kHz dev. 70dBf (ANT. input)	(B)	AUTO 98.0MHz	IFT(RF FRONTEND : A1)	Minimum distortion (L or R)	
4	TUNING LEVEL	(A) 98.0MHz MONO 1kHz, ±75kHz dev. 15dBf (ANT. input)	(B)	MONO 98.0MHz	VR601 (X11)	Adjust VR601 and stop at the point where ED1 (TUNED) goes on.	
FM SECTION :M type only		SELECTOR : FM					
1	DISTORTION (STEREO)	(C) 98.0MHz 1kHz, ±67.5kHz dev. Selector : L or R,Pilot : ±7.5kHz dev. 70dBf (ANT. input)	(B)	AUTO 98.0MHz	IFT (TUNER UNIT : A601)	Minimum distortion (L or R)	
2	TUNING LEVEL	(A) 98.0MHz MONO 1kHz, ±75kHz dev. 15dBf (ANT. input)	(B)	MONO 98.0MHz	VR601 (TUNER UNIT)	Adjust VR601 and stop at the point where ED1 (TUNED) goes on.	

SYSTEM CONNECTIONS

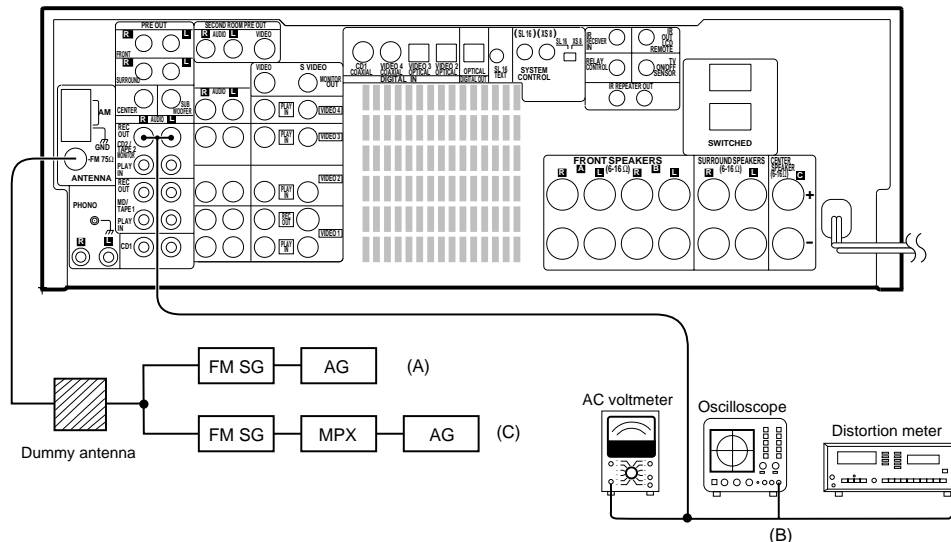

KRF-V9992D/VR-3090/3100

ADJUSTMENT

No.	ITEM	INPUT SETTINGS	OUTPUT SETTINGS	RECEIVER SETTINGS	ALIGNMENT POINTS	ALIGN FOR	FIG.
AUDIO SECTION		SPEAKER : A		PREOUT : OFF		PROLOGIC : ON	
<1>	IDLE CURRENT	—	Connect a DC voltmeter across CN1 (each port) 1, 2 pin : L 5, 6 pin : R 3, 4 pin : SL 7, 8 pin : SR 9, 10 pin : C	(FRONT 2ch MODE) Volume:0	VR1(L) VR2(R) VR3(SL) VR4(SR) VR5(CENTER) (X07-)	10mV	

PC BOARD(Component side view)

X07-294X-XX A/8 (J70-1153-11)

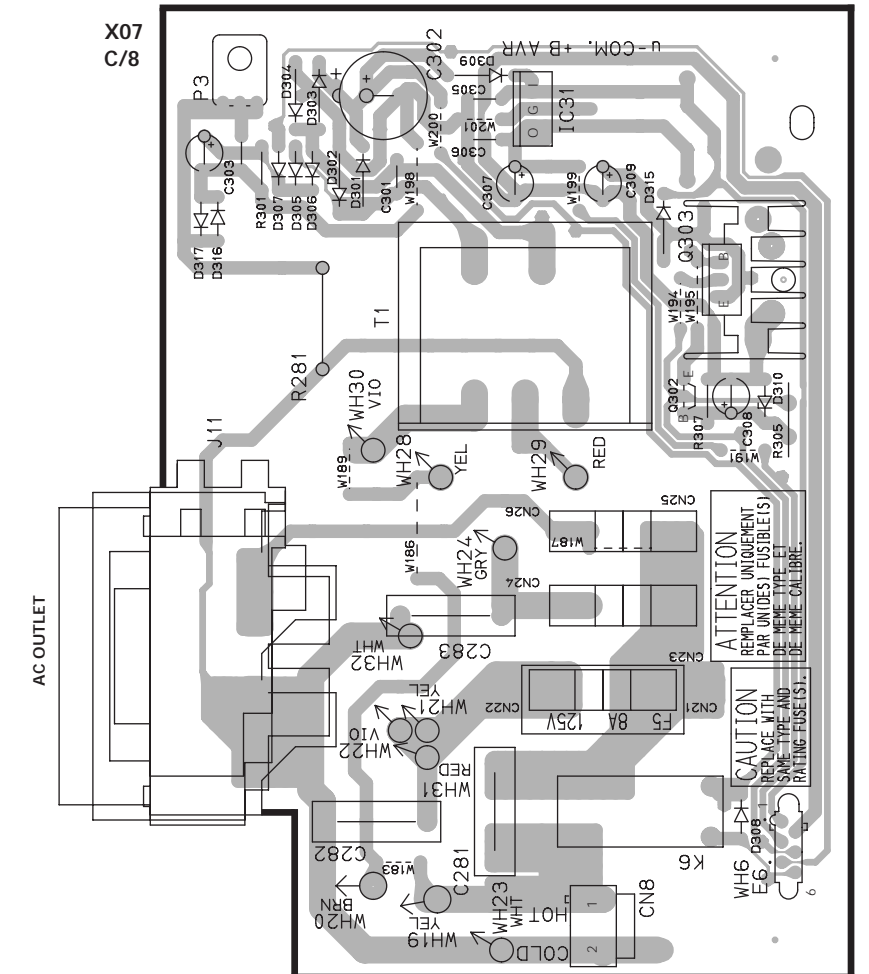
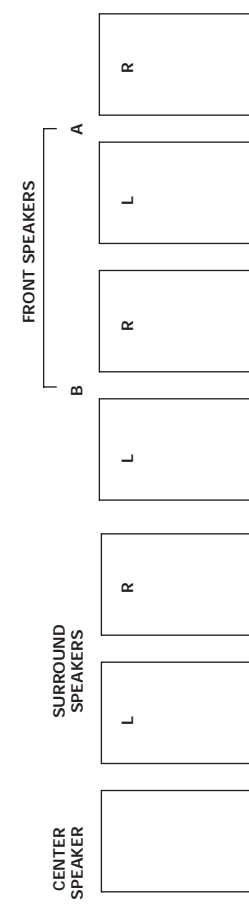
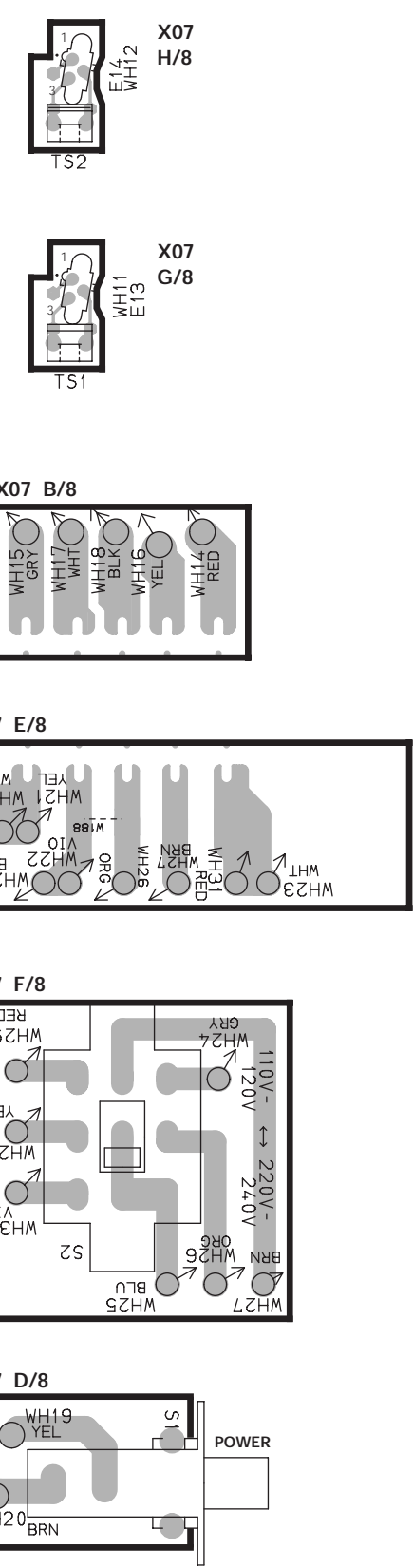
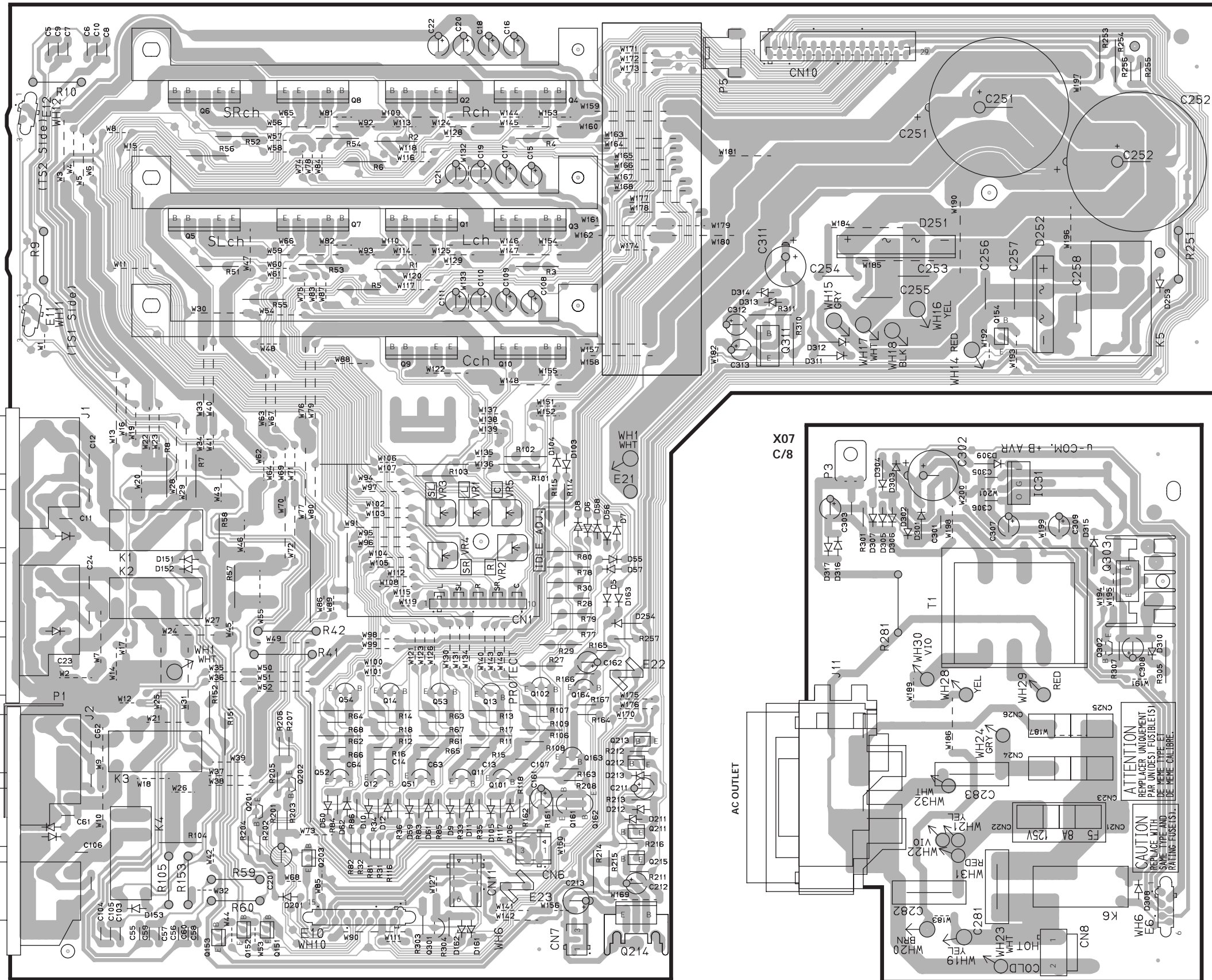

Refer to the schematic diagram for the value of resistors and capacitors.

PC BOARD(Component side view)

X08-2850-10 (J70-1143-51)

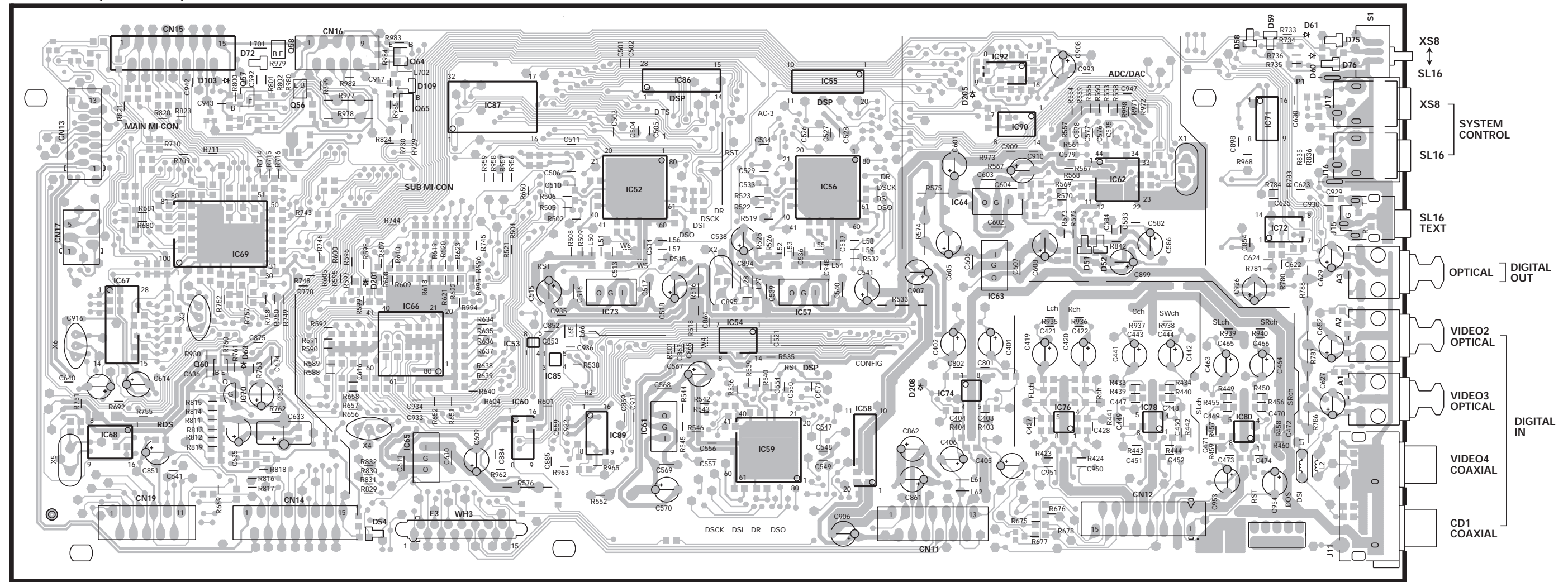

PC BOARD(Component side view)

X08-2850-10 (J70-1143-51)

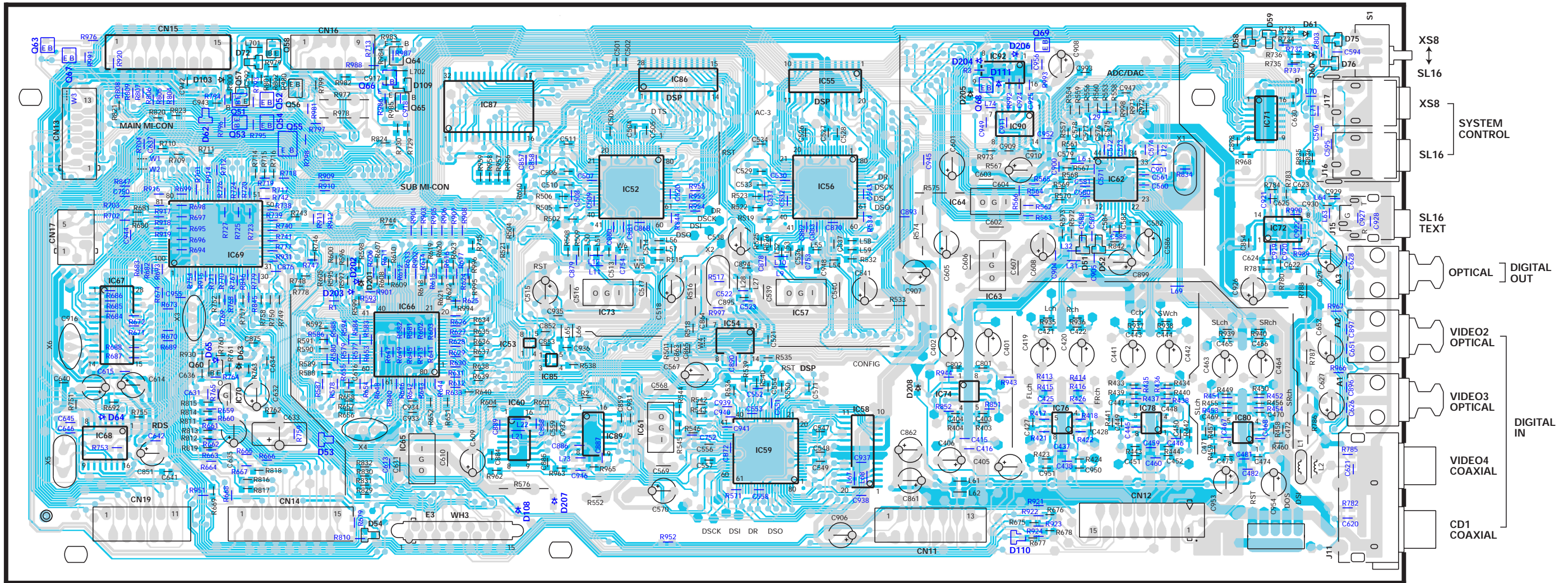

PC BOARD(Component side view)

X25-6040-10 A/7 (J70-1138-31)

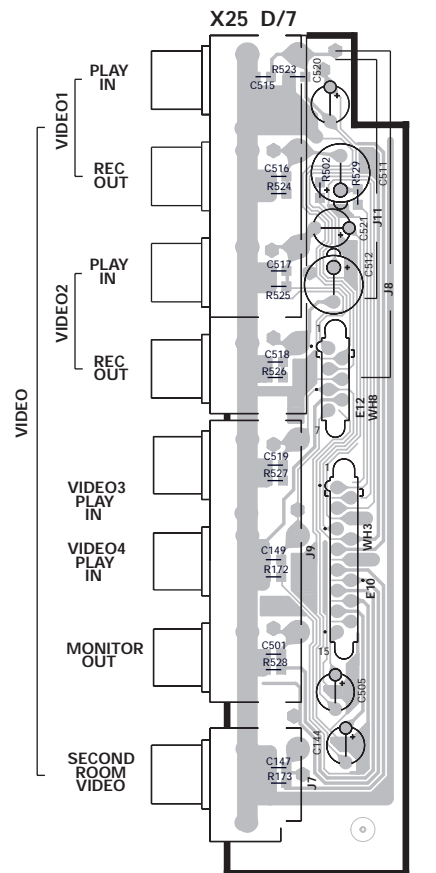
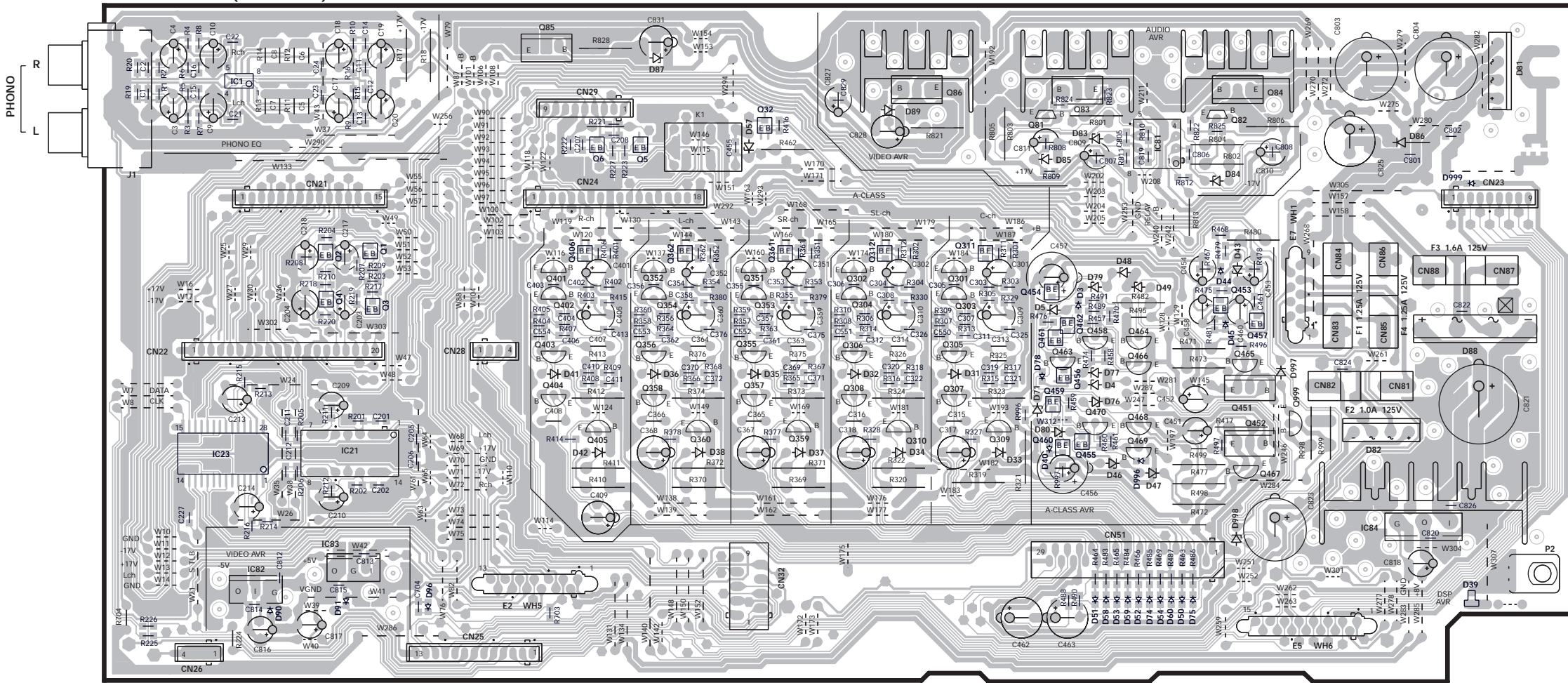

X25 B/7

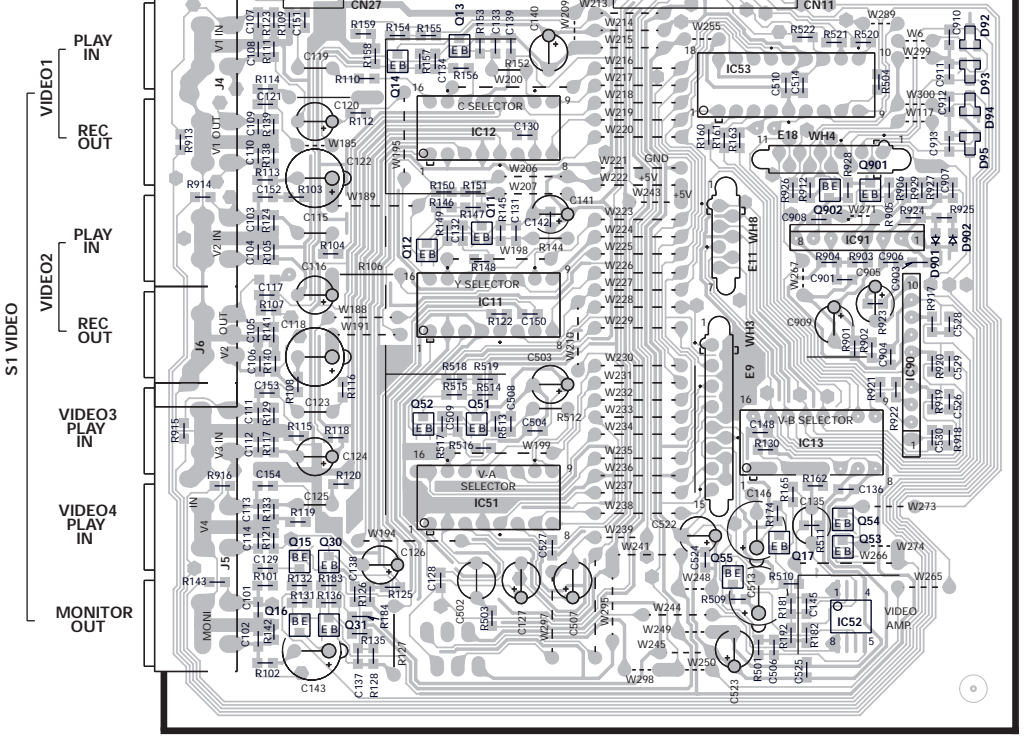

X25 E/7

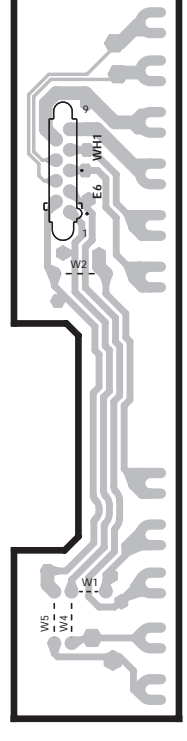

X25 C/7

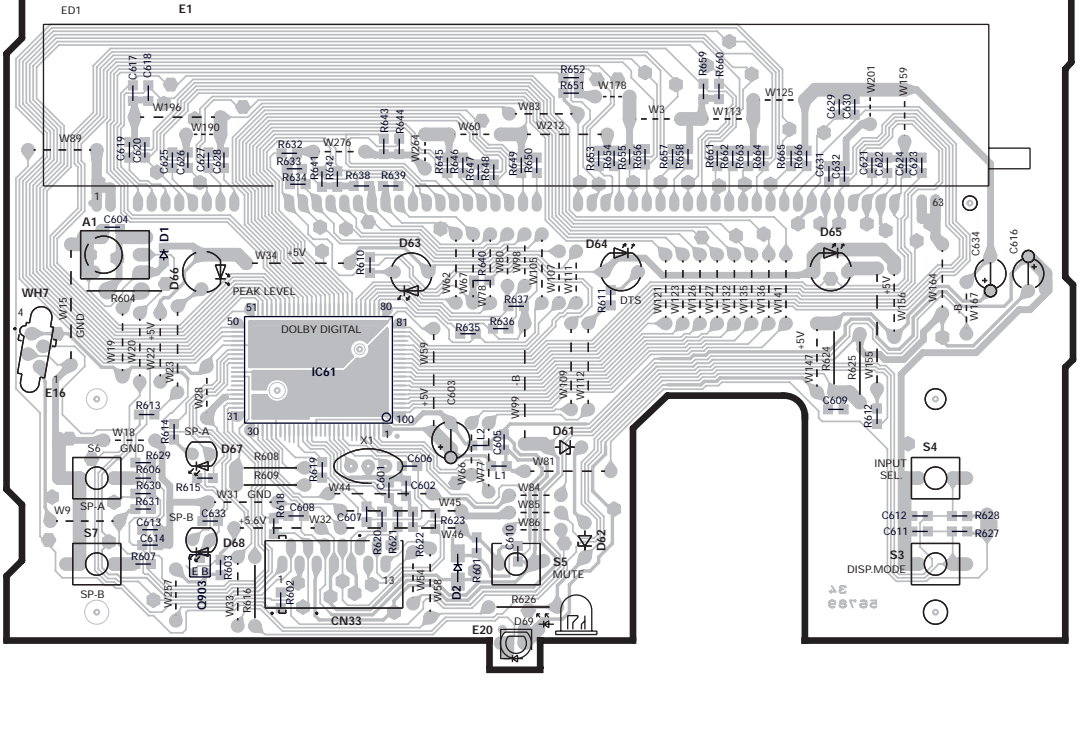

X25 F/7

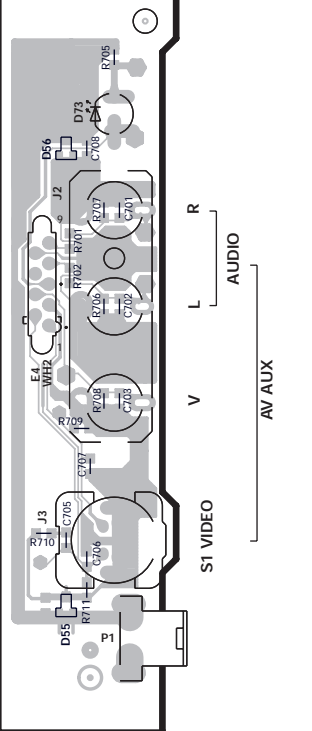

X25 G/7

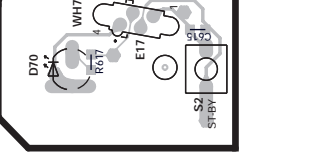

Refer to the schematic diagram for the value of resistors and capacitors.

TUNER UNIT
(X11-380X-XX) (C/7)

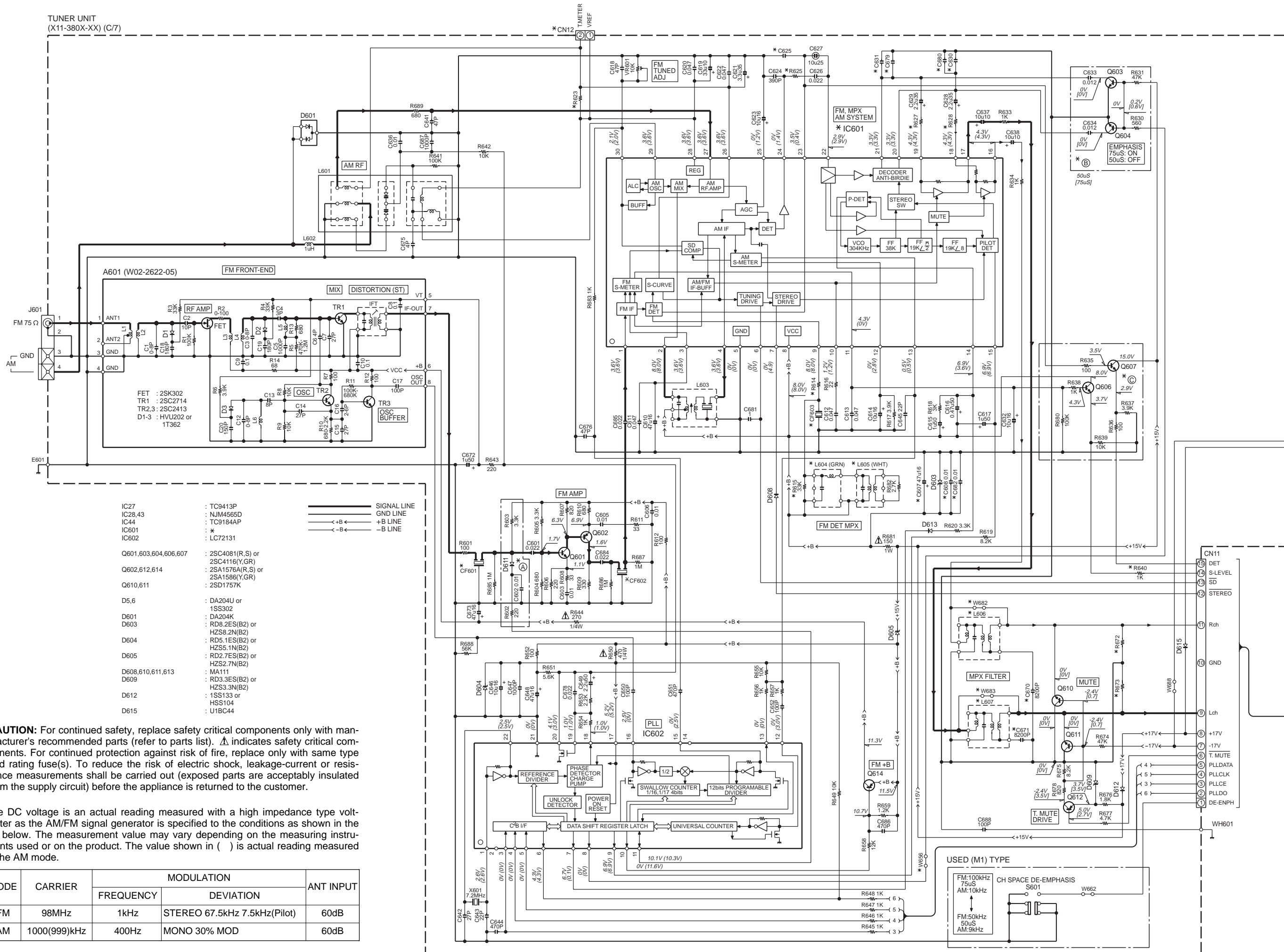

MODE	CARRIER	MODULATION		ANT INPUT
		FREQUENCY	DEVIATION	
FM	98MHz	1kHz	STEREO 67.5kHz 7.5kHz(Pilot)	60dB
AM	1000(999)kHz	400Hz	MONO 30% MOD	60dB

USED (M1) TYPE

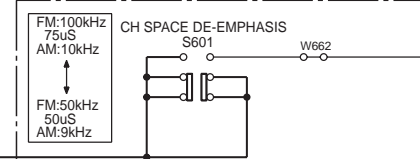

(X11-380X-XX) (C/7)

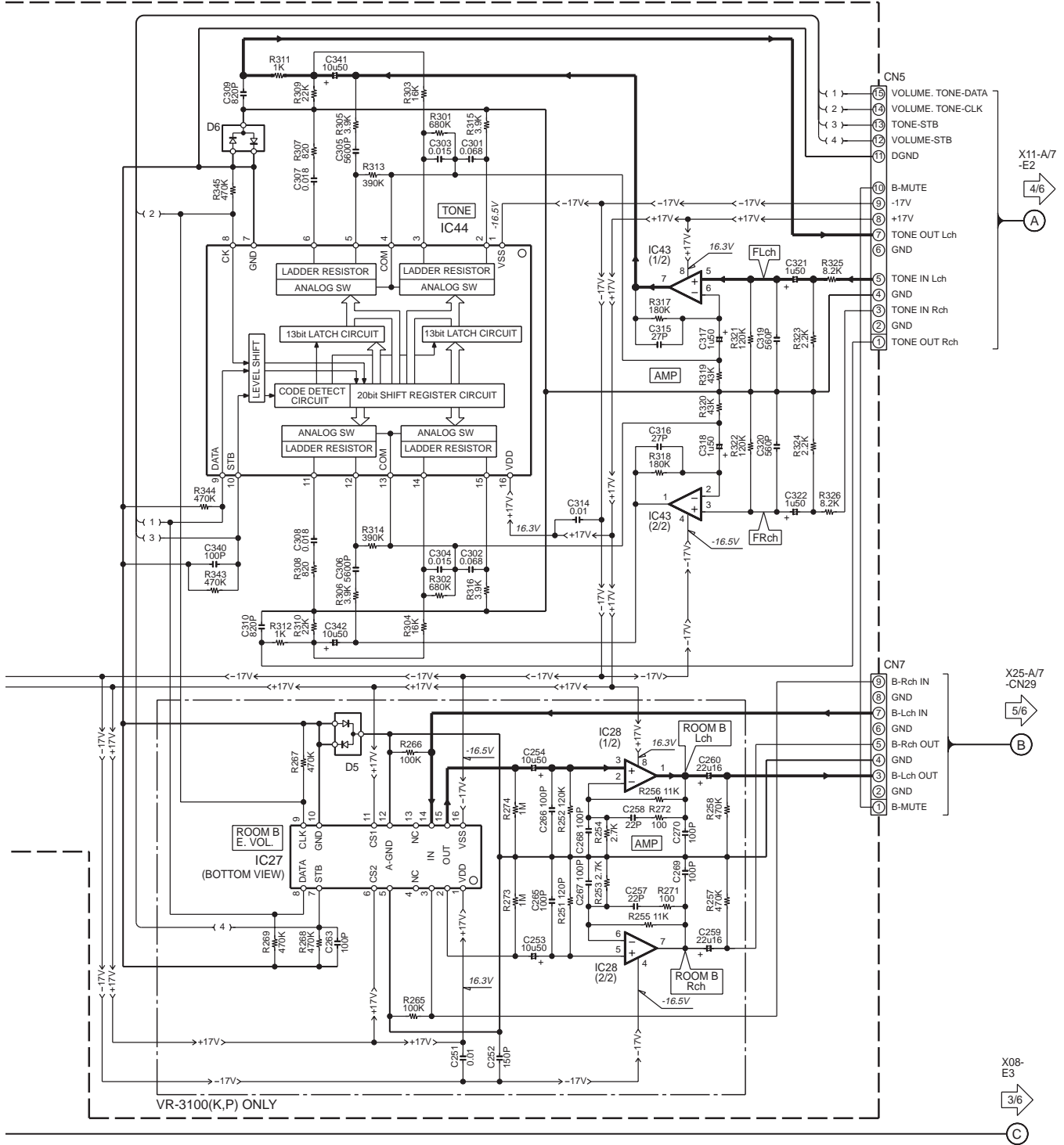

VR-3090 (X11-3803-81)

DESTINATION	COUNTRY	ABB.	UNIT No.	Ⓐ	Ⓑ	Ⓒ	C608	C625	C630, 631	C670, 671,682	C679, 680	R614	R615, 682	R623	R625	R627, 628	R640	R672, 673	W656,662, 682,683	L604-607	CF601, 602	CF603	IC601	CN12
U.S.A.	K1		3-81	NO	NO	NO	150P	0.033	YES	3900P	100	YES	11K	18K	4.7K	NO	3.9K	NO	YES	MS2	NO	LA1837	YES	
CANADA	P2																							

VR-3100 (X11-3802-91)

DESTINATION	COUNTRY	ABB.	UNIT No.	Ⓐ	Ⓑ	Ⓒ	C608	C625	C630, 631	C670, 671,682	C679, 680	R614	R615, 640,682	R623	R625	R627, 628	R672, 673	W656,662, 682,683	L604-607	CF601, 602	CF603	IC601	CN12	
U.S.A.	K		2-91	YES	NO	NO	150P	0.033	YES	3900P	100	YES	11K	18K	4.7K	3.9K	NO	YES	MS2	NO	LA1837	YES		
CANADA	P1																							

KRF-V9992D (X11-3800-71)

DESTINATION	COUNTRY	ABB.	UNIT No.	Ⓐ	Ⓑ	Ⓒ	C608	C625	C630, 631	C670, 671,682	C679, 680	R614	R615, 640,682	R623	R625	R627, 628	R672, 673	W656,662, 682,683	L604-607	CF601, 602	CF603	IC601	CN12
GENERAL MARKET	M1		0-71	NO	YES	YES	270P	0.018	NO	3300P	270	NO	3.3K	15K	8.2K	8.2K	YES	NO	MA5	YES	LA1838	NO	

VR-3090/3100(K,P) (1/6)
KRF-V9992D(M) (1/6)

KRF-V9992D/VR-3090/3100

Y05-3900-10

KENWOOD

VR-3090 (X25-6042-71)

DESTINATION		UNIT No.	E18	R143, 913-916
COUNTRY	ABB.			
U.S.A.	K1	2-71	NO	NO
CANADA	P2			

VR-3100 (X25-6040-11)

DESTINATION		UNIT No.	E18	R143, 913-916
COUNTRY	ABB.			
U.S.A.	K	0-11	YES	YES
CANADA	P1			

(X25-604X-XX) (B/7)

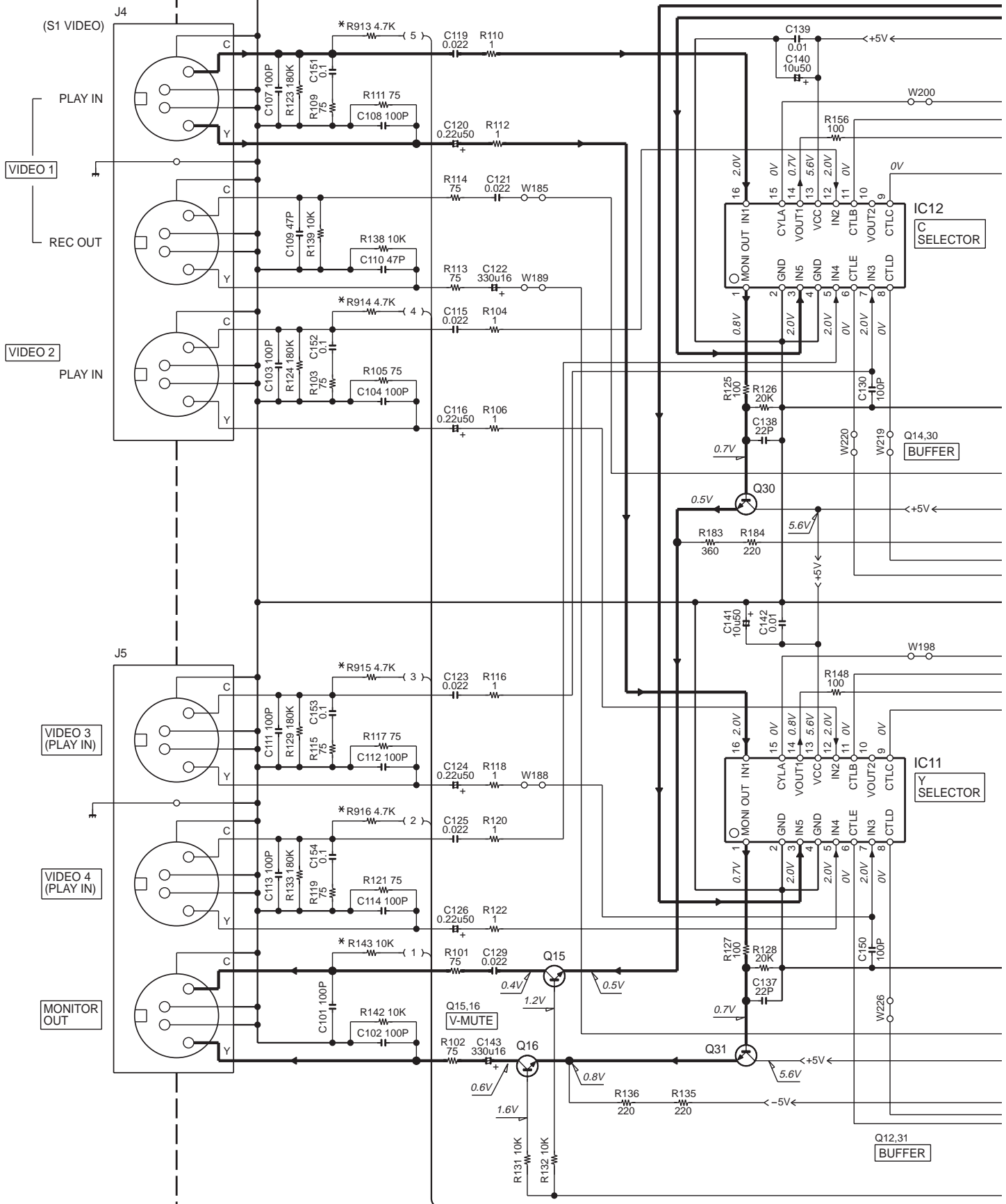

KRF-V9992D (X25-6040-22)

DESTINATION		UNIT No.	Ⓞ	Ⓧ	Ⓜ	E18	R143, 913-916
COUNTRY	ABB.						
GENERAL MARKET	M1	0-22	NO	YES	YES	YES	YES

(X25-604X-XX) (B/7)

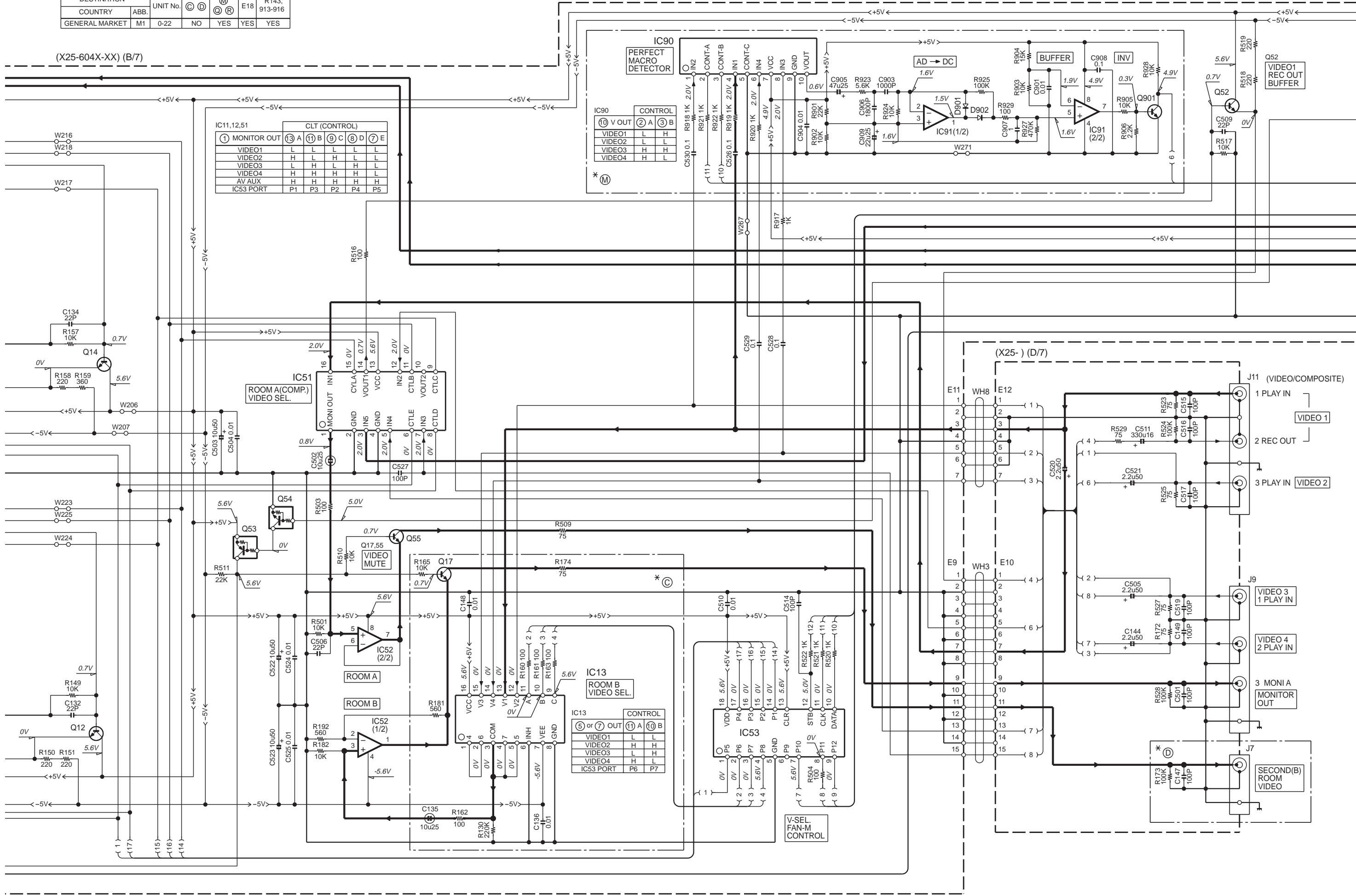

IC11,12,51

CLT (CONTROL)		ⓐ	ⓑ	ⓒ	ⓓ	ⓔ	ⓕ
① MONITOR OUT	⑬ A	⑪ B	⑩ C	⑧ D	⑦ E		
VIDEO1	L	L	L	L	L		
VIDEO2	H	L	H	L	L		
VIDEO3	L	H	L	H	L		
VIDEO4	H	H	H	H	L		
AV AUX	H	H	H	H	H		
IC53 PORT	P1	P3	P2	P4	P5		

IC90

CONTROL		ⓐ	ⓑ	ⓒ
⑩ V OUT	② A	③ B		
VIDEO1	L	H		
VIDEO2	L	L		
VIDEO3	H	H		
VIDEO4	H	L		

IC13

CONTROL		ⓐ	ⓑ	ⓒ
⑤ or ⑦ OUT	⑪ A	⑩ B		
VIDEO1	L	L		
VIDEO2	H	H		
VIDEO3	L	H		
VIDEO4	H	L		
IC53 PORT	P6	P7		

IC53

CONTROL		ⓐ	ⓑ	ⓒ
⑤ or ⑦ OUT	⑪ A	⑩ B		
VIDEO1	L	L		
VIDEO2	H	H		
VIDEO3	L	H		
VIDEO4	H	L		
IC53 PORT	P6	P7		

(X25-) (D/7)

J11 (VIDEO/COMPOSITE)
1 PLAY IN } VIDEO 1
2 REC OUT }
3 PLAY IN } VIDEO 2

J9
VIDEO 3 1 PLAY IN
VIDEO 4 2 PLAY IN

3 MONI A
MONITOR OUT

J7
SECOND(B) ROOM VIDEO

(X25-604X-XX) (B/7)

(X11-380X-XX) (B/7)

VR-3100(K,P) ONLY

IC4 : TC9163AF
IC5 : NJM4565D

X25-A/7
-CN25

X25-A/7
-CN26

X08-
CN19

X25-A/7
-CN28

X25-A/7
-CN22

2SC3944



DTA124EUA

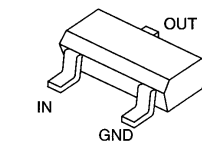

NJM4565D

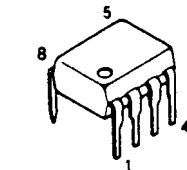

CAUTION: For continued safety, replace safety critical components only with manufacturer's recommended parts (refer to parts list). indicates safety critical components. For continued protection against risk of fire, replace only with same type and rating fuse(s). To reduce the risk of electric shock, leakage-current or resistance measurements shall be carried out (exposed parts are acceptably insulated from the supply circuit) before the appliance is returned to the customer.

The DC voltage is an actual reading measured with a high impedance type voltmeter with no signal input. The measurement value may vary depending on the measuring instruments used or on the product.

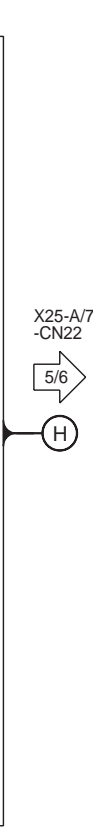
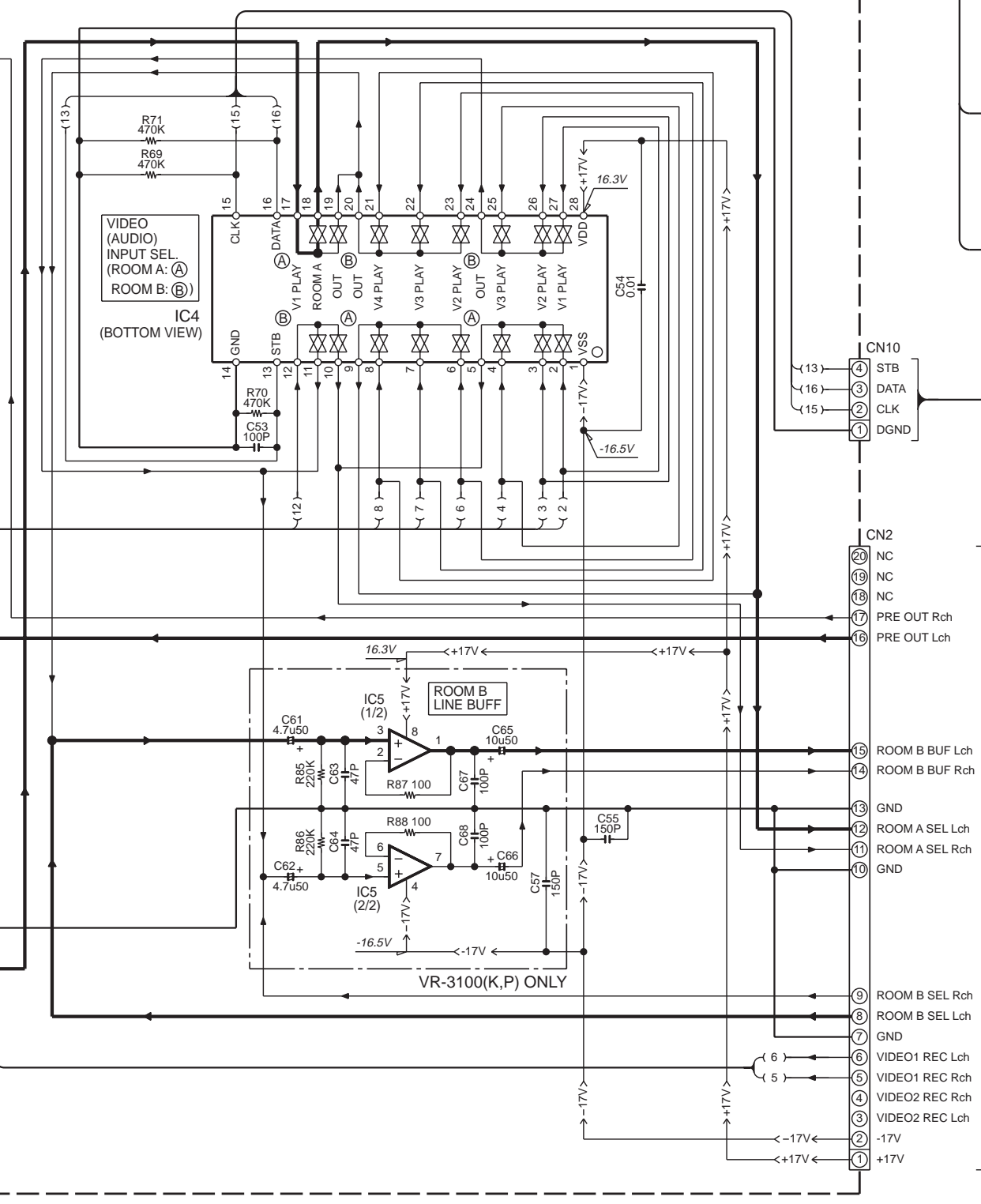
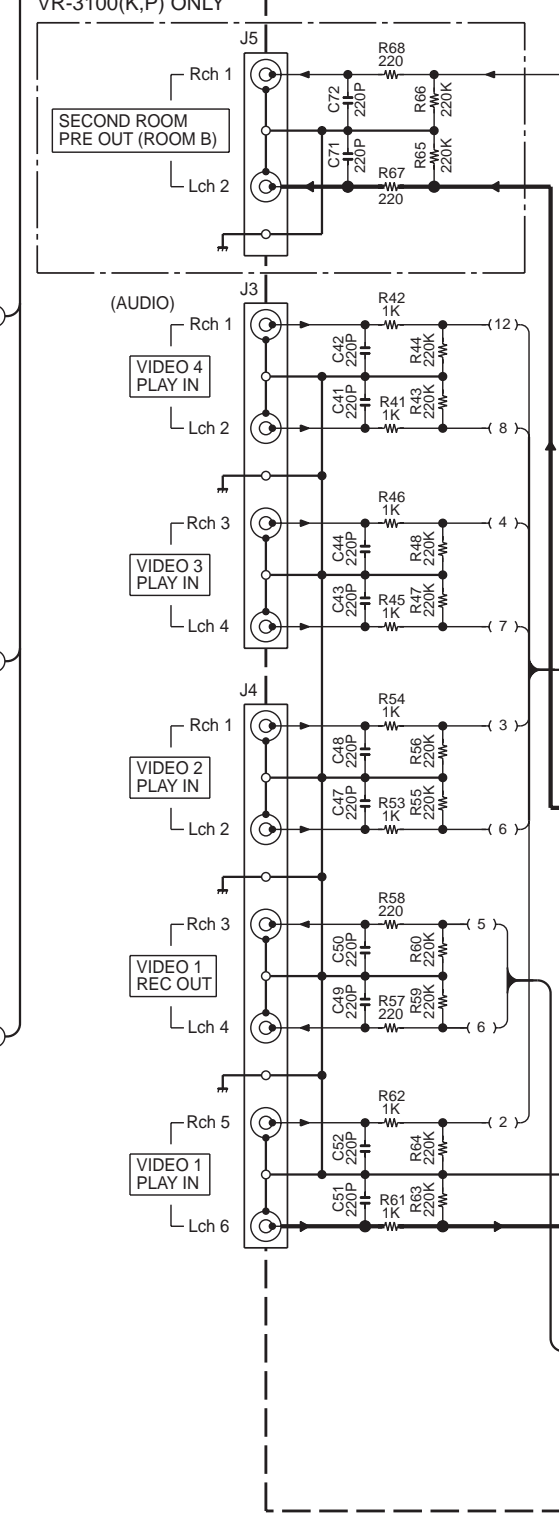
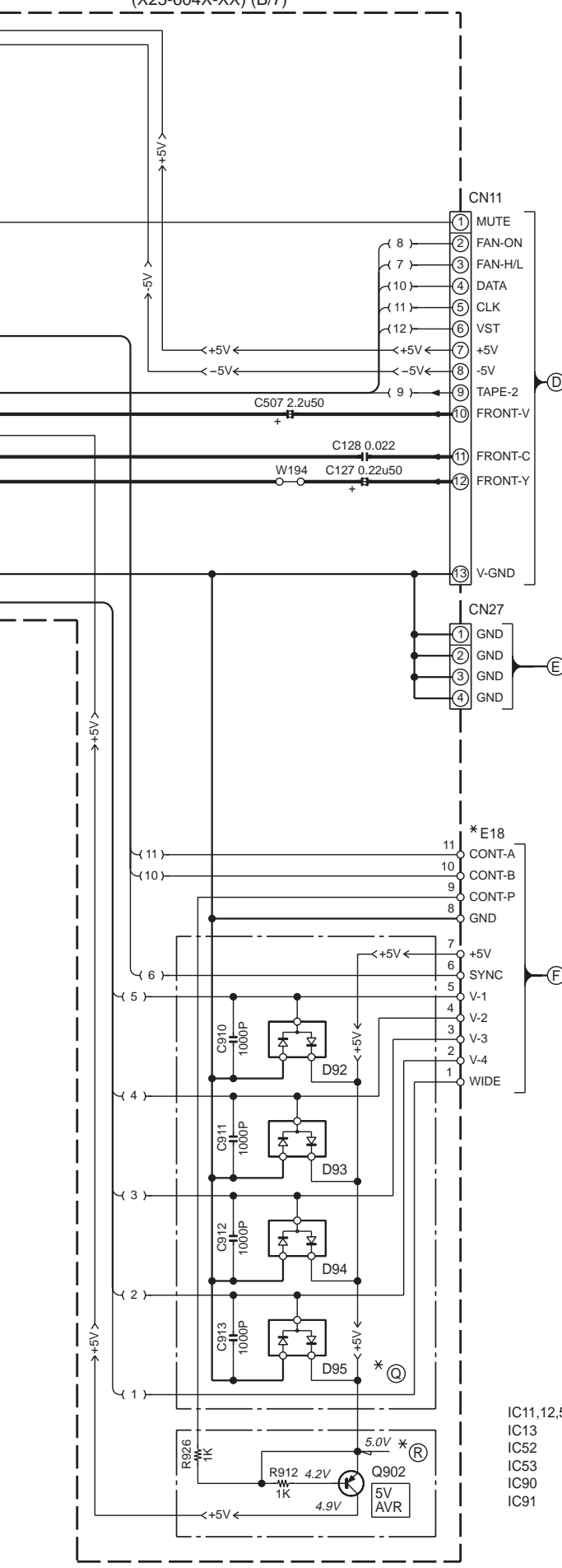

- | | | | |
|------------|----------------|---------------------|-----------------------|
| IC11,12,51 | : SN761200N | Q12,14,30,31,52,901 | : 2SC4081(R,S) |
| IC13 | : TC74HC4051AP | Q15-17,55 | : 2SC4213(B) |
| IC52 | : MC14577CF | Q53 | : UN5119 or DTA113ZUA |
| IC53 | : NJU3713D | Q54 | : UN5212 or DTC124EUA |
| IC90 | : BA7645N | Q902 | : 2SA1611(M5,M6) |
| IC91 | : NJM4580L | | |
| | | D92-95 | : DA204K |
| | | D901,902 | : MA111 |

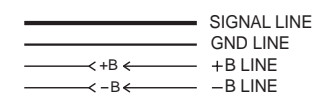

VR-3090/3100(K,P) (2/6)
KRF-V9992D(M) (2/6)

KRF-V9992D/VR-3090/3100

Y05-3900-10

KENWOOD

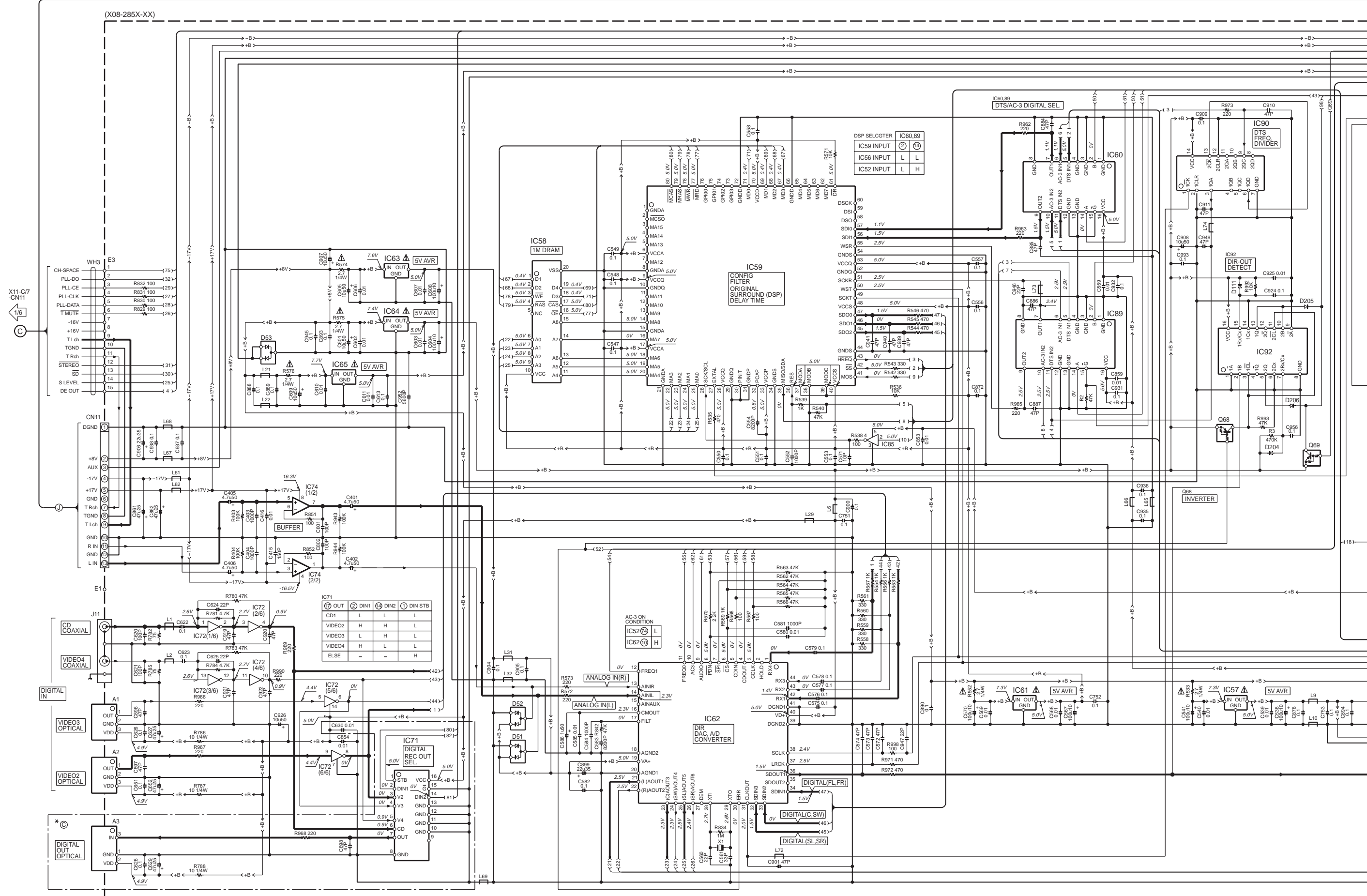

X25-B/7
-E18
2/6
F

The DC voltage is an actual reading measured with a high impedance type voltmeter with a cassette loaded at playback mode. The measurement value may vary depending on the measuring instruments used or on the product. Bias circuit DC voltage is measured while in the record mode.

DOLBY and the double-D symbol are trademarks of Dolby Laboratories Licensing Corporation. Noise reduction circuit made under license from Dolby Laboratories Licensing Corporation.

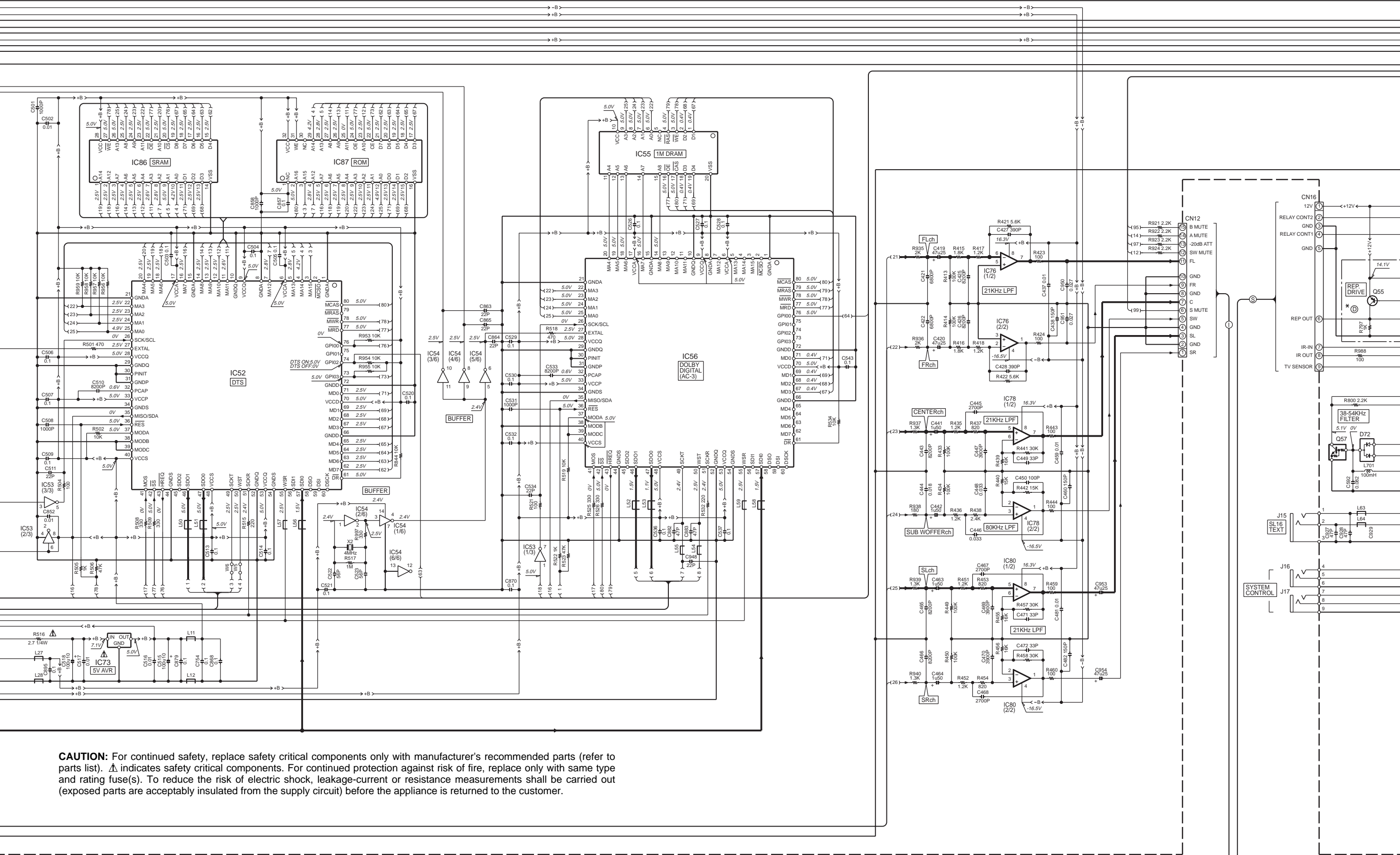

CAUTION: For continued safety, replace safety critical components only with manufacturer's recommended parts (refer to parts list). Δ indicates safety critical components. For continued protection against risk of fire, replace only with same type and rating fuse(s). To reduce the risk of electric shock, leakage-current or resistance measurements shall be carried out (exposed parts are acceptably insulated from the supply circuit) before the appliance is returned to the customer.

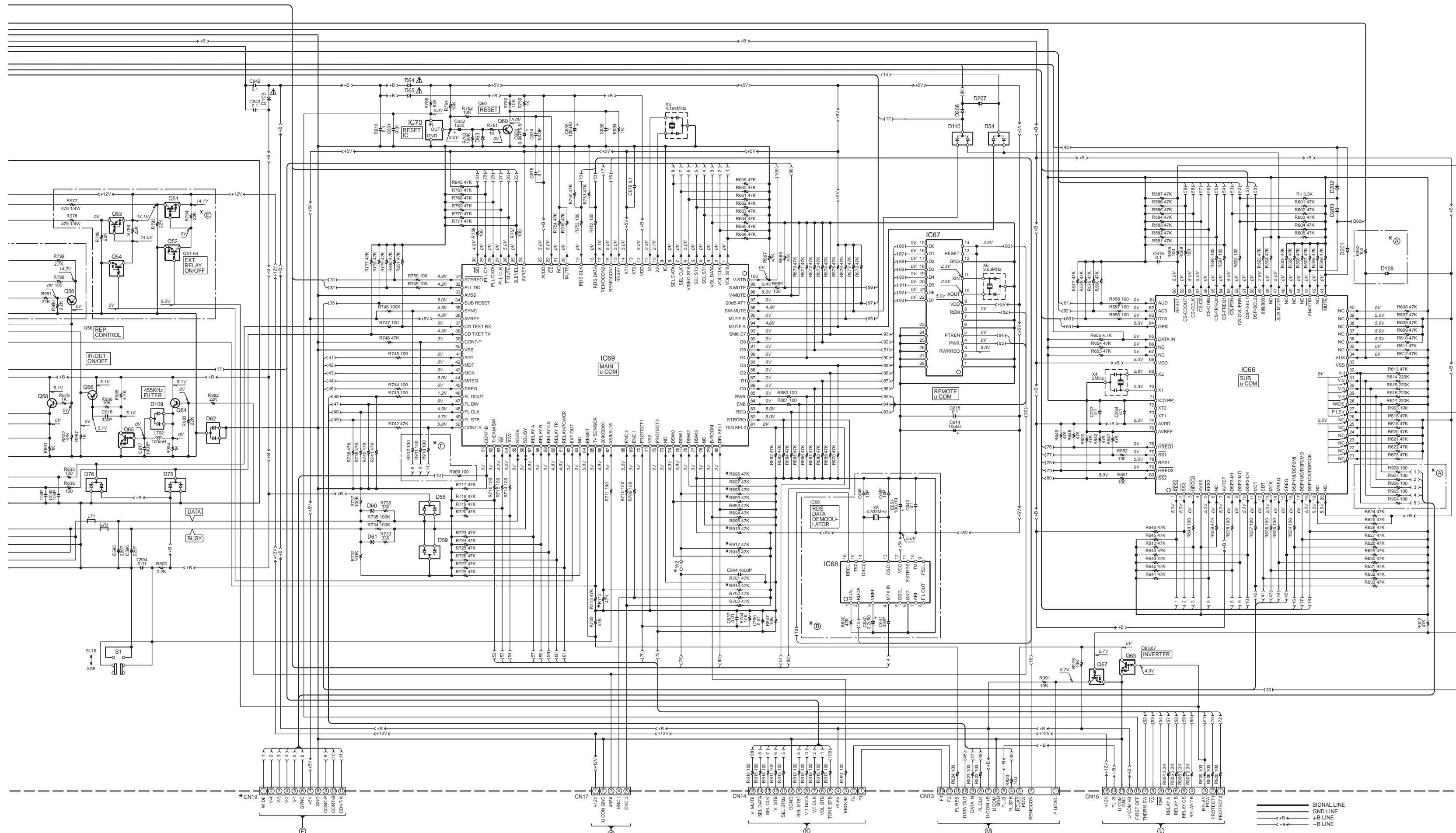

IC52 : DSP56009F-J88	IC74,76,78,80 : NJM4565M	Q51,53,68,69 : UN5112 or DTA124EUA	A1,2 : W02-1181-05
IC53 : TC7W04FU	IC85 : TC7S04F	Q55 : UN5112 or DTA124EUA	A3 : W02-1141-05
IC54,72 : TC74HC04AF	IC86 : N341256J-15 or W24257A-J-15 or N341256J-12 or W24257A-J-12	Q52,54,63,67 : UN5212 or DTC124EUA	D51-53,62,72,75,76,109 : DA204U or 1SS332 or MA143A
IC55,58 : LH64256CK-70	IC87 : 27C100MC-70	Q56,58,60,64 : 2SC4081(R,S) or 2SC4116(Y,G,R)	D54,59,110 : DAP202U or 1SS300 or MA142WA
IC56 : DSP56009F-J88	IC90 : TC74HC133AF	Q57,65 : UN5219 or DTC1132UA	D58 : DAN202U or 1SS301
IC57,63,73 : LM22040T-5.0	IC92 : TC74HC123AF	Q66 : 2SA1576A(R,S) or 2SA1586(Y,G,R)	D60,61,63,106,111,201-208 : MA111
IC59 : DSP56007F-J88			D64,65,103 : U1BC44
IC60,71,89 : TC74HC153AF			
IC61,64,65 : TA78655			
IC62 : CS3429KQC			
IC66 : UPD78058GC-B36			
IC67 : UPD17215G1-737			
IC68 : TDA7478D			
IC69 : UPD78078GF-080			
IC70 : S-806D-Z			

KRF-V9992D (X08-2850-22)

DESTINATION	UNIT No.	R905,914	R908,909	R914,916	R917,919	CN19	W2
COUNTRY	ABB	916,917	712,919				999
GENERAL MARKET	M1	YES	NO	YES	NO	YES	YES

VR-3090 (X08-2852-91)

DESTINATION	UNIT No.	R905,908	R909,914	R914,916	R917,919	CN19	W2
COUNTRY	ABB	699,712					999
U.S.A.	K	NO	YES	YES	NO	YES	NO
CANADA	P1	2-91	NO	NO	NO	YES	NO

VR-3100 (X08-2850-11)

DESTINATION	UNIT No.	R905,908	R909,914	R914,916	R917,919	CN19	W2
COUNTRY	ABB	699,712					999
U.S.A.	K	NO	YES	YES	NO	YES	NO
CANADA	P1	0-11	NO	NO	NO	YES	NO

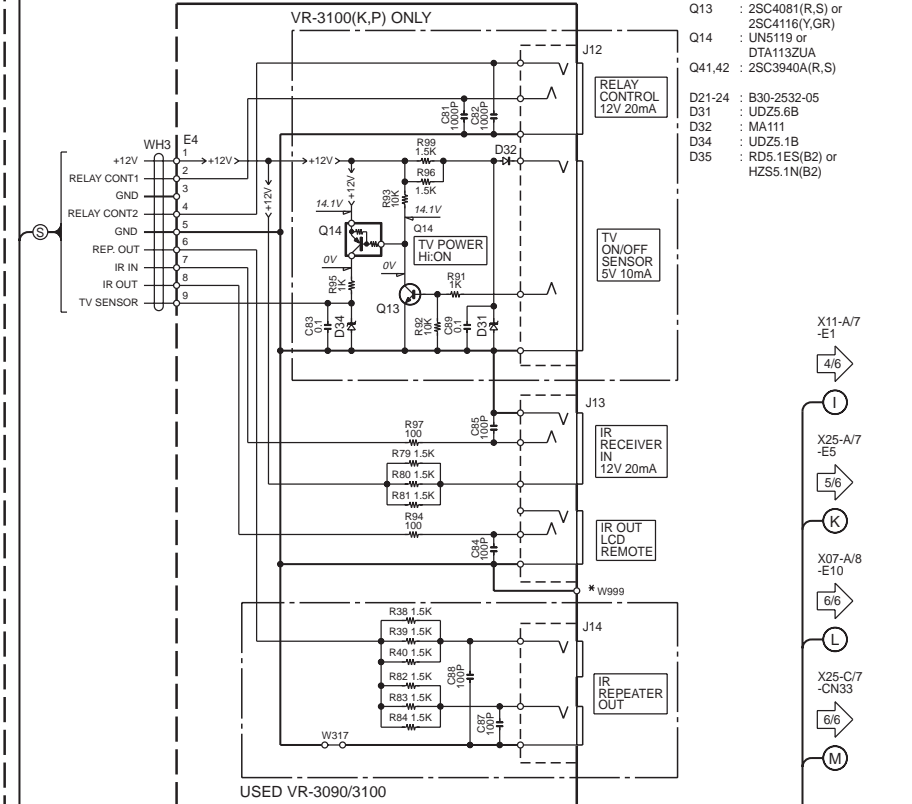
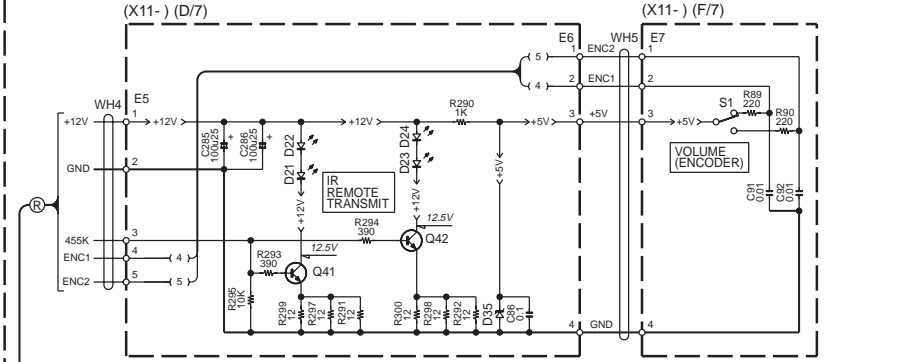

KRF-V9992D(M) (3/6)
VR-3090/3100(K,P) (3/6)

KRF-V9992D/VR-3090/3100

Y05-3900-10

KENWOOD



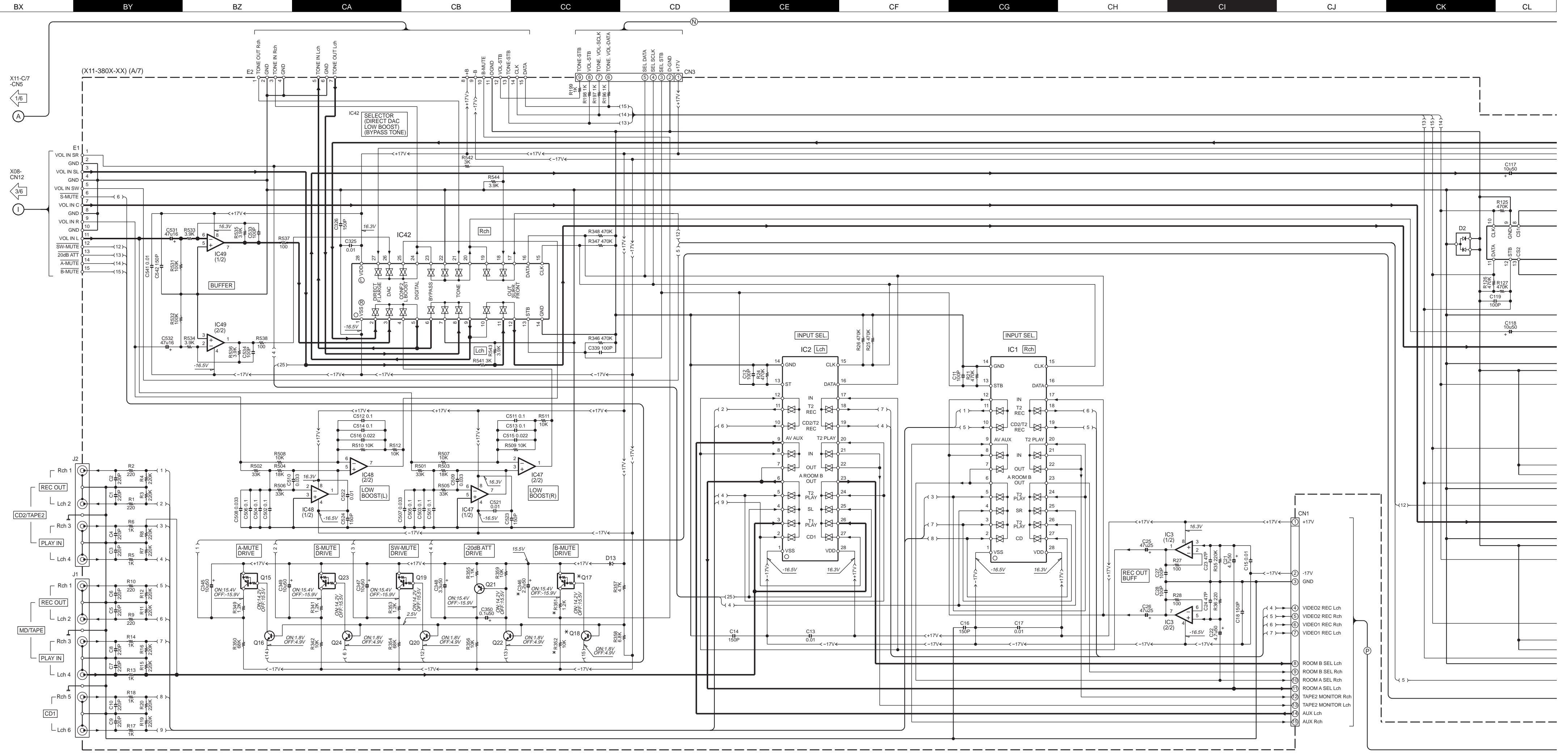

DESTINATION		UNIT No.	R351, 352	C346	Q17, 18
COUNTRY	ABB.				
U.S.A.	K1	3-81	NO	NO	NO
CANADA	P2				

DESTINATION		UNIT No.	R351, 352	C346	Q17, 18
COUNTRY	ABB.				
U.S.A.	K	2-91	YES	YES	YES
CANADA	P1				

DESTINATION		UNIT No.	R351, 352	C346	Q17, 18
COUNTRY	ABB.				
GENERAL MARKET	M1	0-71	NO	NO	NO

- IC1,2 : TC9164AF
- IC3,22,24,26,30,31,51-53 : NJM4565D
- IC21 : TC9412AP
- IC23,25 : TC9413P
- IC42 : TC9163AF
- IC47-49 : NJM4565L
- Q1-12,33-36 : 2SC4231(B)
- Q15,17,19,23 : UN5119 or DTA113ZUA
- Q16,18,20,22,24 : 2SC4081(R,S) or 2SC4116(Y,G,R)
- Q21 : 2SA1576A(R,S) or 2SA1586(Y,G,R)
- D2 : DA204U or 1SS302
- D13 : MA111
- D14 : RD11ES(B) or HZS11N(B)

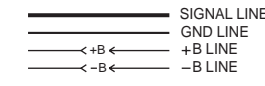

(X11-380X-XX) (A/7)

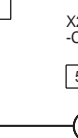
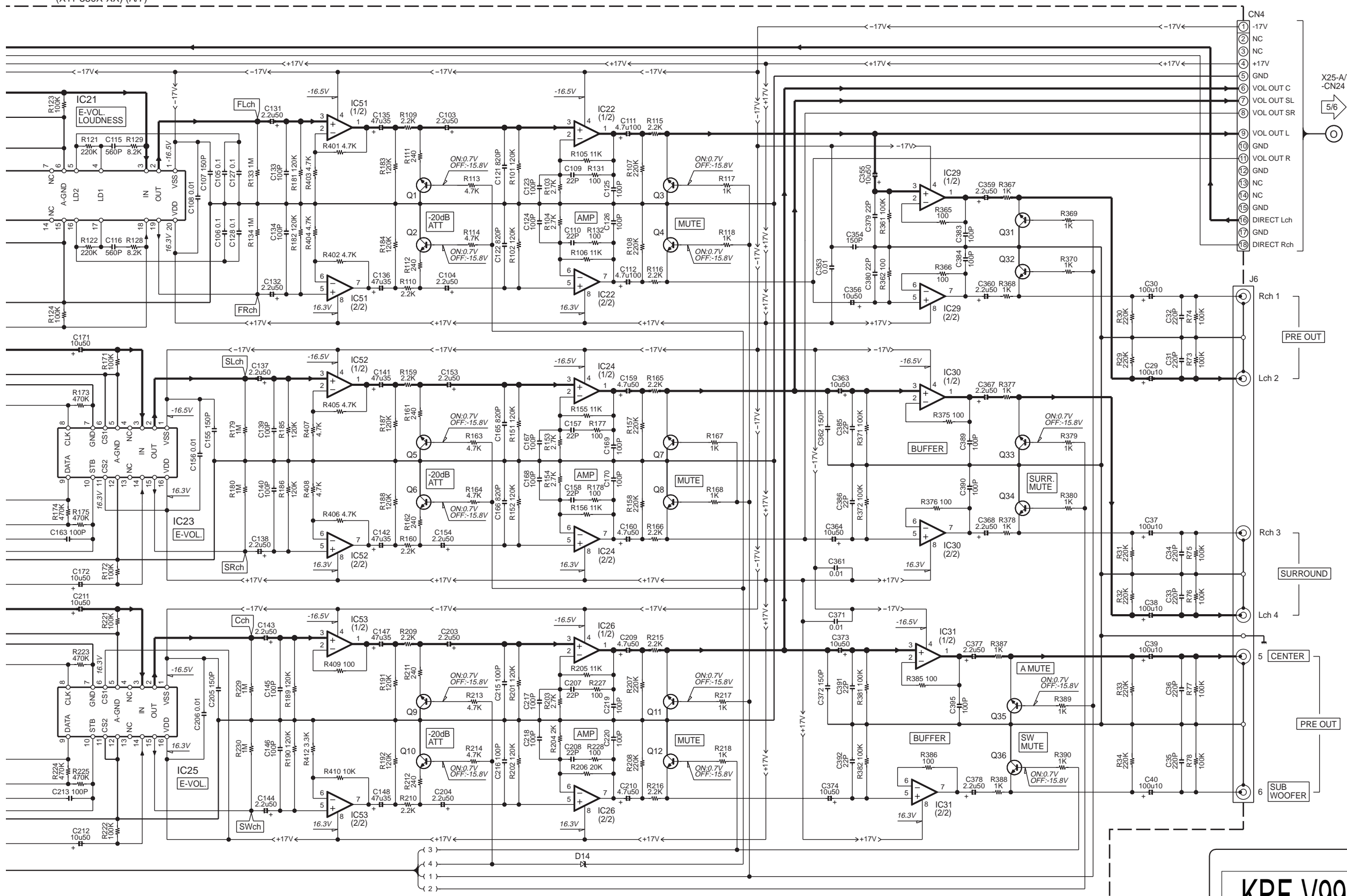

CAUTION: For continued safety, replace safety critical components only with manufacturer's recommended parts (refer to parts list). Δ indicates safety critical components. For continued protection against risk of fire, replace only with same type and rating fuse(s). To reduce the risk of electric shock, leakage-current or resistance measurements shall be carried out (exposed parts are acceptably insulated from the supply circuit) before the appliance is returned to the customer.

The DC voltage is an actual reading measured with a high impedance type voltmeter with no signal input. The measurement value may vary depending on the measuring instruments used or on the product.

VR-3090/3100(K,P) (4/6)
KRF-9992D(M) (4/6) Y05-3900-10

KRF-V9992D/VR-3090/3100

KENWOOD

X11-C/7 -CN7
 X11-A/7 -CN3
 X11-A/7 -CN4
 X11-A/7 -CN1
 X11-B/7 -CN2
 X11-B/7 -CN10
 X25-B/7 -CN11
 X25-B/7 -CN27
 X08-CN11
 X08-CN14

CAUTION: For continued safety, replace safety critical components only with manufacturer's recommended parts (refer to parts list). Δ indicates safety critical components. For continued protection against risk of fire, replace only with same type and rating fuse(s). To reduce the risk of electric shock, leakage-current or resistance measurements shall be carried out (exposed parts are acceptably insulated from the supply circuit) before the appliance is returned to the customer.

The DC voltage is an actual reading measured with a high impedance type voltmeter with no signal input. The measurement value may vary depending on the measuring instruments used or on the product.

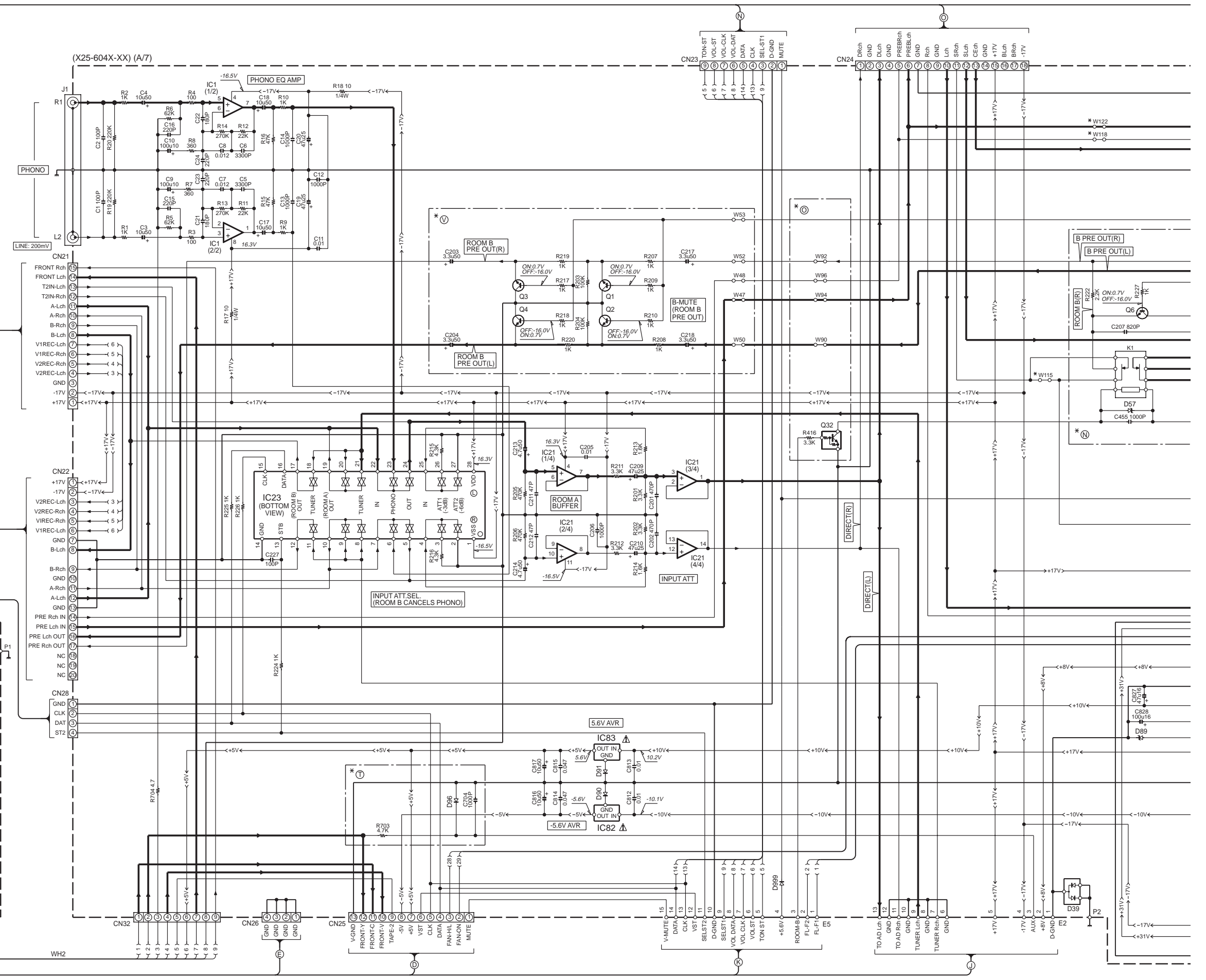

1
2
3
4
5
6
7

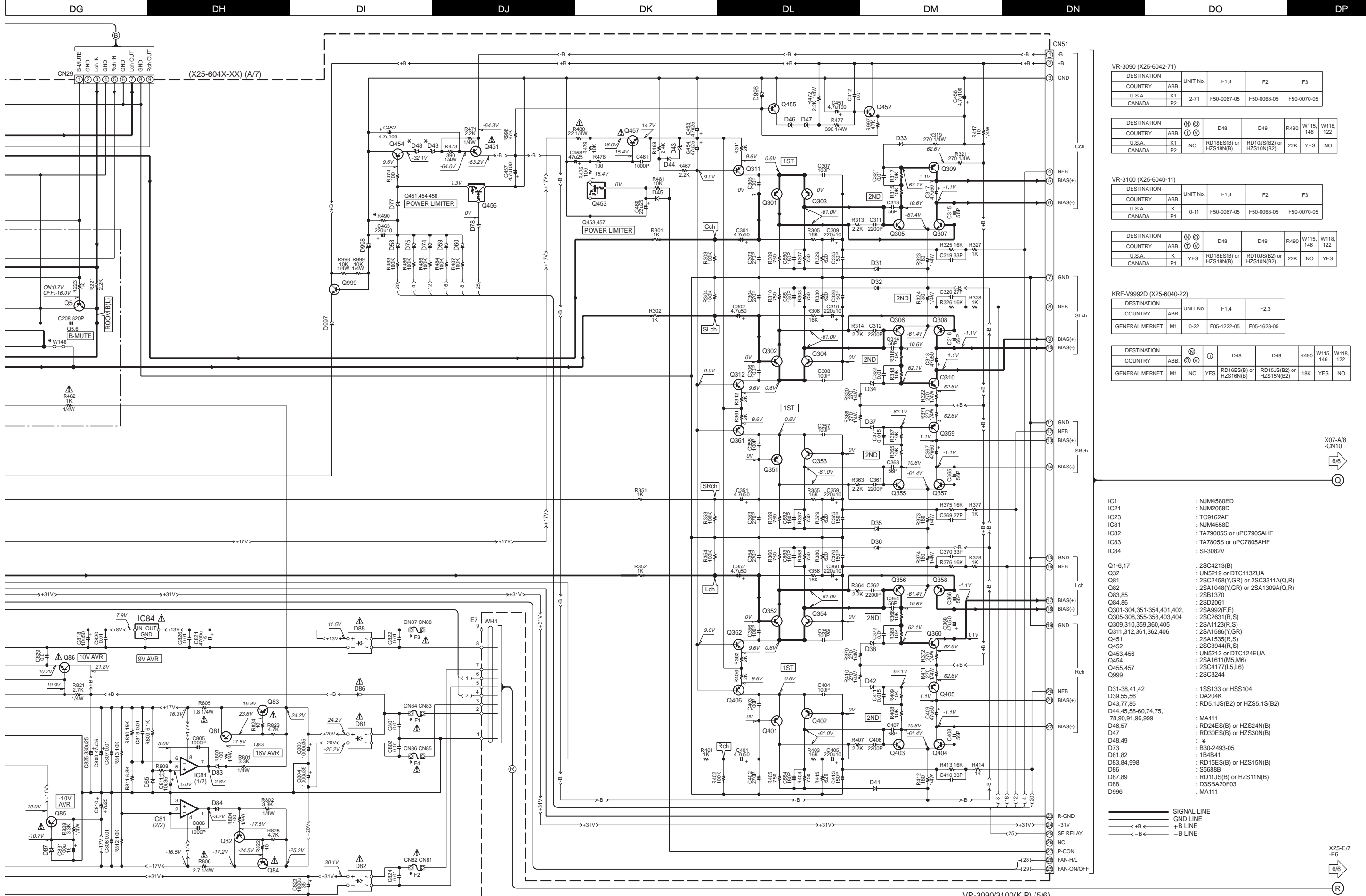

VR-3090 (X25-6042-71)

DESTINATION	UNIT No.	F1,4	F2	F3
COUNTRY	ABB.			
U.S.A.	K1	F50-0067-05	F50-0068-05	F50-0070-05
CANADA	P2			

DESTINATION	UNIT No.	D48	D49	R490	W115, 146	W118, 122
COUNTRY	ABB.					
U.S.A.	K1	NO	RD18ES(B) or HZS18N(B)	RD10JS(B2) or HZS10N(B2)	22K	YES
CANADA	P2					

VR-3100 (X25-6040-11)

DESTINATION	UNIT No.	F1,4	F2	F3
COUNTRY	ABB.			
U.S.A.	K	0-11	F50-0067-05	F50-0068-05
CANADA	P1			

DESTINATION	UNIT No.	D48	D49	R490	W115, 146	W118, 122
COUNTRY	ABB.					
U.S.A.	K	YES	RD18ES(B) or HZS18N(B)	RD10JS(B2) or HZS10N(B2)	22K	NO
CANADA	P1					

KRF-V9992D (X25-6040-22)

DESTINATION	UNIT No.	F1,4	F2,3
COUNTRY	ABB.		
GENERAL MERKET	M1	0-22	F05-1222-05

DESTINATION	UNIT No.	D48	D49	R490	W115, 146	W118, 122
COUNTRY	ABB.					
GENERAL MERKET	M1	NO	YES	RD16ES(B) or HZS16N(B)	RD15JS(B2) or HZS15N(B2)	18K
						YES

- IC1 : NJM4580ED
- IC21 : NJM2058D
- IC23 : TC9162AF
- IC81 : NJM4558D
- IC82 : TA79005S or uPC7905AHF
- IC83 : TA7805S or uPC7805AHF
- IC84 : SI-3082V

- Q1-6,17 : 2SC4213(B)
- Q32 : UN5219 or DTC1132UA
- Q81 : 2SC2458(Y,GR) or 2SC3311A(Q,R)
- Q82 : 2SA1048(Y,GR) or 2SA1309A(Q,R)
- Q83,85 : 2SB1370
- Q84,86 : 2SD2061
- Q301-304,351-354,401,402, Q305-308,355-358,403,404 : 2SA992(F,E)
- Q309,310,359,360,405 : 2SC2631(R,S)
- Q311,312,361,362,406 : 2SA1123(R,S)
- Q451 : 2SA1586(Y,GR)
- Q452 : 2SA1535(R,S)
- Q453,456 : 2SC3944(R,S)
- Q454 : UN5212 or DTC124EUA
- Q455,457 : 2SA1611(M5,M6)
- Q999 : 2SC4177(L5,L6)
- Q999 : 2SC3244

- D31-38,41,42 : 1SS133 or HSS104
- D39,55,56 : DA204K
- D43,77,85 : RD5.1JS(B2) or HZS5.1S(B2)
- D44,45,58-60,74,75, 78,90,91,96,999 : MA111
- D46,57 : RD24ES(B) or HZS24N(B)
- D47 : RD30ES(B) or HZS30N(B)
- D48,49 : *
- D73 : B30-2493-05
- D81,82 : 1B4B41
- D83,84,998 : RD15ES(B) or HZS15N(B)
- D86 : S5688B
- D87,89 : RD11JS(B) or HZS11N(B)
- D88 : D3SBA20F03
- D996 : MA111

- SIGNAL LINE
- GND LINE
- +B LINE
- -B LINE

VR-3090/3100(K,P) (5/6)
KRF-V9992D(M) (5/6)

KRF-V9992D/VR-3090/3100

Y05-3900-10

KENWOOD

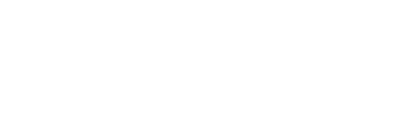
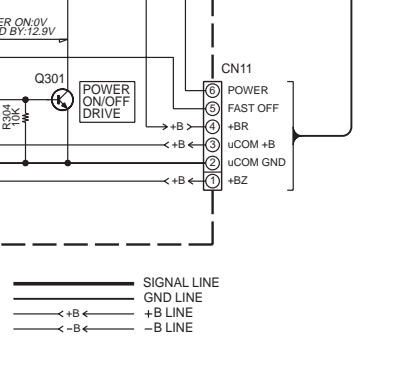
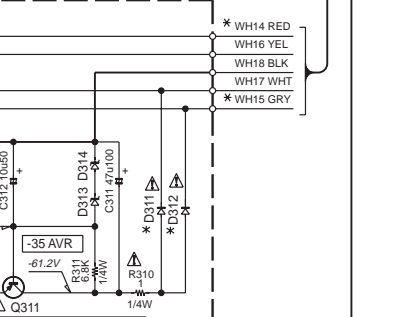
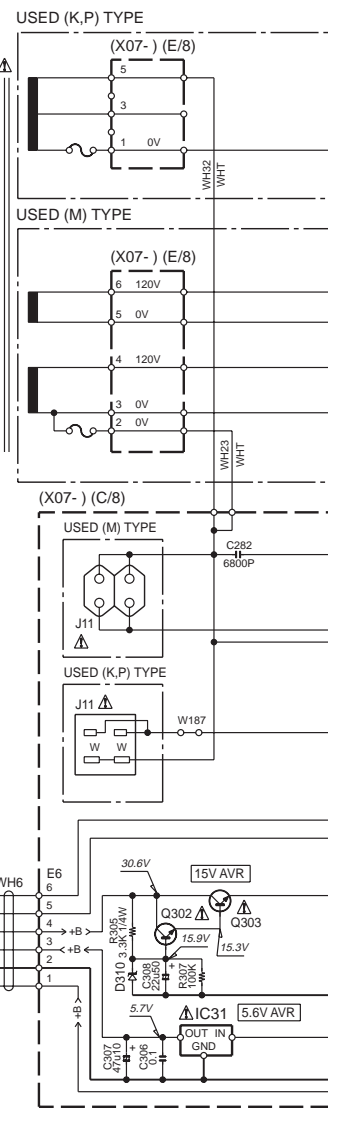
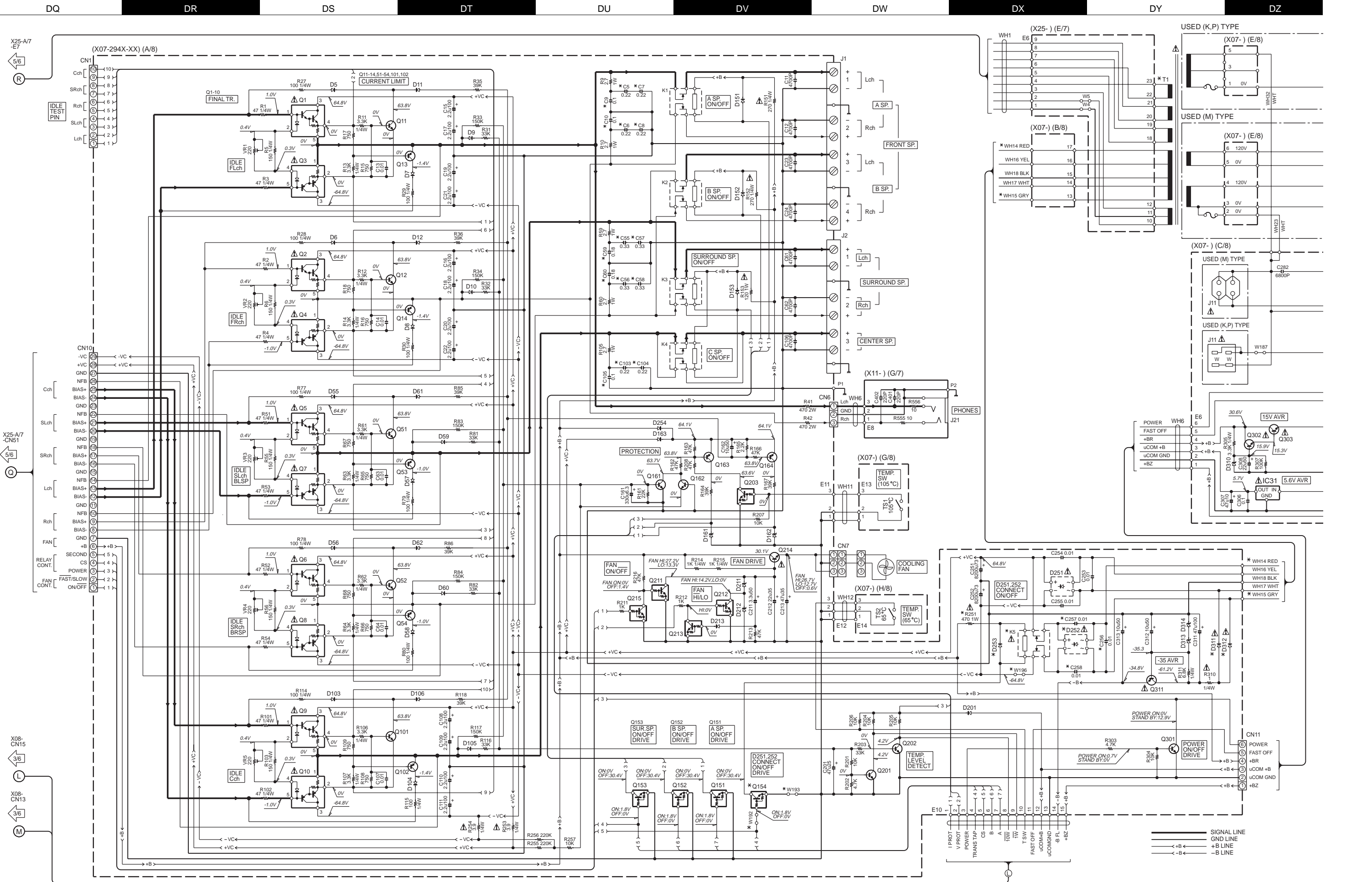

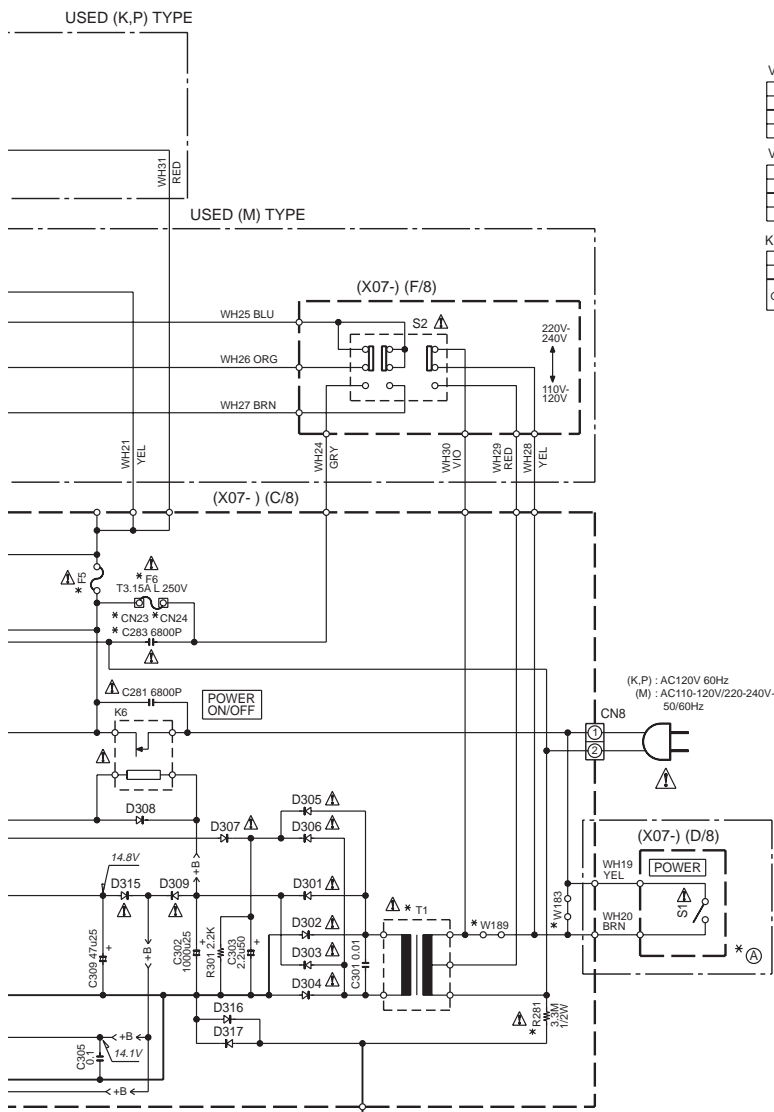

DESTINATION		UNIT No.	C5-8,55-58,103,104,256-258,283	C9,10,59,60,105	R251	R281	Q154	D252,253,312	D311	K5	F5	F6	CN23,24	W183,189	W192,193,196	WH14,15	J11	T1	Ⓢ	
COUNTRY	ABB																			
U.S.A.	K1	0-10	NO	YES	NO	YES	NO	NO	YES	NO	NO	NO	NO	YES	NO	NO	E03-0148-05	L07-2320-05	NO	
CANADA	P2																			

DESTINATION		UNIT No.	C5-8,55-58,103,104,256-258,283	C9,10,59,60,105	R251	R281	Q154	D252,253,312	D311	K5	F5	F6	CN23,24	W183,189	W192,193,196	WH14,15	J11	T1	Ⓢ	
COUNTRY	ABB																			
U.S.A.	K	0-10	NO	YES	NO	YES	NO	NO	YES	NO	NO	NO	NO	YES	NO	NO	E03-0148-05	L07-2320-05	NO	
CANADA	P1																			

DESTINATION		UNIT No.	C5-8,55-58,103,104,256-258,283	C9,10,59,60,105	R251	R281	Q154	D252,253,312	D311	K5	F5	F6	CN23,24	W183,189	W192,193,196	WH14,15	J11	T1	Ⓢ	
COUNTRY	ABB																			
GENERAL MARKET	M1	0-21	YES	NO	YES	NO	YES	YES	NO	YES	T3.15A L 250V	YES	YES	NO	YES	YES	E03-0149-05	L07-2321-05	YES	

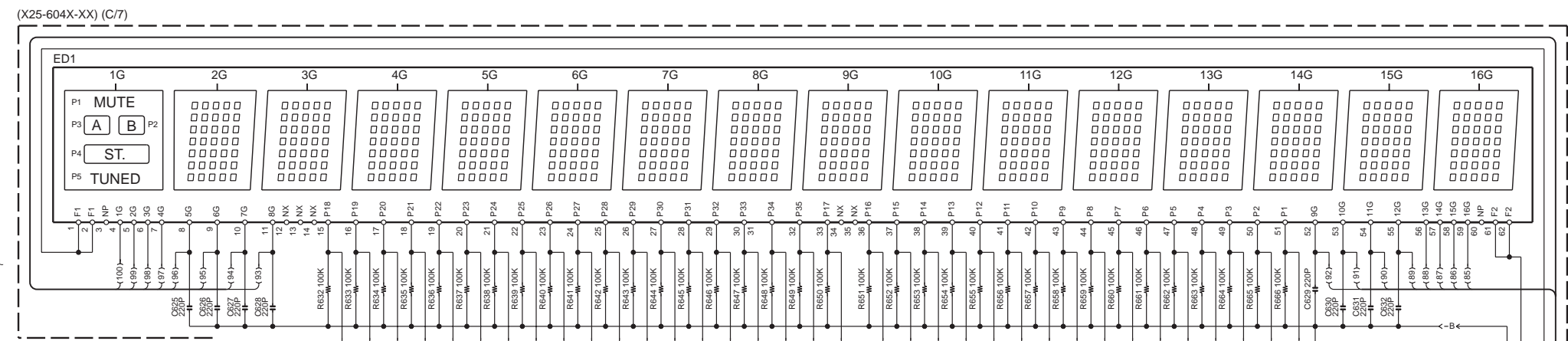

- IC31 : TA78057S
- Q1,2,5,6,9 : TRAIT5N 5
- Q3,4,7,8,10 : TRAIT5P 5
- Q11,12,51,52,101 : 2SC2631(R,S)
- Q13,14,53,54,102,163,164 : 2SA992(F,E)
- Q151-154,211,212 : UN4219 or DTC1132SA
- Q161,162 : 2SC1845(F,E)
- Q201,202,302 : 2SC2458(Y,GR) or 2SC3311A(Q,R)
- Q203,213,215 : UN4212 or DTC124ESA
- Q214,303 : 2SD2012 or 2SD2061
- Q301 : 2SC2003(L,K)
- Q311 : 2SB1375 or 2SB1370
- D5-12,55-62,103-106,151-153,163,201,213,253,254,305-308,316,317 : 1SS133 or HSS104A
- D161,162 : RD4.7ES(B) or HZ34.7N(B)
- D211 : RD13ES(B2) or HZ31N(B2)
- D212 : RD15ES(B) or HZ31N(B)
- D251 : RBV-1506LFA
- D252 : RBA-1002 or D10XB20F03
- D301-304,309,311,312,315 : S5688B or 1SR139-400
- D310 : RD16ES(B2) or HZ316N(B2)
- D313,314 : RD18ES(B2) or HZ318N(B)

CAUTION: For continued safety, replace safety critical components only with manufacturer's recommended parts (refer to parts list). ⚠ indicates safety critical components. For continued protection against risk of fire, replace only with same type and rating fuse(s). To reduce the risk of electric shock, leakage-current or resistance measurements shall be carried out (exposed parts are acceptably insulated from the supply circuit) before the appliance is returned to the customer.

The DC voltage is an actual reading measured with a high impedance type voltmeter with no signal input. The measurement value may vary depending on the measuring instruments used or on the product.

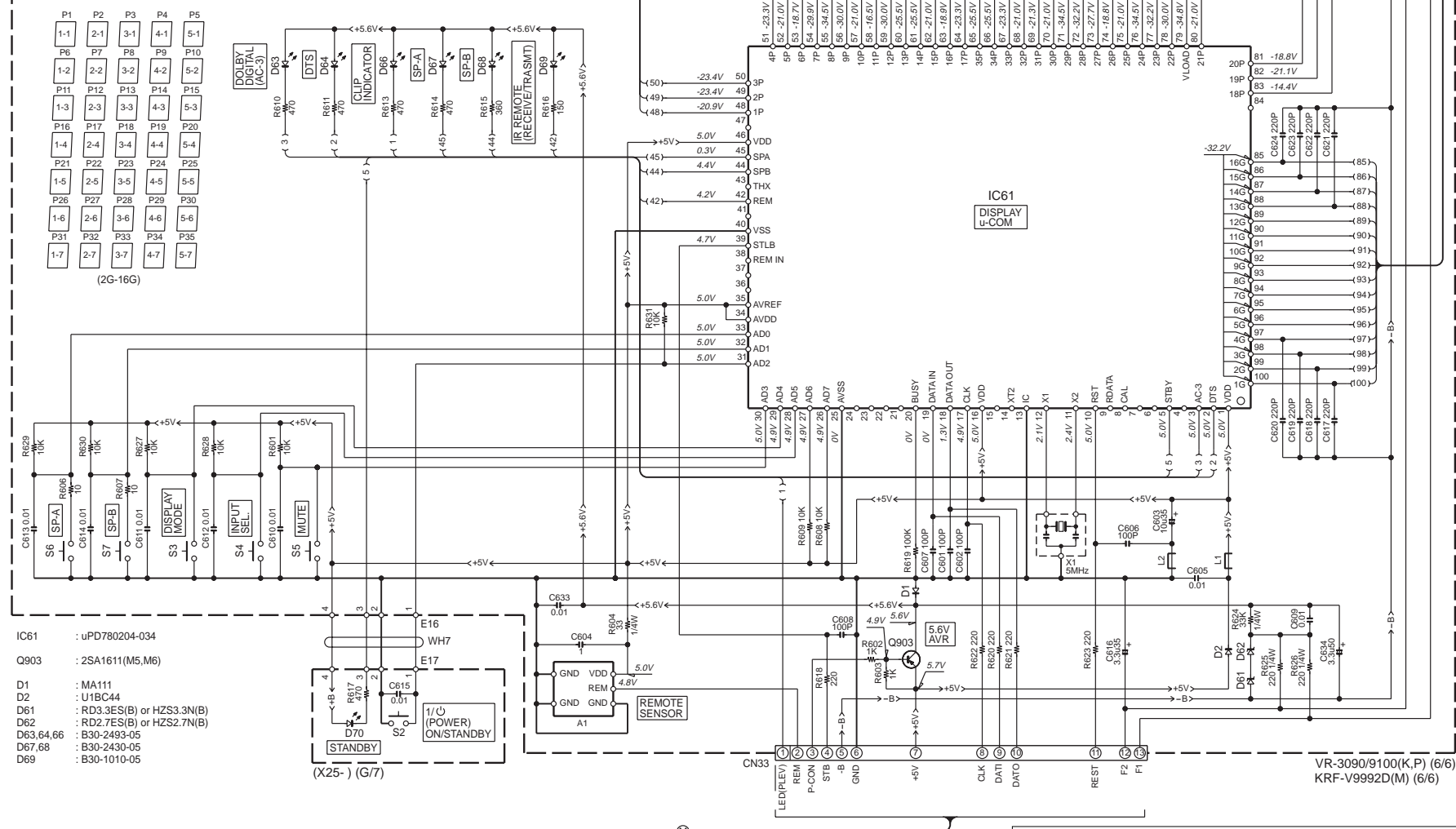

A

B

C

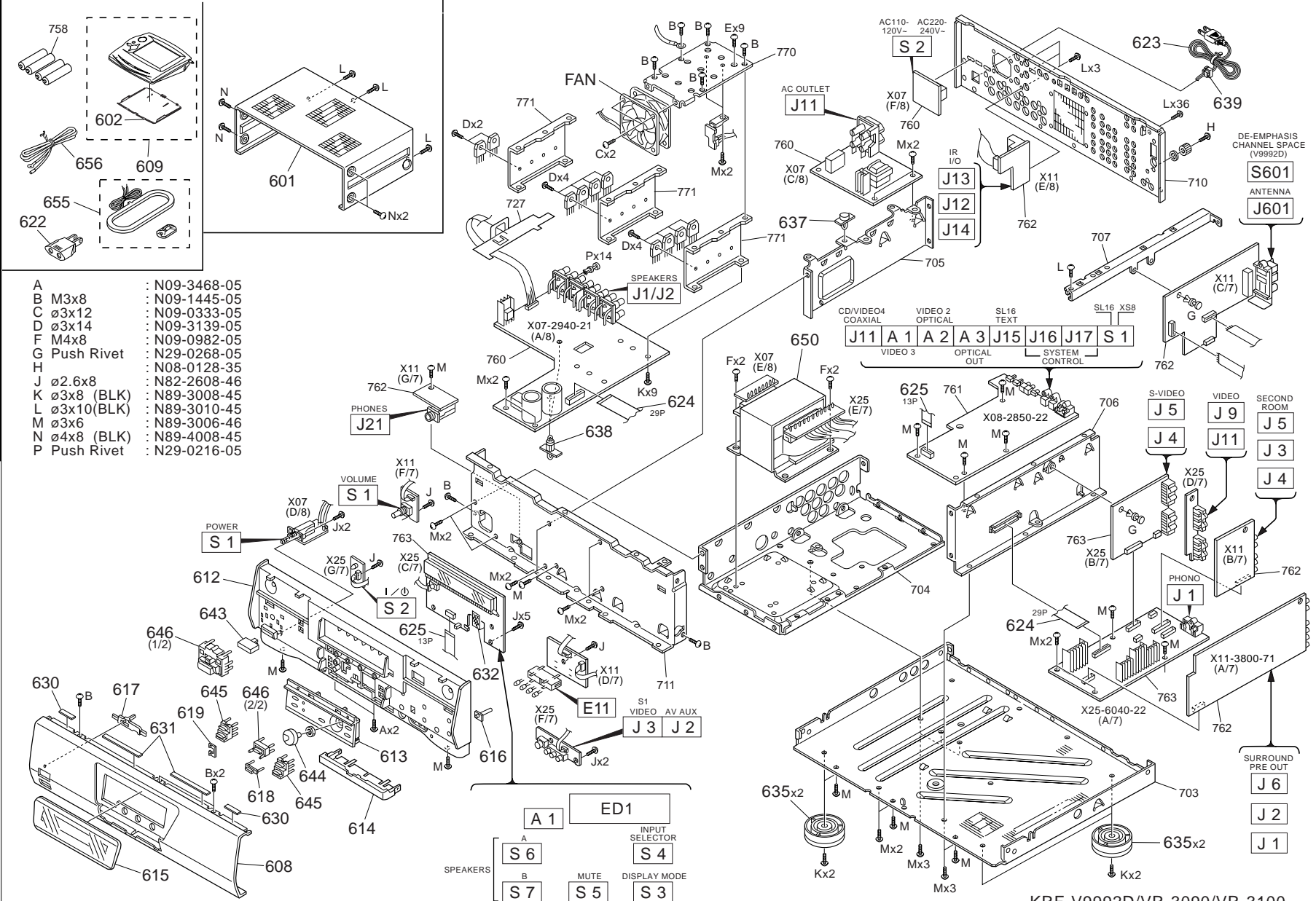

- A : N09-3468-05
- B M3x8 : N09-1445-05
- C ø3x12 : N09-0333-05
- D ø3x14 : N09-3139-05
- F M4x8 : N09-0982-05
- G Push Rivet : N29-0268-05
- H : N08-0128-35
- J ø2.6x8 : N82-2608-46
- K ø3x8 (BLK) : N89-3008-45
- L ø3x10(BLK) : N89-3010-45
- M ø3x6 : N89-3006-46
- N ø4x8 (BLK) : N89-4008-45
- P Push Rivet : N29-0216-05

KRF-V9992D/VR-3090/VR-3100

EXPLODED VIEW

KRF-V9992D/VR-3090/3100

* New Parts

Parts without **Parts No.** are not supplied.
Les articles non mentionnés dans le **Parts No.** ne sont pas fournis.
Teile ohne **Parts No.** werden nicht geliefert.

①

* New Parts

Parts without **Parts No.** are not supplied.
Les articles non mentionnés dans le **Parts No.** ne sont pas fournis.
Teile ohne **Parts No.** werden nicht geliefert.

②

Ref. No	Add-ress	New Parts	Parts No.	Description	Desti-nation	Re-marks
KRF-V9992D/VR-3090/VR-3010						
601	1A		A01-3680-01	METALLIC CABINET		
602	1A	*	A09-1130-08	BATTERY COVER		
608	2A	*	A60-1650-02	PANEL	KP1	
608	2A	*	A60-1651-02	PANEL	M1	
608	2A	*	A60-1652-02	PANEL	K1P2	
609	1A	*	A70-1285-05	REMOTE CONTROLLER ASSY		
612	2A		B01-0533-21	PANEL ESCUTCHEON		
613	2A		B07-2396-22	ESCUTCHEON		
614	2A		B10-2418-03	FRONT GLASS		
615	2A		B10-2451-03	FRONT GLASS		
616	2B		B12-0303-24	INDICATOR		
617	2A		B12-0326-04	INDICATOR		
618	2A		B12-0331-04	INDICATOR		
619	2A		B12-0333-04	INDICATOR		
-			B46-0330-03	WARRANTY CARD	KK1	
-			B46-0346-00	QUESTIONAIRE CARD	KK1	
-			B46-0347-03	WARRANTY CARD	P1P2	
-			B58-0964-13	CAUTION CARD (UL)	KK1	
-			B58-0966-13	CAUTION CARD (PL)	M1	
-			B58-0967-03	CAUTION CARD (PL)	P1P2	
-			B59-1438-00	SUB-INSTRUCTION MANUAL		
-		*	B60-4180-00	INSTRUCTION MANUAL(EN)		
-		*	B60-4181-00	INSTRUCTION MANUAL(EN)		
-		*	B60-4182-00	INSTRUCTION MANUAL(FR)	P1P2	
-		*	B60-4183-00	INSTRUCTION MANUAL(FR)	P1P2	
-		*	B60-4188-00	INSTRUCTION MANUAL(TC)	M1	
-		*	B60-4189-00	INSTRUCTION MANUAL(TC)	M1	
△ 622	1A		E03-0115-05	AC PLUG ADAPTER	M1	
△ 623	1C		E30-2788-05	AC POWER CORD	M1	
△ 623	1C		E30-2883-05	AC POWER CORD	KP1K1	
△ 623	1C		E30-2883-05	AC POWER CORD	P2	
△ 624	1B,2C		E35-2056-05	FLAT CABLE 29P		
625	2A,1C		E35-2057-05	FLAT CABLE 13P		
630	2A		G11-0155-14	SOFT TAPE (40X9X2)		
631	2A		G11-0185-04	SOFT TAPE (120X5X2)		
632	2B		G11-2405-04	SOFT TAPE		
-			H10-7416-22	POLYSTYRENE FOAMED FIXTURE		
-			H10-7417-32	POLYSTYRENE FOAMED FIXTURE		
-		*	H11-0094-04	POLYSTYRENE FOAMED BOARD		
-		*	H13-0311-14	CARTON BOARD		
-		*	H21-0374-04	PROTECTION SHEET		
-			H25-0232-04	PROTECTION BAG (235X350X0.03)		
-		*	H50-3287-04	ITEM CARTON CASE	KP1	
-		*	H50-3288-04	ITEM CARTON CASE	M1	
-		*	H50-3289-04	ITEM CARTON CASE	K1P2	
635	2B,2C		J02-1404-13	FOOT (D=46,H=18.5,T)		
637	1B		J19-3300-05	UNIT HOLDER		
638	1B		J19-5910-05	UNIT HOLDER		
△ 639	1C		J42-0083-05	POWER CORD BUSHING		
-			J30-0480-04	SPACER		

L : Scandinavia K : USA P : Canada R : Mexico C : China I : Malaysia

Y : PX(Far East, Hawaii) T : England E : Europe G : Germany V : China (Shanghai)

Y : AAFES(Europe) X : Australia Q : Russia H : Korea M : Other Areas △ indicates safety critical components.

Ref. No	Add-ress	New Parts	Parts No.	Description	Desti-nation	Re-marks
-			J61-0098-05	WIRE BAND		
643	2A		K27-2248-04	KNOB (BUTTON)	M1	
644	2A		K29-6852-04	KNOB		
645	2A		K29-6855-03	KNOB		
646	2A		K29-6858-12	KNOB		
△ 650	1B		L07-2463-15	POWER TRANSFORMER	KP1K1	
△ 650	1B		L07-2463-15	POWER TRANSFORMER	P2	
△ 650	1B		L07-2464-15	POWER TRANSFORMER	M1	
△ 650	1B		L92-0094-05	FERRITE CORE		
655	1A		T90-0833-05	LOOP ANTENNA		
656	1A		T90-0841-05	LEAD WIRE ANTENNA		
POWER (X07-2940-10)						
C55 ,58	C		CF92FV1H334J	MF-C	0.33UF	J
C59 ,60	C		CF92FV1H184J	MF-C	0.18UF	J
C59 ,60	C		CF92FV1H184J	MF-C	0.18UF	J
C161	C		CE04KW0J331M	ELECTRO	330UF	6.3WV
SURROUND (X08-2850-11)						
C592	C		CK73FB1E823K	CHIP C	0.082UF	K
C947	D		-			
C956	A		CK73FB1E104K	CHIP C	0.10UF	K
R1	A		RK73FB2A332J	CHIP R	3.3K	J 1/10W
R2	A		RK73FB2A473J	CHIP R	47K	J 1/10W
R3	A		RK73FB2A684J	CHIP R	680K	J 1/10W
R558-561	C		RK73FB2A331J	CHIP R	330	J 1/10W
R655	C		RK73FB2A472J	CHIP R	4.7K	J 1/10W
R998	C		RK73FB2A101J	CHIP R	100	J 1/10W
D201-208	A		MA111	DIODE		
IC66	C	*	UPD78058GC-B36	MI-COM IC		
IC87	C		27C1000MC-70	MEMORY IC		
Q69	A		DTA124EUA	TRANSISTOR		
Q69	A		UN5112	TRANSISTOR		
STONE (X11-3802-91)						
D21 -24	C		B30-2532-05	LED(INFRARED)		
C29 ,30	A		CE04KW1A101M	ELECTRO	100UF	10WV
C31 ,32	A		CC73FSL1H221J	CHIP C	220PF	J
C135,136	C		CE04KW1V470M	ELECTRO	47UF	35WV
C141,142	C		CE04KW1V470M	ELECTRO	47UF	35WV
C147,148	C		CE04KW1V470M	ELECTRO	47UF	35WV
C353	A		CK45FF1H103Z	CERAMIC	0.010UF	Z
C354	A		CC73FSL1H151J	CHIP C	150PF	J
C355,356	A		CE04KW1H100M	ELECTRO	10UF	50WV
C359,360	A		CE04KW1H2R2M	ELECTRO	2.2UF	50WV
C379,380	A		CC73FSL1H220J	CHIP C	22PF	J
C383,384	A		CC73FSL1H101J	CHIP C	100PF	J
C639	D		-			
C640	D		-			
C641	C		CC73FCH1H470J	CHIP C	47PF	J
J6	C		E63-1084-05	PIN JACK		
R29 ,30	A		RK73FB2A224J	CHIP R	220K	J 1/10W

L : Scandinavia K : USA P : Canada R : Mexico C : China I : Malaysia

Y : PX(Far East, Hawaii) T : England E : Europe G : Germany V : China (Shanghai)

Y : AAFES(Europe) X : Australia Q : Russia H : Korea M : Other Areas △ indicates safety critical components.

* New Parts
 Parts without **Parts No.** are not supplied.
 Les articles non mentionnés dans le **Parts No.** ne sont pas fournis.
 Teile ohne **Parts No.** werden nicht geliefert.

3

Ref. No	Add-ress	New Parts	Parts No.	Description	Desti-nation	Re-marks
R73 ,74	A		RK73FB2A104J	CHIP R 100K J 1/10W	KP1 M1K1P2	
R355	C		RK73FB2A112J	CHIP R 1.1K J 1/10W		
R361 ,362	A		RK73FB2A104J	CHIP R 100K J 1/10W		
R361 ,362	A		RK73FB2A124J	CHIP R 120K J 1/10W		
R365 ,366	A		RK73FB2A101J	CHIP R 100 J 1/10W		
R367-370	A		RK73FB2A102J	CHIP R 1.0K J 1/10W		
VR601	C		R32-0037-05	SEMI FIXED VARIABLE RESISTOR		
IC29	A		NJM4565D	IC(OP AMP X2)		
Q31 ,32	A		2SC4213(B)	TRANSISTOR		
ELECTRIC (X25-6040-11)						
C145	D		-			
C146	D		-			
C320	C		CC73FSL1H270J	CHIP C 27PF J		
C369	C		CC73FSL1H270J	CHIP C 27PF J		
C412	A		CK73FB1H103K	CHIP C 0.010UF K		
C451	A		CE04KW2A4R7M	ELECTRO 4.7UF 100WV		
C513	D		-			
C550	C		CC73FSL1H181J	CHIP C 180PF J		
C553,554	C		CC73FSL1H181J	CHIP C 180PF J		
C708	A		CK73FB1E104K	CHIP C 0.10UF K		
△ F3	C		F50-0070-05	FUSE(5X20)	KP1K1 P2	
△ F3	C		F50-0070-05	FUSE(5X20)		
R417	D		-			
R477	A		RD14NB2E391J	RD 390 J 1/4W		
R996,997	A		RK73FB2A473J	CHIP R 47K J 1/10W		
D46	A		HZS24N(B)	ZENER DIODE		
D46	A		RD24ES(B)	ZENER DIODE		
D47	A		HZS30N(B)	ZENER DIODE		
D47	A		RD30ES(B)	ZENER DIODE		
D997	A		HSS104A	DIODE		
D997	A		1SS133	DIODE		
IC61	C		UPD780204-038	MI-COM IC		
Q452	A		2SC3944(R,S)	TRANSISTOR		
Q455	A		2SC4177(L5,L6)	TRANSISTOR		

L : Scandinavia K : USA P : Canada R : Mexico C : China I : Malaysia
 Y : PX(Far East, Hawaii) T : England E : Europe V : China (Shanghai)
 Y : AAFES(Europe) X : Australia Q : Russia H : Korea M : Other Areas △ indicates safety critical components.

HOW TO READ THE PARTS LIST

Destination column has the abbreviation for sale country and model.
 Alphabets mean the country. Numerals do the model.
 Example: P2 shows VR-3090 for Canada market.
 "P" does all models for Canada.

ABBREVIATION OF MODEL AND MASS PRODUCTION'S DESTINATIONS

MODEL	CNT	Australia	Canada	China	England	Europe	Germany	Korea	Malaysia
ABB.	X	P	C	T	E	G	H	I	
KRF-V9992D	-	-	-	-	-	-	-	-	-
VR-3090	-	-	P2	-	-	-	-	-	-
VR-3100	-	-	P1	-	-	-	-	-	-

MODEL	CNT	Mexico	PX/AAFES	Russia	Scandinavia	Shanghai	USA	Other area	Other area(M2)
ABB.	R	Y	Q	L	V	K	M	M2	
KRF-V9992D	-	-	-	-	-	-	-	M1	-
VR-3090	-	-	-	-	-	-	K1	-	-
VR-3100	-	-	-	-	-	-	K	-	-

Address

- C: Change parts #
- D: Deletion
- A: Addition

PARTS LIST

KRF-V9992D/VR-3090/3100

KRF-V9992D/VR-3090/3100

SPECIFICATIONS (VR-3100)

AUDIO section

Rated output power during STEREO operation

100 watts per channel minimum RMS, both channels driven, at 6 Ω from 20 Hz to 20 kHz with no more than 0.03 % total harmonic distortion.(FTC)

Rated output power during SURROUND operation

FRONT
(1kHz, 0.06% T.H.D. at 6 Ω).....100 W + 100 W
CENTER
(1kHz, 0.06% T.H.D. at 6 Ω) 100 W
SURROUND
(1kHz, 0.06% T.H.D. at 6 Ω).....100 W + 100 W
Total harmonic distortion..... 0.004% (1 kHz, 50 W, 6 Ω)
Frequency response (IHF'78)
CD1 5 Hz ~ 80 kHz, +0.5 dB, -3 dB
Signal to noise ratio (IHF'66)
PHONO (MM) 77 dB
CD1 90 dB

Input sensitivity / impedance

PHONO (MM) 2.5 mV / 47 kΩ
CD1 200 mV / 47 kΩ

Output level / impedance

TAPAREC 200 mV / 220 Ω
PRE OUT (FRONT, CENTER, SURROUND, SUBWOOFER)
..... 1 V / 1 kΩ

Tone control

BASS ±7 dB (at 100 Hz)
TREBLE ±7 dB (at 10 kHz)

LOUDNESS control

VOLUME at -40dB level ... +7 dB(100 Hz), +4 dB(10 kHz)

DIGITAL AUDIO section

Sampling frequency 32 kHz, 44.1 kHz, 48 kHz

Input level / impedance / wave length

Optical -15 dBm ~ -21 dBm, 660 nm ±30nm
Coaxial 0.5 Vp-p / 75 Ω

Output level / impedance / wave length

Optical -15 dBm ~ -21 dBm, 660 nm ±30nm

VIDEO section

VIDEO inputs / outputs

VIDEO (composite) 1 Vp-p / 75 Ω
S VIDEO (luminance signal) 1 Vp-p / 75 Ω
(chrominance signal) 0.286 Vp-p / 75 Ω

FM tuner section

Tuning frequency range 87.5 MHz ~ 108 MHz

Usable sensitivity (MONO)

..... 1.6μV (75 Ω)/ 15.2 dBf (75 kHz DEV., SINAD 30 dB)

50dB quieting sensitivity

STEREO 31.6μV (75 Ω)/ 41.2 dBf

Total harmonic distortion (1 kHz)

MONO 0.3 % (65 dBf input)
STEREO 0.6 % (65 dBf input)

Signal to noise ratio (1 kHz, 75 kHz DEV.)

MONO 75 dB (65 dBf input)
STEREO 68 dB (65 dBf input)

Stereo separation (1 kHz) 38 dB

Selectivity (±400 kHz) 70 dB

Frequency response 30 Hz ~ 15kHz,+0.5 dB, -3.0 dB

AM tuner section

Tuning frequency range

10 kHz step 530 kHz ~ 1,700 kHz

Usable sensitivity (30% mod., S/N 20 dB)

..... 16 μV / (600 μV/m)

Signal to noise ratio (30 % mod. 1 mV input) 50 dB

Relay and IR IN/OUT section

RELAY CONTROL terminal

Maximum output current 20 mA
Operating voltage 12 V
Output impedance 470 Ω

IR RECEIVER IN terminal

Maximum output current 20 mA
Operating voltage 12 V
Output impedance 470 Ω

IR OUT LCD REMOTE terminal

Maximum output current 20 mA
Operating voltage 5 V
Output impedance 470 Ω

IR REPEATER CONTROL terminals

Maximum output current 20 mA
Operating voltage 12 V
Output impedance 470 Ω

Shape of plug to be connected

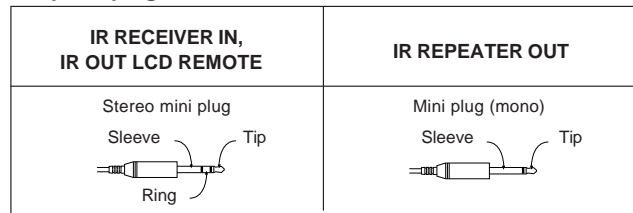

IR IN/OUT specification

Terminal	IR RECEIVER IN	IR OUT LCD REMOTE
To Tip	Signal	Signal
To Ring	Ground	—
To Sleeve	+12 V	Ground

RELAY CONTROL specification

Status	Power off	Power on	Power on and when switch to video input
To Tip	0 V	0 V	+12 V
To Ring	0 V	+12 V	+12 V
To Sleeve	Ground	Ground	Ground

GENERAL

Power consumption 3.5 A

AC outlet

SWITCHED 2 (total 90 W, 0.75 A max.)

Dimensions W : 440 mm (17-5/16")

H : 162 mm (6-3/8")

D : 391 mm (15-3/8")

Weight (Net) 11.2 kg (24.7 lb)



1. KENWOOD follows a policy of continuous advancements in development. For this reason specifications may be changed without notice.
2. Full performance may not be exhibited in extremely cold locations (below 0 deg.C).

KRF-V9992D/VR-3090/3100

SPECIFICATIONS (VR-3090)

AUDIO section

Rated output power during STEREO operation

100 watts per channel minimum RMS, both channels driven, at 6 Ω from 20 Hz to 20 kHz with no more than 0.03 % total harmonic distortion.(FTC)

Rated output power during SURROUND operation

FRONT
(1kHz, 0.06% T.H.D. at 6 Ω) 100 W + 100 W
CENTER
(1kHz, 0.06% T.H.D. at 6 Ω) 100 W
SURROUND
(1kHz, 0.06% T.H.D. at 6 Ω) 100 W + 100 W

Total harmonic distortion 0.004% (1 kHz, 50 W, 6 Ω)

Frequency response (IHF'78)
CD1 5 Hz ~ 80 kHz, +0.5 dB, -3 dB

Signal to noise ratio (IHF'66)
PHONO (MM) 77 dB
CD1 90 dB

Input sensitivity / impedance
PHONO (MM) 2.5 mV / 47 kΩ
CD1 200 mV / 47 kΩ

Output level / impedance
TAPE REC 200 mV / 220 Ω
PRE OUT (FRONT, CENTER, SURROUND, SUBWOOFER)
..... 1 V / 1 kΩ

Tone control
BASS ±7 dB (at 100 Hz)
TREBLE ±7 dB (at 10 kHz)
LOUDNESS control
VOLUME at -40dB level ... +7 dB(100 Hz), +4 dB(10 kHz)

DIGITAL AUDIO section

Sampling frequency 32 kHz, 44.1 kHz, 48 kHz
Input level / impedance / wave length
Optical -15 dBm ~ -21 dBm, 660 nm ±30nm
Coaxial 0.5 Vp-p / 75 Ω

VIDEO section

VIDEO inputs / outputs
VIDEO (composite) 1 Vp-p / 75 Ω
S VIDEO (luminance signal) 1 Vp-p / 75 Ω
(chrominance signal) 0.286 Vp-p / 75 Ω

FM tuner section

Tuning frequency range 87.5 MHz ~ 108 MHz
Usable sensitivity (MONO)
..... 1.6μV (75 Ω)/ 15.2 dBf (75 kHz DEV., SINAD 30 dB)
50dB quieting sensitivity
STEREO 31.6μV (75 Ω)/ 41.2 dBf
Total harmonic distortion (1 kHz)
MONO 0.3 % (65 dBf input)
STEREO 0.6 % (65 dBf input)
Signal to noise ratio (1 kHz, 75 kHz DEV.)
MONO 75 dB (65 dBf input)
STEREO 68 dB (65 dBf input)
Stereo separation (1 kHz) 38 dB
Selectivity (±400 kHz) 70 dB
Frequency response 30 Hz ~ 15kHz,+0.5 dB, -3.0 dB

AM tuner section

Tuning frequency range
10 kHz step 530 kHz ~ 1,700 kHz
Usable sensitivity (30% mod., S/N 20 dB)
..... 16 μV / (600 μV/m)
Signal to noise ratio (30 % mod. 1 mV input) 50 dB

Relay and IR IN/OUT section

IR RECEIVER IN terminal
Maximum output current 20 mA
Operating voltage 12 V
Output impedance 470 Ω
IR OUT LCD REMOTE terminal
Maximum output current 20 mA
Operating voltage 5 V
Output impedance 470 Ω
IR Repeater Control Terminal
Maximum output current 20 mA
Operating voltage 12 V
Output impedance 470 Ω

Shape of plug to be connected

IR RECEIVER IN and IR OUT LCD REMOTE	IR REPEATER OUT

IR IN/OUT specification

Terminal	IR RECEIVER IN	IR OUT LCD REMOTE
To Tip	Signal	Signal
To Ground	Ground	—
To Sleeve	+12 V	Ground

GENERAL

Power consumption 3.5 A
AC outlet
SWITCHED 2 (total 90 W, 0.83 A max.)
Dimensions W : 440 mm (17-5/16")
H : 162 mm (6-3/8")
D : 391 mm (15-3/8")
Weight (Net) 11.2 kg (24.7 lb)



1. KENWOOD follows a policy of continuous advancements in development. For this reason specifications may be changed without notice.
2. Full performance may not be exhibited in extremely cold locations (below 0 deg.C).

KRF-V9992D/VR-3090/3100

SPECIFICATIONS (KRF-V9992D)

AUDIO section

Rated output power during STEREO operation
63 Hz ~ 12.5 kHz, 0.7%, 6 Ω (DIN/IEC) ... 130 W + 130 W

130 watts per channel minimum RMS, both channels driven, at 6 Ω from 20 Hz to 20 kHz with no more than 0.03 % total harmonic distortion.(FTC)

Effective output power during STEREO operation
1kHz, 10% T.H.D., at 6 Ω 180 W + 180 W

Effective output power during SURROUND operation
FRONT
(1kHz, 0.06% T.H.D. at 6 Ω one channel driven)
..... 130 W + 130 W
(1kHz, 10% T.H.D. at 6 Ω one channel driven)
..... 180 W + 180 W

CENTER
(1kHz, 0.06% T.H.D. at 6 Ω one channel driven) ... 130 W
(1kHz, 10% T.H.D. at 6 Ω one channel driven) 180 W

SURROUND
(1kHz, 0.06% T.H.D. at 6 Ω one channel driven)
..... 130 W + 130 W
(1kHz, 10% T.H.D. at 6 Ω one channel driven)
..... 180 W + 180 W

Total harmonic distortion 0.004 % (1kHz, 65 W, 6 Ω)

Frequency response (IHF'78)
CD1 5 Hz ~ 80 kHz, +0.5 dB, -3 dB

Signal to noise ratio (IHF'66)
PHONO (MM) 77 dB
CD1 92 dB

Input sensitivity / impedance
PHONO (MM) 2.5 mV / 47 kΩ
CD1 200 mV / 47 kΩ

Output level / impedance
TAPE REC 200 mV / 220 Ω
PRE OUT (FRONT, CENTER, SURROUND, SUBWOOFER)
..... 1 V / 1 kΩ

Tone control
BASS ±7 dB (at 100 Hz)
TREBLE ±7 dB (at 10 kHz)

LOUDNESS control
VOLUME at -40dB level ... +7 dB(100 Hz), +4 dB(10 kHz)

DIGITAL AUDIO section

Sampling frequency 32 kHz, 44.1 kHz, 48 kHz

Input level / impedance / wave length
Optical -15 dBm ~ -21 dBm, 660 nm ±30nm
Coaxial 0.5 Vp-p / 75 Ω

OUTPUT level / impedance / wave length
Optical -15 dBm ~ -21 dBm, 660 nm ±30nm

VIDEO section

VIDEO inputs / outputs
VIDEO (composite) 1 Vp-p / 75 Ω
S VIDEO (luminance signal) 1 Vp-p / 75 Ω
(chrominance signal) 0.286 Vp-p / 75 Ω

FM tuner section

Tuning frequency range 87.5 MHz ~ 108 MHz

Usable sensitivity (MONO)
..... 1.6μV (75 Ω) / 15.2 dBf(75 kHz DEV., SINAD 30 dB)

50dB quieting sensitivity
STEREO 31.6μV (75 Ω) / 41.2 dBf

Total harmonic distortion (1 kHz)
MONO 0.6 % (65 dBf input)

STEREO 0.7 % (65 dBf input)

Signal to noise ratio (1 kHz, 75 kHz DEV.)
MONO 75 dB (65 dBf input)

STEREO 68 dB (65 dBf input)

Stereo separation (1 kHz) 38 dB

Selectivity (±400 kHz) 50 dB

Frequency response 30 Hz ~ 15kHz,+0.5 dB, -3.0 dB

AM tuner section

Tuning frequency range

9 kHz step 531 kHz ~ 1,602 kHz

10 kHz step 530 kHz ~ 1,610 kHz

Usable sensitivity (30% mod., S/N 20 dB)
..... 16 μV / (600 μV/m)

Signal to noise ratio (30 % mod. 1 mV input) 50 dB

IR IN/OUT section

IR RECEIVER IN terminal
Maximum output current 15 mA
Operating voltage 12 V
Output impedance 470 Ω

IR OUT LCD REMOTE terminal
Maximum output current 15 mA
Operating voltage 5 V
Output impedance 470 Ω

Shape of plug to be connected

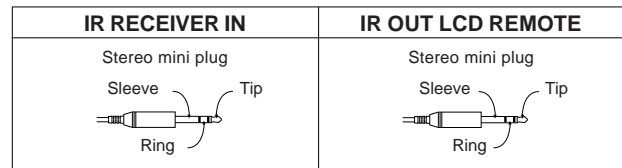

IR IN/OUT specification

Terminal	IR RECEIVER IN	IR OUT LCD REMOTE
To Tip	Signal	Signal
To Ring	Ground	—
To Sleeve	+12 V	Ground

GENERAL

Power consumption 380 W

AC outlet
SWITCHED 2 (total 70 W max.)

Dimensions W : 440 mm
H : 162 mm
D : 391 mm

Weight (Net) 12.2 kg



1. KENWOOD follows a policy of continuous advancements in development. For this reason specifications may be changed without notice.
2. Full performance may not be exhibited in extremely cold locations (below 0 deg.C).

Note:

Component and circuit are subject to modification to insure best operation under differing local conditions. This manual is based on Europe (E) standard, and provides information on regional circuit modification through use of alternate schematic diagrams, and information on regional component variations through use of parts list.

KENWOOD CORPORATION

14-6,Dogenzaka 1-chome, Shibuya-ku, Tokyo, 150-8501 Japan

KENWOOD SERVICE CORPORATION

P.O BOX 22745, 2201 East Dominguez St., Long Beach, CA 90801-5745, U.S.A.