

VR-505/506/507/ 509/510/517

SERVICE MANUAL

© 2001-2/B51-5700-00 (K/K) 1380

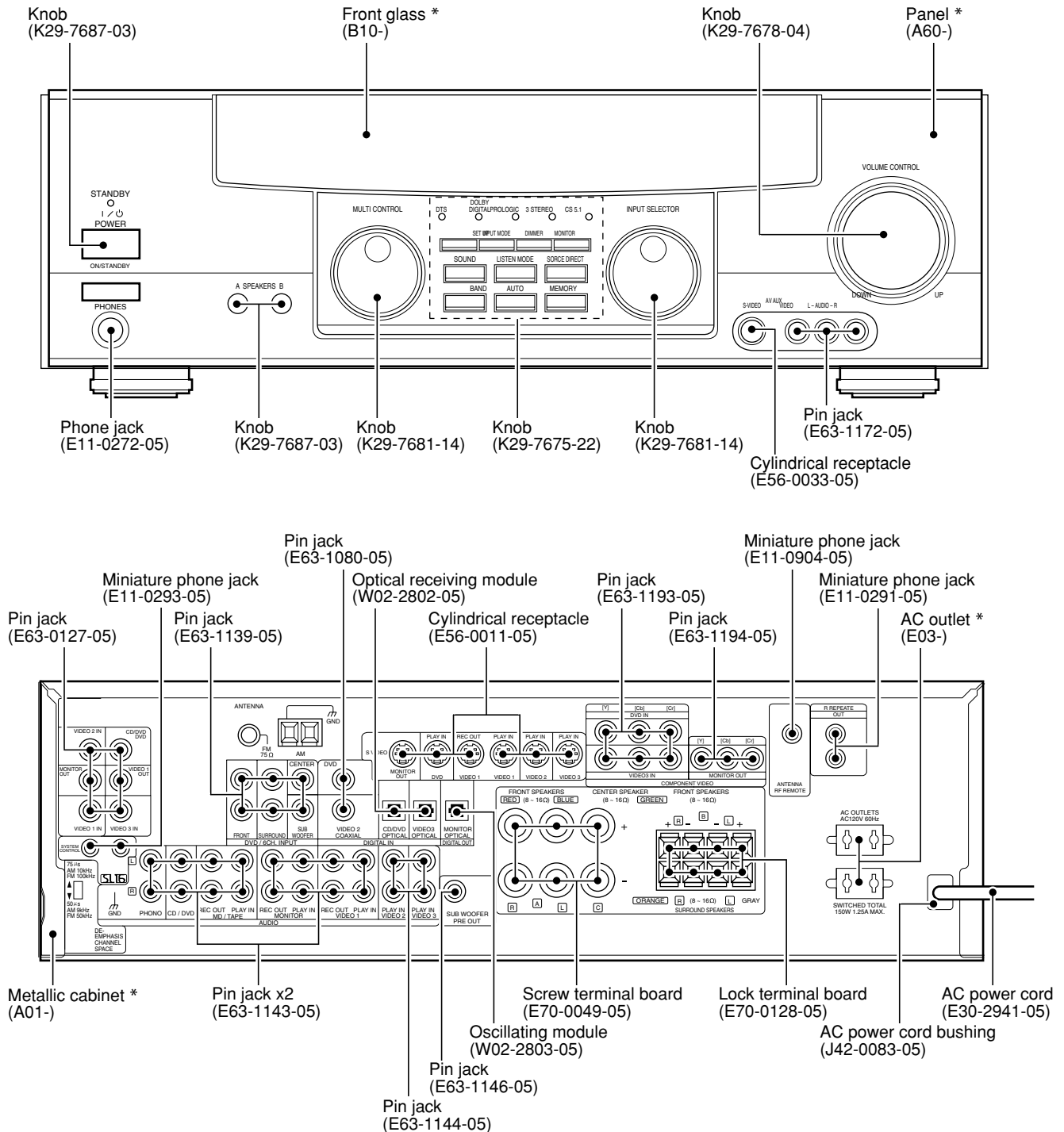

Illustration is VR-509.

* Refer to parts list on page 36 .





VR-505/506/507/509/510/517

CONTENTS / ACCESSORIES / CAUTIONS

Contents

CONTENTS / ACCESSORIES / CAUTIONS.....	2	EXPLODED VIEW	35
CIRCUIT DESCRIPTION	3	PARTS LIST.....	36
WIRING DIAGRAM	8	PARTS DESCRIPTIONS	46
PC BOARD	9	SPECIFICATIONS	47
SCHEMATIC DIAGRAM	15		

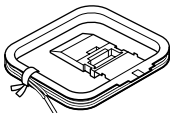
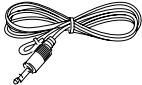
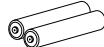
Accessories

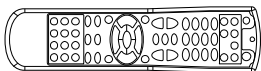
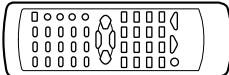
<p>FM indoor antenna (1) (T90-0877-05)</p> 	<p>AM loop antenna (1) (T90-0852-05)</p> 	<p>RF remote antenna (1) (T90-0850-05) VR-509/VR-510 only</p> 	<p>Batteries (R6/AA)</p> 
<p>Remote control unit (1) VR-509/510</p> 	<p>Remote control unit (1) VR-507</p> 	<p>Remote control unit (1) VR-505/506/517</p> 	

Remote Controller vs Parts Number

Model	Remote Controller	Parts #	Battery Cover Parts #
VR-505	RC-R0511	A70-1468-15	A09-1178-08
VR-506	RC-R0615	A70-1466-15	A09-1178-08
VR-507	RC-R0720	A70-1505-05	A09-1218-08
VR-509	RC-R0811	A70-1485-05	A09-1166-08
VR-510	RC-R0812	A70-1484-05	A09-1166-08
VR-517	RC-R0617	A70-1507-05	A09-1178-08

Cautions

Resetting the Microcomputer

The microcomputer may malfunction (unit cannot be operated, or shows an erroneous display) if the power cord is unplugged while the power is ON, or due to some other external factor. If this happens, execute the following procedure to reset the microcomputer and return the unit to its normal operating condition.

- Please note that resetting the microcomputer will clear the contents of the memory and returns the unit to the state it was in when it left the factory.

Unplug the power cord from the wall outlet, then plug it back in while holding down the STANDBY key.

Memory back up function

Please note that the following items will be deleted from the unit's memory if the power cord is disconnected from the AC outlet for approximately 2 days.

- Power mode.
- Input selector settings.
- Device preset.
- Picture output.
- Speaker ON/OFF
- Volume level.
- BASS, TREBLE, INPUT level.
- Subwoofer ON/OFF.
- Dimmer level.
- Monitor ON/OFF.
- MD/TAPE settings.
- 6ch/2ch input setting.
- Listen mode setting.
- Speaker settings.
- Input mode setting.
- Midnight mode setting.
- Broadcast band.
- Frequency setting.
- Preset stations.
- Tuning mode.
- Source Direct.
- RF Band.(VR-509/510)
- THX.(VR-510)
- SW RE-MIX.(VR-510)
- CINEMA EQ.(VR-505/506/507/509/517)

CIRCUIT DESCRIPTION

1. Initial and Backup Function

1-1 Initial State

Below are set value if the microcomputer is initialized when reset:

(1) AMP function initialization

• POWER	POWER OFF (STANDBY)
• Input Selector	TUNER
• Preset device	None
• Visual output	VIDEO1
• Speaker A relay	ON
• Speaker B relay	OFF
• Volume	-66dB
• BASS	0dB
• TREBLE	0dB
• INPUT LEVEL	0dB
• SOURCE DIRECT	0dB
• MONITOR	0dB
• VIDEO2/MONITOR	VIDEO2
• MD/TAPE	TAPE
• RF BAND	BAND 1

(2) SURROUND function initialization

• LISTEN MODE	STEREO
• INPUT MODE	
CD/DVD	DIGITAL AUTO
VIDEO2	ANALOG
VIDEO3	ANALOG
DVD/6ch	DIGITAL AUTO
• SUBWOOFER	ON

• FRONT speaker size	LARGE
• CENTER speaker size	NORMAL
• SURROUND speaker size	NORMAL
• DISTANCE	Fch 3.0m / 10ft
Cch	3.0m / 10ft
Sch	1.5m / 5ft
• LEFT level	0dB
• RIGHT level	0dB
• CENTER level	0dB
• REAR (SL,SR) level	0dB
• SUBWOOFER level	0dB
• MIDNIGHT	OFF
• CINEMA EQ	OFF

(3) TUNER function initialization

• BAND	FM
• PRESET CHANNEL	" - - "
• Frequency receive	Each destination minimum value
K1/K2	FM : 87.50 MHz
E1	AM : 530 kHz
E1	FM : 87.50 MHz
E1	AM : 531 kHz
• AUTO MANUAL	AUTO

1-2 Backup Function

When the AC power supply is turned off, the receiver micro-computer enters the backup mode. As a result, it will return to the last state before the AC OFF when the AC power supply is turned ON again

2. Destination List of Tuner

0 : Pull down, 1: Pull up

SET TYPE	TYPE	BAND	RECEIVING FREQUENCY RANGE	CHANNEL SPACE	IF	PLL	Tuner Destination Port			
							PORT3(68PIN) (CP205)	PORT2(67PIN) (W109)	PORT1(66PIN) (W105)	PORT0(65PIN) (W106)
K, P, R	K1 1700	FM	87.5MHz-108.0MHz	100kHz	+10.7MHz	25kHz	0	0	0	0
		AM	530kHz-1700kHz	10kHz	+450kHz	10kHz				
Y, M, I, C, V	K2 1610	FM	87.5MHz-108.0MHz	100kHz	+10.7MHz	25kHz	0	0	0	1
		AM	530kHz-1610kHz	10kHz	+450kHz	10kHz				
Y	K3 1610 RBDS	FM	87.5MHz-108.0MHz	100kHz	+10.7MHz	25kHz	0	0	1	0
		AM	530kHz-1610kHz	10kHz	+450kHz	10kHz				
K, P	K4 1700 RBDS	FM	87.5MHz-108.0MHz	100kHz	+10.7MHz	25kHz	1	0	1	0
		AM	530kHz-1700kHz	10kHz	+450kHz	10kHz				
Y, M, I, C, V, E, X, H	E1	FM	87.5MHz-108.0MHz	50kHz	+10.7MHz	25kHz	0	0	1	1
		AM	531kHz-1602kHz	9kHz	+450kHz	9kHz				
T	E2 LW	FM	87.5MHz-108.0MHz	50kHz	+10.7MHz	25kHz	0	1	0	0
		MW	531kHz-1602kHz	9kHz	+450kHz	9kHz				
		LW	153kHz-279kHz	9kHz	+450kHz	9kHz				
E, T	E3 RDS	FM	87.5MHz-108.0MHz	50kHz	+10.7MHz	25kHz	0	1	0	1
		AM	531kHz-1602kHz	9kHz	+450kHz	9kHz				
T	E4 LW RDS	FM	87.5MHz-108.0MHz	50kHz	+10.7MHz	25kHz	0	1	1	0
		MW	531kHz-1602kHz	9kHz	+450kHz	9kHz				
		LW	153kHz-279kHz	9kHz	+450kHz	9kHz				
Q	Q1 RDS	FM L	65.0MHz-74.0MHz	10kHz	+10.7MHz	5kHz	1	0	1	1
		FM H	87.5MHz-108.0MHz	50kHz	+10.7MHz	5kHz				
		AM	531kHz-1602kHz	9kHz	+450kHz	9kHz				
Q	Q2 RDS	FM L	65.0MHz-74.0MHz	10kHz	+10.7MHz	5kHz	1	1	0	0
		FM H	87.5MHz-108.0MHz	50kHz	+10.7MHz	5kHz				
		MW	531kHz-1602kHz	9kHz	+450kHz	9kHz				
		LW	153kHz-279kHz	9kHz	+450kHz	9kHz				
Y, M, I, C, V	M	K2/E1 are decided by Tuner Destination Port 1 input. (0=K2 type 1=E1 type)				0	0	X	1	
Y	Y RBDS	K3/E1 are decided by Tuner Destination Port 0 input. (0=K3 type 1=E1 type)				0	0	1	X	

CIRCUIT DESCRIPTION

3. Microprocessor: MN101C49GLE or MN101C49GLD(X14,IC200) 3-1 Microprocessor Periphery block diagram

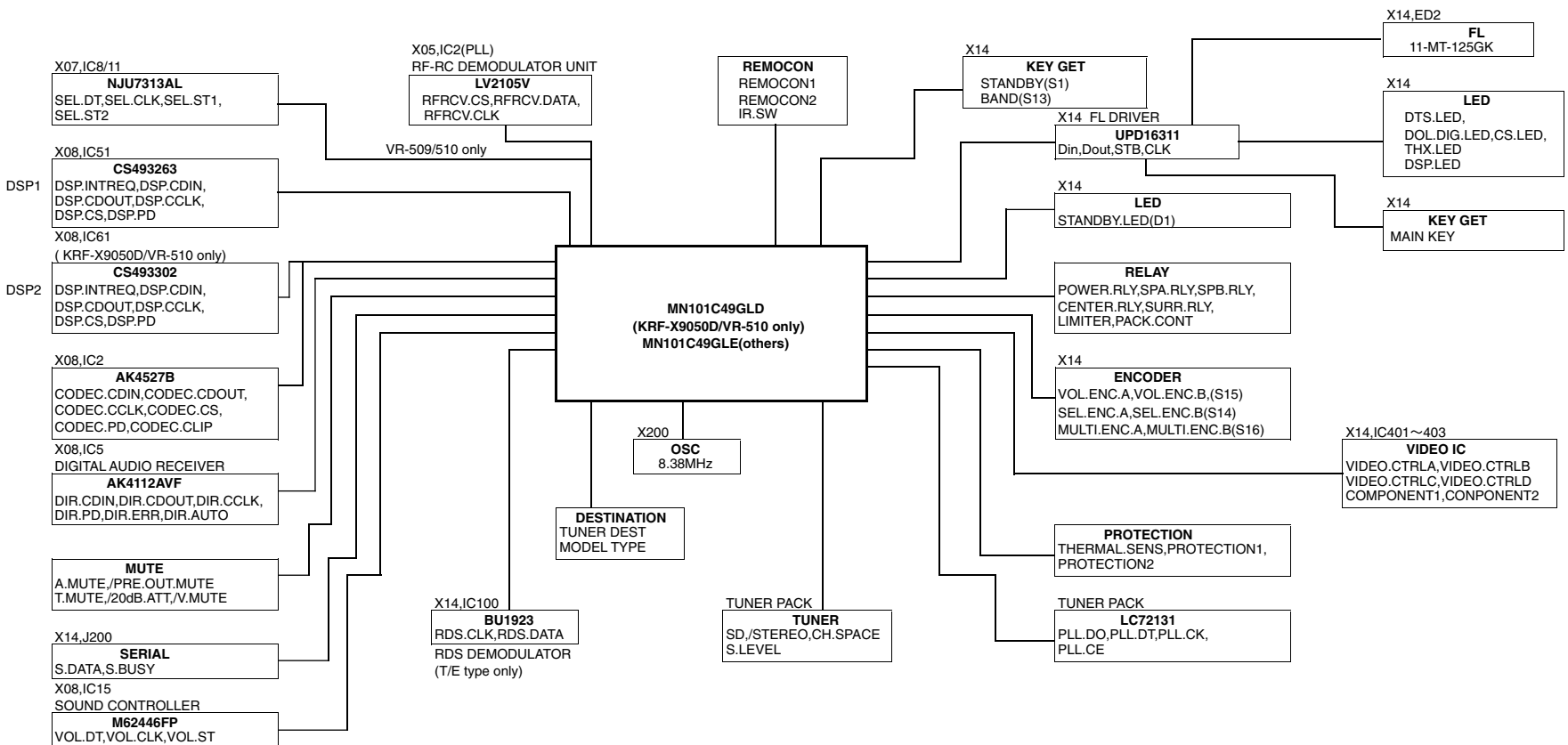

CIRCUIT DESCRIPTION

3-2 Pin Description of Microprocessor

Pin No.	Pin Name	I/O	Description
1	VREF	-	Connected to ground.
2	TH SENS	I	Protection signal detection port for thermal sensor.
3	PROT1	I	Protection signal detection port for over current.
4	PROT2	I	Protection signal detection port for over voltage.
5	S LEVEL	-	Detection port of RDS signal level.
6	KEY GET	I	A/D key input for band and standby.
7	CE2	I	Detection port of chip enable 2 for microprocessor.
8	CE1	I	Detection port of chip enable 1 for microprocessor.
9	DIG DET	I	Detection port of digital signal for DTS.
10	VREF	-	A/D reference voltage.
11	VDD	-	Power supply(+5v) for microprocessor.
12	OSC2	O	Main clock output(8.38MHz).
13	OSC1	I	Main clock input(8.38MHz).
14	VSS	-	Connected to ground.
15	XI	-	Connected to ground.
16	XO	-	Unused.
17	MMCD	-	Connected to ground.
18	DIR/CODEC DIN	O	Data output to DIR/CODEC.
19	DIR/CODEC DOUT	I	Data input port from DIR/CODEC.
20	DIR/CODEC CLK	O	Clock output to DIR/CODEC.
21	DSP DIN	O	Data output port to DSP.
22	DSP DOUT	I	Data input port from DSP.
23	DSP CLK	O	Clock output port to DSP.
24	DSP CE1	O	Chip enable 1 output to DSP.
25	DSP CE2	O	Chip enable 2 output to DSP.
26	REM I	I	Remote control signal input 1(Front panel).
27	REM 0	I	Remote control signal input 1(Rear panel).
28	DIR ERR	I	Detection port for DIR ERROR signal.
29	RDS CLK	I	Clock input of RDS demodulator IC.
30	DPS IRQ1	I	Detection port 1for DSP INTREQ.
31	DPS IRQ2	I	Detection port 2 for DSP INTREQ.
32	NC	-	Unused.
33	RESET	I	Reset signal input for microprocessor.
34	DSP PD1	O	PD output port 1for DSP.
35	DSP PD2	O	PD output port 2 for DSP.
36	DIR PD	O	Power down mode port for DIR.
37	CODEC PD	O	Power down mode port for CDDEC.
38	CODEC CLIP	I	Overflow detection port for CODEC analog signal.
39	CODEC CE	O	Chip select for CODEC.
40	RDS DIN	I	Data input of RDS demodulator IC.
41	NC	-	Unused.
42	FL DIN	O	Data output to FL driver.
43	FL DOUT	I	Data input from FL driver.
44	FL CLK	O	Clock output to FL driver.
45	FL CE	O	CE output to FL driver.

VR-505/506/507/509/510/517

CIRCUIT DESCRIPTION

Pin No.	Pin Name	I/O	Description
46	TUNER DIN	O	Data output to PLL IC.
47	TUNER CLK	O	Clock output to PLL IC.
48	TUNER CE	O	Chip enable output to PLL IC.
49	TUNER DOUT	I	Data input from PLL IC.
50	TUNER MUTE	O	Mute signal output to PLL IC.
51	TUNER STEREO	I	Stereo signal input from PLL IC.
52	TUNER SD	I	SD signal input from PLL IC.
53	RFRCV CE	O	Chip select output to RF remote control receiving IC.
54	RFRCV DIN	O	Data output to RF remote control receiving IC.
55	RFRCV CLK	O	Clock output to RF remote control receiving IC.
56	S BUSY	I/O	Serial busy signal input/output.
57	S DATA	I/O	Serial data signal input/output.
58	LIMITER	O	Power control for A class.
59	IR SW	O	Switching port of remote control signal.
60	DIR AUTO	I	Non PCM detect port.
61~63	MODEL T0~T3	I	Discrimination port for model type.
64	CH SPACE	I	Discrimination port for channel space.
65~68	TUNER DO~D3	I	Discrimination port(D0~D3) for tuner destination.
69	MULTI CW	I	Encoder (Multi control) upward detection.
70	MULTI CCW	I	Encoder (Multi control) downward detection.
71	SEL CW	I	Encoder (Selector)clockwise detection.
72	SEL CCW	I	Encoder (Selector)) counterclockwise detection.
73	VOL. CW	I	Encoder (Vol.)clockwise detection.
74	VOL.CCW	I	Encoder (Vol.) counterclockwise detection.
75	SP. A RLY	O	Relay control for A speaker.
76	CNT/SUB W RELAY	O	Relay control for center and sub speakers.
77	SP. B RLY	O	Relay control for B speaker.
78	SUB W	-	Unused.
79	SURR.RLY	O	Relay control for surround speaker.
80	PWR RLY	O	Control port of power relay.
81	PACK CONT.	O	Power pack control.
82	STANDBY RLY	O	Standby relay control.
83	SURR.MUTE	I	Mute control for surround.
84	20dB ATT.	O	20dB attenuater control.
85	A. MUTE	O	Audio mute control.
86	COMP 1	O	Video component switch control.
87	SEL DIN	O	Data output to selector IC(X08,IC12/14).
88~91	V. CTL A~D	O	Video switch control.
92	SEL. DIN	O	Data output to selector IC(X07,IC8/11).
93	SEL. CLK	O	Clock output to selector IC(X07,IC8/11).
94	SEL. ST1	O	Strobe 1 output to selector IC(X07,IC8).
95	DAVSS	-	Connected to ground.
96	SEL. ST 2	O	Strobe 2 output to selector IC(X07,IC11).
97	VOL. CE	O	Chip enable output to vol. IC (X08,IC15).
98	VOL. CLK	O	Clock output to vol. IC (X08,IC15).
99	V. MUTE	O	Mute control to video selector IC (X14,IC401/402).
100	DAVDD	-	+5V power supply.

CIRCUIT DESCRIPTION

4. AK4112AVF u-com interface port

Pin Name	Pin No.	I/O	Function
PD	7	I	Power Down Mode Pin When "L", the AK4112AVF is power down and reset.
AUTO	5	O	Non PCM Detect Pin "L":No detect, "H":Detect
FS96	17	O	96kHz Sampling Detect Pin "H":fs=88.2kHz or more, "L":fs=54kHz or less.
ERF	18	O	Unlock & Parity Error Output Pin "L":No Error, "H":Error
CSN	25	I	Chip Select pin in Serial Mode
CCLK	26	I	Control Data Clock Pin in Serial Mode
CDTI	27	I	Control Data Input Pin in Serial Mode
CDTO	28	O	Control Data Output Pin in Serial

5. AK4527B u-com interface port

Pin Name	Pin No.	I/O	Function
PDN	17	I	Power Down & Reset Pin
OVF	33	O	Analog Overflow Detect Pin
CSN	41	I	Chip Select Pin
CCLK	42	I	Control Data Clock Pin
CDTI	43	I	Control Data Input Pin

6. Test Mode

6-1 Entering the Test Mode

- While pressing the "BAND" key, plug the power cord into AC wall outlet.

6-2 Cancelling the Test Mode

- Initialized and cancel the test mode if pulling out the power code.

6-3 Contents of the Test Mode

6-3-1 Pch CALL UP/DOWN

Key	Function
DIMMER	Pch CALL UP →01→02→03·····39→40→
INPUT MODE	Pch CALL DOWN ←01←02←03·····39←40←

6-3-2 10 Steps Switching of P ch Call

Key	Function
SET UP	Preset Operation

6-3-3 TUNER mute on/off

Key	Function
LISTEN MODE	TUNER mute on/off

6-3-4 Key Operation

- The following operation is available during the all FL lighting up mode only.(only VR-507/509/510)

Operation Keys	Display	Function
SOUND	Normal Indication	RF receiving frequency is made 422MHz for VR-509/510 and 418MHz for VR-507.
LISTEN MODE	FRONT IR	FRONT IR is enabled and remote control is disabled.
SOURCE DIRECT	RF BAND 2	RF receiving frequency is made 428MHz for VR-509/510.

WIRING DIAGRAM

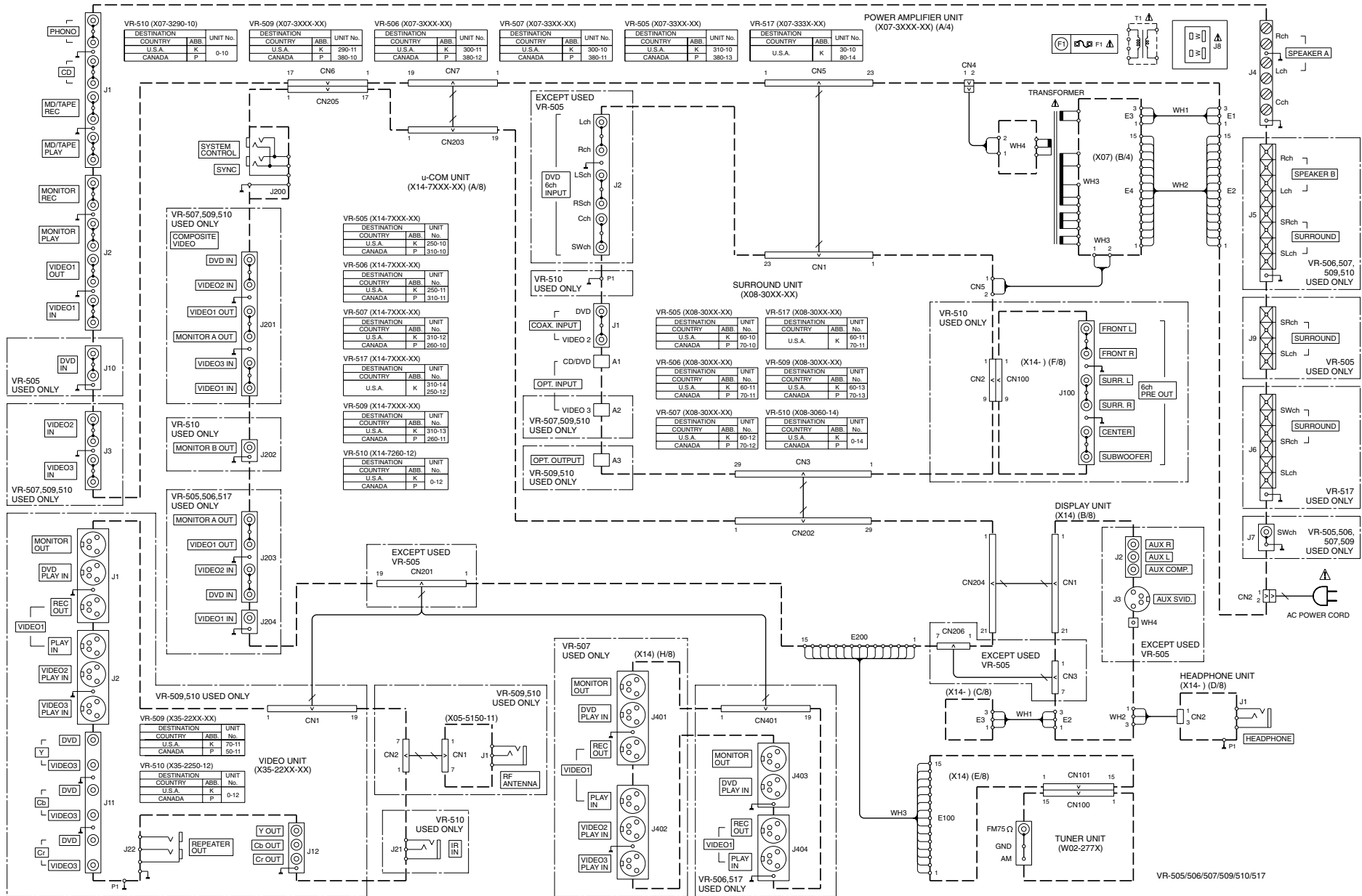

PC BOARD(Component side view)

X05-5150-11 (J70-1391-22)

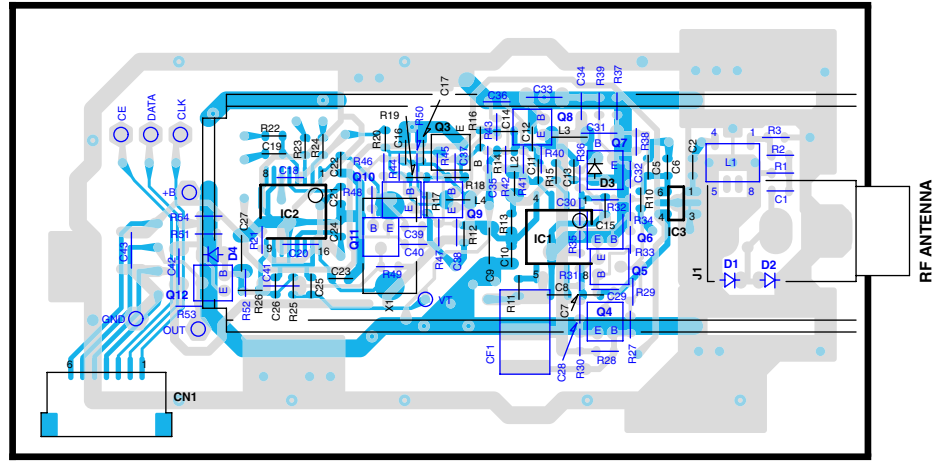

X08-3060-10 (J70-1459-32)

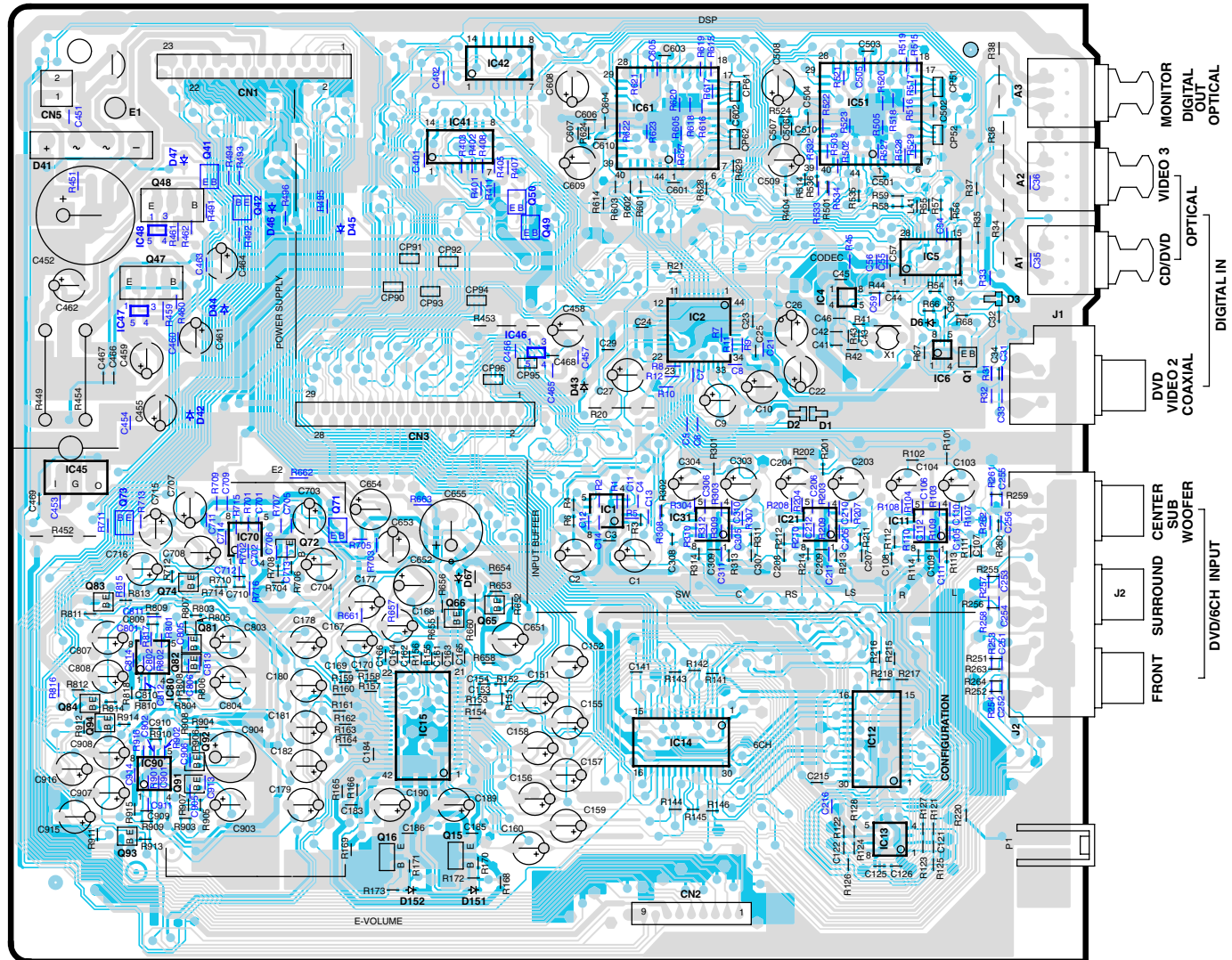

X35-2250-10 (J70-1468-02)

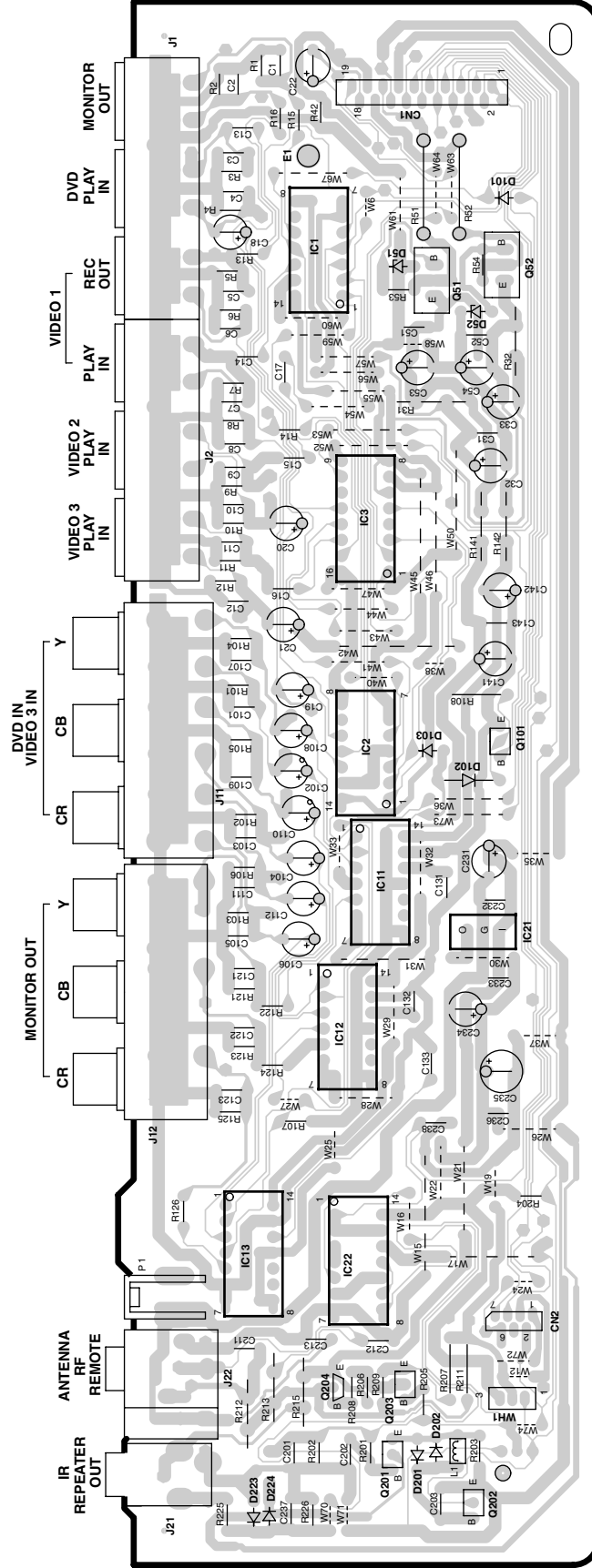

Refer to the schematic diagram for the value of resistors and capacitors.

PC BOARD(Component side view)

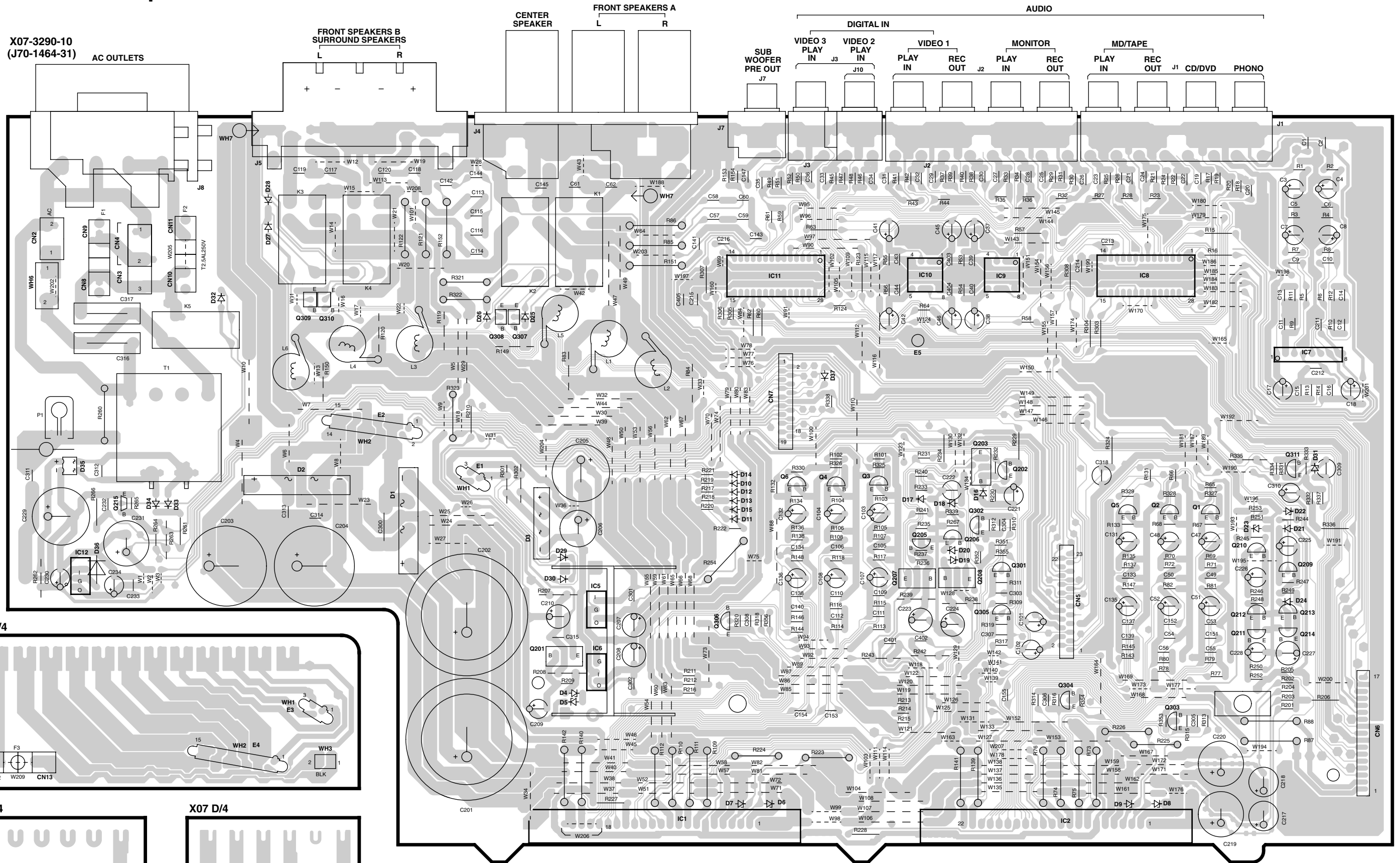

Note: There is a different from X07-3290, X07-3300, X07-3310 on PCB layout.

Refer to the schematic diagram for the value of resistors and capacitors.

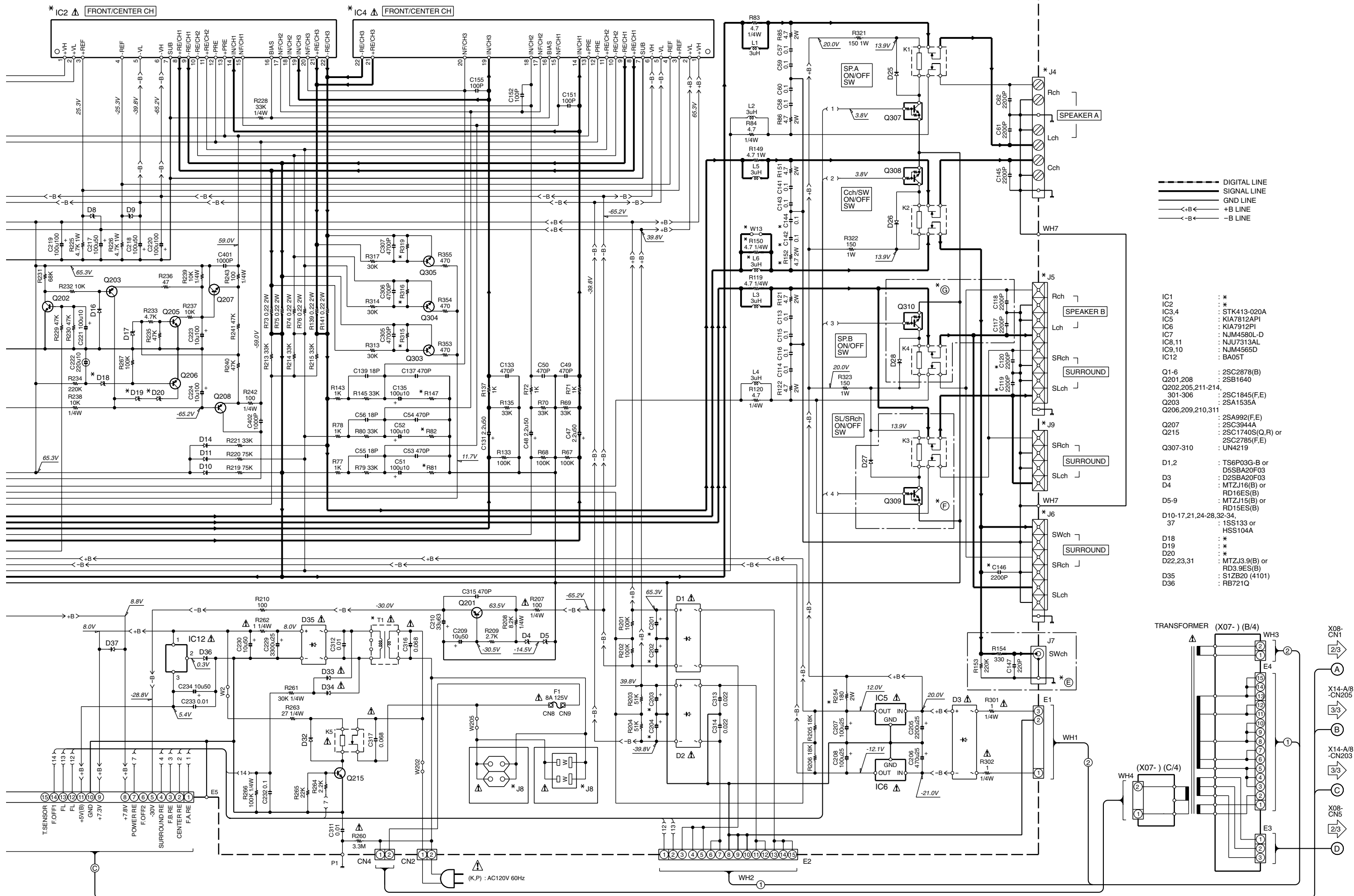

- - - - - DIGITAL LINE
 _____ SIGNAL LINE
 _____ GND LINE
 <-B< <-B< +B LINE
 <-B< <-B< -B LINE

- IC1 : *
- IC2 : *
- IC3,4 : STK413-020A
- IC5 : KIA7812API
- IC6 : KIA7912PI
- IC7 : NUM4580L-D
- IC8,11 : NUJ7313AL
- IC9,10 : NUM4565D
- IC12 : BA05T

- Q1-6 : 2SC2878(B)
- Q201,208 : 2SB1640
- Q202,205,211-214,301-306 : 2SC1845(F,E)
- Q203 : 2SA1535A
- Q206,209,210,311 : 2SA992(F,E)
- Q207 : 2SC3944A
- Q215 : 2SC1740S(Q,R) or 2SC2785(F,E)
- Q307-310 : UN4219

- D1,2 : TS6P03G-B or D5BA20F03
- D3 : D2SBA20F03
- D4 : MTZJ16(B) or RD16ES(B)
- D5-9 : MTZJ15(B) or RD15ES(B)
- D10-17,21,24-28,32-34,37 : 1SS133 or HSS104A
- D18 : *
- D19 : *
- D20 : *
- D22,23,31 : MTZJ3.9(B) or RD3.9ES(B)
- D35 : S1ZB20 (4101)
- D36 : RB721Q

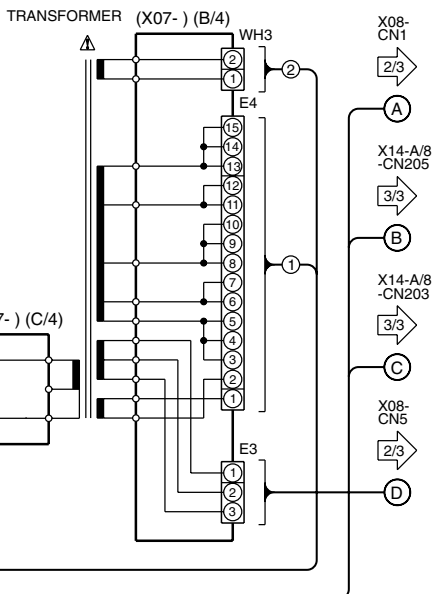

(X07-) (A/3)

VR-510 (X07-3290-10)

DESTINATION	COUNTRY	ABB.	UNIT No.	(A)	(C)	(D)	(E)	(F)	(G)	(B)	(E)	C119, 120	C142, 144, 146	C201,202	C203,204	R81,82, 117,118,147	R132,150, 152,222,330	R254	R315, 316,319	D15	D18	D19	D20	J4	J5	J6,9, 10	J8	Q6	W13,88, 198,201	IC1	IC2	IC3,4	L6	T1
U.S.A.	CANADA	K P	0-10	YES						NO	YES	NO	NO	C90-3945-05	C90-3946-05	1.2K	NO	YES	9.1K	NO	MTZJ8.2(B) RD8.2ES(B)	MTZJ15(B) RD15ES(B)	MTZJ20(B) RD20ES(B)	E70-0049-05	YES	NO	E03-0148-05	NO	NO	STK412-040T STK412-040N	STK413-040T	NO	NO	L07-2809-05

VR-509 (X07-33XX-XX)

DESTINATION	COUNTRY	ABB.	UNIT No.	(A)	(C)	(D)	(E)	(F)	(G)	(B)	(E)	C119, 120	C142, 144, 146	C201,202	C203,204	R81,82, 117,118,147	R132, 254,330	R150, 152,222	R315, 316,319	D15	D18	D19	D20	J4	J5	J6,9, 10	J8	Q6	W198, 201	W13, 88	IC1	IC2	IC3,4	L6	T1
U.S.A.	CANADA	K P	290-11 380-10	YES						NO	YES	NO	NO	C90-3982-05	C90-3983-05	1.1K	YES	NO	10K	NO	MTZJ8.2(B) RD8.2ES(B)	MTZJ16(B) RD16ES(B)	MTZJ18(B) RD18ES(B)	E70-0049-05	YES	NO	E03-0148-05	YES	NO	YES	STK412-020N	STK413-020N	NO	NO	L07-2809-05

VR-506 (X07-33XX-XX)

DESTINATION	COUNTRY	ABB.	UNIT No.	(A)	(E)	(F)	(G)	(B)	(C)	(D)	(E)	C119, 120	C142, 144, 146	C201,202	C203,204	R81,82, 117,118,147	R132, 330	R150,152, 222,254	R315, 316,319	D15	D18	D19	D20	J4	J5	J6,9, 10	J8	Q6	W198, 201	W13, 88	IC1	IC2	IC3,4	L6	T1
U.S.A.	CANADA	K P	300-11 380-12	YES						NO	YES	NO	NO	C90-3982-05	C90-3983-05	1.1K	YES	NO	10K	NO	MTZJ8.2(B) RD8.2ES(B)	MTZJ16(B) RD16ES(B)	MTZJ18(B) RD18ES(B)	E70-0049-05	YES	NO	E03-0148-05	YES	NO	YES	STK412-020N	STK413-020N	NO	NO	L07-2758-05

VR-507 (X07-33XX-XX)

DESTINATION	COUNTRY	ABB.	UNIT No.	(A)	(C)	(D)	(E)	(F)	(G)	(B)	(E)	C119, 120	C142, 144, 146	C201,202	C203,204	R81,82, 117,118,147	R132, 330	R150,152, 222,254	R315, 316,319	D15	D18	D19	D20	J4	J5	J6,9, 10	J8	Q6	W198, 201	W13, 88	IC1	IC2	IC3,4	L6	T1
U.S.A.	CANADA	K P	300-10 380-11	YES						NO	YES	NO	NO	C90-3982-05	C90-3983-05	1.1K	YES	NO	10K	NO	MTZJ8.2(B) RD8.2ES(B)	MTZJ16(B) RD16ES(B)	MTZJ18(B) RD18ES(B)	E70-0049-05	YES	NO	E03-0148-05	YES	NO	YES	STK412-020N	STK413-020N	NO	NO	L07-2809-05

VR-505 (X07-33XX-XX)

DESTINATION	COUNTRY	ABB.	UNIT No.	(A)	(C)	(D)	(E)	(F)	(G)	(B)	(E)	C119, 120	C142, 144, 146	C201,202	C203,204	R81,82, 117,118,147	R132, 330	R150,152, 222,254	R315, 316,319	D15	D18	D19	D20	J4	J5,6	J8	J9,10	Q6	W13,88, 198,201	IC1	IC2	IC3,4	L6	T1	
U.S.A.	CANADA	K P	310-10 380-13	NO						YES	YES	NO	NO	C90-3982-05	C90-3983-05	1.1K	YES	NO	10K	NO	MTZJ8.2(B) RD8.2ES(B)	MTZJ16(B) RD16ES(B)	MTZJ18(B) RD18ES(B)	E70-0122-05	NO	NO	E03-0316-05	YES	YES	YES	STK412-020N	STK413-020N	NO	NO	L07-2761-05

VR-517 (X07-333X-XX)

DESTINATION	COUNTRY	ABB.	UNIT No.	(A)	(C)	(D)	(E)	(F)	(G)	(B)	(E)	C119, 120	C142, 144, 146	C201,202	C203,204	R81,82,117, 118,147	R132,150, 152,222,330	R254	R315, 316,319	D15	D18	D19	D20	J4	J5,9, 10	J6	J8	Q6	W13, 88	W198, 201	IC1	IC2	IC3,4	L6	T1	
U.S.A.		K	30-10 80-14	NO						YES	NO	NO	YES	C90-3982-05	C90-3983-05	1.1K	YES	NO	10K	YES	MTZJ6.8(B) RD6.8ES(B)	MTZJ15(B) RD15ES(B)	MTZJ13(B) RD13ES(B)	E70-0122-05	NO	YES	E03-0148-05	YES	NO	NO	YES	NO	NO	STK413-020A	YES	L07-2761-05

CAUTION: For continued safety, replace safety critical components only with manufacturer's recommended parts (refer to parts list). Δ indicates safety critical components. For continued protection against risk of fire, replace only with same type and rating fuse(s). To reduce the risk of electric shock, leakage-current or resistance measurements shall be carried out (exposed parts are acceptably insulated from the supply circuit) before the appliance is returned to the customer.

The DC voltage is an actual reading measured with a high impedance type voltmeter with no signal input. The measurement value may vary depending on the measuring instruments used or on the product.

2SA1534A 2SC3940A
2SA992
2SC1845
2SC2878

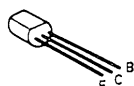

2SA1175
2SC2785

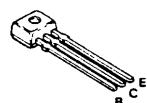

DTC124ESA
2SC1740S

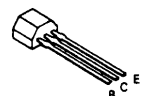

2SA1576A
2SB1218A
2SD1819A

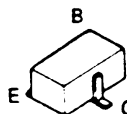

DAN202U

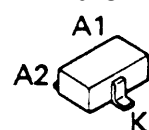

DAP202U

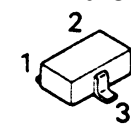

MA142WA
MA142WK
UN5212

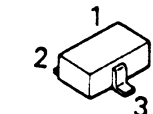

1SS301

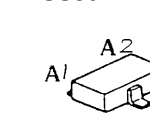

2SB1132

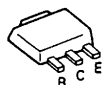

2SA1535A
2SC3944A



2SD1664

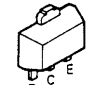

UN4212
UN4219

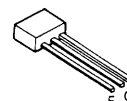

TC74HCT7007AF

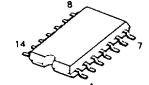

NJM2279M

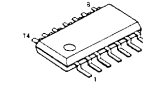

NJU7311AM

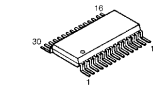

KIA7912PI

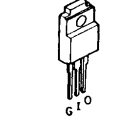

2SB1375



2SC4081

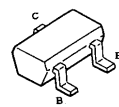

DTA124EUA
DTC124EUA

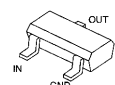

KTA1273



UPC1687G

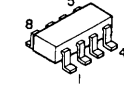

NJU7313AL

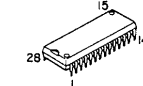

XC62FP5102P

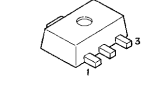

LV2105V

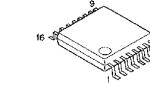

NJM4565D

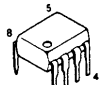

NJM2279D

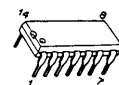

TC74HC00AP
TC74HC07AF

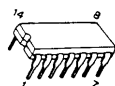

NJU4052BD

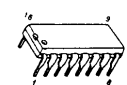

TC7WH123FU

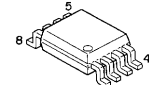

S-80840ANY

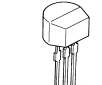

TC7WU04FU

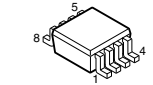

BA05T

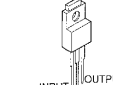

TC74HC4052AP

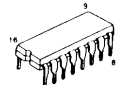

NJM4580L-D

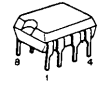

NJM4565M
NJM4565MD

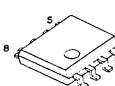

UPD16311

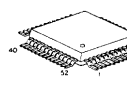

XC62EP2502MR

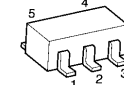

KIA7812API

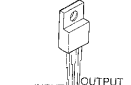

M62446FP

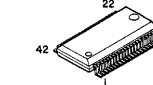

VR-505/506/507/509/510/517

Y05-4150-10

KENWOOD

X07-A/4
-CN5
1/3
A

X07-B/4
E3
1/3
D

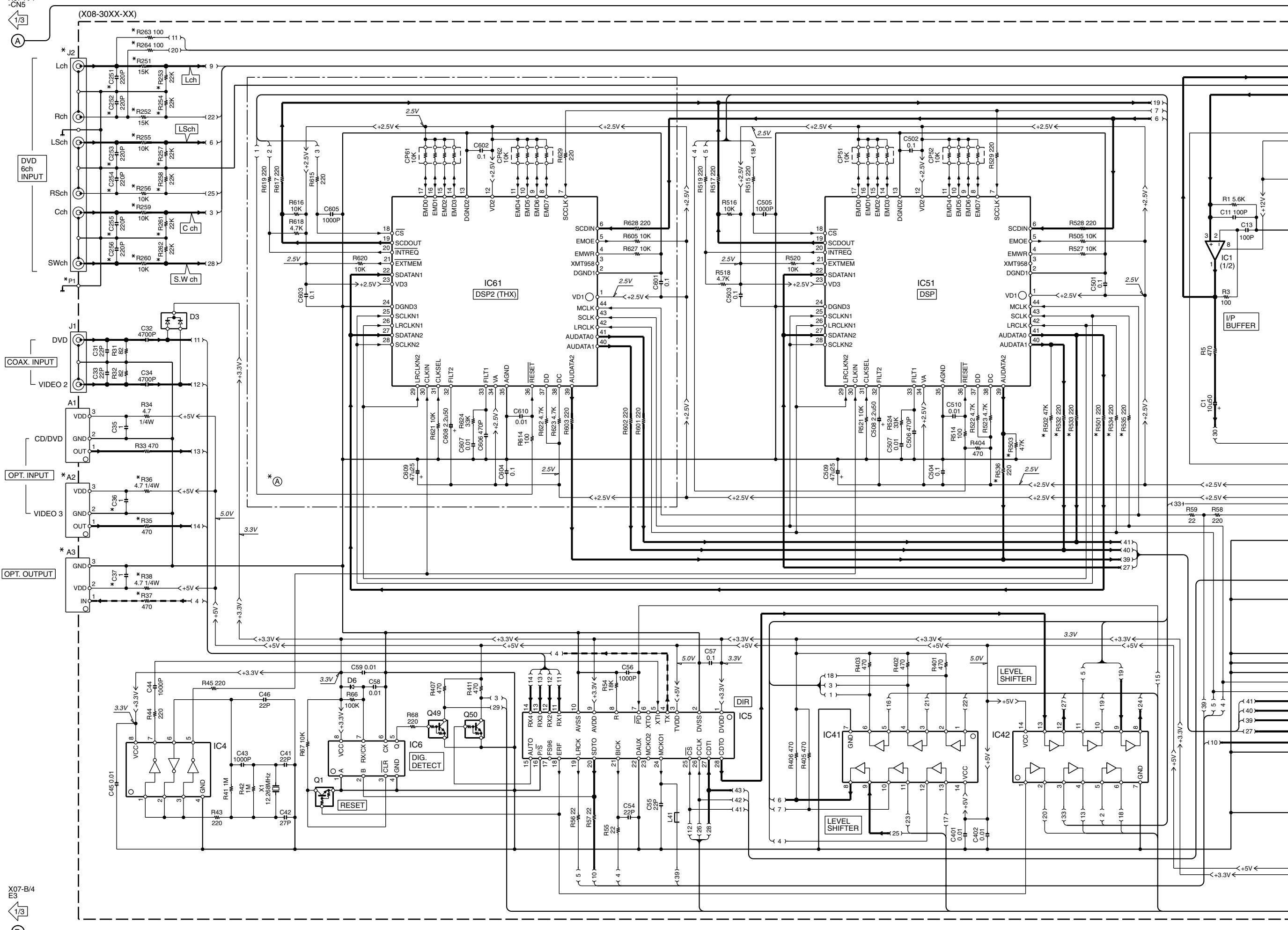

2

3

4

5

6

7

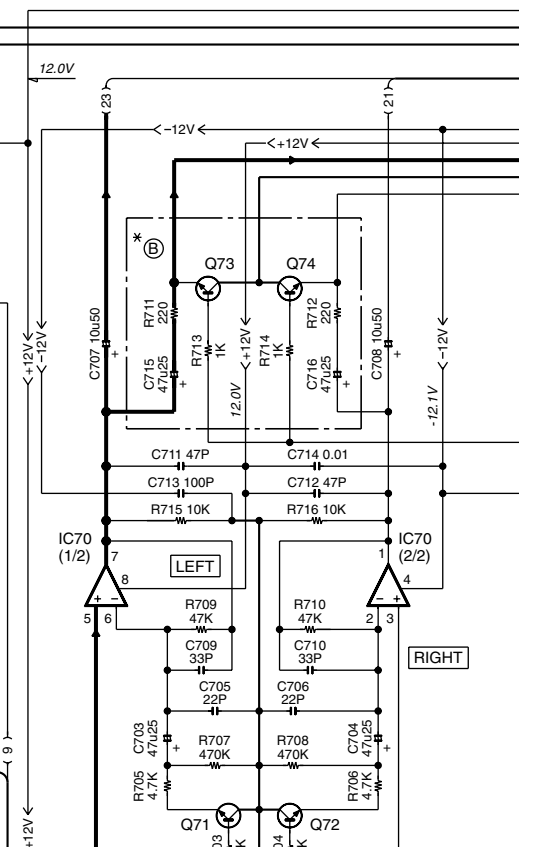
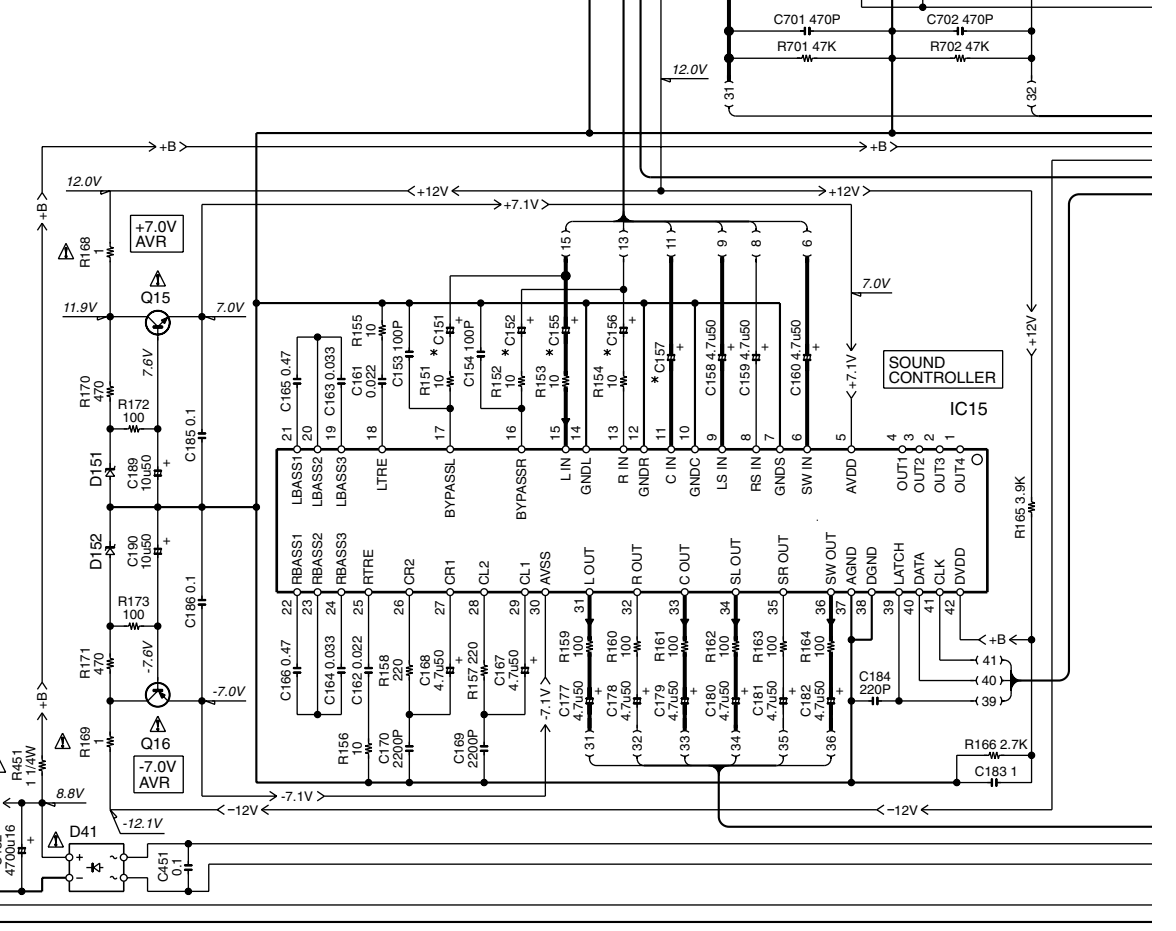
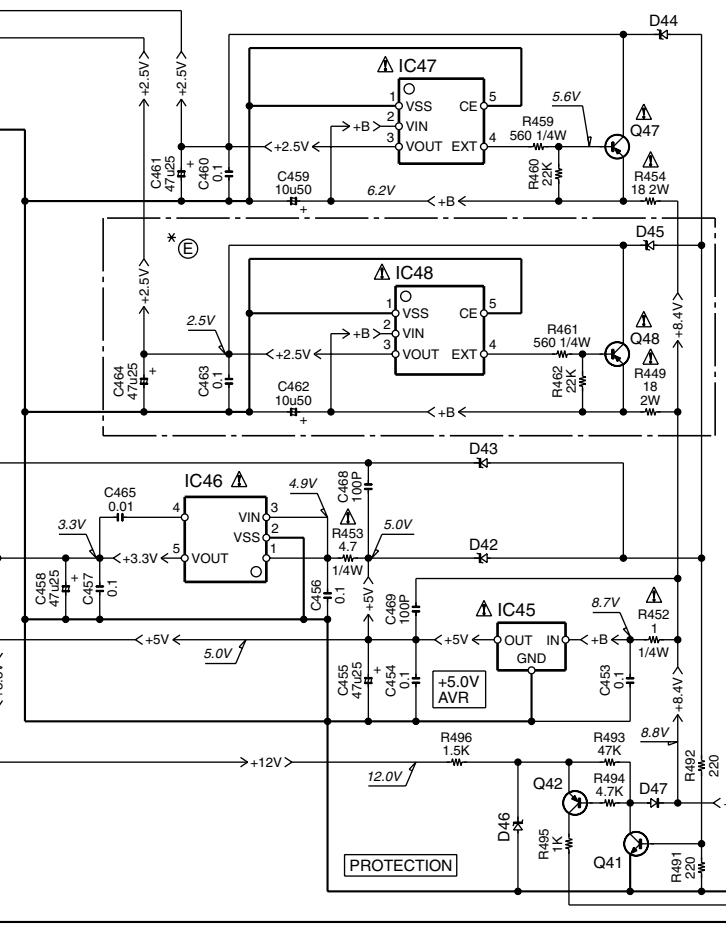
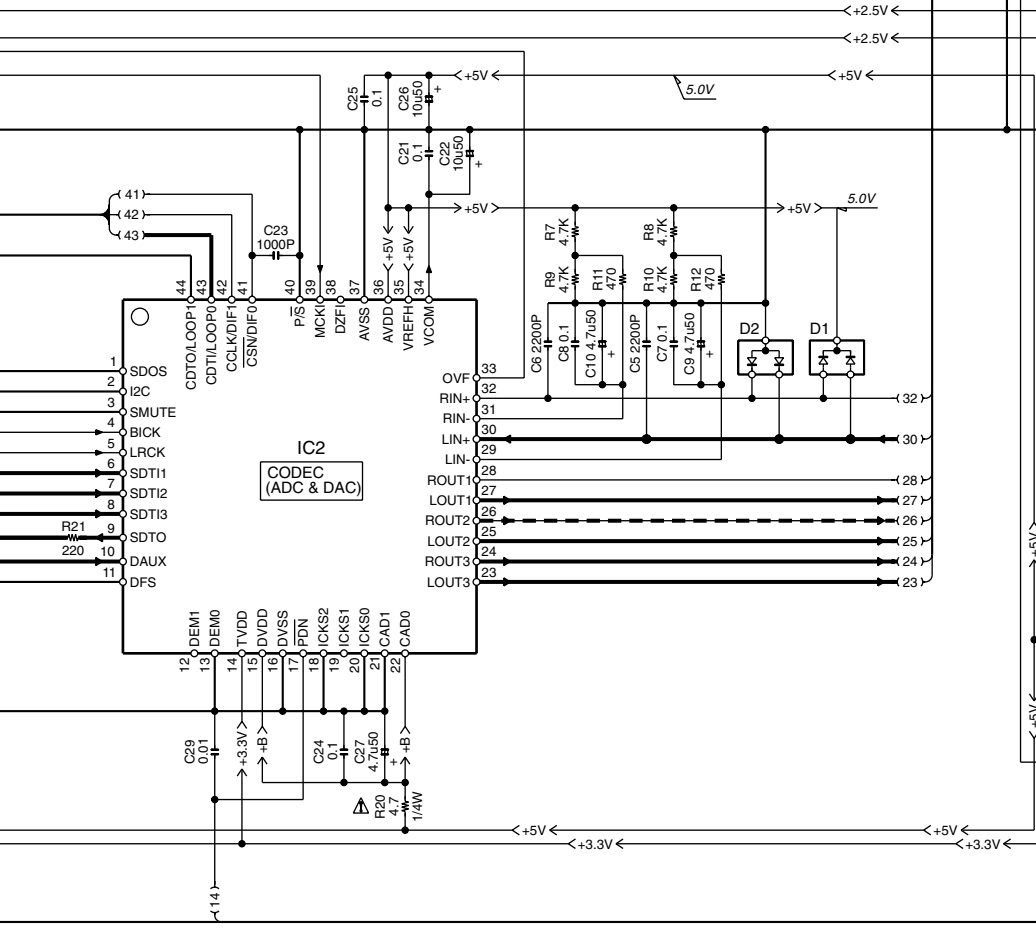
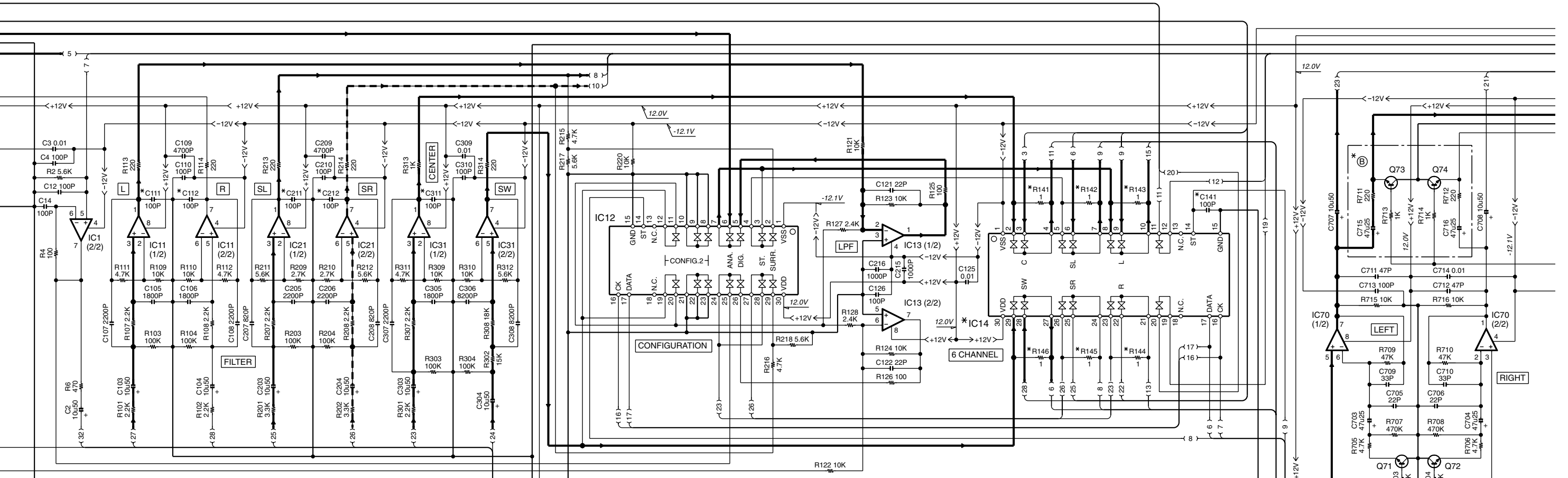

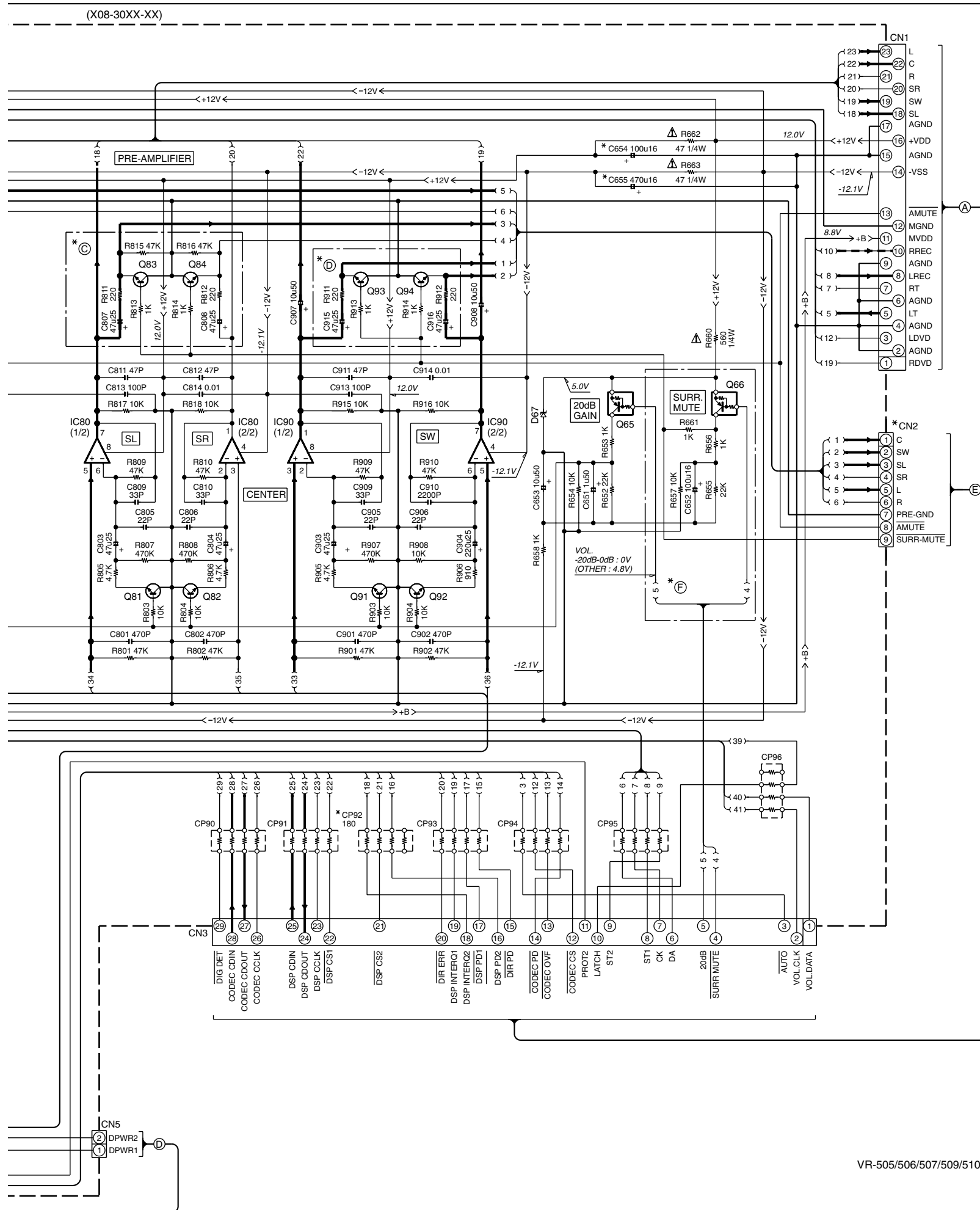

VR-505 (X08-30XX-XX)

DESTINATION	UNIT No.	A	B	C	D	E	F	A2 A3	C36,37,111,112,141,211, 212,251-256,311,654,655	C151,152, 155-157	R35-38, 251-264,501-503	R141-146, 532-536	IC14	J2	CP92	CN2	P1
U.S.A.	K	60-10							NO	NO	4.7u50	NO	YES	NO	NO	NO	NO
CANADA	P	70-10							NO	NO	4.7u50	NO	YES	NO	NO	NO	NO

VR-506 (X08-30XX-XX)

DESTINATION	UNIT No.	A	B	C	D	E	F	A2 A3	C36,37,111,112, 211,212,311,654,655	C141, 251-256	C151,152, 155-157	R35-38, 141-146,501-503	R251-264, 532-536	IC14	J2	CP92	CN2	P1
U.S.A.	K	60-11							NO	NO	YES	4.7u50	NO	YES	YES	YES	NO	NO
CANADA	P	70-11							NO	NO	YES	4.7u50	NO	YES	YES	YES	NO	NO

VR-507 (X08-30XX-XX)

DESTINATION	UNIT No.	A	B	C	D	E	F	A2 A3	C36,111,112,141, 211,212,311,251-256	C151,152, 155-157	C37, 654,655	R35,36,251-264, 532-536	R37,38, 141-146,501-503	IC14	J2	CP92	CN2	P1
U.S.A.	K	60-12							NO	NO	YES	4.7u50	NO	YES	NO	YES	NO	NO
CANADA	P	70-12							NO	NO	YES	4.7u50	NO	YES	YES	YES	NO	NO

VR-517 (X08-30XX-XX)

DESTINATION	UNIT No.	A	B	C	D	E	F	A2 A3	C36,37,111,112, 211,212,311,654,655	C141, 251-256	C151,152, 155-157	R35-38, 141-146,501-503	R251-264, 532-536	IC14	J2	CP92	CN2	P1
U.S.A.	K	60-11							NO	NO	YES	4.7u50	NO	YES	YES	NO	NO	NO
CANADA	P	70-11							NO	NO	YES	4.7u50	NO	YES	YES	NO	NO	NO

VR-509 (X08-30XX-XX)

DESTINATION	UNIT No.	A	B	C	D	E	F	A2 A3	C36,37,111,112,141, 212,251-256,311,654,655	C151,152, 155-157	C654, 655	R35-38, 251-264,532-536	R141-146, 501-503	IC14	J2	CP92	CN2	P1
U.S.A.	K	60-13							NO	YES	YES	4.7u50	NO	YES	YES	NO	NO	NO
CANADA	P	70-13							NO	YES	YES	4.7u50	NO	YES	YES	NO	NO	NO

VR-510 (X08-3060-14)

DESTINATION	UNIT No.	A	B	C	D	E	F	A2 A3	C36,37,111,112,141,211, 212,251-256,311,654,655	C151,152, 155-157	R35-38, 251-264,501-503	R141-146, 532-536	IC14	J2	CP92	CN2	P1	
U.S.A.	K	0-14							YES	YES	YES	4.7u100	YES	NO	YES	YES	YES	YES
CANADA	P	0-14							YES	YES	YES	4.7u100	YES	NO	YES	YES	YES	YES

- IC1,11,13,21,31,70,80,90 : NJM4565M or DTC124EUA
- IC2 : NJM4565MD
- IC4 : AK4527B-VQ
- IC5 : TC7WU04FU
- IC6 : AK4112AVF
- IC12,14 : TC7WH123FU
- IC15 : NJU7311AM
- IC41 : M62446FP
- IC42 : TC74HC07AF
- IC45 : TC74HCT7007AF
- IC46 : BA05T
- IC47,48 : BA033LBSG
- IC51 : XC62EP2502MR
- IC61 : CS493302-CLR
- Q1,49,50 : UN5212 or DTC124EUA
- Q15 : 2SD1664(Q,R)
- Q16 : 2SB1132(Q,R)
- Q41 : TC7WU04FU
- Q42 : 2SC4081(R,S) or 2SD1819A(Q,R)
- Q47,48 : 2SA1576A(R,S) or 2SB1218A(Q,R)
- Q65,66 : UN5112 or DTA124EUA
- Q71-74,81-84,91-94 : 2SC4213 (B)
- D1,3 : 1SS301 or DAN202U or MA142WK
- D2 : 1SS300 or DAP202U or MA142WA
- D6,47 : MA111
- D41 : D2SBA20F03
- D42,43 : UDZ5.6B or HZU5.6 (B2)
- D44,45 : UDZ3.9B or HZU3.9 (B2)
- D46,67 : UDZ5.1B or HZU5.1 (B2)
- D151,152 : UDZ7.5B or HZU7.5 (B2)

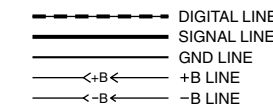

CAUTION: For continued safety, replace safety critical components only with manufacturer's recommended parts (refer to parts list). Δ indicates safety critical components. For continued protection against risk of fire, replace only with same type and rating fuse(s). To reduce the risk of electric shock, leakage-current or resistance measurements shall be carried out (exposed parts are acceptably insulated from the supply circuit) before the appliance is returned to the customer.

The DC voltage is an actual reading measured with a high impedance type voltmeter with no signal input. The measurement value may vary depending on the measuring instruments used or on the product.

X07-A/4 -CN6
1/3
B
X07-A/4 -CN7
1/3
C

(X05-5150-11)

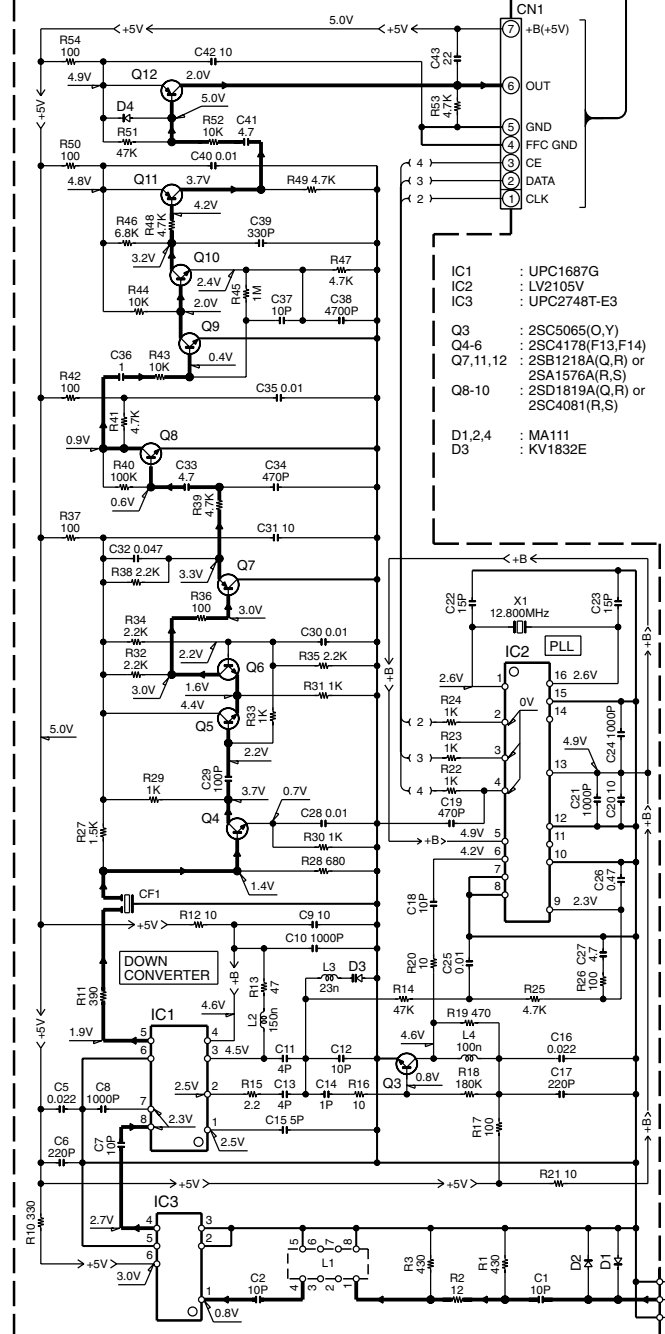

CHANNEL FREQUENCY (MHz)				VT VOLTAGE			
CHANNEL	1	2	3	CHANNEL	1	2	3
OSC FREQUENCY	417.3	414.3	411.3	VT VOLTAGE	2.40 ± 0.5	2.35 ± 0.5	2.30 ± 0.5

(X35-22XX-XX)

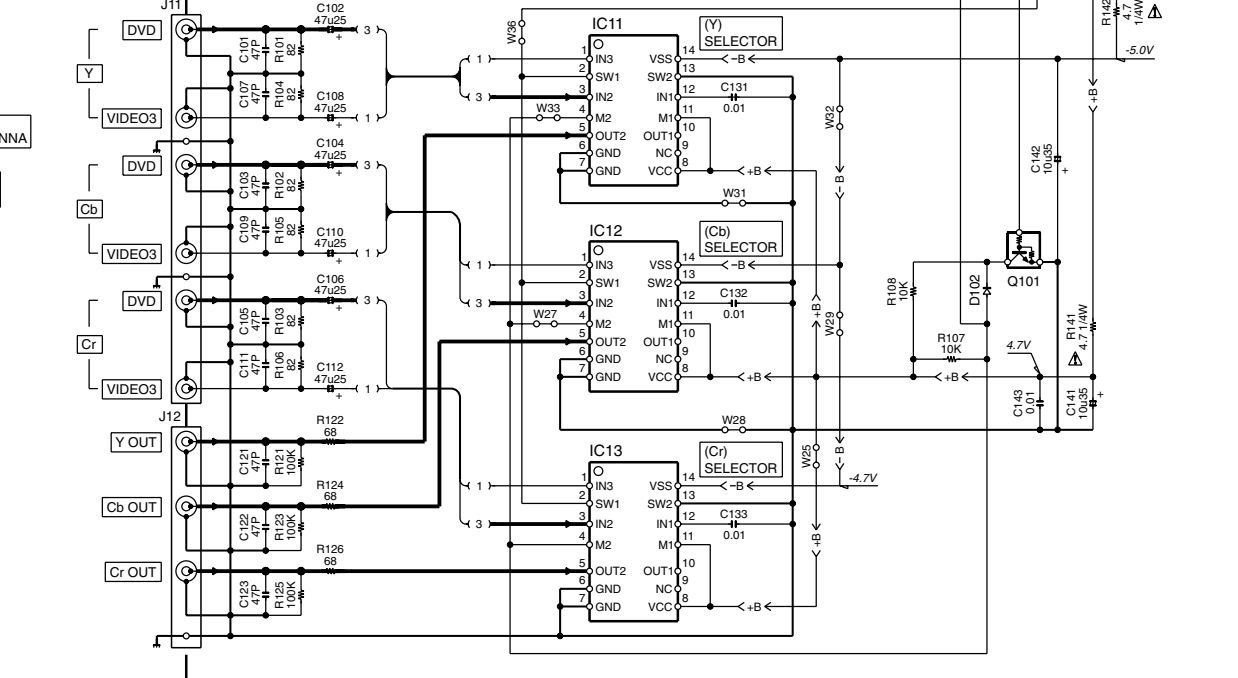
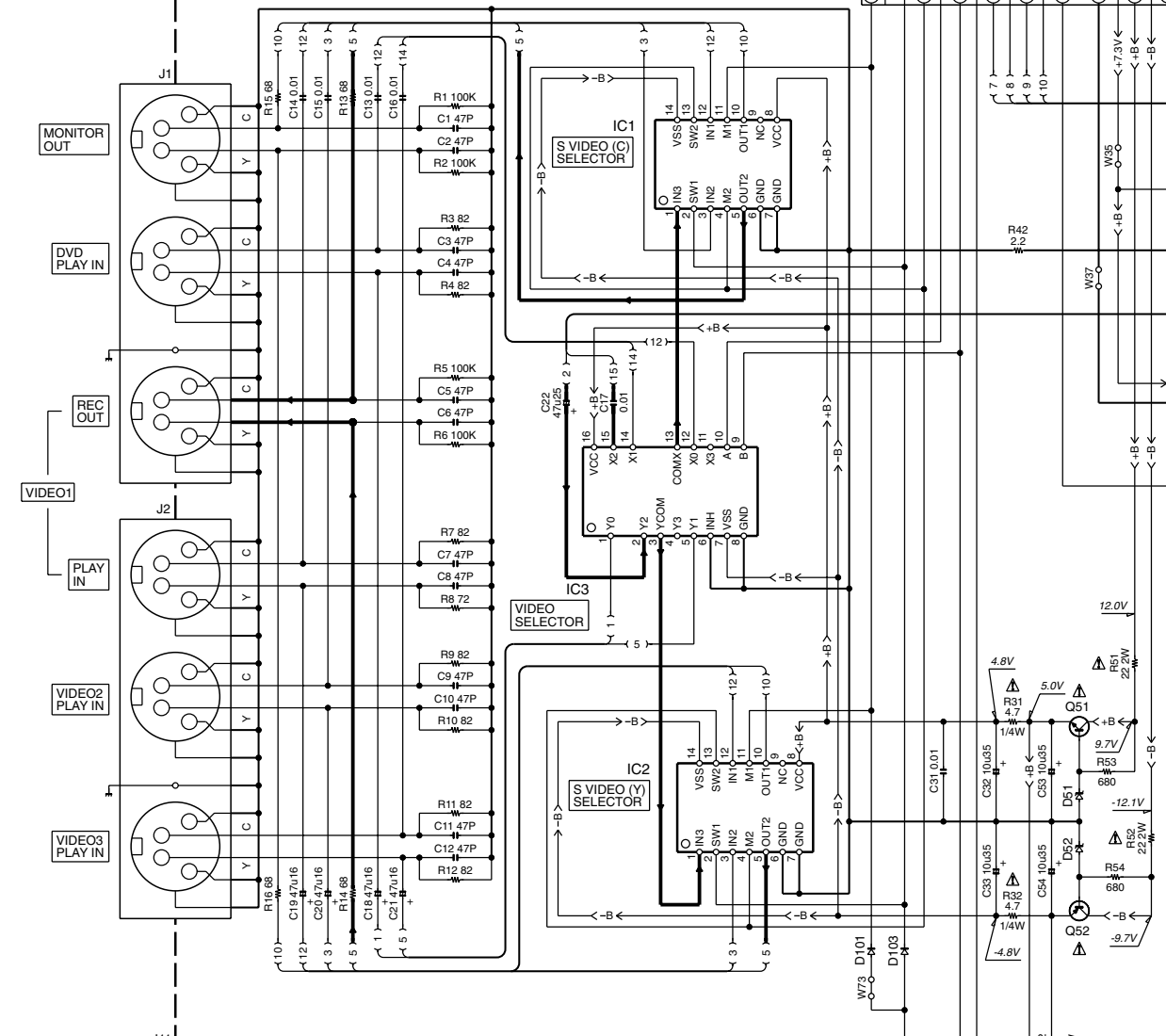

- (X35-22XX-XX)
- IC1,2,11-13 : NJM2279D
 - IC3 : TC74HC4052AP or NJU4052BD
 - IC21 : BA65T
 - IC22 : TC74HC00AP
 - Q51 : 2SD2525
 - Q52 : 2SB1640
 - Q101,202 : UN4212 or DTC124ES
 - Q201,203 : KTC3199 (Y,GR) or 2SC2785 (F,E) or 2SC1740S (Q,R)
 - Q204 : KTA1267 (Y,GR) or 2SA1175 (F,E) or 2SA933AS (Q,R)
 - D51,52 : MTZJ5.6 or MTZJ5.6 (B) or HZS5.6N (B2) or RD5.6ES (B) or RD5.6ES (B2)
 - D101-103,201,202,223,224 : 1SS133 or 1SS133 (B) or HSS104A or HSS104

--- DIGITAL LINE
--- SIGNAL LINE
--- GND LINE
←+B← +B LINE
←-B← -B LINE

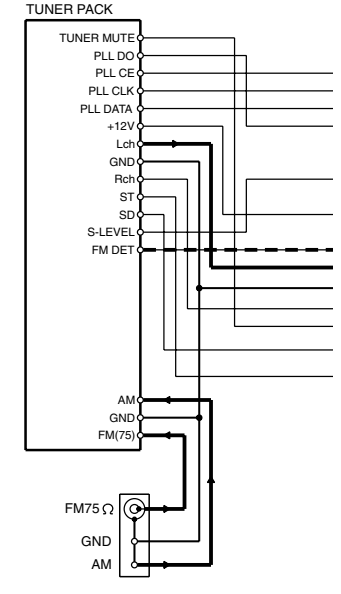

X08-CN2
2/3
E
X08-CN3
2/3
F

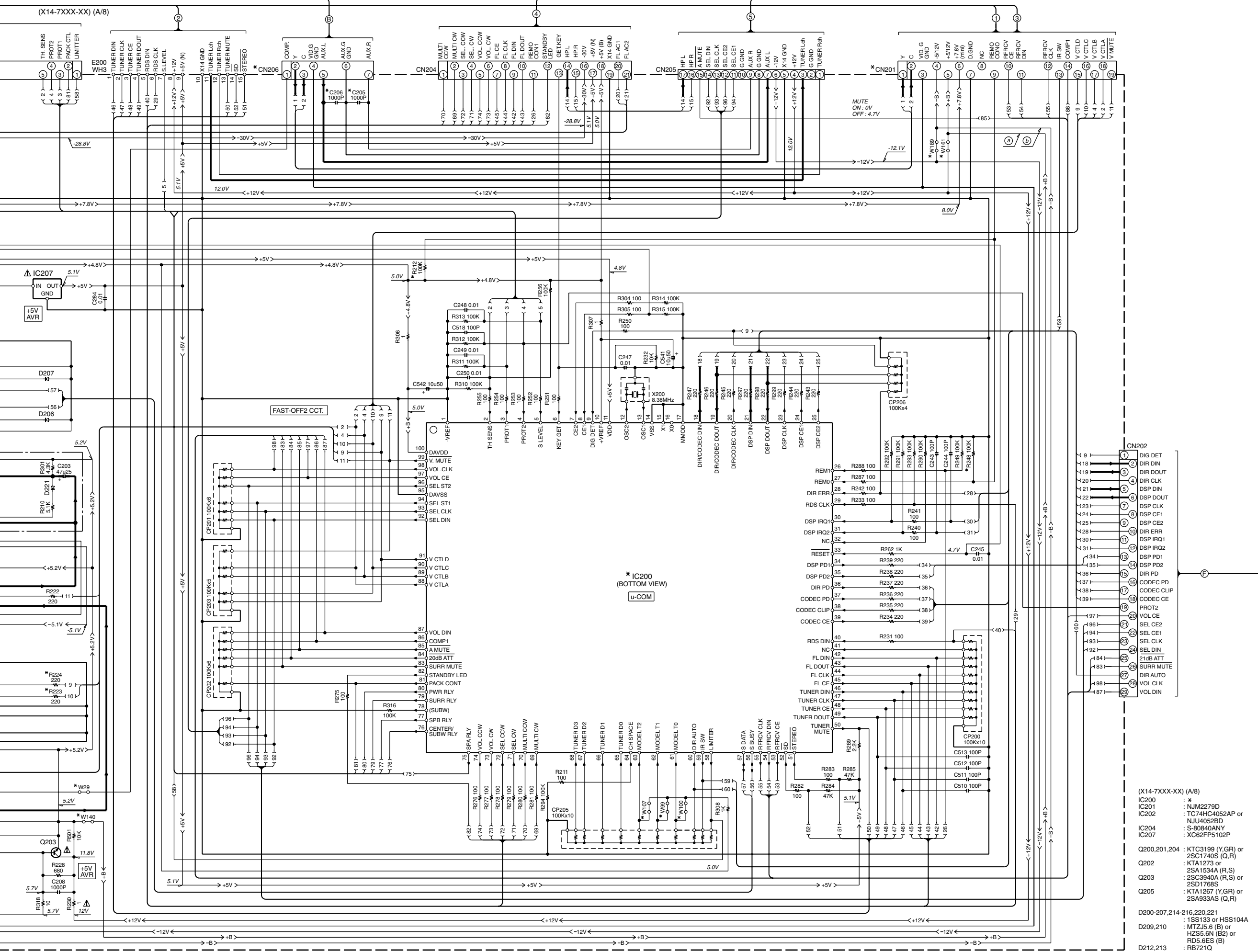

- (X14-7XXX-XX) (A/8)
- IC200 : *
 - IC201 : NJM2279D
 - IC202 : TC74HC4052AP or NJU4052BD
 - IC204 : S-80840ANY
 - IC207 : XC62FP5102P
 - Q200,201,204 : KTC3199 (Y,GR) or 2SC1740S (Q,R)
 - Q202 : KTA1273 or 2SA1534A (R,S)
 - Q203 : 2SC3940A (R,S) or 2SD1768S
 - Q205 : KTA1267 (Y,GR) or 2SA933AS (Q,R)
 - D200-207,214-216,220,221 : 1SS133 or HSS104A
 - D209,210 : MTZJ5.6 (B) or HZS5.6N (B2) or RDS.6ES (B)
 - D212,213 : RB721Q

EXPLODED VIEW (UNIT)

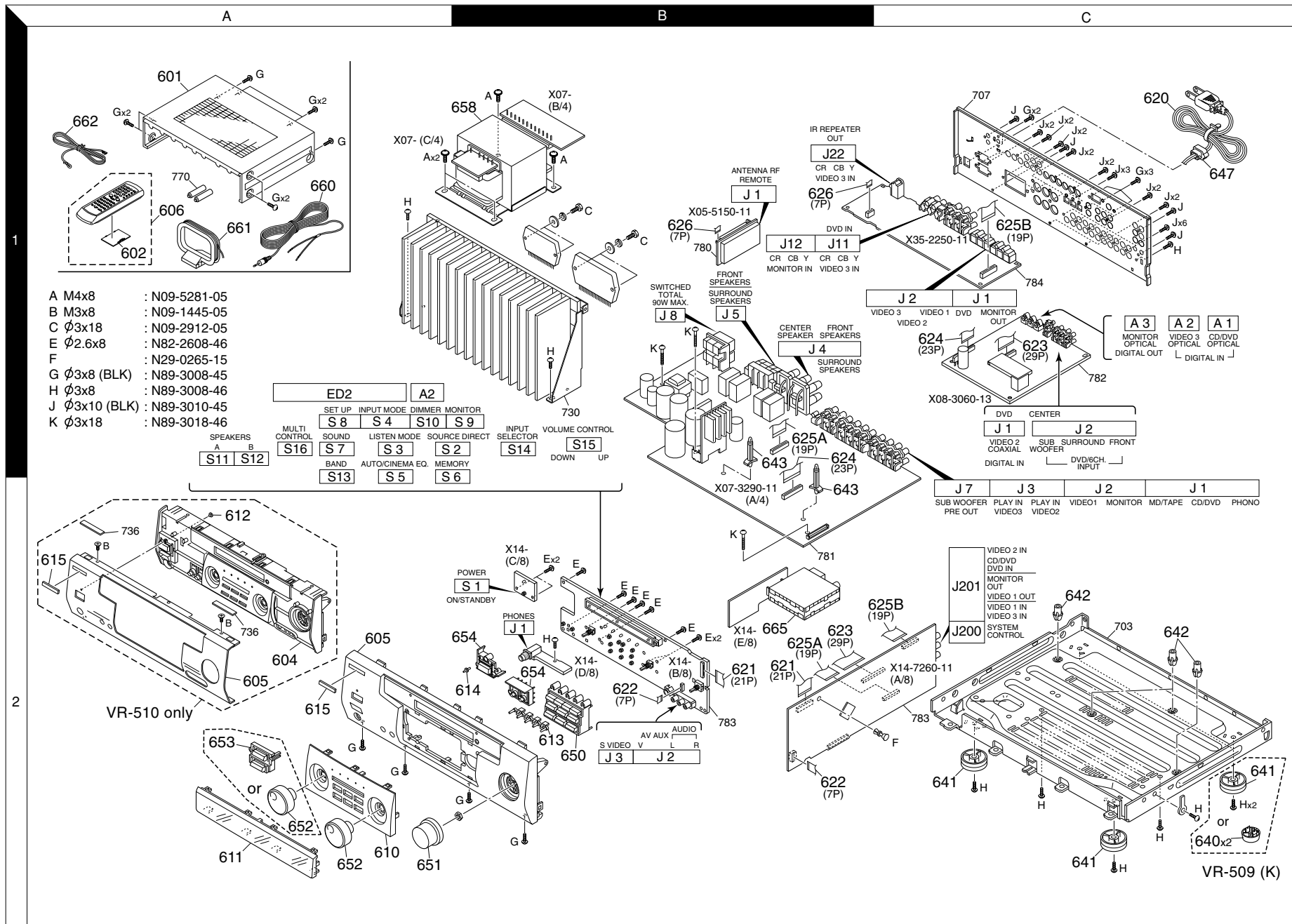

Parts with exploded numbers larger than 700 are not supplied.

* New Parts
Parts without **Parts No.** are not supplied.
Les articles non mentionnés dans le **Parts No.** ne sont pas fournis.
Teile ohne **Parts No.** werden nicht geliefert.

①

Ref. No	Add-ress	New Parts	Parts No.	Description	Desti-nation	Re-marks
VR-505/506/507/509/510/517						
601	1A	*	A01-3793-01	METALLIC CABINET	0	
601	1A	*	A01-3795-01	METALLIC CABINET	56719	
602	1A	*	A09-1166-08	BATTERY COVER	90	
602	1A	*	A09-1178-08	BATTERY COVER	561	
602	1A	*	A09-1218-08	BATTERY COVER	7	
604	2A	*	A22-1851-01	SUB PANEL	0	
605	2A	*	A60-1928-01	PANEL	9	
605	2A	*	A60-1931-01	PANEL	67	
605	2A	*	A60-1932-01	PANEL	5	
605	2A	*	A60-1935-01	PANEL	1	
605	2A	*	A60-1936-02	PANEL	0	
606	1A	*	A70-1466-15	REMOTE CONTROLLER ASSY	9	
606	1A	*	A70-1468-15	REMOTE CONTROLLER ASSY	6	
606	1A	*	A70-1484-05	REMOTE CONTROLLER ASSY	5	
606	1A	*	A70-1485-05	REMOTE CONTROLLER ASSY	9	
606	1A	*	A70-1505-05	REMOTE CONTROLLER ASSY	7	
606	1A	*	A70-1507-05	REMOTE CONTROLLER ASSY	1	
610	2A	*	B07-2550-02	ESCUTCHEON	561	
610	2A	*	B07-2554-02	ESCUTCHEON	79	
611	2A	*	B10-3644-12	FRONT GLASS	0	
611	2A	*	B10-3648-12	FRONT GLASS	9	
611	2A	*	B10-3649-12	FRONT GLASS	7	
611	2A	*	B10-3654-02	FRONT GLASS	6	
611	2A	*	B10-3657-02	FRONT GLASS	5	
611	2A	*	B10-3677-02	FRONT GLASS	1	
612	2A	*	B12-0341-04	INDICATOR	0	
613	2B	*	B12-0383-04	INDICATOR	790	
613	2B	*	B12-0384-04	INDICATOR	561	
614	2B	*	B12-0385-04	INDICATOR	56719	
615	2B	*	B43-0314-04	KENWOOD BADGE		
-	-	-	B46-0330-03	WARRANTY CARD	K	
-	-	-	B46-0347-03	WARRANTY CARD	P	
-	-	-	B46-0352-00	QUESTIONNAIRE CARD	K9K0	
-	-	-	B58-0964-13	CAUTION CARD (UL)	K	
-	-	-	B58-0967-03	CAUTION CARD (PL)	P	
-	-	-	B58-1674-03	CAUTION CARD (P1,PRA,A4,1)	K	
-	-	*	B60-4942-00	INSTRUCTION MANUAL(EN)	5671	
-	-	*	B60-4943-00	INSTRUCTION MANUAL(FR)	P5P6P7	
-	-	*	B60-4954-00	INSTRUCTION MANUAL(FR)	P9	
-	-	*	B60-4955-00	INSTRUCTION MANUAL(EN)	9	
-	-	*	B60-4956-00	INSTRUCTION MANUAL(FR)	P0	
-	-	*	B60-4957-00	INSTRUCTION MANUAL(EN)	0	
△ 620	1C	*	E30-2941-05	AC POWER CORD		
621	2B	*	E35-2774-15	FLAT CABLE 21P		
622	2B	*	E35-2775-15	FLAT CABLE 7P	67190	
623	2B,1C	*	E35-2776-05	FLAT CABLE 29P		
624	1B,1C	*	E35-2777-05	FLAT CABLE 23P		
625	1B,2B	*	E35-2841-05	FLAT CABLE 19P		
626	1B	*	E35-2873-05	FLAT CABLE 7P	90	
-	-	*	H10-7763-02	POLYSTYRENE FOAMED FIXTURE		
-	-	*	H10-7764-02	POLYSTYRENE FOAMED FIXTURE		
-	-	*	H12-3503-04	PACKING FIXTURE		

L : Scandinavia K : USA P : Canada R : Mexico C : China I : Malaysia
Y : PX(Far East,Hawaii) T : England E : Europe G : Germany V : China(Shanghai)
Y : AAFES(Europe) X : Australia Q : Russia H : Korea M : Other Areas △ indicates safety critical components .

* New Parts
Parts without **Parts No.** are not supplied.
Les articles non mentionnés dans le **Parts No.** ne sont pas fournis.
Teile ohne **Parts No.** werden nicht geliefert.

②

Ref. No	Add-ress	New Parts	Parts No.	Description	Desti-nation	Re-marks
-	-	-	H25-0232-04	PROTECTION BAG (235X350X0.03)		
-	-	-	H25-0391-04	PROTECTION BAG		
-	-	*	H50-4099-04	ITEM CARTON CASE	0	
-	-	*	H50-4100-04	ITEM CARTON CASE	9	
-	-	*	H50-4101-04	ITEM CARTON CASE	7	
-	-	*	H50-4102-04	ITEM CARTON CASE	6	
-	-	*	H50-4103-04	ITEM CARTON CASE	5	
-	-	*	H50-4104-04	ITEM CARTON CASE	1	
640	2C	-	J02-1013-05	FOOT REAR	56	
641	2C	-	J02-1464-03	FOOT		
642	2C	-	J19-3751-04	UNIT HOLDER		
643	1B,2B	-	J19-6078-05	UNIT HOLDER		
△ 647	1C	-	J42-0083-05	POWER CORD BUSHING		
-	-	-	J61-0307-05	WIRE BAND		
650	2B	-	K29-7675-22	KNOB		
651	2A	-	K29-7678-04	KNOB		
652	2A	-	K29-7681-14	KNOB		
653	2A	-	K29-7684-03	KNOB	561	
654	2B	-	K29-7687-03	KNOB	56719	
△ 658	1B	*	L07-2916-05	POWER TRANSFORMER	0	
△ 658	1B	*	L07-2922-05	POWER TRANSFORMER	56719	
660	1A	-	T90-0850-05	ANTENNA ASSY	90	
661	1A	-	T90-0852-05	LOOP ANTENNA		
662	1A	*	T90-0877-05	LEAD WIRE ANTENNA		
665	2B	*	W02-2771-05	TUNER ASSY	56719	
665	2B	*	W02-2775-05	TUNER ASSY		
RF-RC (X05-5150-11)						
C1 ,2	-	-	CC73GCH1H100D	CHIP C	10PF	D
C5	-	-	CK73GB1E223K	CHIP C	0.022UF	K
C6	-	-	CC73GCH1H221J	CHIP C	220PF	J
C7	-	-	CC73GCH1H100D	CHIP C	10PF	D
C8	-	-	CK73GB1H102K	CHIP C	1000PF	K
C9	-	-	C93-0037-05	CERAMIC	10UF	10WV
C10	-	-	CK73GB1H102K	CHIP C	1000PF	K
C11	-	-	CC73GCH1H040C	CHIP C	4.0PF	C
C12	-	-	CC73GCH1H100D	CHIP C	10PF	D
C13	-	-	CC73GCH1H040C	CHIP C	4.0PF	C
C14	-	-	CC73GCH1H010C	CHIP C	1.0PF	C
C15	-	-	CC73GCH1H050C	CHIP C	5.0PF	C
C16	-	-	CK73GB1E223K	CHIP C	0.022UF	K
C17	-	-	CC73GCH1H221J	CHIP C	220PF	J
C18	-	-	CC73GCH1H100D	CHIP C	10PF	D
C19	-	-	CC73GCH1H471J	CHIP C	470PF	J
C20	-	-	C93-0037-05	CERAMIC	10UF	10WV
C21	-	-	CK73GB1H102K	CHIP C	1000PF	K
C22 ,23	-	-	CC73GCH1H150J	CHIP C	15PF	J
C24	-	-	CK73GB1H102K	CHIP C	1000PF	K
C25	-	-	CK73GB1E103K	CHIP C	0.010UF	K
C26	-	-	CK73GF1A474Z	CHIP C	0.47UF	Z
C27	-	-	C93-0036-05	CHIP C	4.7UF	Z
C28	-	-	CK73GB1E103K	CHIP C	0.010UF	K
C29	-	-	CC73GCH1H101J	CHIP C	100PF	J

L : Scandinavia K : USA P : Canada R : Mexico C : China I : Malaysia
Y : PX(Far East,Hawaii) T : England E : Europe G : Germany V : China(Shanghai)
Y : AAFES(Europe) X : Australia Q : Russia H : Korea M : Other Areas △ indicates safety critical components .

* New Parts

Parts without **Parts No.** are not supplied.
Les articles non mentionnés dans le **Parts No.** ne sont pas fournis.
Teile ohne **Parts No.** werden nicht geliefert.

3

Ref. No	Add-ress	New Parts	Parts No.	Description	Desti-nation	Re-marks
C30			CK73GB1E103K	CHIP C 0.010UF	K	
C31			C93-0037-05	CERAMIC 10UF	10WV	
C32			CK73GB1C473K	CHIP C 0.047UF	K	
C33			C93-0036-05	CHIP-C 4.7UF	Z	
C34			CC73GCH1H471J	CHIP C 470PF	J	
C35			CK73GB1E103K	CHIP C 0.010UF	K	
C36			CK73GF1C224Z	CHIP C 0.22UF	Z	
C37			CC73GCH1H100D	CHIP C 10PF	D	
C38			CK73GB1H472K	CHIP C 4700PF	K	
C39			CC73GCH1H331J	CHIP C 330PF	J	
C40			CK73GB1E103K	CHIP C 0.010UF	K	
C41			C93-0036-05	CHIP-C 4.7UF	Z	
C42			C93-0037-05	CERAMIC 10UF	10WV	
C43			C93-0039-05	CERAMIC 22UF	10WV	
CN1			E40-8530-05	FLAT CABLE CONNECTOR		
J1			E11-0904-05	MINIATURE PHONE JACK(STEREO MI		
CF1		*	L72-0626-05	CERAMIC FILTER		
L1			L79-1269-05	LC FILTER		
L2			L40-1585-67	SMALL FIXED INDUCTOR(150N,J,20		
L3			L32-1021-05	FM OSCILLATING COIL		
L4			L40-1085-67	SMALL FIXED INDUCTOR(100N,J,20		
X1			L77-2274-05	CRYSTAL RESONATOR		
R1			RK73GB1J431J	CHIP R 430	J 1/16W	
R2			RK73GB1J120J	CHIP R 12	J 1/16W	
R3			RK73GB1J431J	CHIP R 430	J 1/16W	
R10			RK73GB1J331J	CHIP R 330	J 1/16W	
R11			RK73GB1J391J	CHIP R 390	J 1/16W	
R12			RK73GB1J100J	CHIP R 10	J 1/16W	
R13			RK73GB1J470J	CHIP R 47	J 1/16W	
R14			RK73GB1J473J	CHIP R 47K	J 1/16W	
R15			RK73GB1J2R2J	CHIP R 2.2	J 1/16W	
R16			RK73GB1J100J	CHIP R 10	J 1/16W	
R17			RK73GB1J101J	CHIP R 100	J 1/16W	
R18			RK73GB1J184J	CHIP R 180K	J 1/16W	
R19			RK73GB1J471J	CHIP R 470	J 1/16W	
R20 ,21			RK73GB1J100J	CHIP R 10	J 1/16W	
R22 -24			RK73GB1J102J	CHIP R 1.0K	J 1/16W	
R25			RK73GB1J472J	CHIP R 4.7K	J 1/16W	
R26			RK73GB1J101J	CHIP R 100	J 1/16W	
R27			RK73GB1J152J	CHIP R 1.5K	J 1/16W	
R28			RK73GB1J681J	CHIP R 680	J 1/16W	
R29 -31			RK73GB1J102J	CHIP R 1.0K	J 1/16W	
R32			RK73GB1J152J	CHIP R 1.5K	J 1/16W	
R33			RK73GB1J102J	CHIP R 1.0K	J 1/16W	
R34 ,35			RK73GB1J222J	CHIP R 2.2K	J 1/16W	
R36 ,37			RK73GB1J101J	CHIP R 100	J 1/16W	
R38			RK73GB1J222J	CHIP R 2.2K	J 1/16W	
R39			RK73GB1J472J	CHIP R 4.7K	J 1/16W	
R40			RK73GB1J104J	CHIP R 100K	J 1/16W	
R41			RK73GB1J472J	CHIP R 4.7K	J 1/16W	
R42			RK73GB1J101J	CHIP R 100	J 1/16W	
R43 ,44			RK73GB1J103J	CHIP R 10K	J 1/16W	
R45			RK73GB1J105J	CHIP R 1.0M	J 1/16W	

L : Scandinavia K : USA P : Canada R : Mexico C : China I : Malaysia
Y : PX(Far East,Hawaii) T : England E : Europe G : Germany V : China(Shanghai)
Y : AAFES(Europe) X : Australia Q : Russia H : Korea M : Other Areas Δ indicates safety critical components.

* New Parts

Parts without **Parts No.** are not supplied.
Les articles non mentionnés dans le **Parts No.** ne sont pas fournis.
Teile ohne **Parts No.** werden nicht geliefert.

4

Ref. No	Add-ress	New Parts	Parts No.	Description	Desti-nation	Re-marks
R46			RK73GB1J562J	CHIP R 5.6K	J 1/16W	
R47 -49			RK73GB1J472J	CHIP R 4.7K	J 1/16W	
R50			RK73GB1J101J	CHIP R 100	J 1/16W	
R51			RK73GB1J473J	CHIP R 47K	J 1/16W	
R52			RK73GB1J103J	CHIP R 10K	J 1/16W	
R53			RK73GB1J472J	CHIP R 4.7K	J 1/16W	
R54			RK73GB1J101J	CHIP R 100	J 1/16W	
D1 ,2			MA111	DIODE		
D3			KV1832E	VARIABLE CAPACITANCE DIODE		
D4			MA111	DIODE		
IC1			UPC1687G	ANALOGUE IC		
IC2			LV2105V	MOS-IC		
IC3			UPC2748T-E3	ANALOGUE IC		
Q3			2SC5065(O,Y)	TRANSISTOR		
Q4 -6			2SC4178(F13,14)	TRANSISTOR		
Q7			2SA1576A(R,S)	TRANSISTOR		
Q7			2SB1218A(Q,R)	TRANSISTOR		
Q8 -10			2SC4081(R,S)	TRANSISTOR		
Q8 -10			2SD1819A(Q,R)	TRANSISTOR		
Q11 ,12			2SA1576A(R,S)	TRANSISTOR		
Q11 ,12			2SB1218A(Q,R)	TRANSISTOR		
POWER (X07-3290-11,X07-3300-10,X07-3310-10)						
C1 ,2			CC45FSL1H221J	CERAMIC 220PF	J	
C3 ,4			CE04KW1H100M	ELECTRO 10UF	50WV	6790
C5 ,6			CC45FSL1H221J	CERAMIC 220PF	J	6790
C7 ,8			CE04KW1A101M	ELECTRO 100UF	10WV	6790
C9 ,10			CC45FSL1H271J	CERAMIC 270PF	J	6790
C11 ,12			CQ93FMG1H123J	MYLAR 0.012UF	J	6790
C13 ,14			CK45FB1H332K	CERAMIC 3300PF	K	6790
C15 ,16			CC45FSL1H101J	CERAMIC 100PF	J	6790
C17 ,18			CE04KW1H4R7M	ELECTRO 4.7UF	50WV	6790
C19 -32			CC45FSL1H221J	CERAMIC 220PF	J	
C33 ,34			CC45FSL1H221J	CERAMIC 220PF	J	5790
C35 ,36			CC45FSL1H221J	CERAMIC 220PF	J	790
C37 ,38			CE04PW1H2R2M	ELECTRO 2.2UF	50WV	
C39 ,40			CC45FSL1H101J	CERAMIC 100PF	J	
C41 ,42			CE04KW1H2R2M	ELECTRO 2.2UF	50WV	
C43 ,44			CC45FSL1H101J	CERAMIC 100PF	J	
C45 ,46		*	CE04PW1C220M	ELECTRO 22UF	16WV	
C47 ,48			CE04KW1H2R2M	ELECTRO 2.2UF	50WV	
C49 ,50			CK45FB1H471K	CERAMIC 470PF	K	
C51 ,52			CE04KW1A101M	ELECTRO 100UF	10WV	
C53 ,54			CK45FB1H471K	CERAMIC 470PF	K	
C55 ,56			CC45FCH1H180J	CERAMIC 18PF	J	
C57 -60			C91-1573-05	MP-C 0.10UF	J	
C61 ,62			CK45FB1H222K	CERAMIC 2200PF	K	
C101,102			CE04KW1H100M	ELECTRO 10UF	50WV	
C103,104			CE04KW1H2R2M	ELECTRO 2.2UF	50WV	
C105,106			CK45FB1H471K	CERAMIC 470PF	K	
C107,108			CE04KW1A101M	ELECTRO 100UF	10WV	
C109,110			CK45FB1H471K	CERAMIC 470PF	K	
C111,112			CC45FCH1H180J	CERAMIC 18PF	J	
C113-116			C91-1573-05	MP-C 0.10UF	J	
C117,118			CK45FB1H222K	CERAMIC 2200PF	K	16790

L : Scandinavia K : USA P : Canada R : Mexico C : China I : Malaysia
Y : PX(Far East,Hawaii) T : England E : Europe G : Germany V : China(Shanghai)
Y : AAFES(Europe) X : Australia Q : Russia H : Korea M : Other Areas Δ indicates safety critical components.

PARTS LIST

VR-505/506/507/509/510/517

* New Parts

Parts without **Parts No.** are not supplied.Les articles non mentionnés dans le **Parts No.** ne sont pas fournis.Teile ohne **Parts No.** werden nicht geliefert.

⑤

Ref. No	Add-ress	New Parts	Parts No.	Description	Desti-nation	Re-marks
C119,120			CK45FB1H222K	CERAMIC 2200PF	K	56790
C131			CE04KW1H2R2M	ELECTRO 2.2UF	50WV	
C132			CE04KW1H2R2M	ELECTRO 2.2UF	50WV	1
C133			CK45FB1H471K	CERAMIC 470PF	K	
C134			CK45FB1H471K	CERAMIC 470PF	K	1
C135			CE04KW1A101M	ELECTRO 100UF	10WV	
C136			CE04KW1A101M	ELECTRO 100UF	10WV	1
C137			CK45FB1H471K	CERAMIC 470PF	K	
C139			CC45FCH1H180J	CERAMIC 18PF	J	
C140			CC45FCH1H180J	CERAMIC 18PF	J	1
C141			C91-1573-05	MP-C 0.10UF	J	
C142			C91-1573-05	MP-C 0.10UF	J	1
C143			C91-1573-05	MP-C 0.10UF	J	
C144			C91-1573-05	MP-C 0.10UF	J	1
C145			CK45FB1H222K	CERAMIC 2200PF	K	
C146			CK45FB1H222K	CERAMIC 2200PF	K	1
C147		*	CC45FSH1H221J	CERAMIC 220PF	J	5679
C151-155			CC45FSL1H101J	CERAMIC 100PF	J	
C201,202		*	C90-3945-05	ELECTRO 10000UF	80WV	0
C201,202		*	C90-3982-05	ELECTRO 4700UF	75WV	15679
C203,204		*	C90-3946-05	ELECTRO 3300UF	50WV	0
C203,204		*	C90-3983-05	ELECTRO 3300UF	50WV	15679
C205			CE04KW1E222M	ELECTRO 2200UF	25WV	
C206			CE04LW1E471M	ELECTRO 470UF	25WV	
C207,208			CE04KW1E101M	ELECTRO 100UF	25WV	
C209			CE04PW1H100M	ELECTRO 10UF	50WV	
C210		*	CE04PW1J330M	ELECTRO 33UF	63WV	
C211			CC45FSL1H101J	CERAMIC 100PF	J	6790
C212			CK45FF1H103Z	CERAMIC 0.010UF	Z	6790
C213			CC45FSL1H221J	CERAMIC 220PF	J	
C214			CK45FB1H102K	CERAMIC 1000PF	K	
C215			CK45FF1H103Z	CERAMIC 0.010UF	Z	
C216			CC45FSL1H221J	CERAMIC 220PF	J	
C217,218			CE04KW1H101M	ELECTRO 100UF	50WV	
C219,220			CE04KW2A101M	ELECTRO 100UF	100WV	
C221			CE04PW1A101M	ELECTRO 100UF	10WV	
C222			CE04HW1A221M	NP-ELEC 220UF	10WV	
C223,224			CE04KW2A100M	ELECTRO 10UF	100WV	
C225			CE04PW1H4R7M	ELECTRO 4.7UF	50WV	
C226			CE04PW1H010M	ELECTRO 1UF	50WV	
C227		*	CE04PW1A221M	ELECTRO 220UF	10WV	
C228			CE04PW1H2R2M	ELECTRO 2.2UF	50WV	
C229			CE04KW1E332M	ELECTRO 3300UF	25WV	
C230			CE04KW1H100M	ELECTRO 10UF	50WV	
C232			C91-1573-05	MP-C 0.10UF	J	
C233			CK45FF1H103Z	CERAMIC 0.010UF	Z	
C234			CE04KW1H100M	ELECTRO 10UF	50WV	
C303-307			CK45FF1H472Z	CERAMIC 4700PF	Z	
C308			CK45FF1H472Z	CERAMIC 4700PF	Z	1
C309			CE04HW1E100M	NP-ELEC 10UF	25WV	
C310			CE04LW1E470M	ELECTRO 47UF	25WV	
C311,312			CK45FF1H103Z	CERAMIC 0.010UF	Z	
C313,314			CK45FF1H223Z	CERAMIC 0.022UF	Z	
C315			CK45FB1H471K	CERAMIC 470PF	K	
C316,317		*	C91-1635-05	FILM 0.068UF	275WV	

L: Scandinavia

K: USA

P: Canada

R: Mexico

C: China

I: Malaysia

Y: PX(Far East,Hawaii)

T: England

E: Europe

G: Germany

V: China(Shanghai)

Y: AAFES(Europe)

X: Australia

Q: Russia

H: Korea

M: Other Areas

⚠ indicates safety critical components.

* New Parts

Parts without **Parts No.** are not supplied.Les articles non mentionnés dans le **Parts No.** ne sont pas fournis.Teile ohne **Parts No.** werden nicht geliefert.

⑥

Ref. No	Add-ress	New Parts	Parts No.	Description	Desti-nation	Re-marks
C401,402			CK45FB1H102K	CERAMIC 1000PF	K	
C403,404			CC45FSL1H101J	CERAMIC 100PF	J	
C405			CK45FB1H102K	CERAMIC 1000PF	K	
CN2			E40-4245-05	PIN ASSY		
CN4			E40-4245-05	PIN ASSY		
CN5			E40-8485-05	FLAT CABLE CONNECTOR		
CN6			E40-9850-05	PIN ASSY		
CN7			E40-8483-05	FLAT CABLE CONNECTOR		
J1			E63-1143-05	PIN JACK		
J3			E63-1144-05	PIN JACK		790
J4			E70-0049-05	SCREW TERMINAL BOARD		6790
J4			E70-0122-05	LOCK TERMINAL BOARD		15
J5			E70-0128-05	LOCK TERMINAL BOARD		6790
J6			E70-0122-05	LOCK TERMINAL BOARD		1
J7			E63-1146-05	PIN JACK		5679
J8			E03-0148-05	AC OUTLET		16790
J8			E03-0316-05	AC OUTLET		5
J9			E70-0057-05	LOCK TERMINAL BOARD		5
J10		*	E63-1138-05	PIN JACK		5
F1			F50-0077-05	FUSE(5X20)		
CN8,9			J13-0075-05	FUSE CLIP		
E5			J11-0808-05	WIRE CLAMPER		
L1			L39-1373-05	PHASE COMPENSATION COIL		
L6			L39-1373-05	PHASE COMPENSATION COIL		1
T1			L07-2758-05	POWER TRANSFORMER		6
T1			L07-2761-05	POWER TRANSFORMER		15
T1			L07-2809-05	POWER TRANSFORMER		790
R73			RS14KB3DR22J	FL-PROOF RS	0.22	J 2W
R83,84			RD14NB2E4R7J	RD	4.7	J 1/4W
R85,86			RS14KB3D4R7J	FL-PROOF RS	4.7	J 2W
R87,88			RS14KB3D391J	FL-PROOF RS	390	J 2W
R109-112			RS14KB3DR22J	FL-PROOF RS	0.22	J 2W
R119,120			RD14NB2E4R7J	RD	4.7	J 1/4W
R121,122			RS14KB3D4R7J	FL-PROOF RS	4.7	J 2W
R139			RS14KB3DR22J	FL-PROOF RS	0.22	J 2W
R140			RS14KB3DR22J	FL-PROOF RS	0.22	J 2W
R141			RS14KB3DR22J	FL-PROOF RS	0.22	J 2W
R142			RS14KB3DR22J	FL-PROOF RS	0.22	J 2W
R149			RD14NB2E4R7J	RD	4.7	J 1/4W
R150			RD14NB2E4R7J	RD	4.7	J 1/4W
R151			RS14KB3D4R7J	FL-PROOF RS	4.7	J 2W
R152			RS14KB3D4R7J	FL-PROOF RS	4.7	J 2W
R207			RD14NB2E101J	RD	100	J 1/4W
R208			RD14NB2E822J	RD	8.2K	J 1/4W
R223-226			RS14KB3A472J	FL-PROOF RS	4.7K	J 1W
R238,239			RD14NB2E103J	RD	10K	J 1/4W
R242,243			RD14NB2E101J	RD	100	J 1/4W
R254			RS14KB3D181J	FL-PROOF RS	180	J 2W
R260			R92-1844-05	CARBON	3.3M	J 1/2W
R262			RD14NB2E1R0J	RD	1	J 1/4W
R263			RD14NB2E270J	RD	27	J 1/4W
R301,302			RD14NB2E1R0J	RD	1	J 1/4W

L: Scandinavia

K: USA

P: Canada

R: Mexico

C: China

I: Malaysia

Y: PX(Far East,Hawaii)

T: England

E: Europe

G: Germany

V: China(Shanghai)

Y: AAFES(Europe)

X: Australia

Q: Russia

H: Korea

M: Other Areas

⚠ indicates safety critical components.

* New Parts

Parts without **Parts No.** are not supplied.

Les articles non mentionnés dans le **Parts No.** ne sont pas fournis.

Teile ohne **Parts No.** werden nicht geliefert.



Ref. No	Address	New Parts	Parts No.	Description	Destination	Remarks
R321-323 R335 R998,999			RS14KB3A151J RD14NB2E821J RD14NB2E1R0J	FL-PROOF RS 150 J 1W RD 820 J 1/4W RD 1 J J 1/4W		
K1 ,2 K1 ,2 K1 ,2 K3 K3			S76-0042-05 S76-0097-05 * S76-0112-05 S76-0042-05 S76-0097-05	MAGNETIC RELAY MAGNETIC RELAY MAGNETIC RELAY MAGNETIC RELAY MAGNETIC RELAY	170 569 70 56790	
K3 K4 K4 K4 K5			* S76-0112-05 S76-0042-05 S76-0097-05 * S76-0112-05 S76-0099-05	MAGNETIC RELAY MAGNETIC RELAY MAGNETIC RELAY MAGNETIC RELAY MAGNETIC RELAY	569 170 16790 69	
Δ D1 ,2 Δ D1 ,2 Δ D3 D4 D4			* D5SBA20F03 TS6P03G-B D2SBA20F03 MTZJ16(B) RD16ES(B)	DIODE DIODE DIODE ZENER DIODE ZENER DIODE		
D5 -9 D5 -9 D10 -14 D10 -14 D15			MTZJ15(B) RD15ES(B) HSS104A 1SS133 HSS104A	ZENER DIODE ZENER DIODE DIODE DIODE DIODE	1	
D15 D16 ,17 D16 ,17 D18 D18			1SS133 HSS104A 1SS133 MTZJ6.8(B) MTZJ8.2(B)	DIODE DIODE DIODE ZENER DIODE ZENER DIODE	1 56790	
D18 D18 D19 D19 D19			RD6.8ES(B) RD8.2ES(B) MTZJ15(B) MTZJ16(B) RD15ES(B)	ZENER DIODE ZENER DIODE ZENER DIODE ZENER DIODE ZENER DIODE	1 56790 10 5679 10	
D19 D20 D20 D20 D20			RD16ES(B) MTZJ13(B) MTZJ18(B) MTZJ20(B) RD13ES(B)	ZENER DIODE ZENER DIODE ZENER DIODE ZENER DIODE ZENER DIODE	5679 1 5679 0 1	
D20 D20 D21 D21 D22 ,23			RD18ES(B) RD20ES(B) HSS104A 1SS133 MTZJ3.9(B)	ZENER DIODE ZENER DIODE DIODE DIODE ZENER DIODE	5679 0	
D22 ,23 D24 -26 D24 -26 D27 D27			RD3.9ES(B) HSS104A 1SS133 HSS104A 1SS133	ZENER DIODE DIODE DIODE DIODE DIODE	5679 56790	
D28 D28 D31 D31 D32 -34			HSS104A 1SS133 MTZJ3.9(B) RD3.9ES(B) HSS104A	DIODE DIODE ZENER DIODE ZENER DIODE DIODE	16790 16790	
Δ D32 -34			1SS133	DIODE		

L: Scandinavia K: USA P: Canada R: Mexico C: China I: Malaysia
Y: FX(Far East,Hawaii) T: England E: Europe G: Germany V: China(Shanghai)
Y: AAFES(Europe) X: Australia Q: Russia H: Korea M: Other Areas Δ indicates safety critical components.

* New Parts

Parts without **Parts No.** are not supplied.

Les articles non mentionnés dans le **Parts No.** ne sont pas fournis.

Teile ohne **Parts No.** werden nicht geliefert.



Ref. No	Address	New Parts	Parts No.	Description	Destination	Remarks
Δ D35 D36 D37 D37 Δ IC1			S1ZB20(4101) RB721Q HSS104A 1SS133 * STK412-020N	DIODE DIODE DIODE DIODE HYBRID IC		5679
Δ IC1 Δ IC1 Δ IC2 Δ IC2 Δ IC3 ,4			* STK412-040N * STK412-040T * STK413-020T * STK413-040T * STK413-020A	HYBRID IC HYBRID IC HYBRID IC HYBRID IC HYBRID IC		0 0 5679 0 1
Δ IC5 Δ IC6 IC7 IC8 IC9 ,10			KIA7812API KIA7912PI NJM4580L-D NJU7313AL NJM4565D	ANALOGUE IC ANALOGUE IC ANALOGUE IC ANALOGUE IC ANALOGUE IC		6790
IC11 Δ IC12 Q1 -5 Q6 Q201			NJU7313AL BA05T 2SC2878(B) 2SC2878(B) 2SB1640	ANALOGUE IC ANALOGUE IC TRANSISTOR TRANSISTOR TRANSISTOR		15679
Q202 Q203 Q205 Q206 Q207			2SC1845(F,E) 2SA1535A 2SC1845(F,E) 2SA992(F,E) 2SC3944A	TRANSISTOR TRANSISTOR TRANSISTOR TRANSISTOR TRANSISTOR		
Q208 Q209,210 Q211-214 Q215 Q215			2SB1640 2SA992(F,E) 2SC1845(F,E) 2SC1740S(Q,R) 2SC2785(F,E)	TRANSISTOR TRANSISTOR TRANSISTOR TRANSISTOR TRANSISTOR		
Q301-305 Q306 Q307,308 Q309 Q310			2SC1845(F,E) 2SC1845(F,E) UN4219 UN4219 UN4219	TRANSISTOR TRANSISTOR DIGITAL TRANSISTOR DIGITAL TRANSISTOR DIGITAL TRANSISTOR		1 56790 16790
Q311			2SA992(F,E)	TRANSISTOR		
SURROUND (X08-3060-10, X08-3070-10)						
C1 ,2 C3 C4 C5 ,6 C7 ,8			CE04LW1H100M CK73GB1H103K CC73GCH1H101J CK73GB1H222K CK73FB1E104K	ELECTRO CHIP C CHIP C CHIP C CHIP C	10UF 0.010UF 100PF 2200PF 0.10UF	50WV K J K K
C9 ,10 C11 -14 C21 C22 C23			CE04LW1H4R7M CC73GCH1H101J CK73FB1E104K CE04LW1H100M CK73GB1H102K	ELECTRO CHIP C CHIP C ELECTRO CHIP C	4.7UF 100PF 0.10UF 10UF 1000PF	50WV J K 50WV K
C24 ,25 C26 C27 C29 C31			CK73FB1E104K CE04LW1H100M CE04LW1H4R7M CK73GB1H103K CC73GCH1H220J	CHIP C ELECTRO ELECTRO CHIP C CHIP C	0.10UF 10UF 4.7UF 0.010UF 22PF	K 50WV 50WV K J
C32 C33			CK73GB1H472K CC73GCH1H220J	CHIP C CHIP C	4700PF 22PF	K J

L: Scandinavia K: USA P: Canada R: Mexico C: China I: Malaysia
Y: FX(Far East,Hawaii) T: England E: Europe G: Germany V: China(Shanghai)
Y: AAFES(Europe) X: Australia Q: Russia H: Korea M: Other Areas Δ indicates safety critical components.

PARTS LIST

VR-505/506/507/509/510/517

* New Parts
Parts without **Parts No.** are not supplied.
Les articles non mentionnés dans le **Parts No.** ne sont pas fournis.
Teile ohne **Parts No.** werden nicht geliefert.

9

Ref. No	Add-ress	New Parts	Parts No.	Description	Desti-nation	Re-marks
C34			CK73GB1H472K	CHIP C	4700PF	K
C35			CK73FF1C105Z	CHIP C	1.0UF	Z
C36			CK73FF1C105Z	CHIP C	1.0UF	Z
C37			CK73FF1C105Z	CHIP C	1.0UF	Z
C41			CC73GCH1H220J	CHIP C	22PF	J
C42			CC73GCH1H270J	CHIP C	27PF	J
C43, 44			CK73GB1H102K	CHIP C	1000PF	K
C45			CK73GB1H103K	CHIP C	0.010UF	K
C46			CC73GCH1H220J	CHIP C	22PF	J
C54, 55			CC73GCH1H220J	CHIP C	22PF	J
C56			CK73GB1H102K	CHIP C	1000PF	K
C57			CK73FB1E104K	CHIP C	0.10UF	K
C58, 59			CK73GB1H103K	CHIP C	0.010UF	K
C103,104			CE04PW1H100M	ELECTRO	10UF	50WV
C105,106			CK73GB1H182K	CHIP C	1800PF	K
C107,108			CK73GB1H222K	CHIP C	2200PF	K
C109			CK73GB1H472K	CHIP C	4700PF	K
C110			CC73GCH1H101J	CHIP C	100PF	J
C111, 112			CC73GCH1H101J	CHIP C	100PF	J
C121,122			CC73GCH1H220J	CHIP C	22PF	J
C125			CK73GB1H103K	CHIP C	0.010UF	K
C126			CC73GCH1H101J	CHIP C	100PF	J
C141			CC73GCH1H101J	CHIP C	100PF	J
C151, 152			CE04LW1H4R7M	ELECTRO	4.7UF	50WV
C151, 152		*	CE04PW2A4R7M	ELECTRO	4.7UF	100WV
C153, 154			CC73GCH1H101J	CHIP C	100PF	J
C155-157			CE04LW1H4R7M	ELECTRO	4.7UF	50WV
C155-157		*	CE04PW2A4R7M	ELECTRO	4.7UF	100WV
C158-160			CE04PW1H4R7M	ELECTRO	4.7UF	50WV
C161, 162			CK73GB1H223K	CHIP C	0.022UF	K
C163, 164			CK73GB1C333K	CHIP C	0.033UF	K
C165, 166			CK73FB1C474K	CHIP C	0.47UF	K
C167, 168			CE04LW1H4R7M	ELECTRO	4.7UF	50WV
C169, 170			CK73GB1H222K	CHIP C	2200PF	K
C177-181			CE04KW1H4R7M	ELECTRO	4.7UF	50WV
C182			CE04PW1H4R7M	ELECTRO	4.7UF	50WV
C183			CK73FF1C105Z	CHIP C	1.0UF	Z
C184			CC73GCH1H221J	CHIP C	220PF	J
C185, 186			CK73FB1E104K	CHIP C	0.10UF	K
C189, 190			CE04PW1H100M	ELECTRO	10UF	50WV
C203, 204			CE04PW1H100M	ELECTRO	10UF	50WV
C205, 206			CK73GB1H222K	CHIP C	2200PF	K
C207, 208			CK73GB1H821K	CHIP C	820PF	K
C209			CK73GB1H472K	CHIP C	4700PF	K
C210			CC73GCH1H101J	CHIP C	100PF	J
C211, 212			CC73GCH1H101J	CHIP C	100PF	J
C215, 216			CK73GB1H102K	CHIP C	1000PF	K
C251-256			CC73GCH1H221J	CHIP C	220PF	J
C303, 304			CE04PW1H100M	ELECTRO	10UF	50WV
C305			CK73GB1H182K	CHIP C	1800PF	K
C306			CK73GB1H822K	CHIP C	8200PF	K
C307			CK73GB1H222K	CHIP C	2200PF	K
C308			CK73GB1H822K	CHIP C	8200PF	K
C309			CK73GB1H103K	CHIP C	0.010UF	K
C310			CC73GCH1H101J	CHIP C	100PF	J

L : Scandinavia K : USA P : Canada R : Mexico C : China I : Malaysia
Y : PX(Far East,Hawaii) T : England E : Europe G : Germany V : China(Shanghai)
Y : AAFES(Europe) X : Australia Q : Russia H : Korea M : Other Areas Δ indicates safety critical components.

PARTS LIST

10

* New Parts
Parts without **Parts No.** are not supplied.
Les articles non mentionnés dans le **Parts No.** ne sont pas fournis.
Teile ohne **Parts No.** werden nicht geliefert.

Ref. No	Add-ress	New Parts	Parts No.	Description	Desti-nation	Re-marks
C311			CC73GCH1H101J	CHIP C	100PF	J
C401, 402			CK73GB1H103K	CHIP C	0.010UF	K
C451			CK73FB1E104K	CHIP C	0.10UF	K
C452			CE04KW1C472M	ELECTRO	4700UF	16WV
C453, 454			CK73FB1E104K	CHIP C	0.10UF	K
C455			CE04LW1E470M	ELECTRO	47UF	25WV
C456, 457			CK73FB1E104K	CHIP C	0.10UF	K
C458			CE04LW1E470M	ELECTRO	47UF	25WV
C459			CE04PW1H100M	ELECTRO	10UF	50WV
C460			CK73FB1E104K	CHIP C	0.10UF	K
C461			CE04PW1E470M	ELECTRO	47UF	25WV
C462			CE04PW1H100M	ELECTRO	10UF	50WV
C463			CK73FB1E104K	CHIP C	0.10UF	K
C464			CE04PW1E470M	ELECTRO	47UF	25WV
C465			CK73GB1H103K	CHIP C	0.010UF	K
C468, 469			CC73GCH1H101J	CHIP C	100PF	J
C501-504			CK73FB1E104K	CHIP C	0.10UF	K
C505			CK73GB1H102K	CHIP C	1000PF	K
C506			CC73GCH1H471J	CHIP C	470PF	J
C507			CK73GB1H103K	CHIP C	0.010UF	K
C508			CE04LW1H2R2M	ELECTRO	2.2UF	50WV
C509			CE04PW1E470M	ELECTRO	47UF	25WV
C510			CK73GB1H103K	CHIP C	0.010UF	K
C601-604			CK73FB1E104K	CHIP C	0.10UF	K
C605			CK73GB1H102K	CHIP C	1000PF	K
C606			CC73GCH1H471J	CHIP C	470PF	J
C607			CK73GB1H103K	CHIP C	0.010UF	K
C608			CE04LW1H2R2M	ELECTRO	2.2UF	50WV
C609			CE04PW1E470M	ELECTRO	47UF	25WV
C610			CK73GB1H103K	CHIP C	0.010UF	K
C651			CE04PW1H010M	ELECTRO	1UF	50WV
C652			CE04PW1C101M	ELECTRO	100UF	16WV
C653			CE04PW1H100M	ELECTRO	10UF	50WV
C654			CE04LW1C101M	ELECTRO	100UF	16WV
C655			CE04EW1C471M	ELECTRO	470UF	16WV
C701, 702			CK73GB1H471K	CHIP C	470PF	K
C703, 704			CE04KW1E470M	ELECTRO	47UF	25WV
C705, 706			CC73GCH1H220J	CHIP C	22PF	J
C707, 708			CE04KW1H100M	ELECTRO	10UF	50WV
C709, 710			CC73GCH1H330J	CHIP C	33PF	J
C711, 712			CC73GCH1H470J	CHIP C	47PF	J
C713			CC73GCH1H101J	CHIP C	100PF	J
C714			CK73GB1H103K	CHIP C	0.010UF	K
C715, 716			CE04LW1E470M	ELECTRO	47UF	25WV
C801, 802			CK73GB1H471K	CHIP C	470PF	K
C803, 804			CE04KW1E470M	ELECTRO	47UF	25WV
C805, 806			CC73GCH1H220J	CHIP C	22PF	J
C807, 808			CE04LW1E470M	ELECTRO	47UF	25WV
C809, 810			CC73GCH1H330J	CHIP C	33PF	J
C811, 812			CC73GCH1H470J	CHIP C	47PF	J
C813			CC73GCH1H101J	CHIP C	100PF	J
C814			CK73GB1H103K	CHIP C	0.010UF	K
C901, 902			CK73GB1H471K	CHIP C	470PF	K
C903			CE04KW1E470M	ELECTRO	47UF	25WV
C904			CE04KW1E221M	ELECTRO	220UF	25WV

L : Scandinavia K : USA P : Canada R : Mexico C : China I : Malaysia
Y : PX(Far East,Hawaii) T : England E : Europe G : Germany V : China(Shanghai)
Y : AAFES(Europe) X : Australia Q : Russia H : Korea M : Other Areas Δ indicates safety critical components.

* New Parts

Parts without **Parts No.** are not supplied.

Les articles non mentionnés dans le **Parts No.** ne sont pas fournis.

Teile ohne **Parts No.** werden nicht geliefert.



Ref. No	Address	New Parts	Parts No.	Description	Destination	Remarks
C905,906			CC73GCH1H220J	CHIP C 22PF	J	
C907,908			CE04KW1H100M	ELECTRO 10UF	50WV	
C909			CC73GCH1H330J	CHIP C 33PF	J	
C910			CK73GB1H222K	CHIP C 2200PF	K	
C911			CC73GCH1H470J	CHIP C 47PF	J	
C913			CC73GCH1H101J	CHIP C 100PF	J	
C914			CK73GB1H103K	CHIP C 0.010UF	K	
C915,916			CE04LW1E470M	ELECTRO 47UF	25WV	0
CN1			E40-8485-05	FLAT CABLE CONNECTOR		
CN2			E40-9842-05	PIN ASSY		0
CN3			E40-8488-05	FLAT CABLE CONNECTOR		
CN5			E40-3246-05	PIN ASSY		
J1			E63-1080-05	PIN JACK		
J2			E63-1139-05	PIN JACK		16790
E2			F10-1197-04	SHIELDING PLATE		
E1			J11-0808-05	WIRE CLAMPER		
L41			L92-0510-05	CHIP FERRITE		
X1			L77-2296-05	CRYSTAL RESONATOR(12.288MHZ)		
CP51,52			R90-0714-05	MULTI-COMP 10K X4		
CP61,62			R90-0714-05	MULTI-COMP 10K X4		0
CP90,91			R90-0728-05	MULTI-COMP 180 X4		
CP92			R90-0728-05	MULTI-COMP 180 X4		0
CP93-96			R90-0728-05	MULTI-COMP 180 X4		
R1,2			RK73GB1J562J	CHIP R 5.6K	J 1/16W	
R3,4			RK73GB1J101J	CHIP R 100	J 1/16W	
R5,6			RK73GB1J471J	CHIP R 470	J 1/16W	
R7-10			RK73GB1J472J	CHIP R 4.7K	J 1/16W	
R11,12			RK73GB1J471J	CHIP R 470	J 1/16W	
R20			RD14NB2E4R7J	RD 4.7	J 1/4W	
R21			RK73GB1J221J	CHIP R 220	J 1/16W	
R31,32			RK73GB1J820J	CHIP R 82	J 1/16W	
R33			RK73GB1J471J	CHIP R 470	J 1/16W	
R34			RD14NB2E4R7J	RD 4.7	J 1/4W	
R35			RK73GB1J471J	CHIP R 470	J 1/16W	790
R36			RD14NB2E4R7J	RD 4.7	J 1/4W	790
R37			RK73GB1J471J	CHIP R 470	J 1/16W	90
R38			RD14NB2E4R7J	RD 4.7	J 1/4W	90
R41,42			RK73GB1J105J	CHIP R 1.0M	J 1/16W	
R43-45			RK73GB1J221J	CHIP R 220	J 1/16W	
R54			RK73GB1J183J	CHIP R 18K	J 1/16W	
R55-57			RK73GB1J220J	CHIP R 22	J 1/16W	
R58			RK73GB1J221J	CHIP R 220	J 1/16W	
R59			RK73GB1J220J	CHIP R 22	J 1/16W	
R66			RK73GB1J104J	CHIP R 100K	J 1/16W	
R67			RK73GB1J103J	CHIP R 10K	J 1/16W	
R68			RK73GB1J221J	CHIP R 220	J 1/16W	
R101,102			RK73GB1J222J	CHIP R 2.2K	J 1/16W	
R103,104			RK73GB1J104J	CHIP R 100K	J 1/16W	
R107,108			RK73GB1J222J	CHIP R 2.2K	J 1/16W	
R109,110			RK73GB1J103J	CHIP R 10K	J 1/16W	
R111,112			RK73GB1J472J	CHIP R 4.7K	J 1/16W	
R113,114			RK73GB1J221J	CHIP R 220	J 1/16W	

L: Scandinavia K: USA P: Canada R: Mexico C: China I: Malaysia
 Y: PX(Far East,Hawaii) T: England E: Europe G: Germany V: China(Shanghai)
 Y: AAFES(Europe) X: Australia Q: Russia H: Korea M: Other Areas Δ indicates safety critical components.

* New Parts

Parts without **Parts No.** are not supplied.

Les articles non mentionnés dans le **Parts No.** ne sont pas fournis.

Teile ohne **Parts No.** werden nicht geliefert.



Ref. No	Address	New Parts	Parts No.	Description	Destination	Remarks
R121-124			RK73GB1J103J	CHIP R 10K	J 1/16W	
R125,126			RK73GB1J101J	CHIP R 100	J 1/16W	
R127,128			RK73GB1J242J	CHIP R 2.4K	J 1/16W	
R141-146			RK73GB1J1R0J	CHIP R 1	J 1/16W	5
R151-156			RK73GB1J100J	CHIP R 10	J 1/16W	
R157,158			RK73GB1J221J	CHIP R 220	J 1/16W	
R159-164			RK73GB1J101J	CHIP R 100	J 1/16W	
R165			RK73GB1J392J	CHIP R 3.9K	J 1/16W	
R166			RK73GB1J272J	CHIP R 2.7K	J 1/16W	
R168,169			RK73FB2A1R0J	CHIP R 1	J 1/10W	
R170,171			RK73GB1J471J	CHIP R 470	J 1/16W	
R172,173			RK73GB1J101J	CHIP R 100	J 1/16W	
R201,202			RK73GB1J332J	CHIP R 3.3K	J 1/16W	
R203,204			RK73GB1J104J	CHIP R 100K	J 1/16W	
R207,208			RK73GB1J222J	CHIP R 2.2K	J 1/16W	
R209,210			RK73GB1J272J	CHIP R 2.7K	J 1/16W	
R211,212			RK73GB1J562J	CHIP R 5.6K	J 1/16W	
R213,214			RK73GB1J221J	CHIP R 220	J 1/16W	
R215,216			RK73GB1J472J	CHIP R 4.7K	J 1/16W	
R217,218			RK73GB1J562J	CHIP R 5.6K	J 1/16W	
R220			RK73GB1J103J	CHIP R 10K	J 1/16W	
R251,252			RK73GB1J153J	CHIP R 15K	J 1/16W	16790
R253,254			RK73GB1J223J	CHIP R 22K	J 1/16W	16790
R255,256			RK73GB1J103J	CHIP R 10K	J 1/16W	16790
R257,258			RK73GB1J223J	CHIP R 22K	J 1/16W	16790
R259,260			RK73GB1J103J	CHIP R 10K	J 1/16W	16790
R261,262			RK73GB1J223J	CHIP R 22K	J 1/16W	16790
R263,264			RK73GB1J101J	CHIP R 100	J 1/16W	16790
R301			RK73GB1J222J	CHIP R 2.2K	J 1/16W	
R302			RK73GB1J153J	CHIP R 15K	J 1/16W	
R303,304			RK73GB1J104J	CHIP R 100K	J 1/16W	
R307			RK73GB1J222J	CHIP R 2.2K	J 1/16W	
R308			RK73GB1J183J	CHIP R 18K	J 1/16W	
R309,310			RK73GB1J103J	CHIP R 10K	J 1/16W	
R311			RK73GB1J472J	CHIP R 4.7K	J 1/16W	
R312			RK73GB1J562J	CHIP R 5.6K	J 1/16W	
R313			RK73GB1J102J	CHIP R 1.0K	J 1/16W	
R314			RK73GB1J221J	CHIP R 220	J 1/16W	
R401-405			RK73GB1J471J	CHIP R 470	J 1/16W	
R407,408			RK73GB1J471J	CHIP R 470	J 1/16W	
R411			RK73GB1J471J	CHIP R 470	J 1/16W	
R449			RS14KB3D180J	FL-PROOF RS 18	J 2W	0
R451			R92-1945-05	METAL GLAZE 1	J 1/4W	
R452			RD14NB2E1R0J	RD 1	J 1/4W	
R453			RD14NB2E4R7J	RD 4.7	J 1/4W	
R454			RS14KB3D180J	FL-PROOF RS 18	J 2W	
R459		*	R92-1993-05	METAL GLAZE 560	J 1/4W	
R460		*	RK73GB1J223J	CHIP R 22K	J 1/16W	
R461		*	R92-1993-05	METAL GLAZE 560	J 1/4W	0
R462		*	RK73GB1J223J	CHIP R 22K	J 1/16W	0
R491,492			RK73GB1J221J	CHIP R 220	J 1/16W	
R493			RK73GB1J473J	CHIP R 47K	J 1/16W	
R494			RK73GB1J472J	CHIP R 4.7K	J 1/16W	
R495			RK73GB1J102J	CHIP R 1.0K	J 1/16W	
R496			RK73GB1J152J	CHIP R 1.5K	J 1/16W	

L: Scandinavia K: USA P: Canada R: Mexico C: China I: Malaysia
 Y: PX(Far East,Hawaii) T: England E: Europe G: Germany V: China(Shanghai)
 Y: AAFES(Europe) X: Australia Q: Russia H: Korea M: Other Areas Δ indicates safety critical components.

PARTS LIST

VR-505/506/507/509/510/517

* New Parts
 Parts without **Parts No.** are not supplied.
 Les articles non mentionnes dans le **Parts No.** ne sont pas fournis.
 Teile ohne **Parts No.** werden nicht geliefert.

13

Ref. No	Add-ress	New Parts	Parts No.	Description	Desti-nation	Re-marks
R501			RK73GB1J221J	CHIP R 220 J 1/16W	0	
R502,503			RK73GB1J473J	CHIP R 47K J 1/16W	0	
R505			RK73GB1J103J	CHIP R 10K J 1/16W		
R514			RK73GB1J101J	CHIP R 100 J 1/16W		
R515			RK73GB1J221J	CHIP R 220 J 1/16W		
R516			RK73GB1J103J	CHIP R 10K J 1/16W		
R517			RK73GB1J221J	CHIP R 220 J 1/16W		
R518			RK73GB1J472J	CHIP R 4.7K J 1/16W		
R519			RK73GB1J221J	CHIP R 220 J 1/16W		
R520,521			RK73GB1J103J	CHIP R 10K J 1/16W		
R522,523			RK73GB1J472J	CHIP R 4.7K J 1/16W		
R524			RK73GB1J333J	CHIP R 33K J 1/16W		
R527			RK73GB1J103J	CHIP R 10K J 1/16W		
R528,529			RK73GB1J221J	CHIP R 220 J 1/16W		
R532-536			RK73GB1J221J	CHIP R 220 J 1/16W	15679	
R601-603			RK73GB1J221J	CHIP R 220 J 1/16W	0	
R605			RK73GB1J103J	CHIP R 10K J 1/16W	0	
R614			RK73GB1J101J	CHIP R 100 J 1/16W	0	
R615			RK73GB1J221J	CHIP R 220 J 1/16W	0	
R616			RK73GB1J103J	CHIP R 10K J 1/16W	0	
R617			RK73GB1J221J	CHIP R 220 J 1/16W	0	
R618			RK73GB1J472J	CHIP R 4.7K J 1/16W	0	
R619			RK73GB1J221J	CHIP R 220 J 1/16W	0	
R620,621			RK73GB1J103J	CHIP R 10K J 1/16W	0	
R622,623			RK73GB1J472J	CHIP R 4.7K J 1/16W	0	
R624			RK73GB1J333J	CHIP R 33K J 1/16W	0	
R627			RK73GB1J103J	CHIP R 10K J 1/16W	0	
R628,629			RK73GB1J221J	CHIP R 220 J 1/16W	0	
R652			RK73GB1J223J	CHIP R 22K J 1/16W	0	
R653			RK73GB1J102J	CHIP R 1.0K J 1/16W	0	
R654			RK73GB1J103J	CHIP R 10K J 1/16W	0	
R655			RK73GB1J223J	CHIP R 22K J 1/16W	0	
R656			RK73GB1J102J	CHIP R 1.0K J 1/16W	0	
R657			RK73GB1J103J	CHIP R 10K J 1/16W	0	
R658			RK73GB1J102J	CHIP R 1.0K J 1/16W	0	
R660			RD14NB2E561J	RD 560 J 1/4W	0	
R661			RK73GB1J102J	CHIP R 1.0K J 1/16W	0	
R662,663		*	R92-4558-05	METAL GLAZE 47 J 1/4W		
R701,702			RK73GB1J473J	CHIP R 47K J 1/16W		
R703,704			RK73GB1J103J	CHIP R 10K J 1/16W		
R705,706			RK73GB1J472J	CHIP R 4.7K J 1/16W		
R707,708			RK73GB1J474J	CHIP R 470K J 1/16W		
R709,710			RK73GB1J473J	CHIP R 47K J 1/16W		
R711,712			RK73GB1J221J	CHIP R 220 J 1/16W	0	
R713,714			RK73GB1J102J	CHIP R 1.0K J 1/16W	0	
R715,716			RK73GB1J103J	CHIP R 10K J 1/16W		
R801,802			RK73GB1J473J	CHIP R 47K J 1/16W		
R803,804			RK73GB1J103J	CHIP R 10K J 1/16W		
R805,806			RK73GB1J472J	CHIP R 4.7K J 1/16W		
R807,808			RK73GB1J474J	CHIP R 470K J 1/16W		
R809,810			RK73GB1J473J	CHIP R 47K J 1/16W		
R811,812			RK73GB1J221J	CHIP R 220 J 1/16W	0	
R813,814			RK73GB1J102J	CHIP R 1.0K J 1/16W	0	
R815,816			RK73GB1J473J	CHIP R 47K J 1/16W	0	
R817,818			RK73GB1J103J	CHIP R 10K J 1/16W	0	

L : Scandinavia K : USA P : Canada R : Mexico C : China I : Malaysia
 Y : PX(Far East,Hawaii) T : England E : Europe G : Germany V : China(Shanghai)
 Y : AAFES(Europe) X : Australia Q : Russia H : Korea M : Other Areas Δ indicates safety critical components.

PARTS LIST

14

* New Parts
 Parts without **Parts No.** are not supplied.
 Les articles non mentionnes dans le **Parts No.** ne sont pas fournis.
 Teile ohne **Parts No.** werden nicht geliefert.

Ref. No	Add-ress	New Parts	Parts No.	Description	Desti-nation	Re-marks
R901,902			RK73GB1J473J	CHIP R 47K J 1/16W		
R903,904			RK73GB1J103J	CHIP R 10K J 1/16W		
R905			RK73GB1J472J	CHIP R 4.7K J 1/16W		
R906			RK73GB1J911J	CHIP R 910 J 1/16W		
R907			RK73GB1J474J	CHIP R 470K J 1/16W		
R908			RK73GB1J103J	CHIP R 10K J 1/16W		
R909,910			RK73GB1J473J	CHIP R 47K J 1/16W		
R911,912			RK73GB1J221J	CHIP R 220 J 1/16W	0	
R913,914			RK73GB1J102J	CHIP R 1.0K J 1/16W	0	
R915,916			RK73GB1J103J	CHIP R 10K J 1/16W	0	
D1			DAN202U	DIODE		
D1			MA142WK	DIODE		
D1			1SS301	DIODE		
D2			DAP202U	DIODE		
D2			MA142WA	DIODE		
D2			1SS300	DIODE		
D3			DAN202U	DIODE		
D3			MA142WK	DIODE		
D3			1SS301	DIODE		
D6			MA111	DIODE		
Δ D41			D2SBA20F03	DIODE		
D42,43		*	HZU5.6(B2)	ZENER DIODE		
D42,43			UDZ5.6B	ZENER DIODE		
D44		*	HZU3.9(B2)	ZENER DIODE		
D44			UDZ3.9B	ZENER DIODE		
D45		*	HZU3.9(B2)	ZENER DIODE		
D45			UDZ3.9B	ZENER DIODE		
D46		*	HZU5.1(B2)	ZENER DIODE		
D46			UDZ5.1B	ZENER DIODE		
D47			MA111	DIODE		
D67		*	HZU5.1(B2)	ZENER DIODE		
D67			UDZ5.1B	ZENER DIODE		
D151,152		*	HZU7.5(B2)	ZENER DIODE		
D151,152			UDZ7.5B	ZENER DIODE		
IC1			NJM4565M	ANALOGUE IC		
IC1			NJM4565MD	IC(OP AMP X2)		
IC2		*	AK4527B-VQ	MOS-IC		
IC4			TC7WU04FU	MOS-IC		
IC5		*	AK4112AVF	MOS-IC		
IC6			TC7WH123FU	MOS-IC		
IC11			NJM4565M	ANALOGUE IC		
IC11			NJM4565MD	IC(OP AMP X2)		
IC12			NJU7311AM	MOS-IC		
IC13			NJM4565M	ANALOGUE IC		
IC13			NJM4565MD	IC(OP AMP X2)		
IC14			NJU7311AM	MOS-IC	16790	
IC15			M62446FP	ANALOGUE IC		
IC21			NJM4565M	ANALOGUE IC		
IC21			NJM4565MD	IC(OP AMP X2)		
IC31			NJM4565M	ANALOGUE IC		
IC31			NJM4565MD	IC(OP AMP X2)		
IC41			TC74HC07AF	MOS-IC		
IC42			TC74HCT7007AF	MOS-IC		
IC45			BA05T	ANALOGUE IC		
Δ IC46			BA033LBSG	ANALOGUE IC		

L : Scandinavia K : USA P : Canada R : Mexico C : China I : Malaysia
 Y : PX(Far East,Hawaii) T : England E : Europe G : Germany V : China(Shanghai)
 Y : AAFES(Europe) X : Australia Q : Russia H : Korea M : Other Areas Δ indicates safety critical components.

* New Parts

Parts without **Parts No.** are not supplied.
Les articles non mentionnés dans le **Parts No.** ne sont pas fournis.
Teile ohne **Parts No.** werden nicht geliefert.

15

Ref. No	Address	New Parts	Parts No.	Description	Destination	Remarks
△ IC47			XC62EP2502MR	ANALOGUE IC		
△ IC48			XC62EP2502MR	ANALOGUE IC	0	
IC51			CS493263-CLR	MOS-IC		
IC61		*	CS493302-CLR	MOS-IC	0	
IC70			NJM4565M	ANALOGUE IC		
IC70			NJM4565MD	IC(OP AMP X2)		
IC80			NJM4565M	ANALOGUE IC		
IC80			NJM4565MD	IC(OP AMP X2)		
IC90			NJM4565M	ANALOGUE IC		
IC90			NJM4565MD	IC(OP AMP X2)		
Q1			DTC124EUA	DIGITAL TRANSISTOR		
△ Q1			UN5212	DIGITAL TRANSISTOR		
△ Q15			2SD1664(Q,R)	TRANSISTOR		
△ Q16			2SB1132(Q,R)	TRANSISTOR		
△ Q41			2SC4081(R,S)	TRANSISTOR		
Q41			2SD1819A(Q,R)	TRANSISTOR		
Q42			2SA1576A(R,S)	TRANSISTOR		
△ Q42			2SB1218A(Q,R)	TRANSISTOR		
△ Q47			2SB1375	TRANSISTOR		
△ Q48			2SB1375	TRANSISTOR	0	
Q49 ,50			DTC124EUA	DIGITAL TRANSISTOR		
Q49 ,50			UN5212	DIGITAL TRANSISTOR		
Q65			DTA124EUA	DIGITAL TRANSISTOR		
Q65			UN5112	DIGITAL TRANSISTOR		
Q66			DTA124EUA	DIGITAL TRANSISTOR	0	
Q66			UN5112	DIGITAL TRANSISTOR	0	
Q71 ,72			2SC4213(B)	TRANSISTOR		
Q73 ,74			2SC4213(B)	TRANSISTOR	0	
Q81 ,82			2SC4213(B)	TRANSISTOR		
Q83 ,84			2SC4213(B)	TRANSISTOR	0	
Q91 ,92			2SC4213(B)	TRANSISTOR		
Q93 ,94			2SC4213(B)	TRANSISTOR	0	
A1		*	W02-2802-05	OPTIC RECEIVING MODULE	790	
A2		*	W02-2802-05	OPTIC RECEIVING MODULE		
A3		*	W02-2803-05	OSCILLATING MODULE	90	
DISPLAY (X14-7250-10,X14-7260-10)						
D1 -4			B30-2545-05	LED(RED3(160))	790	
D5 ,6			B30-2545-05	LED(RED3(160))		
C1			CE04RW0J470M	ELECTRO	47UF	6.3WV
C10 -12			CK45FF1H103Z	CERAMIC	0.010UF	Z
C13 ,14			CK73GB1H103K	CHIP C	0.010UF	K
C15 ,16			CK45FF1H103Z	CERAMIC	0.010UF	Z
C17 -21			CC45FSL1H101J	CERAMIC	100PF	J
C22 ,23			CQ93FMG1H471J	MYLAR	470PF	J
C24			CE04HW1H100M	NP-ELEC	10UF	50WV
C26			CC45FSL1H101J	CERAMIC	100PF	J
C27			CE04RW1A101M	ELECTRO	100UF	10WV
C28			CE04KW1V470M	ELECTRO	47UF	35WV
C29			CE04RW1H330M	ELECTRO	33UF	50WV
C30			CQ93FMG1H471J	MYLAR	470PF	J
C31 ,32			CE04RW1H010M	ELECTRO	1.0UF	50WV
C100-105			CC45FSL1H221J	CERAMIC	220PF	J
C115			CK73GB1H103K	CHIP C	0.010UF	K

L : Scandinavia K : USA P : Canada R : Mexico C : China I : Malaysia
Y : PX(Far East,Hawaii) T : England E : Europe G : Germany V : China(Shanghai)
Y : AAFES(Europe) X : Australia Q : Russia H : Korea M : Other Areas △ indicates safety critical components .

* New Parts

Parts without **Parts No.** are not supplied.
Les articles non mentionnés dans le **Parts No.** ne sont pas fournis.
Teile ohne **Parts No.** werden nicht geliefert.

15

Ref. No	Address	New Parts	Parts No.	Description	Destination	Remarks
C201			CC45FSL1H221J	CERAMIC	220PF	J
C202			CQ93FMG1H103J	MYLAR	0.010UF	J
C203			CE04PW1E470M	ELECTRO	47UF	25WV
C205,206			CQ93FMG1H102J	MYLAR	1000PF	J
C207,208			CK73GB1H102K	CHIP C	1000PF	K
C209,210			CC45FSL1H470J	CERAMIC	47PF	J
C211			CE04PW1E470M	ELECTRO	47UF	25WV
C212			CC45FSL1H470J	CERAMIC	47PF	J
C213			CE04PW1E470M	ELECTRO	47UF	25WV
C214			CC45FSL1H470J	CERAMIC	47PF	J
C215			CE04PW1E470M	ELECTRO	47UF	25WV
C216			CC45FSL1H470J	CERAMIC	47PF	J
C217			CE04PW1E470M	ELECTRO	47UF	25WV
C218			CC45FSL1H470J	CERAMIC	47PF	J
C219			CC45FSL1H470J	CERAMIC	47PF	J
C229,230			CE04PW1H100M	ELECTRO	10UF	50WV
C243,244			CC73GCH1H101J	CHIP C	100PF	J
C245			CK73GB1H103K	CHIP C	0.010UF	K
C246			CC45FSL1H221J	CERAMIC	220PF	J
C247,248			CQ93FMG1H103J	MYLAR	0.010UF	J
C249,250			CK73GB1H103K	CHIP C	0.010UF	K
C258			CK73GB1H103K	CHIP C	0.010UF	K
C259			CE04PW1A101M	ELECTRO	100UF	10WV
C260			CE04EW0J102M	ELECTRO	1000UF	6.3WV
C262			CE04PW1H010M	ELECTRO	1UF	50WV
C263-265			CK73GB1H103K	CHIP C	0.010UF	K
C284			CQ93FMG1H103J	MYLAR	0.010UF	J
C401-408			CC73GCH1H470J	CHIP C	47PF	J
C409-412			CC73GCH1H470J	CHIP C	47PF	J
C413,414			CK73GB1H103K	CHIP C	0.010UF	K
C415			CK73GB1H103K	CHIP C	0.010UF	K
C416			CK45FF1H103Z	CERAMIC	0.010UF	Z
C417			CK73GB1H103K	CHIP C	0.010UF	K
C418,419			CE04KW1E470M	ELECTRO	47UF	25WV
C420,421			CE04KW1E470M	ELECTRO	47UF	25WV
C422			CE04KW1E470M	ELECTRO	47UF	25WV
C424,425			CE04KW1V100M	ELECTRO	10UF	35WV
C501			CC45FSL1H101J	CERAMIC	100PF	J
C503-505			CC45FSL1H101J	CERAMIC	100PF	J
C510-515			CC45FSL1H101J	CERAMIC	100PF	J
C518			CC73GCH1H101J	CHIP C	100PF	J
C539-542			CE04PW1H100M	ELECTRO	10UF	50WV
CN1			E40-8504-05	FLAT CABLE CONNECTOR		
CN2			E40-3247-05	PIN ASSY		
CN3			E40-8477-05	FLAT CABLE CONNECTOR		16790
CN100			E40-9825-05	SOCKET FOR PIN ASSY		0
CN101			E40-8429-05	SOCKET FOR PIN ASSY		
CN201			E40-8483-05	FLAT CABLE CONNECTOR		16790
CN202			E40-8488-05	FLAT CABLE CONNECTOR		
CN203			E40-8483-05	FLAT CABLE CONNECTOR		
CN204			E40-8504-05	FLAT CABLE CONNECTOR		
CN205			E40-9833-05	SOCKET FOR PIN ASSY		
CN206			E40-4721-05	FLAT CABLE CONNECTOR		16790
CN401			E40-8483-05	FLAT CABLE CONNECTOR		167

L : Scandinavia K : USA P : Canada R : Mexico C : China I : Malaysia
Y : PX(Far East,Hawaii) T : England E : Europe G : Germany V : China(Shanghai)
Y : AAFES(Europe) X : Australia Q : Russia H : Korea M : Other Areas △ indicates safety critical components .

PARTS LIST

VR-505/506/507/509/510/517

* New Parts
Parts without **Parts No.** are not supplied.
Les articles non mentionnés dans le **Parts No.** ne sont pas fournis.
Teile ohne **Parts No.** werden nicht geliefert.

17

Ref. No	Add-ress	New Parts	Parts No.	Description	Desti-nation	Re-marks
J1			E11-0272-05	PHONE JACK		
J2		*	E63-1172-05	PIN JACK	16790	
J3		*	E56-0033-05	CYLINDRICAL RECEPTACLE	16790	
J100			E63-1139-05	PIN JACK	0	
J200			E11-0293-05	MINIATURE PHONE JACK(2P)		
J201			E63-0127-05	PIN JACK	790	
J202			E63-0130-05	PIN JACK	0	
J203			E63-0069-05	PIN JACK	156	
J204			E63-0130-05	PIN JACK	156	
J401,402			E56-0011-05	CYLINDRICAL RECEPTACLE	7	
J403,404			E56-0023-05	CYLINDRICAL RECEPTACLE	16	
E1			J11-0808-05	WIRE CLAMPER		
E4			J11-0808-05	WIRE CLAMPER	670	
L1			L92-0017-05	FERRITE CORE	16790	
X200			L78-0725-05	RESONATOR (8.38MHZ)		
CP200			R90-0802-05	MULTI-COMP	100KX10	J 1/4W
CP201,202			R90-0500-05	MULTI-COMP	100KX6	J 1/4W
CP203			R90-0855-05	MULTI-COMP	100KX5	J
CP205			R90-0802-05	MULTI-COMP	100KX10	J 1/4W
CP206			R90-0482-05	MULTI-COMP	100KX4	J 1/6W
R2			RK73GB1J563J	CHIP R	56K	J 1/16W
R66			RD14NB2E2R2J	RD	2.2	J 1/4W
R231			RK73GB1J101J	CHIP R	100	J 1/16W
R232			RK73GB1J103J	CHIP R	10K	J 1/16W
R233			RK73GB1J101J	CHIP R	100	J 1/16W
R239			RK73GB1J221J	CHIP R	220	J 1/16W
R240-242			RK73GB1J101J	CHIP R	100	J 1/16W
R243-247			RK73GB1J221J	CHIP R	220	J 1/16W
R251-255			RK73GB1J101J	CHIP R	100	J 1/16W
R256			RK73GB1J104J	CHIP R	100K	J 1/16W
R262,263			RK73GB1J102J	CHIP R	1.0K	J 1/16W
R264			RK73GB1J103J	CHIP R	10K	J 1/16W
R265			RK73GB1J102J	CHIP R	1.0K	J 1/16W
R266			RK73GB1J104J	CHIP R	100K	J 1/16W
R267,268			RK73GB1J103J	CHIP R	10K	J 1/16W
R269			RK73GB1J102J	CHIP R	1.0K	J 1/16W
R288			RK73GB1J101J	CHIP R	100	J 1/16W
R297-299			RK73GB1J221J	CHIP R	220	J 1/16W
R304,305			RK73GB1J101J	CHIP R	100	J 1/16W
R310-312			RK73GB1J104J	CHIP R	100K	J 1/16W
R315,316			RK73GB1J104J	CHIP R	100K	J 1/16W
R401,402			RK73GB1J104J	CHIP R	100K	J 1/16W
R403,404			RK73GB1J820J	CHIP R	82	J 1/16W
R405,406			RK73GB1J104J	CHIP R	100K	J 1/16W
R407,408			RK73GB1J104J	CHIP R	100K	J 1/16W
R409-412			RK73GB1J820J	CHIP R	82	J 1/16W
R413			RK73GB1J680J	CHIP R	68	J 1/16W
R415,416			RK73GB1J680J	CHIP R	68	J 1/16W
R421,422			RK73GB1J1R0J	CHIP R	1	J 1/16W
R423			RK73GB1J1R0J	CHIP R	1	J 1/16W
R424,425			RK73GB1J1R0J	CHIP R	1	J 1/16W
S1 -13			S70-0031-05	TACT SWITCH		

L: Scandinavia K: USA P: Canada R: Mexico C: China I: Malaysia
Y: PX(Far East,Hawaii) T: England E: Europe G: Germany V: China(Shanghai)
Y: AAFES(Europe) X: Australia Q: Russia H: Korea M: Other Areas Δ indicates safety critical components.

* New Parts
Parts without **Parts No.** are not supplied.
Les articles non mentionnés dans le **Parts No.** ne sont pas fournis.
Teile ohne **Parts No.** werden nicht geliefert.

18

Ref. No	Add-ress	New Parts	Parts No.	Description	Desti-nation	Re-marks
S1 -13			S70-0086-05	TACT SWITCH		
S17 ,18			S70-0031-05	TACT SWITCH	156	
S17 ,18			S70-0086-05	TACT SWITCH	156	
S14			T99-0630-05	ROTARY ENCODER		
S15			T99-0602-05	ROTARY ENCODER	790	
S16			T99-0630-05	ROTARY ENCODER		
D7			HZS6.2N(B2)	ZENER DIODE		
D7			MTZJ6.2(B)	ZENER DIODE		
D7			RD6.2ES(B)	ZENER DIODE		
D9 -11			HSS104A	DIODE		
D9 -11			1SS133	DIODE		
D12 -15			HSS104A	DIODE	16790	
D12 -15			1SS133	DIODE	16790	
D200-207			HSS104A	DIODE		
D200-207			1SS133	DIODE		
D209,210			HZS5.6N(B2)	ZENER DIODE		
D209,210			MTZJ5.6(B)	ZENER DIODE		
D209,210			RD5.6ES(B)	ZENER DIODE		
D212,213			RB721Q	DIODE		
D214-216			HSS104A	DIODE		
D214-216			1SS133	DIODE		
D220,221			HSS104A	DIODE	0	
D220,221			1SS133	DIODE	0	
D401			HSS104A	DIODE	167	
D401			1SS133	DIODE	167	
ED2		*	HNA-11MS24	FLUORESCENT INDICATOR TUBE		
ED2		*	11-MT-125GK	FLUORESCENT INDICATOR TUBE		
IC1			UPD16311	MOS-IC		
IC200		*	MN101C49GLE	MI-COM IC	156	
IC200		*	MN101C49HLD	MI-COM IC	0	
IC200		*	MN101C49HLF	MI-COM IC	79	
IC201			NJM2279D	ANALOGUE IC		
IC202			NJU4052BD	IC(4CH MPX/DE-MPX)	16790	
IC202			TC74HC4052AP	IC(ANALOG MULTIPLEXER)	16790	
IC204			S-80840ANY	ANALOGUE IC		
IC207			XC62FP5102P	ANALOGUE IC		
IC401,402			NJM2279M	ANALOGUE IC	167	
IC403			TC74HC4052AF	ANALOGUE IC	7	
Q1			KTC3199(Y,GR)	TRANSISTOR		
Q1			2SC1740S(Q,R)	TRANSISTOR		
Q100-105			2SC2878(B)	TRANSISTOR	0	
Q200,201			KTC3199(Y,GR)	TRANSISTOR	0	
Q200,201			2SC1740S(Q,R)	TRANSISTOR	0	
Q202			KTA1273	TRANSISTOR		
Q202			2SA1534A(R,S)	TRANSISTOR		
Q203			2SC3940A(R,S)	TRANSISTOR		
Q203		*	2SD1768S	TRANSISTOR		
Q204			KTC3199(Y,GR)	TRANSISTOR		
Q204			2SC1740S(Q,R)	TRANSISTOR		
Q205			KTA1267(Y,GR)	TRANSISTOR		
Q205			2SA933AS(Q,R)	TRANSISTOR		
Q401			DTC124ESA	TRANSISTOR	16	
Q401			UN4212	TRANSISTOR	16	

L: Scandinavia K: USA P: Canada R: Mexico C: China I: Malaysia
Y: PX(Far East,Hawaii) T: England E: Europe G: Germany V: China(Shanghai)
Y: AAFES(Europe) X: Australia Q: Russia H: Korea M: Other Areas Δ indicates safety critical components.

* New Parts

Parts without **Parts No.** are not supplied.
Les articles non mentionnés dans le **Parts No.** ne sont pas fournis.
Teile ohne **Parts No.** werden nicht geliefert.

19

Ref. No	Add-ress	New Parts	Parts No.	Description	Desti-nation	Re-marks
A2			W02-2625-05	OPTIC RECEIVING MODULE		
VIDEO (X35-2250-11)						
C1 -12 C13 -17 C18 -21 C22 C31			CC45FSL1H470J CK45FF1H103Z CE04PW1C470M CE04PW1E470M CK45FF1H103Z	CERAMIC CERAMIC ELECTRO ELECTRO CERAMIC	47PF 0.010UF 47UF 47UF 0.010UF	J Z 16WV 25WV Z
C32, 33 C53, 54 C101 C102 C103			CE04LW1V100M CE04LW1V100M CC45FSL1H470J CE04PW1E470M CC45FSL1H470J	ELECTRO ELECTRO CERAMIC ELECTRO CERAMIC	10UF 10UF 47PF 47UF 47PF	35WV 35WV J 25WV J
C104 C105 C106 C107 C108			CE04PW1E470M CC45FSL1H470J CE04PW1E470M CC45FSL1H470J CE04PW1E470M	ELECTRO CERAMIC ELECTRO CERAMIC ELECTRO	47UF 47PF 47UF 47PF 47UF	25WV J 25WV J 25WV
C109 C110 C111 C112 C121-123			CC45FSL1H470J CE04PW1E470M CC45FSL1H470J CE04PW1E470M CC45FSL1H470J	CERAMIC ELECTRO CERAMIC ELECTRO CERAMIC	47PF 47UF 47PF 47UF 47PF	J 25WV J 25WV J
C131-133 C141,142 C143 C201 C202			CK45FF1H103Z CE04LW1V100M CK45FF1H103Z CC45FSL1H121J CC45FSL1H470J	CERAMIC ELECTRO CERAMIC CERAMIC CERAMIC	0.010UF 10UF 0.010UF 120PF 47PF	Z 35WV Z J J
C203 C211,212 C213 C231 C232,233			Q93FMG1H823J CC45FSL1H101J CK45FF1H103Z CE04LW1V100M CK45FF1H103Z	MYLAR CERAMIC CERAMIC ELECTRO CERAMIC	0.082UF 100PF 0.010UF 10UF 0.010UF	J Z J 35WV Z
C234 C235 C236 C237 C238			CE04LW0J222M CE04LW0J331M CK45FF1H103Z CC45FSL1H101J CK45FF1H103Z	ELECTRO ELECTRO CERAMIC CERAMIC CERAMIC	2200UF 330UF 0.010UF 100PF 0.010UF	6.3WV 6.3WV J Z Z
C239			CE04LW0J221M	ELECTRO	220UF	6.3WV
CN1 CN2 J1 ,2 J11 J11			E40-8483-05 E40-8531-05 E56-0011-05 E63-1193-05 E63-1195-05	FLAT CABLE CONNECTOR FLAT CABLE CONNECTOR CYLINDRICAL RECEPTACLE PIN JACK PIN JACK		
J11 J12 J12 J12 J21		*	E63-1197-05 E63-1194-05 E63-1196-05 E63-1198-05 E11-0389-05	PIN JACK PIN JACK PIN JACK PIN JACK MINIATURE PHONE JACK(3.5 STERE		0
J22			E11-0291-05	MINIATURE PHONE JACK(2P)		
E1			J11-0809-05	WIRE CLAMPER		
L1			L40-1011-58	SMALL FIXED INDUCTOR(100UH,K)		

L: Scandinavia K: USA P: Canada R: Mexico C: China I: Malaysia
Y: PX(Far East,Hawaii) T: England E: Europe G: Germany V: China(Shanghai)
Y: AAFES(Europe) X: Australia Q: Russia H: Korea M: Other Areas Δ indicates safety critical components.

* New Parts

Parts without **Parts No.** are not supplied.
Les articles non mentionnés dans le **Parts No.** ne sont pas fournis.
Teile ohne **Parts No.** werden nicht geliefert.

20

Ref. No	Add-ress	New Parts	Parts No.	Description	Desti-nation	Re-marks
R31 ,32 R51 ,52 R141,142 R212,213 R215			RD14NB2E4R7J RS14KB3D220J RD14NB2E4R7J RD14NB2E471J RD14NB2E471J	RD FL-PROOF RS RD RD RD	4.7 22 4.7 470 470	J 1/4W J 2W J 1/4W J 1/4W J 1/4W
D51 ,52 D51 ,52 D51 ,52 D51 ,52 D51 ,52			HZS5.6N(B2) MTZJ5.6 MTZJ5.6(B) RD5.6ES(B) RD5.6ES(B2)	ZENER DIODE ZENER DIODE ZENER DIODE ZENER DIODE ZENER DIODE		
D101-103 D101-103 D101-103 D201,202 D201,202			HSS104 HSS104A 1SS133 HSS104 HSS104A	DIODE DIODE DIODE DIODE DIODE		
D201,202 D223,224 D223,224 D223,224 IC1 ,2			1SS133 HSS104 HSS104A 1SS133 NJM2279D	DIODE DIODE DIODE DIODE ANALOGUE IC		0 0 0
IC3 IC3 IC11-13 IC21 IC22			NJU4052BD TC74HC4052AP NJM2279D BA05T TC74HC00AP	IC(4CH MPX/DE-MPX) IC(ANALOG MULTIPLEXER) ANALOGUE IC ANALOGUE IC IC(2INPUT NAND GATE)		0
Q51 Q52 Q101 Q101 Q201			2SD2525 2SB1640 DTC124ESA UN4212 KTC3199(Y,GR)	TRANSISTOR TRANSISTOR DIGITAL TRANSISTOR DIGITAL TRANSISTOR TRANSISTOR		
Q201 Q201 Q202 Q202 Q203			2SC1740S(Q,R) 2SC2785(F,E) DTC124ESA UN4212 KTC3199(Y,GR)	TRANSISTOR TRANSISTOR DIGITAL TRANSISTOR DIGITAL TRANSISTOR TRANSISTOR		
Q203 Q203 Q204 Q204 Q204			2SC1740S(Q,R) 2SC2785(F,E) KTA1267(Y,GR) 2SA1175(F,E) 2SA933AS(Q,R)	TRANSISTOR TRANSISTOR TRANSISTOR TRANSISTOR TRANSISTOR		

L: Scandinavia K: USA P: Canada R: Mexico C: China I: Malaysia
Y: PX(Far East,Hawaii) T: England E: Europe G: Germany V: China(Shanghai)
Y: AAFES(Europe) X: Australia Q: Russia H: Korea M: Other Areas Δ indicates safety critical components.

HOW TO READ THE PARTS LIST

ABBREVIATION OF MODEL AND MASS PRODUCTION'S DESTINATIONS

COUNTRY ORIGIN	MODEL	ABB.	Canada		USA					
			P	K	K	K				
MALAYSIA	VR-505	5	P5	K5	-	-	X07-3310-10	X08-3060-10	X14-7250-10	-
	VR-506	6	P6	K6	-	-	X07-3310-11	X08-3060-11	X14-7250-11	-
	VR-517	1	P1	K1	-	-	X07-3330-10	X08-3060-11	X14-7250-12	-
	VR-507	7	P7	K7	-	-	X07-3300-10	X08-3060-12	X14-7260-10	X35-2250-10
	VR-509	9	P9	K9	X05-5150-11	X07-3290-11	X08-3060-13	X14-7260-11	X35-2250-11	
INDONESIA	VR-510	0	P0	K0	X05-5150-11	X07-3290-10	X08-3060-14	X14-7260-12	X35-2250-12	
	VR-505	5	P5	K5	-	-	X07-3380-13	X08-3070-10	X14-7310-10	-
	VR-506	6	P6	K6	-	-	X07-3380-12	X08-3070-11	X14-7310-11	-
	VR-517	1	P1	K1	-	-	X07-3380-14	X08-3070-11	X14-7310-14	-
	VR-507	7	P7	K7	-	-	X07-3380-11	X08-3070-02	X14-7310-12	-
	VR-509	9	P9	K9	X05-5520-10	X07-3380-10	X08-3070-13	X14-7310-13	X35-2270-11	
	VR-510	0	P0	K0	-	-	-	-	-	-

PARTS LIST

VR-505/506/507/509/510/517

VR-505/506/507/509/510/517

PARTS DESCRIPTIONS

CAPACITORS

CC 45 TH 1H 220 J
 1 2 3 4 5 6

- 1 = Type ... ceramic, electrolytic, etc.
- 2 = Shape ... round, square, ect.
- 3 = Temp. coefficient
- 4 = Voltage rating
- 5 = Value
- 6 = Tolerance

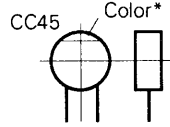

Capacitor value

- 010 = 1pF
- 100 = 10pF
- 101 = 100pF
- 102 = 1000pF = 0.001μF
- 103 = 0.01μF

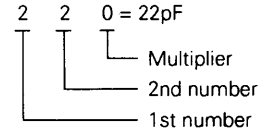

Temperature coefficient

1st Word	C	L	P	R	S	T	U
Color*	Black	Red	Orange	Yellow	Green	Blue	Violet
ppm/°C	0	-80	-150	-220	-330	-470	-750

2nd Word	G	H	J	K	L
ppm/°C	±30	±60	±120	±250	±500

Example : CC45TH = -470 ± 60ppm/°C

Tolerance (More than 10pF)

Code	C	D	G	J	K	M	X	Z	P	No code
(%)	±0.25	±0.5	±2	±5	±10	±20	+40 -20	+80 -20	+100 -0	More than 10μF -10 ~ +50 Less than 4.7μF -10 ~ +75

(Less than 10pF)

Code	B	C	D	F	G
(pF)	±0.1	±0.25	±0.5	±1	±2

Voltage rating

2nd word \ 1st word	A	B	C	D	E	F	G	H	J	K	V
0	1.0	1.25	1.6	2.0	2.5	3.15	4.0	5.0	6.3	8.0	-
1	10	12.5	16	20	25	31.5	40	50	63	80	35
2	100	125	160	200	250	315	400	500	630	800	-
3	1000	1250	1600	2000	2500	3150	4000	5000	6300	8000	-

Chip capacitors

(EX) C C 7 3 F S L 1 H 0 0 0 J
 1 2 3 4 5 6 7

(Chip) (CH, RH, UJ, SL)

(EX) C K 7 3 F F 1 H 0 0 0 Z
 1 2 3 4 5 6 7

(Chip) (B, F)

Refer to the table above.

- 1 = Type
- 2 = Shape
- 3 = Dimension
- 4 = Temp. coefficient
- 5 = Voltage rating
- 6 = Value
- 7 = Tolerance

Dimension (Chip capacitors)

Dimension code	L	W	T
Empty	5.6 ± 0.5	5.0 ± 0.5	Less than 2.0
A	4.5 ± 0.5	3.2 ± 0.4	Less than 2.0
B	4.5 ± 0.5	2.0 ± 0.3	Less than 2.0
C	4.5 ± 0.5	1.25 ± 0.2	Less than 1.25
D	3.2 ± 0.4	2.5 ± 0.3	Less than 1.5
E	3.2 ± 0.2	1.6 ± 0.2	Less than 1.25
F	2.0 ± 0.3	1.25 ± 0.2	Less than 1.25
G	1.6 ± 0.2	0.8 ± 0.2	Less than 1.0

RESISTORS

Chip resistor (Carbon)

(EX) R K 7 3 E B 2 B 0 0 0 J
 1 2 3 4 5 6 7

(Chip) (B, F)

Carbon resistor (Normal type)

(EX) R D 1 4 B B 2 C 0 0 0 J
 1 2 3 4 5 6 7

- 1 = Type
- 2 = Shape
- 3 = Dimension
- 4 = Temp. coefficient
- 5 = Rating wattage
- 6 = Value
- 7 = Tolerance

Dimension

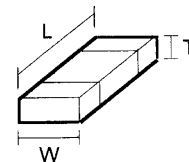

Dimension (Chip resistor)

Dimension code	L	W	T
E	3.2 ± 0.2	1.6 ± 0.2	1.0
F	2.0 ± 0.3	1.25 ± 0.2	1.0
G	1.6 ± 0.2	0.8 ± 0.2	0.5 ± 0.1

Rating wattage

Code	Wattage	Code	Wattage	Code	Wattage
1J	1/16W	2C	1/6W	3A	1W
2A	1/10W	2E	1/4W	3D	2W
2B	1/8W	2H	1/2W		

VR-505/506/507/509/510/517

SPECIFICATIONS

For U.S.A and Canada

AUDIO section (VR-506)

Rated power output during STEREO operation

100 watts per channel minimum RMS, both channels driven, at 8 Ω from 40Hz to 20 kHz with no more than 0.7% total harmonic distortion. (FTC)

Effective power output during SURROUND operation

FRONT (40-20kHz, 0.7% T.H.D. at 8 Ω one channel driven)	100 W + 100 W
CENTER (40-20kHz, 0.7% T.H.D. at 8 Ω one channel driven)	100 W
SURROUND (40-20kHz, 0.7% T.H.D. at 8 Ω one channel driven)	100 W + 100 W
Total harmonic distortion	0.050% (1 kHz, 50W, 8 Ω)
Frequency response	CD 10 Hz ~ 60 kHz, +0 dB, -3.0 dB
Signal to noise ratio (IHF'66)	PHONO (MM) 74 dB
	CD 90 dB
Input sensitivity / impedance	PHONO (MM) 2.5 mV / 27 k Ω
	CD 200 mV / 47 k Ω
	MONITOR IN (VIDEO2/MONITOR) 200 mV / 47 k Ω
	DVD/6ch INPUT 200 mV / 47 k Ω
Output level / impedance	TAPE REC 200 mV / 1 k Ω
	MONITOR OUT (VIDEO2/MONITOR) 200 mV / 1 k Ω
	PRE OUT (SUBWOOFER) 1.5 V / 2.2 k Ω
Tone control	BASS ± 10 dB (at 70 Hz)
	TREBLE ± 10 dB (at 10 kHz)

AUDIO section (VR-505/517)

Rated power output during STEREO operation

100 watts per channel minimum RMS, both channels driven, at 8 Ω from 40 Hz to 20 kHz with no more than 0.7% total harmonic distortion. (FTC)

Effective power output during SURROUND operation

FRONT (40-20kHz, 0.7% T.H.D. at 8 Ω one channel driven)	100 W + 100 W
CENTER (40-20kHz, 0.7% T.H.D. at 8 Ω one channel driven)	100 W
SURROUND (40-20kHz, 0.7% T.H.D. at 8 Ω one channel driven)	100 W + 100 W
SUBWOOFER (50Hz, 0.7% T.H.D. at 8 Ω one channel driven)	100 W
Total harmonic distortion	0.050% (1 kHz, 50W, 8 Ω)
Frequency response	CD 10 Hz ~ 60 kHz, +0 dB, -3.0 dB
Signal to noise ratio (IHF'66)	CD 90 dB
Input sensitivity / impedance	CD 200 mV / 47 k Ω
	MONITOR IN (VIDEO2/MONITOR) 200 mV / 47 k Ω
	DVD/6ch INPUT (VR-517) 200 mV / 47 k Ω
Output level / impedance	TAPE REC 200 mV / 1 k Ω
	MONITOR OUT (VIDEO2/MONITOR) 200 mV / 1 k Ω
	PRE OUT (SUBWOOFER) (VR-505) 1.5 V / 2.2 k Ω
Tone control	BASS ± 10 dB (at 70 Hz)
	TREBLE ± 10 dB (at 10 kHz)

DIGITAL AUDIO section

Sampling frequency	32 kHz, 44.1 kHz, 48 kHz, 96kHz
Input level / impedance / wave length	Optical (-15 dBm ~ -21 dBm), 660 nm ± 30 nm
	Coaxial 0.5 Vp-p / 75 Ω

VIDEO section

VIDEO inputs / outputs	VIDEO (composite) 1 Vp-p / 75 Ω
S VIDEO inputs / outputs (VR-506/517)	S VIDEO (luminance signal) 1 Vp-p / 75 Ω
	S VIDEO (chrominance signal) 0.286 Vp-p / 75 Ω

FM tuner section

Tuning frequency range	87.5 MHz ~ 108 MHz
Usable sensitivity (MONO)	1.3 μ V (75 Ω) / 13.2 dBf (75 kHz DEV., SINAD 30 dB)
50dB quieting sensitivity	STEREO 28 μ V (75 Ω) / 40.2 dBf
Total harmonic distortion (1 kHz)	MONO 0.5% (71.2 dBf input)
	STEREO 0.7% (71.2 dBf input)
Signal to noise ratio (1 kHz, 75 kHz DEV.)	MONO 75 dB (71.2 dBf input)
	STEREO 68 dB (71.2 dBf input)
Stereo separation (1 kHz)	40 dB
Selectivity (± 400 kHz)	70 dB
Frequency response	(30 Hz ~ 15kHz), +0.5 dB, -3.0 dB

AM tuner section

Tuning frequency range	10 kHz step 530 kHz ~ 1,700 kHz
Usable sensitivity (30% mod., S/N 20 dB)	16 μ V / (600 μ V/m)
Signal to noise ratio (30% mod. 1 mV input)	50 dB

GENERAL

Power consumption	2.6 A
AC outlet	SWITCHED (total 150 W, 1.25 A max.)
Dimensions	W : 440 mm (17-5/16")
	H : 143 mm (5-11/16")
	D : 400 mm (15-3/8")
Weight (Net)	VR-506/517 8.8 kg (19.82 lb)
	VR-505 8.7 kg (18.89 lb)

Notes

1. KENWOOD follows a policy of continuous advancements in development. For this reason specifications may be changed without notice.
2. The full performance may not be exhibited in an extremely cold location (under a water-freezing temperature).

VR-505/506/507/509/510/517

SPECIFICATIONS

AUDIO section (VR-507/509/510)

Rated power output during STEREO operation

100 watts per channel minimum RMS, both channels driven, at 8 Ω from 20 Hz to 20 kHz with no more than 0.7% total harmonic distortion. (FTC)

Effective power output during SURROUND operation

FRONT (20-20kHz, 0.7% T.H.D. at 8 Ω one channel driven)
..... 100 W + 100 W
CENTER (20-20kHz, 0.7% T.H.D. at 8 Ω one channel driven)
..... 100 W
SURROUND (20-20kHz, 0.7% T.H.D. at 8 Ω one channel driven)
..... 100 W + 100 W

Total harmonic distortion 0.055% (1 kHz, 50W, 8 Ω)

Frequency response

CD 10 Hz ~ 53 kHz, +0 dB, -3.0 dB

Signal to noise ratio (IHF'66)

PHONO (MM) 75 dB

CD 91 dB

Input sensitivity / impedance

PHONO (MM) 2.5 mV / 27 k Ω

CD 200 mV / 47 k Ω

MONITOR IN 200 mV / 47 k Ω

DVD / 6ch / INPUT (VR-507)..... 200 mV / 47 k Ω

Output level / impedance

TAPE REC 200 mV / 1 k Ω

MONITOR OUT 200 mV / 1 k Ω

PRE OUT (SUBWOOFER) 2 V / 2.2 k Ω

Tone control

BASS ± 10 dB (at 100 Hz)

TREBLE ± 10 dB (at 10 kHz)

DIGITAL AUDIO section

Sampling frequency 32 kHz, 44.1 kHz, 48 kHz, 96 kHz

Input level / impedance / wave length

Optical (-15 dBm ~ -21 dBm), 660 nm ± 30 nm

Coaxial 0.5 Vp-p / 75 Ω

VIDEO section

VIDEO inputs / outputs

VIDEO (composite) 1 Vp-p / 75 Ω

S VIDEO (luminance signal) 1 Vp-p / 75 Ω

(chrominance signal) 0.286 Vp-p / 75 Ω

FM tuner section

Tuning frequency range 87.5 MHz ~ 108 MHz

Usable sensitivity (MONO)

..... 1.6 μ V (75 Ω) / 15.2 dBf (75 kHz DEV., SINAD 30 dB)

50dB quieting sensitivity

STEREO 31.6 μ V (75 Ω) / 41.2 dBf

Total harmonic distortion (1 kHz)

MONO 0.6% (65 dBf input)

STEREO 0.7% (65 dBf input)

Signal to noise ratio (1 kHz, 75 kHz DEV.)

MONO 75 dB (65 dBf input)

STEREO 68 dB (65 dBf input)

Stereo separation (1 kHz) 38 dB

Selectivity (± 400 kHz) 70 dB

Frequency response (30 Hz ~ 15kHz), +0.5 dB, -3.0 dB

AM tuner section

Tuning frequency range

10 kHz step 530 kHz ~ 1,700 kHz

Usable sensitivity (30% mod., S/N 20 dB) 16 μ V / (600 μ V/m)

Signal to noise ratio (30% mod. 1 mV input) 50 dB

GENERAL

Power consumption 2.6 A

AC outlet

SWITCHED (total 150 W, 1.25 A max.)

Dimensions W : 440 mm (17-5/16")

H : 143 mm (5-5/8")

D : 400 mm (15-3/4")

Weight (Net) (VR-509/510)..... 7.2 kg (15.8 lb)

(VR-507)..... 8.8 kg (19.2 lb)

Notes

1. KENWOOD follows a policy of continuous advancements in development. For this reason specifications may be changed without notice.
2. The full performance may not be exhibited in an extremely cold location (under a water-freezing temperature).

Note:

Component and circuit are subject to modification to insure best operation under differing local conditions. This manual is based on Europe (E) standard, and provides information on regional circuit modification through use of alternate schematic diagrams, and information on regional component variations through use of parts list.

KENWOOD CORPORATION

14-6, Dogenzaka 1-chome, Shibuya-ku, Tokyo, 150-8501 Japan

KENWOOD SERVICE CORPORATION

P.O BOX 22745, 2201 East Dominguez St., Long Beach, CA 90801-5745, U.S.A.

KENWOOD ELECTRONICS CANADA INC.

6070 Kestrel Road, Mississauga, Ontario, Canada L5T 1S8

KENWOOD ELECTRONICS LATIN AMERICA S.A.

P.O BOX 55-2791, Piso 6 plaza Chase, Cl. 47 y Aquilino de la Guardia Panama, Republic de Panama

KENWOOD ELECTRONICS BRASIL LTDA.

Av. Moema, 170-17", Andar-Cobertura "B", Ed. Maximum Service Center, 04077-020 Moema, São Paulo-SP-Brasil

KENWOOD ELECTRONICS U.K. LIMITED

KENWOOD House, Dwight Road, Watford, Herts., WD1 8EB., United Kingdom

KENWOOD ELECTRONICS BELGUM N.V.

Meachelsesteenweg 418, B-1930 Zaventem, Belgium

KENWOOD ELECTRONICS DEUTSCHLAND GMBH

Rembrücker Str. 15, 63150 Heusenstamm, Germany

KENWOOD ELECTRONICS FRANCE S.A.

13 Boulevard Ney, 75018 Paris, France

KENWOOD ELECTRONICS ITALIA S.p.A.

Via G. Sirtori, 7/9 20129, Milano, Italy

KENWOOD IBÉRICA S.A.

Bolivia, 239-08020 Barcelona, Spain

KENWOOD ELECTRONICS AUSTRALIA PTY. LTD.

(A.C.N. 001 499 074)

16 Giffnock Avenue, North Ryde, N.S.W. 2113, Australia

KENWOOD ELECTRONICS (HONG KONG) LTD.

Unit 3712-3724, Level 37, Tower 1, Metroplaza, 223 Hing Fong Road, Kwai Fong N.T., Hong Kong

KENWOOD ELECTRONICS GULF FZE

P.O.Box 61318, Jebel Ali, Dubai, U.A.E.

KENWOOD ELECTRONICS SINGAPORE PTE LTD.

No. 1 Genting Lane #02-02, KENWOOD Building, Singapore, 349544

KENWOOD ELECTRONICS (MALAYSIA) SDN BHD.

#4.01 Level 4, Wisma Academy Lot 4A, Jalan 19/1 46300 Petaling Jaya Selangor Darul Ehsan Malaysia

KENWOOD ELECTRONICS (THAILAND) CO., LTD.

2019 New Pechburi Road, Bangkapi, Huaykwang, Bangkok, 10320 Thailand