



008954

# 'STEREO 20' POWER AMPLIFIER

INSTALLATION • OPERATION • MAINTENANCE

## OPERATION

1. The 'STEREO 20' may be fed from the 'VARISLOPE 2 STEREO' preamplifier or from any other suitable source. The LEAK pre-amplifier is supplied with a grey or brown multiple cable terminating in an octal plug which fits the socket on the 'STEREO 20' marked 'PRE-AMP' and automatically makes the input connections.
2. When the 'VARISLOPE 2 STEREO' pre-amplifier is not used the input connections should be taken via two screened co-axial cables to the plugs fitting the sockets marked 'INPUT L' and 'INPUT R'. Source impedances higher than 25,000 ohms will tend to raise the hum level above the advertised figure of 80db below 11 watts. An input of 125mV r.m.s. will give a power output of 11 watts.

## INSTALLATION

3. Check that all valves (tubes) are correctly seated in their holders and that the markings on the valves correspond with those on the chassis adjacent to the holders. The amplifier will work equally well with any of the alternative valves.
4. The amplifier should stand on its base in a well-ventilated position. If placed in a case or cabinet, ventilation must be provided. Four fixing feet are fitted to the amplifier, and these raise the bottom of the amplifier and allow air to circulate freely.
5. On the British model the mains transformer is tapped for voltages of 205, 225 and 245 and the voltage selector plug on top of the mains transformer (see 'TOP CHASSIS' drawing) should be set appropriately. On the U.S.A. model the mains transformer is tapped for voltages of 110, 117 and 124 and the voltage selector plug should be set appropriately. The A.C. power supply should be connected to the two terminals nearest the guide key on the removable plug portion of the mains connector marked 'A.C. POWER'. In order that the amplifier may be remotely controlled we have provided two terminals marked 'SWITCH' underneath the mains transformer (see 'UNDER CHASSIS' drawing). The amplifiers leave our factory with a wire link joining the terminals. A remote switch may be run from the switch terminals, the switch flex being passed through the adjacent grommet marked 'SWITCH CABLE'. This flex should be knotted behind the grommet and the wire ends connected to the switch terminals—after removing the wire link. Most users will wish to employ the switch incorporated in the volume control of the 'VARISLOPE 2 STEREO' pre-amplifier, which is supplied with a plug and twin flex for this purpose. Full details are given on the installation sheets which accompany every pre-amplifier.
6. A double socket marked 'A.C. OUTLETS' is fitted as a convenient source of power supply for gramophone motors, self-powered radio tuners etc. The power taken from this socket should be limited to 100 watts or thereabouts. This socket is not fused but is controlled by the amplifier switch.
7. A connection to earth (ground) should be taken from the third terminal on the removable plug portion of the 'A.C. POWER' connector. This terminal is the one furthest away from the guide key and its corresponding terminal on the fixed portion of the connector is marked on the chassis by the symbol  $\perp$ . It is very bad practice to omit this connection, which may be made to the water system or to the steel conduit encasing the house wiring, providing that these systems themselves are properly grounded. To ensure freedom from hum (caused by 'earth loops') no other earth connection should be made.
8. The loudspeakers should be connected by twisted pairs of wires to the terminals marked 'LOUDSPEAKER L' and 'LOUDSPEAKER R'. It will be seen from the circuit drawing that one side of the loudspeaker winding is connected to the chassis, and no part of the loudspeaker wiring should be earthed elsewhere. The D.C. resistance of the connecting wires should be as low as possible, and not more than one-tenth the D.C. resistance of the loudspeaker. It is a bad practice to operate any power amplifier without a loudspeaker, and if it is desired to mute either loudspeaker by switching it out of circuit this should be accomplished by use of a changeover switch which replaces it with a resistor of corresponding value and rating. If for any reason only one loudspeaker is to be used then a similar resistor should be connected across the loudspeaker terminals of the amplifier channel not in use. The selector plugs on top of the output transformers (see 'TOP CHASSIS' drawing) should be adjusted for the nearest match to the advertised impedance of the loudspeakers.
9. Some users may wish to connect (as a temporary measure) a single channel LEAK pre-amplifier to the 'STEREO 20'. Under these circumstances, the standard black multiple cable (supplied with the pre-amplifier) should be connected to the 'PRE-AMP' socket. The left-hand channel will be driven by this pre-amplifier and the right-hand channel should have a resistor of approximately 16 ohms ( $\frac{1}{4}$  watt) connected across its loudspeaker terminals.

## PHASING

10. It is vitally important that the diaphragms of your two loudspeakers move in phase, i.e. in the same direction at the same instant. To make sure of this note very carefully the following:—

- (i) If you are using identical loudspeakers (as you certainly should if you want true stereo) the manufacturer will doubtless have kept to a convention when marking the terminals, very often simply red and black. In this case the loudspeakers will be in phase when connected as shown below.

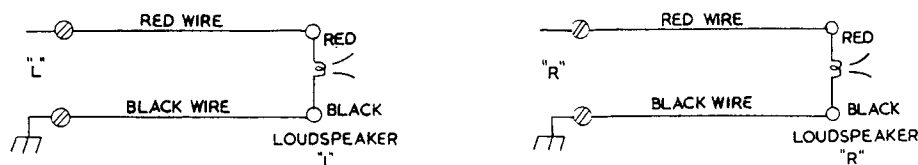

If your loudspeaker terminals are unmarked or you are using dissimilar loudspeakers you can check the phase as follows:—place the two loudspeakers as close together as possible; set the 'FUNCTION' switch to 'INPUT R' and the input selector to 'PICKUP'. Connect an unscreened length of wire (about 1 ft.) to the 'PICKUP R' socket. Turn 'BASS' control to maximum and then turn up 'VOLUME' control until the hum picked up by the unscreened lead is fairly loud. Then reverse the leads to *one* loudspeaker; the condition which gives you noticeably more bass hum is the correct connection, i.e. the loudspeakers are in phase.

- (ii) Most unfortunately, some manufacturers of stereo records and tapes were inconsistent over phasing. We have stereo records containing several bands where the signals change phase from band to band! The same is even true of a Hi-Fi demonstration tape! If you have these earlier records and tapes you will need to fit an external switch to reverse the phase of one of the loudspeakers, as shown below. You will find, when you operate the phase-change switch rapidly, that the correct position is obvious on most records, though less obvious on others: this is due to a combination of musical content and recording techniques. When musical signals are out of phase you will generally have a loss of stereo effect, a deficiency in bass reproduction and a 'hole in the middle' (the sound appears to come from each loudspeaker with little sound apparently coming from the area between them). With a good stereo system, properly phased, there is no 'hole in the middle' effect.

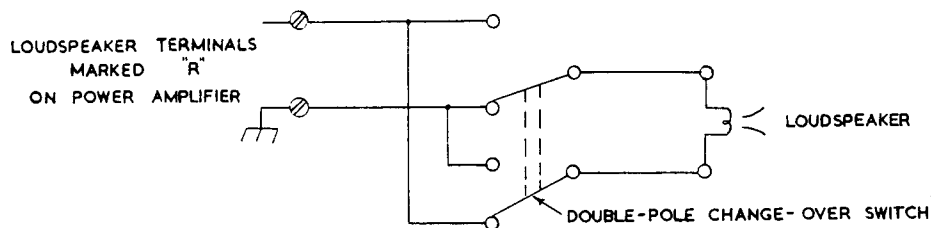

## MAINTENANCE

11. The circuit diagram provides a qualified engineer with all information required for servicing. However, the following points may be of interest:—

- (a) The 'STEREO 20' does not depend upon the output valves (tubes) being matched pairs to give the stated performance, and if one output valve fails it is not necessary to replace both valves.
- (b) Should it ever be necessary to replace the reservoir capacitor C13 (which is in the same can as C12) note that the C13 must be of a type capable of handling a ripple current of 190mA.

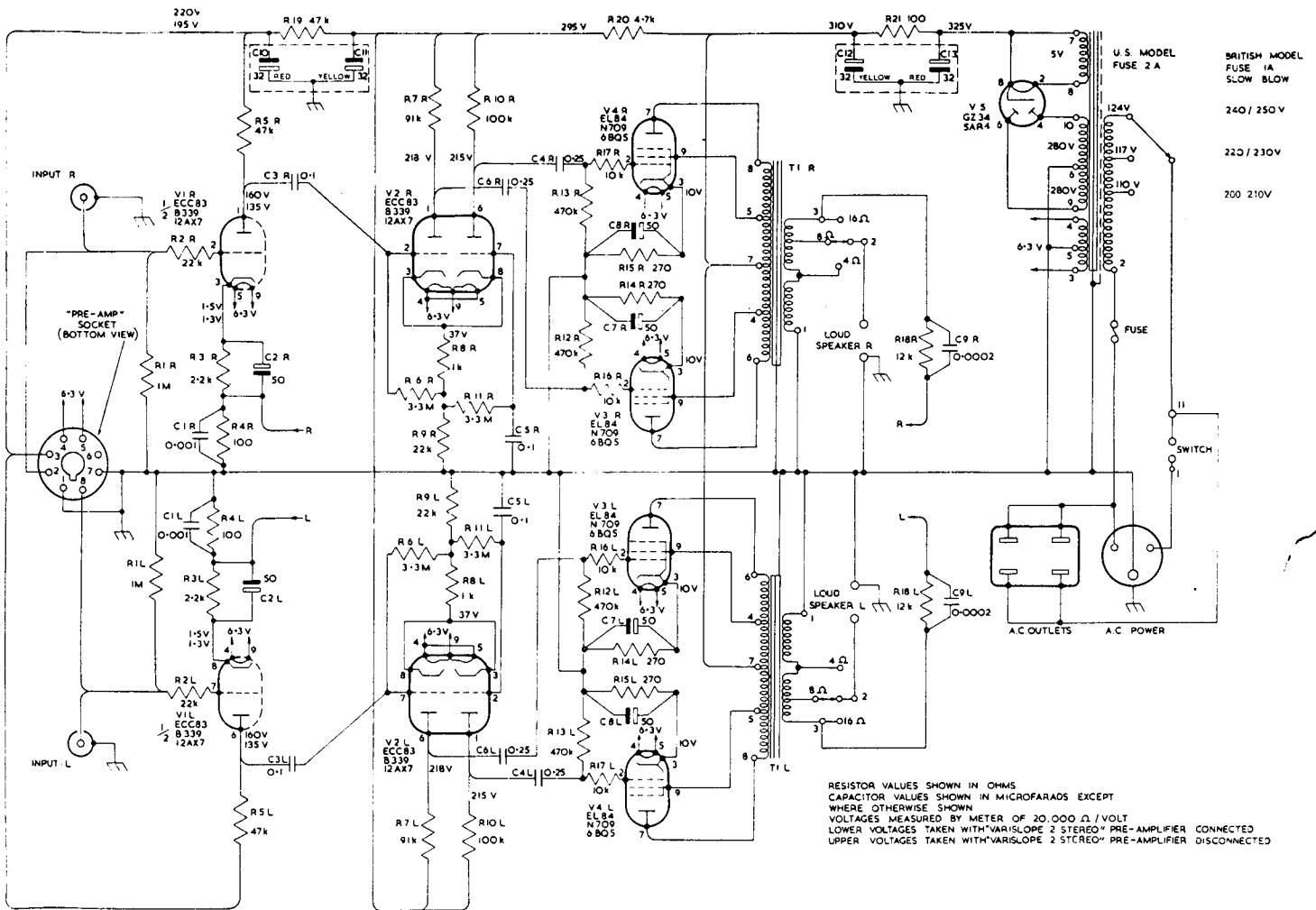

CIRCUIT DIAGRAM

TOP CHASSIS

UNDER CHASSIS

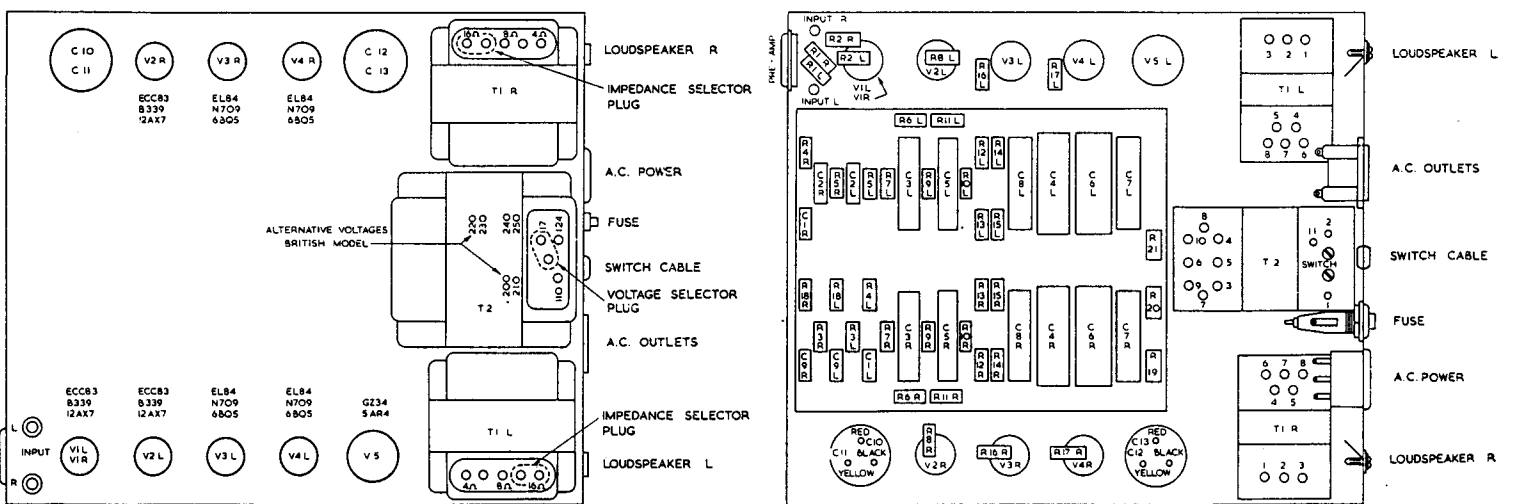

## A MAJOR LOUDSPEAKER INVENTION\*

THROUGHOUT the history of broadcasting and recording, certain exceptional developments have become milestones in the progress of sound reproduction.

ONE such milestone was the world's first very-low-distortion amplifier, the famous original Leak 'Point One', in 1945.

WE now pioneer another major breakthrough, the invention of the fantastically rigid 'Sandwich' cone diaphragm, which is demonstrably of great strength and hundreds of times stiffer than all conventional forms of cone. The photographs on this page illustrate the astonishing superiority of the Leak 'Sandwich' invention.

THE 'Sandwich' diaphragm is the invention of Donald A. Barlow, M.Sc., who leads the Leak Transducer Research Team. The theoretical treatise on his invention was given by Mr Barlow in the *Wireless World*, December, 1958.

TO understand the impact of this invention one must remember that to obtain low distortion the movement of a loudspeaker diaphragm or cone should follow as accurately as possible the waveform of the signals applied to its speech coil. The ability of the cone to follow these impulses accurately depends upon the LIGHTNESS and STIFFNESS of the cone assembly.

CONVENTIONAL cones (paper, impregnated fabric, plastics, aluminium) suffer from low stiffness. This results in significantly large areas of the cone vibrating in motions uncontrolled by the speech coil. These uncontrolled motions produce transient 'hangover', amplitude distortion (peaks and hollows in the frequency response) and intermodulation distortion (lack of clarity and spurious tones). These shortcomings are inherent in all direct-radiator loudspeaker systems using conventional cones, irrespective of cost.

ALL the above shortcomings of conventional cone loudspeakers are overcome by the Leak Piston-Action 'Sandwich' construction. Using engineering design principles as applied to air-frame construction, the 'Sandwich' cone comprises stiff aluminium skins for the outer surfaces where the stresses are greatest, bonded to a thick core of featherweight expanded plastic where the stresses are lowest, giving far greater stiffness than the same total weight of either material used separately. This use of the most suitable materials in optimum proportions and dispositions gives immense stiffness and rigid piston-action over a range of more than six octaves, and for the first time in audio history gives a direct-radiator diaphragm which reproduces the signal applied to the speech coil totally free from mechanical break-up and its associated distortions. The result is a remarkably smooth frequency response free from violent peaks or troughs over a very broad frequency range, indicative of excellent transient response (see graph below).

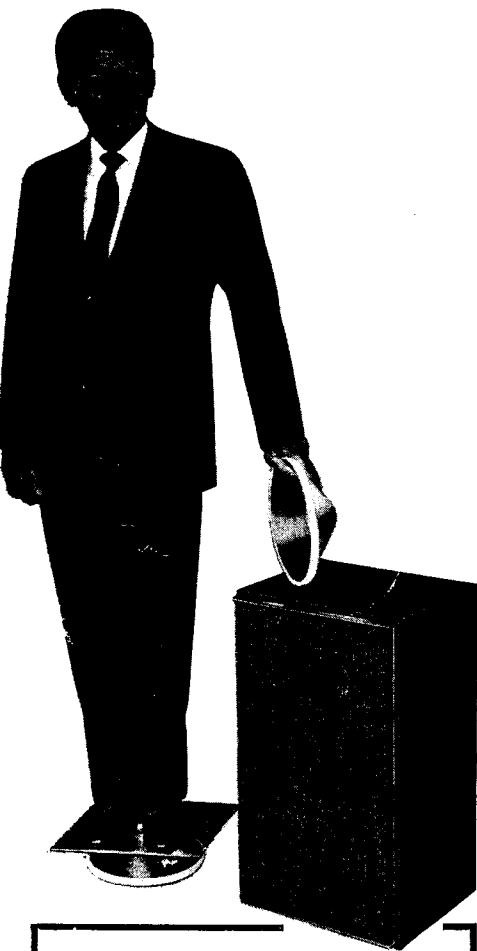

Harold J. Leak demonstrates immense stiffness of piston-action 'Sandwich' diaphragm which supports his weight below plate glass square.

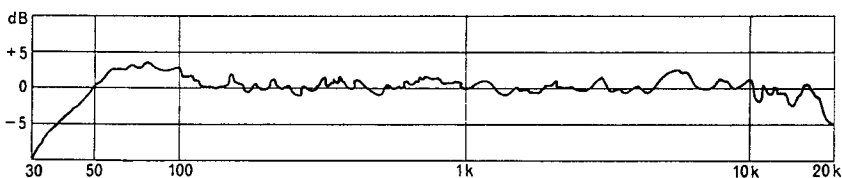

AXIAL PRESSURE RESPONSE OF 'SANDWICH' SYSTEM

The illustration shows a section of a paper cone flexing under the weight of one  $\frac{1}{2}$ d., and a section of the immensely stiff 'Sandwich' cone, which weighs the same as the paper cone supporting the weight of 100 halfpennies. The revolutionary Leak cone comprises two skins of very thin aluminium separated by a filler of very light plastic material expanded to a thickness of  $\frac{1}{8}$  inch.

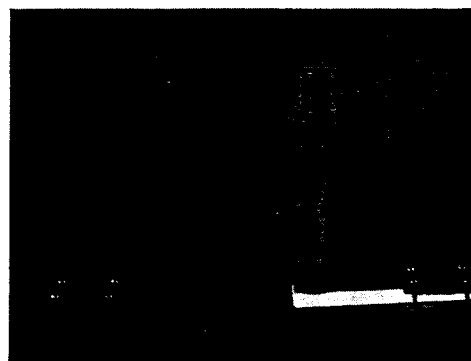

\* U.S. Patent Number 3,111,187 granted to applicants D. A. Barlow and H. J. Leak & Co., Ltd.

### H. J. LEAK & CO., LTD.

BRUNEL ROAD • WESTWAY FACTORY ESTATE • LONDON W.3

Telephone: SHEpherds Bush 1173 (Private Branch Exchange)

Telegrams: Inland: Sinusoidal, Ealux, London Foreign: Sinusoidal, London