



'STEREO 30 PLUS' INTEGRATED TRANSISTORISED AMPLIFIER

INSTALLATION • OPERATION • MAINTENANCE

IMPORTANT

Do not connect any AC/DC device (TV, Tape or Radio) to the 'Stereo 30 Plus' amplifier. These devices may have high AC potentials on their chassis capable of causing serious damage to the 'Stereo 30 Plus' amplifier.

INSTALLING THE 'STEREO 30 PLUS'

1. If you have bought the 'Stereo 30 Plus' already installed in the standard LEAK decorative wood case the mounting of the amplifier is completed.
If you have bought the 'Stereo 30 Plus' in chassis form it may be mounted in a LEAK tuner/amplifier wood case or on a panel of any thickness, through a cut-out of $12\frac{2}{16}'' \times 3\frac{5}{16}''$ (31.8×10 cms.). To mount on a panel: pass the body of the amplifier through the cut-out until the front plate butts against the panel, then pass the U-shaped bracket over the back of the amplifier and fix it by passing the wing screw through the hole in the bracket and into the threaded hank-bush in the centre of the rear panel on the amplifier. Tighten the wing screw just enough to prevent the front plate of the amplifier from slipping on the panel.
2. The mains transformer primary is wound for voltages of 110, 117, 130, 210, 230, 250 (40-60 Hz). The circular voltage selector (marked 'VOLTS' on the back of the amplifier) should be withdrawn to its fullest extent, rotated so that the arrow indicates the voltage nearest to your supply and then reinserted.
3. The amplifier is fitted with a 13-ft. (4-metre) power cable, either 2-core or 3-core according to the practice of the country to which it is shipped. This cable should be connected to the domestic power supply as follows :—
 - (a) 3-core cable. If the power supply socket has a third (earth) contact, the green/yellow wire should be connected to the corresponding pin on the power supply plug. The red or brown wire should be connected to the live pin (usually marked 'L') and the black or blue wire should be connected to the neutral pin (usually marked 'N').
If the socket has only two contacts then connect the red and black or brown and blue wires to the pins of the plug fitting this socket. Cut off the green/yellow lead and run a separate earth (ground) lead from the 'EARTH' terminal on the rear of the chassis to the water system or to the steel conduit encasing the house wiring, provided that these systems themselves are properly grounded.
 - (b) 2-core cable. The plug fitted to the power cable should be connected to the domestic power supply socket. A separate earth (ground) lead should be run from the 'EARTH' terminal on the rear of the chassis to the water system or to the steel conduit encasing the house wiring, provided that these systems themselves are properly grounded.
It is bad practice to omit this earth connection, and to ensure freedom from hum (caused by 'earth loops') no other earth connection should be made.
The amplifier is switched on by pressing the button marked 'POWER ON/OFF'.
4. Double sockets marked 'AC OUTLETS' are fitted as a convenient source of power supply for turntables, radio tuners or tape recorders. The power taken from these sockets should be limited to 100 watts or thereabouts. These sockets are not fused but are controlled by the amplifier switch.
5. The amplifier has been designed to operate under domestic conditions for the reproduction of speech and music anywhere in the world. Due to the very small amount of heat generated by the amplifier it is possible to mount the chassis model of the amplifier in a small cabinet and it is only necessary to ensure that the ventilating slots in the cover plates are unobstructed. Sinewave testing at full power output should be of short duration, particularly at high frequencies, otherwise overheating may occur and the 1.6A DC fuse may blow.
6. Fusing. In addition to the normal AC fuse and in order to give the amplifier maximum protection against abuse we have fitted a quick acting 1.6A DC fuse. Care should be taken to avoid shorting the loudspeaker leads as this may blow the fuse, but in order to cover this contingency we have supplied spare fuses which are fitted in the clips on the rear panel of the amplifier adjacent to the fuseholders.
7. Loudspeakers of any impedance from 4-15 ohms may be used and they should be connected to the plugs fitting the pair of sockets marked 'LOUDSPEAKERS 4-15 OHMS R and L'.

It will be seen from the circuit diagram that one side of the loudspeaker wiring is connected to the chassis, and no other part of the loudspeaker wiring should be earthed elsewhere.

If you wish to use a loudspeaker which has a built-in matching transformer (e.g. a full range electrostatic loudspeaker) it may be necessary to connect 2 ohm 2 watt resistors in series with one of the two leads connecting each loudspeaker to the 'Stereo 30 Plus' amplifier. Failure to connect these resistors may result in a form of low frequency instability depending on the characteristics of the matching transformer in the loudspeaker.

8. **Phasing.** It is vitally important that the diaphragms of your two loudspeakers move in phase, i.e. in the same direction at the same instant. To make sure of this note very carefully the following:—
First your loudspeaker cable must be colour coded, e.g. red and black. If you are using identical loudspeakers (as you certainly should if you want true stereo) the manufacturer will doubtless have kept to a convention when marking the terminals, very often simply red and black. In this case the loudspeakers will be in phase when connected as shown below.

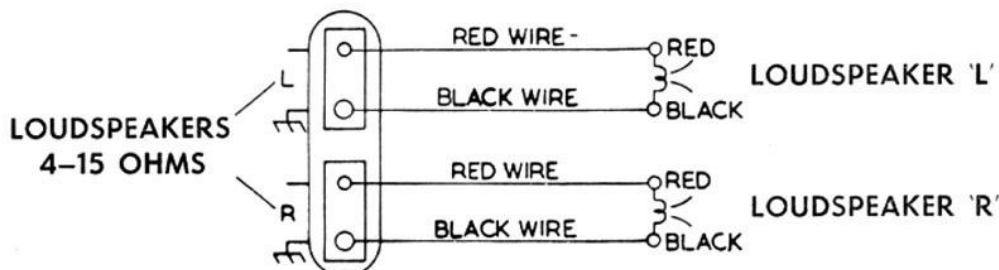

If your loudspeaker terminals are unmarked or you are using dissimilar loudspeakers you can check the phase as follows: place the two loudspeakers as close together as possible; depress the button marked 'INPUT R' and set the input switch to 'PICKUP 1'. Connect an unscreened length of wire (about 1ft.) to the 'PICKUP 1 R' socket. Turn 'BASS' control to maximum and then turn up 'VOLUME' control until the hum picked up by the unscreened lead is fairly loud. Then reverse the leads to **one loudspeaker**; the condition which gives you noticeably more bass hum is the correct connection, i.e. the loudspeakers are in phase.

9. **'PHONES'.** A 3-contact jack socket is provided on the front panel to enable the user to connect a pair of stereo headphones for personal listening when it is not desired to use a pair of loudspeakers. The 'Stereo 30 Plus' is despatched from the factory with a dummy plug inserted in this jack socket to balance the panel layout and improve the appearance of the amplifier. If you wish to use headphones then pull out the dummy plug and insert the headphone jack plug. We have wired this 3-contact jack socket to conform to the usual practice adopted by headphone manufacturers, i.e., the left channel output is connected to the 'tip', the right channel output is connected to the 'ring' and the common connection to both channels is connected to the 'sleeve'. If the headphones you possess are not terminated in a 3-contact jack plug then a plug of this type should be obtained from your radio dealer and connected as shown below:—

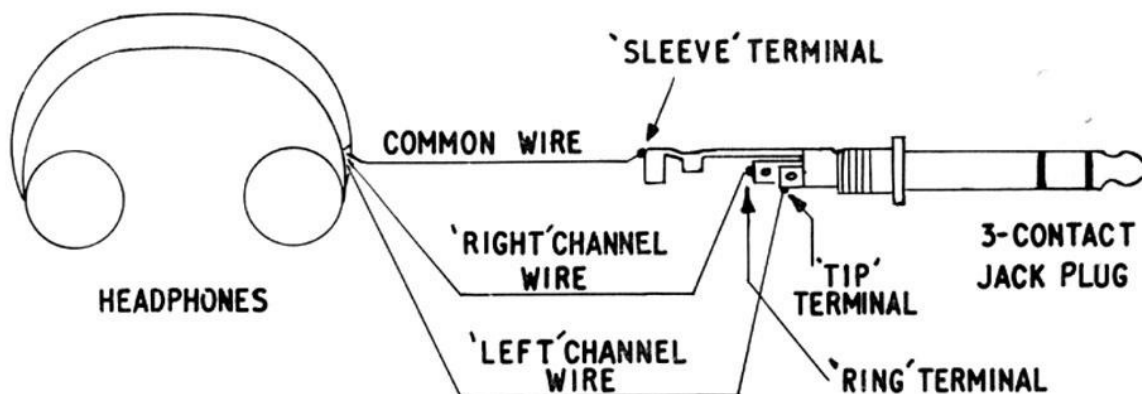

If your stereo headphones are supplied with a four wire output lead, one lead from the 'right' headpiece and one lead from the 'left' headpiece should be joined and connected to the 'sleeve' termination. The correct phasing of the signals from your stereo headphones is very important and in all probability the manufacture of the headphones will have indicated which leads should be joined together and taken to the 'sleeve' termination. Should this information not be available then proceed as in paragraph 8 above—reversing the connections to one headpiece when the condition which gives noticeably more bass hum will be correct.

Two 100 ohm resistors (R56L and R56R) are wired in series with the 'L' and 'R' headphone connections to enable most headphones to be directly connected to the socket. If, however, the headphones that you are using do not give satisfactory results it may be necessary to connect another resistor across each headphone, or to alter the value of the resistors that have been fitted inside the 'Stereo 30 Plus' amplifier. This is because the impedance and sensitivity of headphones varies considerably between the manufacturers.

OPERATING THE 'STEREO 30 PLUS'

10. BALANCE CONTROL

The 'BALANCE' control allows you to compensate for differences in sensitivity between loudspeakers, or the 'L' and 'R' sides of any stereo input device. The gain in each channel is identical when the pointer on the 'BALANCE' control knob is at 12 o'clock. A further function of the 'BALANCE' control is mentioned in paragraph 19.

11. VOLUME CONTROL

The input attenuator switches marked 'GAIN HI-LO' on the rear panel of the 'Stereo 30 Plus' should be set so that a normal level of reproduction is obtained with the main 'VOLUME' control set to 9 o'clock or higher. It is better not to listen with the 'VOLUME' control below 9 o'clock, as the channel balance below this setting may vary excessively.

12. FUNCTION SELECTOR

A four position switch allows the choice of :—

- (i) 'MONO'—the 'L' and 'R' inputs are connected in parallel: normally you will use this position **only** when you play a mono record when using a stereo pickup.
- (ii) 'STEREO'.
- (iii) 'INPUT R'—mono reproduction is obtained from both loudspeakers from the signal connected to the input socket marked 'R'.
- (iv) 'INPUT L'—mono reproduction is obtained from both loudspeakers from the signal connected to the input socket marked 'L'.

13. NOISE (Hum and Hiss)

The 'Stereo 30 Plus' has a very low noise level which can be checked by removing all the input plugs and turning up the 'VOLUME' control. The connection of any input device to the input sockets will lower the input impedance and should, therefore, reduce the noise level. This is particularly true when using the 'PICKUP 1' input. If the hum level increases on making input connections, the cause of the hum must lie outside the amplifier, and our instructions on the connection of various input devices should be read carefully in an attempt to locate the cause. The high-pitched hiss associated with vacuum tube amplifiers is less noticeable with transistors, the irreducible noise being lower in pitch and unobtrusive.

N.B. When connecting an input plug to the 'Stereo 30 Plus' ensure that the screening of the co-axial lead does not touch the chassis of the amplifier as this may cause excessive hum.

CONNECTING STEREO PICKUPS

- (a) The greatest care has been taken in the design of this amplifier to ensure that any pickup generally available in the world can be connected to give optimum results, i.e. the highest quality obtainable from the chosen make of pickup. Our prime aim is for you to obtain optimum results from the pickup of your choice.
- (b) The pickup should be connected via screened co-axial cables to the sockets marked 'PICKUP 1' or 'PICKUP 2' at the rear of the 'Stereo 30 Plus', as shown below.

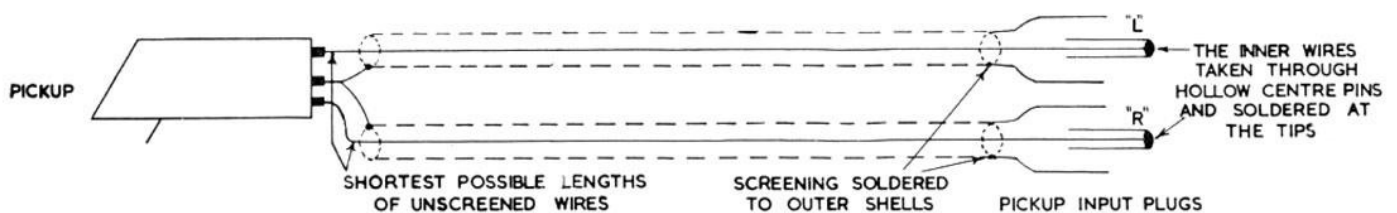

- (c) Some pickups will be fitted with two inner conductors covered by one outer screening; in this case the user should make sure that the screening of both inner conductors is maintained right up to the plugs fitting the sockets marked 'PICKUP 1' or 'PICKUP 2', as shown below.

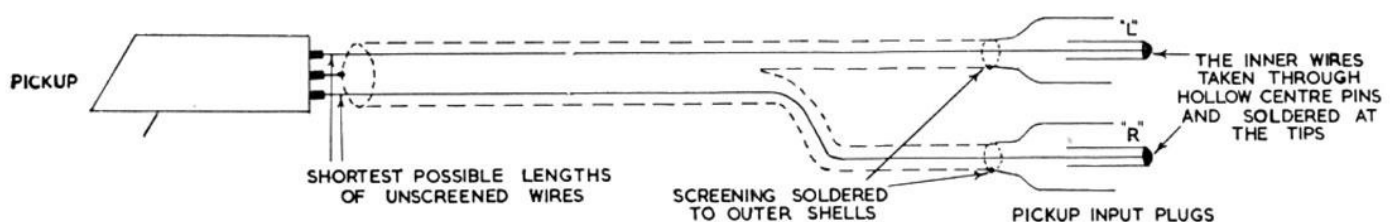

- (d) We know from experience that the main troubles encountered by the music-lover at home are with the reproduction of records. There are five major reasons for these troubles :—
- (i) No record can possibly give perfect reproduction, and many records (perhaps the majority) contain noticeable distortions due to imperfections in recording and/or processing. These imperfections may show up as 'rattle', high surface noise, recorded hum and rumble and recorded 'wow'. Shrill treble may be due to a poor record, or to a pickup having its high-frequency resonance within the audible range, or to inferior loudspeakers.
 - (ii) No pickup is perfect and many have performances **very much** below those which are attainable.
 - (iii) Hum. This often arises because insufficient attention is given during the design of a pickup to the commonly-found circumstances in which it will operate, i.e. near an electric motor and near a power amplifier. Hum can also arise from incorrect connection of the pickup by the user.
 - (iv) 'Rumble'. Vibration from the motor is transmitted to the pickup stylus and appears in the sound output as a rumbling or humming noise. Rumble disappears when the pickup is lifted from the record.
 - (v) Acoustic feedback. If a loudspeaker is placed in the same cabinet as a pickup, then vibration from the movement of the loudspeaker can be transmitted to the stylus of the pickup. As the volume is increased a stage is reached where a sustained roaring noise is set up. At volume levels considerably below this point distortion is noticeable. Acoustic feedback disappears when the pickup is lifted from the record.
- (e) The matching of stereo pickups.
- (i) Low-output moving-magnet, moving-coil or variable-reluctance pickups.
The above types should be connected to the 'PICKUP 1' input sockets, which have an input sensitivity of 2mV and an input impedance of 47k ohms.
 - (ii) Higher output moving-magnet, moving-coil or variable-reluctance pickups.
The above types should be connected to the 'PICKUP 2' input sockets setting the associated gain switch to 'HI'. The input sensitivity is 10mV and the input impedance is 33k ohms.
 - (iii) Crystal and Ceramic pickups.
The above types should be connected to the input sockets marked 'PICKUP 2', setting the associated gain switch to 'LO'. The input sensitivity is 30mV and the input impedance is 100k ohms. The input loading under these conditions forces this type of pickup to give approximately the same frequency characteristic as moving-coil and variable-reluctance pickups. This type of pickup may be accompanied by recommendations that a high input impedance (1 megohm) should be used ; these instructions must be disregarded as they apply only when you are using an amplifier which does not incorporate record compensation. If more bass is desired you should insert a 100k ohm resistor in series with each 'live' pickup input lead. As these resistors can pick up hum unless screened, we strongly recommend that you solder the resistors to the co-axial input sockets inside the amplifier.

OPERATING THE CONTROLS WHEN PLAYING RECORDS

15. (a) The 'RIAA' (same as British Standard 1928/61 for Fine Groove Records) playback characteristic has been incorporated in the 'Stereo 30 Plus' as this is an internationally agreed standard, and has been in world-wide use since 1955 for 33 and 45 rpm records. This characteristic does not take into account the acoustics of the recording studio, the position of the microphones relative to the artistes, your pickup, your loudspeaker systems, the acoustics of your room and your particular ears ! In other words, the playback characteristic is of use only as an approximation, and it may well be necessary to adjust the final result by using the controls marked 'BASS' and 'TREBLE' ; this is the reason for their presence. When playing LP records (33 and 45 rpm) made prior to 1955 the bass and treble controls may be used to correct for differences in the recording characteristic.
When playing European 78 records the 'TREBLE' control should, theoretically, be turned to 2 o'clock and the bass control to 11 o'clock but, here again, you may prefer the results with the controls at 12 o'clock !
- (b) When the switch marked 'TREBLE FILTER' is switched 'ON' a filter is incorporated in the 'Stereo 30 Plus' circuit which gives further control of the treble frequencies. The turnover frequency is 6 kHz (i.e. the frequency at which the response falls 3dB) and the rate of attenuation above this frequency is 12dB per octave.
This filter should not be required in normal use but will prove beneficial when reproducing music in which there is high distortion at high frequencies, for it is then possible to remove much of the offensiveness whilst losing a minimum of the musical content.

(c) **BASS CONTROL**

Consumer opinion in some countries insists on a magnitude of available bass boost which, if used at maximum, can only result in a travesty of the original music. We have provided you with an availability of bass boost which you certainly should not need if your pickup and loudspeakers are moderately good. It is not possible to obtain **true** bass from small loudspeaker systems by turning the 'BASS' control to maximum, though an intermediate setting may be helpful, particularly when listening at low intensity levels (as in an apartment late at night).

GRAMOPHONE (PHONOGRAPH) MOTORS OR TURNTABLES

16. The main trouble with cheaper turntables and record changers is vibration, which is transmitted to the pickup stylus and appears in the sound output as a low-pitched 'rumble'. This 'rumble' will be more obtrusive when reproducing from stereo records because a stereo pickup is sensitive to vertical vibrations. Expensive transcription turntables are relatively free from 'rumble' because they are more precisely engineered than mass-produced units.

The 'Stereo 30 Plus' incorporates a fixed high-pass filter which sharply attenuates the low frequency response of the amplifier below 20 Hz. This removes all unwanted signals which do not contribute any useful information and may cause audible interference or amplifier overload at subsonic frequencies (the turn-over frequency is 17 Hz and the attenuation rate is 18dB per octave).

This filter minimises the effect of 'rumble' and 'acoustic feedback' (see 14 (d) (iv)), but its incorporation in the 'Stereo 30 Plus' is no substitute for a first-class transcription turntable.

CONNECTING STEREO TUNERS

17. We have designed the 'Stereo 30 Plus' amplifier to operate from any stereo tuner generally available in the world. To provide this degree of flexibility there are two tuner inputs, 'TUNER 1/MIC' and 'TUNER 2'.

When using a low output tuner, like the 'TROUGH LINE STEREO', the tuner output leads should be connected to either the 'TUNER 1/MIC' input sockets which have an input sensitivity of 25mV, or the 'TUNER 2' input sockets with the 'TUNER 2' input attenuator set to 'HI' when the input sensitivity will be 60mV.

When using a high output tuner the output leads should be connected to the 'TUNER 2' input sockets with the associated input attenuator set to 'LO' when the input sensitivity will be 250mV.

When a tuner is used a separate earth (ground) connection should **not** be made to the tuner as this will be effected by the screening of the co-axial cable connecting the tuner output to the amplifier input.

For other uses for the 'TUNER 1/MIC' input sockets see paragraph 18.

CONNECTING STEREO MICROPHONES

18. Any dynamic (moving-coil or ribbon) microphones, together with their associated matching transformers, may be plugged into the sockets marked 'TUNER 1/MIC'. The sensitivity of the amplifier will need to be raised and this can easily be done by cutting the only two white links of wire on the input switch (see circuit diagram and chassis layout). For stereo operation you must follow the makers recommendations on the positioning of the microphones.

CONNECTING MONO TUNERS, PICKUPS & MICROPHONES

19. These input devices may be connected via a screened co-axial cable to either the right or left-hand socket of the appropriate input. The unwanted channel can then be muted by full rotation of the 'BALANCE' control. If, however, mono reproduction is required through both channels then switch the 'FUNCTION' selector to 'INPUT R' or 'INPUT L', when the appropriate input socket will feed both channels simultaneously. When a tuner is used a separate earth (ground) connection should **not** be made to the tuner as this will be effected by the screening of the co-axial cable connecting the tuner output to the amplifier input.

CONNECTING TAPE RECORDERS

20. In general, any normally designed tape system can be connected, via screened cables, to the co-axial sockets marked 'REPLAY' on the rear of the 'Stereo 30 Plus' for replay purposes, or to the sockets marked 'RECORD' for recording purposes.

The following points should be noted :—

- (a) An earth (ground) connection should not be made to the tape recorder, as this may cause an 'earth loop' and hum. The recorder will be earthed automatically through the 'Stereo 30 Plus' amplifier.

- (b) For replay purposes the input switch should be set to 'REPLAY'.
- (c) For recording purposes the input switch should be turned to the input from which it is desired to record.
- (d) The 'FUNCTION', 'BASS', 'TREBLE' and 'TREBLE FILTER' controls are operative when recording or replaying.
- (e) The output level (which is unaffected by the 'BALANCE' or 'VOLUME' controls) from the 'RECORD' sockets on the 'Stereo 30 Plus' will be approximately 400mV and normally these sockets should be connected to the low sensitivity inputs on the tape recorder, which should have an input impedance of at least 50k ohms.
- (f) TAPE MONITOR

If you use a tape recorder having a separate replay head and separate recording and replay amplifiers, it is possible for you to compare instantaneously the original signals being fed to the tape recorder with the recorded signals taken from the tape immediately after recording.

With the 'TAPE MONITOR' switch 'OFF' the loudspeakers reproduce the signals being fed to the tape recorder. With the 'TAPE MONITOR' switch 'ON', the signals from the tape replay amplifier will be fed via the 'VOLUME' control and the power amplifier sections of the 'Stereo 30 Plus' to the loudspeakers. The 'RECORD' sockets will continue to feed steady recording signals (unaffected by the 'VOLUME' or 'BALANCE' controls) to the tape recorder.

N.B. THIS SWITCH MUST BE SET TO 'OFF' IN ORDER THAT THE AMPLIFIER MAY FUNCTION NORMALLY. ONLY SWITCH TO 'ON' FOR MONITORING PURPOSES WHILST MAKING A TAPE RECORDING AS DETAILED ABOVE.

SERVICING

21. The 'Stereo 30 Plus' amplifier is manufactured in a form which simplifies servicing. Each amplifier channel is built on two printed circuit boards, a pre-amplifier section and a power amplifier section. The output transistors for both channels are separately clamped to the aluminium heat sink/chassis and insulating bushes and washers are used to prevent electrical contact between the case of the transistor and the heat sink/chassis.

If a fault does occur on the 'Stereo 30 Plus' amplifier then it should be possible to localise the trouble to either the right or left channels and to further localise the fault into the power amplifier or the pre-amplifier section (see paragraph 22).

To remove any of the four printed circuit boards it is necessary to lift the printed circuit board fixing clamp (for location see chassis layout) which is under spring tension and rotate the clamp through 90 degrees. The clamp will then rest in-between the printed circuit boards and the boards may easily be withdrawn. The faulty board can then be changed, or if a replacement is not readily available then the faulty board can be returned to the factory for servicing.

Even after the amplifier guarantee period has expired a faulty board, or complete amplifier, may still be returned to the factory when servicing will be carried out efficiently and at a reasonable cost to the user.

GUIDE TO FAULT LOCATION

22. (a) If the fault which occurs is excessive hum, noise or distortion and it is only present on one specific input (i.e. 'PICKUP', 'TUNER', etc.) and not present on the other inputs then the fault is most likely to be due to the input device and not the amplifier. In this case, the connecting leads of the suspect input device should be examined for bad joints; if this fails to locate the trouble the input device should be retested by your supplier or the device manufacturer.
- (b) If the fault is present on all inputs then first rotate the 'BALANCE' control fully clockwise and listen for the hum, noise or distortion, and if this is present then this indicates that the fault is in the left channel. Now rotate the 'BALANCE' control fully anti-clockwise and if the hum, noise or distortion is present this indicates that the fault is in the right channel. If the fault occurs in both channels the likelihood is that either the power supply section of the 'Stereo 30 Plus' amplifier is at fault, or the input device (pickup or tuner, etc.) is faulty, see 22 (a).
- (c) Hum and Noise.

If the fault is excessive hum or noise and it is only present on one channel then turn the 'BALANCE' control so that you are listening to this channel and turn the 'VOLUME' control fully anti-clockwise. If the hum or noise remains then the power amplifier section is at fault.

If, however, the hum or noise only occurs as the 'VOLUME' is advanced then remove all input plugs and if the hum or noise still remains the preamplifier section is at fault. If on removing the input plugs the hum or noise disappears then this indicates a faulty input device, see 22 (a).

- (d) Distortion.

If the fault is distortion then listen carefully and if the distortion only occurs at high volume levels then the power amplifier section is probably the cause.

If, however, the distortion is present at all volume levels and on all input signals from your pickup or tuner, etc. then the pre-amplifier section is probably the cause. It is also possible that the pre-amplifier is being overloaded by an excessive input signal.

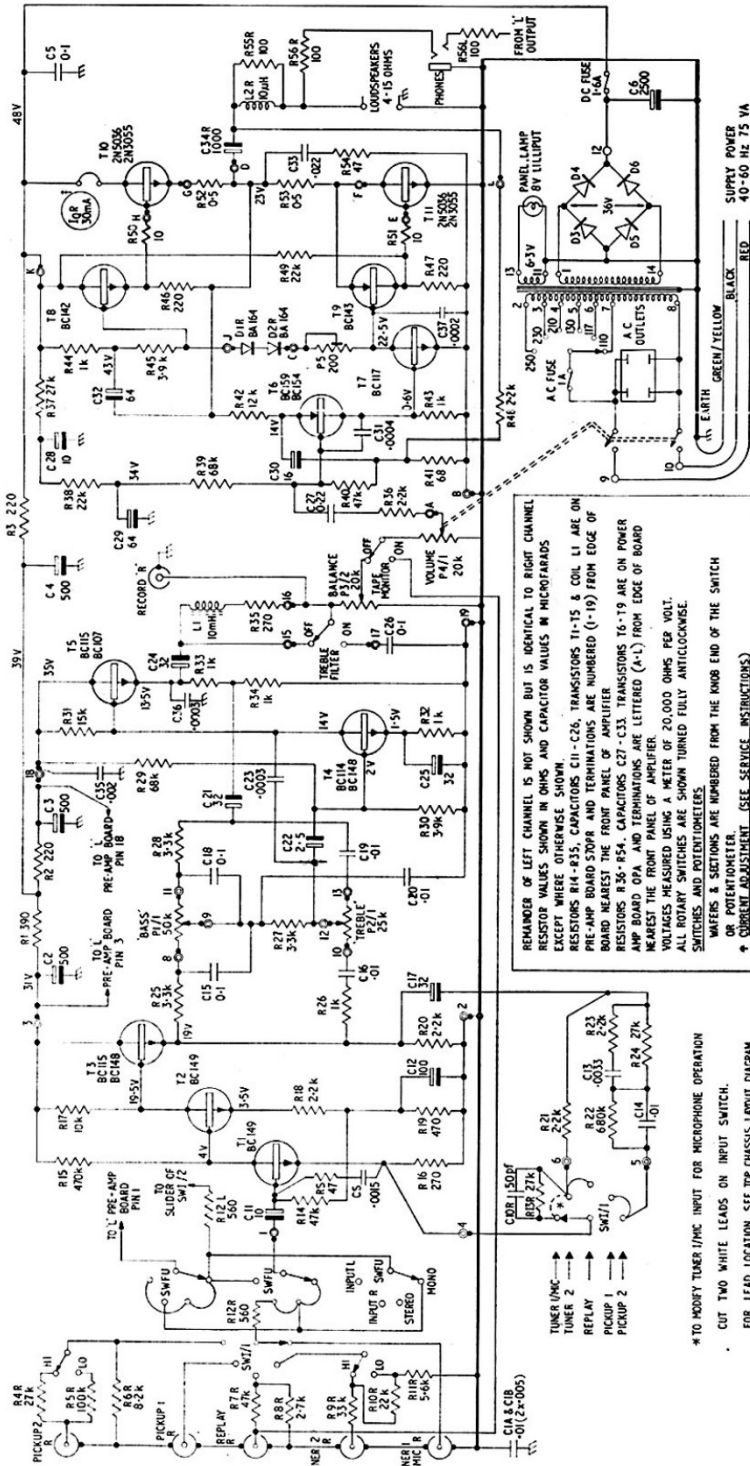

REMARKS OF LEFT CHANNEL IS NOT SHOWN BUT IS IDENTICAL TO RIGHT CHANNEL EXCEPT WHERE OTHERWISE SHOWN.
 RESISTORS R14-R35, CAPACITORS C11-C26, TRANSISTORS T1-T5 & COIL L1 ARE ON PRE-AMP BOARD STOP AND TERMINATIONS ARE NUMBERED (1-15) FROM EDGE OF BOARD NEAREST THE FRONT PANEL OF AMPLIFIER.
 RESISTORS R36-R54, CAPACITORS C27-C33, TRANSISTORS T6-T9 ARE ON POWER AMP BOARD OPA, AND TERMINATIONS ARE LETTERED (A-L) FROM EDGE OF BOARD NEAREST THE FRONT PANEL OF AMPLIFIER.
 ALL BATTERY SWITCHES ARE SHOWN TURNED FULLY ANTICLOCKWISE.
 SWITCHES AND POTENTIOMETERS ARE NUMBERED FROM THE DMB END OF THE SWITCH OR POTENTIOMETER (SEE SERVICE INSTRUCTIONS).
 † CURRENT ADJUSTMENT (SEE SERVICE INSTRUCTIONS).
 ‡ I.G.R. AND T.O.L. MUST BE SET BETWEEN 30-55 mA BY ADJUSTING P5R AND P5L.
 N.B. DO NOT SWITCH ON AMPLIFIER WITH I.G.R. OR T.O.L. SHORTING LEADS ENGAGED.

* TO MODIFY TUNER/MIC INPUT FOR MICROPHONE OPERATION
 CUT TWO WHITE LEADS ON INPUT SWITCH.
 FOR LEAD LOCATION SEE TOP CHASSIS LAYOUT DIAGRAM

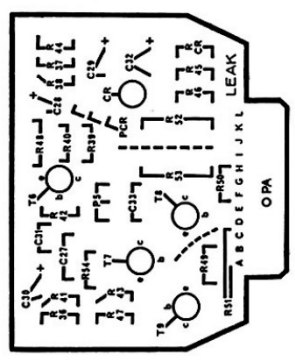

POWER AMPLIFIER CIRCUIT BOARD LAYOUT DIAGRAM

TOP CHASSIS LAYOUT

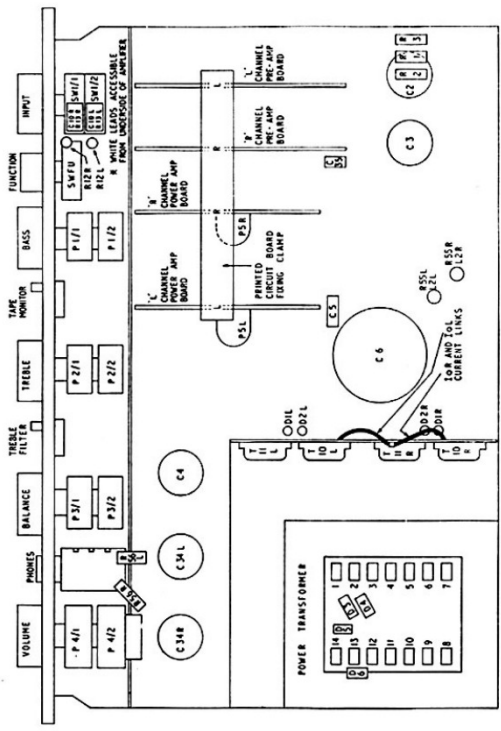

8

CIRCUIT DIAGRAM

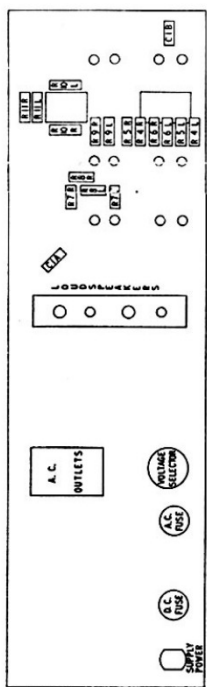

INSIDE VIEW OF REAR FACE

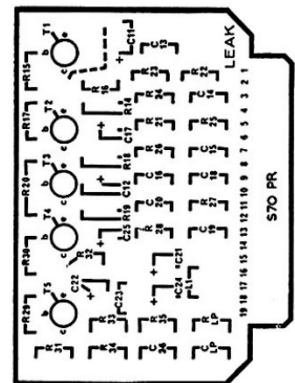

PRE-AMPLIFIER CIRCUIT BOARD LAYOUT DIAGRAM

7

INSTRUCTIONS TO SERVICE ENGINEERS

23. (a) COMPONENT LAYOUT.

- (i) Components not shown in layout diagram are mounted on the printed circuit boards as indicated on the circuit diagram. If access is required to components on the inside of the rear face of the chassis then capacitors C2, C3, C6 and C7 can be removed easily by unscrewing the fixing bolts on the underside of the chassis.
- (ii) When removing components from a printed circuit board care must be taken to avoid overheating the copper foil as this may damage the adhesion. We suggest that you use a small-bit instrument type soldering iron.
We have **not** crimped the component leads and they can be removed easily from the board if the solder around the lead is melted.
- (iii) When removing transistors from the printed circuit board the body of the transistor should be gently pulled at the same time as applying the soldering iron to the soldered connections on the underside of the board.
- (iv) When removing horizontally mounted components the body of the component should be gently prised at one end and in this manner the lead-out wires removed one at a time.
- (v) When removing vertically mounted components the centre terminal should be unsoldered and the component gently pulled away from the board. The side wire can then be removed more easily.

(b) CURRENT ADJUSTMENTS IQL and IQR.

- (i) The quiescent (no-drive) current in the output stages of the 'Stereo 30 Plus' amplifier has been set at the factory at 30mA and it should not be necessary to reset this current unless a driver transistor (T8 or T9), or an output transistor (T10 or T11) has been replaced.
- (ii) To readjust quiescent current. Two red flexible 'current links' (see layout diagram) connect the collectors of T10L and T10R to the 48V line, and these wire links should be disconnected and an ammeter inserted (positive terminal to 48V line) to measure the quiescent current of the output transistors. The quiescent current can then be readjusted to 30mA by resetting P5L or P5R; the location of each is shown on the layout diagram.

N.B.—Do not switch on the amplifier without current links or ammeters in place as this will damage the driver transistors.

(c) PRECAUTIONS.

- (i) Avoid shorting loudspeaker leads while driving the amplifier as this may blow the DC fuse.
- (ii) When testing the amplifier it is better not to sustain full-power sine-wave drive for longer than two minutes, particularly at high frequencies, as this will overheat the output and driver transistors and may cause the DC fuse to blow.
- (iii) Do not short together the lead-out wires of the transistors as this will cause failure of the transistor, particularly under drive conditions.
- (iv) Do not switch on the amplifier with the current links removed as damage to the driver transistors will be caused (see Current Adjustments 23b).

(d) TRANSISTORS.

The transistor types used are shown on the circuit diagram and other replacement types should not be used unless full facilities for testing the amplifier are available.

(e) DIODES.

The bridge type of rectifier that we use is made from four discrete silicon diodes each having an average current rating of 0.75A and a peak inverse voltage rating of 200V.

SPECIFICATION

POWER OUTPUT (both channels sine-wave driven at 1 kHz):

- 15 watts rms each channel into 8 ohm loudspeakers.
- 10 watts rms each channel into 15 ohm loudspeakers.

TOTAL HARMONIC DISTORTION :

- 0.1% for ALL power levels up to 10 watts rms each channel at 1 kHz into 8 ohm loudspeakers.
- or
- 8 watts rms each channel at 1 kHz into 15 ohm loudspeakers.

DAMPING FACTOR :

- 40 measured at 1 kHz for 15 ohm loudspeakers.
- 20 measured at 1 kHz for 8 ohm loudspeakers.

INPUT SENSITIVITIES :

The sensitivities shown below give 15 watts output at 1 kHz into 8 ohm loudspeakers with tone controls at 12 o'clock and the volume control on maximum.

'PICKUP 1' (RIAA Characteristic):	2mV		
Input impedance :	47k ohm		
'PICKUP 2' (RIAA Characteristic):	10mV	or	30mV
Input impedance :	33k ohm		100k ohm
Selected by switched input attenuator marked 'HI' and 'LO' located on the rear panel.			
'TUNER 1/MIC':	25mV	or	2mV
Input impedance :	47k ohm		47k ohm
Selected by cutting white leads on input switch, see paragraph 18.			
'TUNER 2':	60mV	or	250mV
Input impedance :	50k ohm		50k ohm
Selected by switched input attenuator marked 'HI' and 'LO' located on the rear panel.			
'REPLAY' ('TAPE MONITOR' 'OFF'):	400mV		
Input impedance :	47k ohm		
'REPLAY' ('TAPE MONITOR' 'ON'):	400mV		
Input impedance :	20k ohm		

OVERLOAD DISTORTION :

Less than 0.1% for input signals up to 20dB above stated sensitivities from 30 Hz – 15 kHz.

HUM AND NOISE :

63dB below 15 watts on 'TUNER' and 'REPLAY' and 53dB below 15 watts on other inputs.

CROSS-TALK :

Between 'L' and 'R' channels, - 56dB up to 1 kHz and - 30dB at 10 kHz.

H. J. LEAK & CO., LTD.

BRUNEL ROAD • WESTWAY FACTORY ESTATE • LONDON W.3

Telephone : 01-749 1641 (10 lines)

Telegrams Inland : Sinusoidal, Ealux, London Foreign : Sinusoidal, London