

Power Amplifiers

procon plus

service manual
schematic diagrams

Index

- 2 Technical specifications, transistor packages, Procon 400p test procedures.
- 3 Procon 750p, Procon 1000p test procedures.
- 4 Procon 1250p, Procon 1500p test procedures.
- 5 Procon 1800p, Procon 2200p test procedures.
- 6 Procon 400p schematic.
- 7 Procon 750p schematic.
- 8 Procon 1000p schematic.
- 9 Procon 1250p schematic.
- 10 Procon 1500p schematic.
- 11 Procon 1800p schematic.
- 12 Procon 2200p schematic.
- 13 Spare part list.



Notice

Service must be carried out by qualified personnel only. Any tampering carried out by unqualified personnel during the guarantee period will forfeit the right to guarantee.

For a correct operation of the instrument, after having switched off, be careful to wait at least 3 seconds before switching on again.

To improve the device's specifications, the schematic diagrams may be subject to change without prior notice.

All components marked by this symbol have special safety characteristics, when replacing any of these components use only manufacturer's specified parts.

The (μ) micro symbol of capacitance value is substituted by U.

The (Ω) omega symbol of resistance value is substituted by E.

The electrolytic capacitors are 25Vdc rated voltage unless otherwise specified.

All resistors are 1/8W unless otherwise specified.

All switches shown in the "OFF" position. All DC voltages measured to ground with a voltmeter 20KOhm/V.

← Soldering point.

↑ Supply voltage.

⊥ Logic supply ground.

• Male connector.

□ Test point.

⊥ Analog supply ground.

○ Female connector.

◊ Flag joined with one or more flags with the same signal name inscribed.

⊥ Chassis ground.

⊔ M/F faston connector.

⊕ Earth ground.



ATTENTION Observe precautions when handling electrostatic sensitive devices.



GENERALMUSIC S.p.A. Sales Division: 47842 S.Giovanni in Marignano (RN) ITALY - Via delle Rose, 12



Phone +39(0)541/959511 - Fax +39(0)541/957404 - Internet: www.generalmusic.com

PROCON PLUS SERIES • TECHNICAL SPECIFICATIONS

POWER SPECIFICATIONS		400P	750P	1000P	1250P	1500P	1800P	2200P
EIA output power	8 ohm	125+125	215+215	300+300	375+375	450+450	550+550	650+650
1kHz, THD maximum 1%	4 ohm	200+200	375+375	550+550	625+625	750+750	900+900	1100+1100
Both channels	8 ohm BRIDGED	400	750	1100	1250	1500	1800	2200
ELECTRICAL SPECIFICATIONS		400P	750P	1000P	1250P	1500P	1800P	2200P
INPUT SENSITIVITY		0dB (0.775V)						
INPUT IMPEDANCE		10 kOhms (balanced)						
FREQUENCY RESPONSE		10+50000 Hz (-0.5dB)						
VOLTAGE GAIN		32dB	33dB	35dB	36dB	37dB	37dB	39dB
SLEW RATE		22 V/ms						
DAMPING FACTOR		>400:1 @ 1kHz, 80hms						
CROSSTALK		-82 dB (1KHz)						
S/N ratio		-100 dB						
Harmonic distortion THD		<0.1% (ref 20Hz -20KHz)						
Intermodulation distortion SMPTE		<0.1% (SMPTE method, 60Hz & 7kHz, 4:1 ratio)						
GENERAL SPECIFICATIONS		400P	750P	1000P	1250P	1500P	1800P	2200P
PROTECTIONS		Power transformer thermal protection Short circuit protection Sensor for current on outputs CLIP Limiter on each channel Soft-start circuit (1000P to 2200P)						
CONTROLS		ON/OFF switch 21-detect input level control for each channel MODE selector SHIELD selector						
INDICATORS		POWER ON: 1 red LED BRIDGE: 1 red LED PROTECT: 1 red LED LEVEL: 2 x 5-LED meters LIMIT: 1 red LED						
CONNECTORS	IN OUT	1 XLR-F + 1 JACK in parallel for each channel 2 x BINDING POST + 1 SPEAKON for each channel (400-1500) 1 SPEAKON for each channel + 1 SPEAKON for BRIDGE output (1800-2200)						
POWER SUPPLY		see label on the unit						
DIMENSIONS	mm (WxHxD)	483x88x366		483x88x428			483x88x456	
WEIGHT	kg	13	15	18	19.5	21	23.5	25

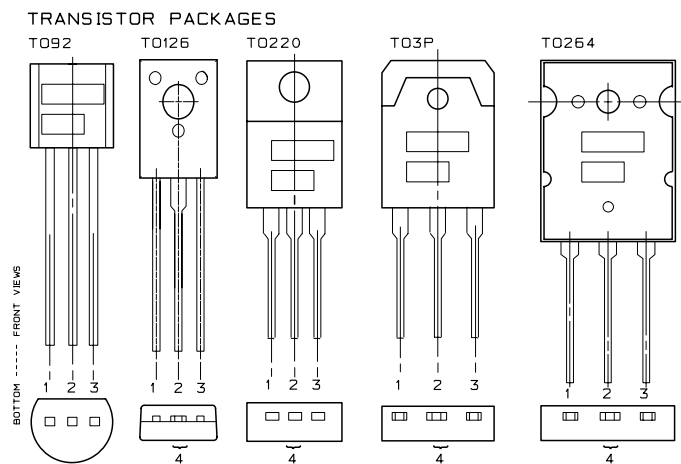

PROCON400p - Test procedures

PRECAUTION

- To prevent short circuit during any test, the oscilloscope must be EARTH INSULATED, this occurs because some test require to connect its probe to the amplifier output, non-compliance may cause damages to oscilloscope inputs circuitry.
- Before removing or installing any modules and connectors, disconnect the amplifier from AC MAINS and measure the DC supply voltages across each of the power supply capacitors. If your measurement on any of the caps is greater than 10Vdc, connect a 100E 60W resistor across the applicable caps to discharge them for your safety. Remember to remove the discharge resistor immediately after discharging caps. Do not power up the amplifier with the discharge resistor connected.
- Do not check the amplifier with the speakers connected use the appropriate load resistors only.
- BE CAREFUL increasing the Variac you must not exceed the nominal mains voltage plus its tolerance (see specifications) any upper voltage can be cause of damage.

VISUAL CHECK

- Use compressed air to clear dust in the amplifier chassis.
- Before proceed to supply the amplifier check visually the internal assembly, if appears an evident damage find the most possible reasons that cause it.
- Check the wiring cables for possible interruptions or shorts.
- If the damage has burnt a printed circuit board don't try to repair it, replace with a new one.

TESTING GEAR

- Audio Generator
- Dual Trace Oscilloscope
- Digital Multimeter
- 4E 300W, 8E 450W, 100E 60W resistors
- Variac
- Digital Thermometer (not indispensable)

SETUP

- Connect the Variac between the Mains and the amplifier and set it at zero voltage.
- Turn full counter-clockwise the LEVEL potentiometers.
- Connect the audio generator to the channel inputs and set it to 1KHz 775mVrms (0dBu) sinusoidal signal.
- Connect the two scope traces to the amplifier outputs, before the relay, and set them in DC at 20V/div. 2mS/div.

SUPPLY CHECK

- Verify with the Multimeter the insulation between the heatsinks and all transistor collectors mounted on them; placing the multimeter tips between the screw heads and the collector pins you can exclude an erroneous reading due to the insulation of the heatsink anodization.
- Verify with the Multimeter the NTC (RT1) and R1 paralleled resistor value, it must be about 1080ohm (at 25°C).
- Disconnect the amplifier module supplies of each channel (red and yellow wires).
- Set the Variac to the nominal mains voltage, turn on the Amplifier, then check with the Multimeter the AC supply voltages:

F1-F2 = 29±2Vac.

RED secondary wires = 87±9Vac.

- Re-set the Variac at zero voltage, turn off the amplifier and reconnect the supplies at each amplifier module.
- Set up the Variac slowly monitoring the oscilloscope screen, it should display no signal; if you notice a DC voltage or a protection trips check the amplifier as suggested in the ADVICES.
- As soon as the +12VF supply circuit reaches its nominal value, all cooling fans run at their minimum and the speaker output relays (J201-202) switch.
- When the Variac ac voltage reaches the nominal voltage verify the DC supplies as follow:

+VCC = +59±6Vdc

-VCC = -59±6Vdc

U101 pin 8 = +12±0.5Vdc

U101 pin 4 = -12±0.5Vdc

U403 pin 3 = +12±0.5Vdc

- If one or more voltages don't correspond, check the rectifiers, capacitors and transformers disconnecting them from circuitry.

CHANNEL CHECK

- Be sure you have disconnected the load resistor.
- Increasing the input signal also the output signal raise accordingly, it must be symmetrical without visible distortion or oscillation as shown in figure (note: the figure is representative don't refer to the levels displayed). If there is a distortion read the section ADVICES.
- When the input signal exceeds -20dBu (20Vpp on output) the fans turn at their maximum speed.
- Firstly you must check the channel without load, afterwards you must repeat the check with the loads attached, the following table reports the approx. maximum level obtainable with this amp:

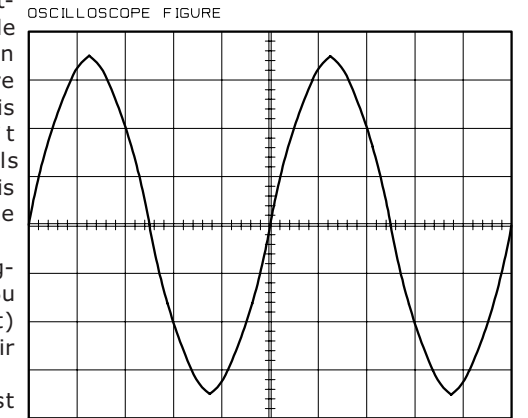

	out level	in level
no load	113Vpp	+1.5dBu
1CH 4E	91Vpp	-0.2dBu
2CH 4E	82Vpp	-2.0dBu
Bridge 8E	161Vpp	-2.3dBu

LEVEL METER ADJUSTMENT

- Check if the clip led lights at -2dBu on input (~80Vpp on output), if necessary adjust the trimmers W301/2 on display board.

OFFSET ADJUSTMENT

- Set the input level at minimum (no signal), the output dc offset voltage must be within range ±20mV, if necessary adjust the VR201 trimmer (for each channel) to be within this range.

BIAS ADJUSTMENT

- No bias adjustment is necessary for this amplifier circuitry.

ADVICES

- If you have determinate that the problem is a short on a rail, you must check the output transistors.
- To determine which transistor devices are bad, use a soldering iron to lift one leg of each emitter pin and measure the resistance across emitter and collector of each device. Unsolder and lift one leg of each base pin and check the base-collector resistance. Replace any device that measure as a short.
- If all the transistors are OK, unsolder and lift one leg of each diode and check them.
- Check the circuit board for open foil traces.
- Use the Multimeter to check the resistors, particularly the base and emitter resistors of damaged transistor.
- If the input sinewave appears to be distorted during the negative cycle, you can assume that the problem is located somewhere in the circuitry of the positive rail.
- If the positive cycle appears distorted, you can assume that the problem is in the circuitry of the negative rail.
- The dc voltages printed on the schematics are measured with the amplifier in steady state without input signal and nominal mains voltage supply, it can be useful to localize a damage.

PROCON750p - Test procedures

PRECAUTION

- To prevent short circuit during any test, the oscilloscope must be EARTH INSULATED, this occurs because some test require to connect its probe to the amplifier output, non-compliance may cause damages to oscilloscope inputs circuitry.
- Before removing or installing any modules and connectors, disconnect the amplifier from AC MAINS and measure the DC supply voltages across each of the power supply capacitors. If your measurement on any of the caps is greater than 10Vdc, connect a 100E 70W resistor across the applicable caps to discharge them for your safety. Remember to remove the discharge resistor immediately after discharging caps. Do not power up the amplifier with the discharge resistor connected.
- Do not check the amplifier with the speakers connected use the appropriate load resistors only.
- BE CAREFUL increasing the Variac you must not exceed the nominal mains voltage plus its tolerance (see specifications) any upper voltage can be cause of damage.

VISUAL CHECK

- Use compressed air to clear dust in the amplifier chassis.
- Before proceed to supply the amplifier check visually the internal assembly, if appears an evident damage find the most possible reasons that cause it.
- Check the wiring cables for possible interruptions or shorts.
- If the damage has burnt a printed circuit board don't try to repair it, replace with a new one.

TESTING GEAR

- Audio Generator
- Dual Trace Oscilloscope
- Digital Multimeter
- 4E 450W, 8E 800W, 100E 70W resistors
- Variac
- Digital Thermometer (not indispensable)

SETUP

- Connect the Variac between the Mains and the amplifier and set it at zero voltage.
- Turn full counter-clockwise the LEVEL potentiometers.
- Connect the audio generator to the channel inputs and set it to 1KHz 775mVrms (0dBu) sinusoidal signal.
- Connect the two scope traces to the amplifier outputs, before the relay, and set them in DC at 20V/div. 2mS/div.

SUPPLY CHECK

- Verify with the Multimeter the insulation between the heatsinks and all transistor collectors mounted on them; placing the multimeter tips between the screw heads and the collector pins you can exclude an erroneous reading due to the insulation of the heatsink anodization.
- Verify with the Multimeter the NTC (RT1) and R1 paralleled resistor value, it must be about 1080ohm (at 25°C).
- Disconnect the amplifier module supplies of each channel (red and yellow wires).
- Set the Variac to the nominal mains voltage, turn on the Amplifier, then check with the Multimeter the AC supply voltages:

F1-F2 = 29±2Vac.

RED secondary wires = 106±10Vac.

- Re-set the Variac at zero voltage, turn off the amplifier and reconnect the supplies at each amplifier module.
- Set up the Variac slowly monitoring the oscilloscope screen, it should display no signal; if you notice a DC voltage or a protection trips check the amplifier as suggested in the ADVICES.
- As soon as the +12VF supply circuit reaches its nominal value, all cooling fans run at their minimum and the speaker output relays (J201-202) switch.
- When the Variac ac voltage reaches the nominal voltage verify the DC supplies as follow:

+VCC = +72±7Vdc

-VCC = -72±7Vdc

U101 pin 8 = +12±0.5Vdc

U101 pin 4 = -12±0.5Vdc

U403 pin 3 = +12±0.5Vdc

- If one or more voltages don't correspond, check the rectifiers, capacitors and transformers disconnecting them from circuitry.

CHANNEL CHECK

- Be sure you have disconnected the load resistor.
- Increasing the input signal also the output signal raise accordingly, it must be symmetrical without visible distortion or oscillation as shown in figure (note: the figure is representative don't refer to the levels displayed). If there is a distortion read the section ADVICES.
- When the input signal exceeds -20dBu (20Vpp on output) the fans turn at their maximum speed.
- Firstly you must check the channel without load, afterwards you must repeat the check with the loads attached, the following table reports the approx. maximum level obtainable with this amp:

	out level	in level
no load	139Vpp	+3.0dBu
1CH 4E	117Vpp	+1.5dBu
2CH 4E	109Vpp	+0.9dBu
Bridge 8E	214Vpp	+0.7dBu

LEVEL METER ADJUSTMENT

- Check if the clip led lights at -1dBu on input (~90Vpp on output), if necessary adjust the trimmers W301/2 on display board.

OFFSET ADJUSTMENT

- Set the input level at minimum (no signal), the output dc offset voltage must be within range ±20mV, if necessary adjust the VR201 trimmer (for each channel) to be within this range.

BIAS ADJUSTMENT

- No bias adjustment is necessary for this amplifier circuitry.

ADVICES

- If you have determinate that the problem is a short on a rail, you must check the output transistors.
- To determine which transistor devices are bad, use a soldering iron to lift one leg of each emitter pin and measure the resistance across emitter and collector of each device. Unsolder and lift one leg of each base pin and check the base-collector resistance. Replace any device that measure as a short.
- If all the transistors are OK, unsolder and lift one leg of each diode and check them.
- Check the circuit board for open foil traces.
- Use the Multimeter to check the resistors, particularly the base and emitter resistors of damaged transistor.
- If the input sinewave appears to be distorted during the negative cycle, you can assume that the problem is located somewhere in the circuitry of the positive rail.
- If the positive cycle appears distorted, you can assume that the problem is in the circuitry of the negative rail.
- The dc voltages printed on the schematics are measured with the amplifier in steady state without input signal and nominal mains voltage supply, it can be useful to localize a damage.

PROCON1000p - Test procedures

PRECAUTION

- To prevent short circuit during any test, the oscilloscope must be EARTH INSULATED, this occurs because some test require to connect its probe to the amplifier output, non-compliance may cause damages to oscilloscope inputs circuitry.
- Before removing or installing any modules and connectors, disconnect the amplifier from AC MAINS and measure the DC supply voltages across each of the power supply capacitors. If your measurement on any of the caps is greater than 10Vdc, connect a 100E 80W resistor across the applicable caps to discharge them for your safety. Remember to remove the discharge resistor immediately after discharging caps. Do not power up the amplifier with the discharge resistor connected.
- Do not check the amplifier with the speakers connected use the appropriate load resistors only.
- BE CAREFUL increasing the Variac you must not exceed the nominal mains voltage plus its tolerance (see specifications) any upper voltage can be cause of damage.

VISUAL CHECK

- Use compressed air to clear dust in the amplifier chassis.
- Before proceed to supply the amplifier check visually the internal assembly, if appears an evident damage find the most possible reasons that cause it.
- Check the wiring cables for possible interruptions or shorts.
- If the damage has burnt a printed circuit board don't try to repair it, replace with a new one.

TESTING GEAR

- Audio Generator
- Dual Trace Oscilloscope
- Digital Multimeter
- 4E 700W, 8E 1100W, 100E 80W resistors
- Variac
- Digital Thermometer (not indispensable)

SETUP

- Connect the Variac between the Mains and the amplifier and set it at zero voltage.
- Turn full counter-clockwise the LEVEL potentiometers.
- Connect the audio generator to the channel inputs and set it to 1KHz 775mVrms (0dBu) sinusoidal signal.
- Connect the two scope traces to the amplifier outputs, before the relay, and set them in DC at 50V/div. 2mS/div.

SUPPLY CHECK

- Verify with the Multimeter the insulation between the heatsinks and all transistor collectors mounted on them; placing the multimeter tips between the screw heads and the collector pins you can exclude an erroneous reading due to the insulation of the heatsink anodization.
- Verify with the Multimeter the NTC (RT1) and R1 paralleled resistor value, it must be about 7Kohm (at 25°C).
- Disconnect the amplifier module supplies of each channel (red and yellow wires).
- Set the Variac to the nominal mains voltage, turn on the Amplifier, then check with the Multimeter the AC supply voltages:

F1-F2 = 29±2Vac.

RED secondary wires = 125±6Vac.

- Re-set the Variac at zero voltage, turn off the amplifier and reconnect the supplies at each amplifier module.
- Set up the Variac slowly monitoring the oscilloscope screen, it should display no signal; if you notice a DC voltage or a protection trips check the amplifier as suggested in the ADVICES.
- As soon as the +12VF supply circuit reaches its nominal value, all cooling fans run at their minimum and the speaker output relays (J201-202) switch.
- When the Variac ac voltage reaches the nominal voltage verify the DC supplies as follow:

+VCC = +82±5Vdc

-VCC = -82±5Vdc

U501 pin 8 = +12±0.5Vdc

U501 pin 4 = -12±0.5Vdc

U403 pin 3 = +12.5±0.5Vdc

- If one or more voltages don't correspond, check the rectifiers, capacitors and transformers disconnecting them from circuitry.

CHANNEL CHECK

- Be sure you have disconnected the load resistor.
- Increasing the input signal also the output signal raise accordingly, it must be symmetrical without visible distortion or oscillation as shown in figure (note: the figure is representative don't refer to the levels displayed). If there is a distortion read the section ADVICES.
- When the input signal exceeds -20dBu (24Vpp on output) the fans turn at their maximum speed.
- Firstly you must check the channel without load, afterwards you must repeat the check with the loads attached, the following table reports the approx. maximum level obtainable with this amp:

	out level	in level
no load	162Vpp	+2.0dBu
1CH 4E	141Vpp	+1.7dBu
2CH 4E	131Vpp	+1.0dBu
Bridge 8E	258Vpp	+0.5dBu

LEVEL METER ADJUSTMENT

- Check if the clip led lights at -2dBu on input (~150Vpp on output), if necessary adjust the trimmers W301/2 on display board.

OFFSET ADJUSTMENT

- Set the input level at minimum (no signal), the output dc offset voltage must be within range ±20mV, if necessary adjust the VR201 trimmer (for each channel) to be within this range.

BIAS ADJUSTMENT

- No bias adjustment is necessary for this amplifier circuitry; in any case the amplifier has the possibility to adjust it if necessary. To check properly the bias proceed as follows:
- Using a sinusoidal signal (1KHz or more) and the 4E load attached, wait till the heatsink temperature reaches about 60°C.
- Turn down the signal at the smallest intensity you can read on your oscilloscope trace connected at the amplifier output.
- Zoom in the crossing region using the amplitude, timebase and trigger controls of your oscilloscope. If you see a distortion, try to eliminate it adjusting the VR202 trimmer.
- Finally, set the input level at minimum and verify with the multimeter attached across an emitter resistance (p.e. R232) that the dc voltage doesn't exceed 10mV.

ADVICES

- If you have determinate that the problem is a short on a rail, you must check the output transistors.
- To determine which transistor devices are bad, use a soldering iron to lift one leg of each emitter pin and measure the resistance across emitter and collector of each device. Unsolder and lift one leg of each base pin and check the base-collector resistance. Replace any device that measure as a short.
- If all the transistors are OK, unsolder and lift one leg of each diode and check them.
- Check the circuit board for open foil traces.
- Use the Multimeter to check the resistors, particularly the base and emitter resistors of damaged transistor.
- If the input sinewave appears to be distorted during the negative cycle, you can assume that the problem is located somewhere in the circuitry of the positive rail.
- If the positive cycle appears distorted, you can assume that the problem is in the circuitry of the negative rail.
- The dc voltages printed on the schematics are measured with the amplifier in steady state without input signal and nominal mains voltage supply, it can be useful to localize a damage.

OSCILLOSCOPE FIGURE

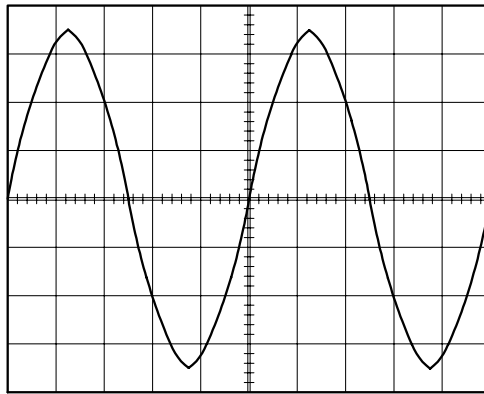

TRACE setting:
TIMEBASE: 2mS/div.
AMPLITUDE: 20V/div.

OSCILLOSCOPE FIGURE

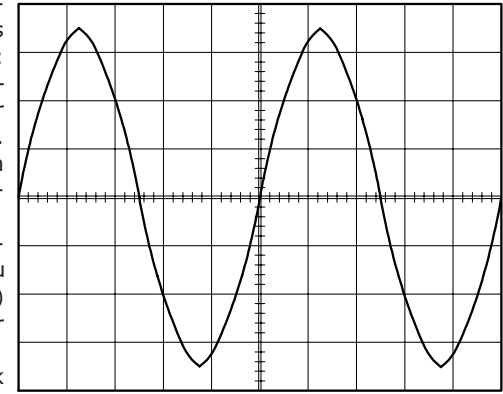

TRACE setting:
TIMEBASE: 2mS/div.
AMPLITUDE: 20V/div.

PROCON1250p - Test procedures

PRECAUTION

- To prevent short circuit during any test, the oscilloscope must be EARTH INSULATED, this occurs because some test require to connect its probe to the amplifier output, non-compliance may cause damages to oscilloscope inputs circuitry.
- Before removing or installing any modules and connectors, disconnect the amplifier from AC MAINS and measure the DC supply voltages across each of the power supply capacitors. If your measurement on any of the caps is greater than 10Vdc, connect a 100E 90W resistor across the applicable caps to discharge them for your safety. Remember to remove the discharge resistor immediately after discharging caps. Do not power up the amplifier with the discharge resistor connected.
- Do not check the amplifier with the speakers connected use the appropriate load resistors only.
- BE CAREFUL increasing the Variac you must not exceed the nominal mains voltage plus its tolerance (see specifications) any upper voltage can be cause of damage.

VISUAL CHECK

- Use compressed air to clear dust in the amplifier chassis.
- Before proceed to supply the amplifier check visually the internal assembly, if appears an evident damage find the most possible reasons that cause it.
- Check the wiring cables for possible interruptions or shorts.
- If the damage has burnt a printed circuit board don't try to repair it, replace with a new one.

TESTING GEAR

- Audio Generator
- Dual Trace Oscilloscope
- Digital Multimeter
- 4E 800W, 8E 1300W, 100E 90W resistors
- Variac
- Digital Thermometer (not indispensable)

SETUP

- Connect the Variac between the Mains and the amplifier and set it at zero voltage.
- Turn full counter-clockwise the LEVEL potentiometers.
- Connect the audio generator to the channel inputs and set it to 1KHz 775mVrms (0dBu) sinusoidal signal.
- Connect the two scope traces to the amplifier outputs, before the relay, and set them in DC at 50V/div. 2mS/div.

SUPPLY CHECK

- Verify with the Multimeter the insulation between the heatsinks and all transistor collectors mounted on them; placing the multimeter tips between the screw heads and the collector pins you can exclude an erroneus reading due to the insulation of the heatsink anodization.
- Verify with the Multimeter the NTC (RT1) and R1 paralleled resistor value, it must be about 7Kohm (at 25°C).
- Disconnect the amplifier module supplies of each channel (red and yellow wires).
- Set the Variac to the nominal mains voltage, turn on the Amplifier, then check with the Multimeter the AC supply voltages:

F1-F2 = 29±2Vac.
RED secondary wires = 137±7Vac.

- Re-set the Variac at zero voltage, turn off the amplifier and reconnect the supplies at each amplifier module.
- Set up the Variac slowly monitoring the oscilloscope screen, it should display no signal; if you notice a DC voltage or a protection trips check the amplifier as suggested in the ADVICES.
- As soon as the +12VF supply circuit reaches its nominal value, all cooling fans run at their minimum and the speaker output relais (J201-202) switch.
- When the Variac ac voltage reaches the nominal voltage verify the DC supplies as follow:

+VCC = +92±6Vdc
-VCC = -92±6Vdc
U501 pin 8 = +12±0.5Vdc
U501 pin 4 = -12±0.5Vdc
U403 pin 3 = +12.5±0.5Vdc

- If one or more voltages don't correspond, check the rectifiers, capacitors and transformers disconnecting them from circuitry.

CHANNEL CHECK

- Be sure you have disconnected the load resistor.
- Increasing the input signal also the output signal raise accordingly, it must be symmetrical without visible distortion or oscillation as shown in figure (note: the figure is representative don't refer to the levels displayed). If there is a distortion read the section ADVICES.

OSCILLOSCOPE FIGURE

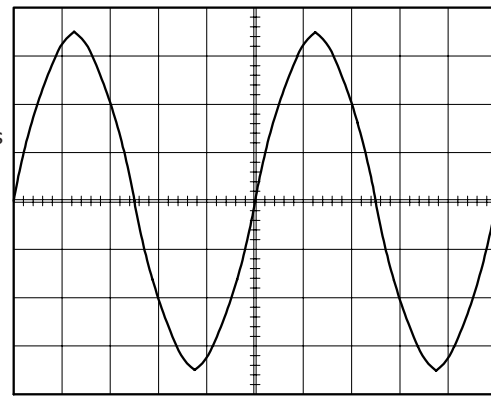

TRACE setting:
 TIMEBASE: 2mS/div.
 AMPLITUDE: 20V/div.

- When the input signal exceeds -20dBu (24Vpp on output) the fans turn at their maximum speed.
- Firstly you must check the channel without load, afterwards you must repeat the check with the loads attached, the following table reports the approx. maximum level obtainable with this amp:

	out level	in level
no load	178Vpp	+1.0dBu
1CH 4E	154Vpp	+0.8dBu
2CH 4E	141Vpp	+0.0dBu
Bridge 8E	278Vpp	-0.5dBu

LEVEL METER ADJUSTMENT

- Check if the clip led lights at -2dBu on input (~130Vpp on output), if necessary adjust the trimmers W301/2 on display board.

OFFSET ADJUSTMENT

- Set the input level at minimum (no signal), the output dc offset voltage must be within range ±20mV, if necessary adjust the VR201 trimmer (for each channel) to be within this range.

BIAS ADJUSTMENT

- No bias adjustment is necessary for this amplifier circuitry; in any case the amplifier has the possibility to adjust it if necessary. To check properly the bias proceed as follows:
- Using a sinusoidal signal (1KHz or more) and the 4E load attached, wait till the heatsink temperature reaches about 60°C.
- Turn down the signal at the smallest intensity you can read on your oscilloscope trace connected at the amplifier output.
- Zoom in the crossing region using the amplitude, timebase and trigger controls of your oscilloscope. If you see a distortion, try to eliminate it adjusting the VR202 trimmer.
- Finally, set the input level at minimum and verify with the multimeter attached across an emitter resistance (p.e. R232) that the dc voltage doesn't exceed 10mV.

ADVICES

- If you have determinate that the problem is a short on a rail, you must check the output transistors.
- To determine which transistor devices are bad, use a soldering iron to lift one leg of each emitter pin and measure the resistance across emitter and collector of each device. Unsolder and lift one leg of each base pin and check the base-collector resistance. Replace any device that measure as a short.
- If all the transistors are OK, unsolder and lift one leg of each diode and check them.
- Check the circuit board for open foil traces.
- Use the Multimeter to check the resistors, particularly the base and emitter resistors of damaged transistor.
- If the input sinewave appears to be distorted during the negative cycle, you can assume that the problem is located somewhere in the circuitry of the positive rail.
- If the positive cycle appears distorted, you can assume that the problem is in the circuitry of the negative rail.
- The dc voltages printed on the schematics are measured with the amplifier in steady state without input signal and nominal mains voltage supply, it can be useful to localize a damage.

PROCON1500p - Test procedures

PRECAUTION

- To prevent short circuit during any test, the oscilloscope must be EARTH INSULATED, this occurs because some test require to connect its probe to the amplifier output, non-compliance may cause damages to oscilloscope inputs circuitry.
- Before removing or installing any modules and connectors, disconnect the amplifier from AC MAINS and measure the DC supply voltages across each of the power supply capacitors. If your measurement on any of the caps is greater than 10Vdc, connect a 100E 100W resistor across the applicable caps to discharge them for your safety. Remember to remove the discharge resistor immediately after discharging caps. Do not power up the amplifier with the discharge resistor connected.
- Do not check the amplifier with the speakers connected use the appropriate load resistors only.
- BE CAREFUL increasing the Variac you must not exceed the nominal mains voltage plus its tolerance (see specifications) any upper voltage can be cause of damage.

VISUAL CHECK

- Use compressed air to clear dust in the amplifier chassis.
- Before proceed to supply the amplifier check visually the internal assembly, if appears an evident damage find the most possible reasons that cause it.
- Check the wiring cables for possible interruptions or shorts.
- If the damage has burnt a printed circuit board don't try to repair it, replace with a new one.

TESTING GEAR

- Audio Generator
- Dual Trace Oscilloscope
- Digital Multimeter
- 4E 900W, 8E 1500W, 100E 100W resistors
- Variac
- Digital Thermometer (not indispensable)

SETUP

- Connect the Variac between the Mains and the amplifier and set it at zero voltage.
- Turn full counter-clockwise the LEVEL potentiometers.
- Connect the audio generator to the channel inputs and set it to 1KHz 775mVrms (0dBu) sinusoidal signal.
- Connect the two scope traces to the amplifier outputs, before the relay, and set them in DC at 50V/div. 2mS/div.

SUPPLY CHECK

- Verify with the Multimeter the insulation between the heatsinks and all transistor collectors mounted on them; placing the multimeter tips between the screw heads and the collector pins you can exclude an erroneus reading due to the insulation of the heatsink anodization.
- Verify with the Multimeter the NTC (RT1) and R1 paralleled resistor value, it must be about 7Kohm (at 25°C).
- Disconnect the amplifier module supplies of each channel (red and yellow wires).
- Set the Variac to the nominal mains voltage, turn on the Amplifier, then check with the Multimeter the AC supply voltages:

F1-F2 = 29±2Vac.
RED secondary wires = 145±8Vac.

- Re-set the Variac at zero voltage, turn off the amplifier and reconnect the supplies at each amplifier module.
- Set up the Variac slowly monitoring the oscilloscope screen, it should display no signal; if you notice a DC voltage or a protection trips check the amplifier as suggested in the ADVICES.
- As soon as the +12VF supply circuit reaches its nominal value, all cooling fans run at their minimum and the speaker output relais (J201-202) switch.
- When the Variac ac voltage reaches the nominal voltage verify the DC supplies as follow:

+VCC = +97±6Vdc
-VCC = -97±6Vdc
U501 pin 8 = +12±0.5Vdc
U501 pin 4 = -12±0.5Vdc
U403 pin 3 = +12.5±0.5Vdc

- If one or more voltages don't correspond, check the rectifiers, capacitors and transformers disconnecting them from circuitry.

CHANNEL CHECK

- Be sure you have disconnected the load resistor.
- Increasing the input signal also the output signal raise accordingly, it must be symmetrical without visible distortion or oscillation as shown in figure (note: the figure is representative don't refer to the levels displayed). If there is a distortion read the section ADVICES.

OSCILLOSCOPE FIGURE

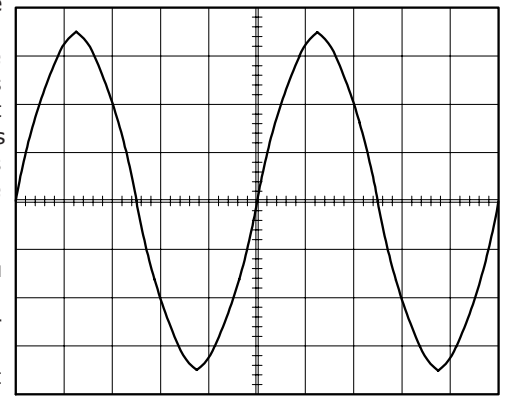

TRACE setting:
 TIMEBASE: 2mS/div.
 AMPLITUDE: 20V/div.

- When the input signal exceeds -20dBu (24Vpp on output) the fans turn at their maximum speed.
- Firstly you must check the channel without load, afterwards you must repeat the check with the loads attached, the following table reports the approx. maximum level obtainable with this amp:

	out level	in level
no load	189Vpp	+1.0dBu
1CH 4E	166Vpp	+0.7dBu
2CH 4E	154Vpp	+0.2dBu
Bridge 8E	307Vpp	+0.0dBu

LEVEL METER ADJUSTMENT

- Check if the clip led lights at -2dBu on input (~130Vpp on output), if necessary adjust the trimmers W301/2 on display board.

OFFSET ADJUSTMENT

- Set the input level at minimum (no signal), the output dc offset voltage must be within range ±20mV, if necessary adjust the VR201 trimmer (for each channel) to be within this range.

BIAS ADJUSTMENT

- No bias adjustment is necessary for this amplifier circuitry; in any case the amplifier has the possibility to adjust it if necessary. To check properly the bias proceed as follows:
- Using a sinusoidal signal (1KHz or more) and the 4E load attached, wait till the heatsink temperature reaches about 60°C.
- Turn down the signal at the smallest intensity you can read on your oscilloscope trace connected at the amplifier output.
- Zoom in the crossing region using the amplitude, timebase and trigger controls of your oscilloscope. If you see a distortion, try to eliminate it adjusting the VR202 trimmer.
- Finally, set the input level at minimum and verify with the multimeter attached across an emitter resistance (p.e. R232) that the dc voltage doesn't exceed 10mV.

ADVICES

- If you have determinate that the problem is a short on a rail, you must check the output transistors.
- To determine which transistor devices are bad, use a soldering iron to lift one leg of each emitter pin and measure the resistance across emitter and collector of each device. Unsolder and lift one leg of each base pin and check the base-collector resistance. Replace any device that measure as a short.
- If all the transistors are OK, unsolder and lift one leg of each diode and check them.
- Check the circuit board for open foil traces.
- Use the Multimeter to check the resistors, particularly the base and emitter resistors of damaged transistor.
- If the input sinewave appears to be distorted during the negative cycle, you can assume that the problem is located somewhere in the circuitry of the positive rail.
- If the positive cycle appears distorted, you can assume that the problem is in the circuitry of the negative rail.
- The dc voltages printed on the schematics are measured with the amplifier in steady state without input signal and nominal mains voltage supply, it can be useful to localize a damage.

PROCON1800p - Test procedures

PRECAUTION

- To prevent short circuit during any test, the oscilloscope must be EARTH INSULATED, this occurs because some test require to connect its probe to the amplifier output, non-compliance may cause damages to oscilloscope inputs circuitry.
- Before removing or installing any modules and connectors, disconnect the amplifier from AC MAINS and measure the DC supply voltages across each of the power supply capacitors. If your measurement on any of the caps is greater than 10Vdc, connect a 100E 120W resistor across the applicable caps to discharge them for your safety. Remember to remove the discharge resistor immediately after discharging caps. Do not power up the amplifier with the discharge resistor connected.
- Do not check the amplifier with the speakers connected use the appropriate load resistors only.
- BE CAREFUL increasing the Variac you must not exceed the nominal mains voltage plus its tolerance (see specifications) any upper voltage can be cause of damage.

VISUAL CHECK

- Use compressed air to clear dust in the amplifier chassis.
- Before proceed to supply the amplifier check visually the internal assembly, if appears an evident damage find the most possible reasons that cause it.
- Check the wiring cables for possible interruptions or shorts.
- If the damage has burnt a printed circuit board don't try to repair it, replace with a new one.

TESTING GEAR

- Audio Generator
- Dual Trace Oscilloscope
- Digital Multimeter
- 4E 1100W, 8E 2000W, 100E 120W resistors
- Variac
- Digital Thermometer (not indispensable)

SETUP

- Connect the Variac between the Mains and the amplifier and set it at zero voltage.
- Turn full counter-clockwise the LEVEL potentiometers.
- Connect the audio generator to the channel inputs and set it to 1KHz 775mVrms (0dBu) sinusoidal signal.
- Connect the two scope traces to the amplifier outputs, before the relay, and set them in DC at 50V/div. 2mS/div.

SUPPLY CHECK

- Verify with the Multimeter the insulation between the heatsinks and all transistor collectors mounted on them; placing the multimeter tips between the screw heads and the collector pins you can exclude an erroneous reading due to the insulation of the heatsink anodization.
- Verify with the Multimeter the NTC (RT1) and R1 paralleled resistor value, it must be about 7Kohm (at 25°C).
- Disconnect the amplifier module supplies of each channel (red and yellow wires).
- Set the Variac to the nominal mains voltage, turn on the Amplifier, then check with the Multimeter the AC supply voltages:

F1-F2 = 29±2Vac.
RED secondary wires = 164±9Vac.

- Re-set the Variac at zero voltage, turn off the amplifier and reconnect the supplies at each amplifier module.
- Set up the Variac slowly monitoring the oscilloscope screen, it should display no signal; if you notice a DC voltage or a protection trips check the amplifier as suggested in the ADVICES.
- As soon as the +12VF supply circuit reaches its nominal value, all cooling fans run at their minimum and the speaker output relays (J201-202) switch.
- When the Variac ac voltage reaches the nominal voltage verify the DC supplies as follow:

+VCC = +110±7Vdc
-VCC = -110±7Vdc
U501 pin 8 = +12±0.5Vdc
U501 pin 4 = -12±0.5Vdc
U403 pin 3 = +12.5±0.5Vdc

- If one or more voltages don't correspond, check the rectifiers, capacitors and transformers disconnecting them from circuitry.

CHANNEL CHECK

- Be sure you have disconnected the load resistor.
- Increasing the input signal also the output signal raise accordingly, it must be symmetrical without visible distortion or oscillation as shown in figure (note: the figure is representative don't refer to the levels displayed). If there is a distortion read the section ADVICES.

- When the input signal exceeds -20dBu (24Vpp on output) the fans turn at their maximum speed.
- Firstly you must check the channel without load, afterwards you must repeat the check with the loads attached, the following table reports the approx. maximum level obtainable with this amp:

	out level	in level
no load	210Vpp	+2.0dBu
1CH 4E	184Vpp	+1.7dBu
2CH 4E	170Vpp	+1.0dBu
Bridge 8E	343Vpp	+0.6dBu

LEVEL METER ADJUSTMENT

- Check if the clip led lights at -2dBu on input (~140Vpp on output), if necessary adjust the trimmers W301/2 on display board.

OFFSET ADJUSTMENT

- Set the input level at minimum (no signal), the output dc offset voltage must be within range ±20mV, if necessary adjust the VR201 trimmer (for each channel) to be within this range.

BIAS ADJUSTMENT

- No bias adjustment is necessary for this amplifier circuitry; in any case the amplifier has the possibility to adjust it if necessary. To check properly the bias proceed as follows:
 - Using a sinusoidal signal (1KHz or more) and the 4E load attached, wait till the heatsink temperature reaches about 60°C.
 - Turn down the signal at the smallest intensity you can read on your oscilloscope trace connected at the amplifier output.
 - Zoom in the crossing region using the amplitude, timebase and trigger controls of your oscilloscope. If you see a distortion, try to eliminate it adjusting the VR202 trimmer.
 - Finally, set the input level at minimum and verify with the multimeter attached across an emitter resistance (p.e. R232) that the dc voltage doesn't exceed 10mV.

ADVICES

- If you have determinate that the problem is a short on a rail, you must check the output transistors.
- To determine which transistor devices are bad, use a soldering iron to lift one leg of each emitter pin and measure the resistance across emitter and collector of each device. Unsolder and lift one leg of each base pin and check the base-collector resistance. Replace any device that measure as a short.
- If all the transistors are OK, unsolder and lift one leg of each diode and check them.
- Check the circuit board for open foil traces.
- Use the Multimeter to check the resistors, particularly the base and emitter resistors of damaged transistor.
- If the input sinewave appears to be distorted during the negative cycle, you can assume that the problem is located somewhere in the circuitry of the positive rail.
- If the positive cycle appears distorted, you can assume that the problem is in the circuitry of the negative rail.
- The dc voltages printed on the schematics are measured with the amplifier in steady state without input signal and nominal mains voltage supply, it can be useful to localize a damage.

PROCON2200p - Test procedures

PRECAUTION

- To prevent short circuit during any test, the oscilloscope must be EARTH INSULATED, this occurs because some test require to connect its probe to the amplifier output, non-compliance may cause damages to oscilloscope inputs circuitry.
- Before removing or installing any modules and connectors, disconnect the amplifier from AC MAINS and measure the DC supply voltages across each of the power supply capacitors. If your measurement on any of the caps is greater than 10Vdc, connect a 100E 150W resistor across the applicable caps to discharge them for your safety. Remember to remove the discharge resistor immediately after discharging caps. Do not power up the amplifier with the discharge resistor connected.
- Do not check the amplifier with the speakers connected use the appropriate load resistors only.
- BE CAREFUL increasing the Variac you must not exceed the nominal mains voltage plus its tolerance (see specifications) any upper voltage can be cause of damage.

VISUAL CHECK

- Use compressed air to clear dust in the amplifier chassis.
- Before proceed to supply the amplifier check visually the internal assembly, if appears an evident damage find the most possible reasons that cause it.
- Check the wiring cables for possible interruptions or shorts.
- If the damage has burnt a printed circuit board don't try to repair it, replace with a new one.

TESTING GEAR

- Audio Generator
- Dual Trace Oscilloscope
- Digital Multimeter
- 4E 1300W, 8E 2200W, 100E 150W resistors
- Variac
- Digital Thermometer (not indispensable)

SETUP

- Connect the Variac between the Mains and the amplifier and set it at zero voltage.
- Turn full counter-clockwise the LEVEL potentiometers.
- Connect the audio generator to the channel inputs and set it to 1KHz 775mVrms (0dBu) sinusoidal signal.
- Connect the two scope traces to the amplifier outputs, before the relay, and set them in DC at 50V/div. 2mS/div.

SUPPLY CHECK

- Verify with the Multimeter the insulation between the heatsinks and all transistor collectors mounted on them; placing the multimeter tips between the screw heads and the collector pins you can exclude an erroneous reading due to the insulation of the heatsink anodization.
- Verify with the Multimeter the NTC (RT1) and R1 paralleled resistor value, it must be about 7Kohm (at 25°C).
- Disconnect the amplifier module supplies of each channel (red and yellow wires).
- Set the Variac to the nominal mains voltage, turn on the Amplifier, then check with the Multimeter the AC supply voltages:

F1-F2 = 29±2Vac.
RED secondary wires = 173±10Vac.

- Re-set the Variac at zero voltage, turn off the amplifier and reconnect the supplies at each amplifier module.
- Set up the Variac slowly monitoring the oscilloscope screen, it should display no signal; if you notice a DC voltage or a protection trips check the amplifier as suggested in the ADVICES.
- As soon as the +12VF supply circuit reaches its nominal value, all cooling fans run at their minimum and the speaker output relays (J201-202) switch.
- When the Variac ac voltage reaches the nominal voltage verify the DC supplies as follow:

+VCC = +115±8Vdc
-VCC = -115±8Vdc
U501 pin 8 = +12±0.5Vdc
U501 pin 4 = -12±0.5Vdc
U403 pin 3 = +12.5±0.5Vdc

- If one or more voltages don't correspond, check the rectifiers, capacitors and transformers disconnecting them from circuitry.

CHANNEL CHECK

- Be sure you have disconnected the load resistor.
- Increasing the input signal also the output signal raise accordingly, it must be symmetrical without visible distortion or oscillation as shown in figure (note: the figure is representative don't refer to the levels displayed). If there is a distortion read the section ADVICES.

- When the input signal exceeds -20dBu (20Vpp on output) the fans turn at their maximum speed.
- Firstly you must check the channel without load, afterwards you must repeat the check with the loads attached, the following table reports the approx. maximum level obtainable with this amp:

	out level	in level
no load	225Vpp	+2.0dBu
1CH 4E	200Vpp	+1.7dBu
2CH 4E	185Vpp	+1.0dBu
Bridge 8E	373Vpp	+0.6dBu

LEVEL METER ADJUSTMENT

- Check if the clip led lights at -2dBu on input (~150Vpp on output), if necessary adjust the trimmers W301/2 on display board.

OFFSET ADJUSTMENT

- Set the input level at minimum (no signal), the output dc offset voltage must be within range ±20mV, if necessary adjust the VR201 trimmer (for each channel) to be within this range.

BIAS ADJUSTMENT

- No bias adjustment is necessary for this amplifier circuitry; in any case the amplifier has the possibility to adjust it if necessary. To check properly the bias proceed as follows:
 - Using a sinusoidal signal (1KHz or more) and the 4E load attached, wait till the heatsink temperature reaches about 60°C.
 - Turn down the signal at the smallest intensity you can read on your oscilloscope trace connected at the amplifier output.
 - Zoom in the crossing region using the amplitude, timebase and trigger controls of your oscilloscope. If you see a distortion, try to eliminate it adjusting the VR202 trimmer.
 - Finally, set the input level at minimum and verify with the multimeter attached across an emitter resistance (p.e. R232) that the dc voltage doesn't exceed 10mV.

ADVICES

- If you have determinate that the problem is a short on a rail, you must check the output transistors.
- To determine which transistor devices are bad, use a soldering iron to lift one leg of each emitter pin and measure the resistance across emitter and collector of each device. Unsolder and lift one leg of each base pin and check the base-collector resistance. Replace any device that measure as a short.
- If all the transistors are OK, unsolder and lift one leg of each diode and check them.
- Check the circuit board for open foil traces.
- Use the Multimeter to check the resistors, particularly the base and emitter resistors of damaged transistor.
- If the input sinewave appears to be distorted during the negative cycle, you can assume that the problem is located somewhere in the circuitry of the positive rail.
- If the positive cycle appears distorted, you can assume that the problem is in the circuitry of the negative rail.
- The dc voltages printed on the schematics are measured with the amplifier in steady state without input signal and nominal mains voltage supply, it can be useful to localize a damage.

OSCILLOSCOPE FIGURE

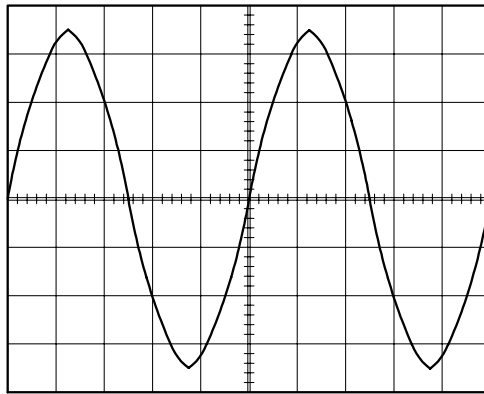

TRACE setting:
 TIMEBASE: 2mS/div.
 AMPLITUDE: 20V/div.

OSCILLOSCOPE FIGURE

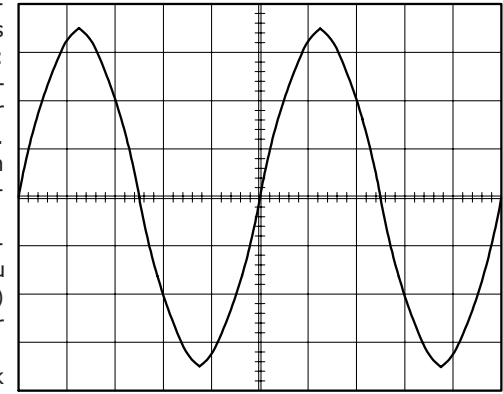

TRACE setting:
 TIMEBASE: 2mS/div.
 AMPLITUDE: 20V/div.

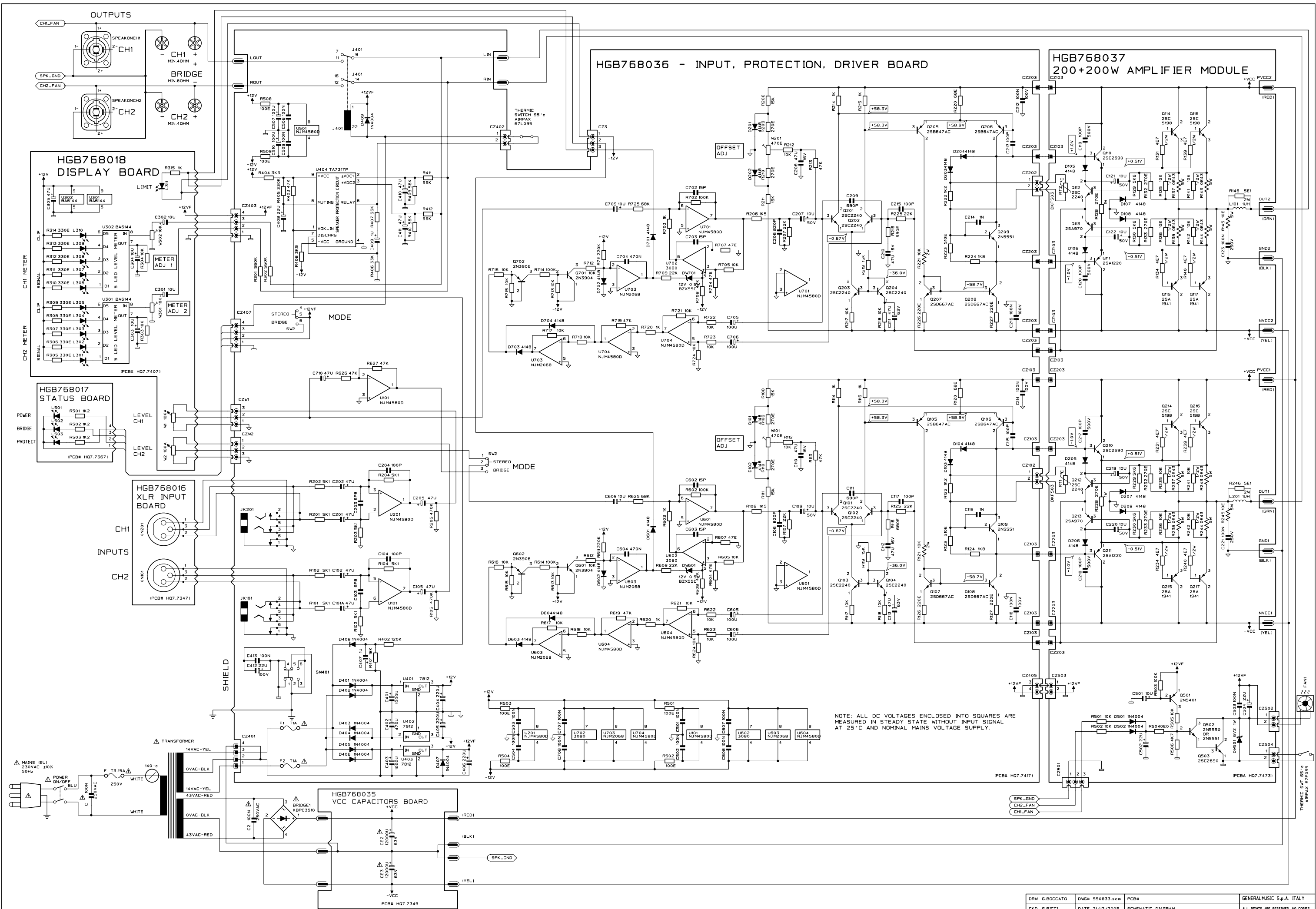

NOTE: ALL DC VOLTAGES ENCLOSED INTO SQUARES ARE MEASURED IN STEADY STATE WITHOUT INPUT SIGNAL AT 25°C AND NOMINAL MAINS VOLTAGE SUPPLY.

DRW. G. BOCCATO	DWG# 550833.scm	PCB#	GENERALMUSIC S.p.A. ITALY
CKD. G. RICCI	DATE 21/12/2005		ALL RIGHTS ARE RESERVED. NO COPIES OR REPRODUCTIONS OF THIS DOCUMENT WITHOUT WRITTEN CONSENT BY GENERALMUSIC.
APP. R. FALCONI	REV: A	Procon 400p	

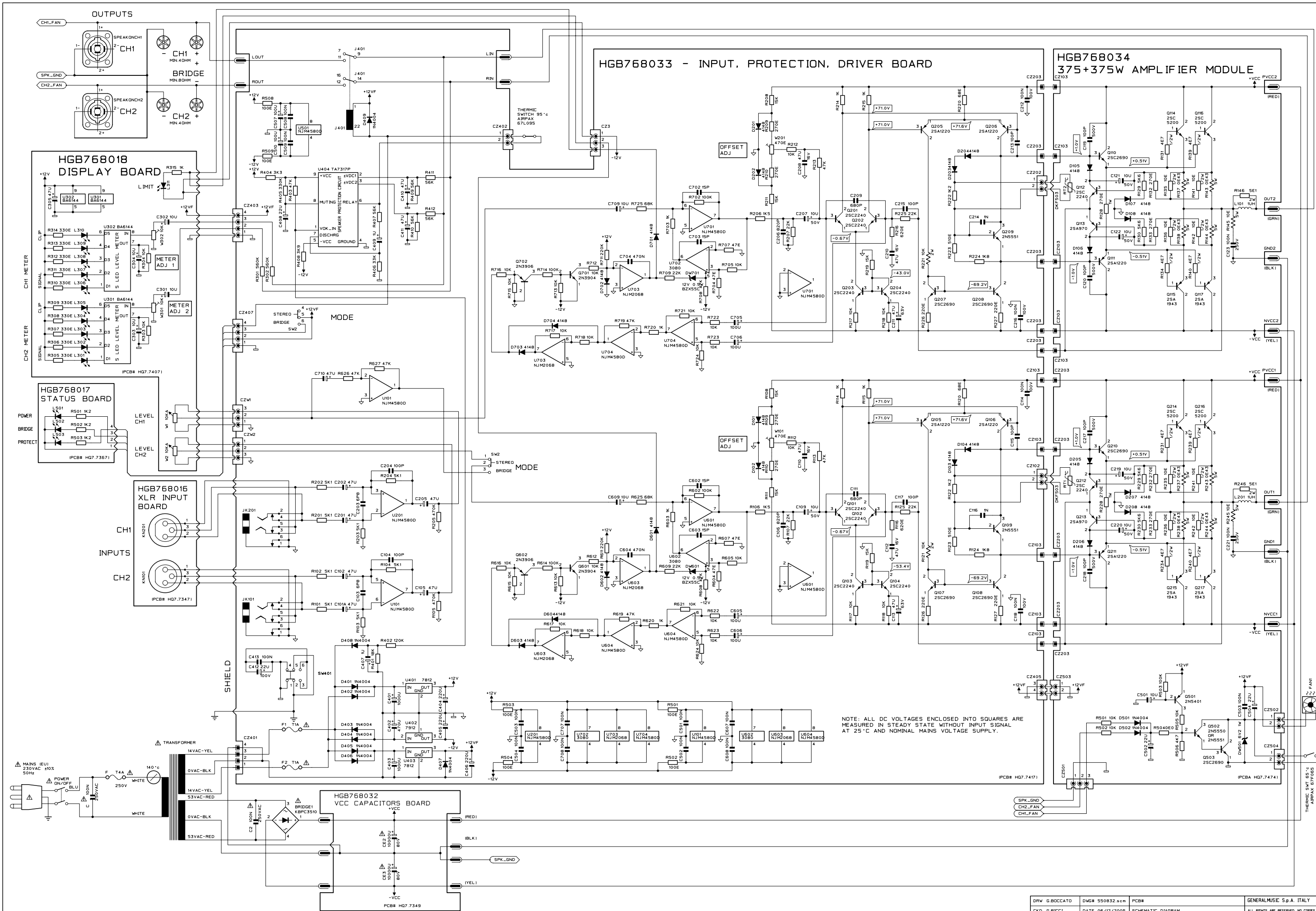

HGB768033 - INPUT, PROTECTION, DRIVER BOARD

HGB768034 375+375W AMPLIFIER MODULE

NOTE: ALL DC VOLTAGES ENCLOSED INTO SQUARES ARE MEASURED IN STEADY STATE WITHOUT INPUT SIGNAL AT 25°C AND NOMINAL MAINS VOLTAGE SUPPLY.

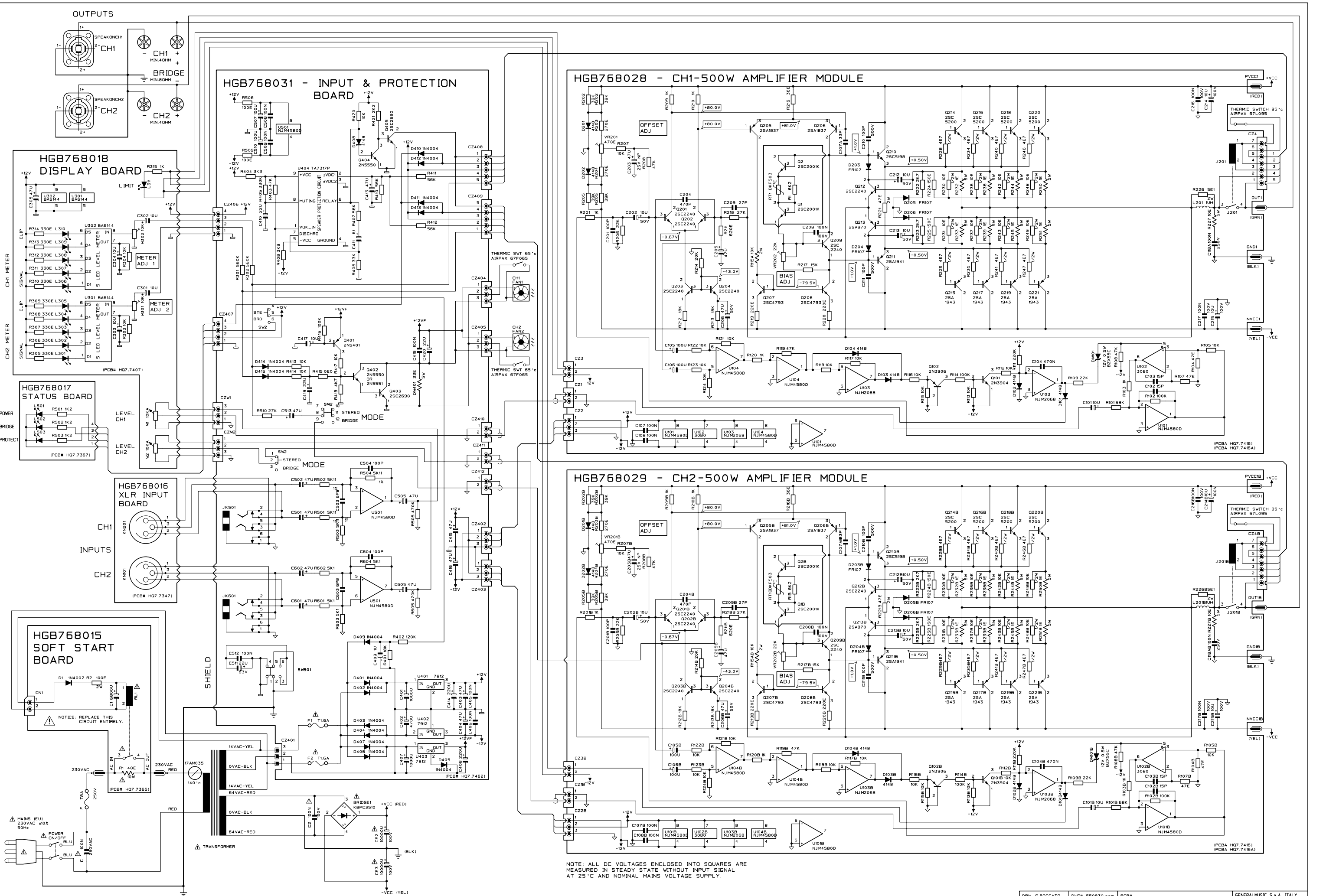

NOTE: ALL DC VOLTAGES ENCLOSED INTO SQUARES ARE MEASURED IN STEADY STATE WITHOUT INPUT SIGNAL AT 25 °C AND NOMINAL MAINS VOLTAGE SUPPLY.

DRW. G. BOCCATO	DWG. 550830.scm	PCB#	GENERALMUSIC S.p.A. ITALY
CKD. G. RICCI	DATE 16/03/2008	SCHEMATIC DIAGRAM	
APP. R. FALCONI	REV. B	Procon 1000p	

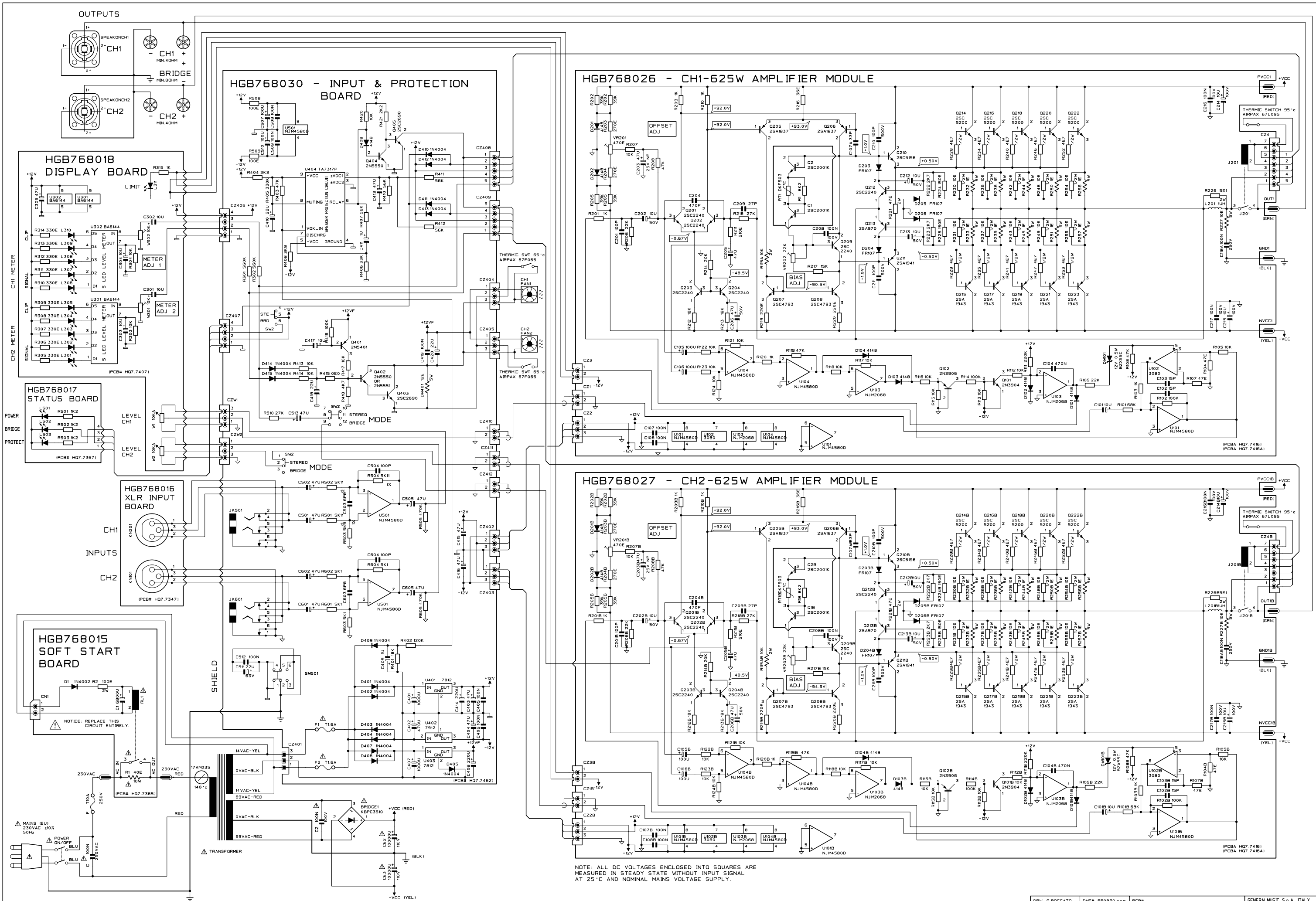

NOTE: ALL DC VOLTAGES ENCLOSED INTO SQUARES ARE MEASURED IN STEADY STATE WITHOUT INPUT SIGNAL AT 25°C AND NOMINAL MAINS VOLTAGE SUPPLY.

DRW G. BOCCATO	DWG# 550630.scm	PCB#	GENERALMUSIC S.p.A. ITALY
CKD G. RICCI	DATE 16/03/2006	REV: B	ALL RIGHTS ARE RESERVED. NO COPIES OR REPRODUCE THIS DOCUMENT WITHOUT WRITTEN CONSENT BY GENERALMUSIC.
APP. R. FALCONI		Praccon I250p	

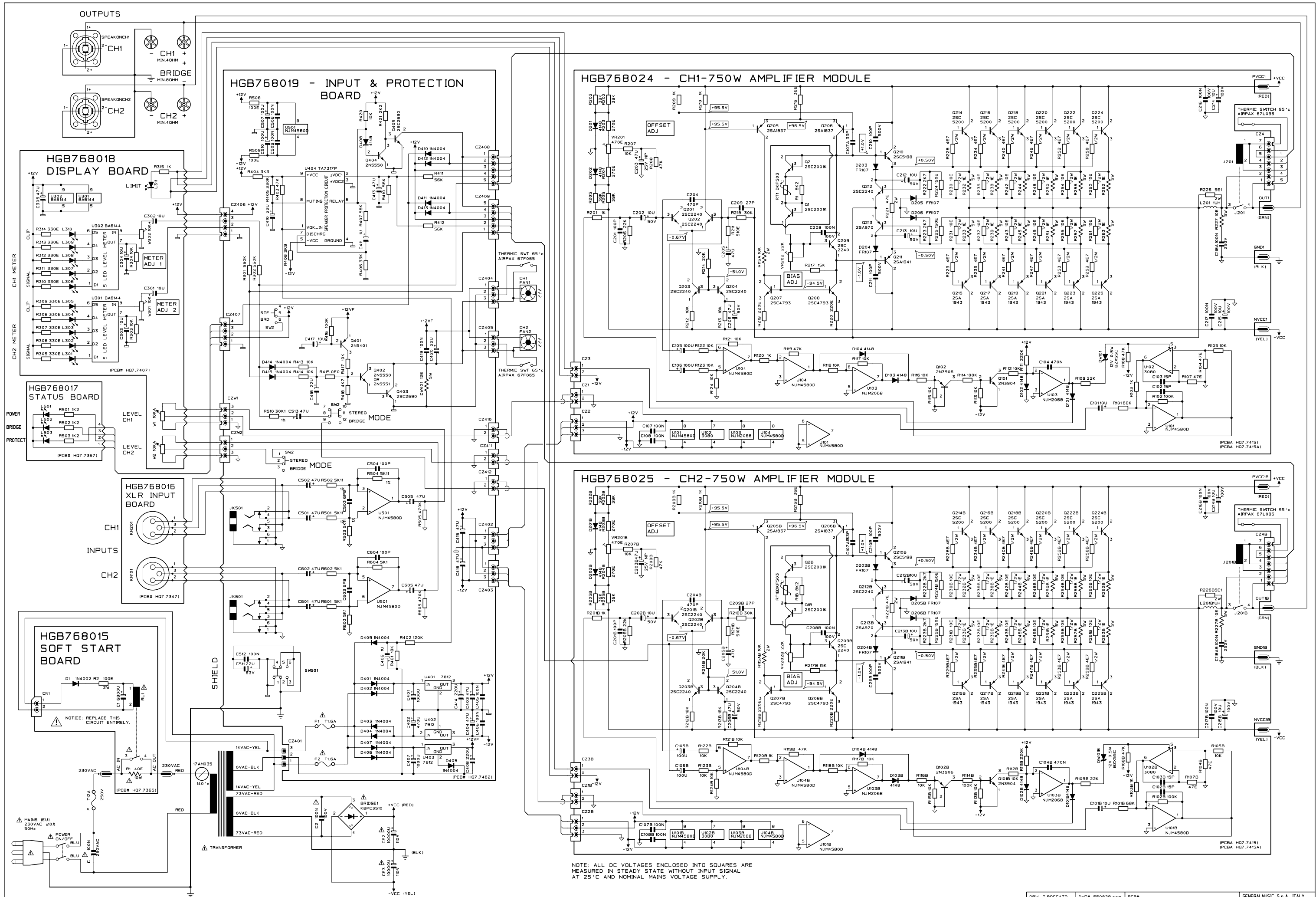

NOTE: ALL DC VOLTAGES ENCLOSED INTO SQUARES ARE MEASURED IN STEADY STATE WITHOUT INPUT SIGNAL AT 25°C AND NOMINAL MAINS VOLTAGE SUPPLY.

DRW G. BOCCATO	DWG 550829.scm	PCB#	GENERALMUSIC S.p.A. ITALY
CKD G. RICCI	DATE 16/03/2008	SCHMATIC DIAGRAM	ALL RIGHTS ARE RESERVED. NO COPIES OR REPRODUCE THIS DOCUMENT WITHOUT WRITTEN CONSENT BY GENERALMUSIC.
APP. R. FALCONI	REV: B	Procon 1500p	

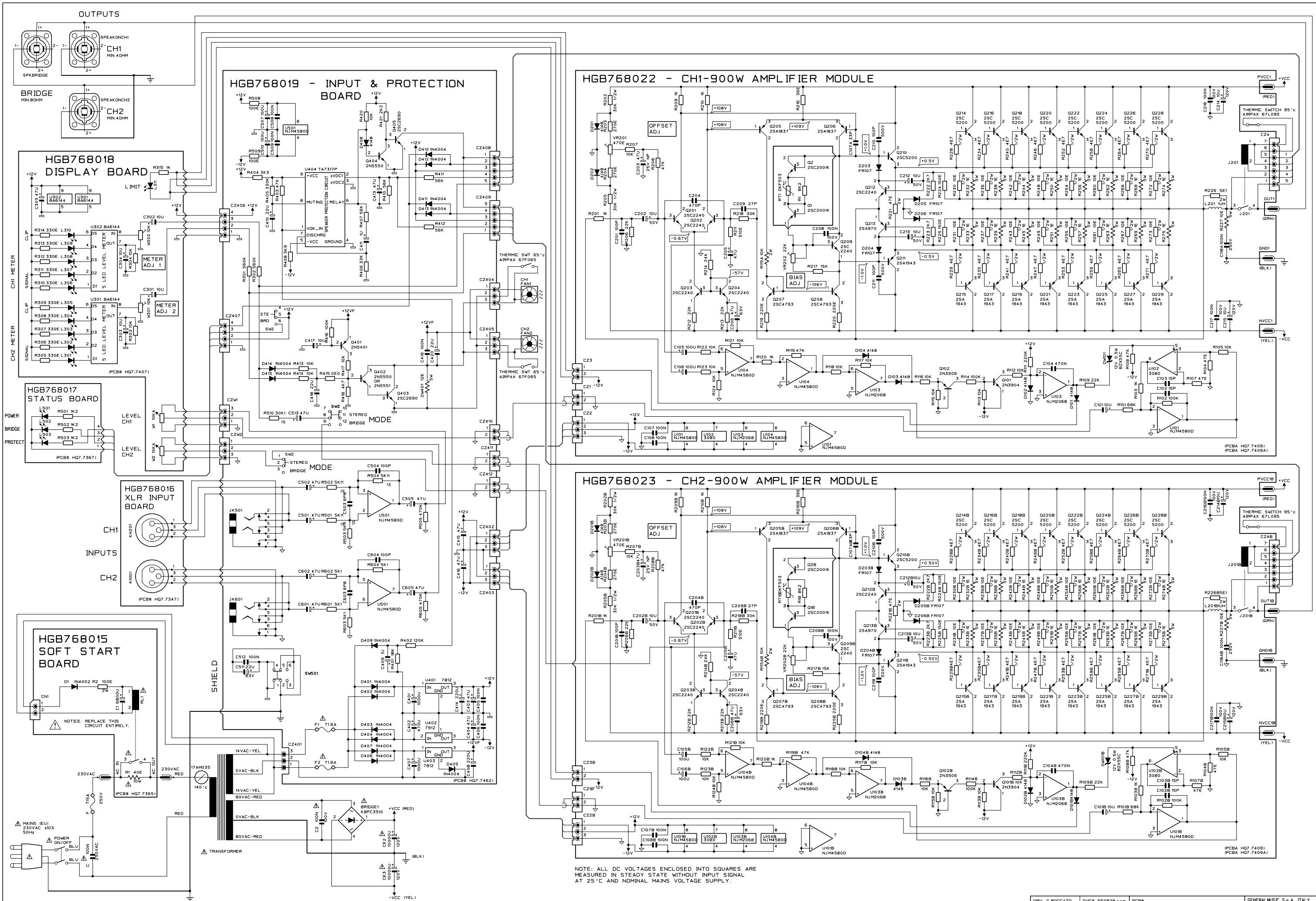

HGB768022 - CH1-900W AMPLIFIER MODULE

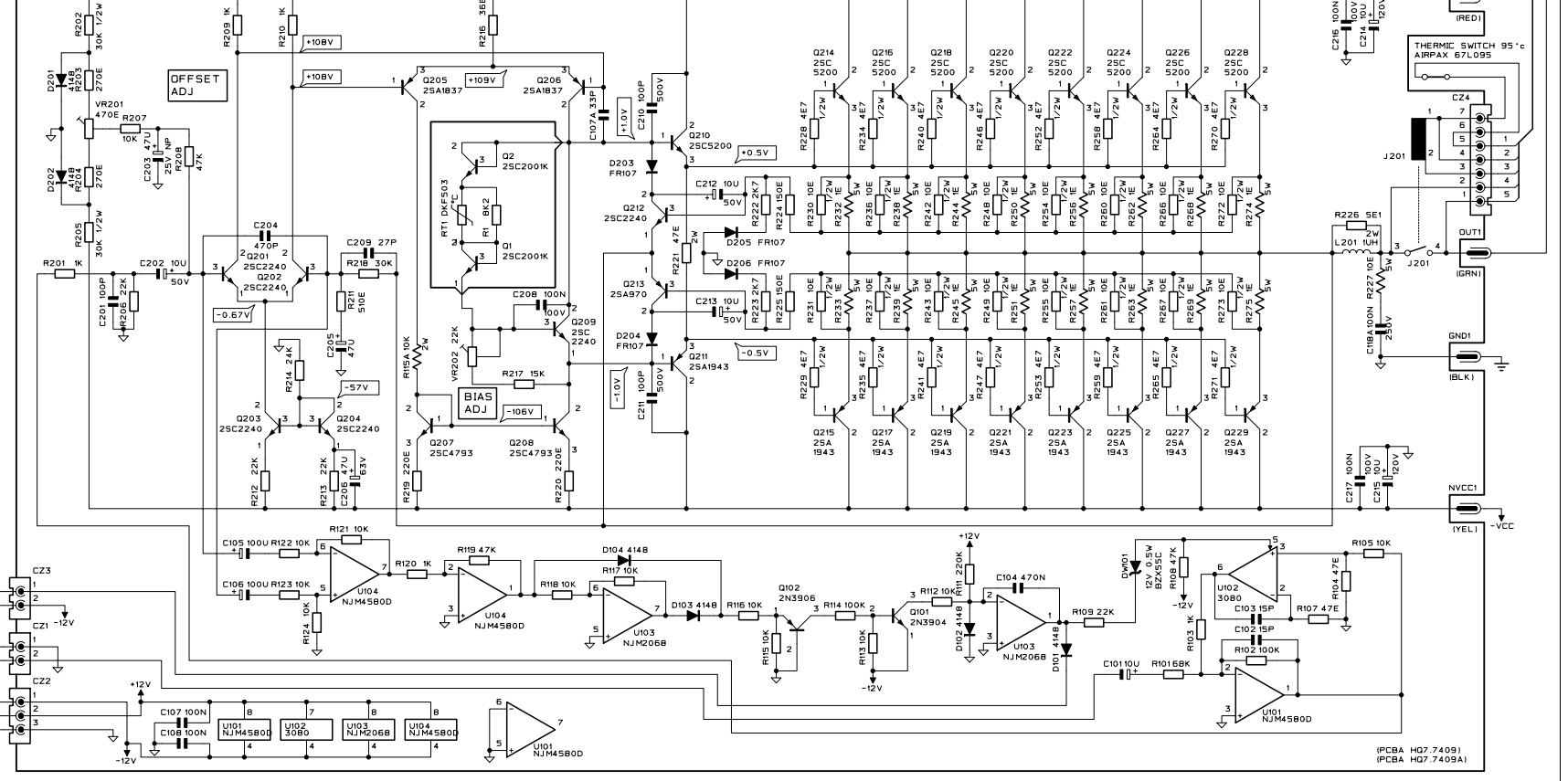

HGB768023 - CH2-900W AMPLIFIER MODULE

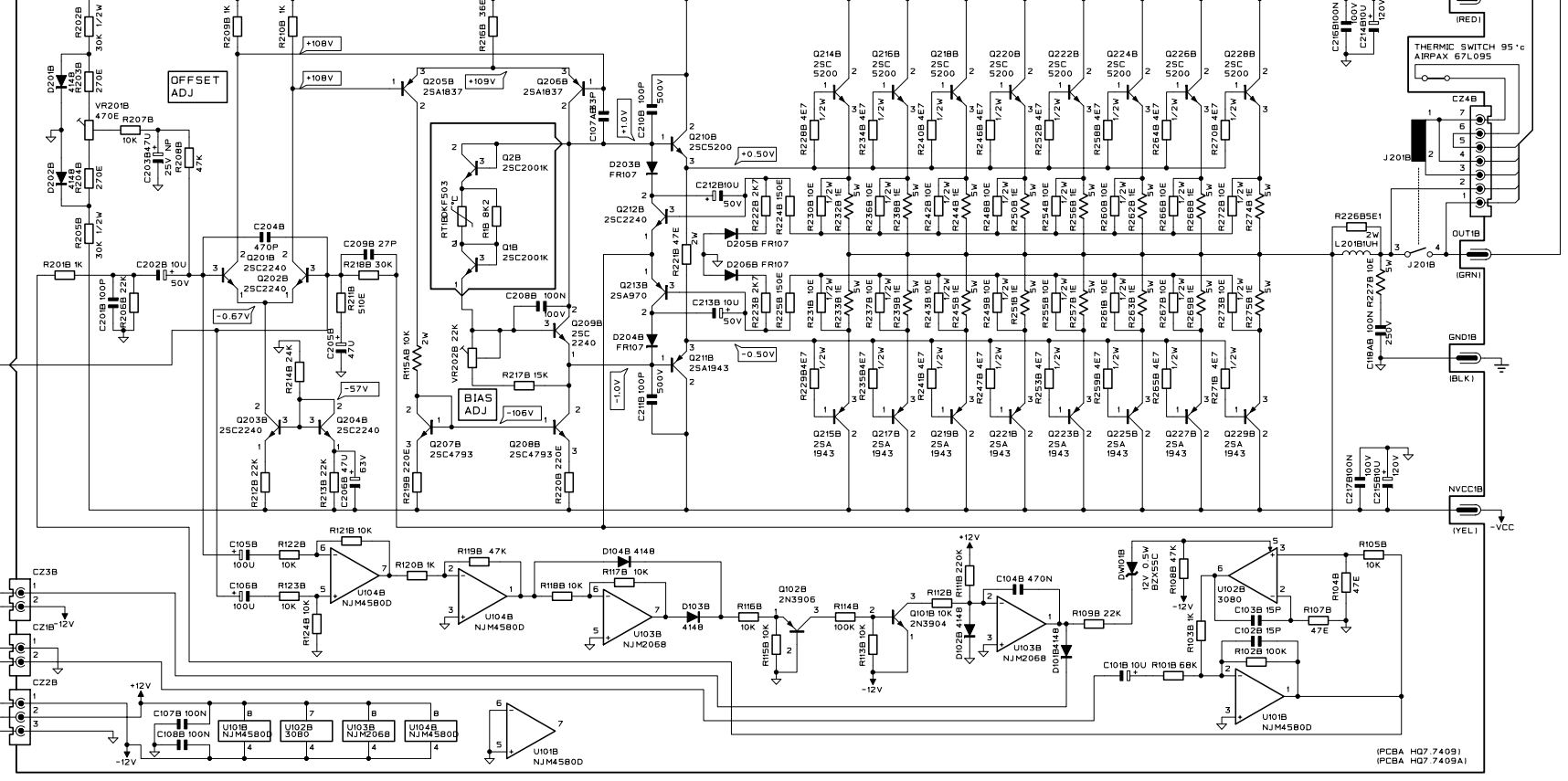

NOTE: ALL DC VOLTAGES ENCLOSED IN SQUARES ARE MEASURED IN STEADY STATE WITHOUT INPUT SIGNAL AT 25 °C AND NOMINAL MAINS VOLTAGE SUPPLY.

DRW G. BOCCATO	DWG# 550628.scm	PCB#	GENERALMUSIC S.p.A. ITALY
CKD G. RICCITI	DATE 16/03/2006	SCHEMATIC DIAGRAM	ALL RIGHTS ARE RESERVED. NO COPIES OR REPRODUCTIONS OF THIS DOCUMENT WITHOUT WRITTEN CONSENT BY GENERALMUSIC.
APP. R. FALCONI	REV: B	Praccon 1800p	

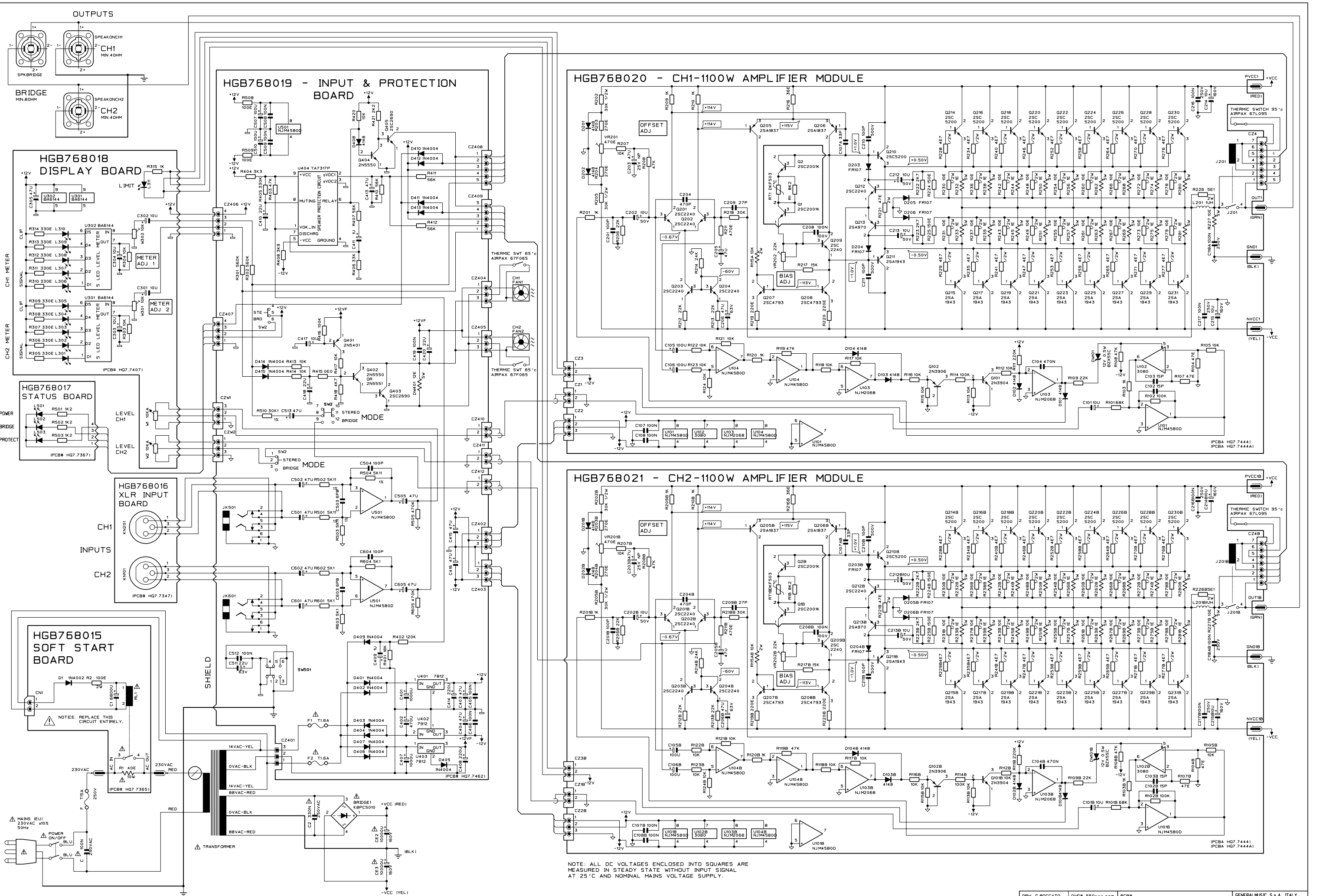

NOTE: ALL DC VOLTAGES ENCLOSED INTO SQUARES ARE MEASURED IN STEADY STATE WITHOUT INPUT SIGNAL AT 25°C AND NOMINAL MAINS VOLTAGE SUPPLY.

DRW G.BOCCATI	DWG 550xx.scm	PCB#	GENERALMUSIC S.p.A. ITALY
CKD G.RICCI	DATE 16/03/2006	SCHMATIC DIAGRAM	ALL RIGHTS ARE RESERVED. NO COPIES OR REPRODUCE THIS DOCUMENT WITHOUT WRITTEN CONSENT BY GENERALMUSIC.
APP. R.FALCONI	REV: B	Procon 2200p	

Spare Part List

Legend	
code	description
Miscellaneous Parts	
130285	Mains Cable (EU)
110291	16A 250Vac Bipolar Power Switch
020493	100n 250Vac MKP EMI Capacitor
110003	T3.15A Fuse 5X20mm (Procon400P)
110029	T4A Fuse 5X20mm (Procon750P)
110023	T8A Fuse 5X20mm (Procon1000P)
110030	T10A Fuse 5X20mm (Procon1250P)
110040	T12A Fuse 6.3X32mm (Procon1500P)
110041	T15A Fuse 6.3X32mm (Procon1800P/2200P)
HGB110100	Panel Fuse Holder for 5x20mm fuses
HGB110101	Panel Fuse Holder for 6.3x32mm fuses
HGB238007	Transformer 230Vac 550W (EU) (Procon 400P)
HGB238008	Transformer 230Vac 920W (EU) (Procon 750P)
HGB238009	Transformer 230Vac 1480W (EU) (Procon 1000P)
HGB238010	Transformer 230Vac 1660W (EU) (Procon 1250P)
HGB238011	Transformer 230Vac 2090W (EU) (Procon 1500P)
HGB238012	Transformer 230Vac 2680W (EU) (Procon 1800P)
HGB238013	Transformer 230Vac 3170W (EU) (Procon 2200P)
HGB080801	KBPC3510 35A 1000V Rectifier Diode Bridge (Procon 400P...1800P)
HGB080802	KBPC5010 50A 1000V Rectifier Diode Bridge (Procon 2200P)
141200	Speakon Socket (NL4MP Neutrik)
HGB347001	Volume Knob
HGB140000	Dual Red/Blk Binding Post
HGB110300	12Vdc 0.25A 80x25mm Fan (Procon 400P...1000P)
HGB110302	12Vdc 0.45A 80x25mm Fan (Procon 1250P...2200P)
HGB110305	Thermostat 65° NO 67F065 Airpax
HGB110306	Thermostat 95° NC 67L095 Airpax
110360	Fan Grid 80mm
HGB030004	10000uF 160V Electrolytic Capacitor Screw-Terminal (Procon2200P)
HGB030003	10000uF 120V Electrolytic Capacitor Screw-Terminal (Procon1800P)
HGB030002	10000uF 110V Electrolytic Capacitor Screw-Terminal (Procon1250P/1500P)
HGB030001	10000uF 100V Electrolytic Capacitor Screw-Terminal (Procon1000P)

Soft Start Board

HGB768015	Soft Start Board (Pcb# HQ7.7365) (Procon 1000P...2200P)
HGB110303	Relay 12V / 1 Switch 30A 240Vac NO
080156	1N4002 1A 100V Rectifier Diode
030862	6800uF 25V Electrolytic Capacitor
HGB061002	40E 10W 5% Wire Resistor

VCC Capacitor Board

HGB768035	VCC Capacitor Board (Pcb# HQ7.7349) (Procon 400P)
HGB768032	VCC Capacitor Board (Pcb# HQ7.7349) (Procon 750P)
030884	10000uF 80V Electrolytic Capacitor Snap-In (Procon750P)
HGB030005	12000uF 63V Electrolytic Capacitor Snap-In (Procon400P)
HGB768016	XLR Input Board (Pcb# HQ7.7347)(All Models)
HGB140002	Hor Female XLR Socket

Display Board

HGB768001	Display Board (PCBA HQ7.7407)(All Models)
HGB075001	10KA RK16 Rotary Potentiometer K15 40CLK
HGB100001	BA6144 5-Point Led Level Meter
080705	3mm Red Led
080706	3mm Green Led
080710	3mm Yellow Led

Status Board

HGB768017	Status Board (PCBA HQ7.7367)(All Models)
080705	3mm Red Led

Input, Protection, Driver Board

HGB768036	Input, Protection, Driver Board (PCBA HQ7.7417)(Procon 400P)
HGB768033	Input, Protection, Driver Board (PCBA HQ7.7417)(Procon 750P)
HGB140004	2sw 2pos H Slider Switch
HGB140003	Jack Horizontal S-F Socket
HGB110301	Relay 12V / 2 Switch 10A 250Vac
HGB100000	TA7317P Speaker Protection Circuit
100045	7812 +12V 1A Voltage Regulator
100043	7912 -12V 1A Voltage Regulator
100971	NJM4580D Dual LN Operational Amplifier
SKK100000	NJM2068D Dual LN Operational Amplifier
100004	LM3080 Single Operational Transconctance Amplifier
HGB090008	2SC2690 TO126 Npn Transistor (Procon 750P)
HGB090010	2SA1220 TO126 Pnp Transistor (Procon 750P)
HGB090000	2SC2240GR TO92 LN Npn Transistor
HGB090017	2SD667AC TO92L Npn Transistor (Procon 400P)
HGB090018	2SB647AC TO92L Pnp Transistor (Procon 400P)
090200	2N5551 TO92 Npn Transistor
HGB090019	2N3904 TO92 Npn Transistor
HGB090020	2N3906 TO92 Pnp Transistor

080272	12V 1W 5% Zener Diode
080158	1N4004 1A 400V Rectifier Diode
080103	1N4148 100mA 75V Signal Diode
110011	T1A Fuse 5x20mm (EU)

Dual Channel Amplifier Module

HGB768034	375+375W Amplifier Module (PCBA HQ7.7474)(Procon 400P)
HGB768037	200+200W Amplifier Module (PCBA HQ7.7473)(Procon 750P)
HGB090008	2SC2690 TO126 Npn Transistor
HGB090010	2SA1220 TO126 Pnp Transistor
HGB090014	2SA1943 TO264 Pnp Transistor (Procon 750P)
HGB090013	2SC5200 TO264 Npn Transistor (Procon 750P)
HGB090006	2SA1941 TO3P/TO218 Pnp Transistor (Procon 400P)
HGB090005	2SC5198 TO3P/TO218 Npn Transistor (Procon 400P)
HGB090000	2SC2240GR TO92 LN Npn Transistor
HGB090004	2SA970GR TO92 LN Pnp Transistor
HGB080800	Ntc type DKF503 (Thermometrics)
080158	1N4004 1A 400V Rectifier Diode
080103	1N4148 100mA 75V Signal Diode
HGB060089	0E43 5W 5% Wire Resistor

Input, Protection, Board

HGB768031	Input, Protection, Board (PCBA HQ7.7462)(Procon 1000P)
HGB768030	Input, Protection, Board (PCBA HQ7.7462)(Procon 1250P)
HGB768019	Input, Protection, Board (PCBA HQ7.7462)(Procon 1500P/1800P/2200P)
HGB140004	2sw 2pos H Slider Switch
HGB140005	4sw 2pos H Slider Switch
HGB140003	Jack Horizontal S-F Socket
HGB100000	TA7317P Speaker Protection Circuit
100045	7812 +12V 1A Voltage Regulator
100043	7912 -12V 1A Voltage Regulator
100971	NJM4580D Dual LN Operational Amplifier
HGB090008	2SC2690 TO126 Npn Transistor
090200	2N5551 TO92 Npn Transistor
090201	2N5401 TO92 Pnp Transistor
080158	1N4004 1A 400V Rectifier Diode
080103	1N4148 100mA 75V Signal Diode
110012	T1.6A Fuse 5x20mm (EU)

Single Amplifier Module

HGB768029	CH2-500W Amplifier Module (Pcb# HQ7.7416)(Procon 1000P)
HGB768028	CH1-500W Amplifier Module (Pcb# HQ7.7416)(Procon 1000P)
HGB768027	CH2-625W Amplifier Module (Pcb# HQ7.7416)(Procon 1250P)
HGB768026	CH1-625W Amplifier Module (Pcb# HQ7.7416)(Procon 1250P)
HGB768025	CH2-750W Amplifier Module (Pcb# HQ7.7415)(Procon 1500P)
HGB768024	CH1-750W Amplifier Module (Pcb# HQ7.7415)(Procon 1500P)
HGB768023	CH2-900W Amplifier Module (Pcb# HQ7.7409)(Procon 1800P)
HGB768022	CH1-900W Amplifier Module (Pcb# HQ7.7409)(Procon 1800P)
HGB768021	CH2-1100W Amplifier Module (Pcb# HQ7.7444)(Procon 2200P)
HGB768020	CH1-1100W Amplifier Module (Pcb# HQ7.7444)(Procon 2200P)
HGB110304	Relay 12V / 1 Switch 30A 240Vac NO
100971	NJM4580D Dual LN Operational Amplifier
SKK100000	NJM2068D Dual LN Operational Amplifier
100004	LM3080 Single Operational Transconctance Amplifier
HGB090013	2SC5200 TO264 Npn Transistor
HGB090014	2SA1943 TO264 Pnp Transistor
HGB090005	2SC5198 TO3P/TO218 Npn Transistor
HGB090006	2SA1941 TO3P/TO218 Pnp Transistor
HGB090015	2SC4793 TO220P Npn Transistor
HGB090016	2SA1837 TO220P Pnp Transistor
HGB090000	2SC2240GR TO92 LN Npn Transistor
HGB090004	2SA970GR TO92 LN Pnp Transistor
HGB090001	2SC2001K TO92 Npn Transistor
HGB090019	2N3904 TO92 Npn Transistor
HGB090020	2N3906 TO92 Pnp Transistor
080272	12V 1W 5% Zener Diode
HGB080800	Ntc type DKF503 (Thermometrics)
HGB080000	FR107 OR BA159 Fast Rec Diode 1A 1000V 500ns DO41
HGB061000	10K 4W 5% Resistor
080158	1N4004 1A 400V Rectifier Diode
080103	1N4148 100mA 75V Signal Diode
060151	1E 5W 5% Wire Resistor

Note:

Each spare part is single quantity unless otherwise specified.

Asterisk prefix explanation:

Omitted = First level spare part.

One asterisk = Second level, part of previous listed first level part.

Two asterisk = Third level, part of previous listed second level part.

Three asterisk=

Any request for not above mentioned part must encompass specific description including:

- 1) Model name,
- 2) Section name,
- 3) Module code,
- 4) Reference name,
- 5) Quantity number.

