

KSS-213CCM CD MAIN PCB : 6870S-361AA

OPTION

IC801
KA9220B
PRE-SIGNAL &
SERVO SIGNAL
PROCESSOR

IC802
KS9282B
DIGITAL SIGNAL
PROCESSOR

IC803
KA9258BD
4CH BTL
DRIVER

IC804
KA8301

IC805
KA3082

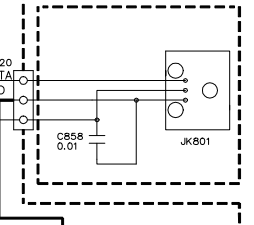
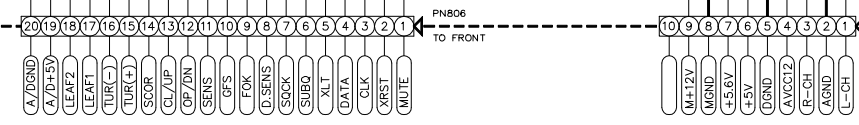
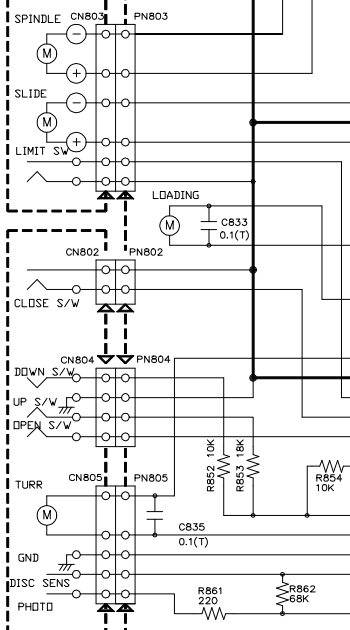

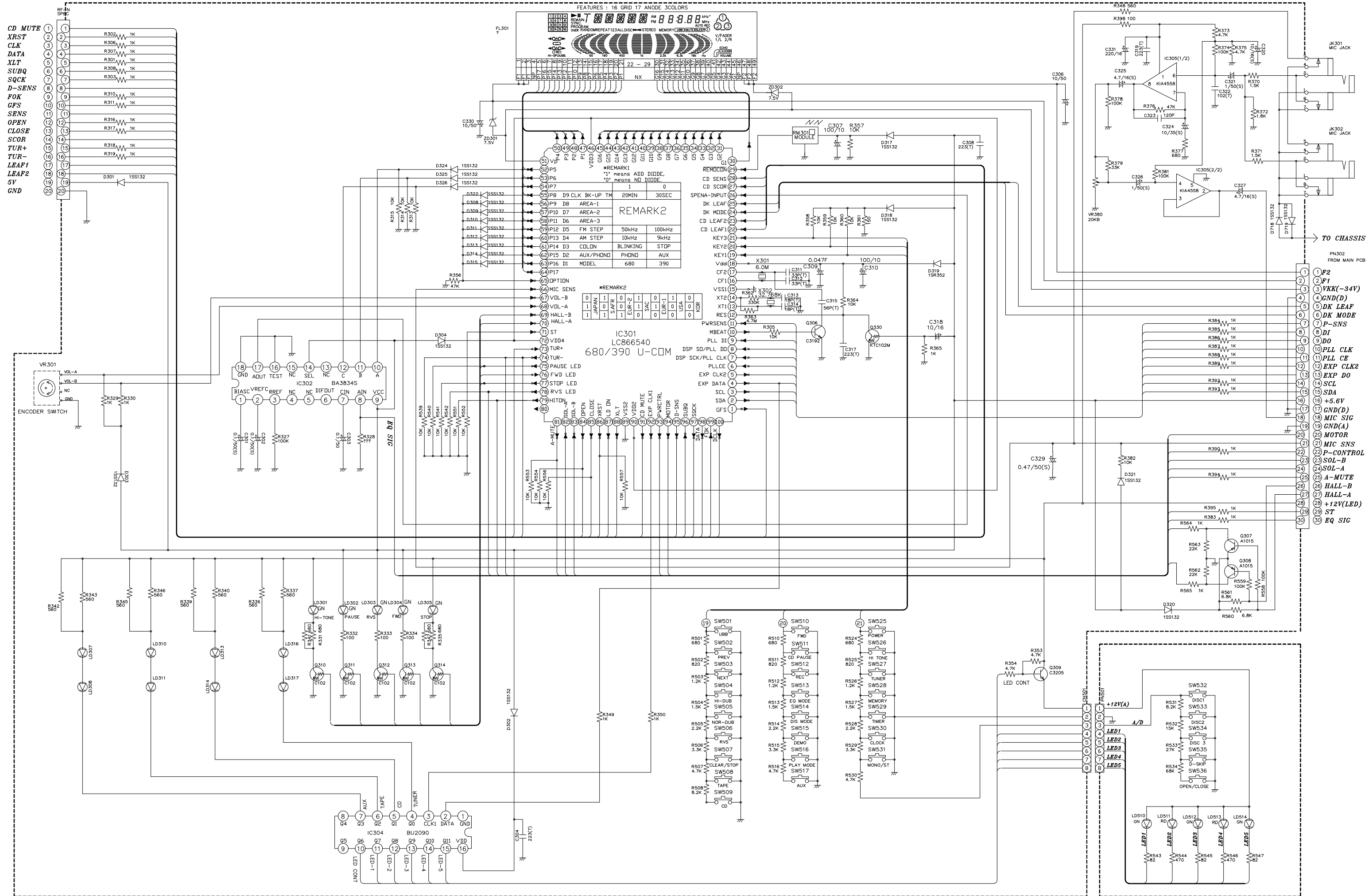

- 1 CD MUTE
- 2 XRST
- 3 CLK
- 4 DATA
- 5 XLT
- 6 SUBQ
- 7 SQCK
- 8 D-SENS
- 9 FOK
- 10 GFS
- 11 SENS
- 12 OPEN
- 13 CLOSE
- 14 SCOR
- 15 TUR+
- 16 TUR-
- 17 LEAF1
- 18 LEAF2
- 19 5V
- 20 GND

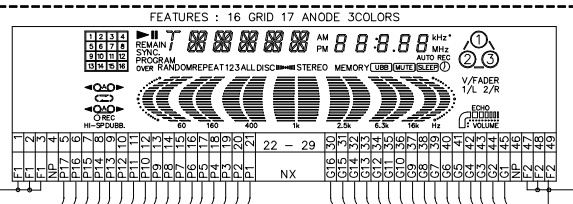

REMARK1
*1 means ADD DIODE.
*0 means NO DIODE.

D322	ISS132	1	0
D308	ISS132	20MIN	30SEC
D309	ISS132	AREA-1	
D310	ISS132	AREA-2	
D311	ISS132	AREA-3	
D312	ISS132	50kHz	100kHz
D313	ISS132	10kHz	9kHz
D314	ISS132	BLINKING	STDP
D315	ISS132	AUX/PHONO	AUX
D316	ISS132	MODEL	680 390

REMARK2

0	JAPAN	0	0	1	0	1	0	0	0
1	SAFAR	1	0	0	0	0	0	0	0
1	EUR-2	1	0	0	0	0	0	0	0
1	SAC	0	1	0	0	0	0	0	0
1	EUR-1	0	0	0	0	0	0	0	0
0	USA	0	0	0	0	0	0	0	0
0	KDR	0	0	0	0	0	0	0	0

IC301
LC866540
680/390 U-COM

1	ST
2	VDD4
3	TUR+
4	TUR-
5	PAUSE LED
6	FWD LED
7	STOP LED
8	RVS LED
9	HITON
10	A-MUTE
11	SOL-B
12	SOL-A
13	DPEN
14	CLDSE
15	XRST
16	XLT
17	VJDE
18	CD MUTE
19	EXP CLK1
20	PWCTRL
21	MOTOR
22	D-SNS
23	SUBQ
24	DATA
25	CLK
26	LD
27	LD
28	LD
29	LD
30	LD

- 1 F2
- 2 F1
- 3 VKK(-34V)
- 4 GND(D)
- 5 DK LEAF
- 6 DK MODE
- 7 P-SNS
- 8 DI
- 9 DO
- 10 PLL CLK
- 11 PLL CE
- 12 EXP CLK2
- 13 EXP DO
- 14 SCL
- 15 SDA
- 16 +5.6V
- 17 GND(D)
- 18 MIC SIG
- 19 GND(A)
- 20 MOTOR
- 21 MIC SNS
- 22 P-CONTROL
- 23 SOL-B
- 24 SOL-A
- 25 A-MUTE
- 26 HALL-B
- 27 HALL-A
- 28 +12V(LED)
- 29 ST
- 30 EQ SIG

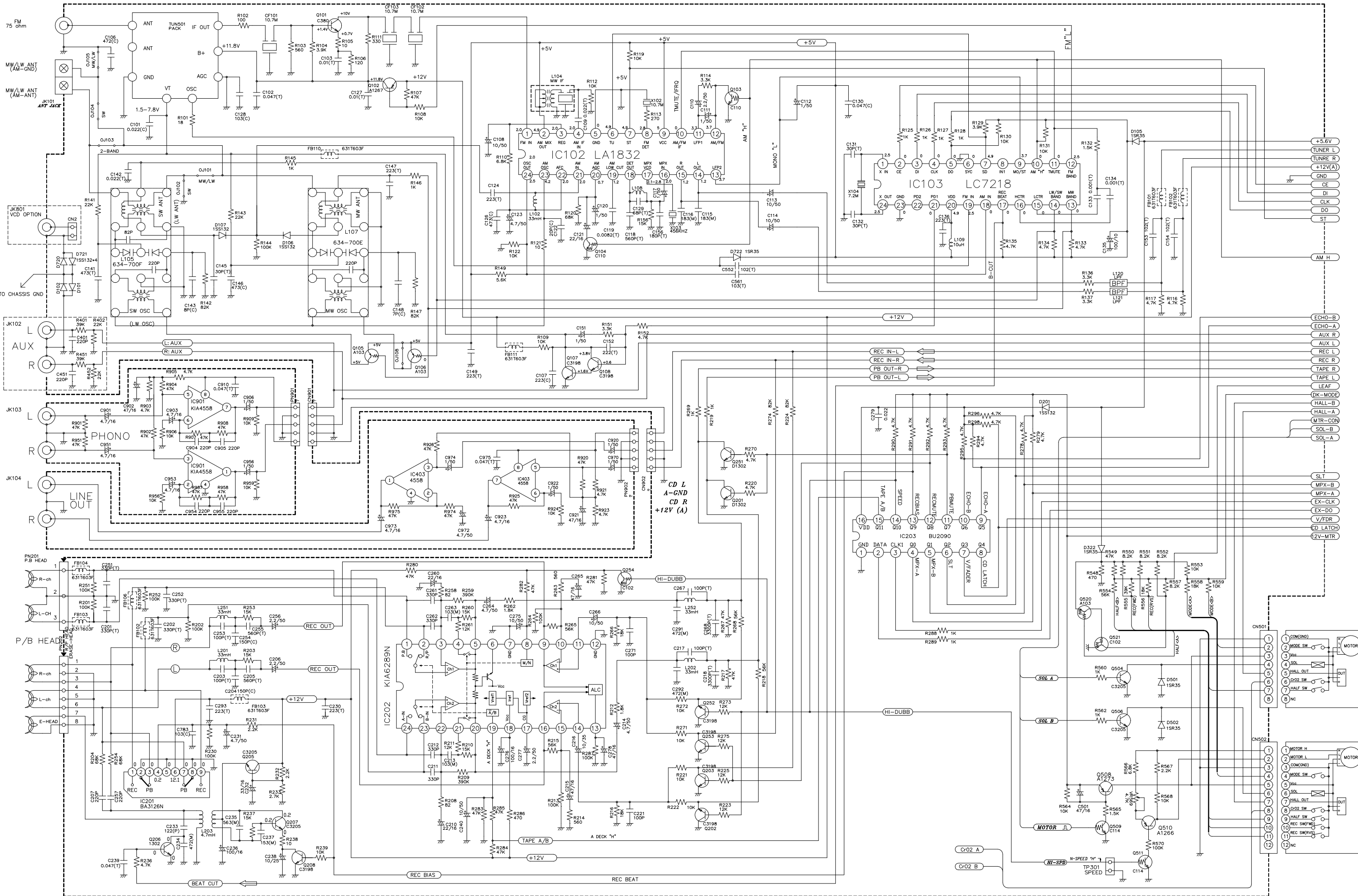

- +5.6V
- TUNER L
- +12V(A)
- GND
- CE
- DI
- CLK
- DO
- ST

- ECHO-B
- ECHO-A
- AUX L
- AUX R
- REC L
- REC R
- TAPE R
- TAPE L
- LEAF
- DK-MODE
- HALL-B
- HALL-A
- MTR-CON
- SOL-B
- SOL-A

- SLT
- MPX-B
- MPX-A
- EX-CLK
- EX-DO
- V/DTR
- CD LATCH
- Q2V-MTR

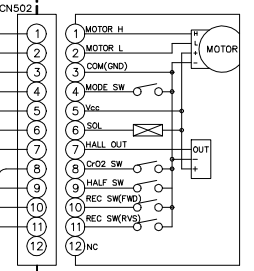
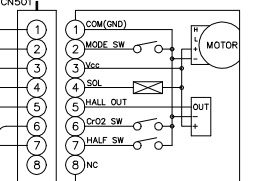

- Gr02 A
- Gr02 B

HI-SPD N-SPEED 'H'
TP.301 SPEED