



SERVICE MANUAL

MODELS : HDR899/1000

# DVB-T/HDD/DVD RECORDER

## SERVICE MANUAL

**MODELS : HDR899/1000**

**CAUTION**

BEFORE SERVICING THE UNIT, READ THE "SAFETY PRECAUTIONS"  
IN THIS MANUAL.



## **CONTENTS**

**SECTION 1.....SUMMARY**

**SECTION 2.....CABINET & MAIN CHASSIS**

**SECTION 3.....ELECTRICAL**

**SECTION 4.....RS-06A LOADER PART**

**SECTION 5.....REPLACEMENT PARTS LIST**

# SECTION 1

## SUMMARY

### CONTENTS

<b>NEW FUNCTIONS OF HDD/DVD RECORDER .....</b>	<b>1-3</b>
<b>PRODUCT SAFETY SERVICING GUIDELINES FOR HDD/DVD RECORDER PRODUCTS .....</b>	<b>1-4</b>
<b>SERVICING PRECAUTIONS.....</b>	<b>1-5</b>
• GENERAL SERVICING PRECAUTIONS	
• INSULATION CHECKING PRODEDURE	
• ELECTROSTATICALLY SENSITIVE (ES) DEVICES	
<b>SERVICE INFORMATION FOR EEPROM IC SETTING.....</b>	<b>1-6</b>
<b>UPGRADE THE MAIN &amp; LOADER PROGRAM.....</b>	<b>1-7</b>
<b>SPECIFICATIONS .....</b>	<b>1-8</b>

# NEW FUNCTIONS OF HDD/DVD RECORDER

## • HDMI

HDMI IS THE SPECIFICATION FOR THE HIGH-DEFINITION MULTIMEDIA INTERFACE. HDMI IS PROVIDED FOR TRANSMITTING DIGITAL TELEVISION AUDIOVISUAL SIGNALS FROM HDD-DVD RECORDER TO TELEVISION SETS, OTHER VIDEO DISPLAYS. HDMI CAN CARRY HIGH QUALITY MULTI-CHANNEL AUDIO DATA AND CAN CARRY ALL STANDARD AND HIGH DEFINITION CONSUMER ELECTRONICS VIDEO FORMATS. CONTENT PROTECTION TECHNOLOGY IS AVAILABLE. HDMI CAN ALSO CARRY CONTROL AND STATUS INFORMATION IN BOTH DIRECTIONS.

<< OPERATING >>

AUDIO, VIDEO AND AUXILIARY DATA IS TRANSMITTED ACROSS THE THREE TMDS DATA CHANNELS. THE VIDEO PIXEL CLOCK IS TRANSMITTED ON THE TMDS CLOCK CHANNEL AND USED BY THE RECEIVER AS A FREQUENCY REFERENCE FOR DATA RECOVERY ON THE THREE TMDS DATA CHANNELS.

VIDEO DATA IS CARRIED AS A SERIES OF 24-BIT PIXELS ON THE THREE TMDS DATA CHANNELS.

TMDS ENCODING CONVERTS THE 8BIT PER CHANNEL INTO THE 10BIT DC-BALANCED.

VIDEO PIXEL RATES CAN RANGE FROM 25MHz TO 165MHz. THE VIDEO PIXELS CAN BE ENCODED IN EITHER RGB, YCbCr 4:4:4 OR YCbCr 4:2:2 FORMATS. IN ALL THREE CASES, UP TO 24 BITS PER PIXEL CAN BE TRANSFERRED.

## FAST DUBBING

DUBBING MEANS A COPYING FUNCTION BETWEEN HDD TO DVD DISCS.

COPYING BETWEEN HDD TO DVD IS A COMPLETELY DIGITAL PROCESS AND THEREFORE INVOLVES NO LOSS OF QUALITY IN THE AUDIO OR VIDEO. SO THIS MEANS THAT COPYING CAN BE CARRIED OUT AT THE MAXIMUM SPEED POSSIBLE.

<< DUBBING SPEED RATE >>

NORMAL DUBBING : SPEED RATE MAX X1

FAST DUBBING : SPEED RATE MAX X4

WHEN FAST DUBBING FROM HDD TO DVD, THE SPEED OF COPYING DEPENDS ON THE RECORDING MODE AND THE KIND OF USING THE DVD DISC, AND THIS MODE IS NOT AVAILABLE FOR EDITED VIDEO TITLE IN HDD.

WHEN FAST DUBBING FROM DVD TO HDD, ONLY AVAILABLE WHEN COPYING VR MODE DISC(DVD-RW) TO HDD, AND ONLY NORMAL DUBBING AVAILABLE WHEN COPYING VIDEO MODE DISC(DVD+RW/RW, DVD-R) TO HDD.

# PRODUCT SAFETY SERVICING GUIDELINES FOR HDD/DVD RECORDER PRODUCTS

## IMPORTANT SAFETY NOTICE

This manual was prepared for use only by properly trained audio-video service technicians.

When servicing this product, under no circumstances should the original design be modified or altered without permission from LG Corporation. All components should be replaced only with types identical to those in the original circuit and their physical location, wiring and lead dress must conform to original layout upon completion of repairs.

Special components are also used to prevent x-radiation, shock and fire hazard.

These components are indicated by the letter "X" included in their component designators and are required to maintain safe performance. No deviations are allowed without prior approval by LG Corporation.

Circuit diagrams may occasionally differ from the actual circuit used. This way, implementation of the latest safety and performance improvement changes into the set is not delayed until the new service literature is printed.

**CAUTION :** Do not attempt to modify this product in any way. Never perform customized installations without manufacturer's approval. Unauthorized modifications will not only void the warranty, but may lead to property damage or user injury.

Service work should be performed only after you are thoroughly familiar with these safety checks and servicing guidelines.

## GRAPHIC SYMBOLS



The exclamation point within an equilateral triangle is intended to alert the service personnel to important safety information in the service literature.



The lightning flash with arrowhead symbol within an equilateral triangle is intended to alert the service personnel to the presence of non-insulated "dangerous voltage" that may be of sufficient magnitude to constitute a risk of electric shock.



The pictorial representation of a fuse and its rating within an equilateral triangle is intended to convey to the service personnel the following fuse replacement caution notice:

**CAUTION :** FOR CONTINUED PROTECTION AGAINST RISK OF FIRE, REPLACE ALL FUSES WITH THE SAME TYPE AND RATING AS MARKED NEAR EACH FUSE.

## SERVICE INFORMATION

While servicing, use an isolation transformer for protection from AC line shock. After the original service problem has been corrected, make a check of the following:

### FIRE AND SHOCK HAZARD

1. Be sure that all components are positioned to avoid a possibility of adjacent component shorts. This is especially important on items transported to and from the repair shop.
2. Verify that all protective devices such as insulators, barriers, covers, shields, strain reliefs, power supply cords, and other hardware have been reinstalled per the original design. Be sure that the safety purpose of the polarized line plug has not been defeated.
3. Soldering must be inspected to discover possible cold solder joints, solder splashes, or sharp solder points. Be certain to remove all loose foreign particles.
4. Check for physical evidence of damage or deterioration to parts and components, for frayed leads or damaged insulation (including the AC cord), and replace if necessary.
5. No lead or component should touch a high current device or a resistor rated at 1 watt or more. Lead tension around protruding metal surfaces must be avoided.
6. After reassembly of the set, always perform an AC leakage test on all exposed metallic parts of the cabinet (the channel selector knobs, antenna terminals, handle and screws) to be sure that set is safe to operate without danger of electrical shock. **DO NOT USE A LINE ISOLATION TRANSFORMER DURING THIS TEST.** Use an AC voltmeter having 5000 ohms per volt or more sensitivity in the following manner: Connect a 1500 ohm, 10 watt resistor, paralleled by a .15 mfd 150V AC type capacitor between a known good earth ground water pipe, conduit, etc.) and the exposed metallic parts, one at a time. Measure the AC voltage across the combination of 1500 ohm resistor and .15 mfd capacitor. Reverse the AC plug by using a non-polarized adaptor and repeat AC voltage measurements for each exposed metallic part. Voltage measured must not exceed 0.75 volts RMS. This corresponds to 0.5 milliamp AC. Any value exceeding this limit constitutes a potential shock hazard and must be corrected immediately.

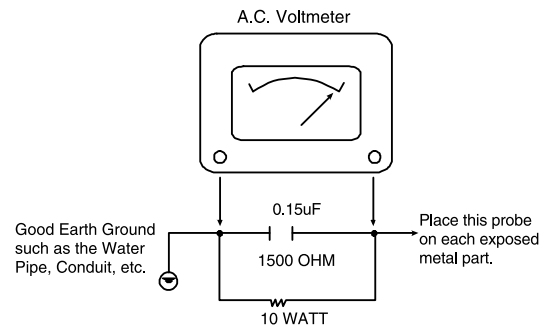

## TIPS ON PROPER INSTALLATION

1. Never install any receiver in a closed-in recess, cubbyhole, or closely fitting shelf space over, or close to, a heat duct, or in the path of heated air flow.
2. Avoid conditions of high humidity such as: outdoor patio installations where dew is a factor, near steam radiators where steam leakage is a factor, etc.
3. Avoid placement where draperies may obstruct venting. The customer should also avoid the use of decorative scarves or other coverings that might obstruct ventilation.
4. Wall- and shelf-mounted installations using a commercial mounting kit must follow the factory-approved mounting instructions. A product mounted to a shelf or platform must retain its original feet (or the equivalent thickness in spacers) to provide adequate air flow across the bottom. Bolts or screws used for fasteners must not touch any parts or wiring. Perform leakage tests on customized installations.
5. Caution customers against mounting a product on a sloping shelf or in a tilted position, unless the receiver is properly secured.
6. A product on a roll-about cart should be stable in its mounting to the cart. Caution the customer on the hazards of trying to roll a cart with small casters across thresholds or deep pile carpets.
7. Caution customers against using extension cords. Explain that a forest of extensions, sprouting from a single outlet, can lead to disastrous consequences to home and family.

# SERVICING PRECAUTIONS

**CAUTION:** Before servicing the HDD / DVD RECORDER covered by this service data and its supplements and addends, read and follow the SAFETY PRECAUTIONS. NOTE: if unforeseen circumstances create conflict between the following servicing precautions and any of the safety precautions in this publications, always follow the safety precautions.

Remember Safety First :

## General Servicing Precautions

1. Always unplug the HDD / DVD RECORDER AC power cord from the AC power source before:
  - (1) Removing or reinstalling any component, circuit board, module, or any other assembly.
  - (2) Disconnecting or reconnecting any internal electrical plug or other electrical connection.
  - (3) Connecting a test substitute in parallel with an electrolytic capacitor.  
**Caution :** A wrong part substitution or incorrect polarity installation of electrolytic capacitors may result in an explosion hazard.
2. Do not spray chemicals on or near this HDD / DVD RECORDER or any of its assemblies.
3. Unless specified otherwise in this service data, clean electrical contacts by applying an appropriate contact cleaning solution to the contacts with a pipe cleaner, cotton-tipped swab, or comparable soft applicator.  
Unless specified otherwise in this service data, lubrication of contacts is not required.
4. Do not defeat any plug/socket B+ voltage interlocks with which instruments covered by this service manual might be equipped.
5. Do not apply AC power to this HDD / DVD RECORDER and / or any of its electrical assemblies unless all solidstate device heat sinks are correctly installed.
6. Always connect the test instrument ground lead to an appropriate ground before connecting the test instrument positive lead. Always remove the test instrument ground lead last.

## Insulation Checking Procedure

Disconnect the attachment plug from the AC outlet and turn the power on. Connect an insulation resistance meter (500V) to the blades of the attachment plug. The insulation resistance between each blade of the attachment plug and accessible conductive parts (Note 1) should be more than 1Mohm.

**Note 1 :** Accessible Conductive Parts include Metal panels, Input terminals, Earphone jacks, etc.

## Electrostatically Sensitive (ES) Devices

Some semiconductor (solid state) devices can be damaged easily by static electricity. Such components commonly are called Electrostatically Sensitive (ES) Devices. Examples of typical ES devices are integrated circuits and some field effect transistors and semiconductor chip components.

The following techniques should be used to help reduce the incidence of component damage caused by static electricity.

1. Immediately before handling any semiconductor component or semiconductor-equipped assembly, drain off any electrostatic charge on your body by touching a known earth ground. Alternatively, obtain and wear a commercially available discharging wrist strap device, which should be removed for potential shock reasons prior to applying power to the unit under test.
2. After removing an electrical assembly equipped with ES devices, place the assembly on a conductive surface such as aluminum foil, to prevent electrostatic charge buildup or exposure of the assembly.
3. Use only a grounded-tip soldering iron to solder or unsolder ES devices.
4. Use only an anti-static solder removal device. Some solder removal devices not classified as "anti-static" can generate electrical charges sufficient to damage ES devices.
5. Do not use freon-propelled chemicals. These can generate an electrical charge sufficient to damage ES devices.
6. Do not remove a replacement ES device from its protective package until immediately before you are ready to install it. (Most replacement ES devices are packaged with leads electrically shorted together by conductive foam, aluminum foil, or comparable conductive material).
7. Immediately before removing the protective material from the leads of a replacement ES device, touch the protective material to the chassis or circuit assembly into which the device will be installed.

**Caution:** Be sure no power is applied to the chassis or circuit, and observe all other safety precautions.

8. Minimize bodily motions when handling unpackaged replacement ES devices. (Normally harmless motion such as the brushing together of your clothes fabric or the lifting of your foot from a carpeted floor can generate static electricity sufficient to damage an ES device.)

# SERVICE INFORMATION FOR EEPROM IC SETTING

1. Please the CLEAR button on the remote together with ▲ OPEN the Front Panel about 6 sec.



The picture on OSD will be bellow ;

Model :

	Disc	Read Time
	DVD	018 Sec OK
	CD	021 Sec NG
OP1 : 00	00000000	M : 10.013
OP2 : 00	00000000	E : FF(OR)
OP3 : 00	00000000	
OP4 : 00	00000000	
OP5 : 00	00000000	
OP6 : 00	00000000	
OP7 : 00	00000000	Write : OK
OP8 : 00	00000000	Exit : MP
OP9 : 00	00000000	Move : <>
OPA : 00	00000000	Edit :



2. To MOVE from OP! to another option. Please ◀▶ button on the remote control.
3. To CHANGE the Option Code. Please ⬆ button on the remote control.
4. To APPLY the Option Code. After change the option press ENTER button on remote control.
5. To INITIALIZE the system. Press CLEAR button on the remotecontrol together with OPEN on the Front panel about 2sec.
6. To exit from the Option Code menu without Initialize the system.  
Just turn off the power and turn on again.

# UPGRADE THE MAIN & LOADER PROGRAM

## 1. MAKING UPGRADE DISC

- 1) Do Physical format as ISO9660 or JOLIET file system
- 2) Don't care about the CD Volume label
- 3) Write RH300 B\_E & LOADER file on Root
- 4) Write I\_O file on Root

Note) You can't write steps 3 and 4 on the same disc.  
Use the different disc to write another step.

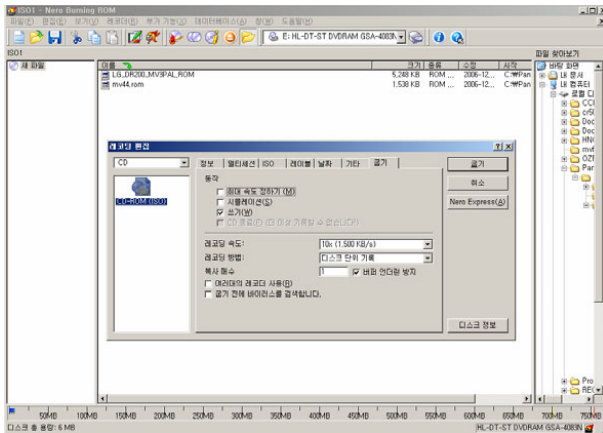

### \* OPTIONAL PARTS

- 1) B\_E  
LG\_RH300\_UPDATE\_PAL.ROM
- 2) LOADER  
DvdS617.rs.6, Yas617.din
- 3) I\_O  
io\_micom\_update.hex

## 2. UPGRADE FLASH (MAIN & LOADER) and I\_O

- 1) Put Upgrde DISC on the Set
- 2) After Disc Reading, You can see below screen



### \* OPTIONAL PARTS

- 1) MAIN  
ONLY B\_E UPGRADE
- 2) LOADER  
ONLY LOADER UPGRADE
- 3) ALL  
B\_E & LOADER UPGRADE

- 3) Press ENTER (or OK) KEY.

You can see both current and upgrade version.



- 4) Press PLAY KEY.

Start upgrading.



- 5) After upgrading, Automatically open tray.

Eject the Disc.

Reboot the Set

- 6) Put I\_O update disc and repeat 1) ~ 5)



# SPECIFICATIONS

## • GENERAL

Power requirements	AC 200-240V, 50/60 Hz
Power consumption	30W
Dimensions (approx.)	430 X 49 X 275mm (w x h x d) without foot
Net weight (approx.)	4kg
Operating temperature	5°C to 35°C
Operating humidity	5% to 65%
Television system	PAL I, B/G, I/I, SECAM D/K, K1 color system
Recording format	PAL

## • RECORDING

Recording format	DVD Video Recording, DVD-VIDEO
Recordable media	HDD (320GB), DVD-RW, DVD-R, DVD+RW, DVD+R, DVD+R (Double Layer), DVD-RAM
Recordable time	DVD (4.7GB): Approx. 1 hour (XP mode), 2 hours (SP mode), 4 hours (LP mode), 6 hours (EP mode), 14 hours (MLP mode) DVD+R DL (8.5GB): Approx. 3hours (XP mode), 3.8 hours (SP mode), 7.3 hours (LP mode), 9.1 hours (EP mode), 21 hours (MLP mode) HDD (320GB, MPEG2 Recording): Approx. 85 hours (XP mode), 165 hours (SP mode), 323 hours (LP mode), 456 hours (EP mode), 935 hours (MLP mode)

## Video recording format

Sampling frequency	27MHz
Compression format	MPEG2 (VBR supported)

## Audio recording format

Sampling frequency	48kHz
Compression format	Dolby Digital

## • PLAYBACK

Frequency response	DVD (PCM 48kHz): 8Hz to 22kHz, CD: 8Hz to 20kHz DVD (PCM 96kHz): 8Hz to 44kHz
Signal-to-noise ratio	More than 90dB (AUDIO OUT connector)
Harmonic distortion	Less than 0.02% (AUDIO OUT connector)

## • INPUTS

Dynamic range	More than 95dB (AUDIO OUT connector)
ANTENNA IN	Antenna input, 75ohms
VIDEO IN	1.0 Vp-p 75ohms, sync negative, RCA jack x 1 / SCART x 2
AUDIO IN	2.0 Vrms more than 47kohms, RCA jack (L, R) x 1 / SCART x 2
DV IN	4 pin (IEEE 1394 standard)
USB IN	4 pin (USB 1.1 standard)

## • OUTPUTS

VIDEO OUT	1Vp-p 75Ω, sync negative, SCART x 2
S-VIDEO OUT	(Y) 1.0V (p-p), 75Ω, sync negative, Mini DIN 4-pin x 1(C) 0.3V (p-p) 75Ω
COMPONENT VIDEO OUT	(Y) 1.0V (p-p), 75Ω, sync negative, RCA jack x 1, (PB)/(PR) 0.7V (p-p), 75Ω, RCA jack x 2
HDMI video/audio output	19 pin (HDMI standard, Type A)
Audio output (digital audio)	0.5V (p-p), 75Ω, RCA jack x 1
Audio output (optical audio)	3V (p-p), Optical connector x 1
Audio output (analog audio)	2Vrms (1kHz, 0dB), 600Ω, RCA jack (L, R) x 2 / SCART x 2

# SECTION 2

## CABINET & MAIN CHASSIS

### CONTENTS

<b>EXPLODED VIEWS</b> .....	2-2
1. CABINET AND MAIN FRAME SECTION .....	2-2
2. DECK MECHANISM SECTION (RS-06A).....	2-3
3. PACKING ACCESSORY SECTION.....	2-4



## 2. DECK MECHANISM SECTION (RS-06A)

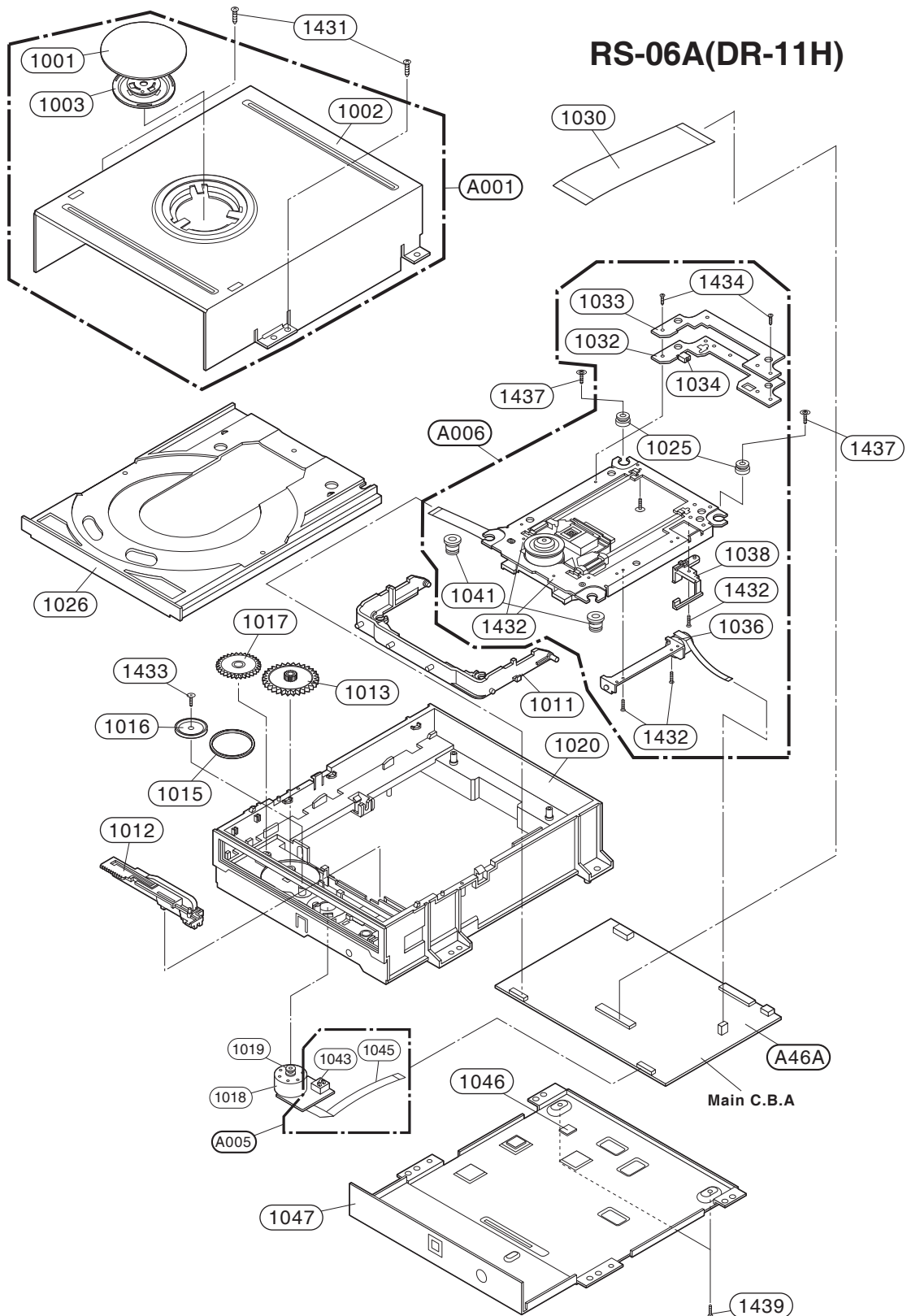

### 3. PACKING ACCESSORY SECTION

★ OPTIONAL PARTS

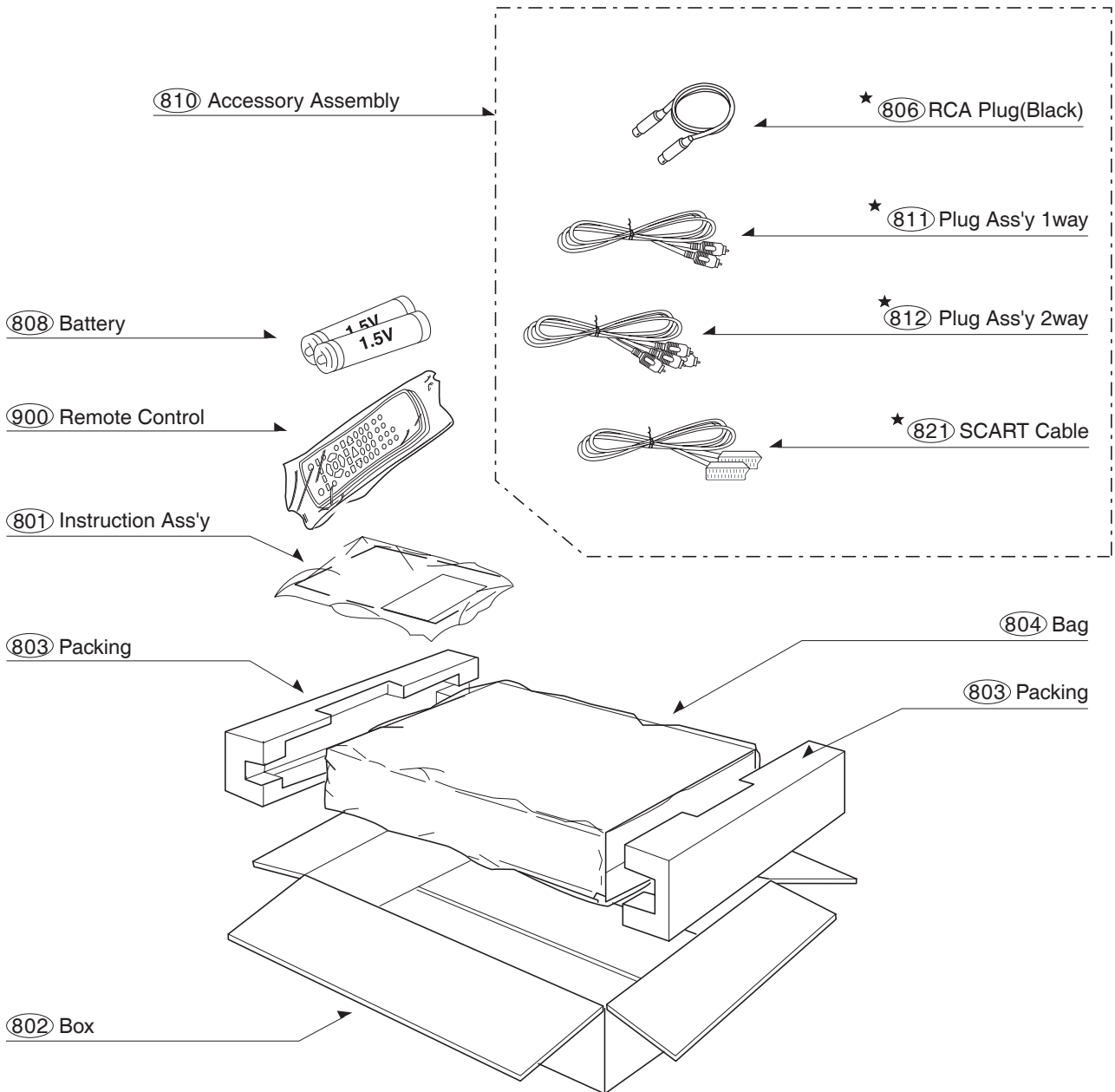

# SECTION 3

## ELECTRICAL

### CONTENTS

<p><b>ELECTRICAL TROUBLESHOOTING GUIDE</b>.....3-2</p> <p>1. POWER SUPPLY ON SMPS BOARD .....3-2</p> <p>2. POWER SUPPLY ON I/O BOARD .....3-4</p> <p>3. SYSTEM CIRCUIT PART .....3-9</p> <p>4. DISC NOT RECOGNIZED.....3-9</p> <p>5. WHEN PLAYING DISC, NO AUDIO OUTPUT .....3-10</p> <p>6. NO OPTICAL/DIGITAL OUTPUT .....3-11</p> <p>7. NO TUNER AUDIO OUTPUT .....3-12</p> <p>8. NO EXTERNAL AUDIO INPUT .....3-13</p> <p>9. NO RGB/COMPONENT VIDEO SIGNAL WHEN PLAY DISC .....3-14</p> <p>10. NO COMPOSITE/S-VIDEO SIGNAL WHEN PLAY DISC.....3-15</p> <p>11. NO TV, EXTERNAL INPUT VIDEO SIGNAL.....3-16</p> <p>12. NO DV (IEEE1394) INPUT (VIDEO/AUDIO) SIGNAL.....3-17</p> <p><b>WAVEFORMS</b>.....3-18</p> <p>1. SMPS BLOCK .....3-18</p> <p>2. SYSTEM BLOCK .....3-20</p> <p>3. VIDEO BLOCK (COLOR BAR INPUT).....3-23</p> <p>4. AUDIO BLOCK (1kHz SINEWAVE INPUT)....3-24</p> <p>5. SERIAL INTERFACE BLOCK (BETWEEN MAIN AND I/O) .....3-25</p> <p>6. TUNER BLOCK.....3-26</p> <p>7. HDMI BLOCK .....3-27</p> <p><b>WIRING CONNECTION DIAGRAM</b>.....3-28</p> <p>1. WIRING CONNECTION DIAGRAM 1 .....3-28</p> <p>2. WIRING CONNECTION DIAGRAM 2 .....3-29</p> <p>3. WIRING CONNECTION DIAGRAM 3 .....3-30</p>	<p><b>BLOCK DIAGRAMS</b>.....3-31</p> <p>1. VERALL BLOCK DIAGRAM.....3-31</p> <p>2. SMPS BLOCK DIAGRAM .....3-32</p> <p>3. POWER MAIN BLOCK DIAGRAM .....3-33</p> <p>4. POWER I/O BLOCK DIAGRAM.....3-34</p> <p>5. A/V BLOCK DIAGRAM .....3-35</p> <p>6. AUDIO OUT BLOCK DIAGRAM .....3-36</p> <p>7. HDMI BLOCK DIAGRAM .....3-37</p> <p><b>CIRCUIT DIAGRAMS</b>.....3-39</p> <p>1. SMPS 1 CIRCUIT DIAGRAM.....3-39</p> <p>2. SMPS 2 CIRCUIT DIAGRAM.....3-41</p> <p>3. MPEG CIRCUIT DIAGRAM.....3-43</p> <p>4. FLASH/DDR/DV CIRCUIT DIAGRAM.....3-45</p> <p>5. ATAPI, HDMI &amp; USB CIRCUIT DIAGRAM ....3-47</p> <p>6. I/O, <math>\mu</math>-COM CIRCUIT DIAGRAM .....3-49</p> <p>7. DECODER &amp; MIC CIRCUIT DIAGRAM.....3-51</p> <p>8. SCART/RCA CIRCUIT DIAGRAM .....3-53</p> <p>9. HDMI CIRCUIT DIAGRAM .....3-55</p> <p>10. TIMER CIRCUIT DIAGRAM (8 &amp; 9 TOOLS) ...3-57</p> <p>11. KEY CIRCUIT DIAGRAM (8 &amp; 9 TOOLS) .....3-59</p> <p>• <b>CIRCUIT VOLTAGE CHART</b> .....3-61</p> <p><b>PRINTED CIRCUIT BOARD DIAGRAMS</b>...3-65</p> <p>1. MAIN P.C.BOARD .....3-65</p> <p>2. I/O P.C.BOARD.....3-67</p> <p>3. POWER P.C.BOARD .....3-71</p> <p>4. TIMER &amp; KEY P.C.BOARD.....3-73</p> <p>5. HDMI P.C.BOARD .....3-75</p>
---	--

# ELECTRICAL TROUBLESHOOTING GUIDE

## 1. POWER SUPPLY ON SMPS BOARD

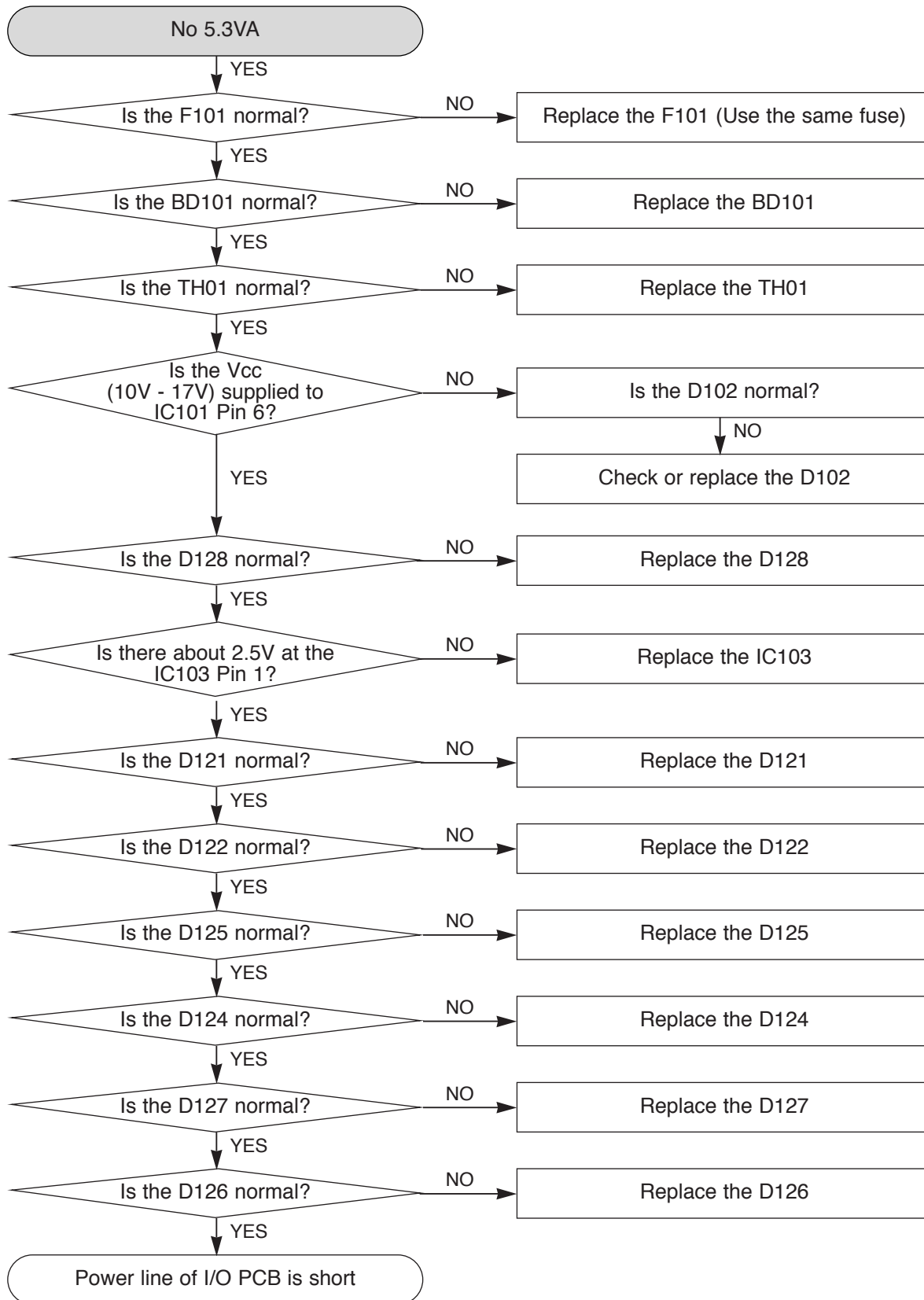

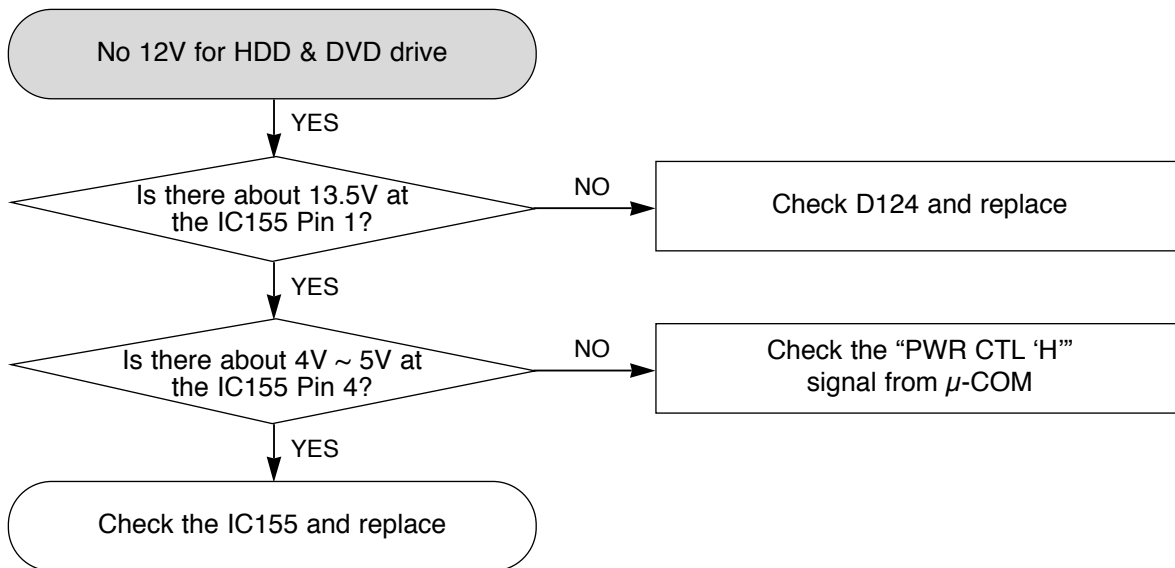
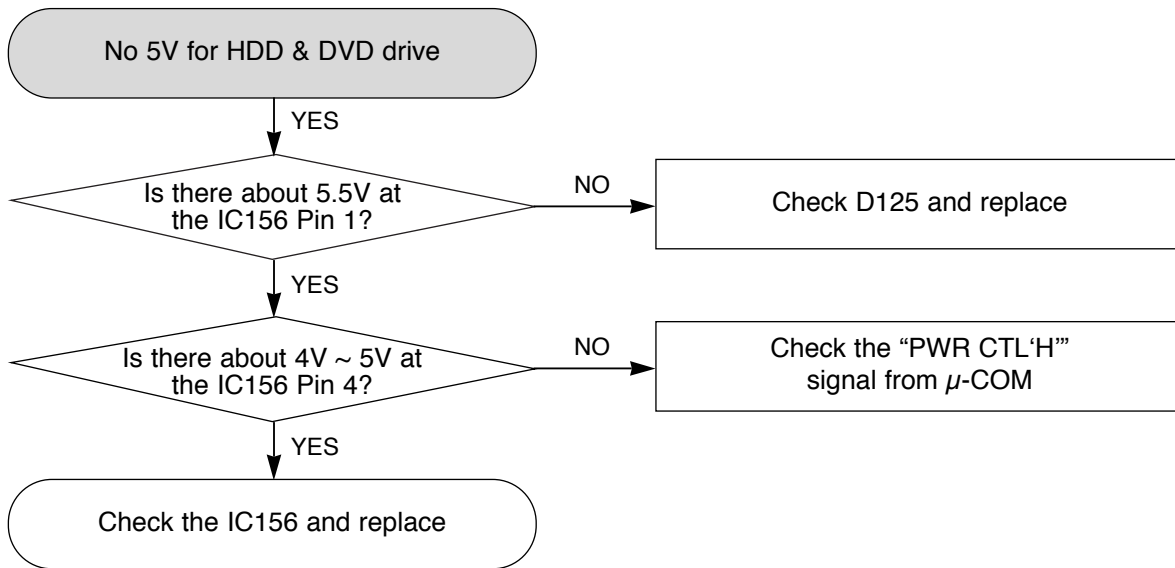



## 2. POWER SUPPLY ON I/O BOARD

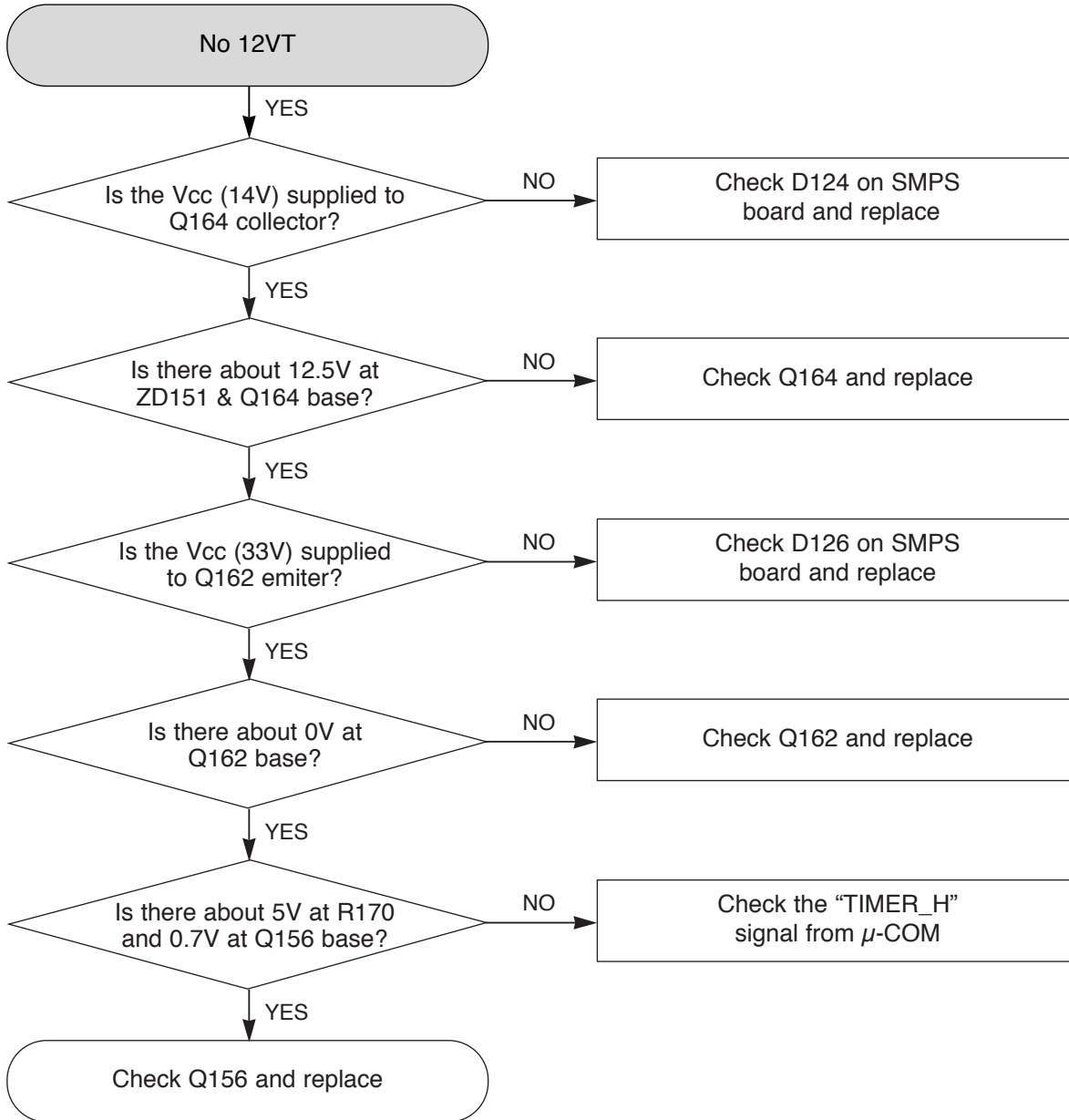

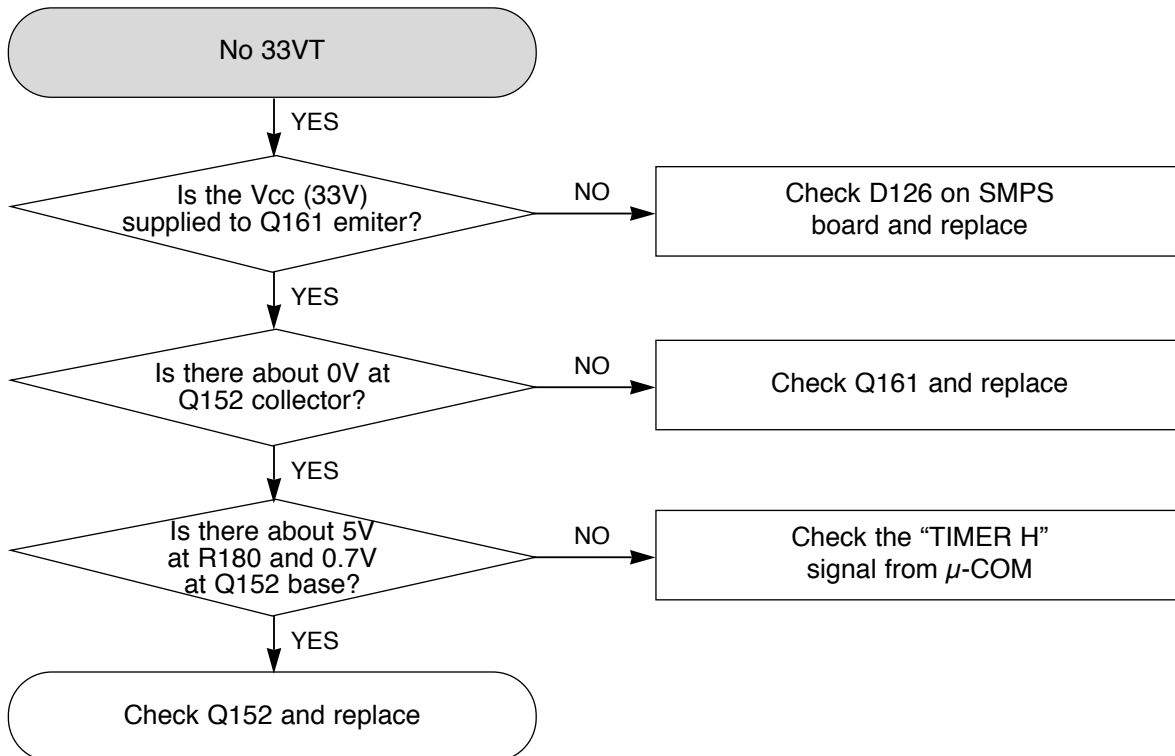
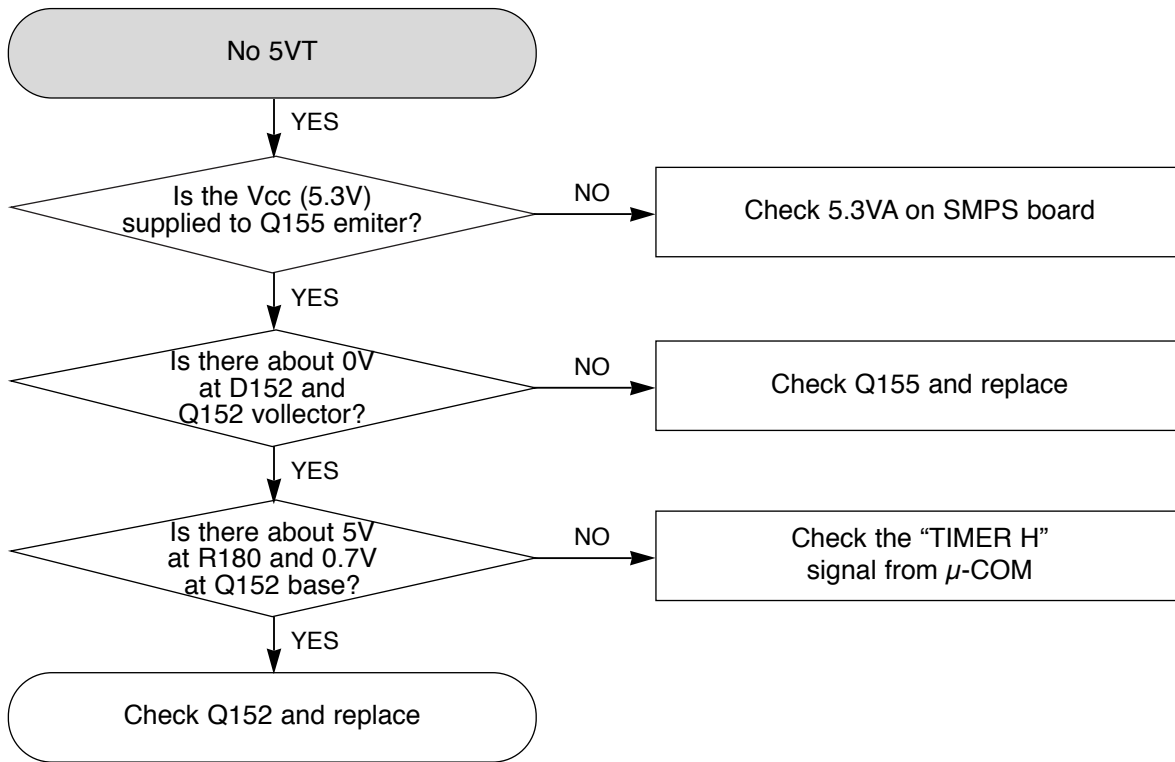

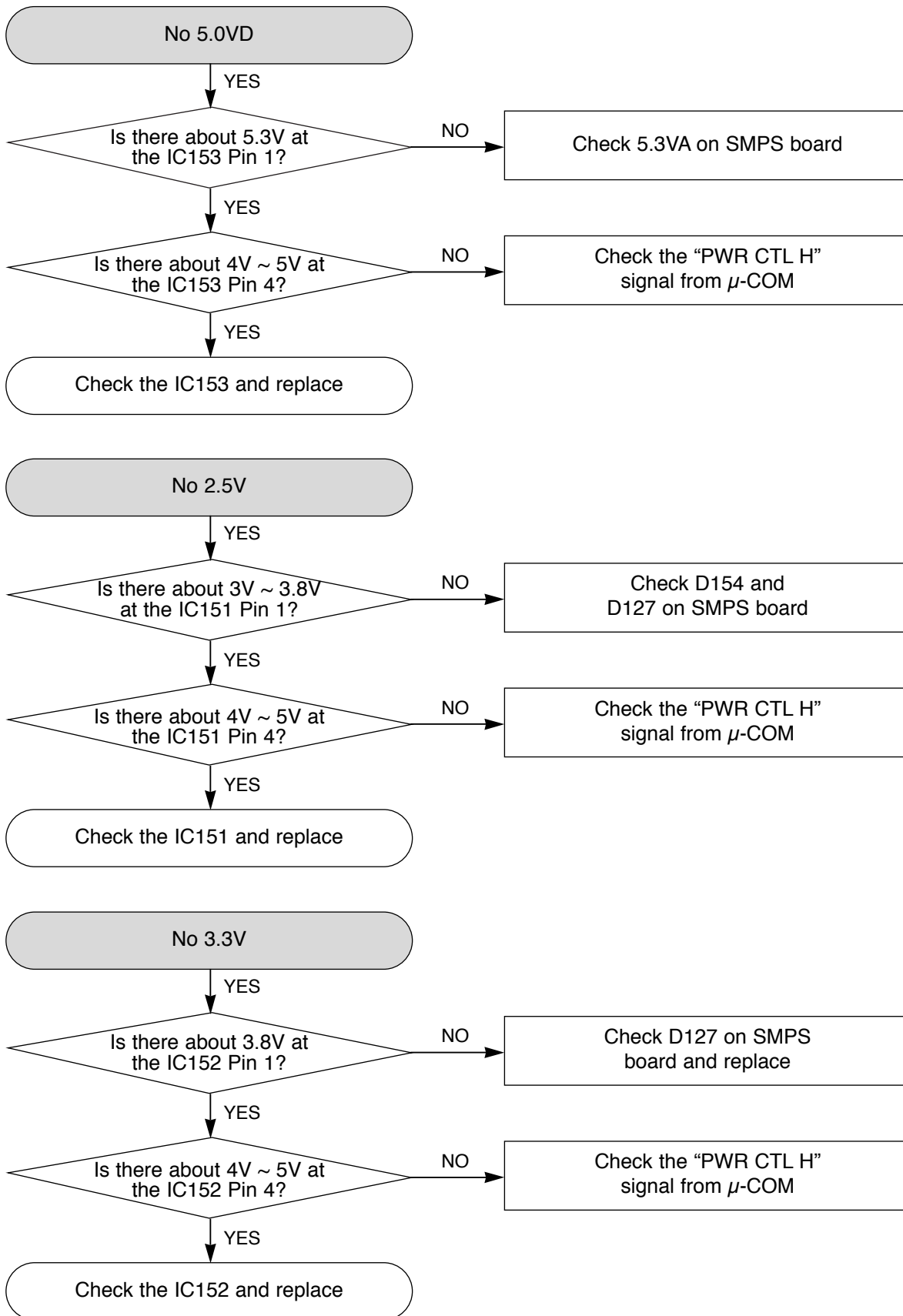

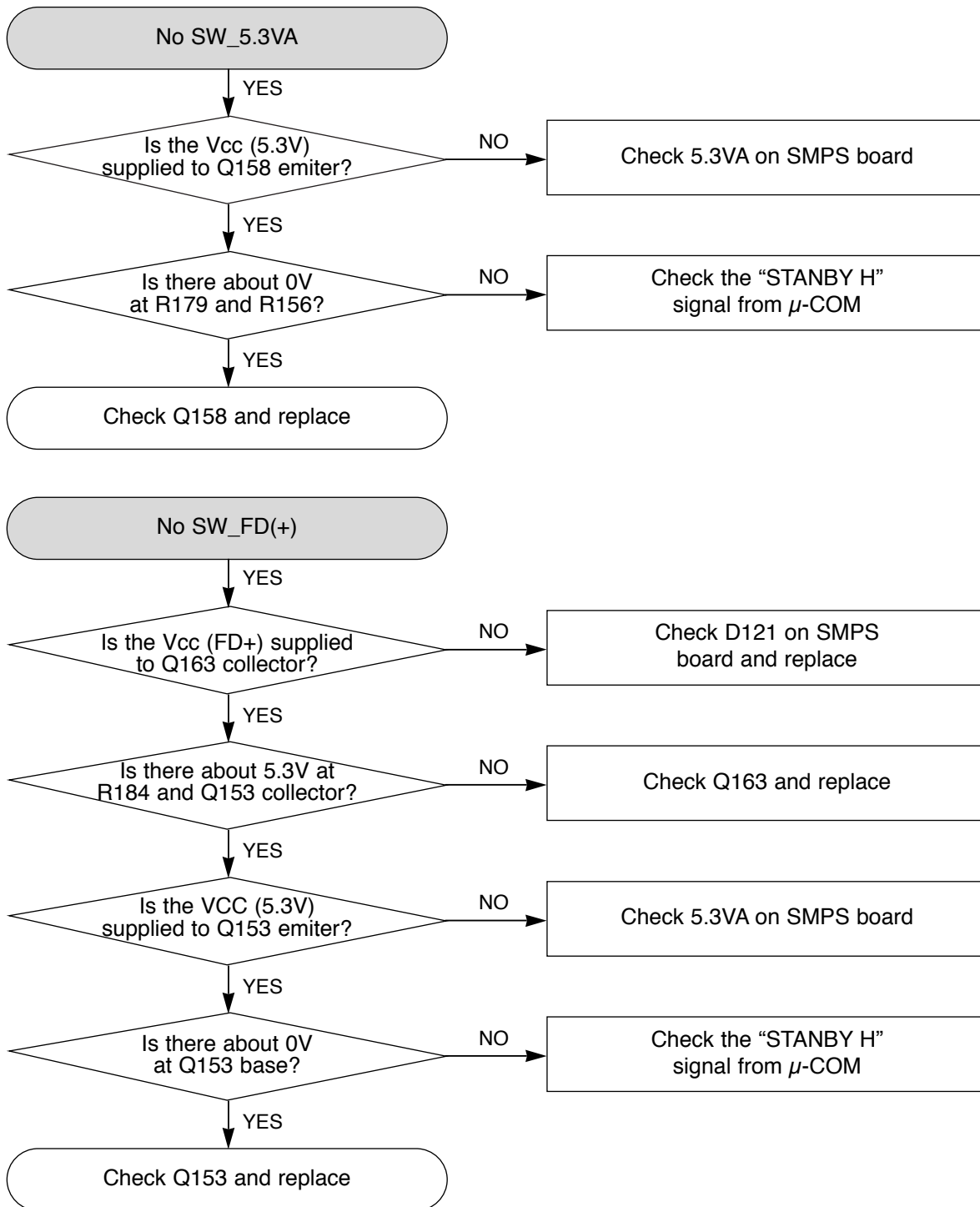

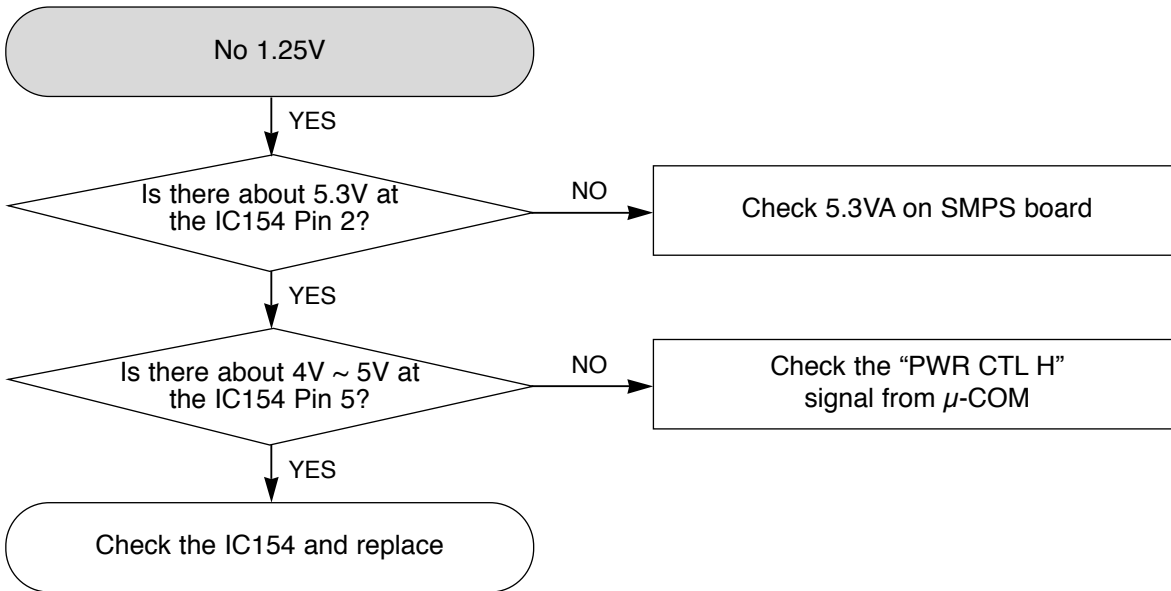
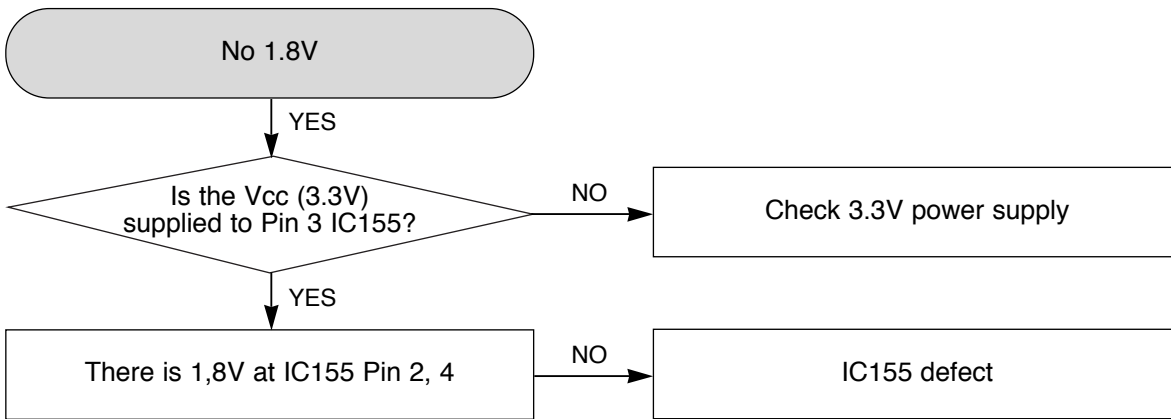

### 3. SYSTEM CIRCUIT PART

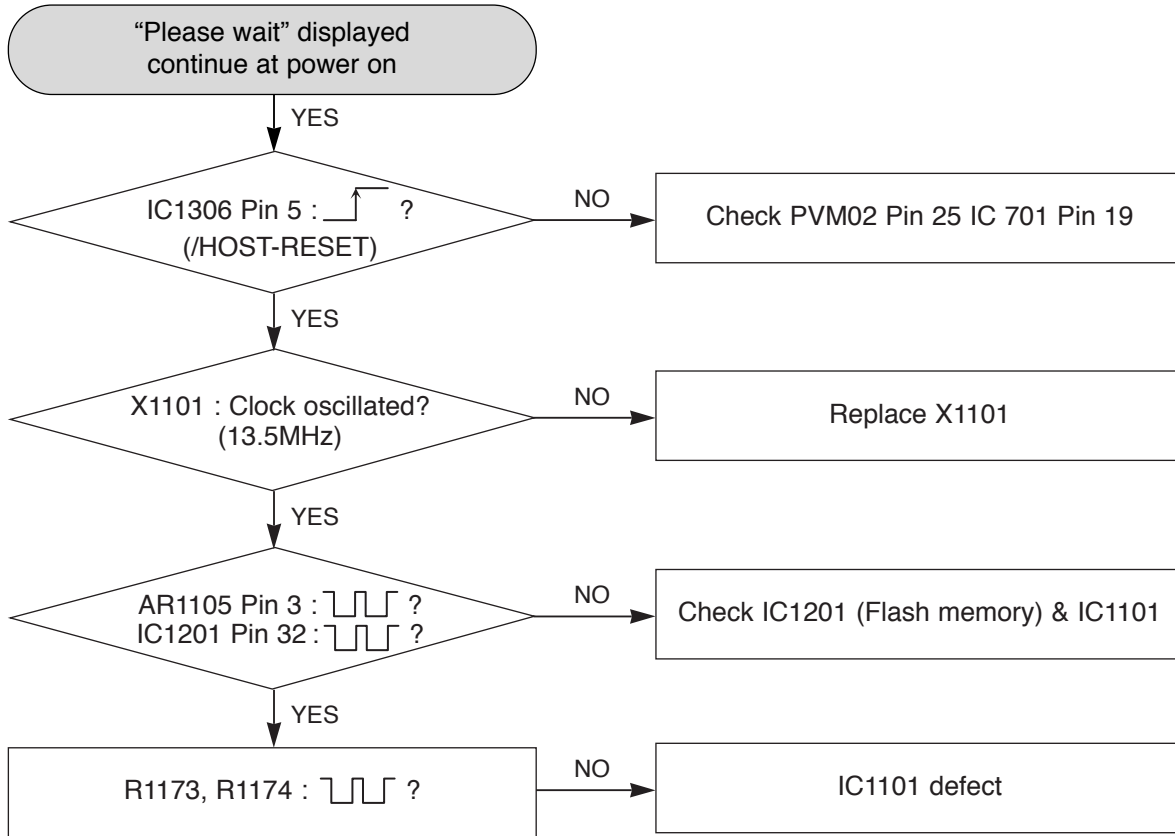

### 4. DISC NOT RECOGNIZED

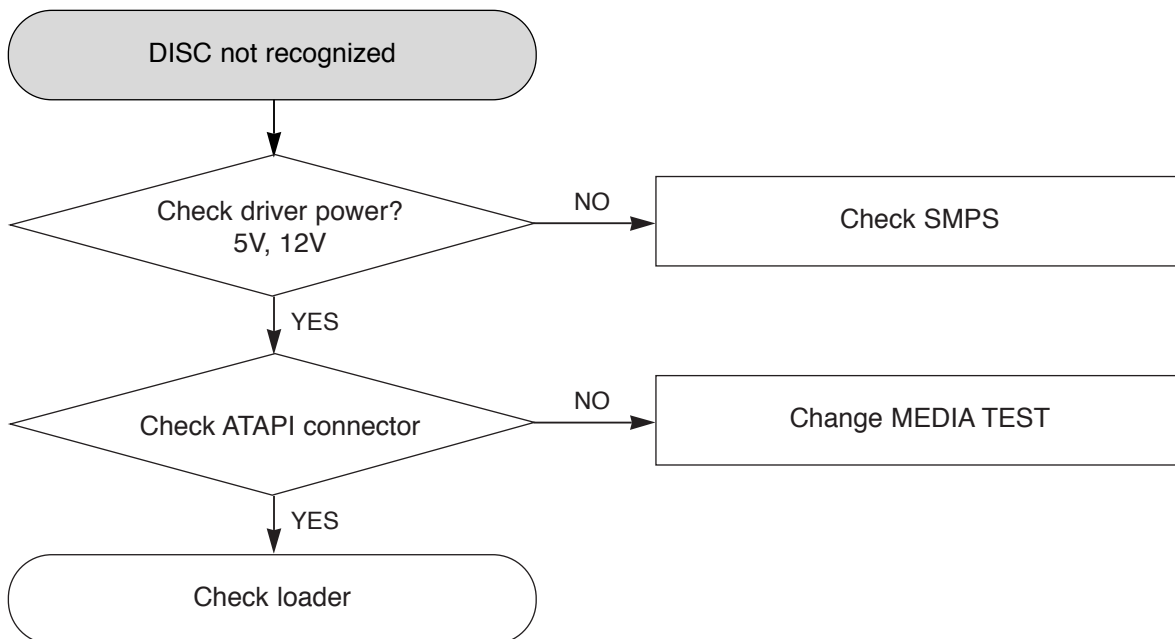

## 5. WHEN PLAYING DISC, NO AUDIO OUTPUT

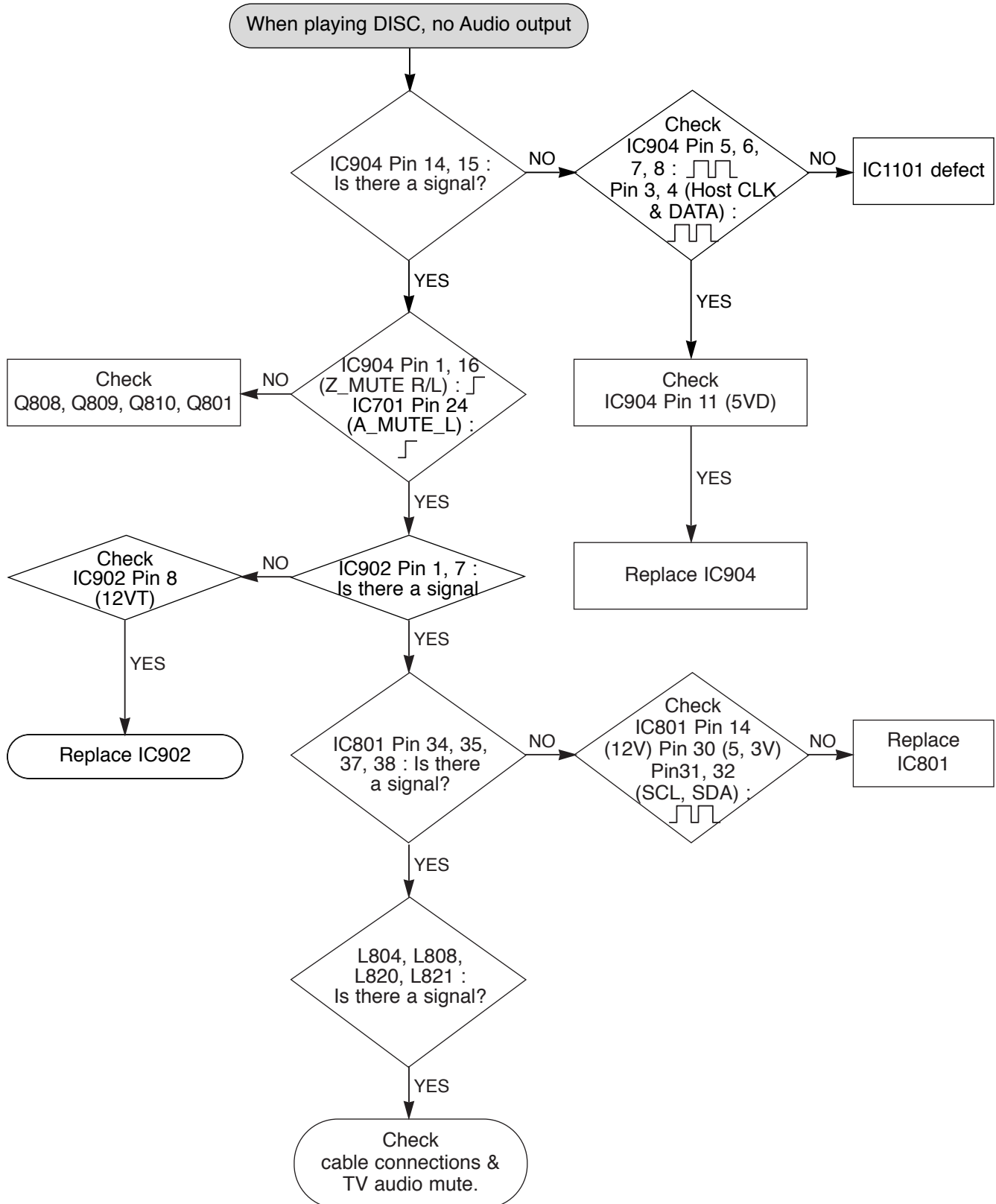

## 6. NO OPTICAL/DIGITAL OUTPUT

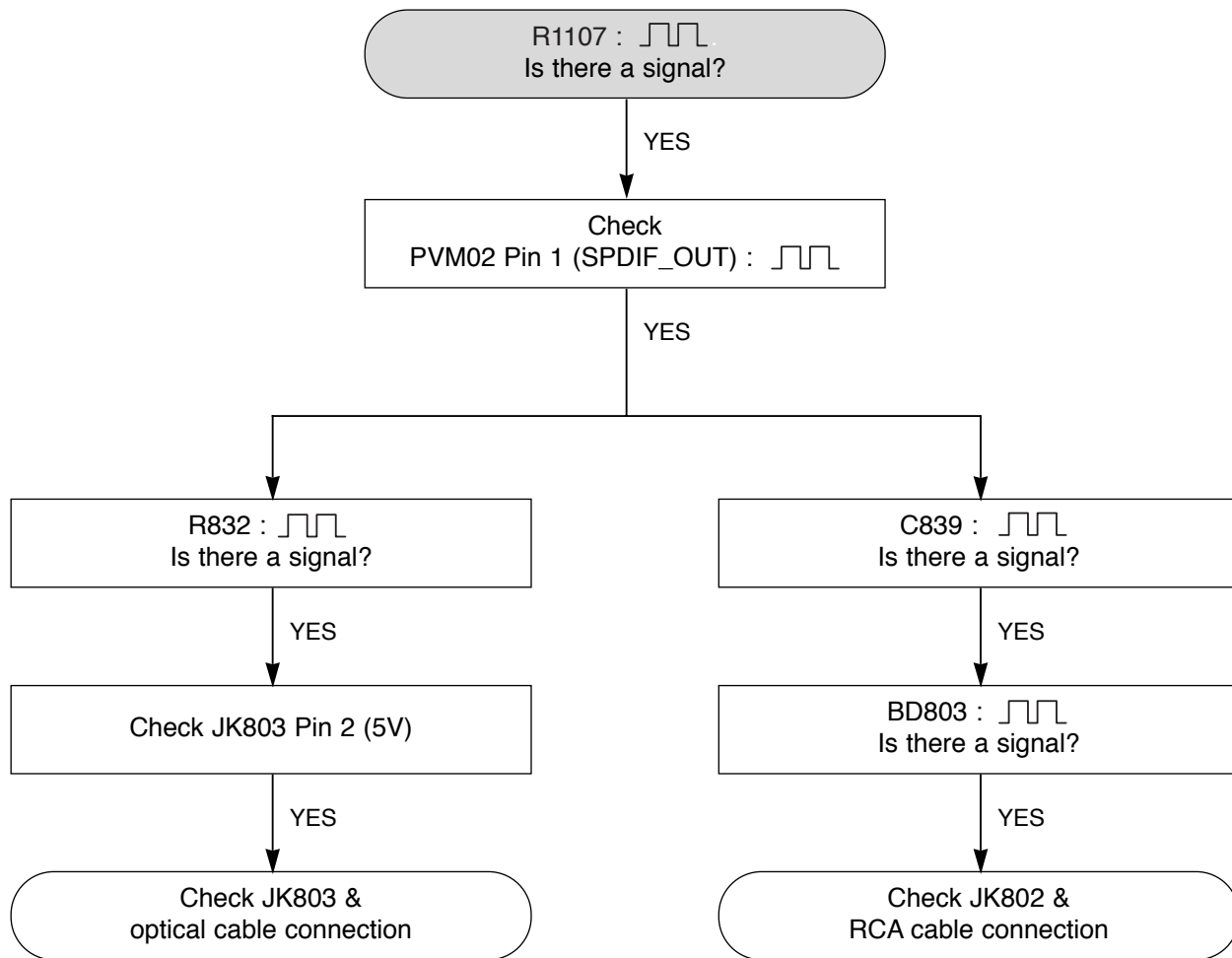



## 7. NO TUNER AUDIO OUTPUT

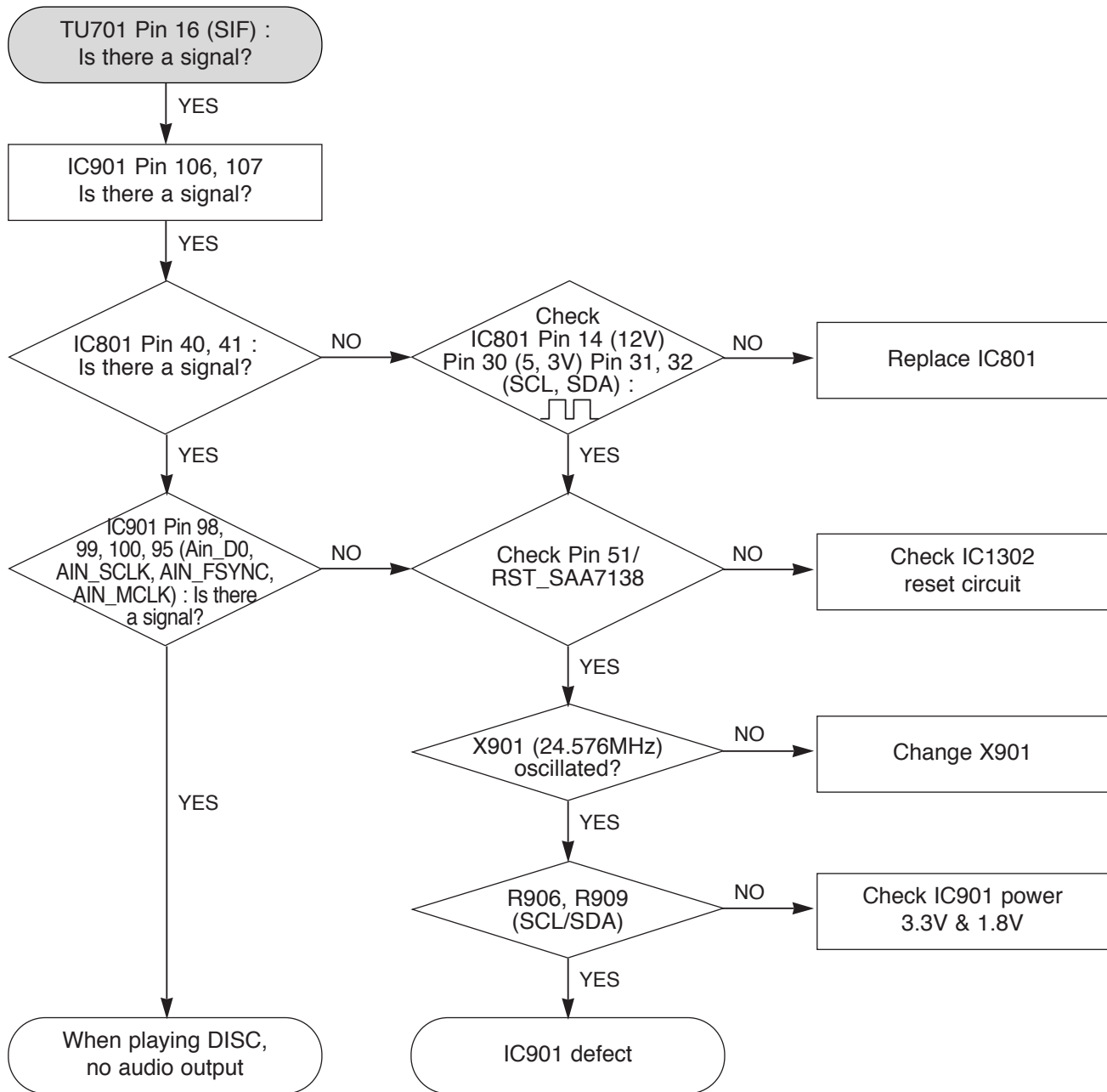

## 8. NO EXTERNAL AUDIO INPUT

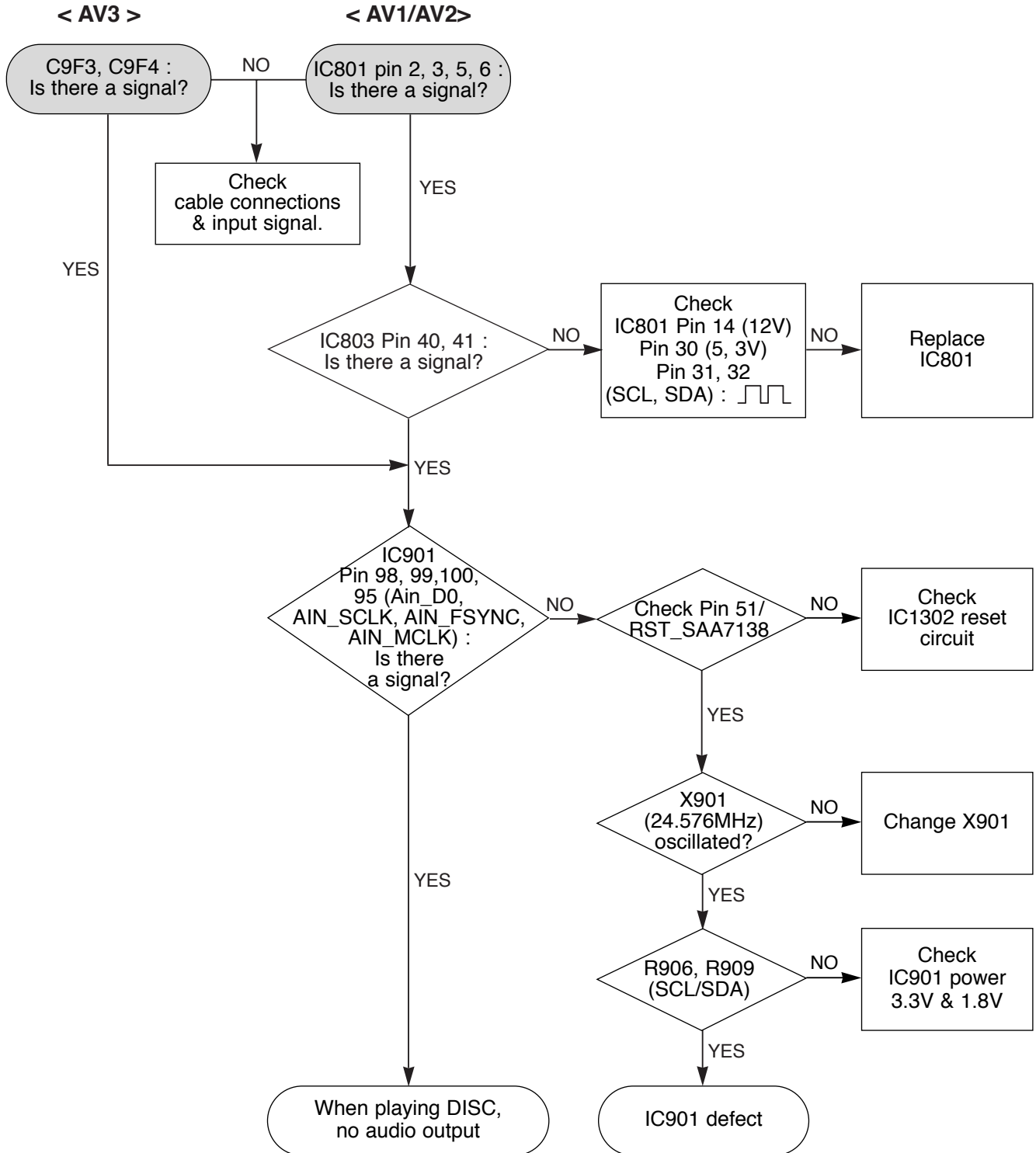

## 9. NO RGB/COMPONENT VIDEO SIGNAL WHEN PLAY DISC

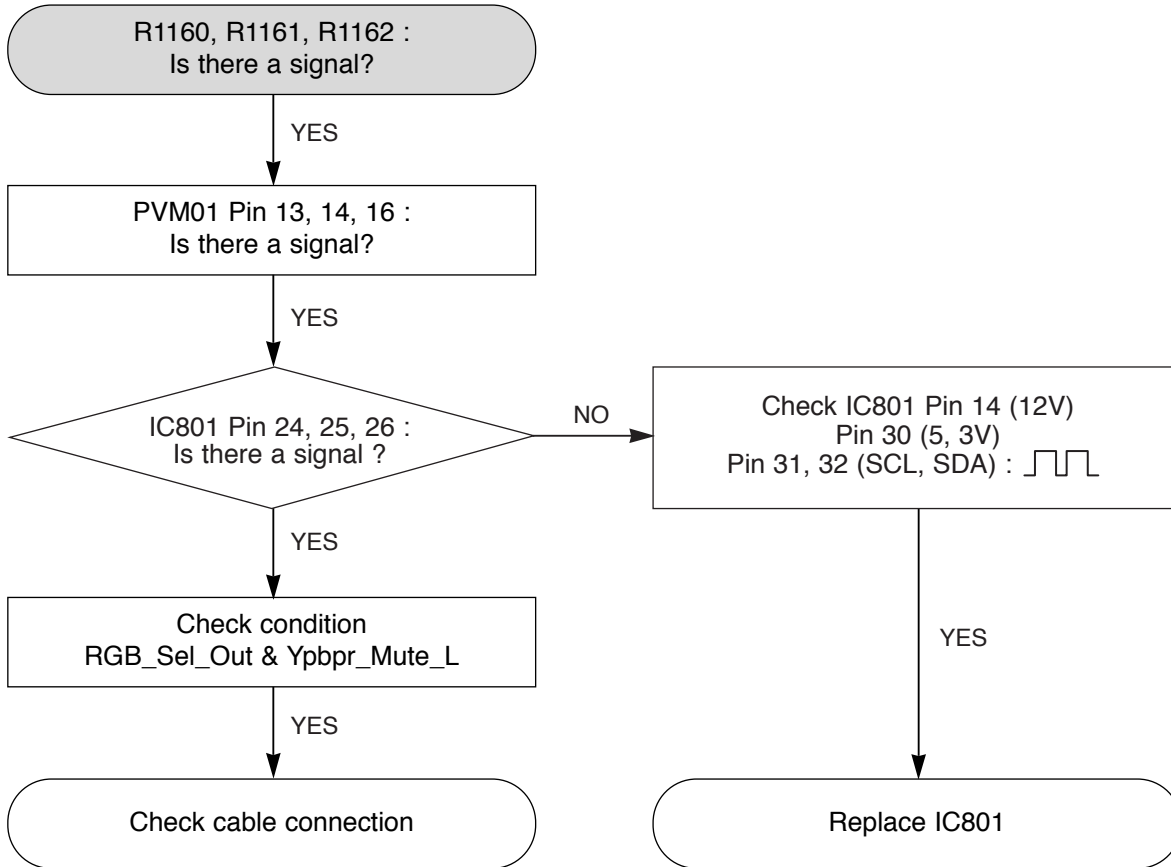

## 10. NO COMPOSITE/S-VIDEO SIGNAL WHEN PLAY DISC

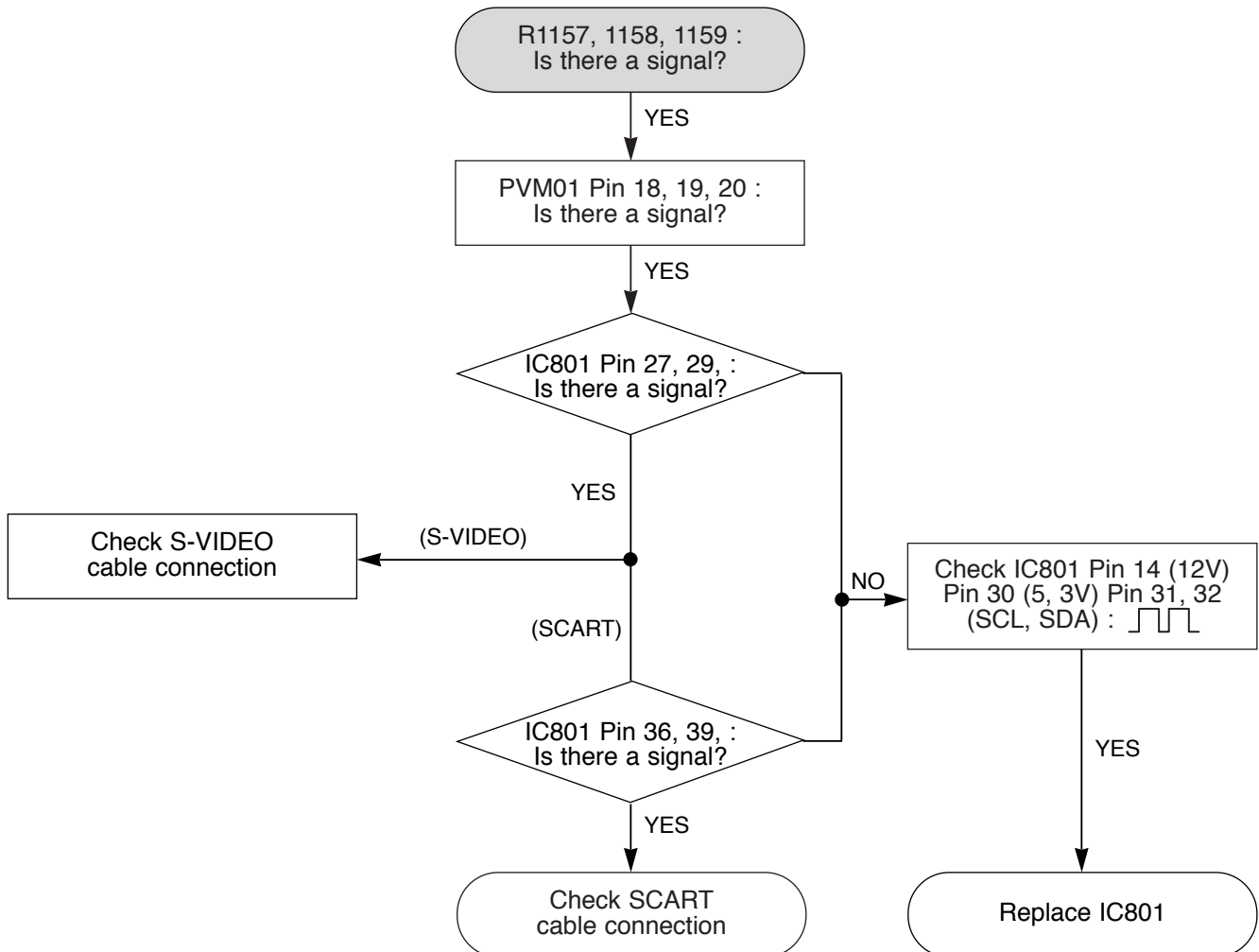

# 11. NO TV, EXTERNAL INPUT VIDEO SIGNAL

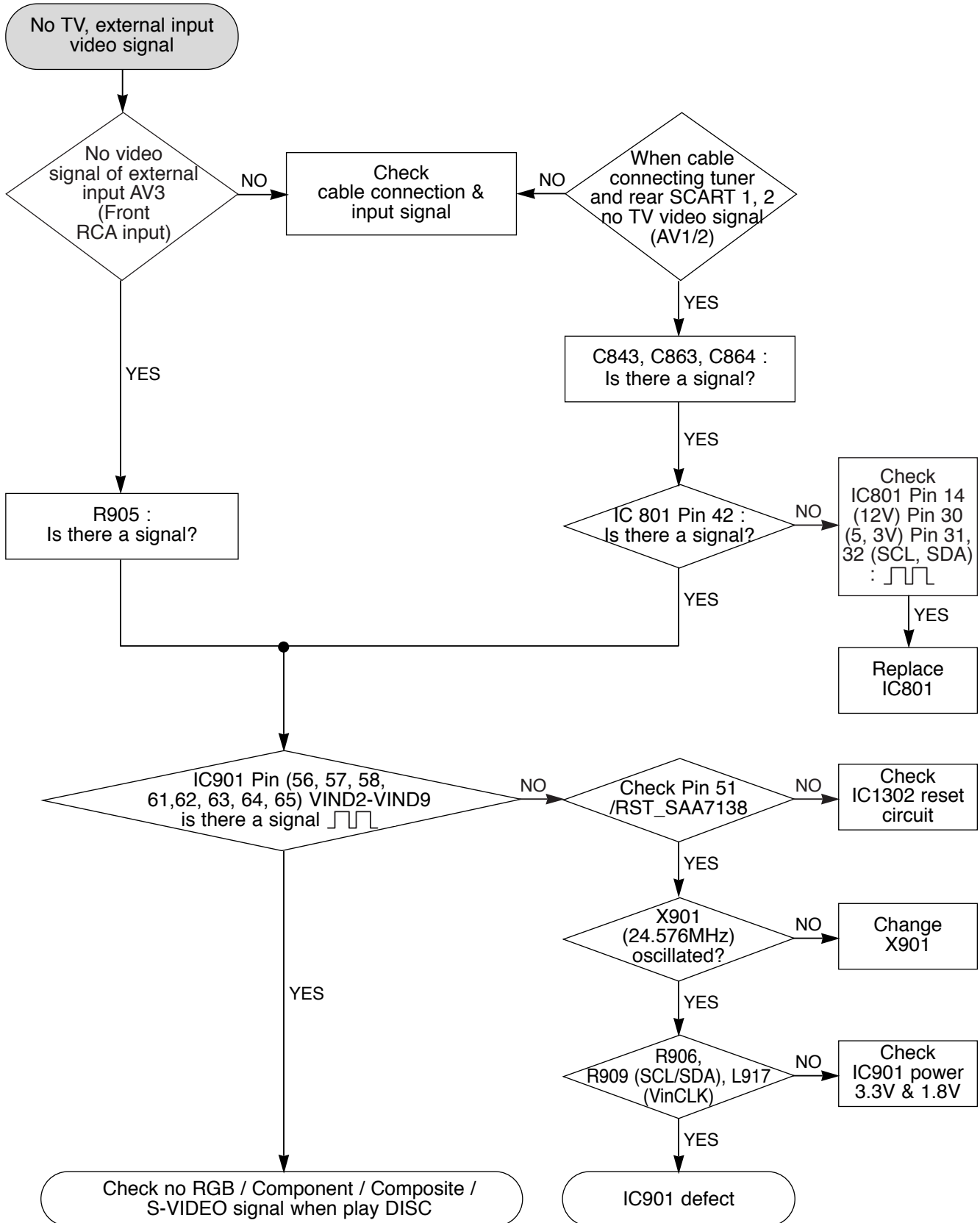

## 12. NO DV (IEEE1394) INPUT (VIDEO/AUDIO) SIGNAL

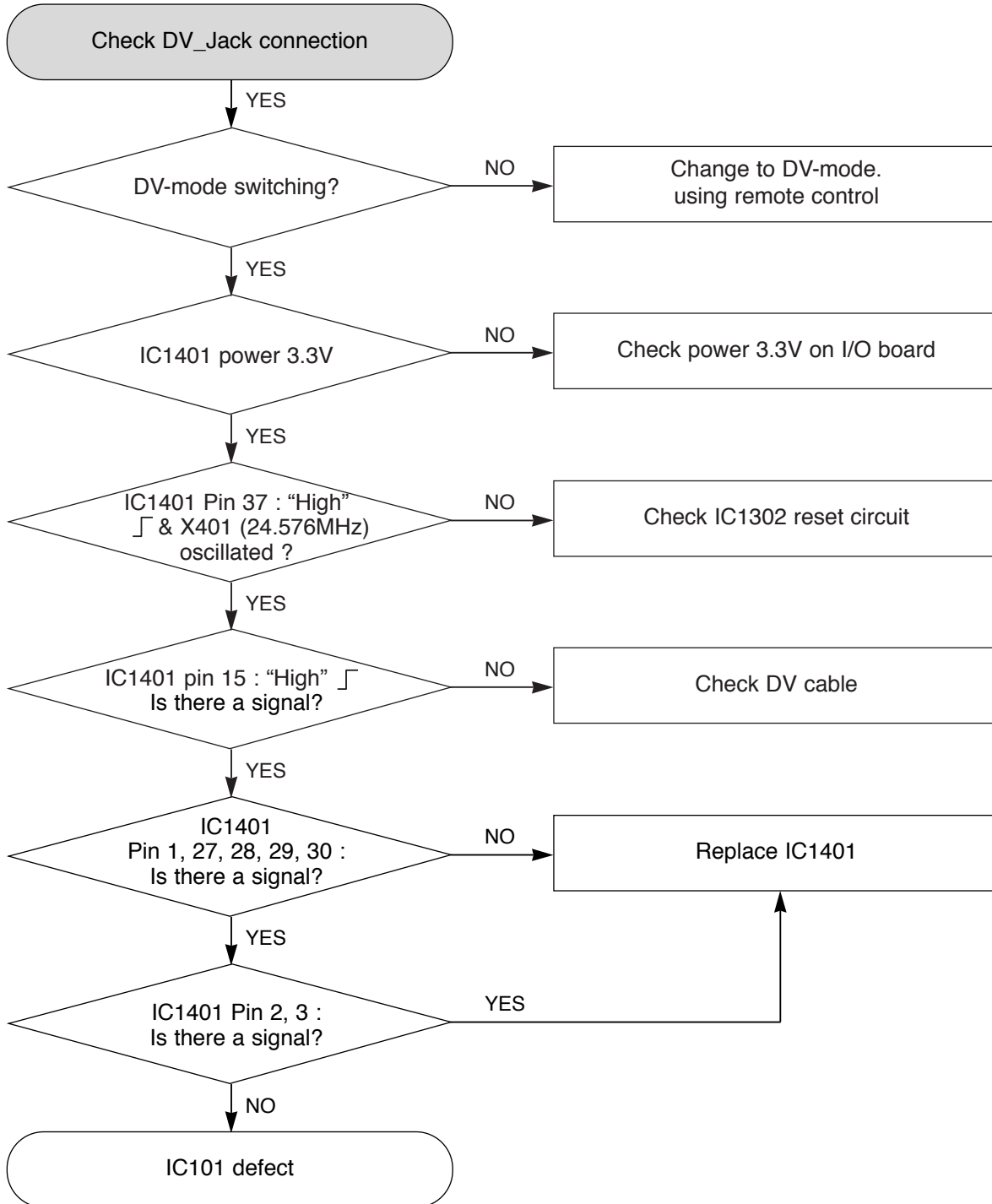

# WAVEFORMS

## 1. SMPS BLOCK

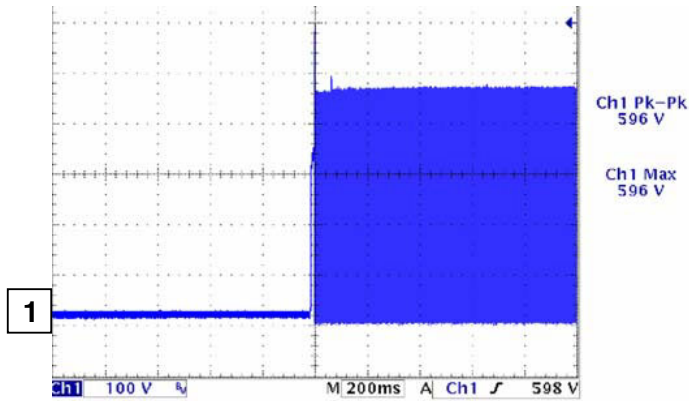

< Switching waveform of IC101, when power is on >

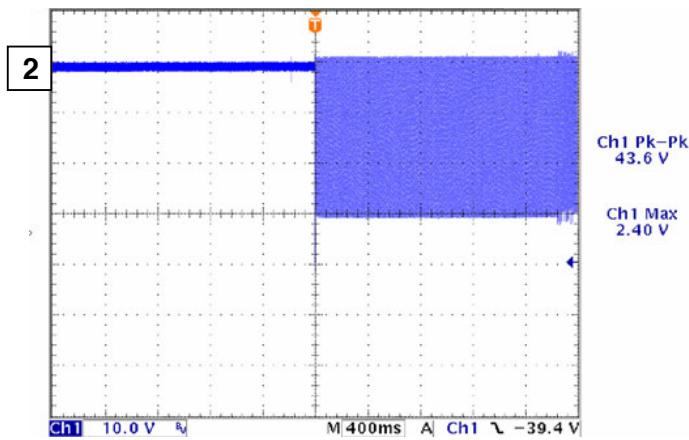
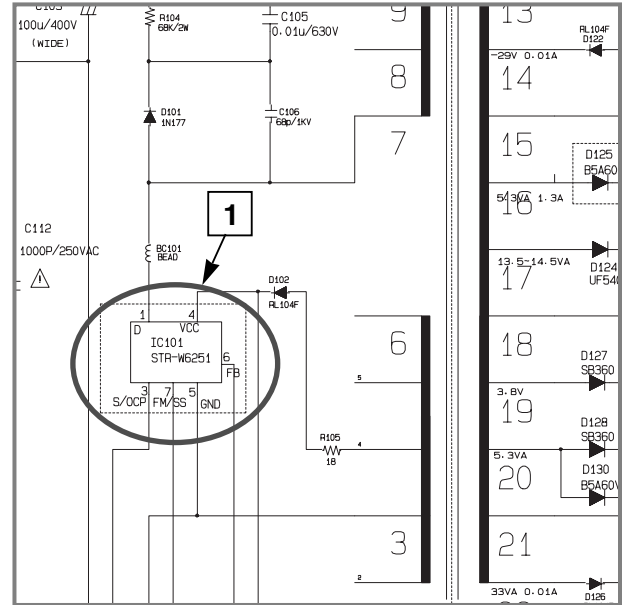

< Both ends waveform of D128, when power is on (feedback 5.3VA) >

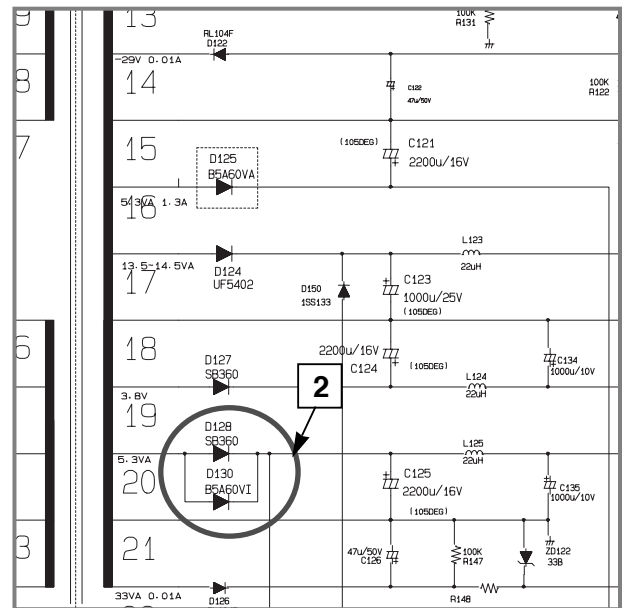

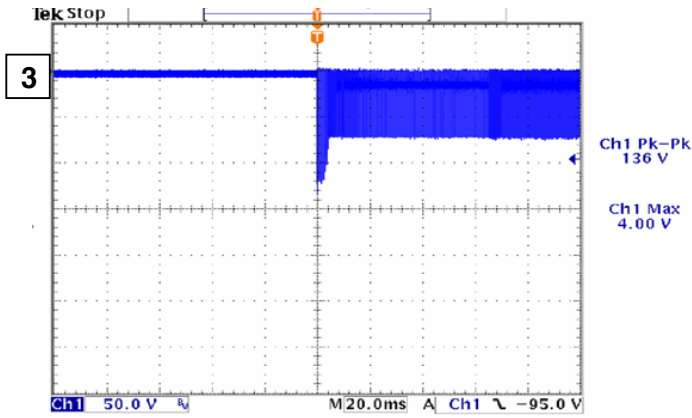

< Both ends waveform of D124, when power is on (12VA) >

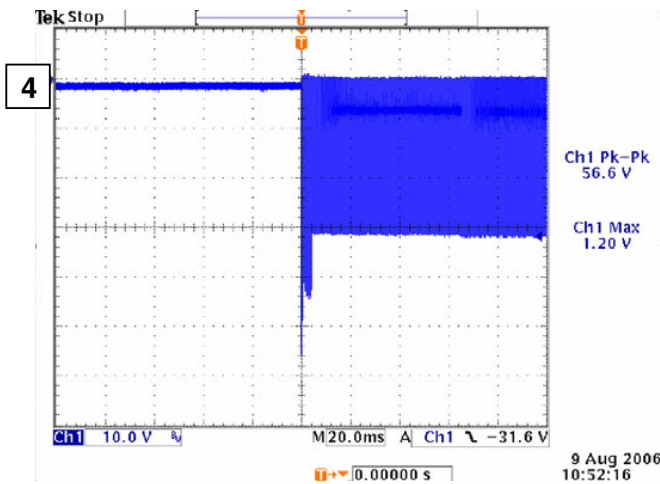
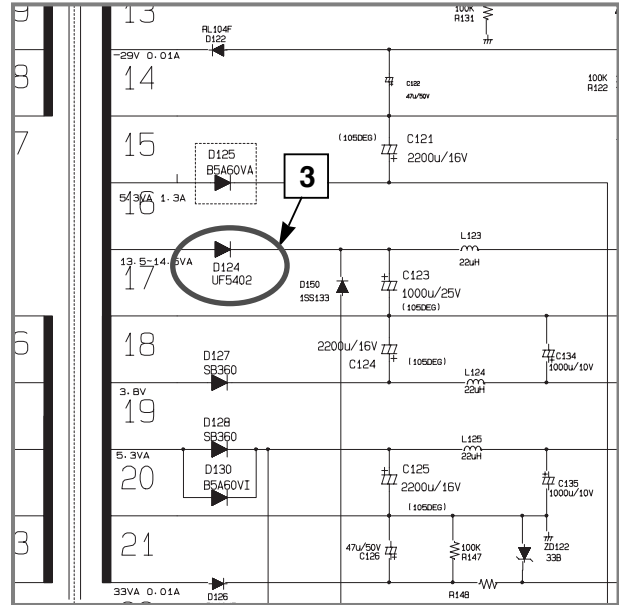

< Both ends waveform of D125, when power is on (5.5VA) >

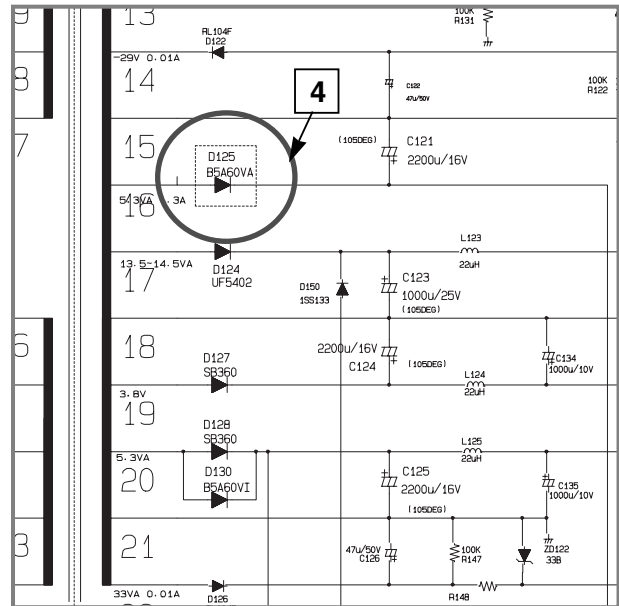



## 2. SYSTEM BLOCK

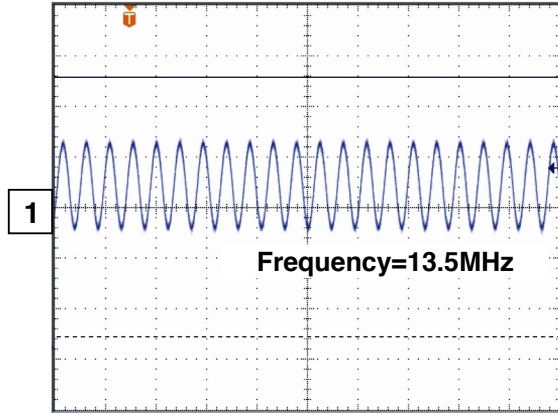

< Main Clock >

1

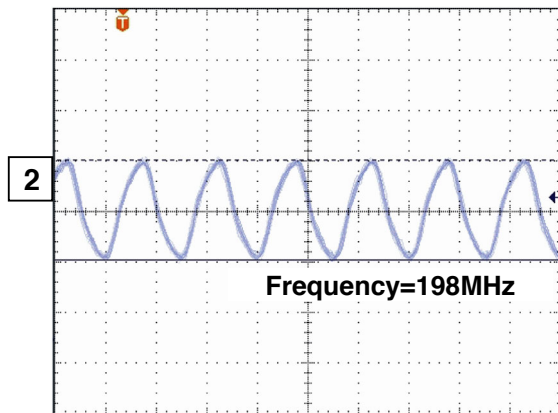
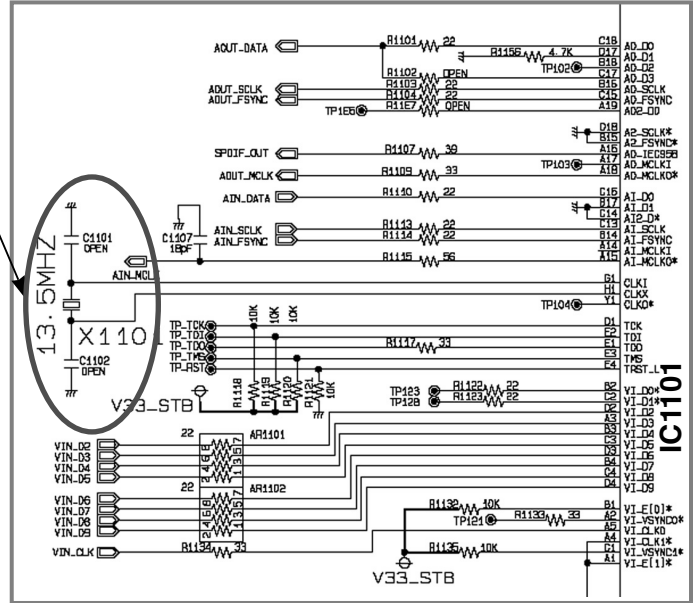

< DDR RAM Clock >

2

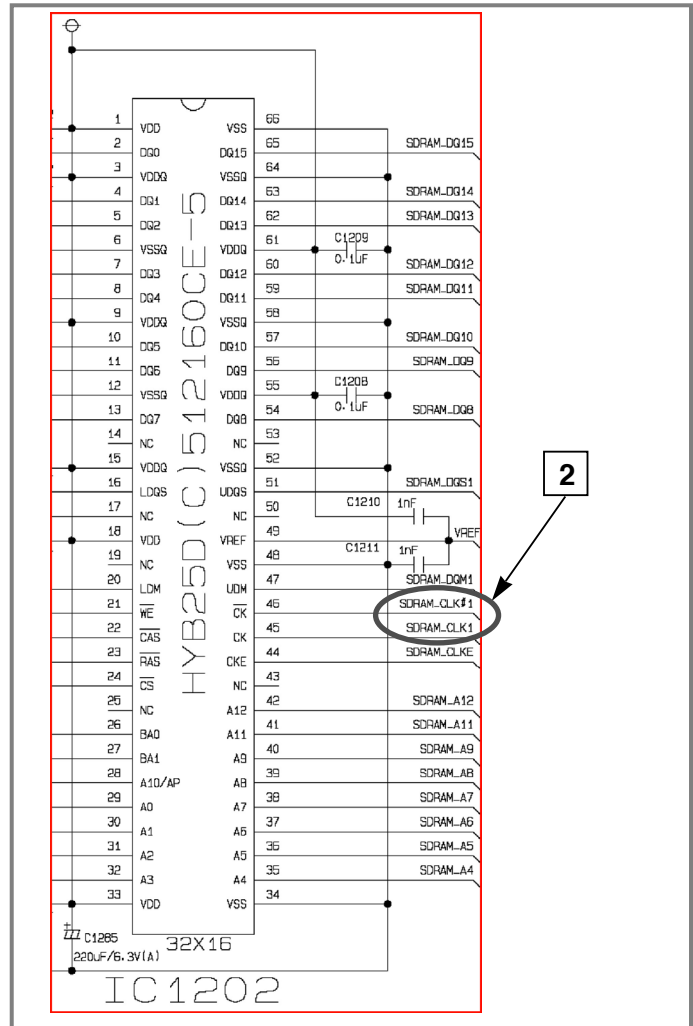

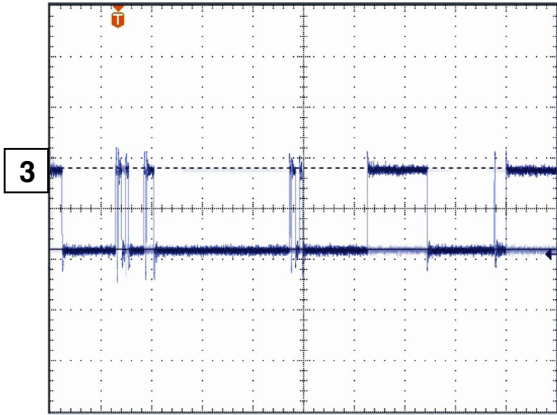

< DDR Bank Address >

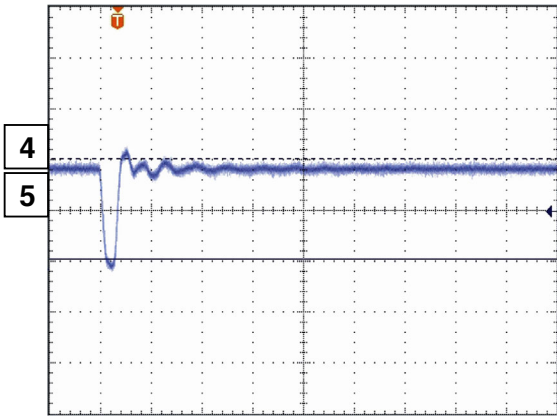

< DDR RAS & CAS >

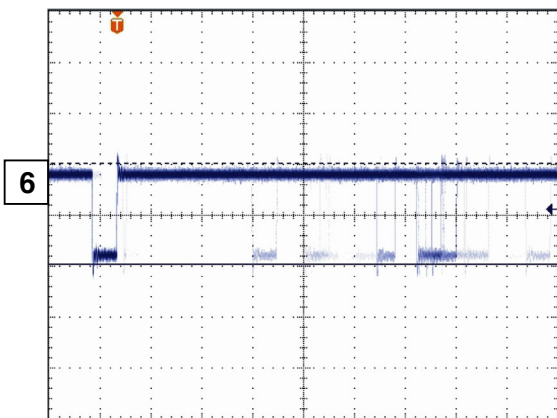

< DDR Write Enable >

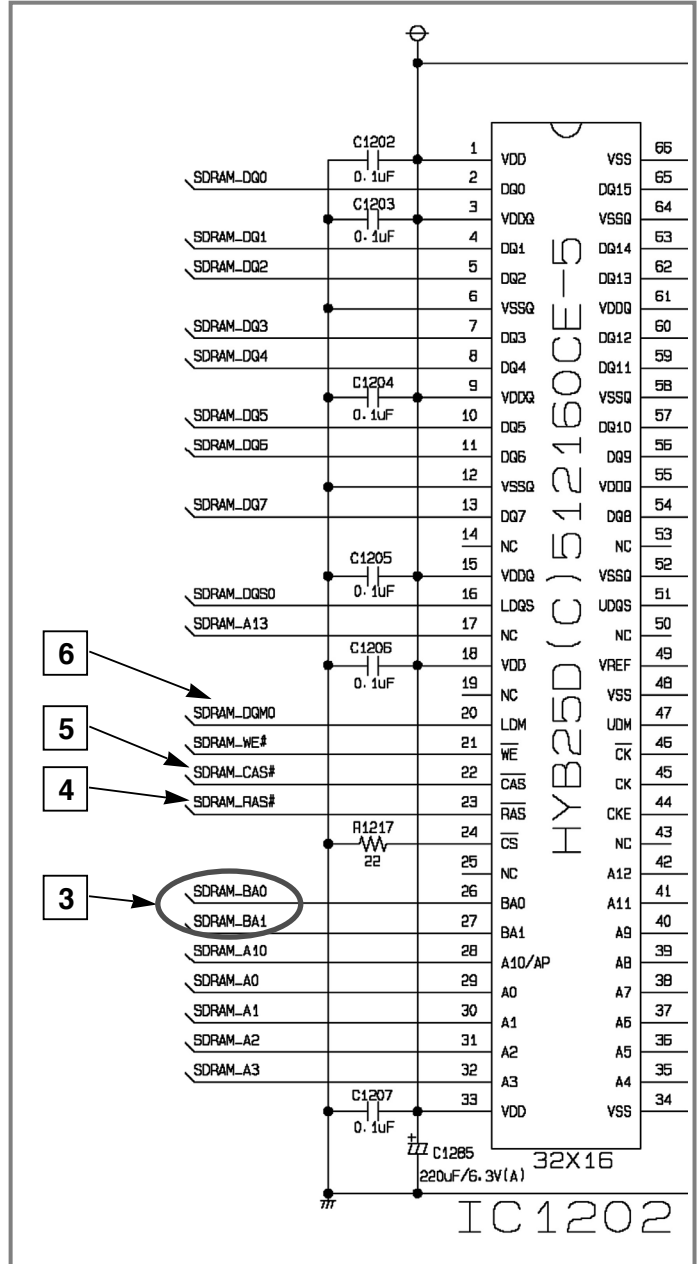

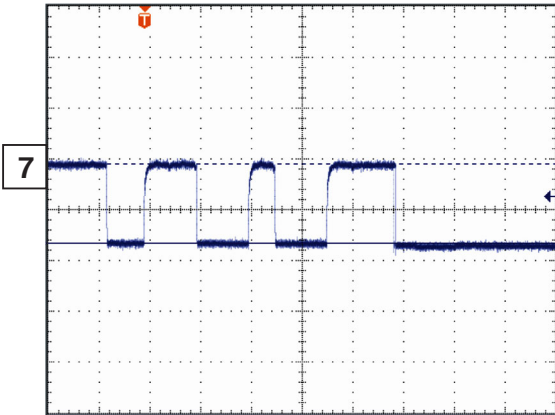
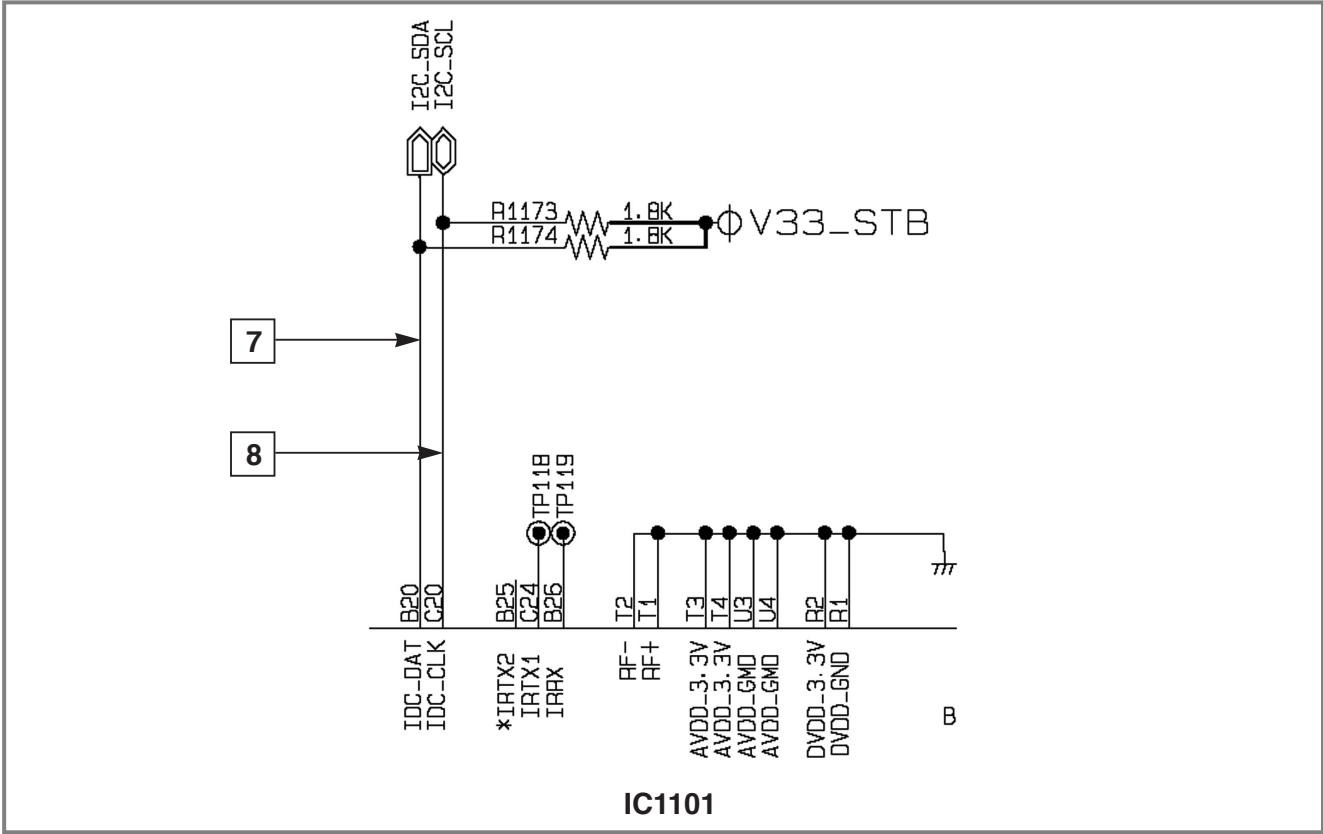

< I2C\_SDA >

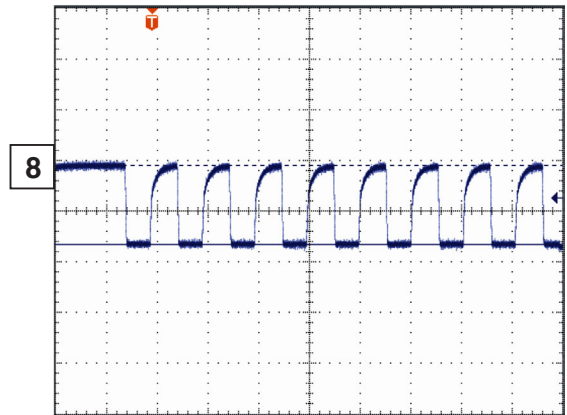

< I2C\_SCL >

### 3. VIDEO BLOCK (COLOR BAR INPUT)

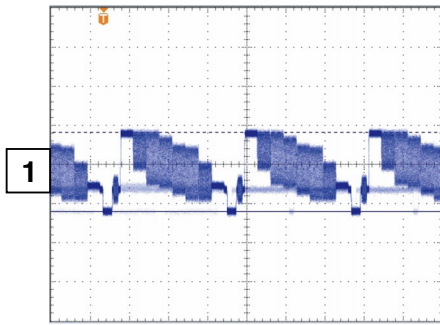

< CVBS\_OUT >

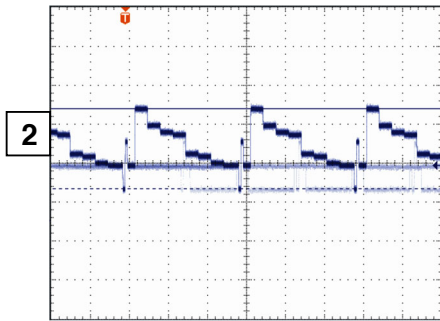

< Y\_OUT >

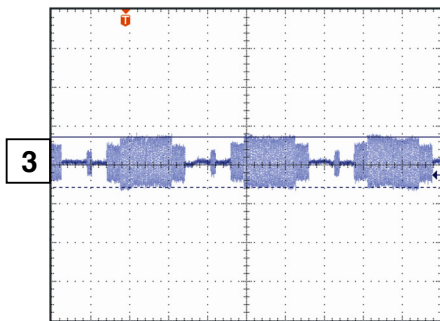

< C\_OUT >

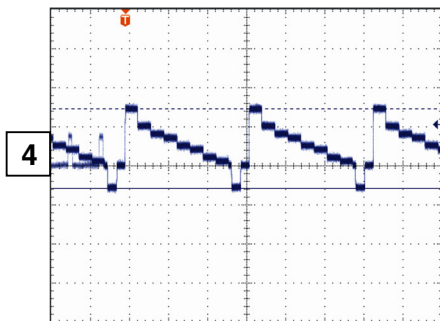

< G/Y\_OUT >

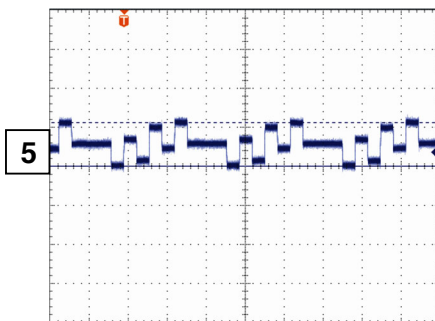

< R/PR\_OUT >

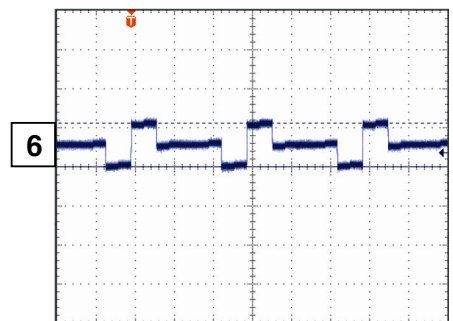

< B/PR\_OUT >

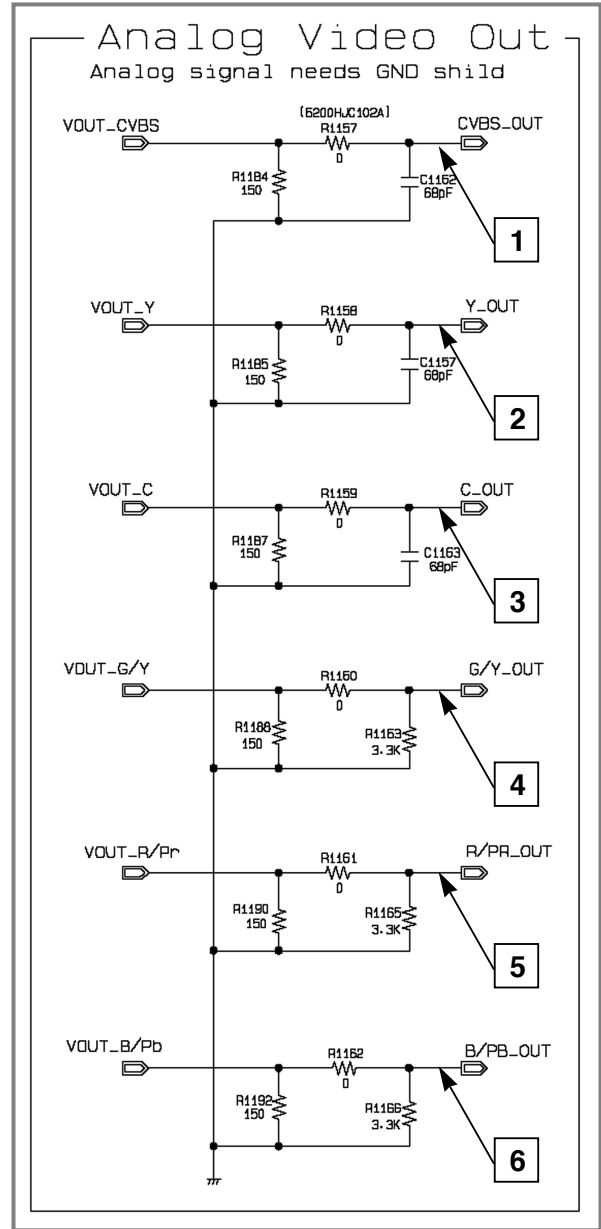

## 4. AUDIO BLOCK (1kHz SINEWAVE INPUT)

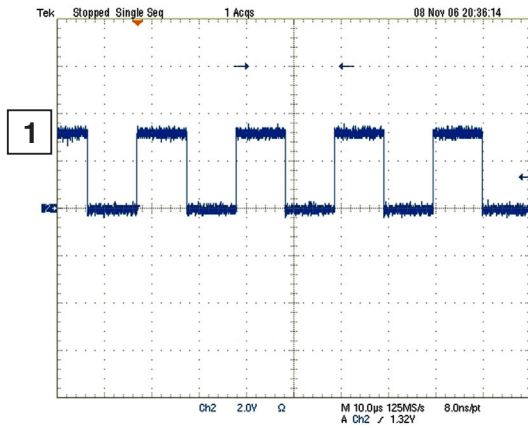
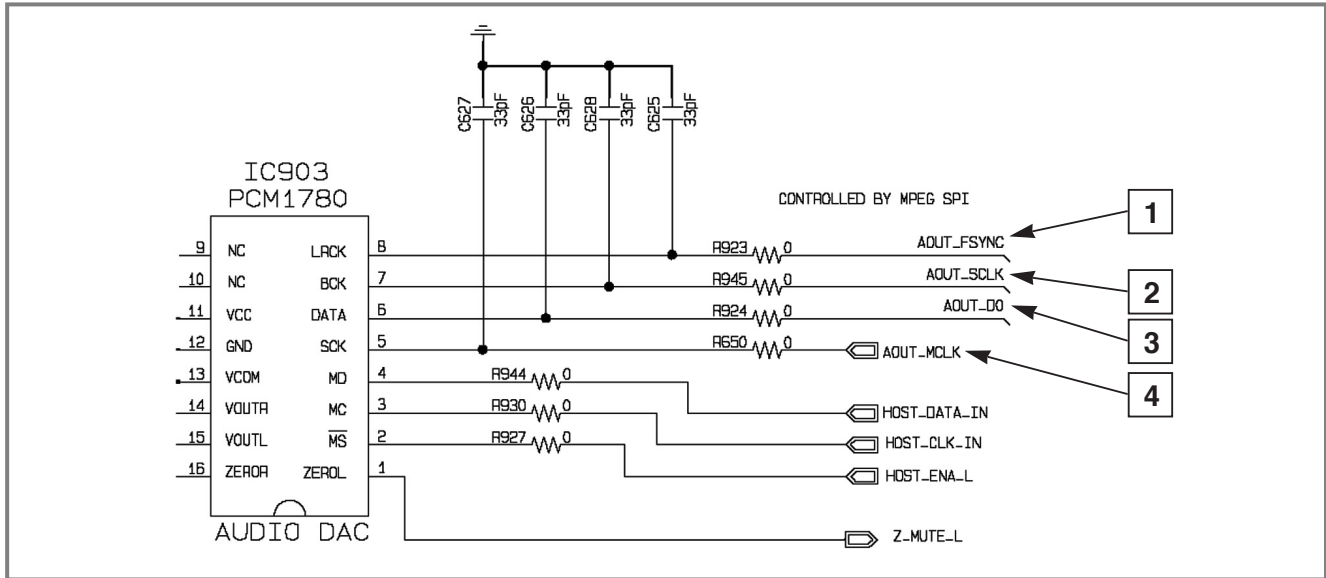

< AOUT\_FSYNC >

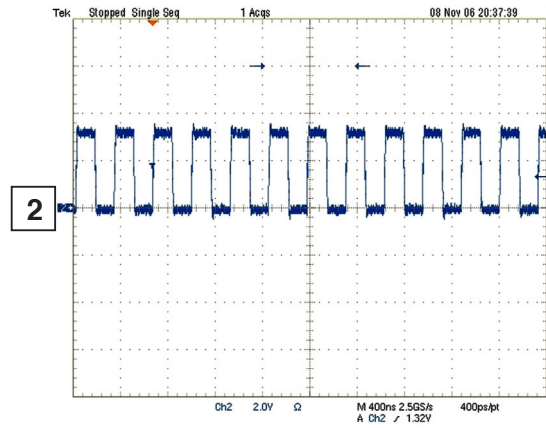

< AOUT\_SCLK >

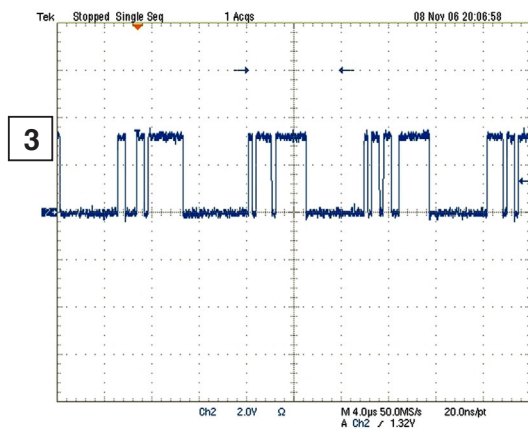

< AOUT\_D0 >

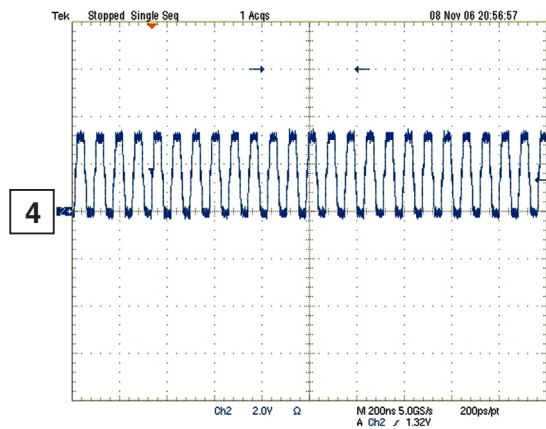

< AOUT\_MCLK >

## 5. SERIAL INTERFACE BLOCK (BETWEEN MAIN AND I/O)

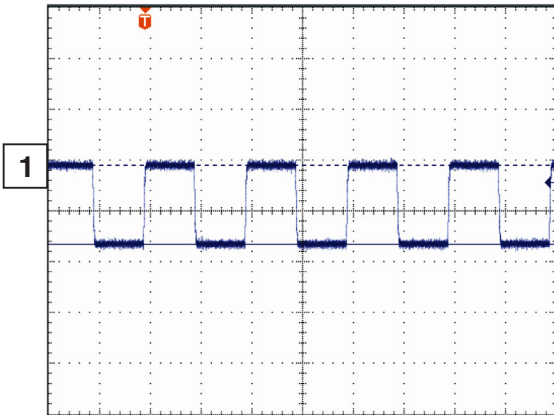
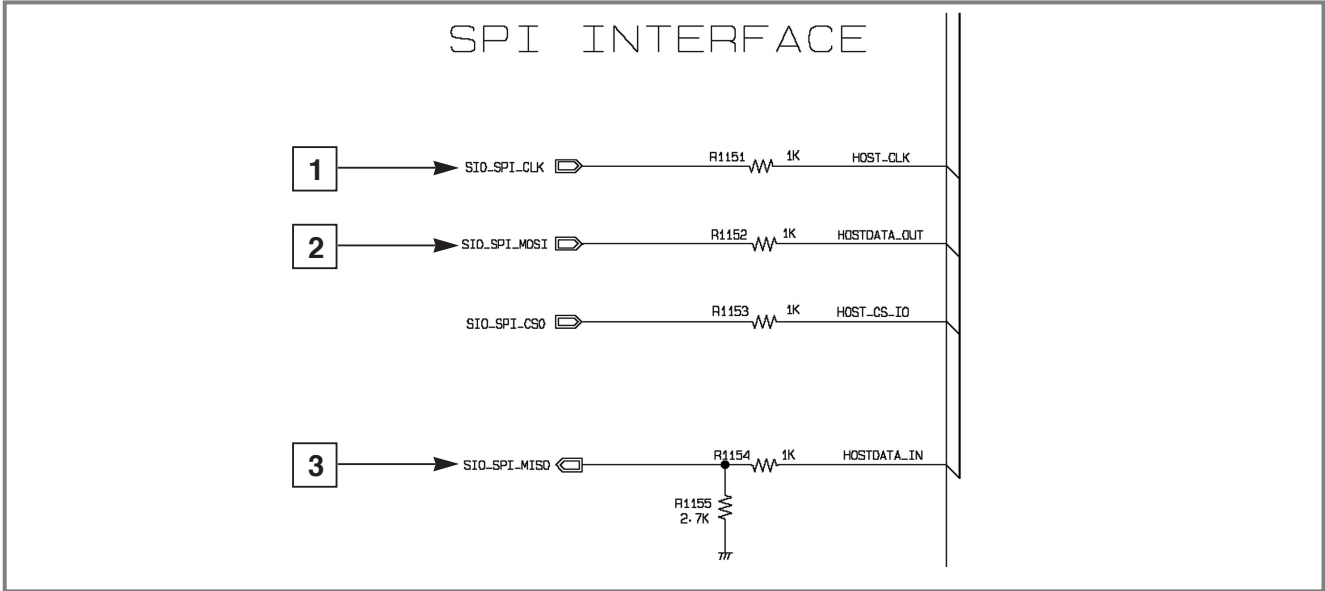

< SIO\_SPI\_CLK >

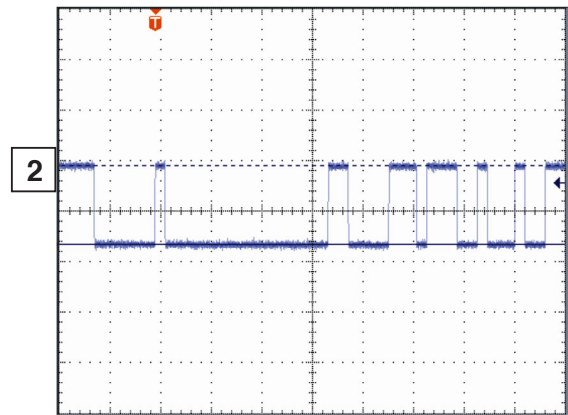

< SIO\_SPI\_MOSI >

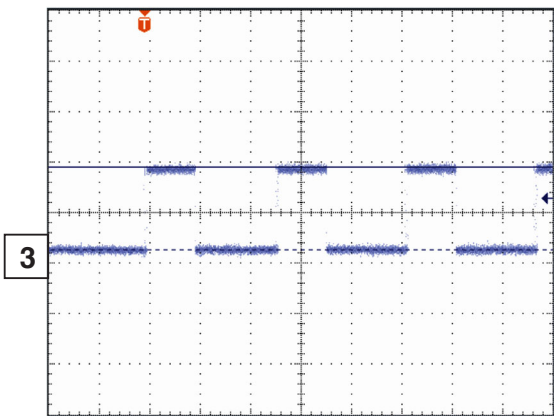

< SIO\_SPI\_MISO >

## 6. TUNER BLOCK

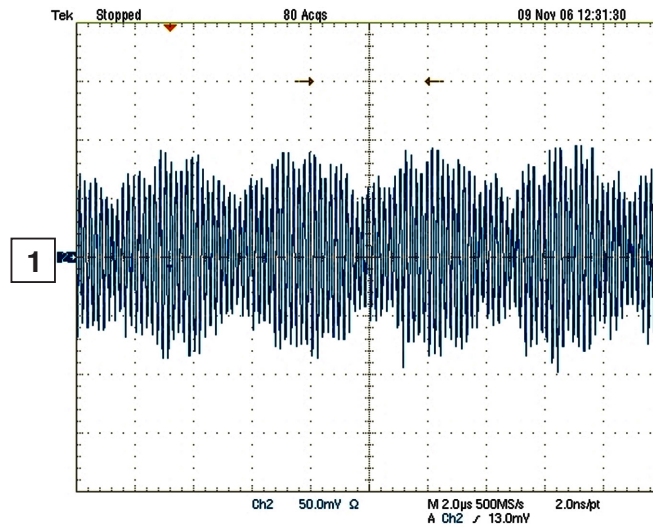
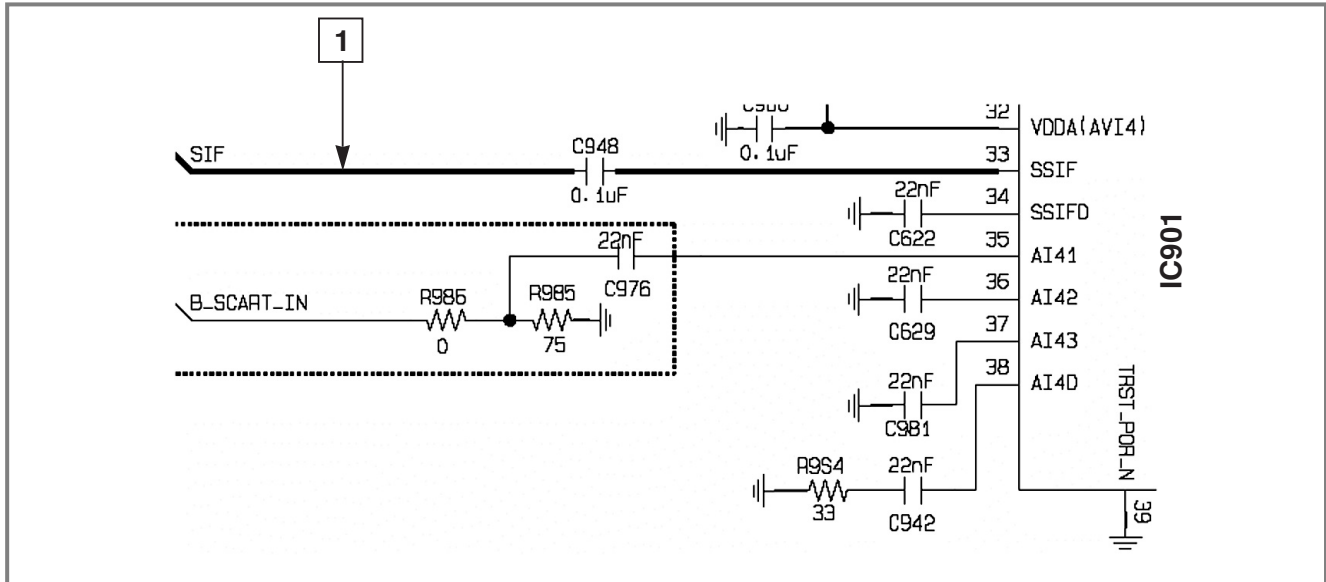

< SIF >

# 7. HDMI BLOCK

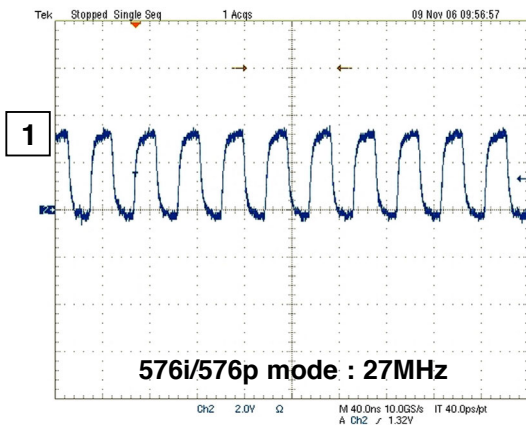
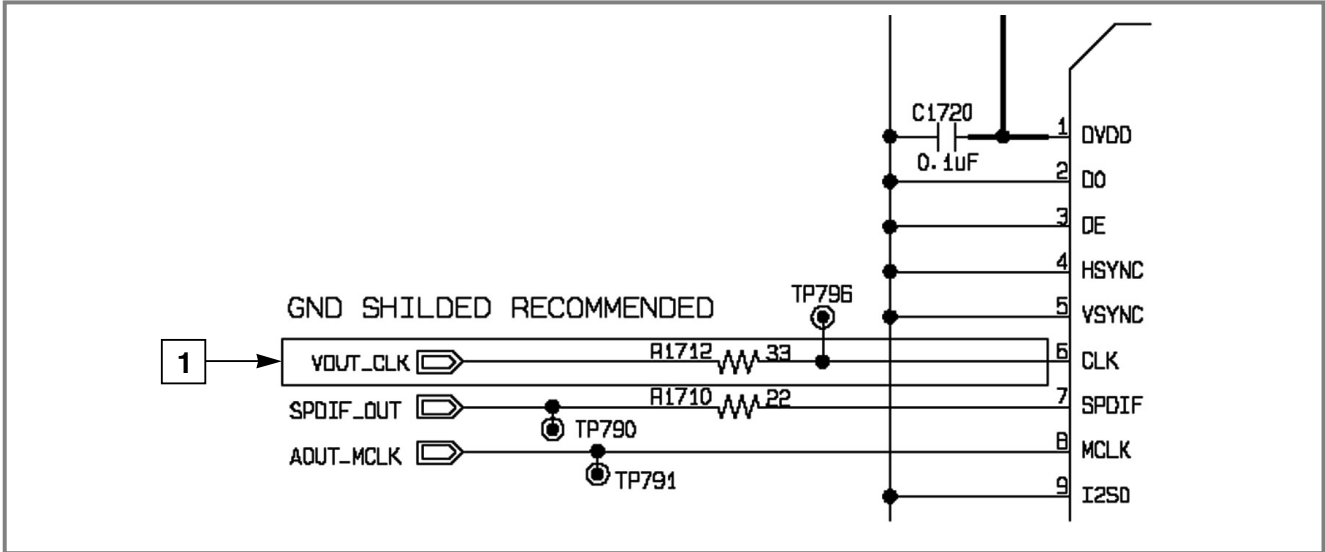

< VOUT\_CLK >

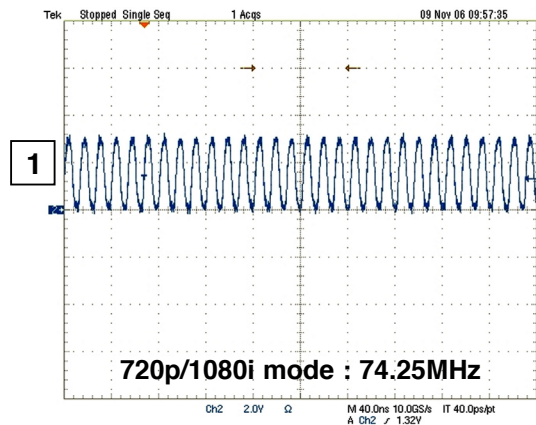

< VOUT\_CLK >

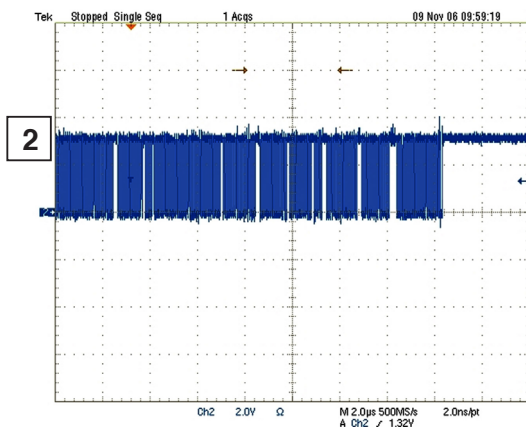

< VOUT\_CLK >

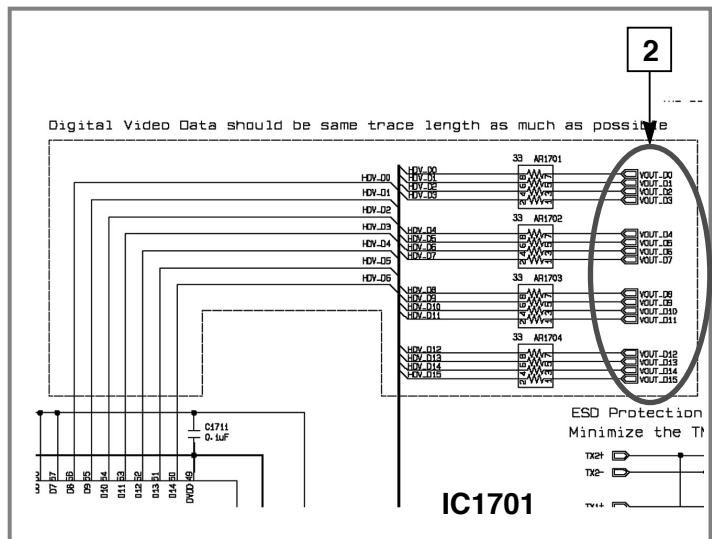



# WIRING CONNECTION DIAGRAM

## 1. WIRING CONNECTION DIAGRAM 1

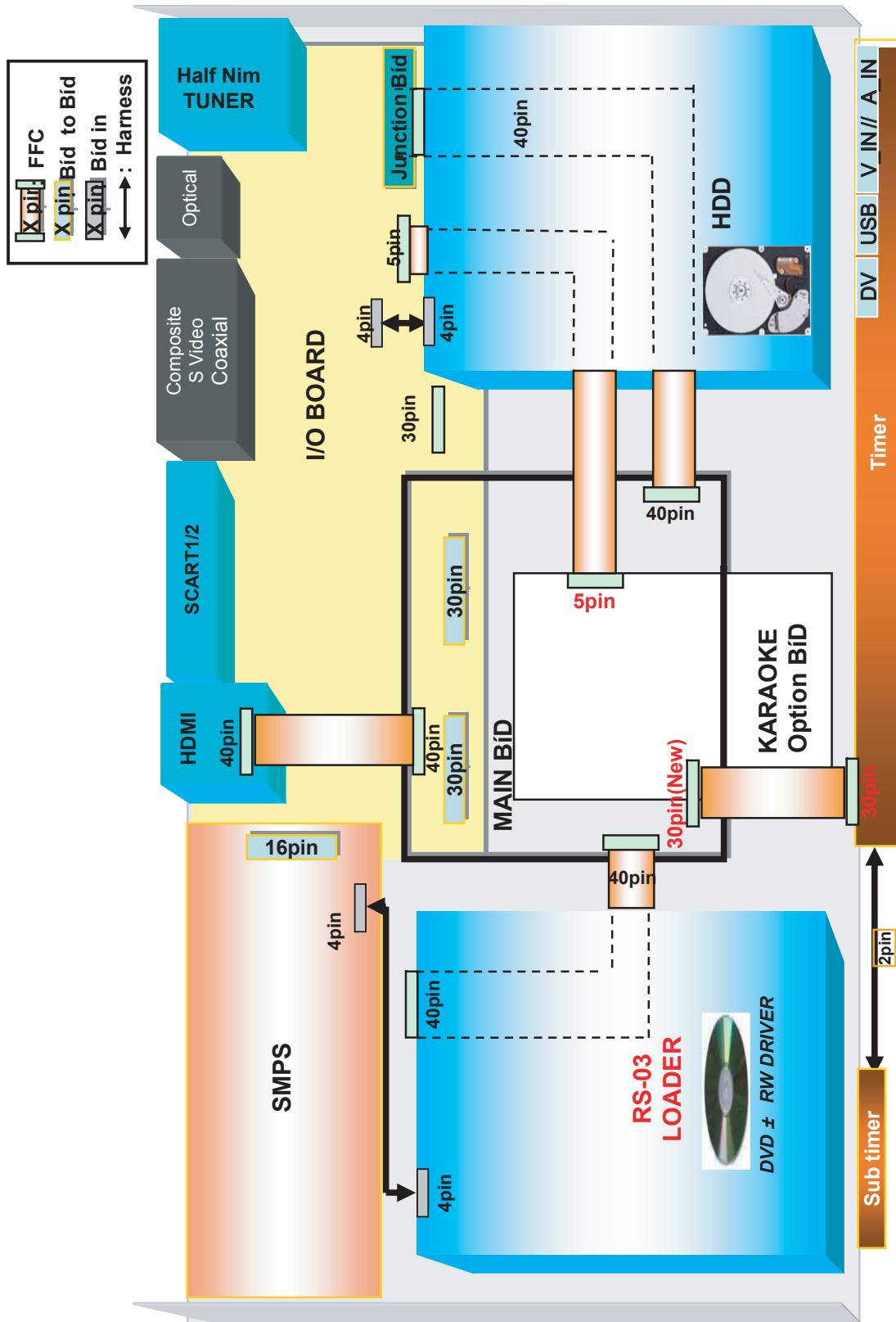

## 2. WIRING CONNECTION DIAGRAM 2

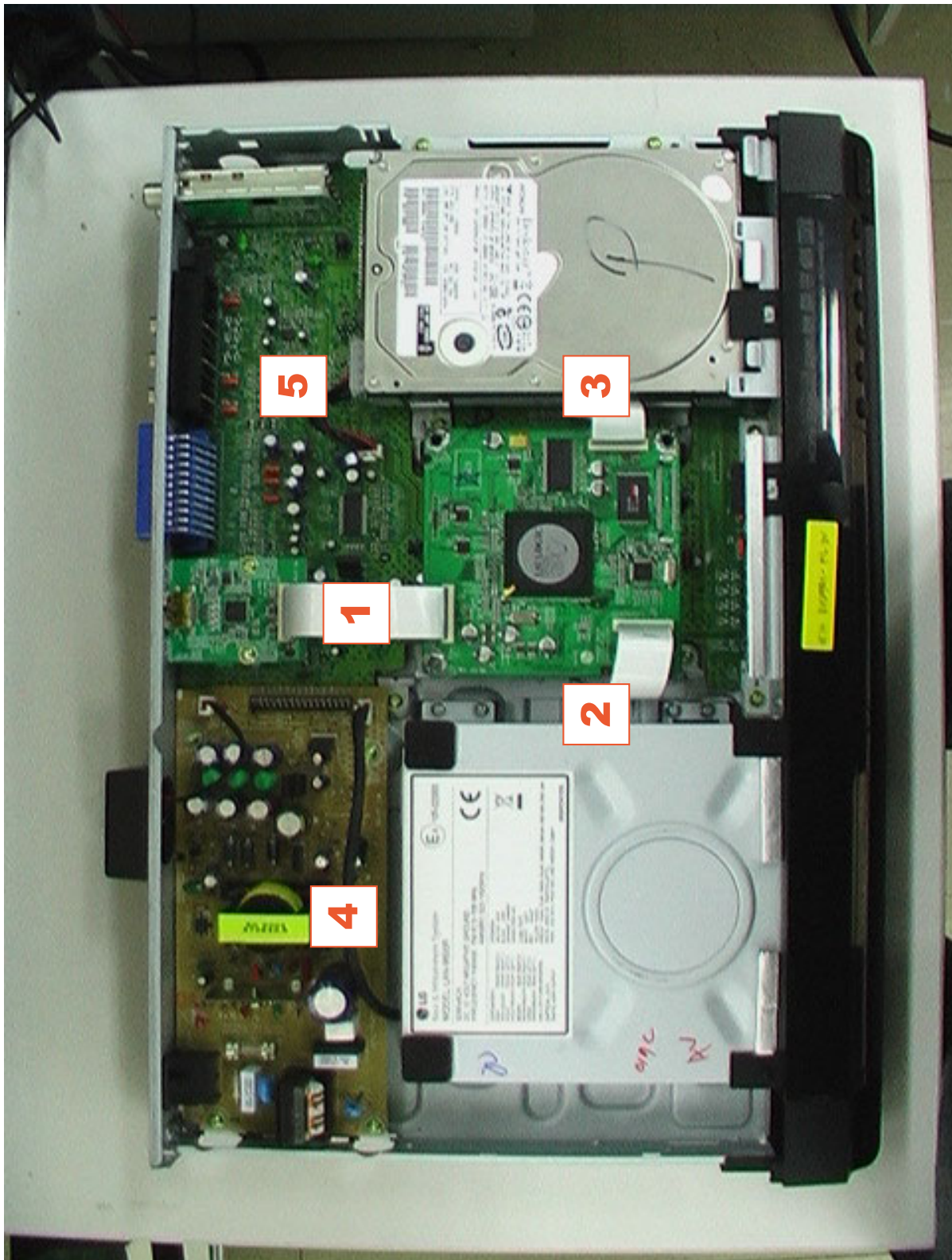

### 3. WIRING CONNECTION DIAGRAM 3

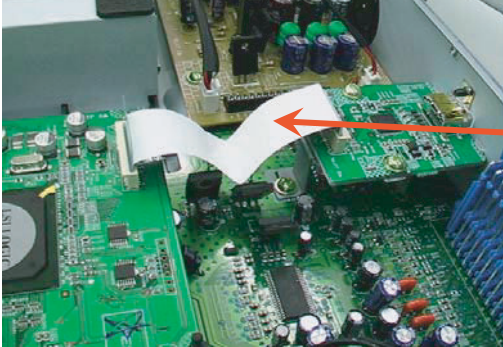

1

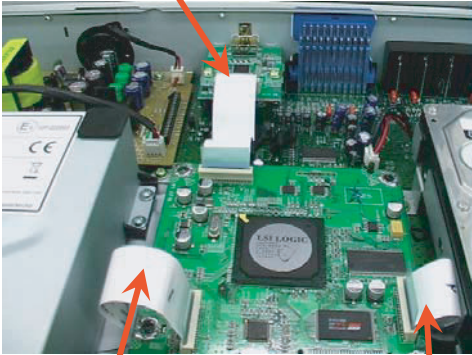

2

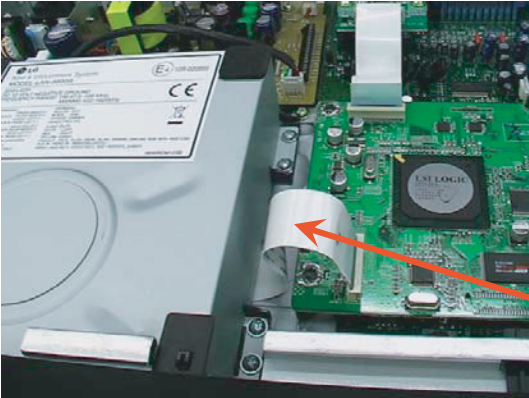

3

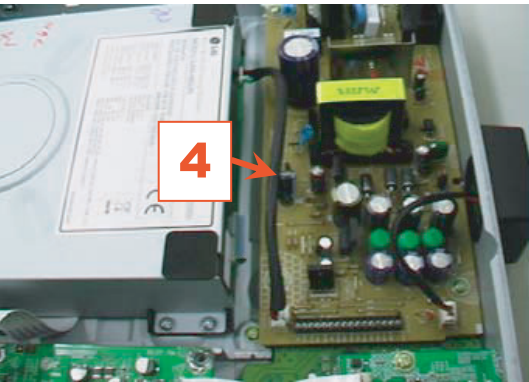

4

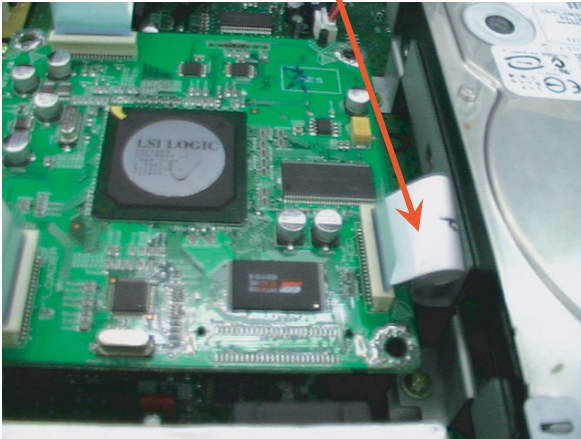

5

# BLOCK DIAGRAMS

## 1. OVERALL BLOCK DIAGRAM

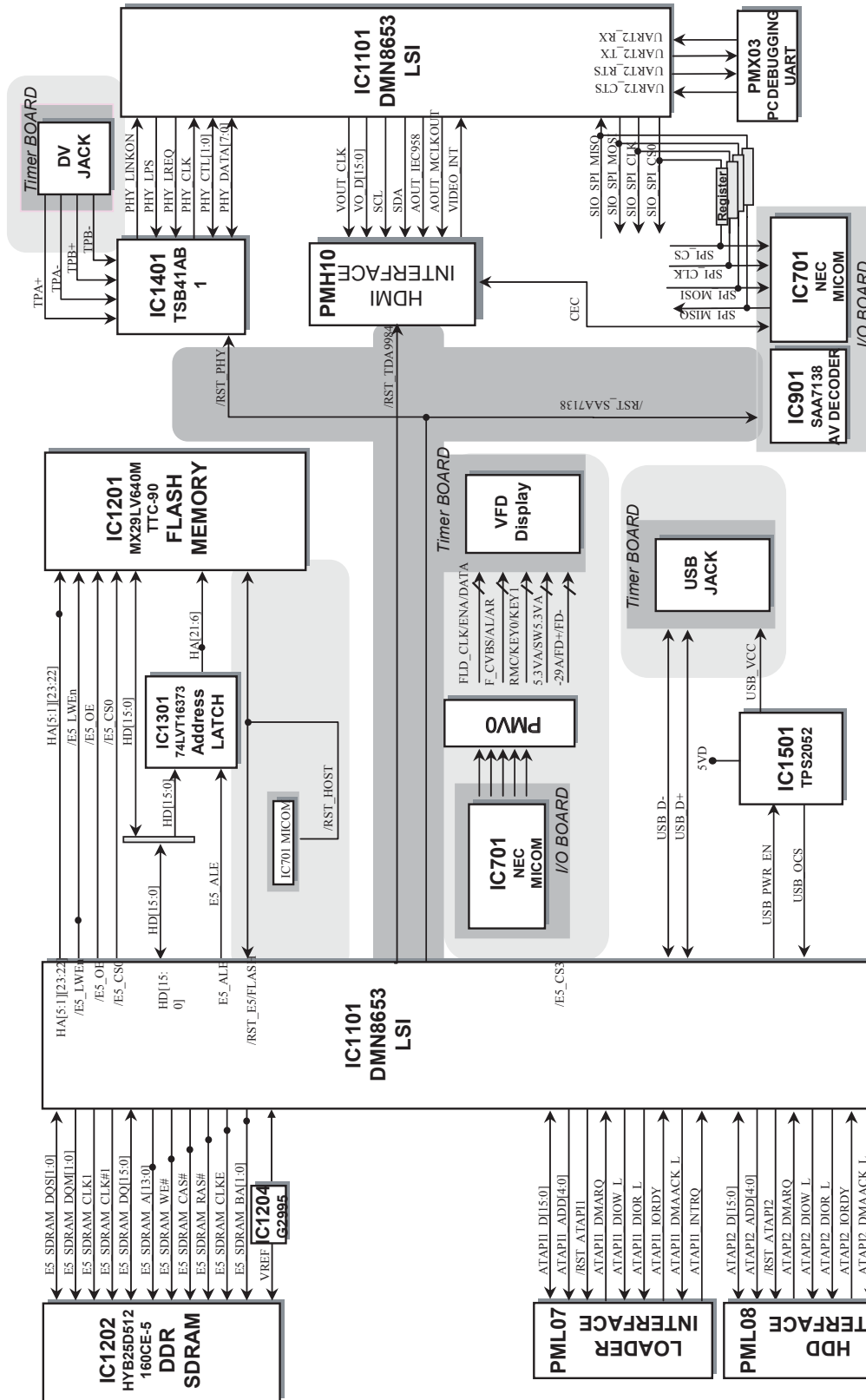

## 2. SMPS BLOCK DIAGRAM

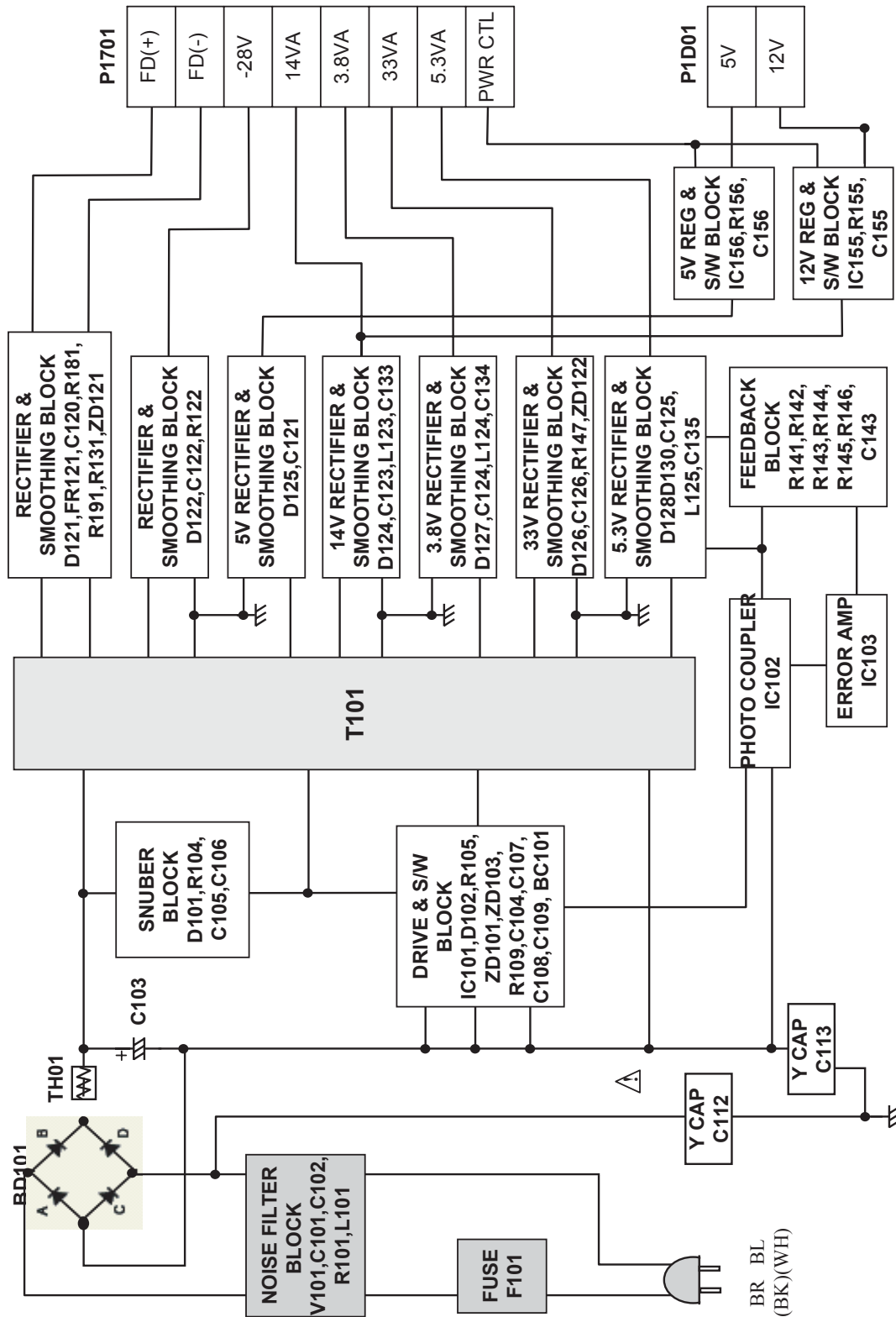

### 3. POWER MAIN BLOCK DIAGRAM

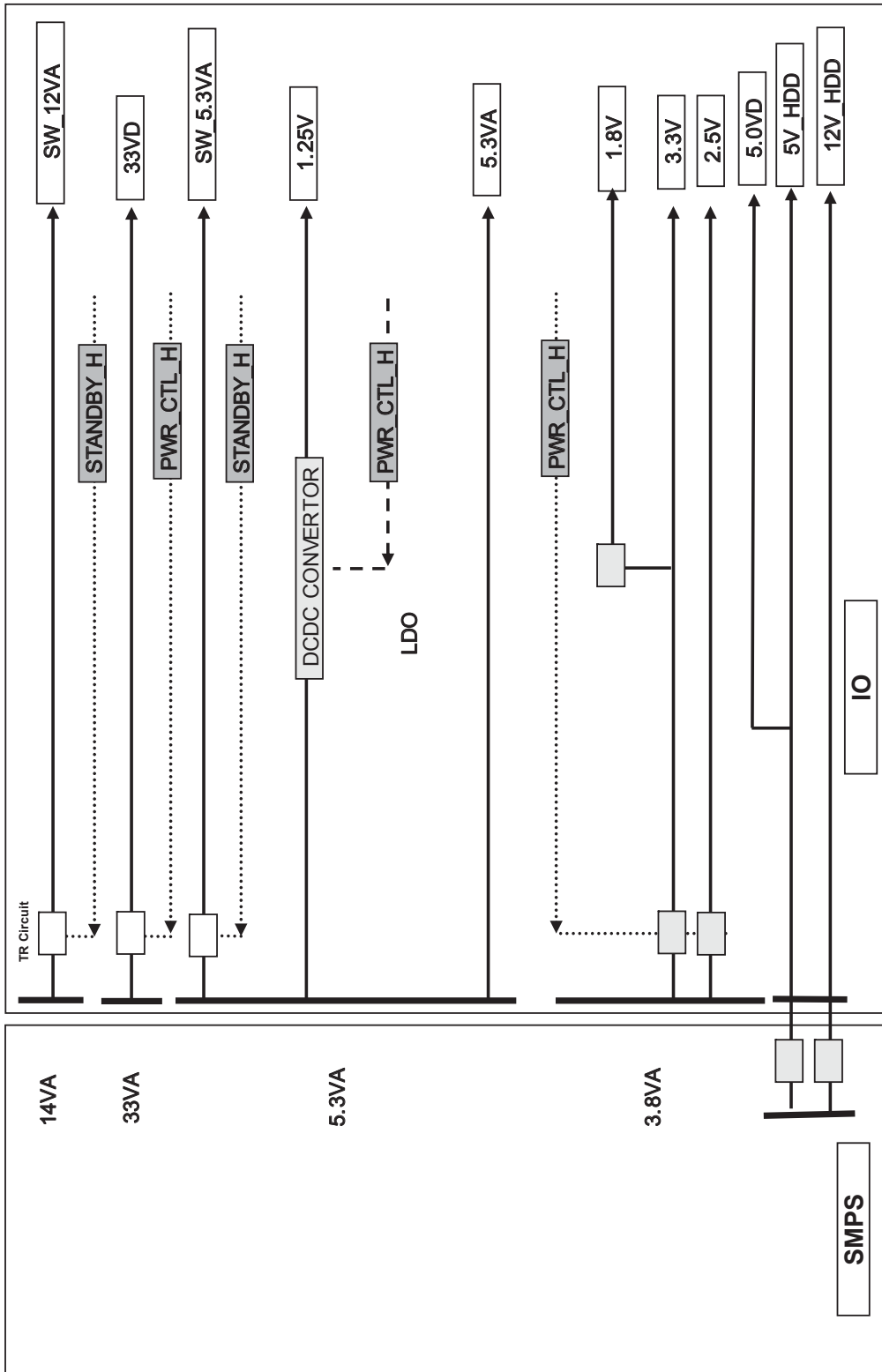

## 4. POWER I/O BLOCK DIAGRAM

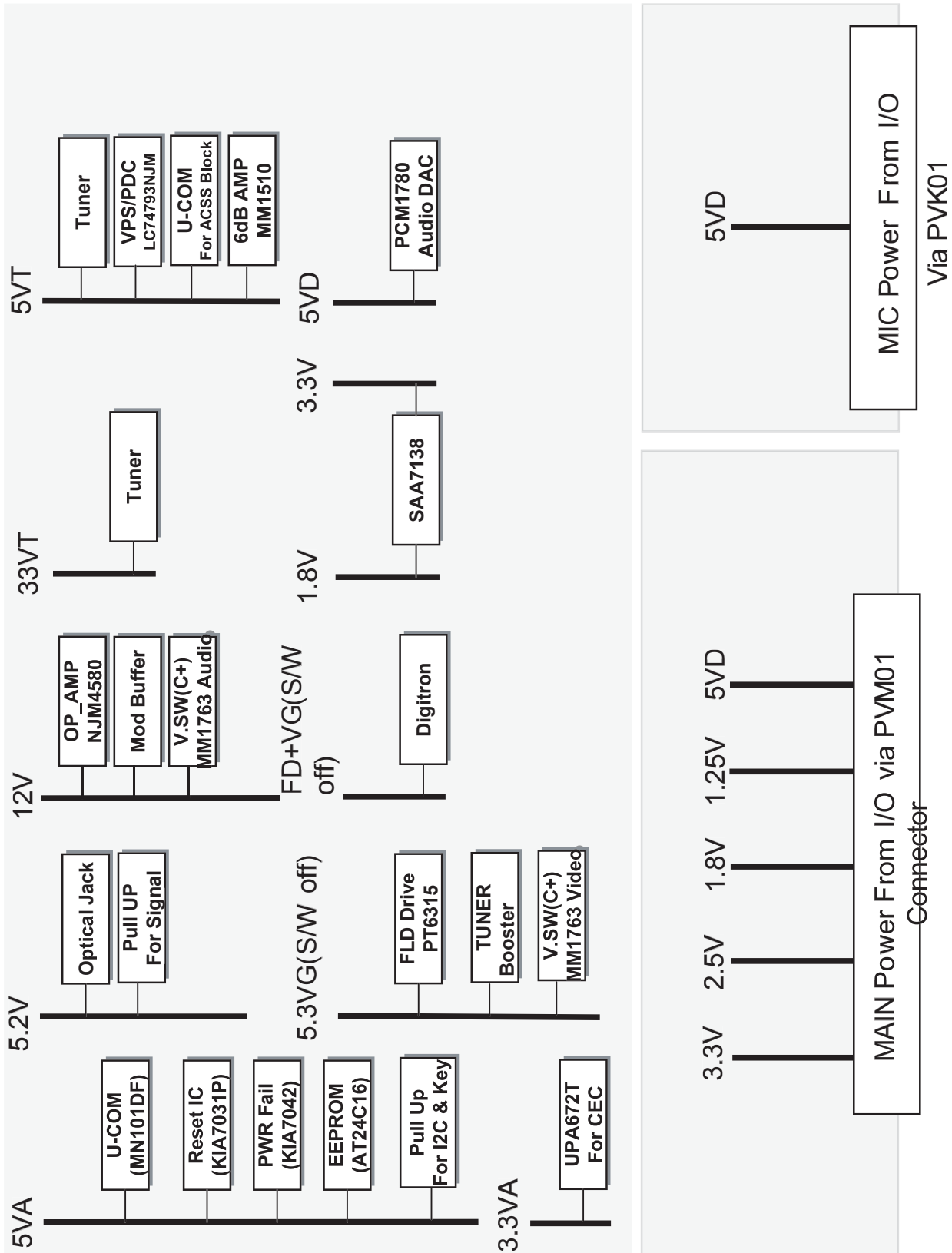

# 5. AV BLOCK DIAGRAM

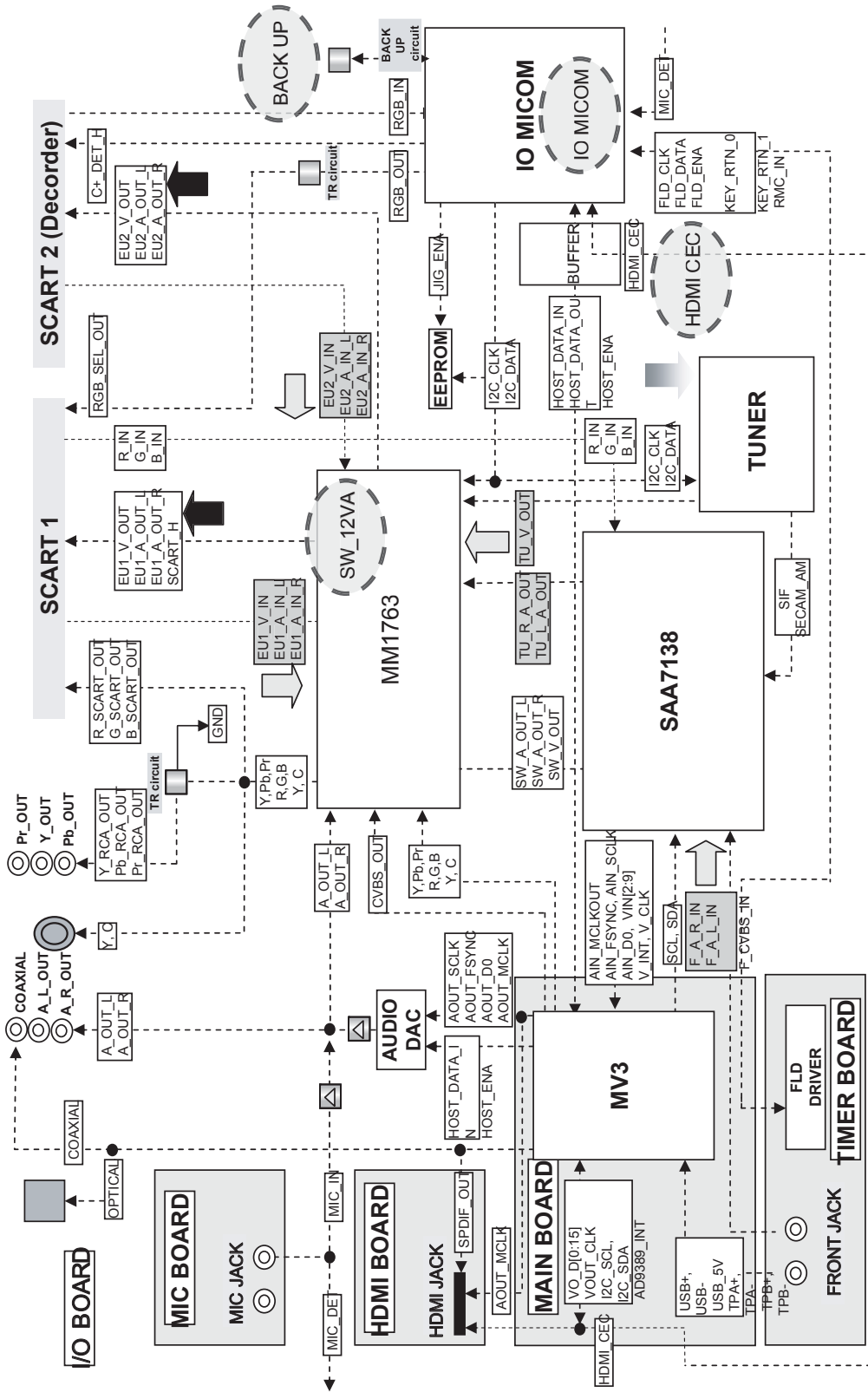



## 6. AUDIO OUT BLOCK DIAGRAM

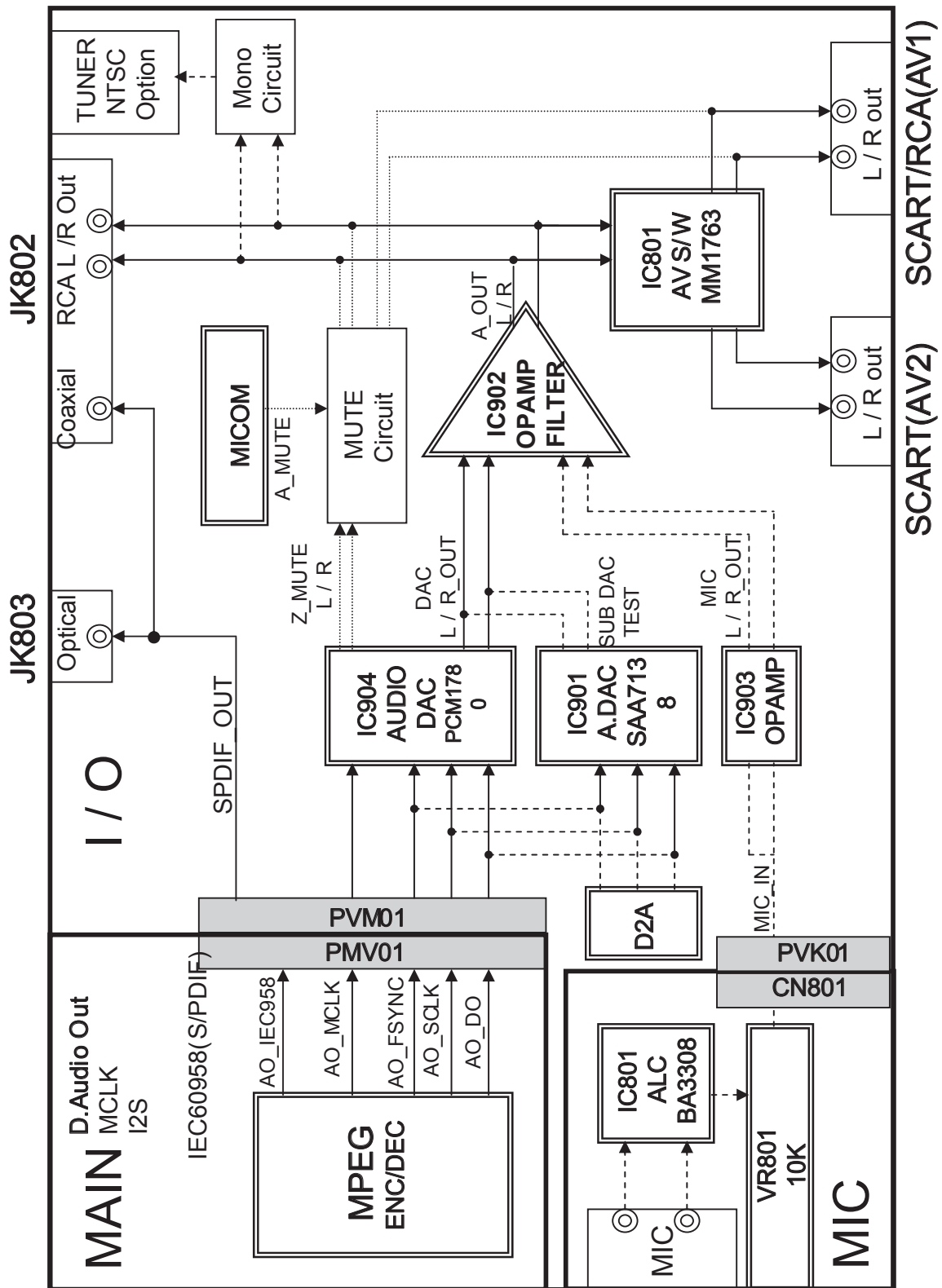

# 7. HDMI BLOCK DIAGRAM

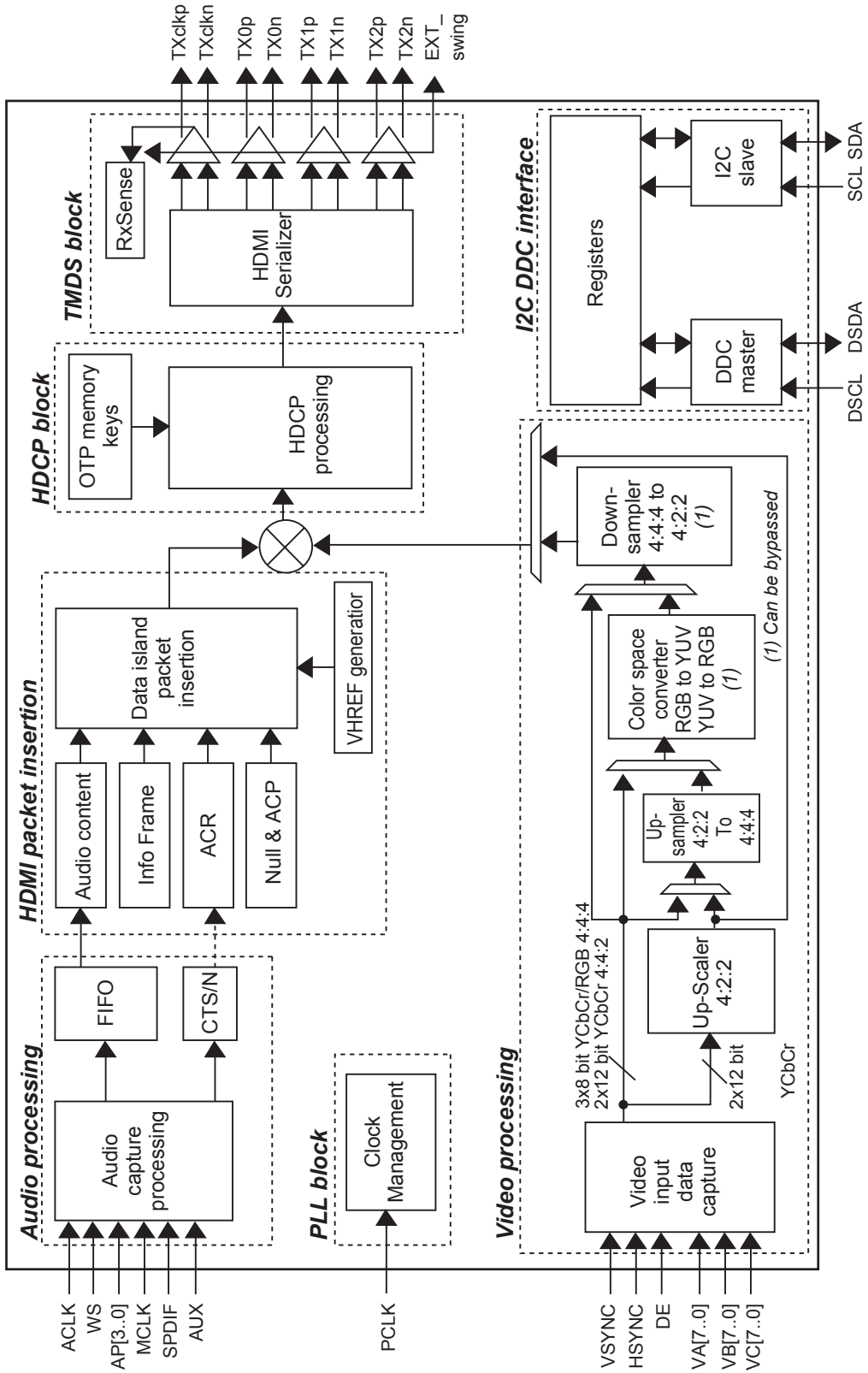

# MEMO

A series of horizontal dotted lines for writing.

# CIRCUIT DIAGRAMS

## 1. SMPS 1 CIRCUIT DIAGRAM

### IMPORTANT SAFETY

WHEN SERVICING THIS CHASSIS, UNDER NO CIRCUMSTANCES SHOULD THE ORIGINAL DESIGN BE MODIFIED OR ALTERED WITHOUT PERMISSION FROM THE LG CORPORATION. ALL COMPONENTS SHOULD BE REPLACED ONLY WITH TYPES IDENTICAL TO THOSE IN THE ORIGINAL CIRCUIT. SPECIAL COMPONENTS ARE SHADED ON THE SCHEMATIC

FOR EASY IDENTIFICATION, THIS CIRCUIT DIAGRAM MAY OCCASIONALLY DIFFER FROM THE ACTUAL CIRCUIT USED. THIS WAY, IMPLEMENTATION OF THE LATEST SAFETY AND PERFORMANCE IMPROVEMENT CHANGES INTO THE SET IS NOT DELAYED UNTIL THE NEW SERVICE LITERATURE IS PRINTED.

### NOTE :

1. Shaded (■) parts are critical for safety. Replace only with specified part number.
2. Voltages are DC-measured with a digital voltmeter during Play mode.

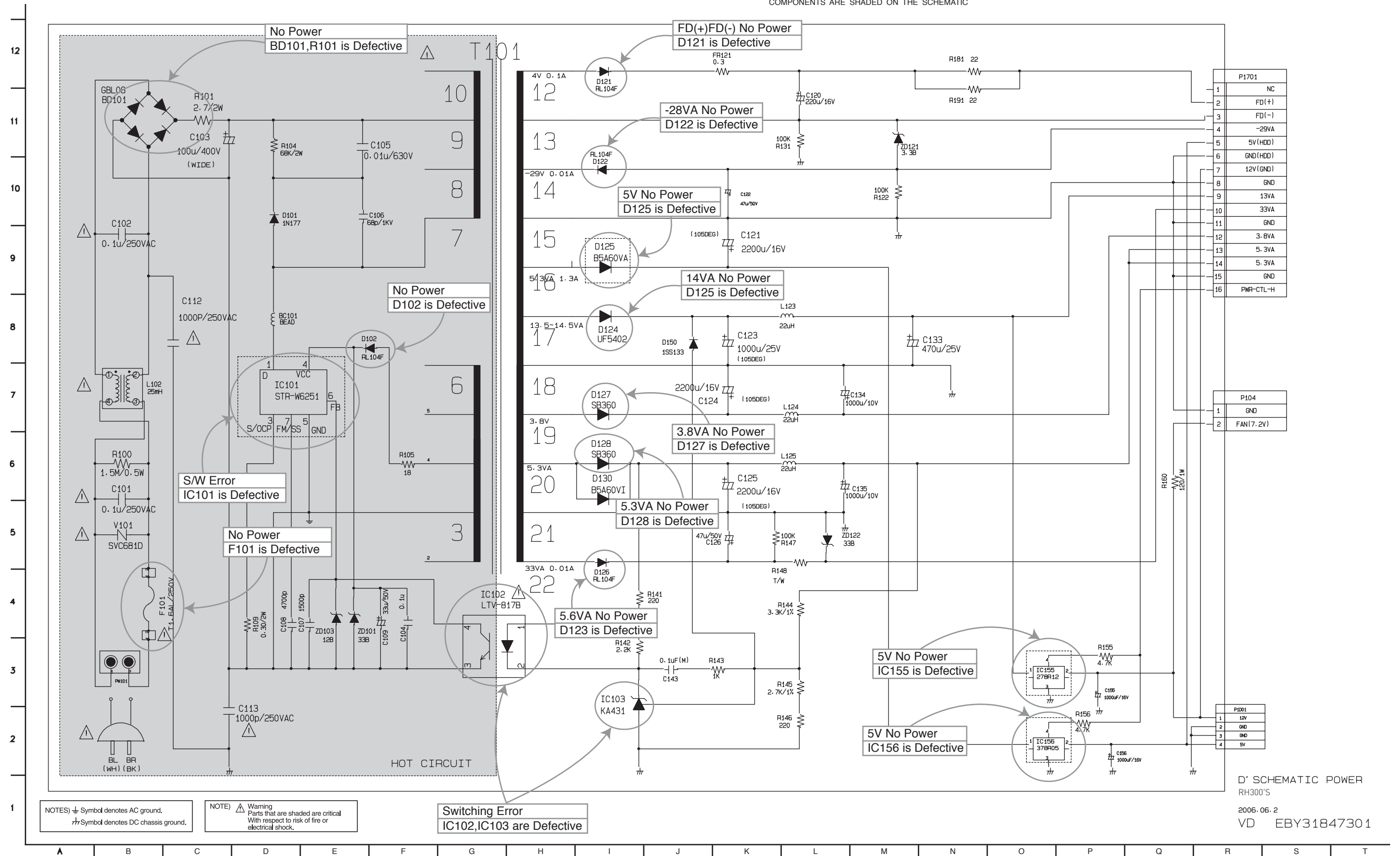

## 2. SMPS 2 CIRCUIT DIAGRAM

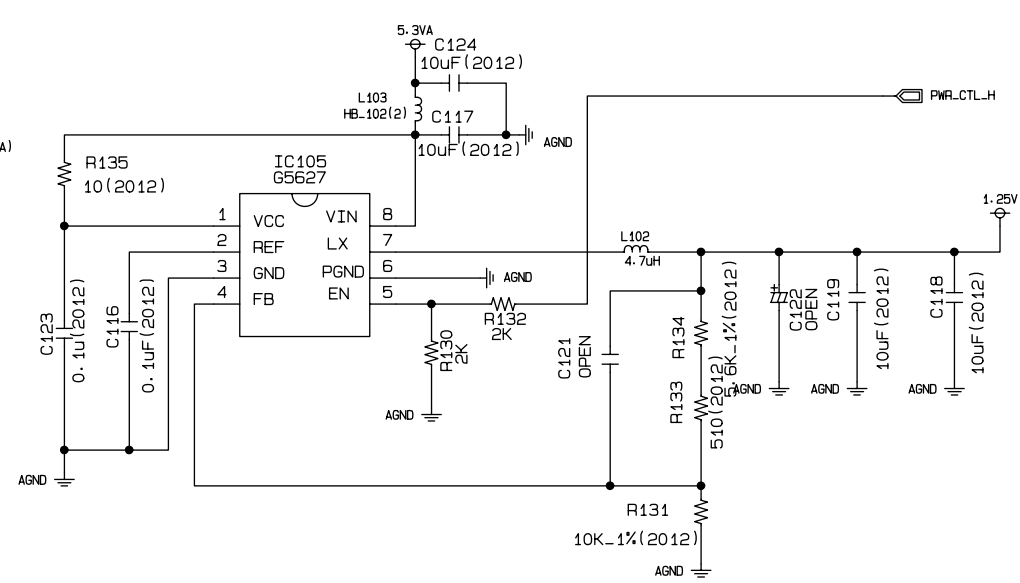
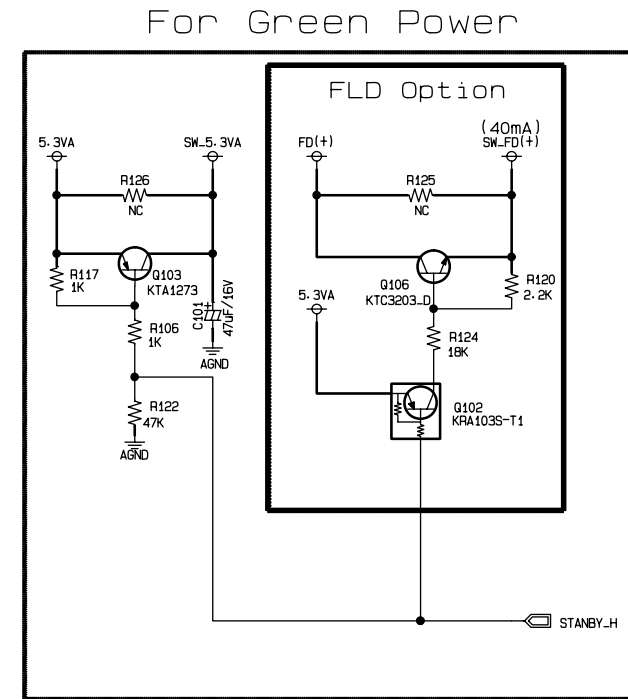
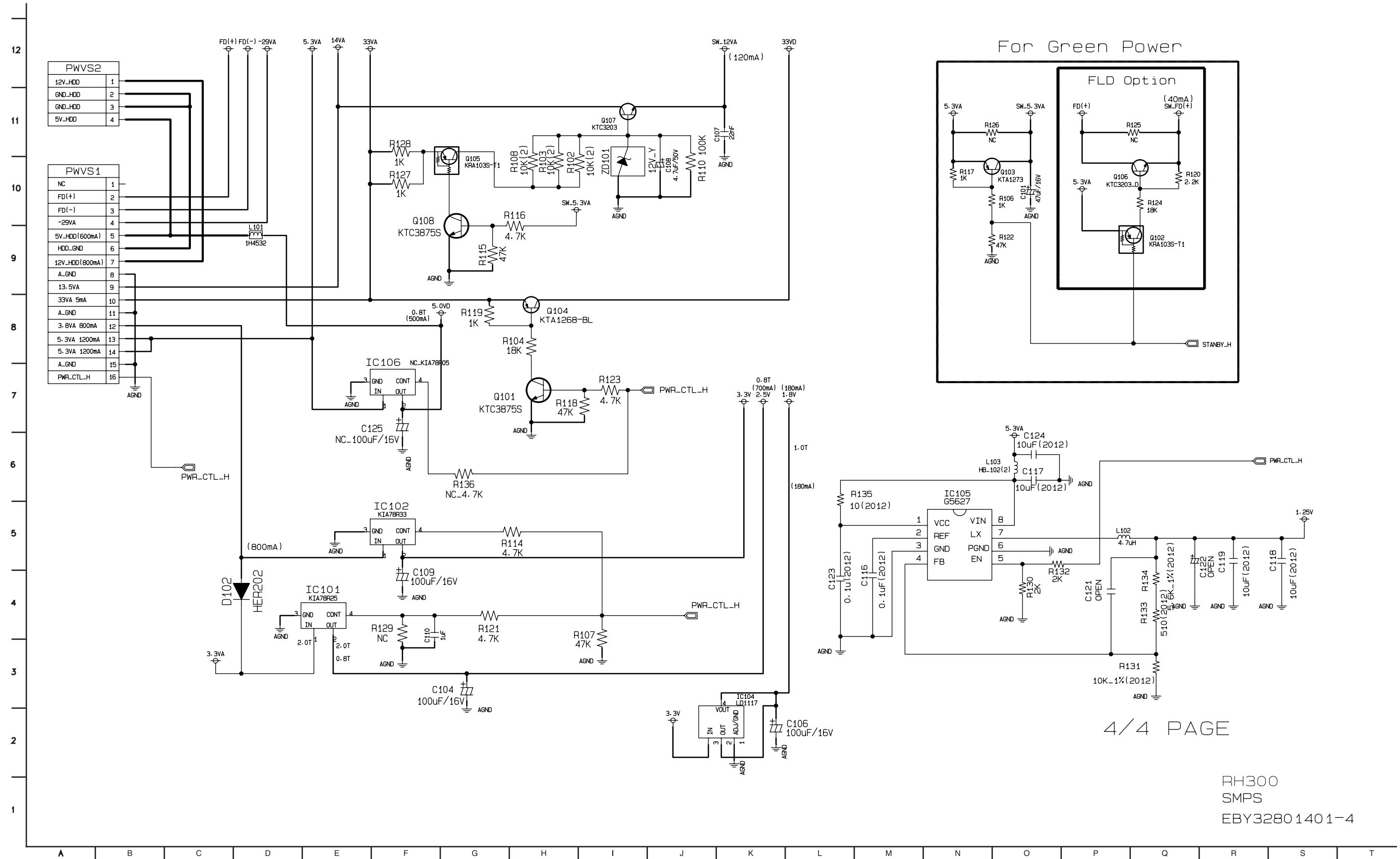

4/4 PAGE

RH300  
SMPS  
EBY32801401-4

### 3. MPEG CIRCUIT DIAGRAM

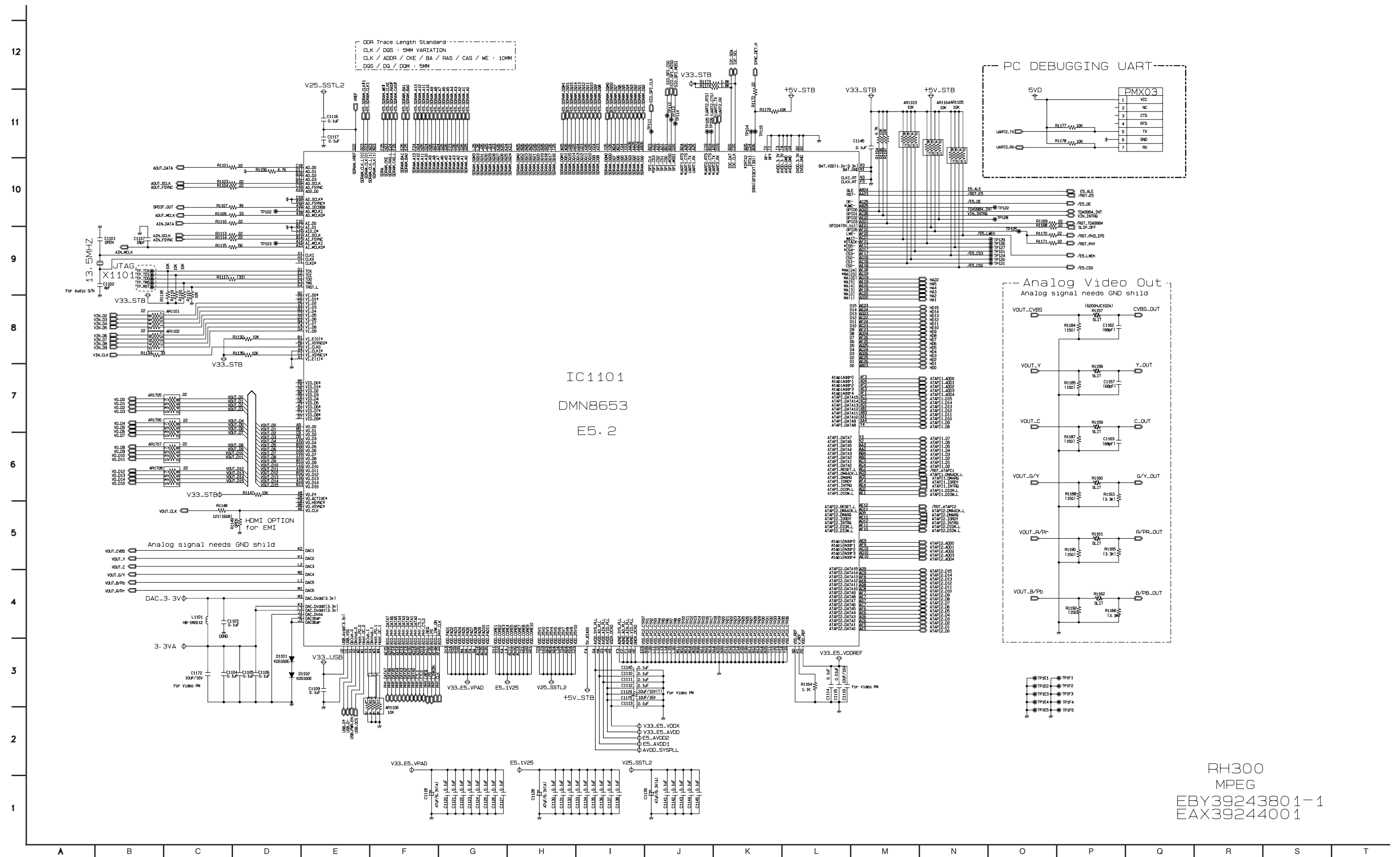

RH300  
MPEG  
EBY3924380 1-1  
EAX3924400 1

# 4. FLASH/DDR/DV CIRCUIT DIAGRAM

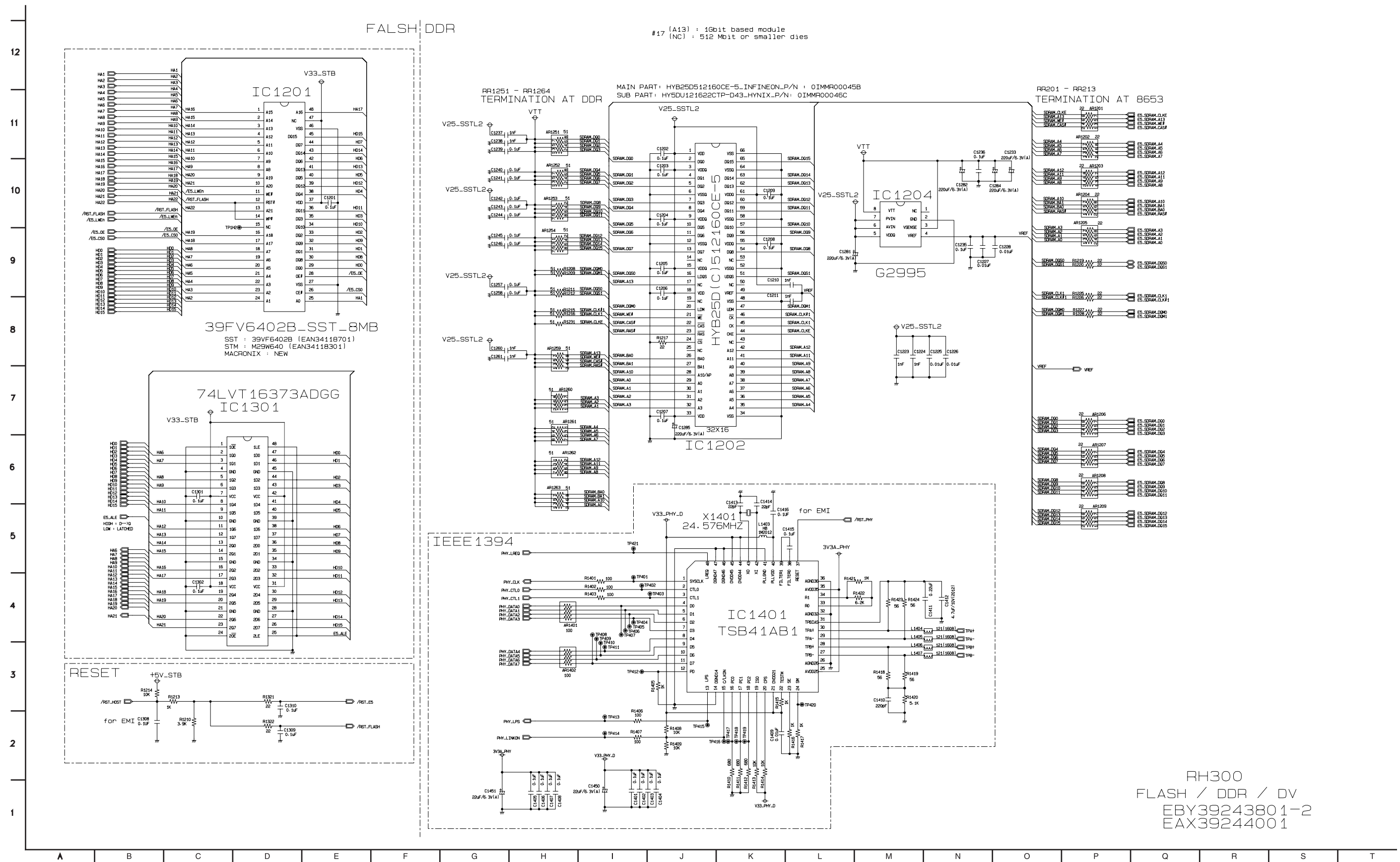

RH300  
 FLASH / DDR / DV  
 EBY39243801-2  
 EAX39244001

# 5. ATAPI, HDMI & USB CIRCUIT DIAGRAM

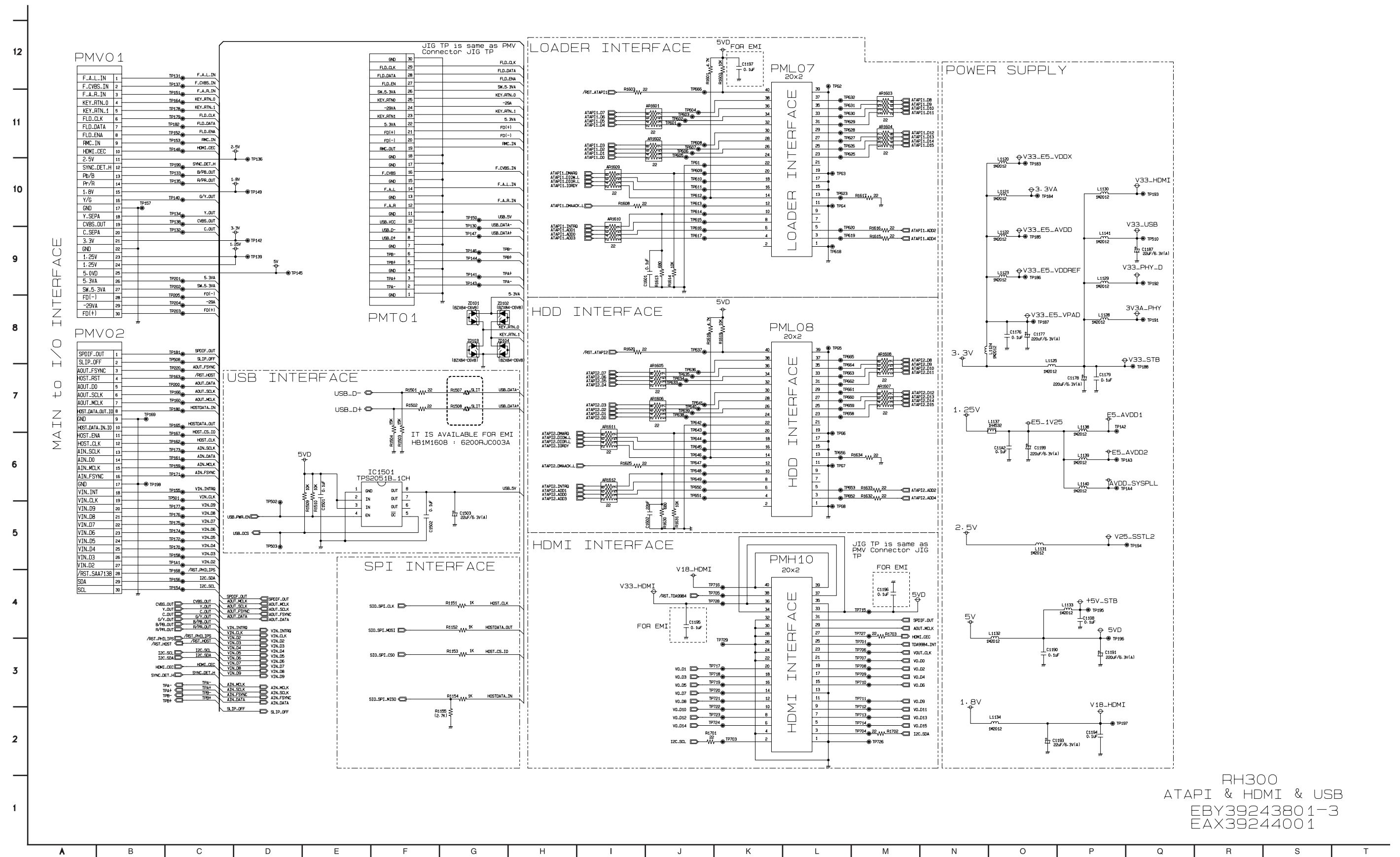

RH300  
ATAPI & HDMI & USB  
EBY39243801-3  
EAX39244001



# 6. I/O, $\mu$ -com CIRCUIT DIAGRAM

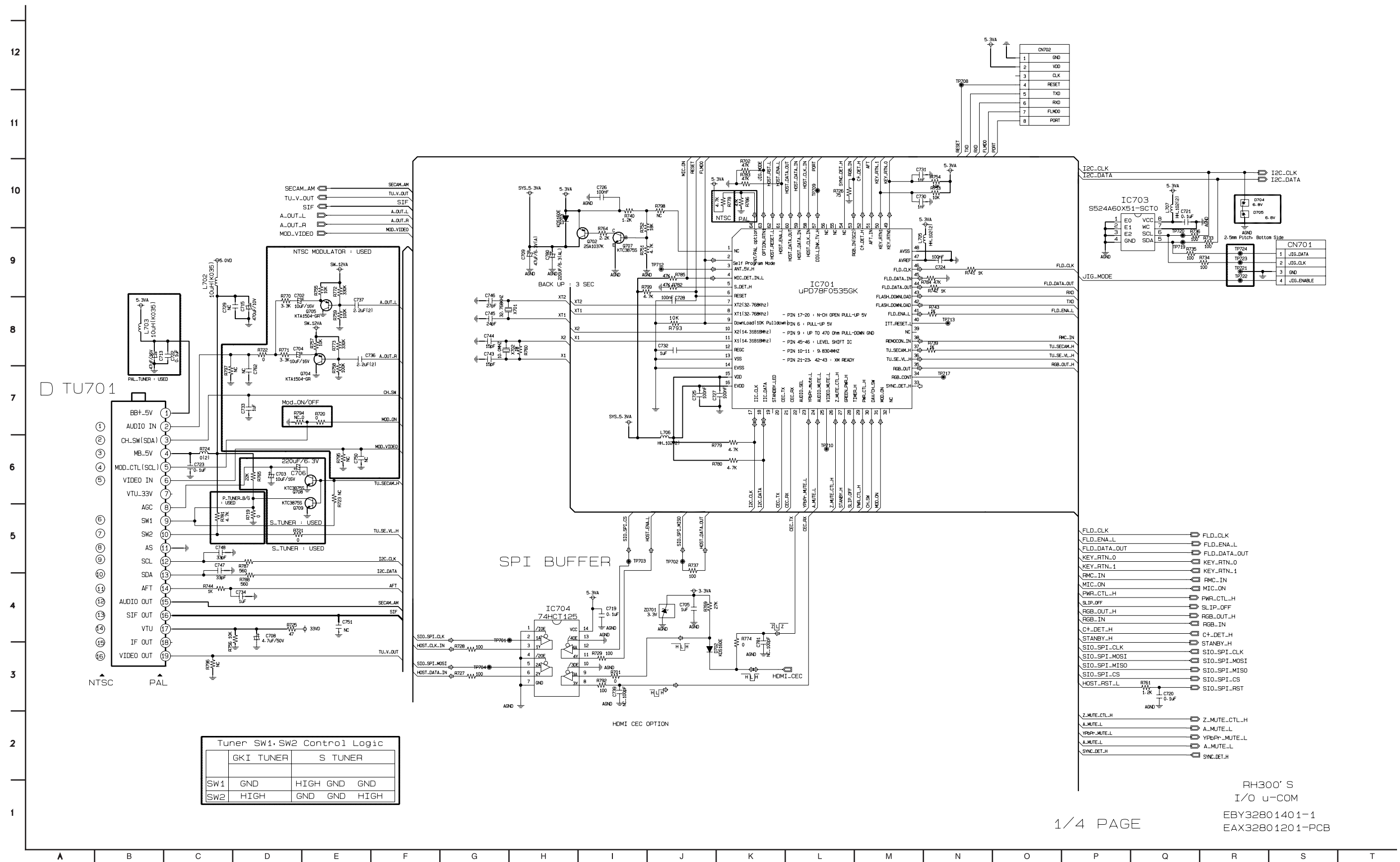

Tuner SW1, SW2 Control Logic

	GKI TUNER		S TUNER	
SW1	GND	HIGH	GND	GND
SW2	HIGH	GND	GND	HIGH

- FLD\_CLK
- FLD\_ENA\_L
- FLD\_DATA\_OUT
- KEY\_RTN\_0
- KEY\_RTN\_1
- RMC\_IN
- MIC\_ON
- PWR\_CTL\_H
- SLIP\_OFF
- RGB\_OUT\_H
- RGB\_IN
- C+DET\_H
- STANBY\_H
- SIO\_SPI\_CLK
- SIO\_SPI\_MOSI
- SIO\_SPI\_MISO
- SIO\_SPI\_CS
- SIO\_SPI\_RST
- Z\_MUTE\_CTL\_H
- A\_MUTE\_L
- YPRP\_MUTE\_L
- A\_MUTE\_L
- SYNC\_DET\_H

RH300' S  
I/O u-COM  
EBY32801401-1  
EAX32801201-PCB

1/4 PAGE

# 7. DECODER & MIC CIRCUIT DIAGRAM

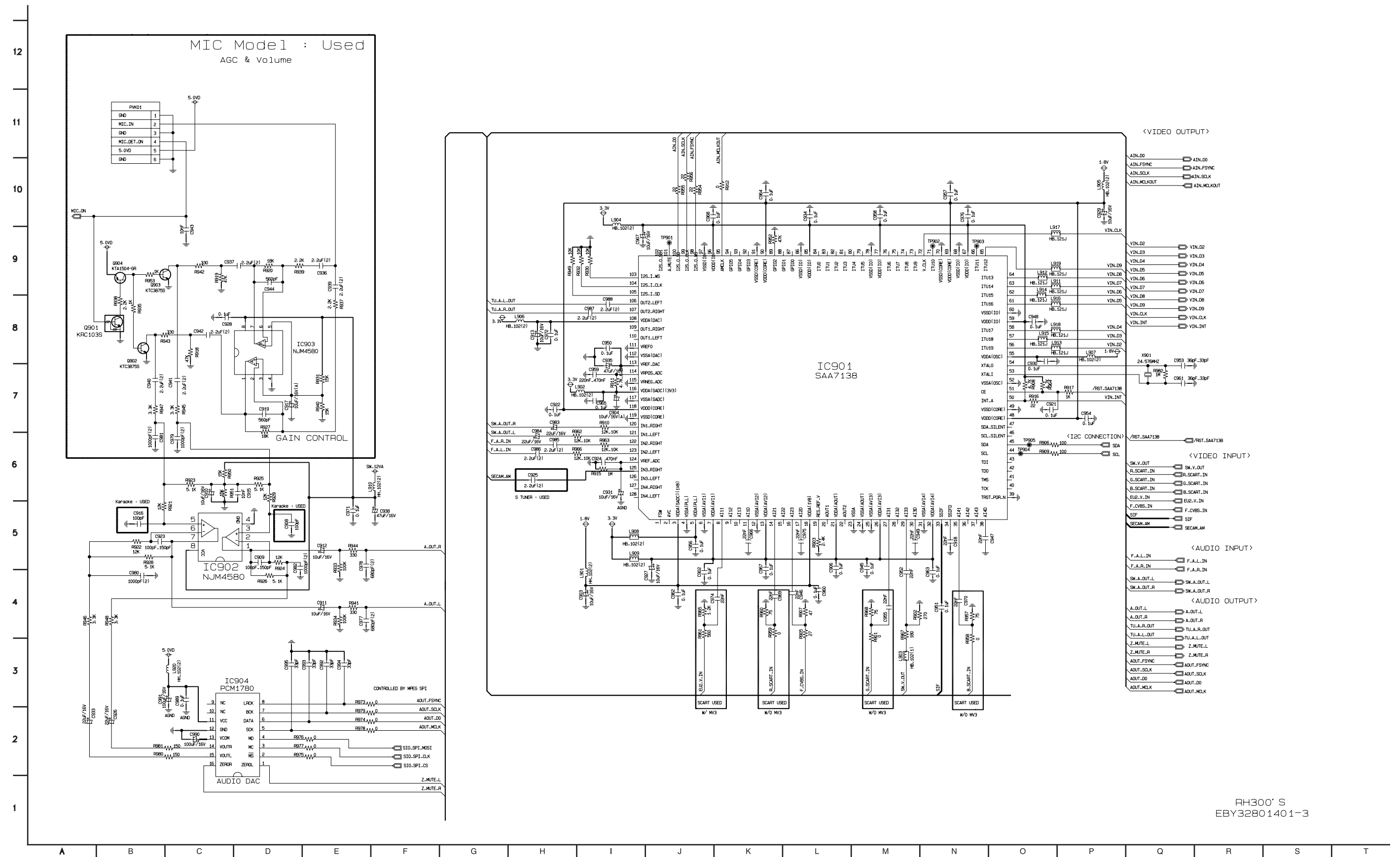

# 8. SCART/RCA CIRCUIT DIAGRAM

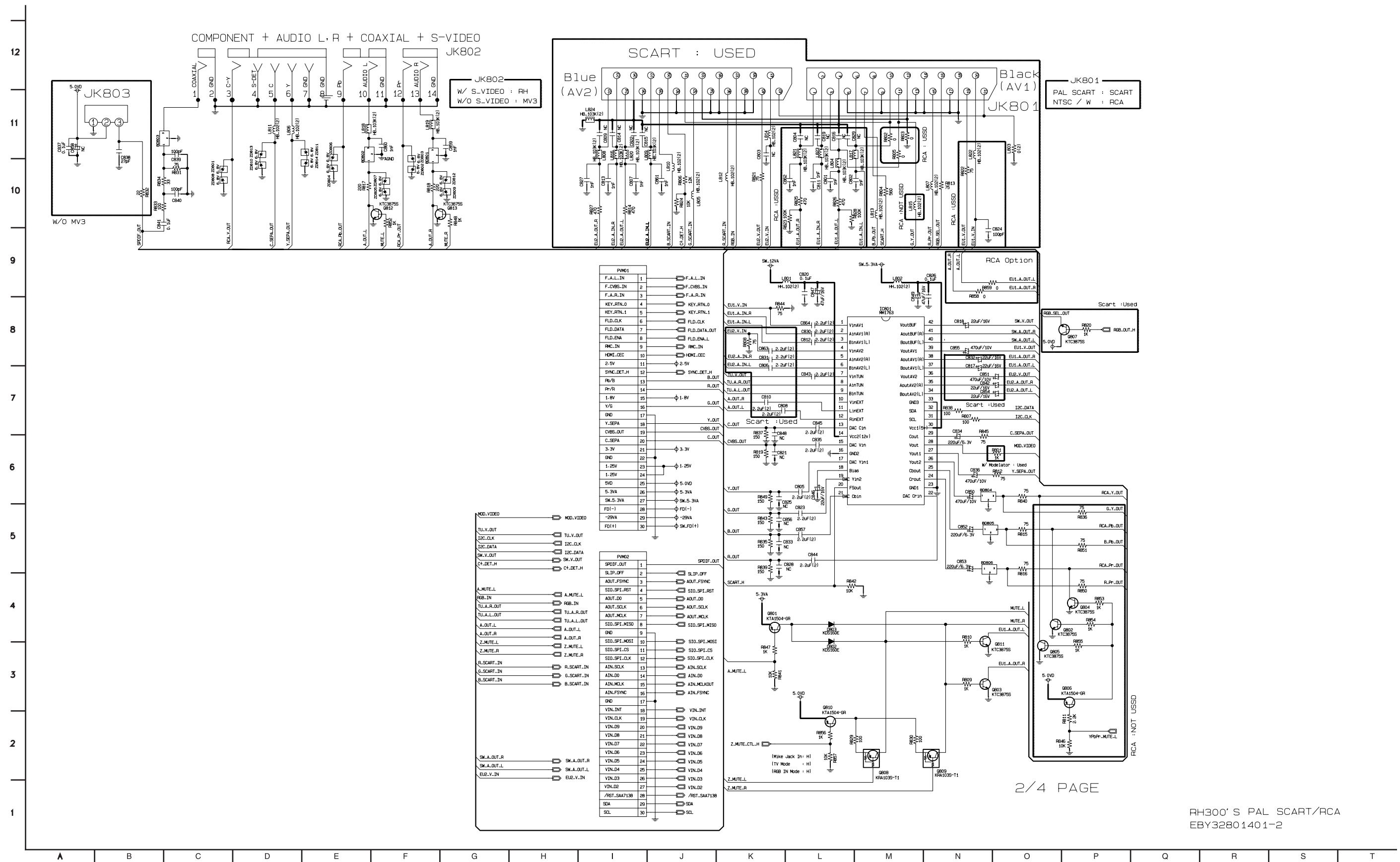

# 9. HDMI CIRCUIT DIAGRAM

PCB P/N:

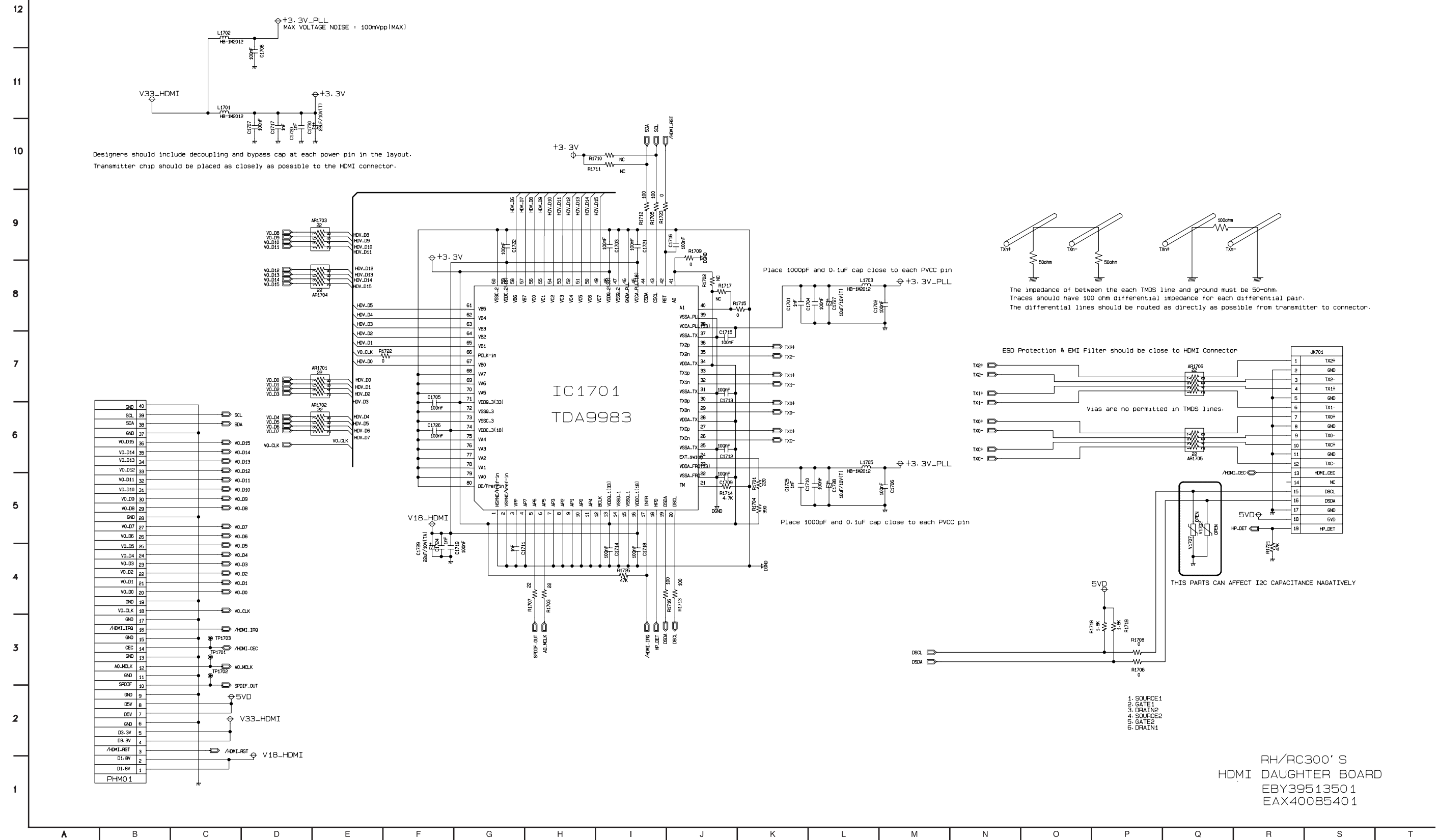

Designers should include decoupling and bypass cap at each power pin in the layout.  
Transmitter chip should be placed as closely as possible to the HDMI connector.

Place 1000pF and 0.1uF cap close to each PVCC pin

Place 1000pF and 0.1uF cap close to each PVCC pin

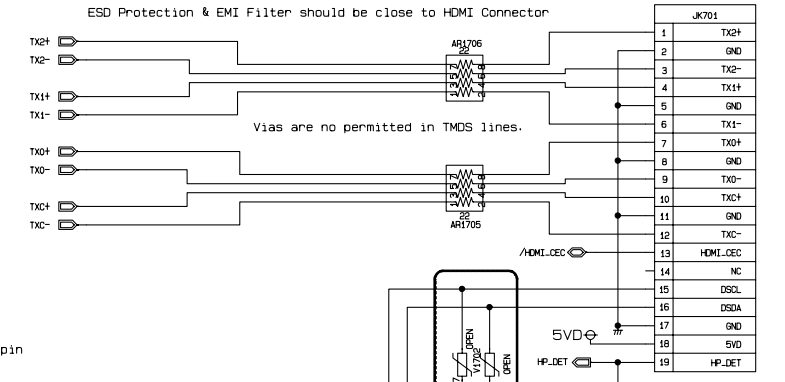
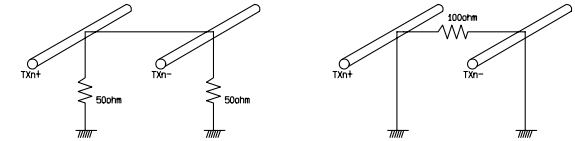

THIS PARTS CAN AFFECT I2C CAPACITANCE NEGATIVELY

- 1. SOURCE1
- 2. GATE1
- 3. DRAIN2
- 4. SOURCE2
- 5. GATE2
- 6. DRAIN1

RH/RC300'S  
HDMI DAUGHTER BOARD  
EBY39513501  
EAX40085401

# 10. TIMER CIRCUIT DIAGRAM (8 & 9 TOOLS)

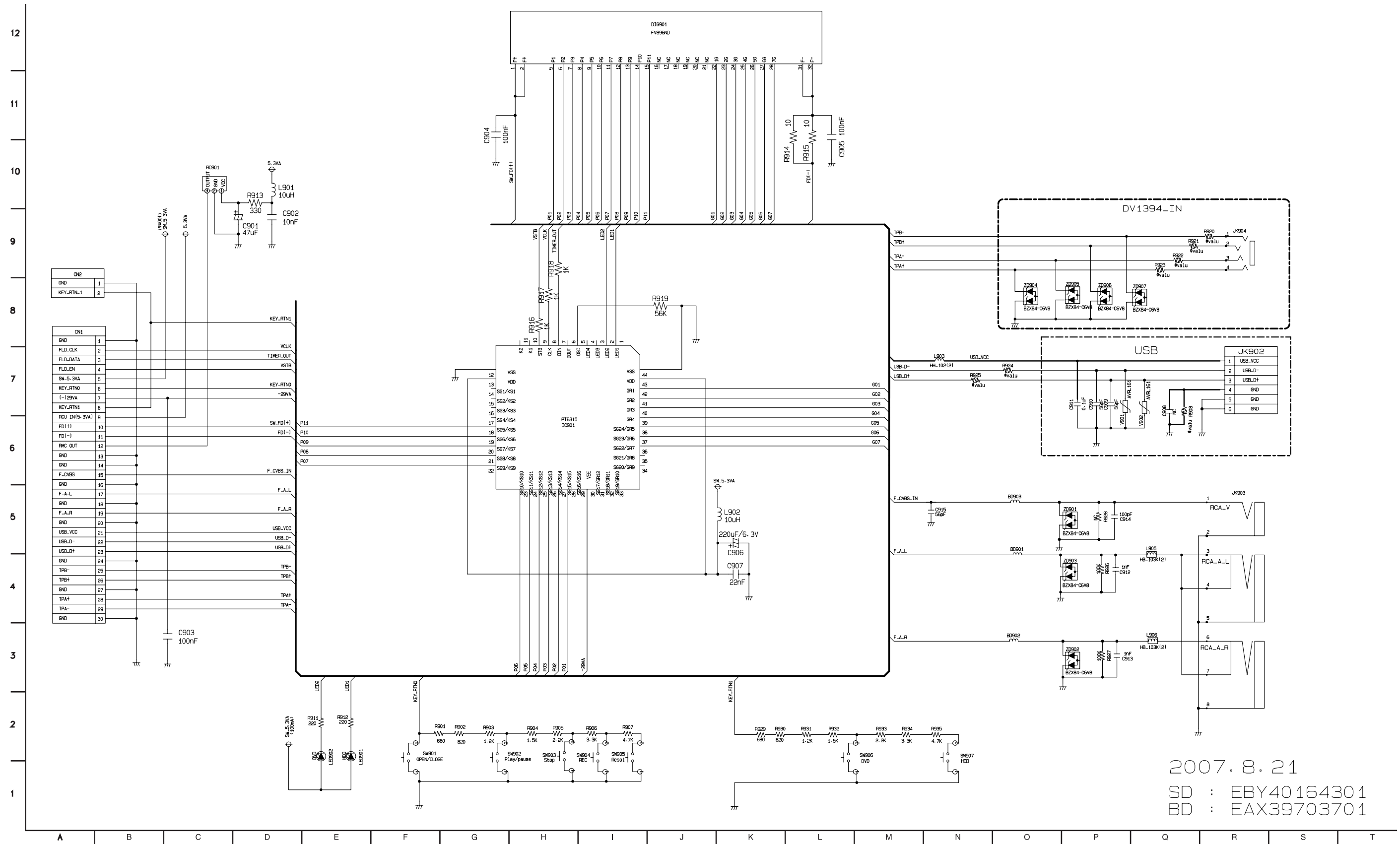

2007. 8. 21  
 SD : EBY40164301  
 BD : EAX39703701

# 11. KEY CIRCUIT DIAGRAM (8 & 9 TOOLS)

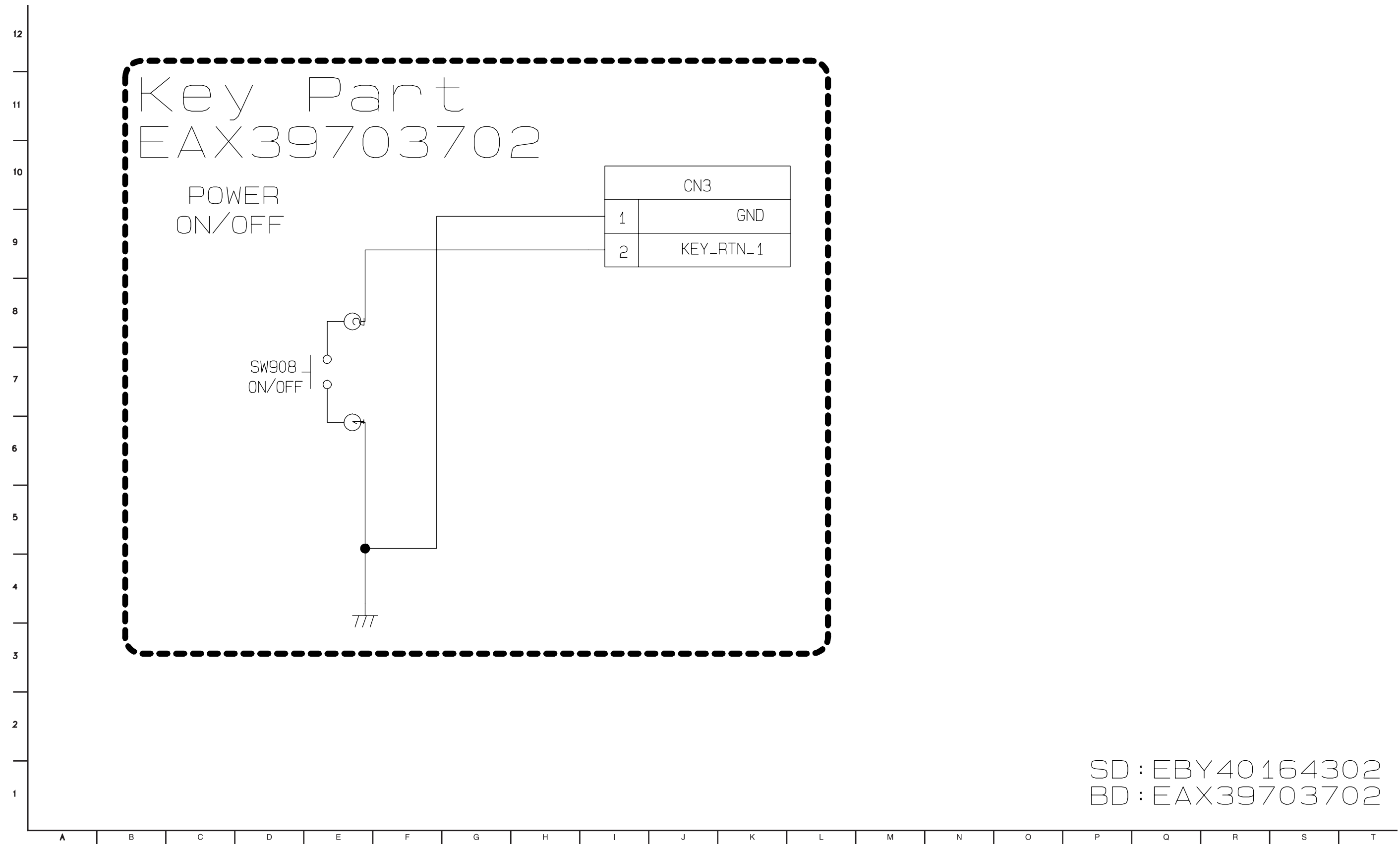

SD : EBY40164302  
BD : EAX39703702

## • CIRCUIT VOLTAGE CHART

### INFORMATION :

1. Voltage Check using W/S
2. EE Mode : Check with signal C2
3. Playback Mode : Check with DVD TEST DISC KDV-N chapter 2
4. Record Mode: Check with recording signal C2 using DVD -RW  
Brand : Victor, VR Mode MLP

PIN	EE MODE	PB MODE	REC MODE
<b>IC105 G5627</b>			
1	5.23V	5.23V	5.21V
2	0.8V	0.8V	0.8V
3	0V	0V	0V
4	0.8V	0.8V	0.8V
5	2.56V	2.56V	2.56V
6	0V	0V	0V
7	1.36V	1.36V	1.36V
8	5.23V	5.23V	5.21V
<b>IC701 uPD78F0535GK</b>			
1	5.23V	5.23V	5.23V
2	0V	0V	0V
3	0V	0V	0V
4	5.22V	5.21V	5.21V
5	0V	0V	0V
6	5.24V	5.24V	5.23V
7	2.67V	2.66V	2.66V
8	2.38V	2.35V	2.34V
9	0V	0V	0.01V
10	3.21V	3.24V	3.21V
11	2.6V	2.65V	2.64V
12	2.53V	2.53V	2.53V
13	0V	0V	0V
14	0V	0V	0V
15	5.23V	5.24V	5.23V
16	5.24V	5.24V	5.24V
17	5.17V	5.16V	5.16V
18	5.17V	5.17V	5.17V
19	0V	0V	0V
20	3.67V	3.68V	3.69V
21	5.28V	5.27V	5.27V
22	0V	0V	0.01V
23	5.21V	5.2V	5.2V
24	5.21V	5.2V	5.2V
25	5.23V	5.22V	5.22V
26	0V	0.08V	0.08V
27	0V	0.09V	0.09V
28	5.23V	5.22V	5.22V
29	5.11V	5.1V	5.1V
30	0V	0V	0.01V
31	0V	0.02V	0.02V
32	0V	0.01V	0.01V
33	4.85V	4.83V	4.83V
34	0V	0.01V	0.02V
35	0V	0.01V	0.01V
36	0V	0.01V	0.01V
37	0V	0.01V	0.01V
38	4.93V	4.93V	4.93V
39	0V	0V	0.01V
40	0V	0.01V	0.01V
41	4.95V	4.94V	4.95V
42	5.21V	5.21V	5.21V
43	0V	0.01V	0.01V
44	0.74V	0.74V	0.75V
45	0V	0V	0V
46	5.17V	5.16V	5.16V
47	5.28V	5.28V	5.28V
48	0V	0V	0V
49	5.24V	5.27V	5.27V
50	2.64V	2.64V	2.64V
51	2.48V	2.47V	2.47V
52	2.65V	2.64V	2.64V
53	0V	0V	0V
54	0V	0V	0V
55	0V	0V	0V
56	0V	0V	0V

PIN	EE MODE	PB MODE	REC MODE
57	5.23V	5.23V	5.23V
58	5.07V	5.06V	5.27V
59	0V	0.01V	0V
60	0.4V	0.42V	0V
61	5.28V	5.27V	5.27V
62	5.19V	5.19V	5.19V
63	0V	0V	0V
64	0V	0V	0V
<b>IC703 S524A60X51-SCTO</b>			
1	0V	0V	0V
2	0V	0V	0V
3	0V	0V	0V
4	0V	0V	0V
5	5.17V	5.17V	5.17V
6	5.16V	5.15V	5.16V
7	0V	0V	0V
8	5.28V	5.28V	5.28V
<b>IC704 74HCT125</b>			
1	0V	0V	0V
2	3.09V	3.08V	3.08V
3	5.07V	5.06V	5.07V
4	0V	0V	0V
5	0V	0V	0.01V
6	0V	0V	0.01V
7	0V	0V	0V
8	5.28V	5.28V	5.27V
9	3.68V	3.68V	3.67V
10	0V	0V	0V
11	5.28V	5.28V	5.27V
12	3.22V	3.22V	3.22V
13	0V	0V	0V
14	5.28V	5.27V	5.28V
<b>IC801 MM1763</b>			
1	1.09V	1.09V	1.08V
2	6.93V	6.93V	6.94V
3	6.93V	6.93V	6.94V
4	1.09V	1.09V	1.08V
5	6.94V	6.93V	6.94V
6	6.94V	6.93V	6.94V
7	1.59V	1.59V	1.59V
8	6.93V	6.93V	6.93V
9	6.94V	6.93V	6.93V
10	1.09V	1.09V	1.09V
11	6.93V	6.93V	6.93V
12	6.94V	6.93V	6.93V
13	2.42V	2.42V	2.42V
14	12.06V	12.06V	12.08V
15	1.57V	1.67V	1.57V
16	0V	0V	0V
17	1.56V	1.66V	1.56V
18	2.45V	2.45V	2.45V
19	1.55V	1.64V	1.54V
20	9.97V	9.96V	9.96V
21	2.42V	2.42V	2.42V
22	2.42V	2.42V	2.42V
23	0V	0V	0V
24	0V	0V	0V
25	0V	0.01V	0V
26	2.08V	2.27V	2.08V
27	2.11V	2.31V	2.11V
28	2.12V	2.33V	2.12V
29	2.49V	2.49V	2.49V
30	5.1V	5.1V	5.09V
31	5.16V	5.16V	5.16V
32	5.17V	5.17V	5.17V
33	0V	0V	0V

PIN	EE MODE	PB MODE	REC MODE
34	6.47V	6.48V	6.48V
35	6.47V	6.48V	6.47V
36	2.13V	2.34V	2.14V
37	6.48V	6.47V	6.47V
38	6.47V	6.47V	6.47V
39	2.13V	2.34V	2.13V
40	6.46V	6.46V	6.46V
41	6.46V	6.46V	6.46V
42	1.6V	1.61V	1.6V
<b>IC901 SAA7138</b>			
1	0V	0.01V	0V
2	0V	0V	0V
3	1.82V	1.82V	1.82V
4	0V	0V	0V
5	3.28V	3.28V	3.28V
6	0V	0V	0V
7	3.26V	3.26V	3.26V
8	0.57V	0.57V	0.57V
9	0.57V	0.57V	0.57V
10	0.57V	0.57V	0.57V
11	1V	1V	1V
12	0V	0V	0V
13	3.26V	3.26V	3.26V
14	0.4V	0.41V	0.41V
15	0.56V	0.56V	0.56V
16	0.56V	0.56V	0.56V
17	0.99V	0.99V	0.99V
18	1.82V	1.82V	1.82V
19	0V	0V	0V
20	2.11V	2.11V	2.11V
21	3.26V	3.27V	3.27V
22	0V	0V	0V
23	0V	0V	0V
24	0V	0V	0V
25	0V	0V	0V
26	3.26V	3.26V	3.26V
27	0.44V	0.44V	0.44V
28	0.56V	0.56V	0.56V
29	0.89V	0.89V	0.89V
30	0.98V	0.98V	0.98V
31	0V	0V	0V
32	3.26V	3.26V	3.26V
33	1.01V	1.01V	1.01V
34	1.01V	1.01V	1.01V
35	0.57V	0.57V	0.58V
36	0.57V	0.57V	0.57V
37	0.57V	0.57V	0.57V
38	0.99V	1V	1V
39	0V	0V	0V
40	0V	0.01V	0V
41	3.28V	3.28V	3.28V
42	0V	0.01V	0.01V
43	3.28V	3.28V	3.28V
44	3.27V	3.2V	3.22V
45	3.15V	3.15V	3.14V
46	0V	0.01V	0.01V
47	0V	0.01V	0.01V
48	1.8V	1.8V	1.8V
49	0V	0V	0V
50	0.05V	0.05V	0.05V
51	3.28V	3.29V	3.27V
52	0V	0V	0V
53	0.88V	0.88V	0.88V
54	0.87V	0.87V	0.88V
55	1.83V	1.83V	1.83V
56	1.4V	1.4V	1.4V

PIN	EE MODE	PB MODE	REC MODE
57	1.34V	1.33V	1.32V
58	1.38V	1.37V	1.36V
59	3.29V	3.29V	3.28V
60	0V	0V	0V
61	1.57V	1.62V	1.61V
62	1.47V	1.47V	1.46V
63	1.23V	1.23V	1.22V
64	1.13V	1.14V	1.14V
65	1.35V	1.32V	1.32V
66	3.03V	3.03V	3.03V
67	3.29V	3.29V	3.29V
68	0V	0V	0V
69	1.8V	1.8V	1.8V
70	0V	0V	0V
71	2.74V	2.74V	2.74V
72	1.58V	1.5V	1.53V
73	1.4V	1.42V	1.42V
74	1.32V	1.33V	1.33V
75	1.37V	1.37V	1.36V
76	1.53V	1.53V	1.56V
77	3.29V	3.29V	3.29V
78	0V	0V	0V
79	1.48V	1.47V	1.48V
80	1.23V	1.24V	1.24V
81	1.14V	1.15V	1.15V
82	1.35V	1.34V	1.34V
83	0V	0V	0V
84	1.75V	1.75V	1.75V
85	3.29V	3.29V	3.29V
86	0V	0V	0V
87	3.29V	3.29V	3.29V
88	3.29V	3.29V	3.29V
89	3.29V	3.29V	3.29V
90	1.8V	1.8V	1.8V
91	0V	0V	0V
92	3.29V	3.29V	3.29V
93	3.29V	3.29V	3.29V
94	3.29V	3.29V	3.29V
95	1.66V	1.65V	1.65V
96	3.29V	3.29V	3.29V
97	0V	0V	0V
98	1.65V	1.64V	1.64V
99	1.66V	1.64V	1.65V
100	1.24V	1.24V	1.24V
101	0V	0V	0V
102	3.28V	3.28V	3.28V
103	0.47V	0.47V	0.47V
104	0.47V	0.47V	0.47V
105	0.47V	0.47V	0.47V
106	1.64V	1.64V	1.64V
107	1.64V	1.64V	1.64V
108	3.29V	3.29V	3.29V
109	1.64V	1.64V	1.64V
110	1.64V	1.64V	1.64V
111	0V	0V	0V
112	0V	0V	0V
113	1.63V	1.63V	1.63V
114	3.12V	3.12V	3.12V
115	0V	0V	0V
116	3.29V	3.29V	3.29V
117	0V	0V	0V
118	1.8V	1.8V	1.81V
119	0V	0V	0V
120	1.62V	1.62V	1.62V
121	1.62V	1.62V	1.62V
122	1.62V	1.62V	1.62V

PIN	EE MODE	PB MODE	REC MODE
123	1.62V	1.62V	1.62V
124	1.62V	1.62V	1.62V
125	1.62V	1.62V	1.62V
126	1.62V	1.62V	1.62V
127	1.62V	1.62V	1.62V
128	1.62V	1.62V	1.62V
<b>IC902 NJM4580</b>			
1	5.99V	6.02V	6.02V
2	6V	6.02V	6.02V
3	5.98V	6V	6V
4	0V	0V	0V
5	5.98V	6.01V	6V
6	6V	6.02V	6.02V
7	6V	6.02V	6.02V
8	12.03V	12.08V	12.08V
<b>IC904 PCM1780</b>			
1	4.8V	0.01V	4.87V
2	3.21V	3.23V	3.22V
3	3.08V	3.1V	3.08V
4	0V	0.01V	0V
5	1.66V	1.67V	1.66V
6	1.63V	0.01V	1.63V
7	1.63V	1.64V	1.64V
8	1.63V	1.64V	1.63V
9	0V	0V	0V
10	0V	0V	0V
11	4.88V	4.88V	4.87V
12	0V	0V	0V
13	2.44V	2.44V	2.43V
14	2.38V	2.37V	2.37V
15	2.39V	2.38V	2.38V
16	4.88V	0V	4.87V
<b>IC1701 TDA9983A</b>			
1	0V	0V	0V
2	0V	0	

NO	PIN NAME	EE MODE	PB MODE	REC MODE
<b>IC401 TSB41AB1 IE6E1394-DV Input</b>				
<b>IC401</b>				
1	PHY_CLK	1.78	1.71	1.73
2	PHY_CTL0	0.01	0.01	0.01
3	PHY_CTL1	0.01	0.01	0.01
4	PHY_DATA0	0.01	0.01	0.01
5	PHY_DATA1	0.01	0.01	0.01
6	PHY_DATA2	0.01	0.01	0.01
7	PHY_DATA3	0.01	0.01	0.01
8	PHY_DATA4	0.01	0.01	0.01
9	PHY_DATA5	0.01	0.01	0.01
10	PHY_DATA6	0.01	0.01	0.01
11	PHY_DATA7	0.01	0.01	0.01
12	1394_PD	0.01	0.01	0.01
13	PHY_LPS	3.26	3.26	3.26
14	GND	0.01	0.01	
15	PHY_LINKON	0.01	0.01	0.01
16	PC0	0.01	0.01	0.01
17	PC1	0.00	0.01	0.01
18	PC2	0.01	0.01	0.01
19	ISO	3.27	3.27	3.27
20	CPS	3.15	3.15	3.15
21	DVDD21	3.27	3.27	3.27
22	TESTM	3.27	3.27	3.27
23	SE	0.01	0.01	0.01
24	SM	0.01	0.01	0.01
25	AVDD25	3.27	3.27	3.27
26	GND	0.00	0.00	0.00
27	TPB-	1.77	1.56	1.56
28	TPB+	1.77	1.77	1.77
29	TPA-	1.80	1.84	1.84
30	TPA+	1.77	1.77	1.77
31	TPBIAS	1.82	1.82	1.82
32	AGND32	0.00	0.00	0.00
33	RO	0.00	0.10	0.01
34	RI	1.21	1.21	1.21
35	AVDD35	3.27	3.27	3.27
36	GND	0.00	0.00	0.00
37	/RST_PHY	3.26	3.26	3.26
38	FILTER0	0.01	0.01	0.01
39	FILTER1	1.28	1.29	1.29
40	PLLVD	3.28	3.27	3.27
41	PLLGND	0.00	0.00	0.01
42	XI	1.50	1.50	1.50

NO	PIN NAME	EE MODE	PB MODE	REC MODE
43	XO	1.50	1.50	1.50
44	DVDD44	3.28	3.28	3.27
45	DVDD45	3.28	3.27	3.27
46	GND	0.00	0.00	0.01
47	GND	0.00	0.00	0.01
48	PHY_LREQ	0.01	0.01	0.01
<b>IC1201 39FV6402B SST 8MB FLASH MEMORY</b>				
<b>IC201</b>				
1	HA16	0.09	0.08	0.08
2	HA15	0.09	0.08	0.08
3	HA14	0.09	0.08	0.08
4	HA13	0.09	0.08	0.08
5	HA12	0.09	0.08	0.08
6	HA11	0.09	0.08	0.08
7	HA10	0.09	0.08	0.08
8	HA9	0.09	0.08	0.08
9	HA20	0.09	0.08	0.08
10	HA21	0.09	0.08	0.08
11	/E5_LWEn	3.27	3.26	3.26
12	/RST_FLASH	3.25	3.23	3.23
13	HA22	0.02	0.00	0.00
14	HA19	3.25	3.23	3.23
15	HA18	(0.02)	0.00	0.00
16	HA8	(0.02)	0.08	0.08
17	HA18	0.10	0.08	0.08
18	HA8	0.10	3.28	0.08
19	HA7	0.10	0.08	0.08
20	HA6	0.10	0.08	0.08
21	HA5	3.27	3.26	3.26
22	HA4	3.27	3.26	3.26
23	HA3	3.27	3.26	3.26
24	HA2	3.27	3.26	3.26
25	HA1	3.27	3.26	3.26
26	/E5_CS0	3.27	3.26	3.26
27	VSS	0.02	0.00	0.00
28	/E5_OE	3.27	3.26	3.26
29	HD0	0.02	0.01	0.00
30	HD8	0.02	0.00	0.01
31	HD1	0.02	0.01	0.00
32	HD9	0.02	0.01	0.01
33	HD2	0.02	0.01	0.01
34	HD10	0.02	0.01	0.01
35	HD3	0.02	0.01	0.01
36	HD11	0.02	0.01	0.01

NO	PIN NAME	EE MODE	PB MODE	REC MODE
37	VCC	3.28	3.28	3.28
38	HD4	0.02	0.01	0.01
39	HD12	0.02	0.01	0.01
40	HD5	0.02	0.01	0.01
41	HD13	0.02	0.00	0.00
42	HD6	0.02	0.01	0.01
43	HD14	0.02	0.01	0.01
44	HD7	0.02	0.01	0.01
45	HD15	0.02	0.01	0.01
46	VSS	0.02	0.01	0.01
47	V33_STB	3.28	3.28	3.28
48	HA17	0.20	0.08	0.08
<b>IC1202 K4H5116380-UCCC DDR SDRAM</b>				
<b>IC202</b>				
1	VDD	2.43	2.43	2.41
2	SDRAM_DQ0	1.11	1.06	1.11
3	VDDQ	2.43	2.43	2.41
4	SDRAM_DQ1	1.13	1.08	1.12
5	SDRAM_DQ2	1.10	1.04	1.09
6	VSSQ	0.00	0.00	0.00
7	SDRAM_DQ3	1.12	1.08	1.15
8	SDRAM_DQ4	1.12	1.09	1.12
9	VDDQ	2.43	2.41	2.41
10	SDRAM_DQ5	1.09	1.20	1.00
11	SDRAM_DQ6	1.09	1.20	1.06
12	VSSQ	0.00	0.00	0.00
13	SDRAM_DQ7	1.05	1.20	0.98
14	NC	0.00	0.00	0.00
15	VDDQ	2.43	2.46	2.41
16	SDRAM_DQS0	1.20	1.23	1.19
17	SDRAM_A13	1.10	1.22	1.08
18	VDD	2.43	2.46	2.41
19	NC	0.00	0.00	0.00
20	SDRAM_DQM0	0.45	0.56	0.56
21	SDRAM_WE#	1.22	1.88	1.79
22	SDRAM_CAS#	1.74	1.85	1.66
23	SDRAM_RAS#	1.79	1.87	1.77
24	/CS	0.00	0.00	0.00
25	NC	0.00	0.00	0.00
26	SDRAM_BA0	1.22	1.24	1.20
27	SDRAM_BA1	1.22	1.24	1.21
28	SDRAM_A10	1.12	1.22	1.11
29	SDRAM_A0	1.13	1.22	1.11
30	SDRAM_A1	1.14	1.22	1.11

NO	PIN NAME	EE MODE	PB MODE	REC MODE
31	SDRAM_A2	1.14	1.22	1.12
32	SDRAM_A3	1.15	1.23	1.19
33	VDD	2.43	2.47	2.42
34	VSS	0.00	0.01	0.01
35	SDRAM_A4	1.20	1.23	1.19
36	SDRAM_A5	1.20	1.23	1.19
37	SDRAM_A6	1.21	1.23	1.19
38	SDRAM_A7	1.22	1.23	1.20
39	SDRAM_A8	1.21	1.23	1.19
40	SDRAM_A9	1.20	1.23	1.20
41	SDRAM_A11	1.14	1.22	1.10
42	SDRAM_A12	1.13	1.22	1.10
43	NC	0.00	0.00	0.00
44	SDRAM_CLKE	1.85	1.88	1.84
45	SDRAM_CLK1	1.24	1.26	1.23
46	SDRAM_CLK#1	1.14	1.21	1.18
47	SDRAM_DQM1	0.58	0.56	0.56
48	VSS	0.00	0.00	0.00
49	VREF	1.23	1.25	1.22
50	NC	0.00	0.00	0.00
51	SDRAM_DQS1	1.20	1.23	1.19
52	VSSQ	0.00	0.00	0.00
53	NC	0.00	0.01	0.00
54	SDRAM_DQ8	1.13	1.19	1.12
55	VDDQ	2.43	2.47	2.42
56	SDRAM_DQ9	1.13	1.19	1.11
57	SDRAM_DQ10	1.12	1.17	1.06
58	VSSQ	0.00	0.00	0.00
59	SDRAM_DQ11	1.11	1.19	1.17
60	SDRAM_DQ12	1.15	1.20	1.11
61	VDDQ	2.43	2.47	2.41
62	SDRAM_DQ13	1.07	1.20	1.07
63	SDRAM_DQ14	1.09	1.20	1.06
64	VSSQ	0.00	0.00	0.01
65	SDRAM_DQ15	1.07	1.21	1.03
66	VSS	0.00	0.00	0.00
<b>IC1204 G2995</b>				
<b>IC204</b>				
1	NC	0.00	0.00	0.00
2	GND	0.00	0.00	0.00
3	VSENSE	1.20	1.24	1.20
4	VREF	1.22	1.25	1.22
5	VDDQ	2.41	2.46	2.42
6	AVIN	2.40	2.46	2.41

NO	PIN NAME	EE MODE	PB MODE	REC MODE
7	PVIN	2.40	2.47	2.42
8	VTT	1.20	1.24	1.20
<b>IC1301 74LVT16373ADGG</b>				
<b>IC1301</b>				
1	GND	0.03	0.03	0.03
2	HA6	0.09	0.09	0.09
3	HA7	0.09	0.09	0.09
4	GND	0.03	0.03	0.03
5	HA8	0.09	3.27	0.09
6	HA9	0.09	0.09	0.09
7	V33_STB	3.28	3.28	3.28
8	HA10	0.09	0.09	0.09
9	HA11	0.09	0.09	0.09
10	GND	0.03	0.03	0.03
11	HA12	0.09	0.09	0.09
12	HA13	0.09	0.09	0.09
13	HA14	0.09	0.09	0.09
14	HA15	0.09	0.09	0.09
15	GND	0.03	0.03	0.03
16	HA16	0.09	0.09	0.09
17	HA17	0.09	0.09	0.09
18	V33_STB	3.28	3.28	3.28
19	HA18	0.09	0.09	0.09
20	HA19	0.09	0.09	0.09
21	GND	0.03	0.03	0.03
22	HA20	0.09	0.09	0.09
23	HA21	0.09	0.09	0.09
24	GND	0.03	0.00	0.00
25	E5_ALE	0.03	0.03	0.03
26	HD15	0.03	0.03	0.03
27	HD14	0.03	0.03	0.03
28	GND	0.03	0.03	0.03
29	HD13	0.03	0.03	0.03
30	HD12	0.03	0.03	0.03
31	V33_STB	3.28	3.28	3.28
32	HD11	0.03	0.03	0.03
33	HD10	0.03	0.03	0.03
34	GND	0.03	0.03	0.03
35	HD9	0.03	0.03	0.03
36	HD8	0.03	0.03	0.03
37	HD7	0.03	0.03	0.03
38	HD6	0.03	0.03	0.03
39	GND	0.03	0.03	0.03
40	HD5	0.03	0.03	0.03

NO	PIN NAME	EE MODE	PB MODE	REC MODE
41	HD4	0.03	0.03	0.03
42	V33_STB	3.28	3.28	3.28
43	HD3	0.03	2.97	2.97
44	HD2	0.03	0.03	0.03
45	GND	0.		



# PRINTED CIRCUIT BOARD DIAGRAMS

## 1. MAIN P.C.BOARD

(TOP VIEW)

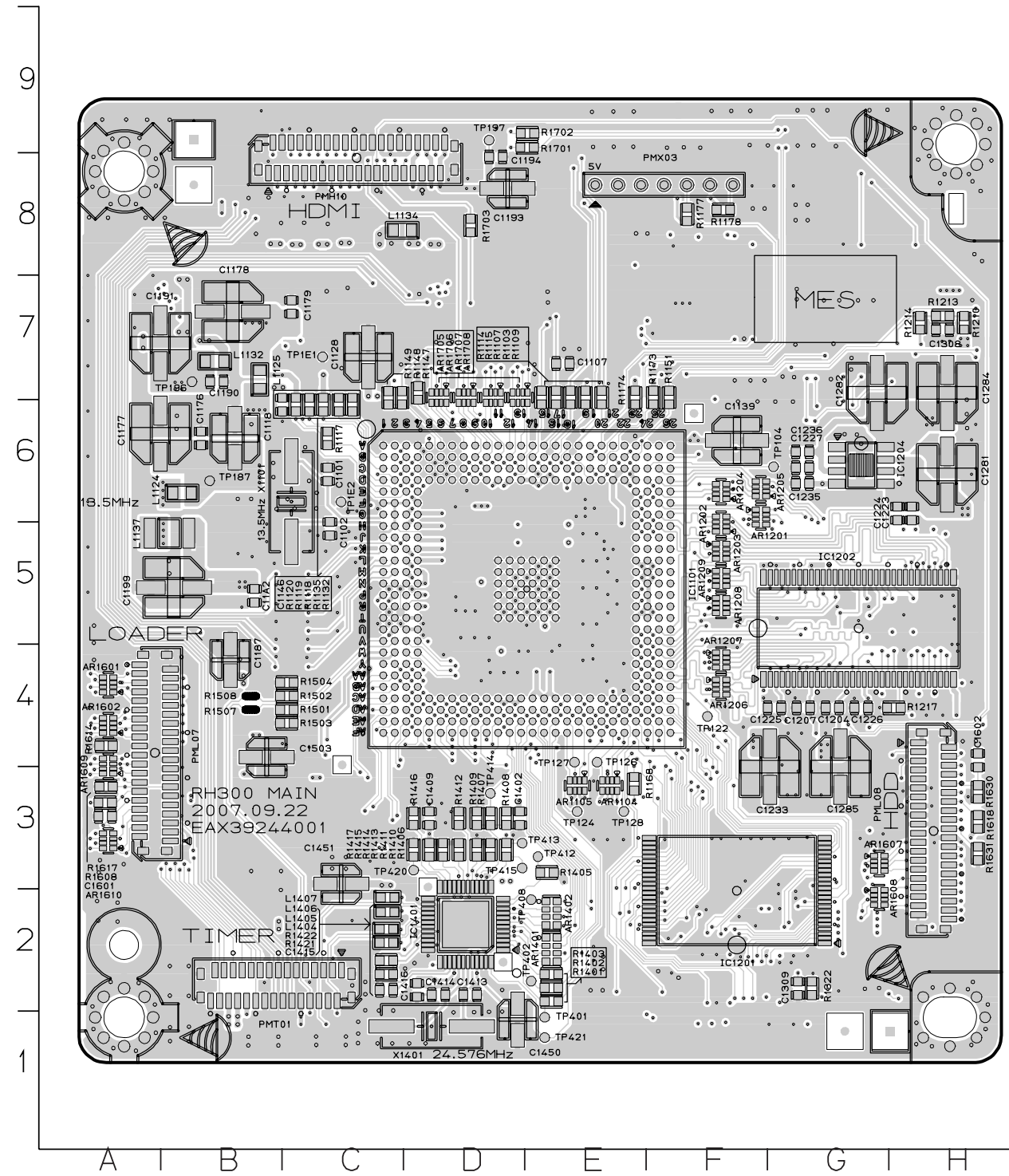

(BOTTOM VIEW)

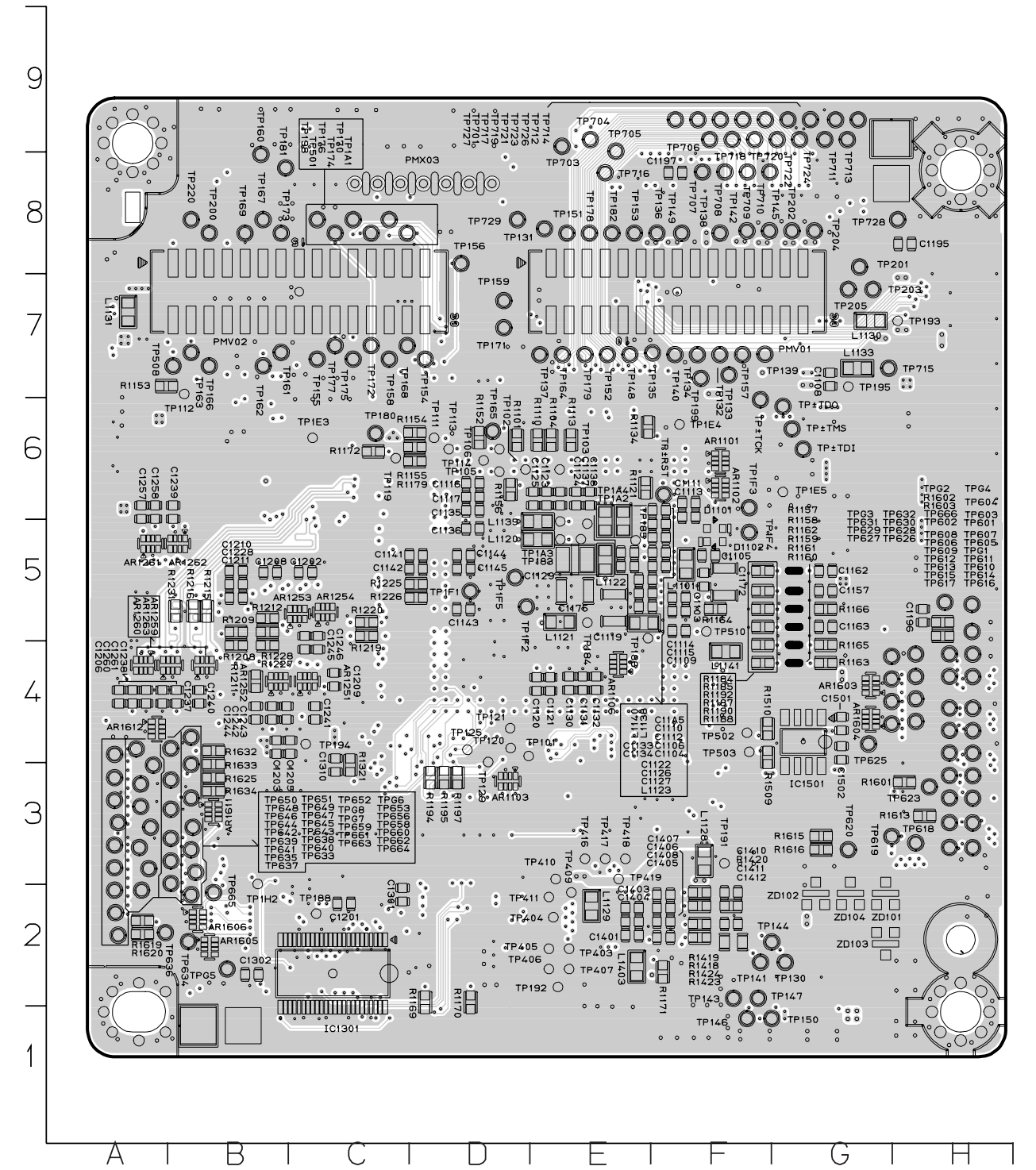

**2. I/O P.C.BOARD  
(TOP VIEW)**

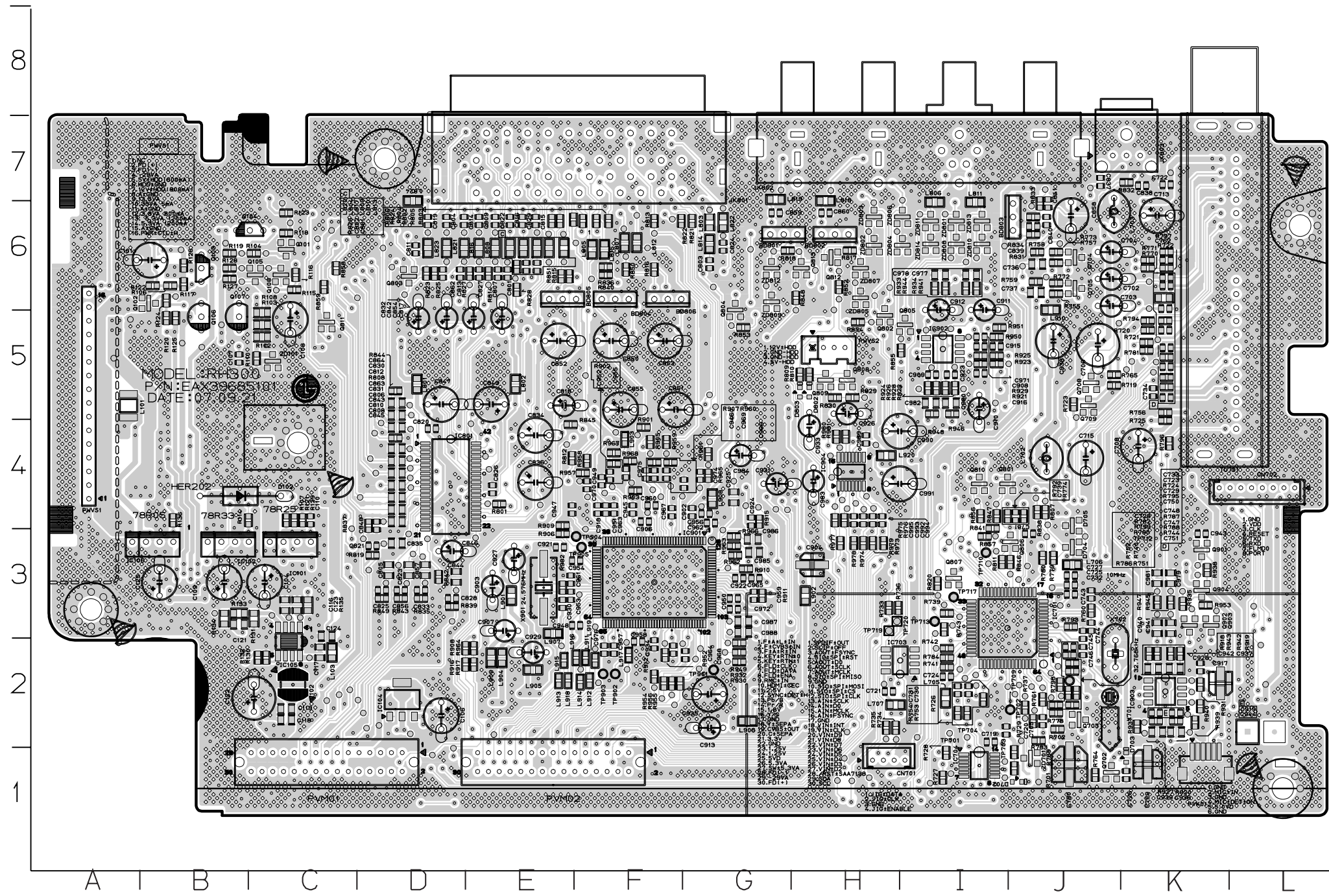

**2. I/O P.C.BOARD  
(BOTTOM VIEW)**

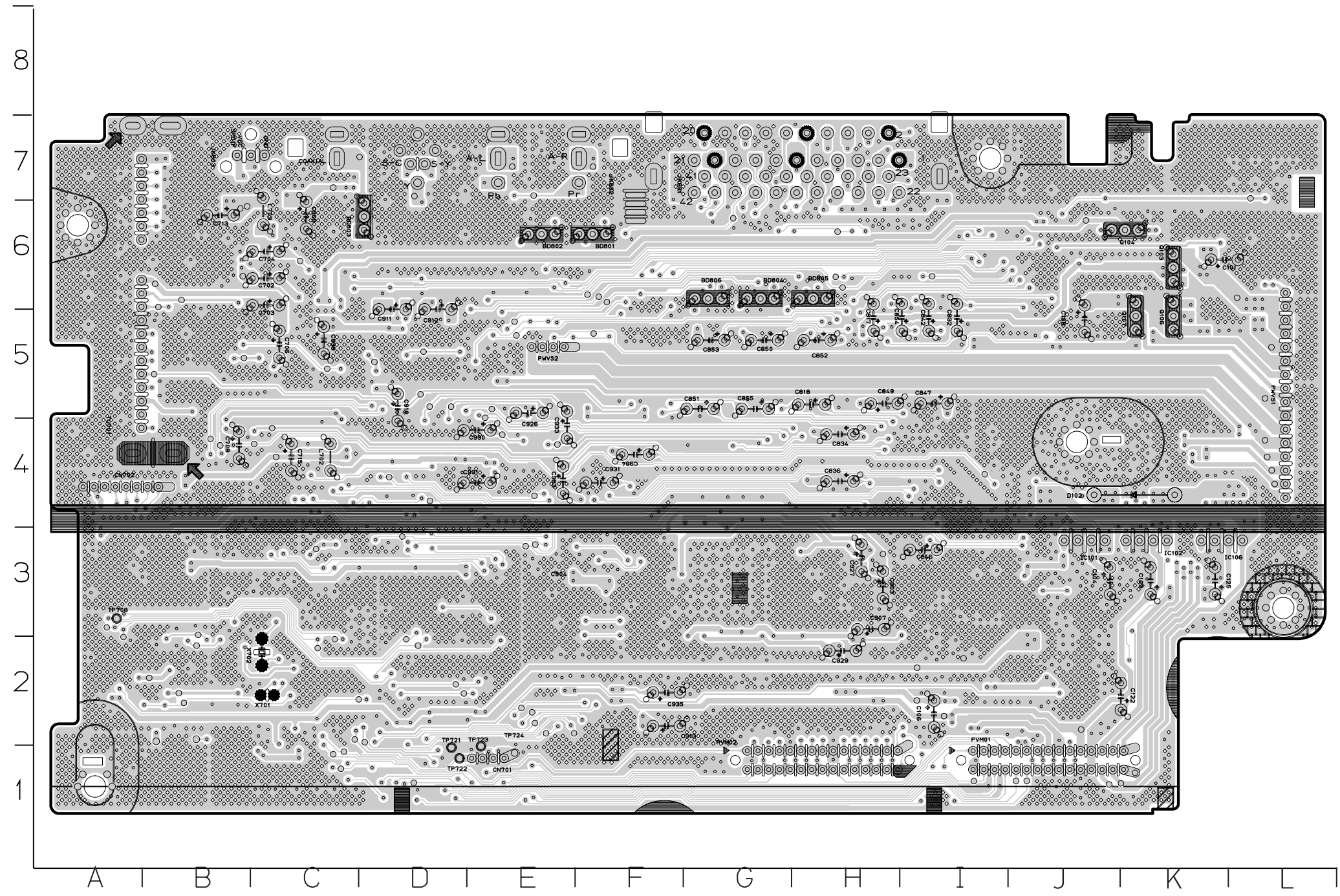

### 3. POWER P.C.BOARD (TOP VIEW)

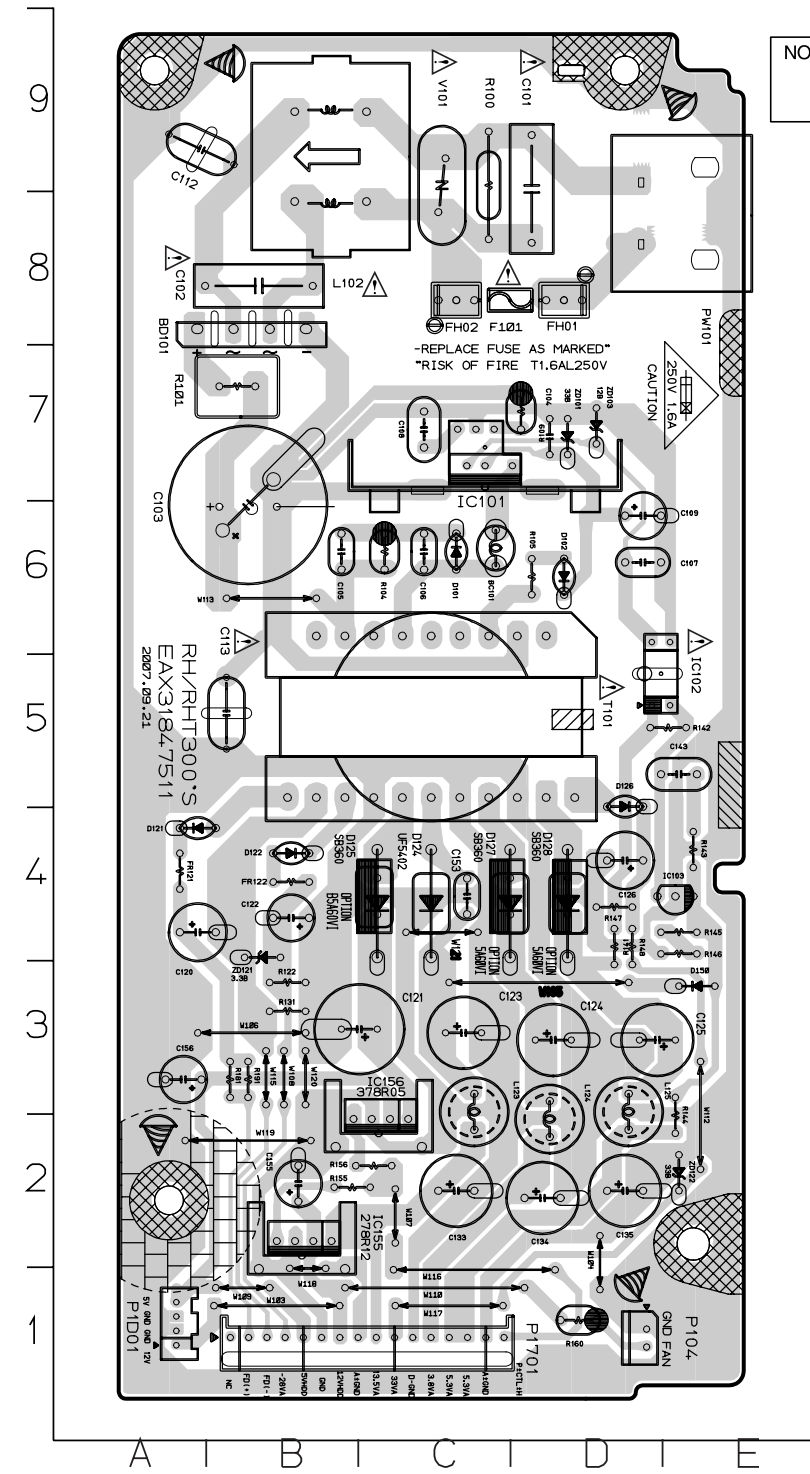

### (BOTTOM VIEW)

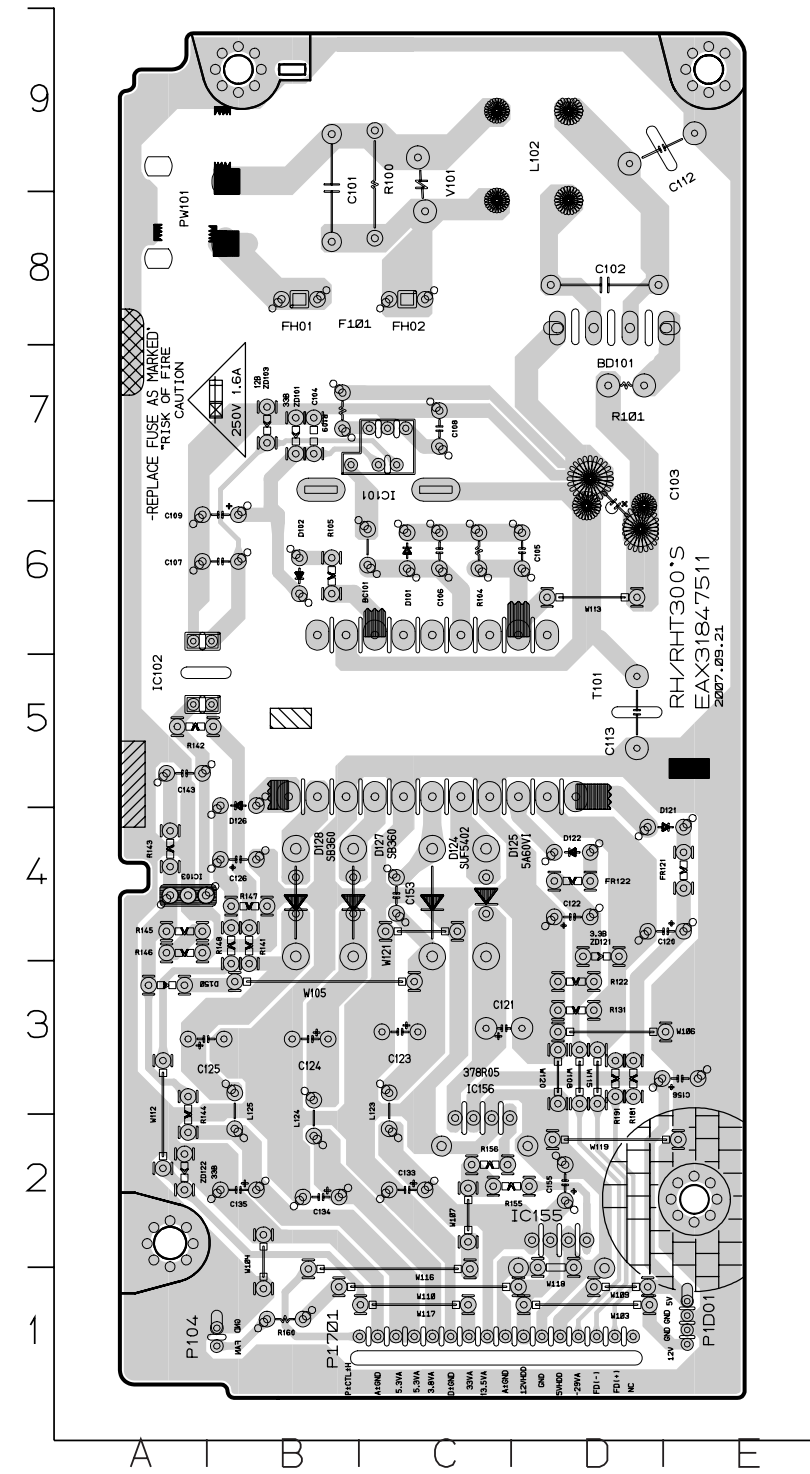

#### 4. TIMER & KEY P.C.BOARD

4-1. 8 TOOL  
(TOP VIEW)

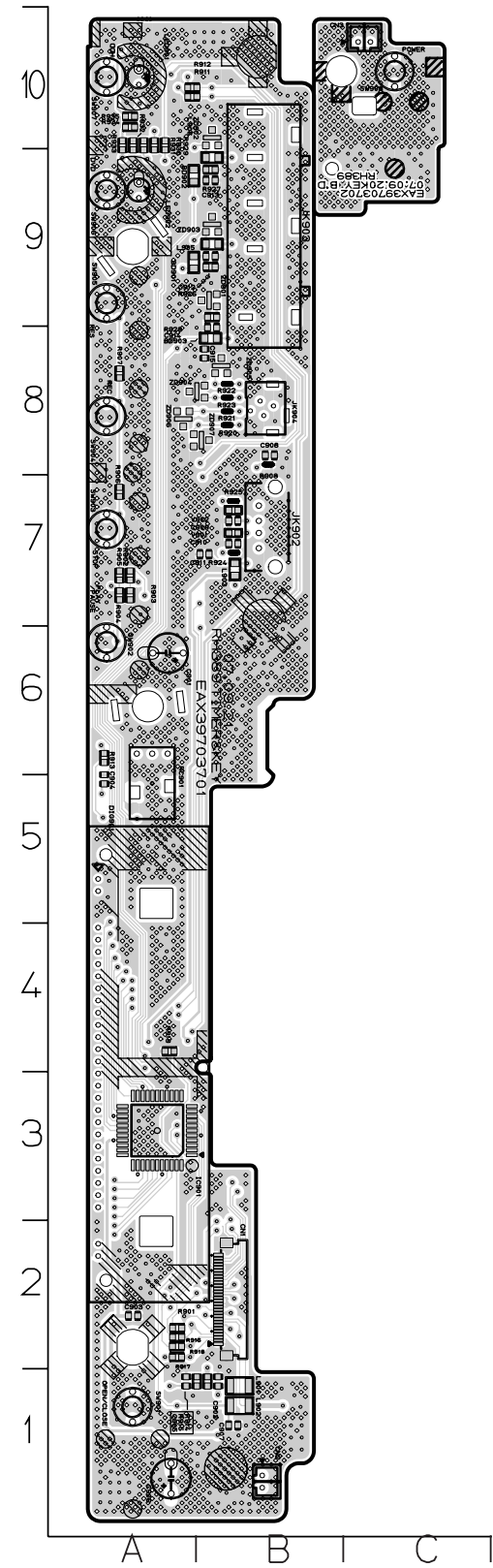

(BOTTOM VIEW)

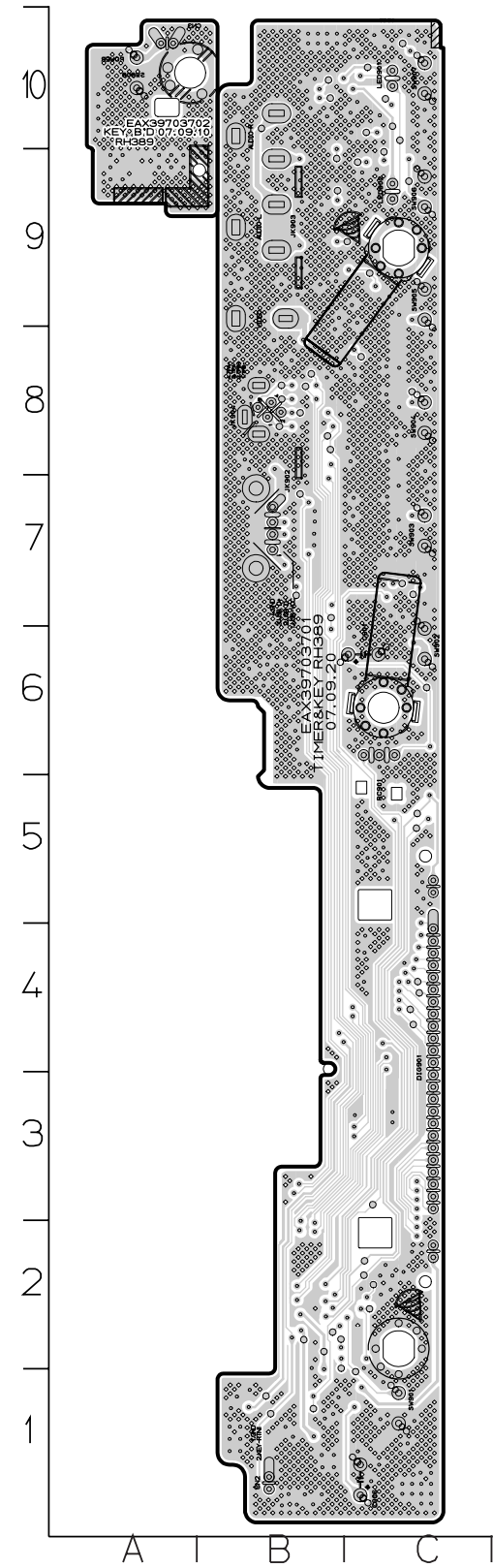

4-2. 9 TOOL  
(TOP VIEW)

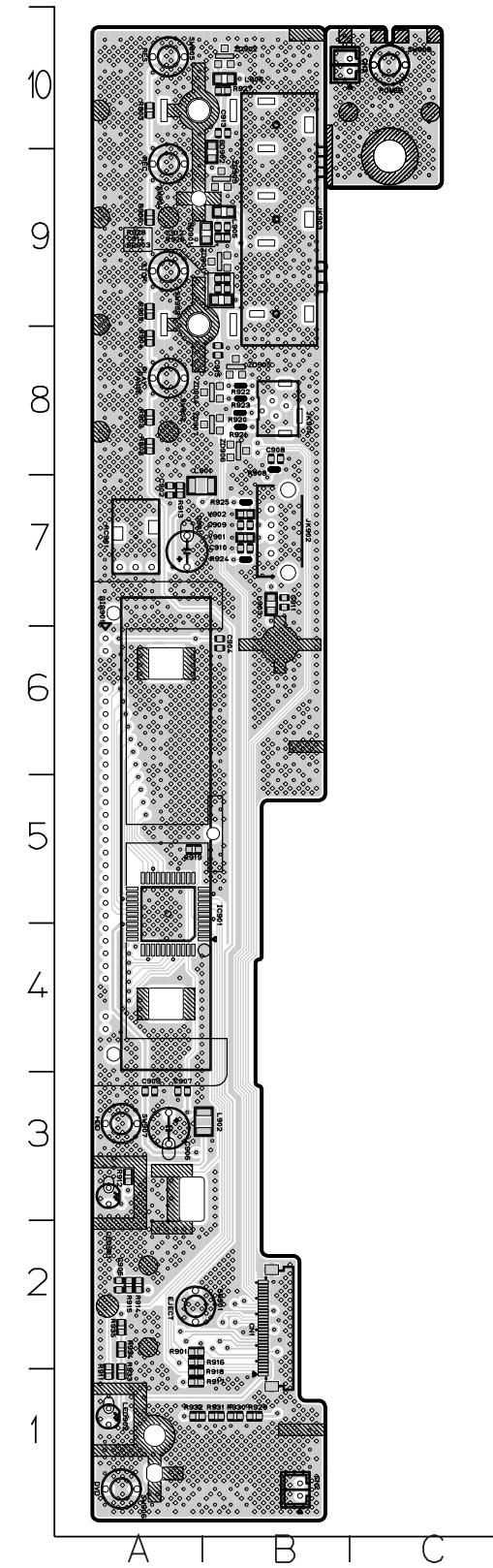

(BOTTOM VIEW)

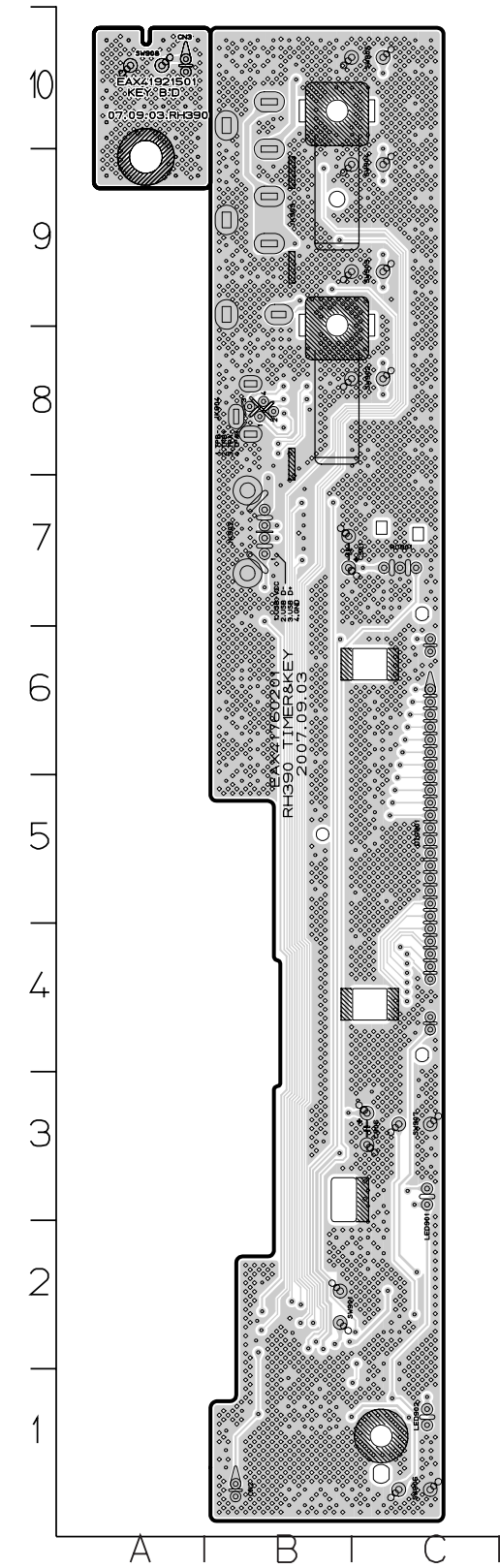

**5. HDMI P.C.BOARD  
(TOP VIEW)**

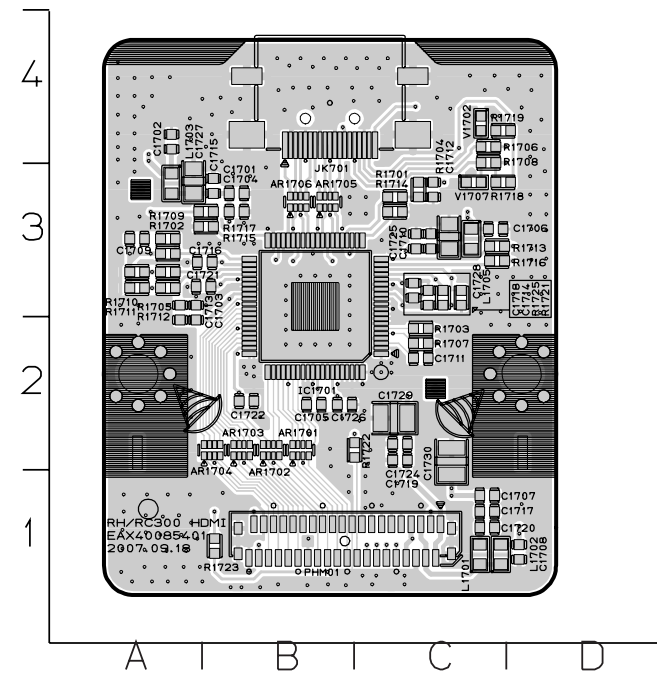

**(BOTTOM VIEW)**

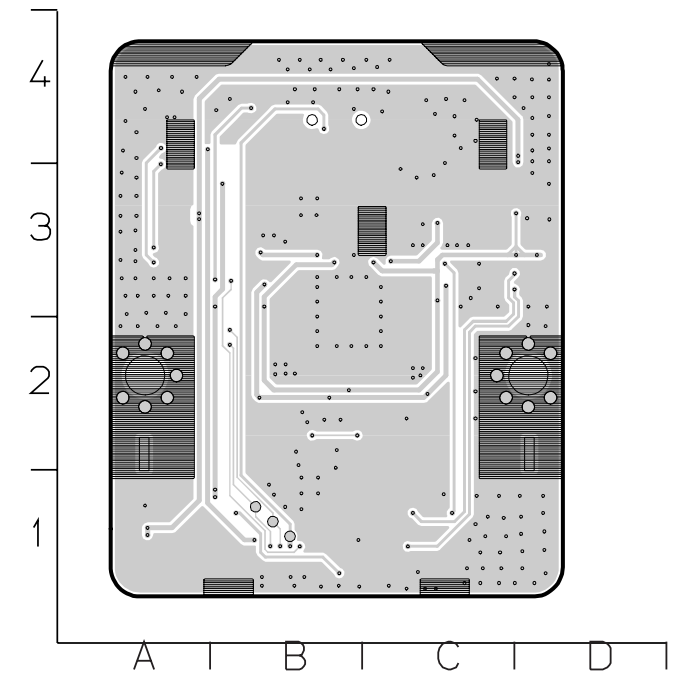

# MEMO

Blank memo form with horizontal dotted lines for writing.

# MEMO

Blank memo form with horizontal dotted lines for writing.

# SECTION 4

## RS-06A LOADER PART

### CONTENTS

<b>ELECTRICAL TROUBLESHOOTING GUIDE</b> .....	4-2
<b>THE DIFFERENCE OF DVD-R/RW, DVD+R/RW DISCS AND DVD-ROM</b> .....	4-16
1. RECORDING LAYER .....	4-16
2. DISC SPECIFICATION .....	4-17
3. DISC MATERIALS .....	4-17
4. ORGANIZATION OF THE INNER DRIVE AREA, OUTER DRIVE AREA, LEAD-IN ZONE AND LEAD-OUT ZONE.....	4-21
<b>OPTICAL POWER SETTING</b> .....	4-24
1. AUTOMATIC OPTICAL POWER SETTING (SET-BASED) .....	4-24
2. MANUAL OPTICAL POWER SETTING .....	4-25
2-1. ALPC MEASUREMENT SYSTEM.....	4-25
2-2. ALPC PROGRAM.....	4-25
2-3. EXECUTE ALPC PROGRAM.....	4-26
2-4. OPTICAL POWER SETTING .....	4-28
2-5. CONFIRM OPTICAL POWER SETTING PARAMETER.....	4-29
2-6. ATTACHMENT. OPTICAL POWER MEASUREMENT .....	4-30
<b>INTERNAL STRUCTURE OF THE PICK-UP</b> .....	4-31
1. BLOCK DIAGRAM OF THE PICK-UP (HOP-7232TL) .....	4-31
2. PICK UP PIN ASSIGNMENT .....	4-32
3. SIGNAL DETECTION OF THE P/U.....	4-33
<b>DESCRIPTION OF CIRCUIT</b> .....	4-34
1. ALPC (AUTOMATIC LASER POWER CONTROL) CIRCUIT .....	4-34
2. FOCUS/TRACKING/SLED SERVO CIRCUIT .....	4-35
3. SPINDLE SERVO CIRCUIT .....	4-36
<b>MAJOR IC INTERNAL BLOCK DIAGRAM AND PIN DESCRIPTION</b> .....	4-37
1. LIC101 (AN22117A) : FEP(RF) ANALOG SIGNAL PROCESSOR .....	4-37
2. LIC201 (MN103SC7G) : ENCODER, DECODER & DSP SINGAL PROCESSOR .....	4-43
3. LIC301 (BD7776ARFS) : CD-ROM/DVD-ROM 7CH POWER DRIVER .....	4-50
<b>BLOCK DIAGRAM</b> .....	4-51
<b>CIRCUIT DIAGRAM</b> .....	4-53
<b>CIRCUIT VOLTAGE CHART</b> .....	4-55
<b>PRINTED CIRCUIT BOARD DIAGRAMS</b> .....	4-57
1. MAIN P.C.BOARD (TOP VIEW).....	4-57
2. MAIN P.C.BOARD (BOTTOM VIEW) .....	4-59



# ELECTRICAL TROUBLESHOOTING GUIDE

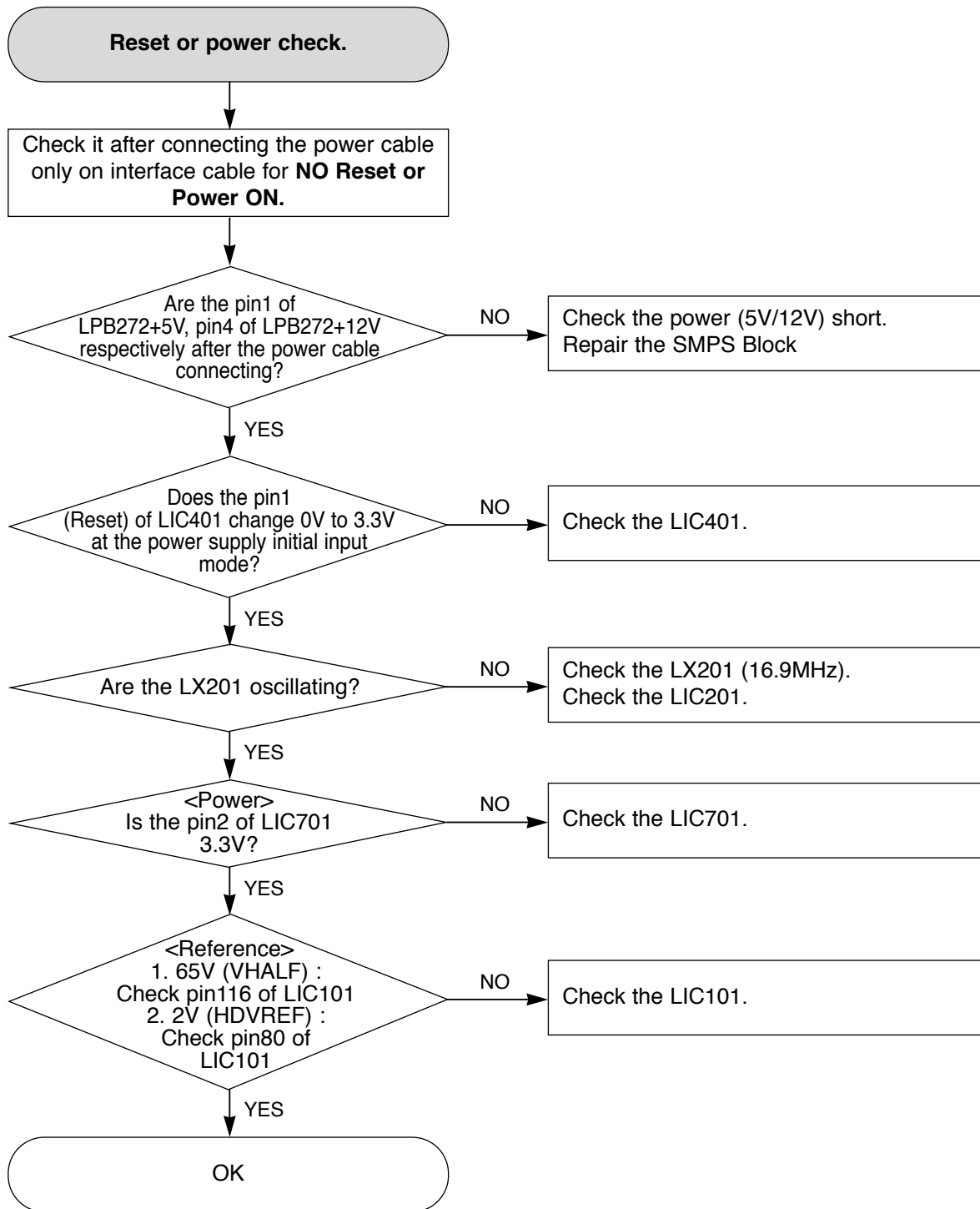

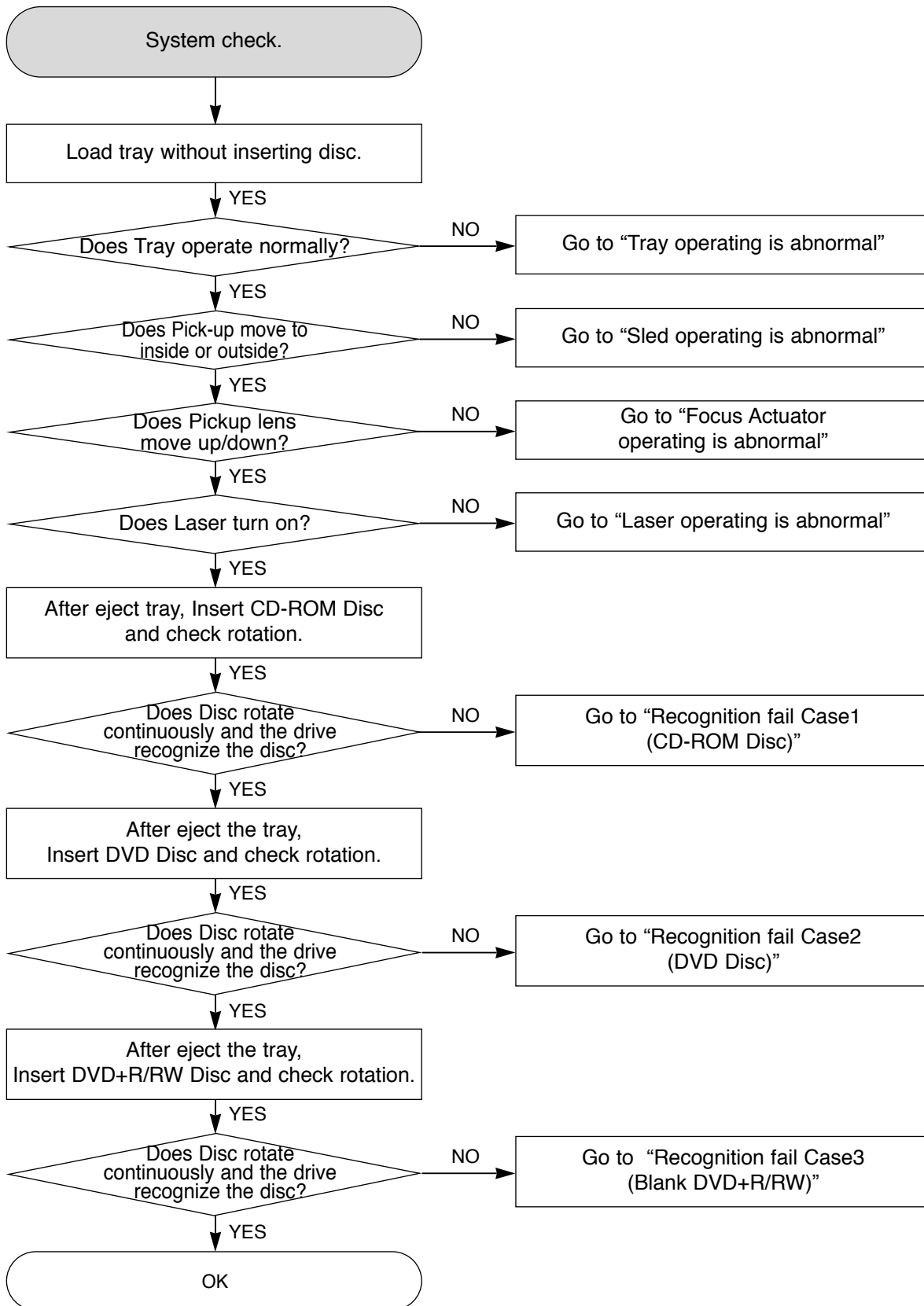

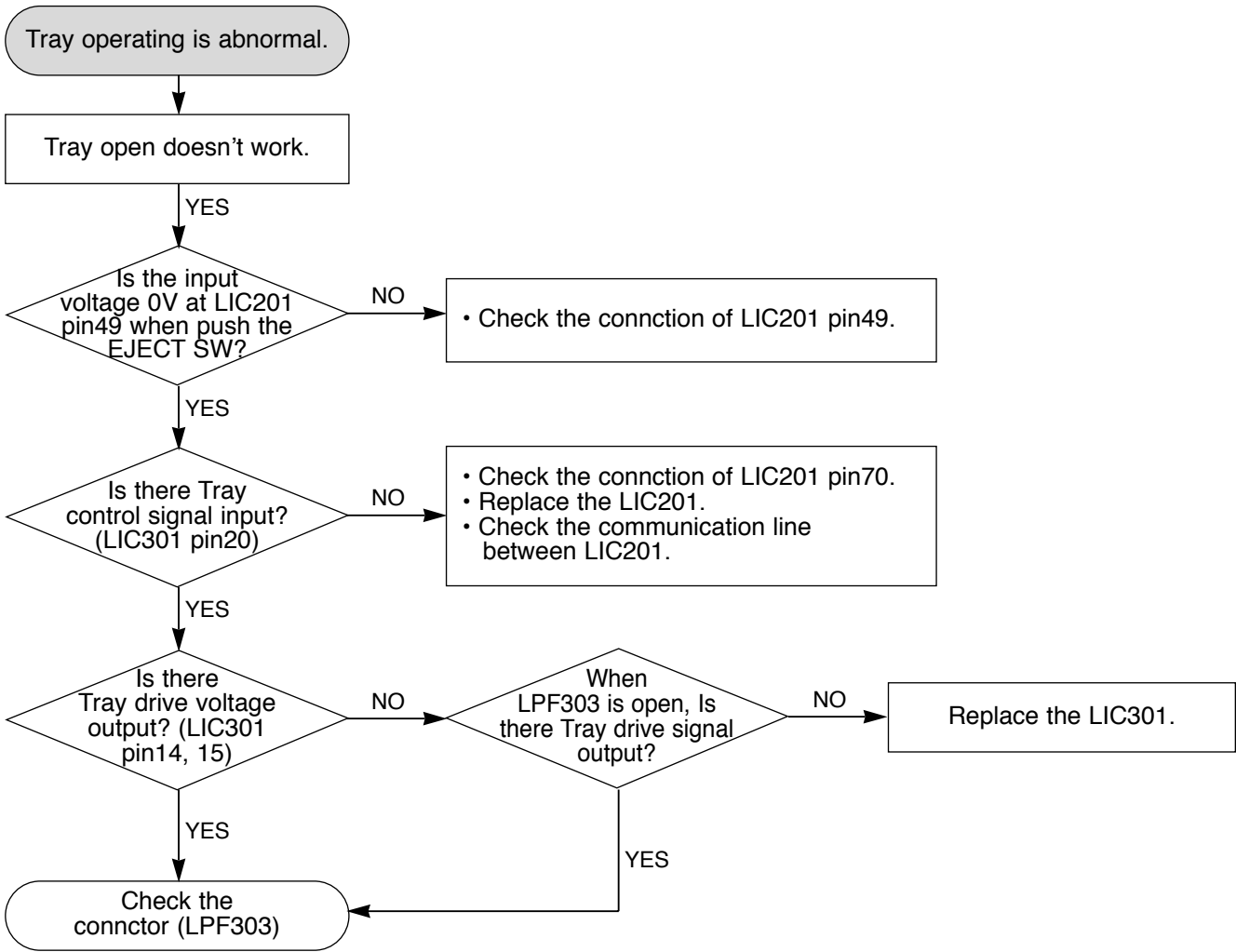

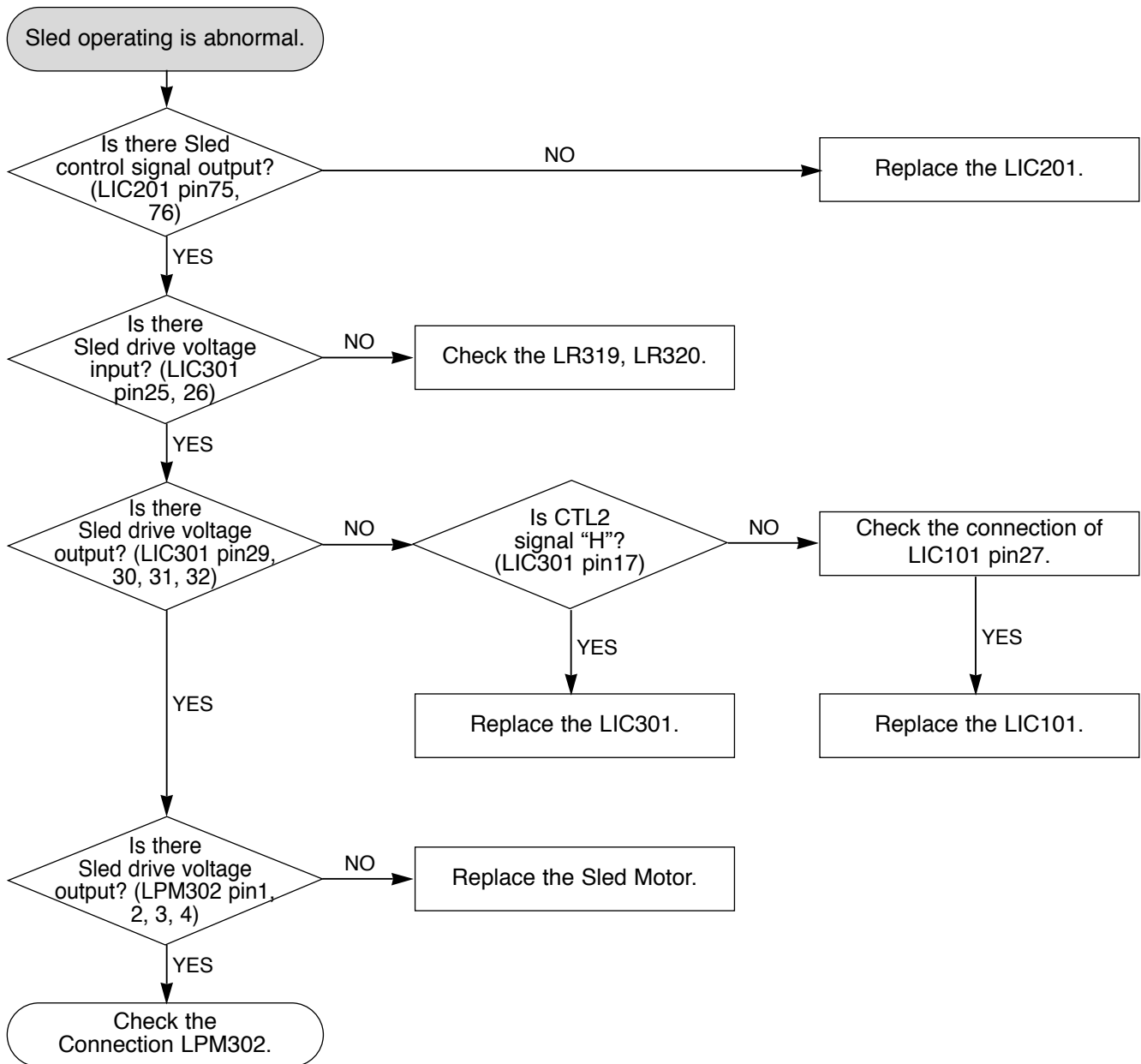

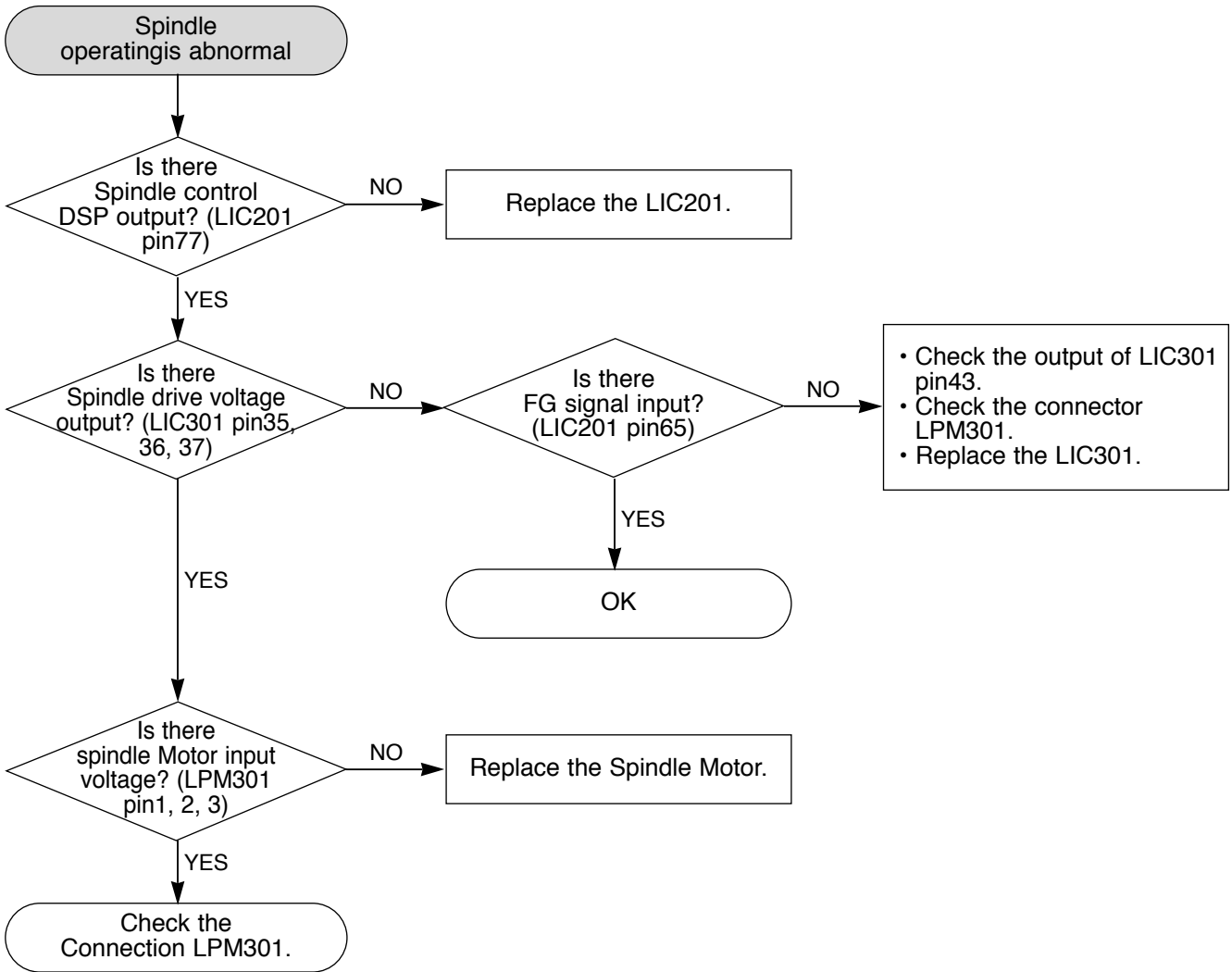

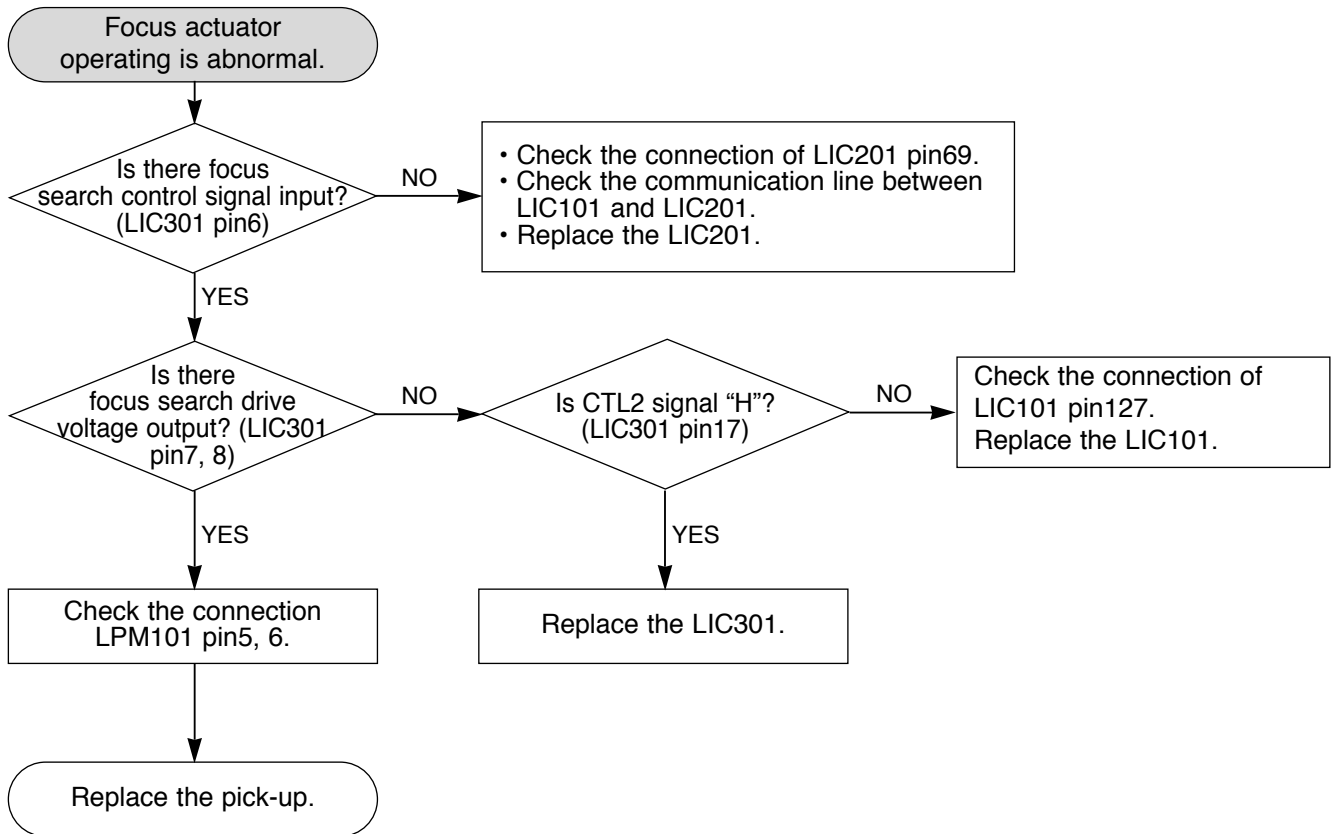
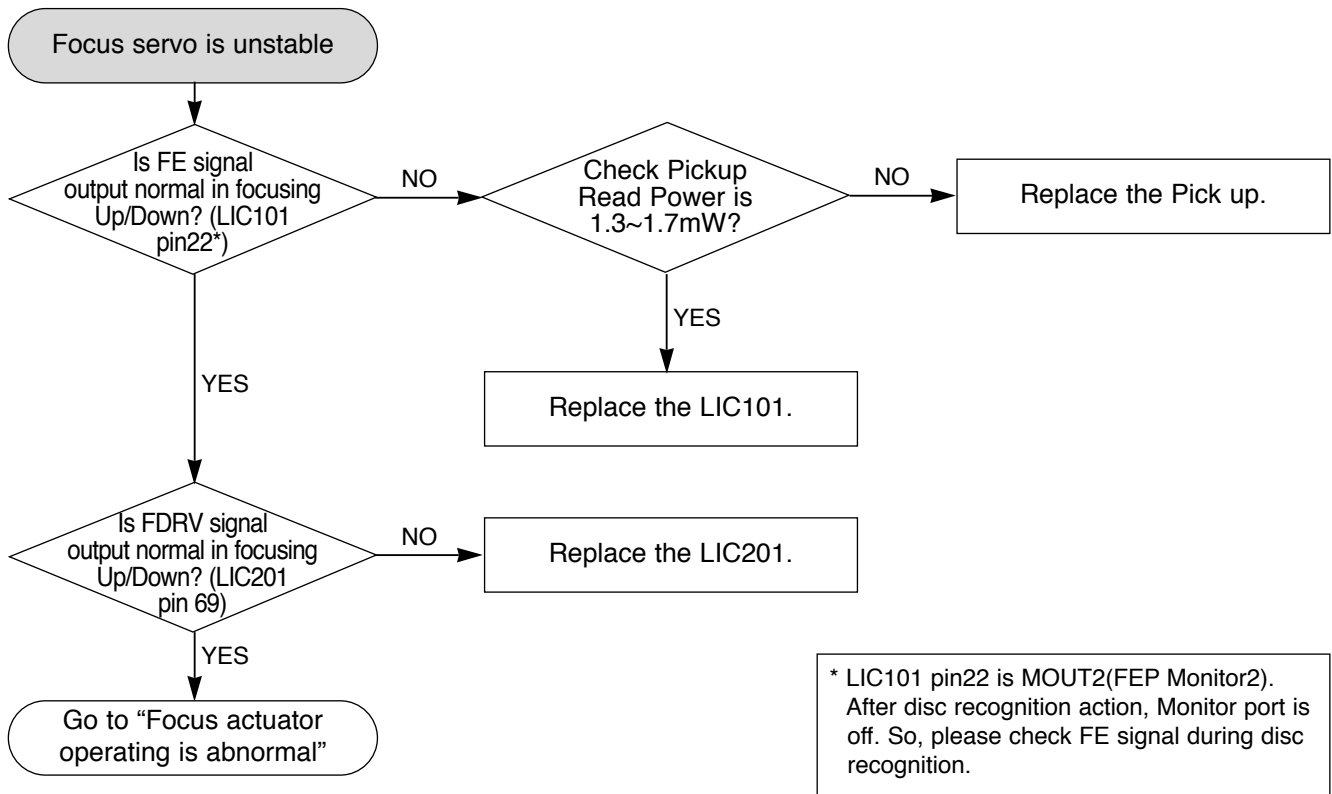

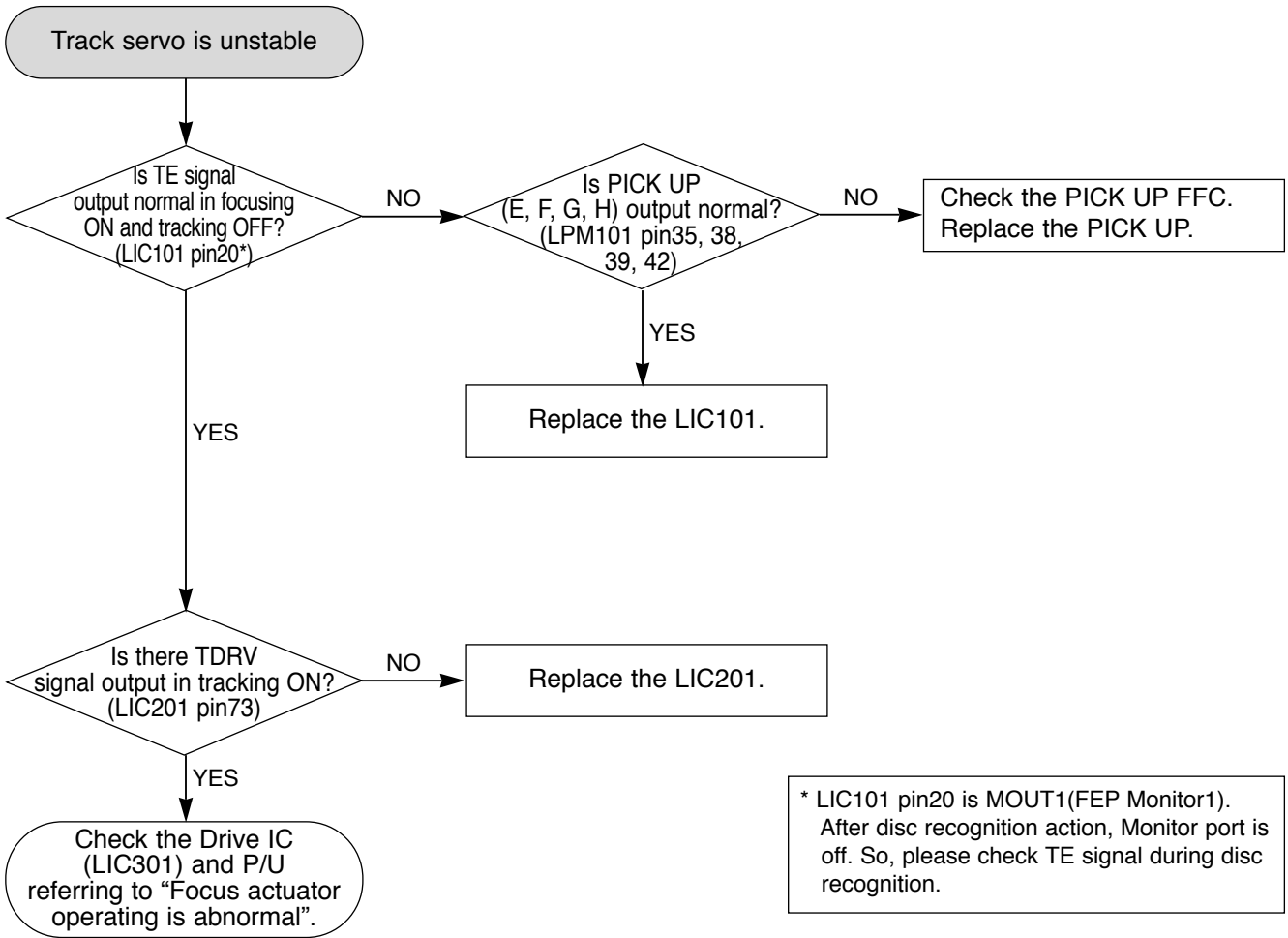

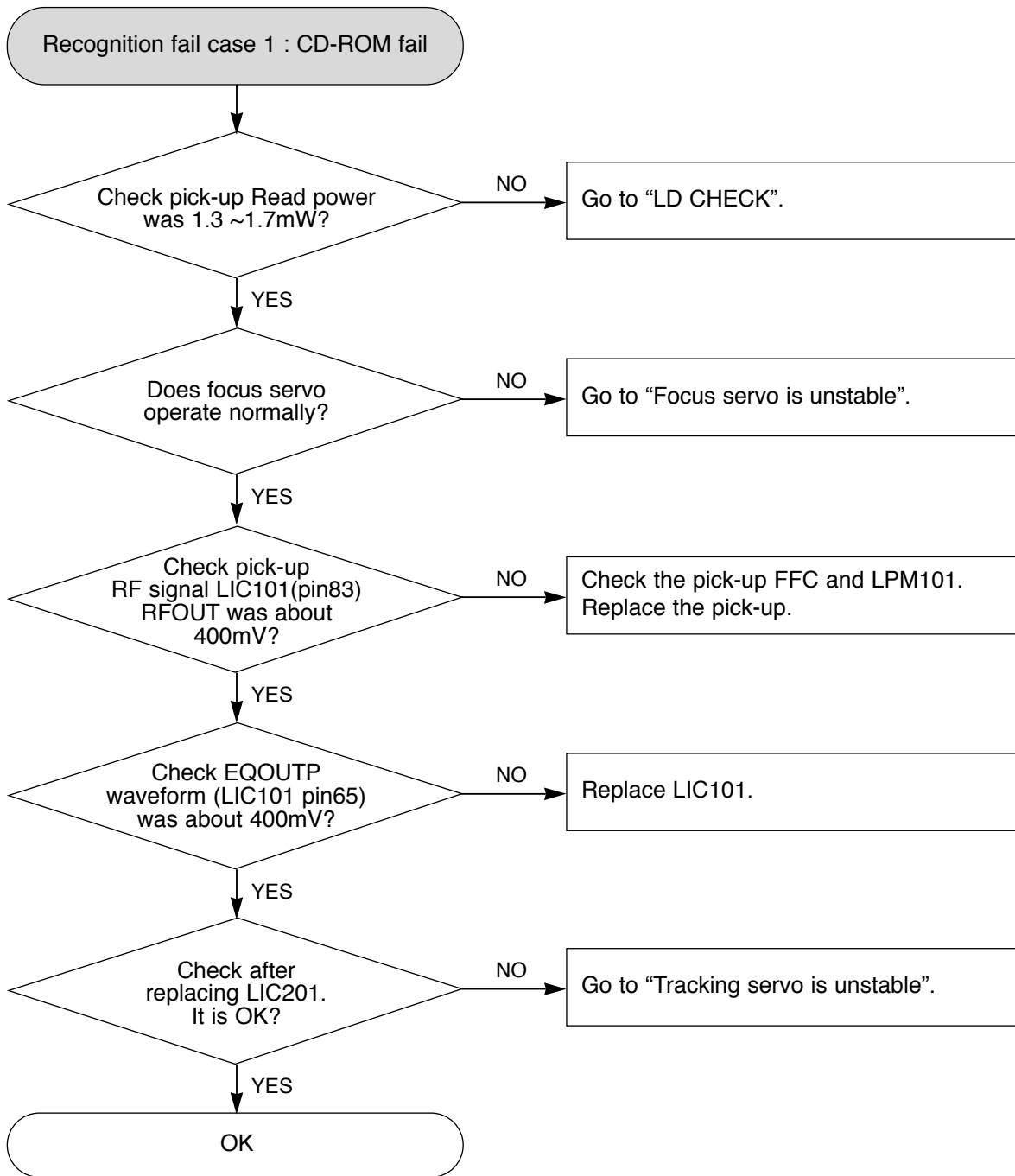



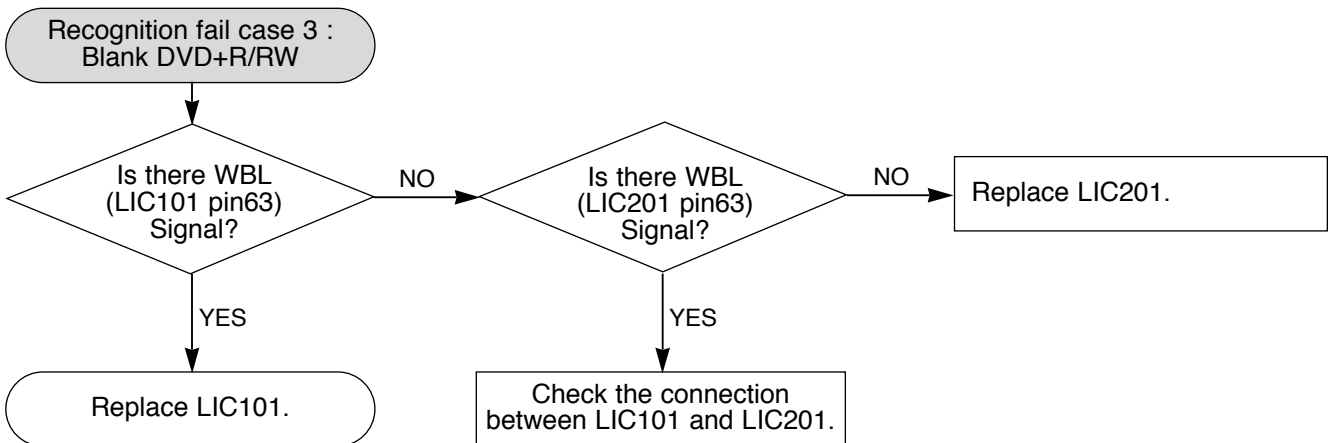
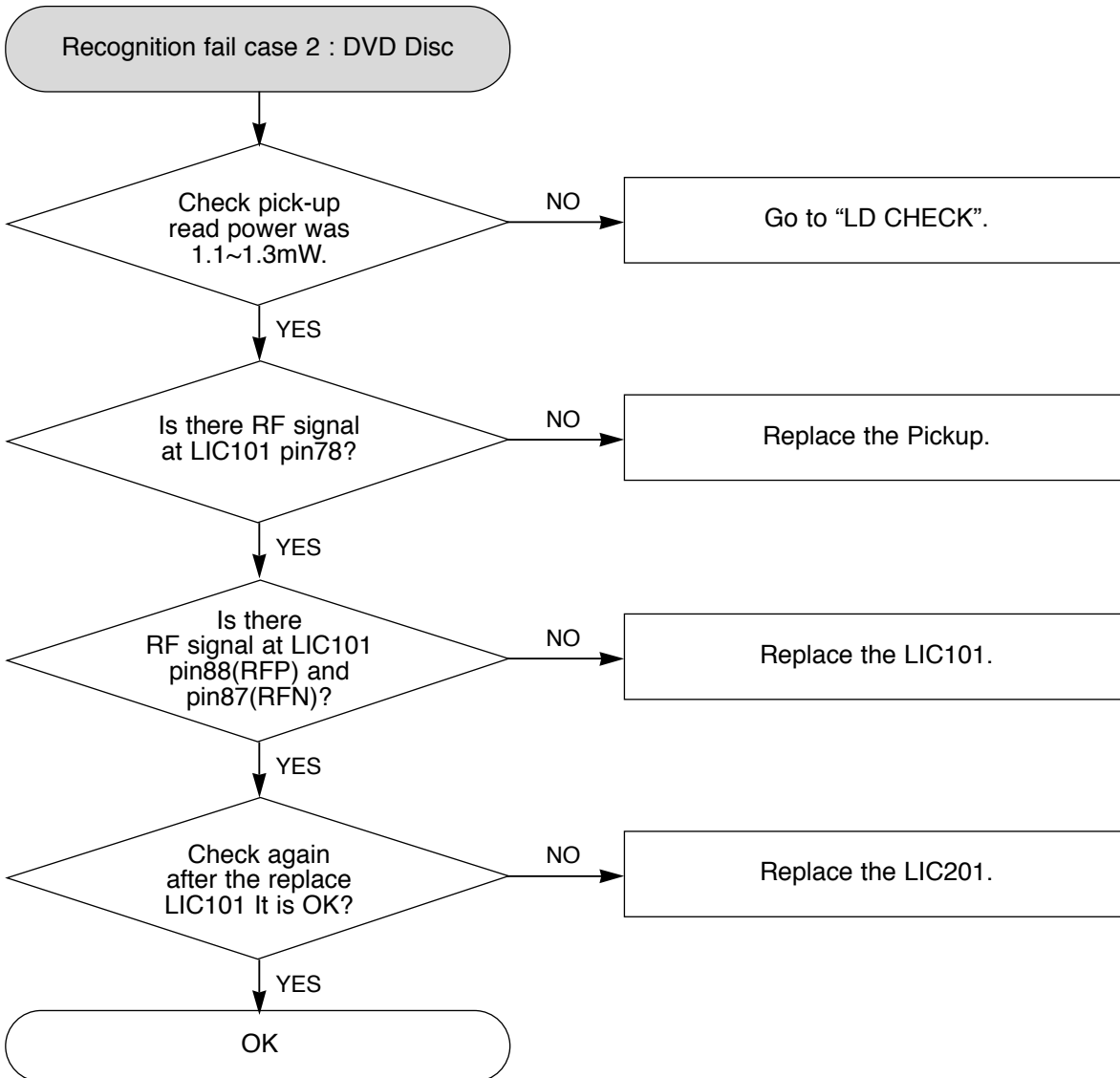

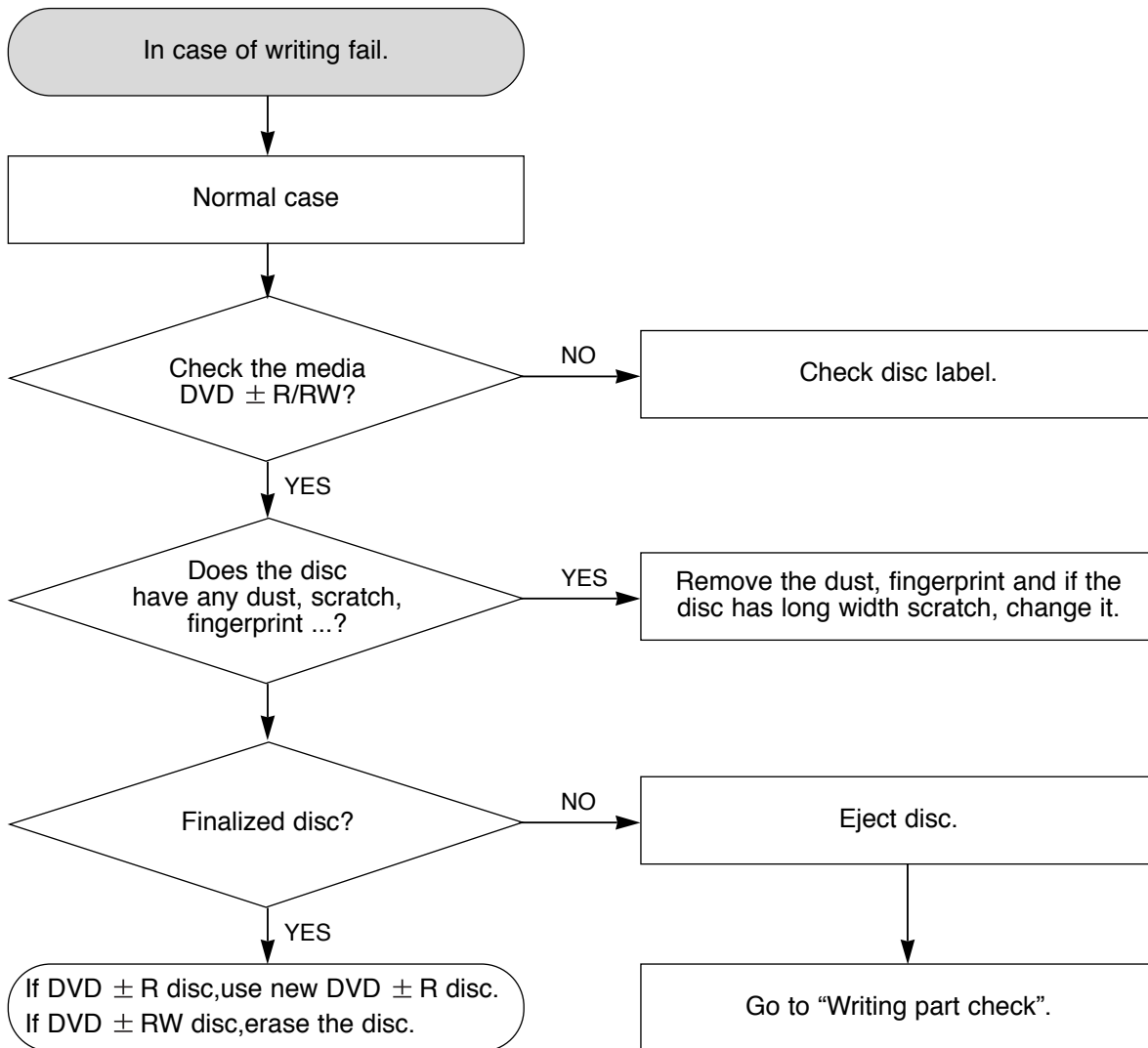

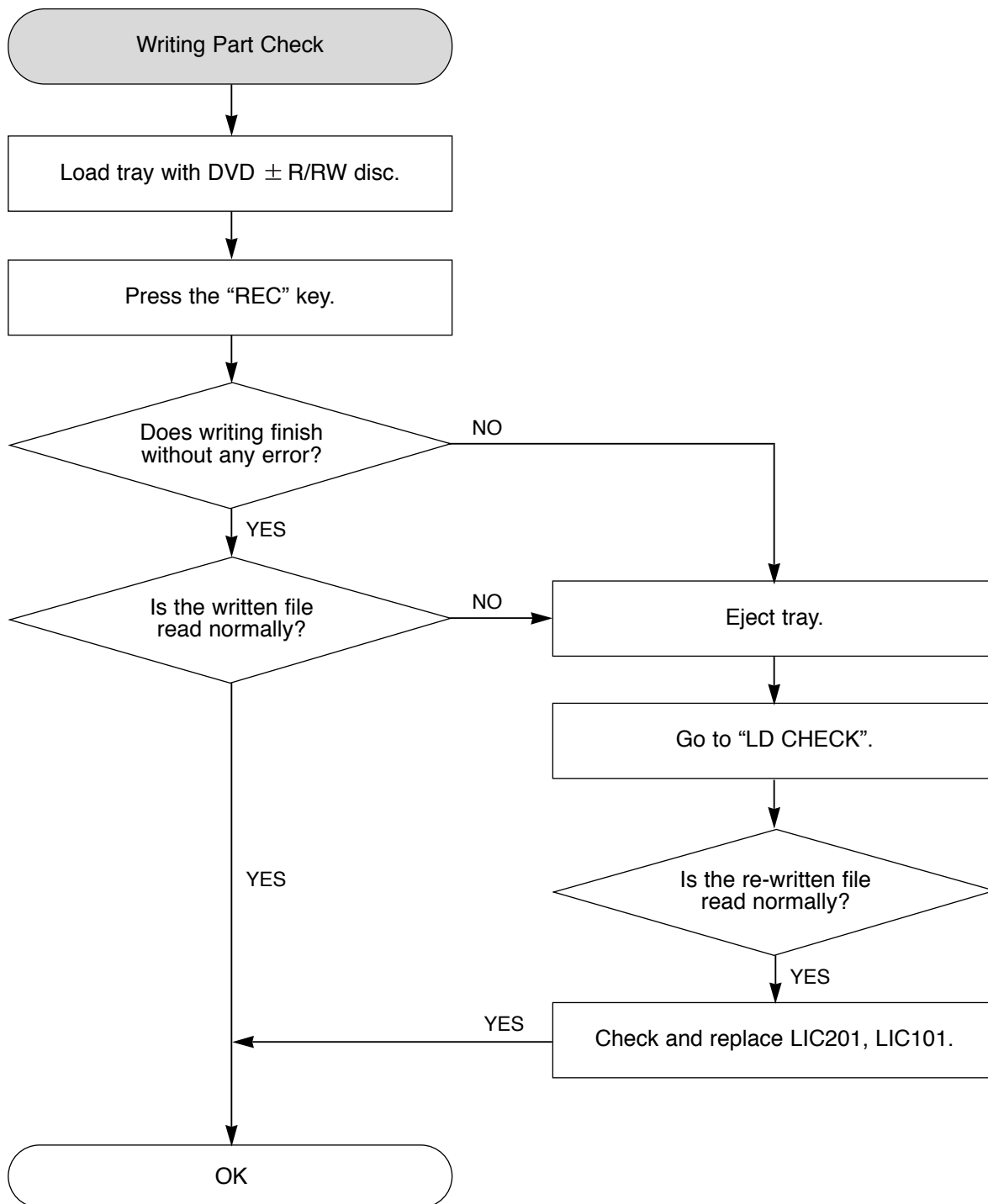

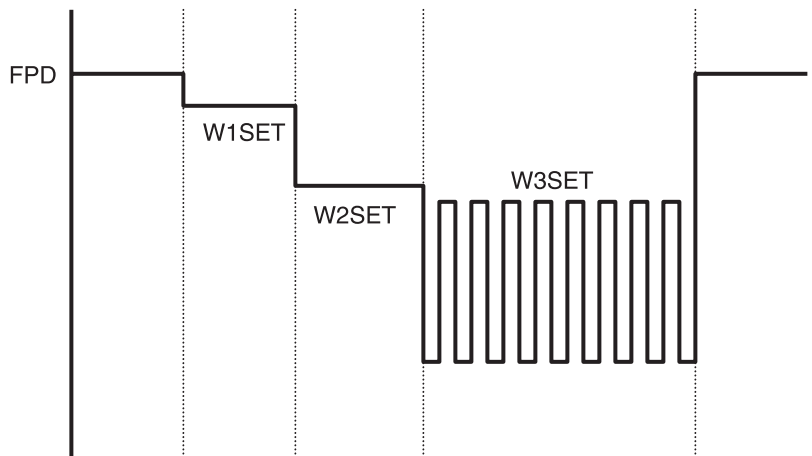
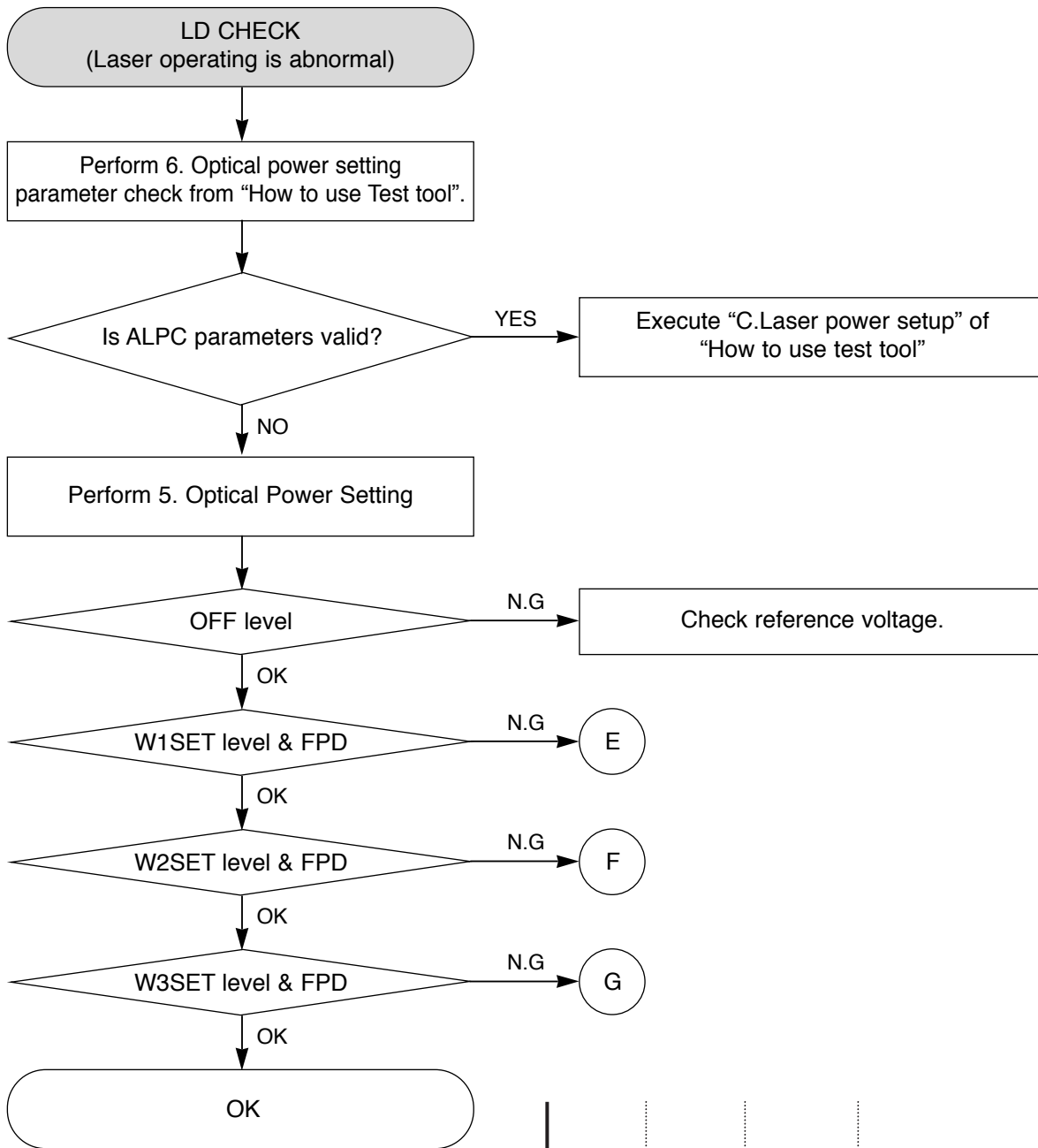

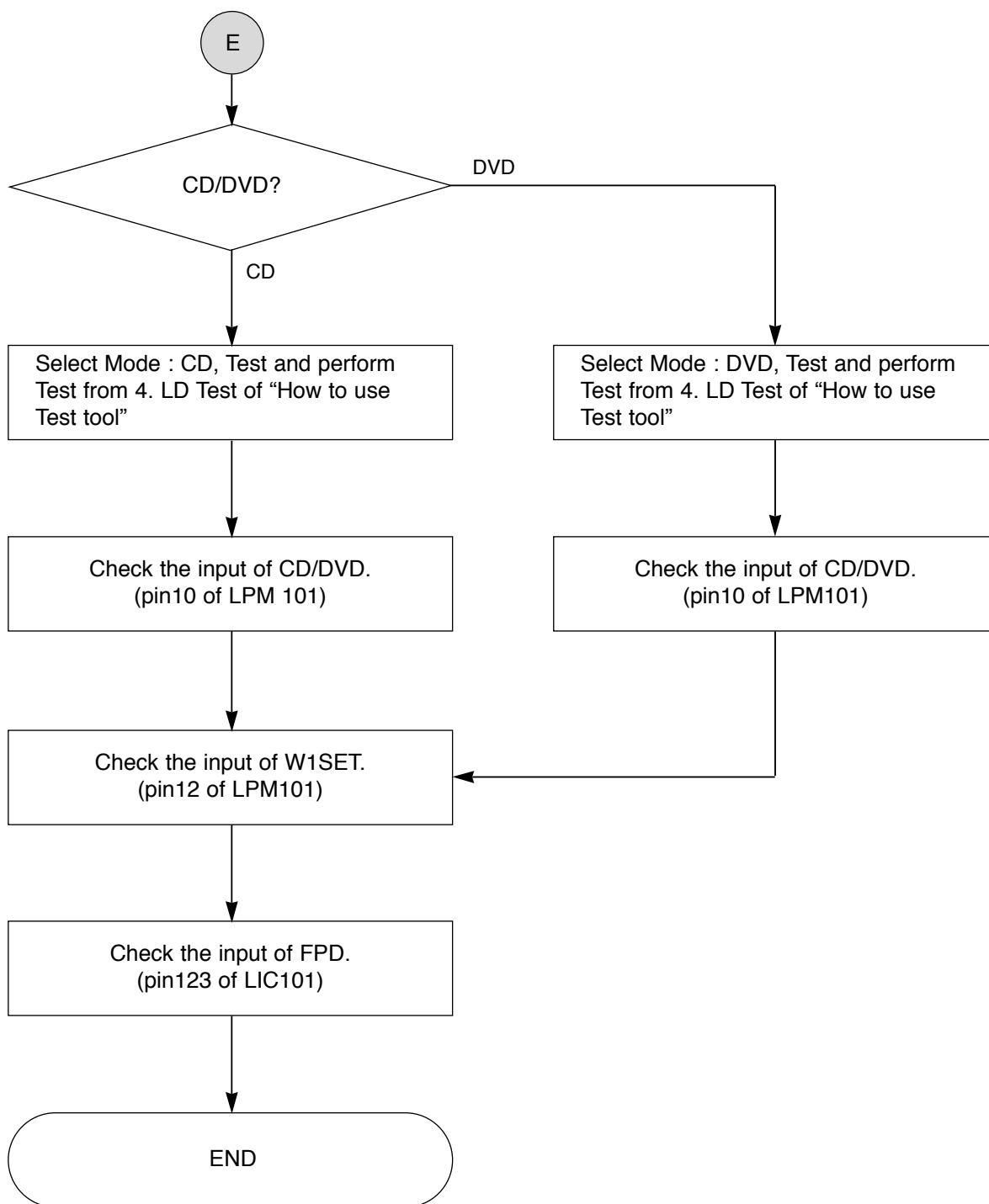

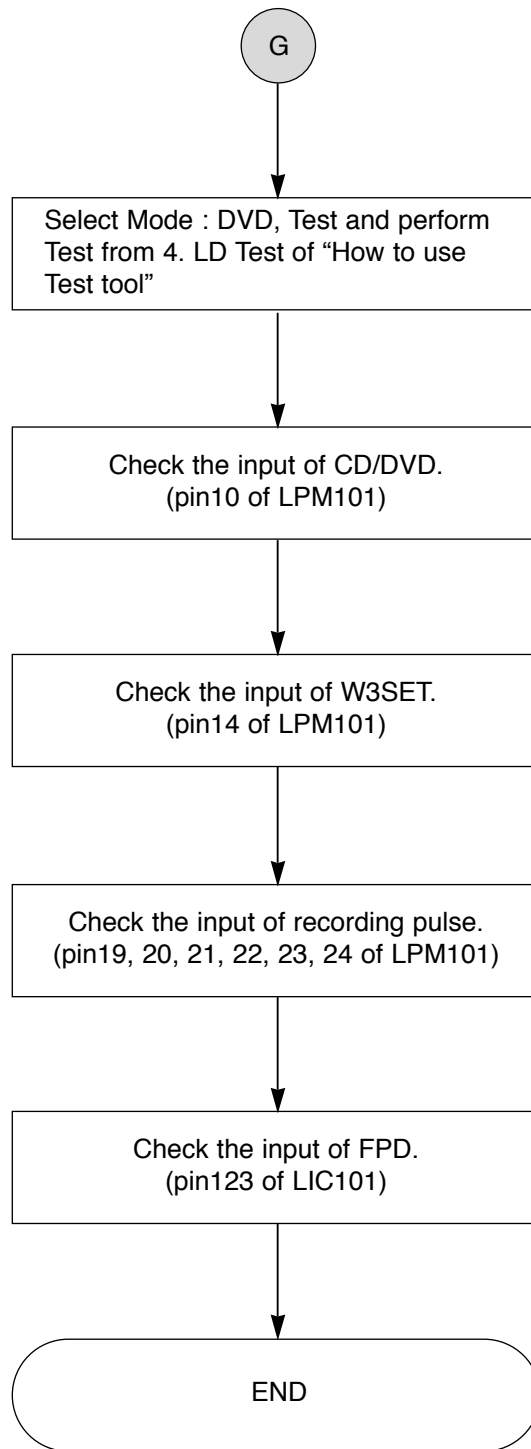
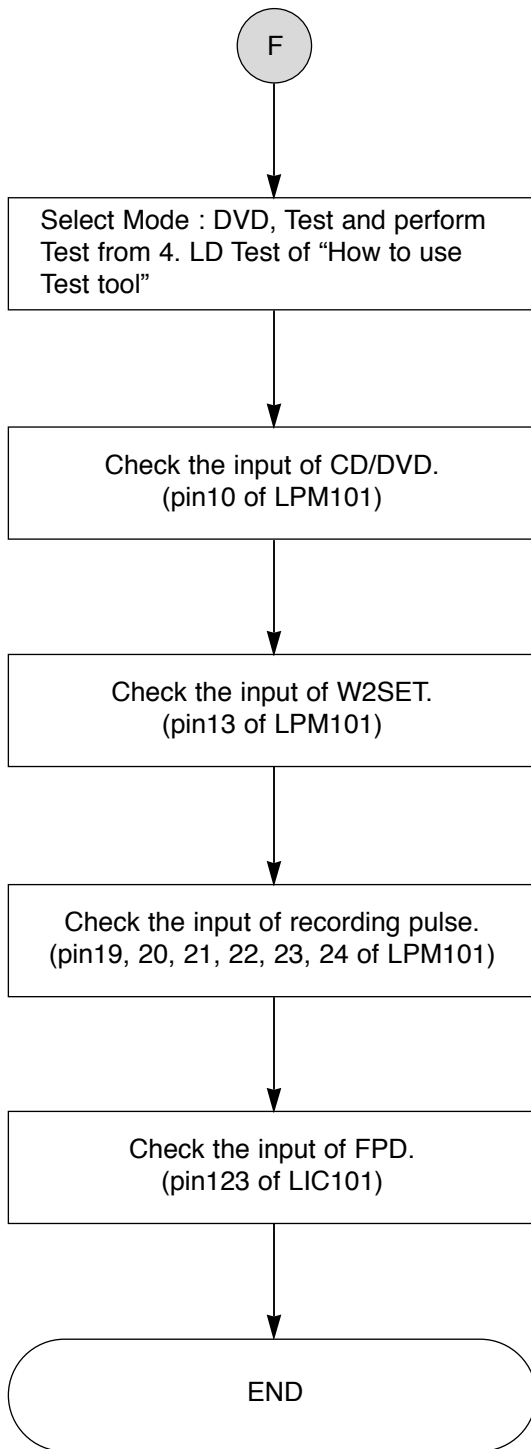

# THE DIFFERENCE OF DVD-R/RW, DVD+R/RW DISCS AND DVD-ROM

## 1. RECORDING LAYER

- DVD-ROM (Read Only Disc)

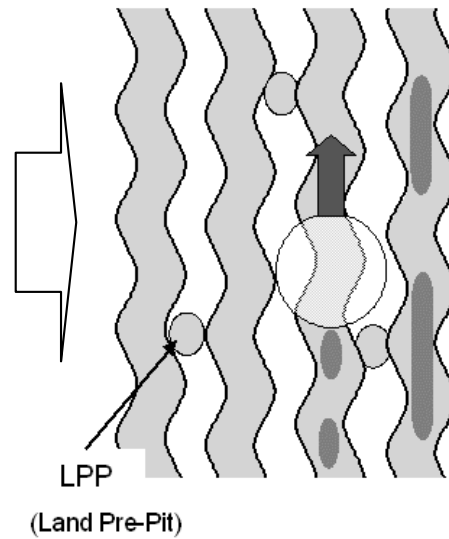
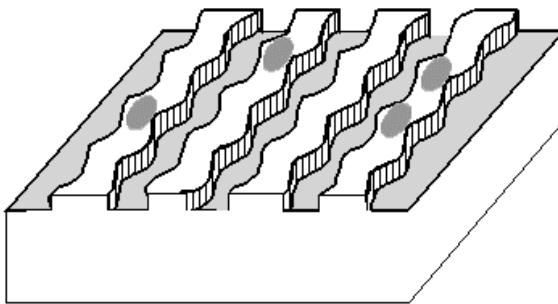
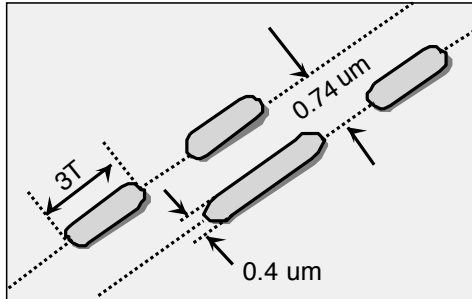

- DVD+R/RW Disc

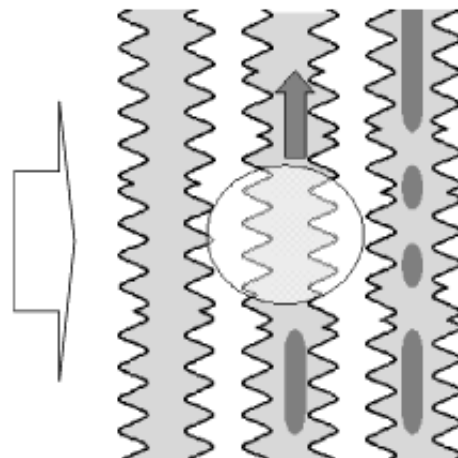
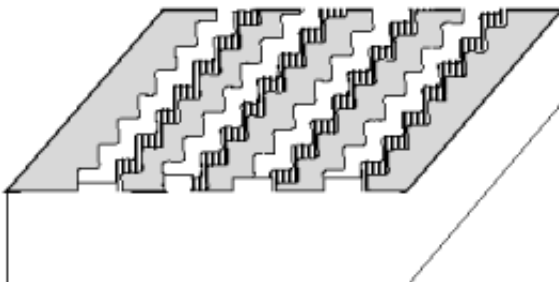

## 2. DISC SPECIFICATION

	DVD-ROM		DVD-R	DVD-RW	DVD+R	DVD+RW
	Single-Layer	Dual-Layer				
Media Type	Read Only	Read Only	Dye	Phase change	Dye	Phase change
User data capacity	4.7GB	8.54GB	4.7GB	4.7GB	4.7GB	4.7GB
Wavelength	650nm	650nm	650nm	650nm	650nm	650nm
Reflectivity	45~85%	18~30nm	45~85%	18~30%	45~85%	18~30nm
Track pitch	0.74 $\mu$ m	0.74 $\mu$ m	0.74 $\mu$ m	0.74 $\mu$ m	0.74 $\mu$ m	0.74 $\mu$ m
Minimum pit length	0.4 $\mu$ m	0.4 $\mu$ m	0.4 $\mu$ m	0.4 $\mu$ m	0.4 $\mu$ m	0.4 $\mu$ m
Modulation	>0.6	>0.6	>0.6	>0.6	>0.6	>0.6
Channel bit-rate	26.16MHz	26.16MHz	26.16MHz	26.16MHz	26.16MHz	26.16MHz
Wobble Frequency	–	–	140KHz	140KHz	817.4KHz	817.4KHz
Addressing	26.16MHz	26.16MHz	Wobble & LPP	Wobble & LPP	Wobble(ADIP)	Wobble(ADIP)
Read Power (mW)					0.7 $\pm$ 0.1	0.7 $\pm$ 0.1
Write Power (mW)	–					
Jitter	<8%	<8%	<8%	<8%	<9%	<9%

## 3. DISC MATERIALS

### 1) DVD-ROM

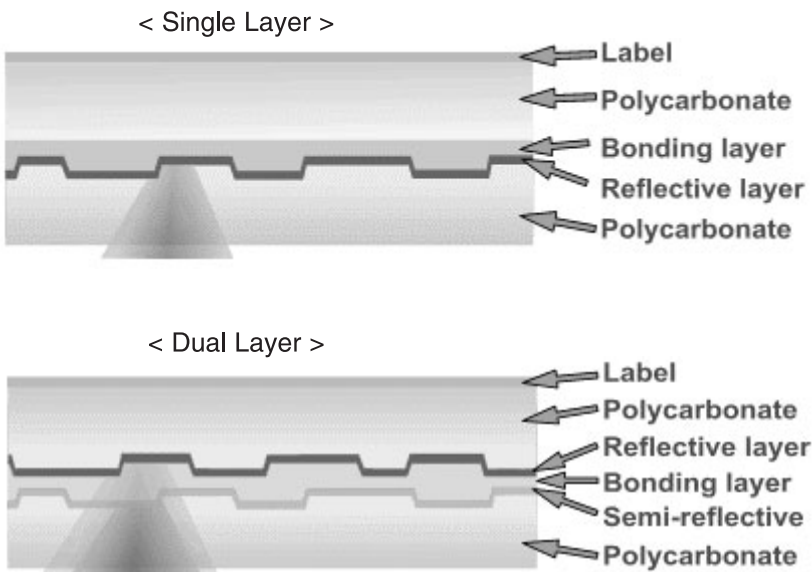



## 2) Recording format using organic dye material (DVD-R / DVD+R)

The format that records data through the creation of recorded marks by changing the organic dye material with a laser beam.

### • Disc structure

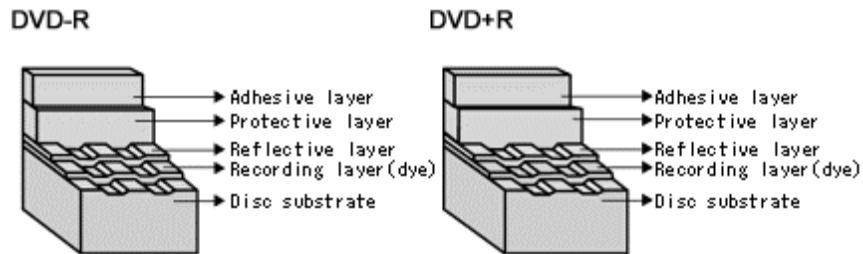

### • Recording principles

#### [ Recording ]

Recording is done by changing the organic dye layer and the substrate with a laser. When a strong laser is applied to a disc, the temperature of the organic dye material goes up, the dye is decomposed and the substrate changes at the same time. At this time, a durable bit is created as is the case with a CD-ROM.

#### [ Playback ]

Signals are read with the differences of the reflection of a laser from pits.

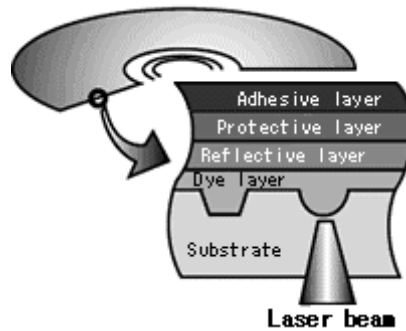

### 3) Recording format using phase-change recording material (DVD-RW / DVD+RW)

Data is recorded by changing the recording layer from the amorphous status to the crystalline status, and played back by reading the difference of the reflection coefficient.  
Amorphous: Non-crystalline.

#### • Disc structure

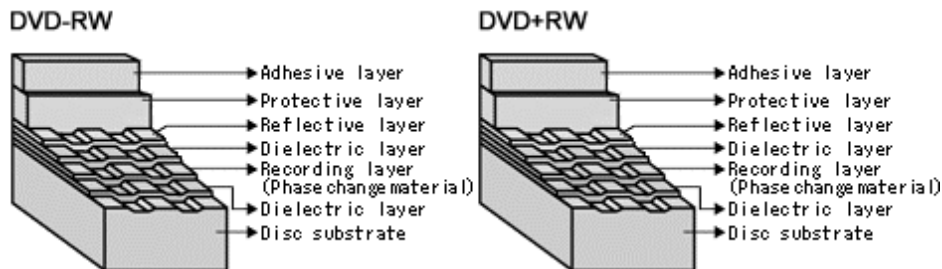

#### • Recording principles

##### [ Recording ]

When a high-power laser is applied to the recording material, it melts and then becomes amorphous with a low reflection coefficient when it quickly cools off. When a mid-power laser is applied to heat gradually the recording material and then gradually cools it off, it becomes crystal with a high reflection coefficient.

##### [ Playback ]

A low-power laser is used for playback. The amount of reflected light depends on the status (amorphous or crystalline) of the recording material. This is detected by an optical sensor.

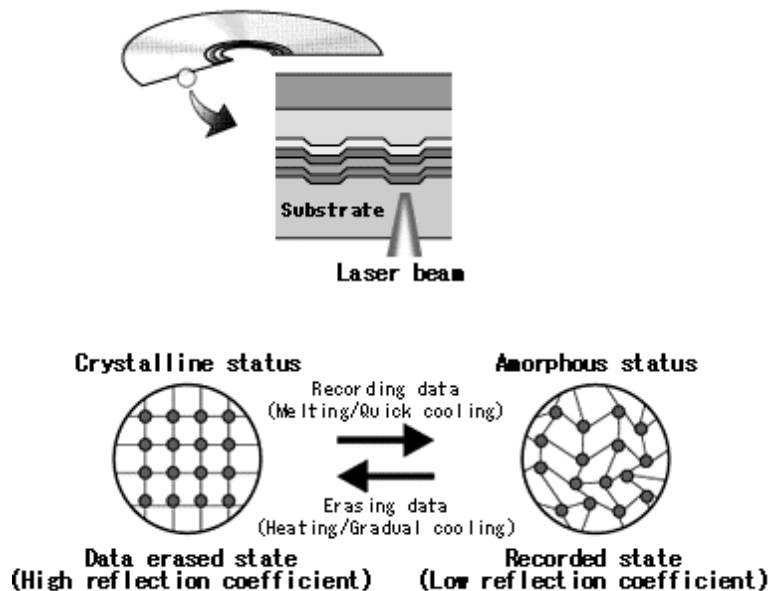

To make recordings, it is necessary to modulate the write pulse, which is called "Write Strategy". There can be many types in Write Strategy. Typically Write Strategy for DVD ± R has NMP(Non Multi-Pulse) type and MP(Multi-Pulse) type. In NMP type each single mark is created by subsequent separated short pulses. In MP type each single mark is created by one continuous pulse. Write Strategy for DVD ± RW has Type 1 and Type 2. In Type 1 the mark with nT width is created by one top pulse and (n-2) multi-pulses. Thus mark 3T is made by one top pulse and one multi-pulse. In Type 2 the mark with nT width is created by one top pulse and (n-3) multi-pulses. Thus mark 3T is made by one top pulse only. RS-06A uses MP type Write Strategy for DVD ± R and Type 1 for DVD ± RW as shown below.

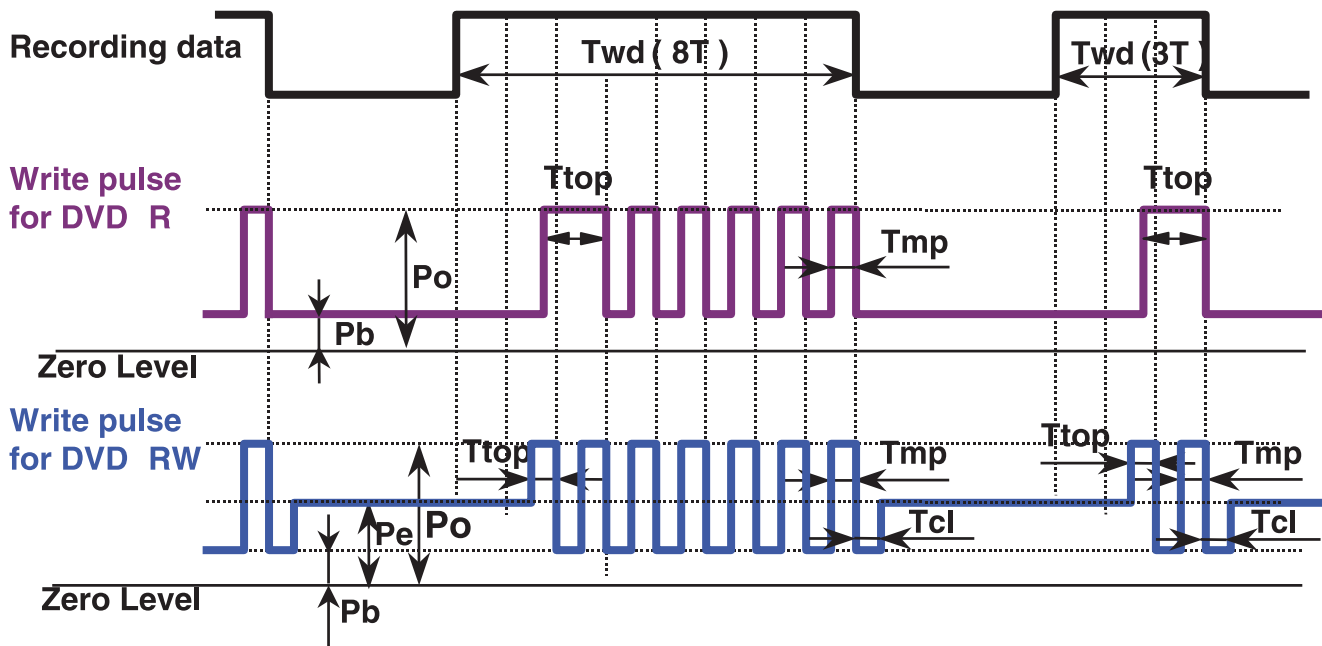

Po :Write Power (Peak Power)  
 Pe :Erase Power  
 Pb :Bias Power

# 4. ORGANIZATION OF THE INNER DRIVE AREA, OUTER DRIVE AREA, LEAD-IN ZONE AND LEAD-OUT ZONE

## 1) Layout of DVD-ROM disc

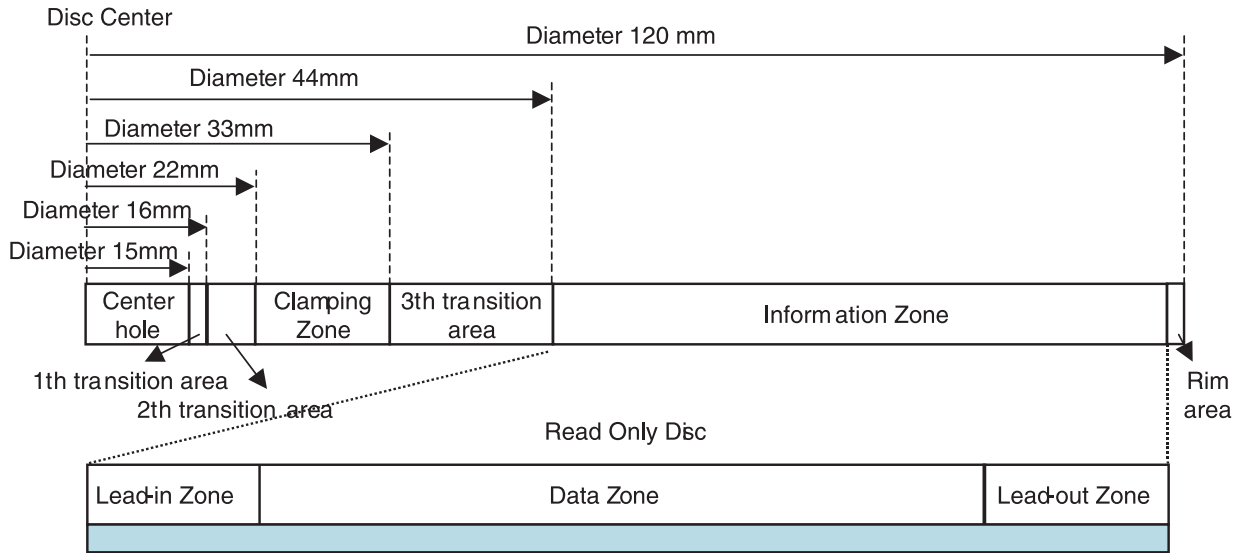

## 2) Layout of DVD+R disc

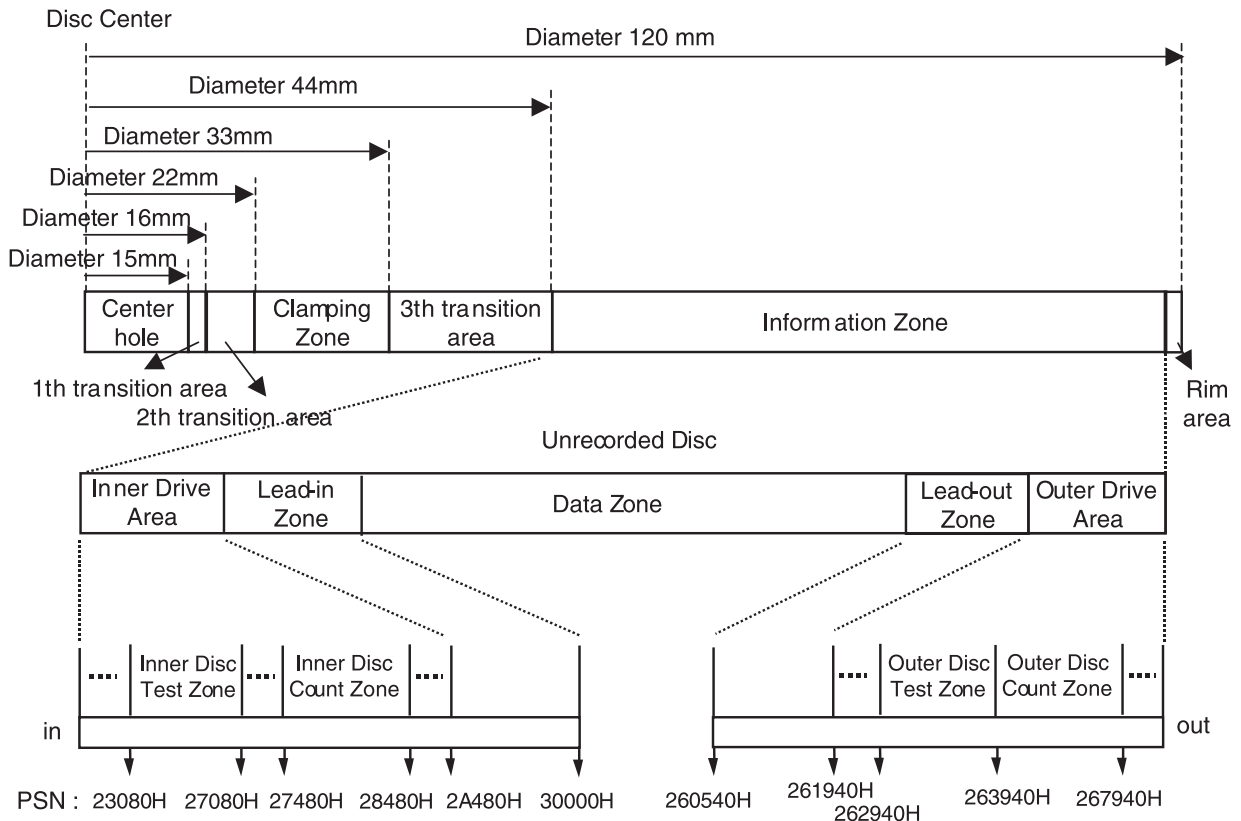

Inner Disc Test Zone : for performing OPC procedures.  
 Inner Disc Count Zone : For counting the number of OPC algorithm performed in IDT Zone.  
 Outer Disc Test Zone : for performing OPC procedures.  
 Outer Disc Count Zone : For counting the number of OPC algorithm performed in IDT Zone.

### 3) Layout of DVD+RW disc

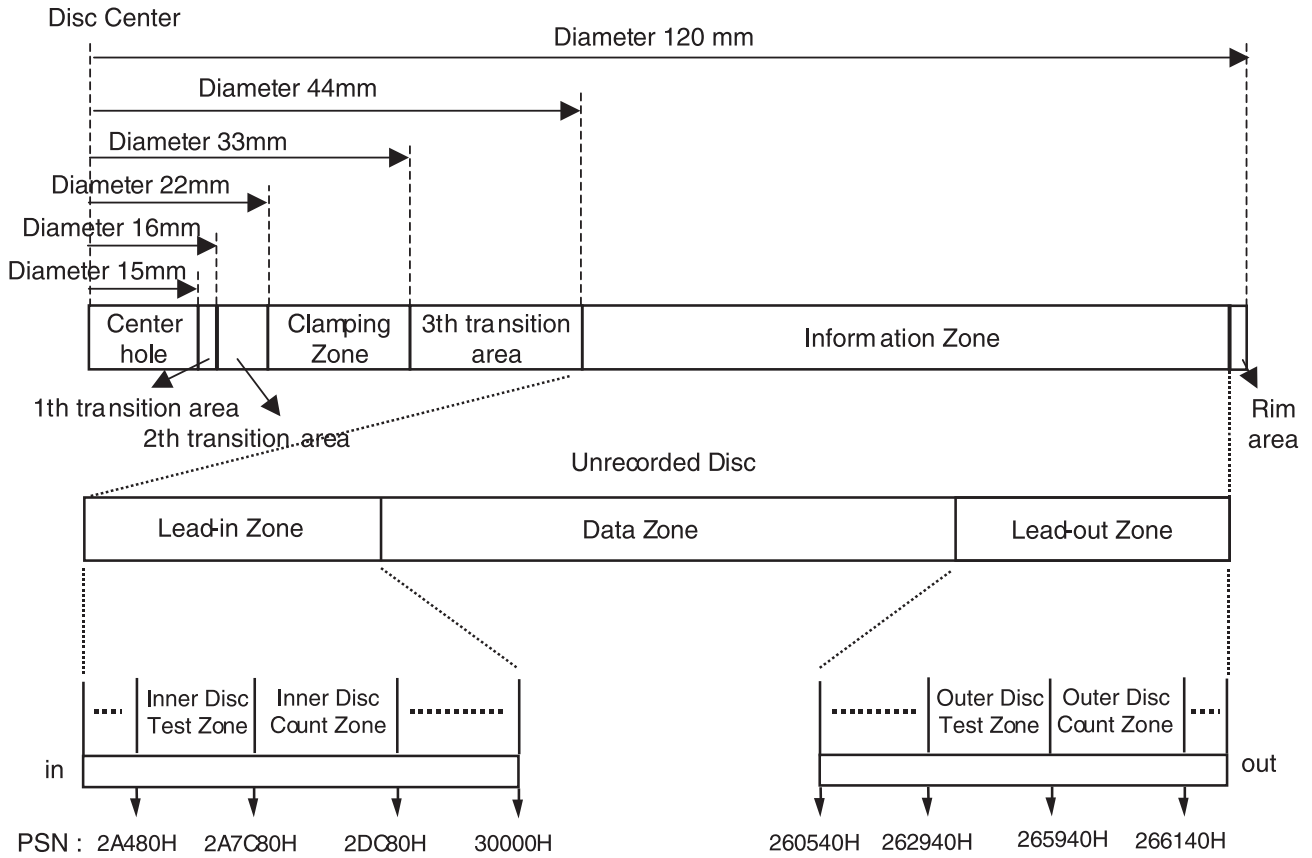

Inner Disc Test Zone : for performing OPC procedures.

Inner Disc Count Zone : For counting the number of OPC algorithm performed in IDT Zone.

Outer Disc Test Zone : for performing OPC procedures.

Outer Disc Count Zone : For counting the number of OPC algorithm performed in IDT Zone.

#### 4) Layout of DVD-R/RW disc

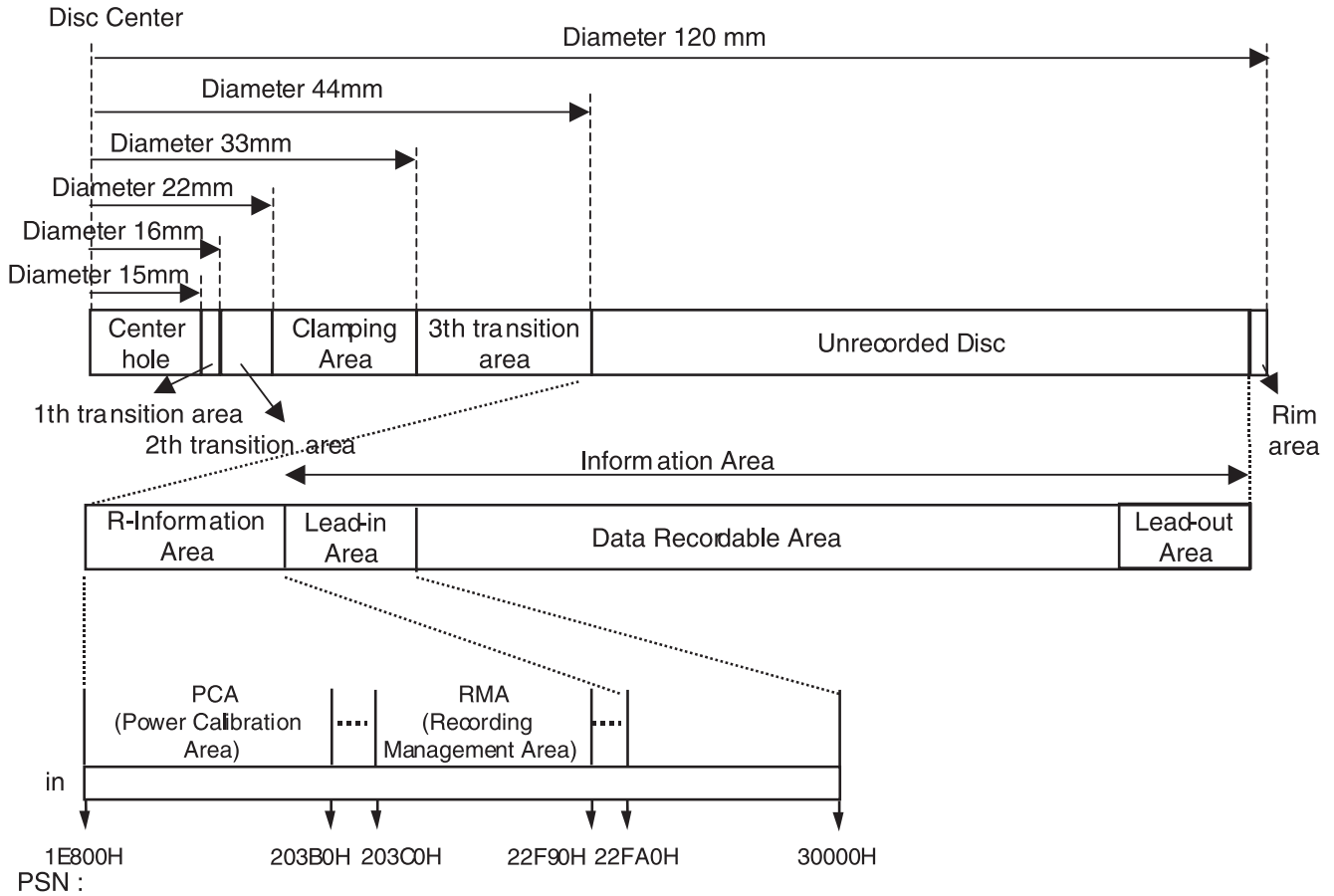

# OPTICAL POWER SETTING

## 1. AUTOMATIC OPTICAL POWER SETTING (SET-BASED)

The RS-06A mounted models are supported by the B/END to automatically execute the optical power setting of the loader at the set condition with the following steps.

1. Use the remote controller to select the mode as Lock position at the Setup menu.
2. Use the remote controller to enter 5 -> 7 -> 2 -> 0 into the set.  
When they are normally entered, the GUI is displayed as shown at Fig. 1.
3. When you select 'Yes', the optical power setting is automatically proceeded and it takes about 20 seconds.
4. When setting is finished, OK or NG is displayed on the screen.  
The OK screen is displayed for the normal termination (Fig. 2)  
The NG screen is displayed for the abnormal termination (Fig. 3)
5. When you select 'Yes' button, the GUI is cleared and it normally operates.



Fig. 1



Fig. 2



Fig. 3

## 2. MANUAL OPTICAL POWER SETTING

If the manual optical power setting is not accomplished, you can use the automatic optical power setting.

### 2-1. ALPC Measurement System

We need basically several measurement instruments to adjust Optical Power of CD and DVD Disc

- **ESSENTIAL INSTRUMENT**

- 1) Optical Power meter & Sensor (ADVANTEST, TQ8230/Q82014A)
- 2) Personal Computer
- 3) Adjustment Program (Dragon or ALPC) --> being recommended ALPC Program in case of SVC

- **OPTIONAL INSTRUMENT**

- 1) USB-ATAPI Interface (if you don't have Notebook which has ATAPI Interface or use PC USB Port)
- 2) Connector-ATAPI Interface Board

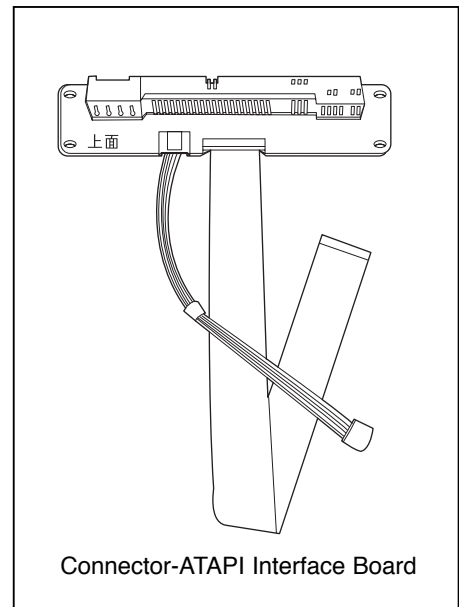
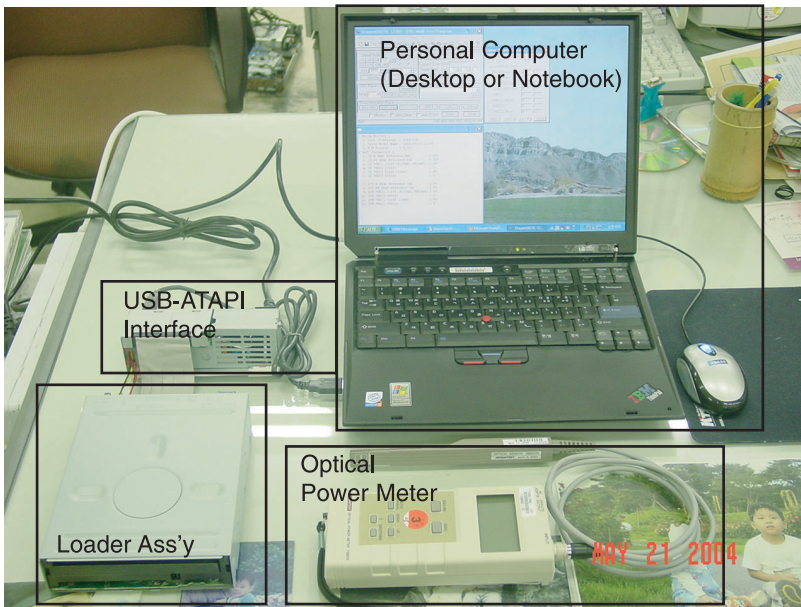

### 2-2. ALPC Program

Use the ALPC program in Dragon tool for Optical power setting. It is consist of total 4 files.

Dragon\_JW3P.exe  
dragon.cfg  
blue.dat  
WNASPI32.DLL

Four files must exist in same Directory.



## 2-3. Execute ALPC Program

1) Execute Dragon\_JW3P.exe file.



2) Enter the password. It is “qaz”.  
When you enter the password, turn off the “Caps lock” in your keyboard.

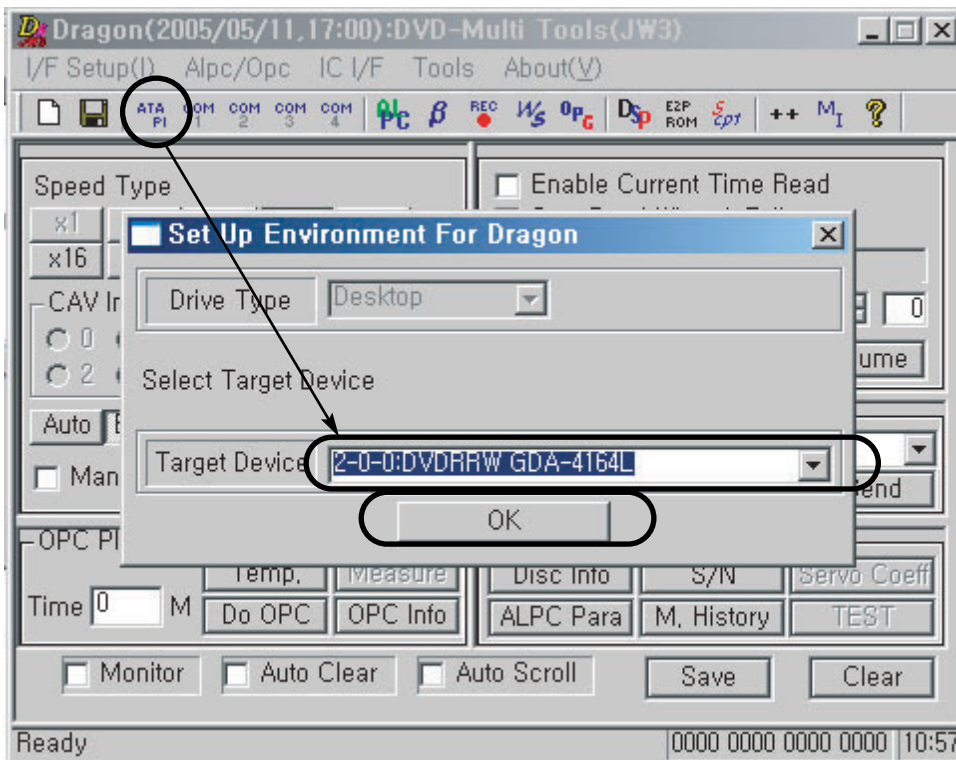

3) Set up the target device.  
Press “ATAPI” button on the main dialog of Dragon tool. And find the target device which is GDA-4164L.

4) If the target device setting is completed, execute the "Setup Laser Power(Manual)" in the "Alpc/Opc" menu.

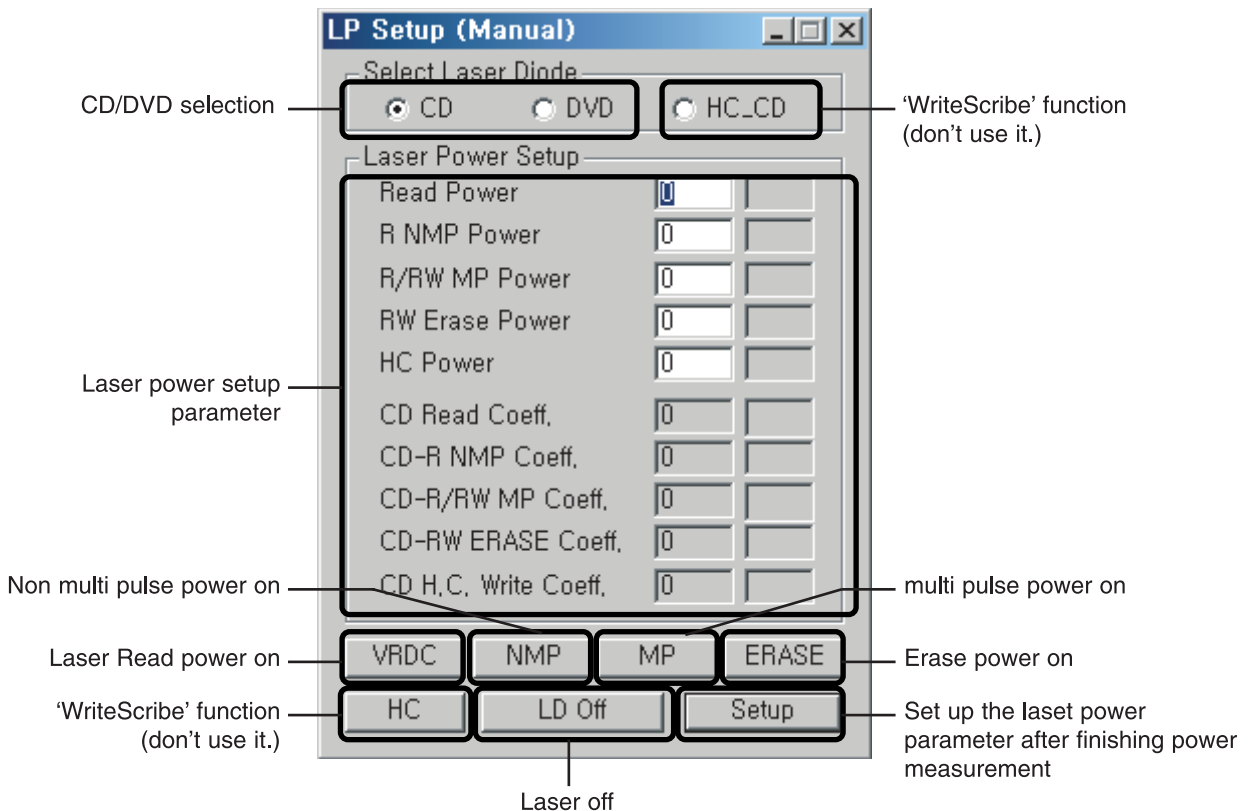
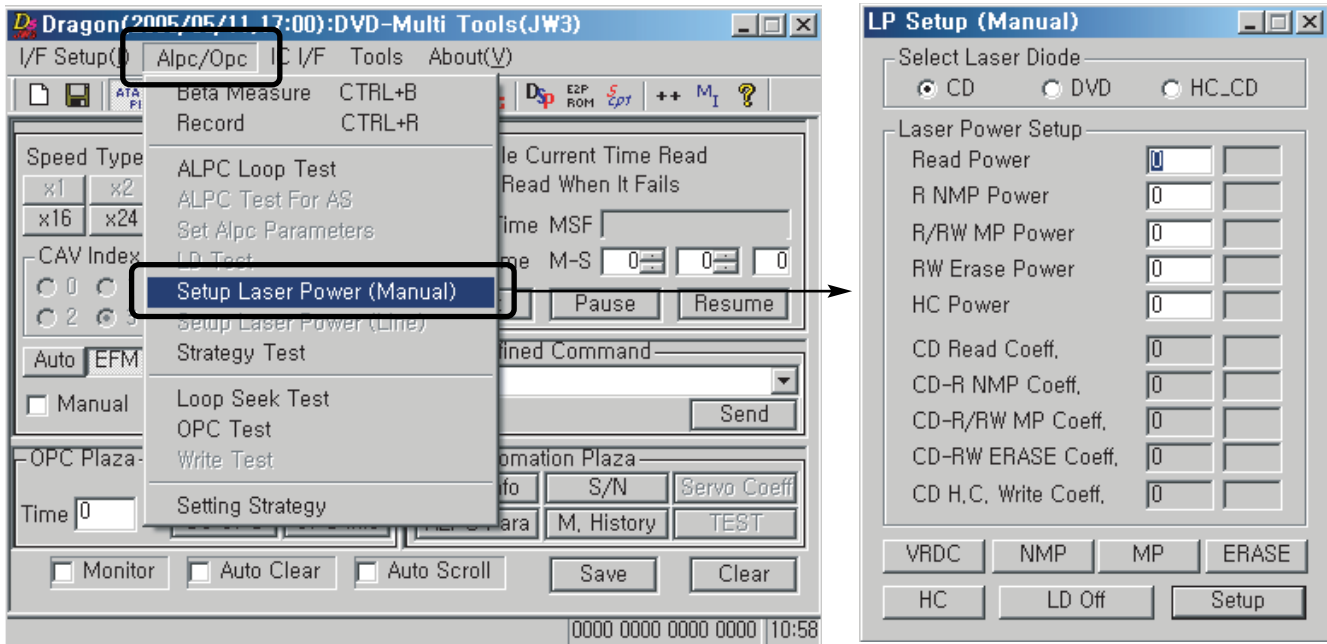







## 2-4. Optical power setting

<Test for checking DVD LD and CD LD>



When you change the Travers ass'y(including pick-up) or loader PCB, you must do the laser power setting to match pick-up and loader PCB.

### 1) DVD LD power setting

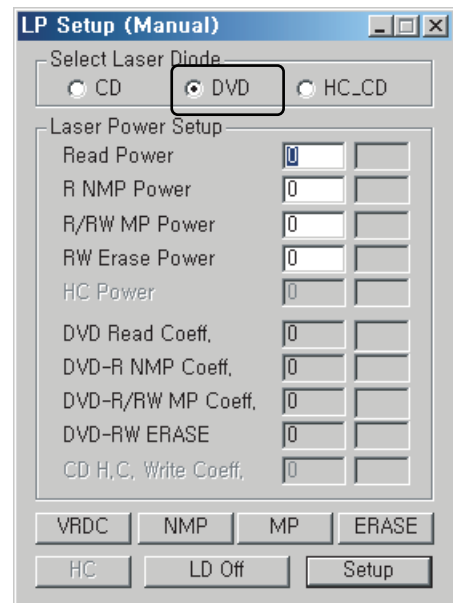
- Select the DVD in the “Select Laser Diode”
- Press  (Read power on, Strong read light)
- Measure optical read Power.
- Write read power value.
- In case of    , you are able to measure the power through same procedure.  
(caution) Don't watch light directly.
- When you finish optical power measurement, press  button(LD Off).
- Press  button.(save to ERPROM)



### 2) CD LD Power Setting

- Select the CD in the “Select Laser Diode”
  - Press .
  - Measure optical read Power.
  - Write Read Power value.
  - Press  button(save to ERPROM)
- \*\*\* In case of CD power setting of RS-06A, loader doesn't need to set up write power.  
Although NMP, MP, Erase and HC power is N.G when you press setup, please ignore the N.G message.  
Because of RS-06A only support reading function about CD-R/RW.
- \* Look at reference sheet to test Optical Power.  
\*\* Power value is mW unit. Value is read power X 100.

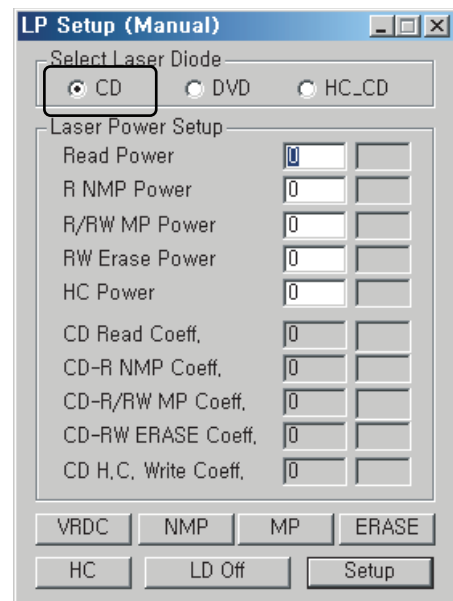

## 2-5. Confirm Optical Power Setting Parameter

LD Test result is ok, but Loader performance is bad.

### 1. Check ALPC parameter value

1) Press **++** button to open "Results Display" dialog.

2) Press **ALPC Para** button.

- We can see optical power setting value.
- Write optical Power Setting value to paper.
- Adjust power setting again.
- Compare original parameter to new parameter.
- if parameter value is different, original value is wrong or optical power may change.
- But pick-up LD test is all ok, just adjust optical power setting again.

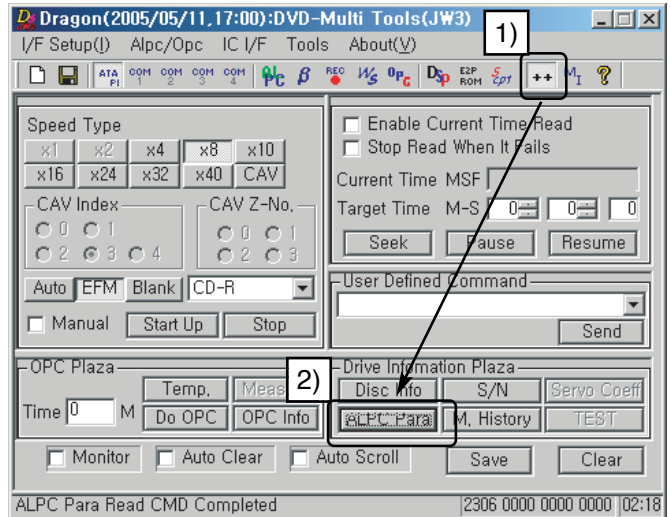

Normal range of ALPC parameter

Optical power value which has been saved in the EEPROM

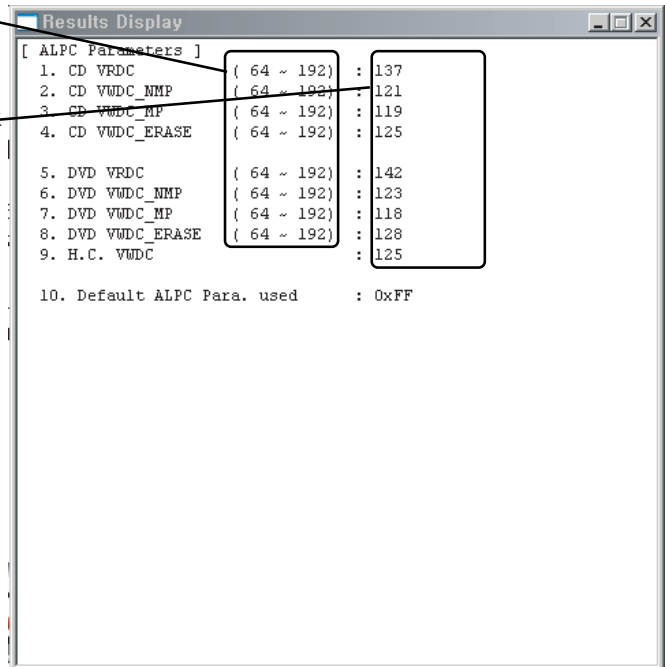

## 2-6. Attachment. Optical Power Measurement

Optical Power measurement is to adjust LD power from Pick-up  
To measure optical power, LD status is on. Other light affects optical power.  
Avoid other light to measure exact power  
Generally headlight power is about  $50\mu\text{W}$ , Sun power is about  $100\text{mW}$ .

Optical Power measurement method

1. Fit optical Power Meter  $\lambda$  (wavelength) value to DVD.(generally 660nm)
2. DVD LD On.
3. Approach power sensor to Pick-up Lens about 3mm vertically. Fix Lens and Sensor mark position.
4. Read Monitor value. (move sensor read just a little and read max value.)  
(caution) unit is mW.
5. Write monitoring value x 100. Only an integer.
6. Fit Power Meter (wavelength) value to CD.(generally 780nm)
7. CD LD On.
8. 3 ~ 5 recheck.

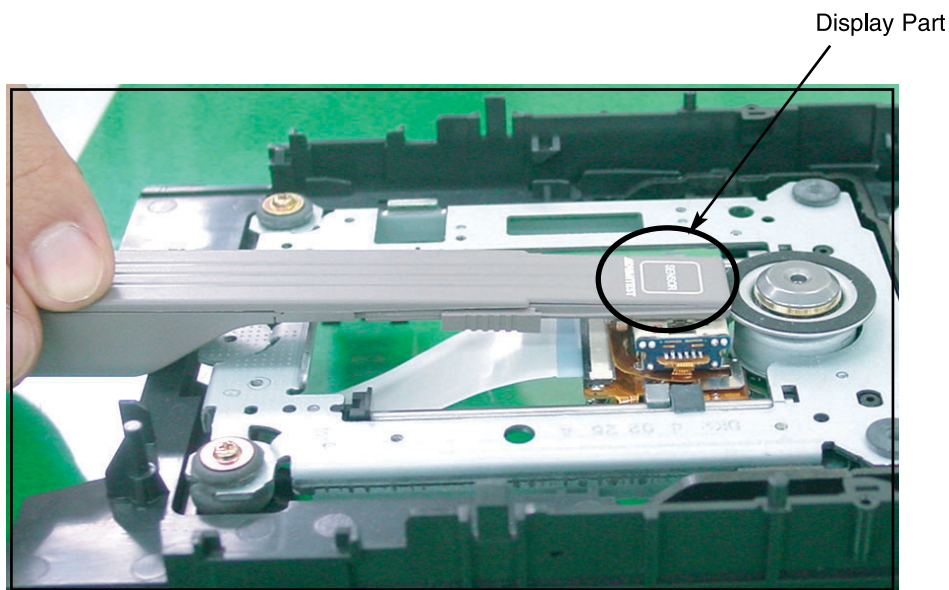

# INTERNAL STRUCTURE OF THE PICK-UP

## 1. BLOCK DIAGRAM OF THE PICK-UP (HOP-7232TL)

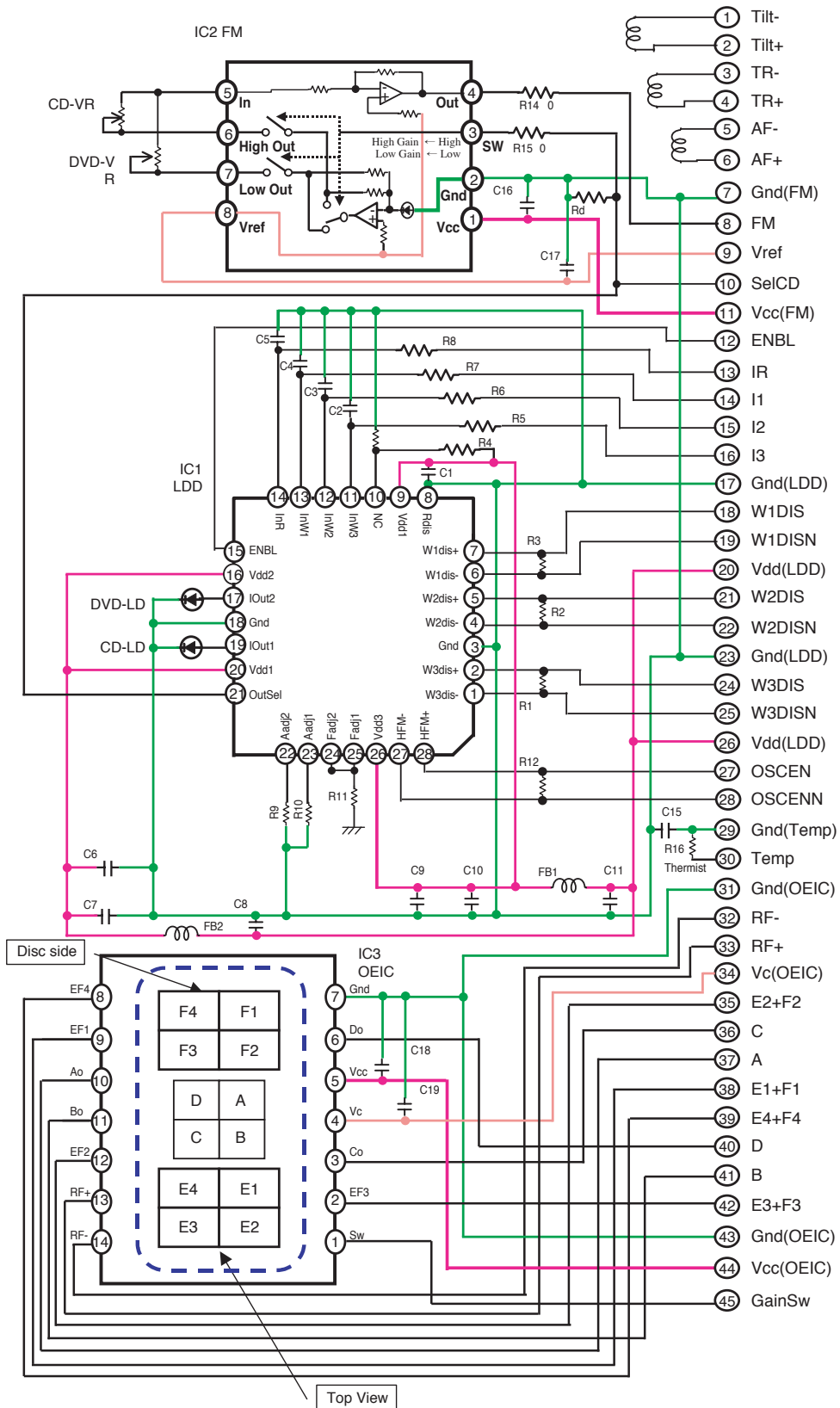

## 2. PICK UP PIN ASSIGNMENT

No.	Signal Name	Signal Description	I/O
1	Tilt-	Tilting Actuator drive signal -	I
2	Tilt+	Tilting Actuator drive signal +	I
3	TR-	Tracking Actuator drive signal -	I
4	TR+	Tracking Actuator drive signal +	I
5	AF-	Focusing Actuator drive signal -	I
6	AF+	Focusing Actuator drive signal +	I
7	Gnd(FM)	Ground connection for FM	
8	FM	FM output	O
9	Vref	FM reference voltage input	I
10	SELCD	High:selects CD-LD,CD-VR Low: selects DVD-LD,DVD-VR	I
11	Vcc(FM)	Power supply for FM (+5 V)	
12	ENABLE	Disables output current regardless of **DIS (Low voltage:No lout)	I
13	IR	Input current for current amplifier	I
14	I1	Input current for current amplifier	I
15	I2	Input current for current amplifier	I
16	I3	Input current for current amplifier	I
17	GND(LDD)	Ground connection for LDD	
18	W1DIS	LVDS control for output current (Low active) (LVDS+)	I
19	W1DISN	LVDS control for output current (LVDS-)	I
20	VDD(LDD)	Power supply for LDD (+5 V)	
21	W2DIS	LVDS control for output current (Low active) (LVDS+)	I
22	W2DISN	LVDS control for output current (LVDS-)	I
23	Gnd(LDD)	Ground connection for LDD	
24	W3DIS	LVDS control for output current (Low active) (LVDS+)	I
25	W3DISN	LVDS control for output current (LVDS-)	I
26	Vdd(LDD)	Power supply for •DD (+5 V)	
27	OscEn	LVDS control for Oscillator (High active) (LVDS+)	I
28	OscEnN	LVDS control for Oscillator (LVDS-)	I
29	Gnd(TEMP)	Ground connection for Thermister	
30	TEMP	Resistance for controlling temperature	O
31	Gnd(OEIC)	Ground for OEIC	O
32	RF-	Signal OEIC RF negative differential output	O
33	RF+	Signal OEIC RF positive differential output	O
34	Vc(OEIC)	Reference voltage input for OEIC (+2.1 V)	I
35	E2+F2	Signal OEIC output EF2	O
36	C	Signal OEIC output C	O
37	A	Signal OEIC output A	O
38	E1+F1	Signal OEIC output EF1	O
39	E4+F4	Signal OEIC output EF4	O
40	D	Signal OEIC output D	O
41	B	Signal OEIC output B	O
42	E3+F3	Signal OEIC output EF3	O
43	Gnd(OEIC)	Ground for OEIC	
44	Vcc(OEIC)	Power supply for OEIC (+5 V)	I
45	GainSw	OEIC output gain control (High voltage:Low gain , Middle:Middle gain , Low:High gain)	I

### 3. SIGNAL DETECTION OF THE P/U

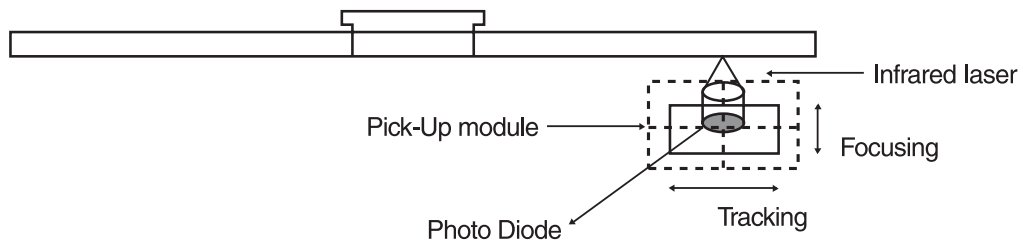

**1) Focus Error Signal ==> (A+C)-(B+D)**

This signal is generated in RF IC (LIC121 : AN22113A) and controls the pick-up's up and down to focus on Disc.

**2) Tracking Error Signal (DPP Method) ==> {(A+D)-(B+C)}- k x {(EF1+EF4)-(EF2+EF3)}**

This signal is generated in RF IC (LIC121 : AN22113A) and controls the pick-up's left and right shift to find track on Disc.

**3) RF Signal ==> (A+B+C+D)**

This signal is converted to DATA signal in DSP IC (LIC201 : MN103SA6G).

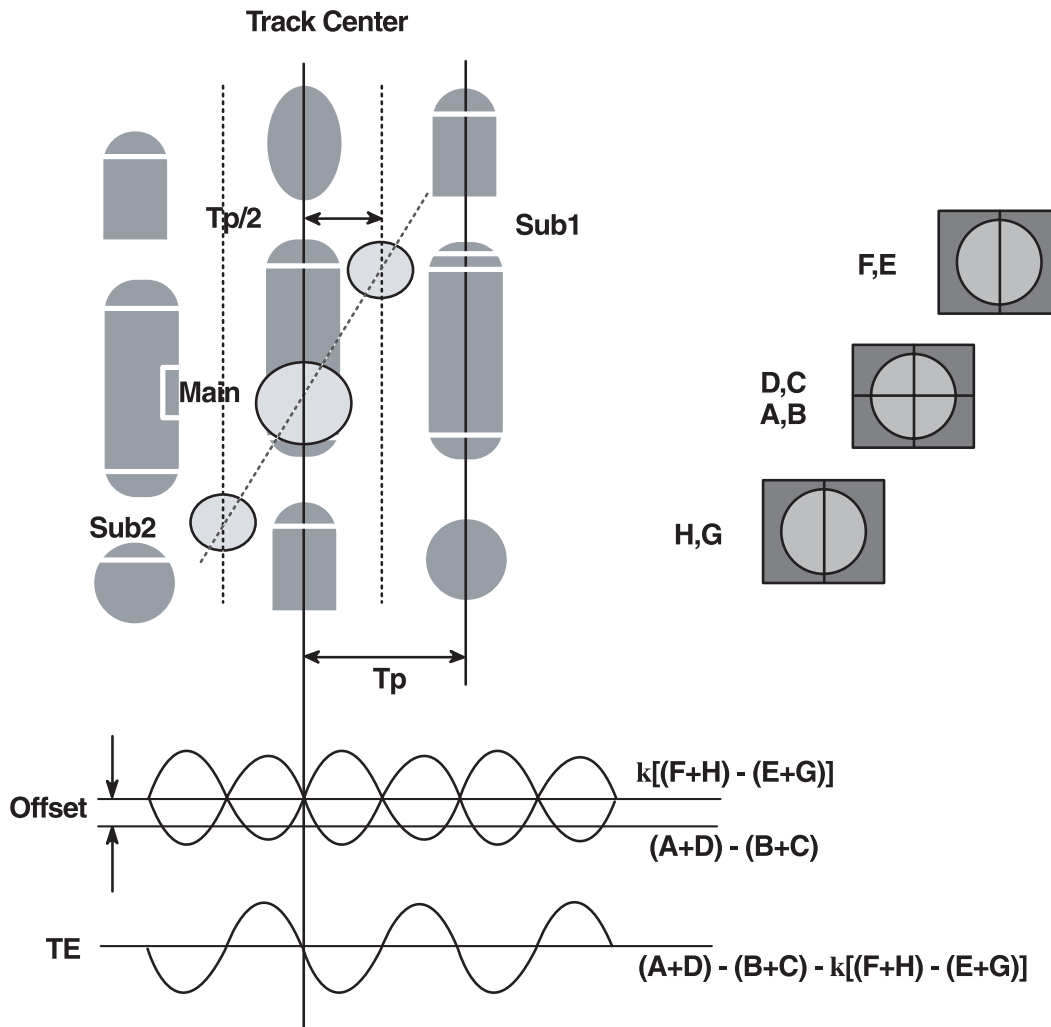



# DESCRIPTION OF CIRCUIT

## 1. ALPC (AUTOMATIC LASER POWER CONTROL) CIRCUIT

### 1-1. Block Diagram

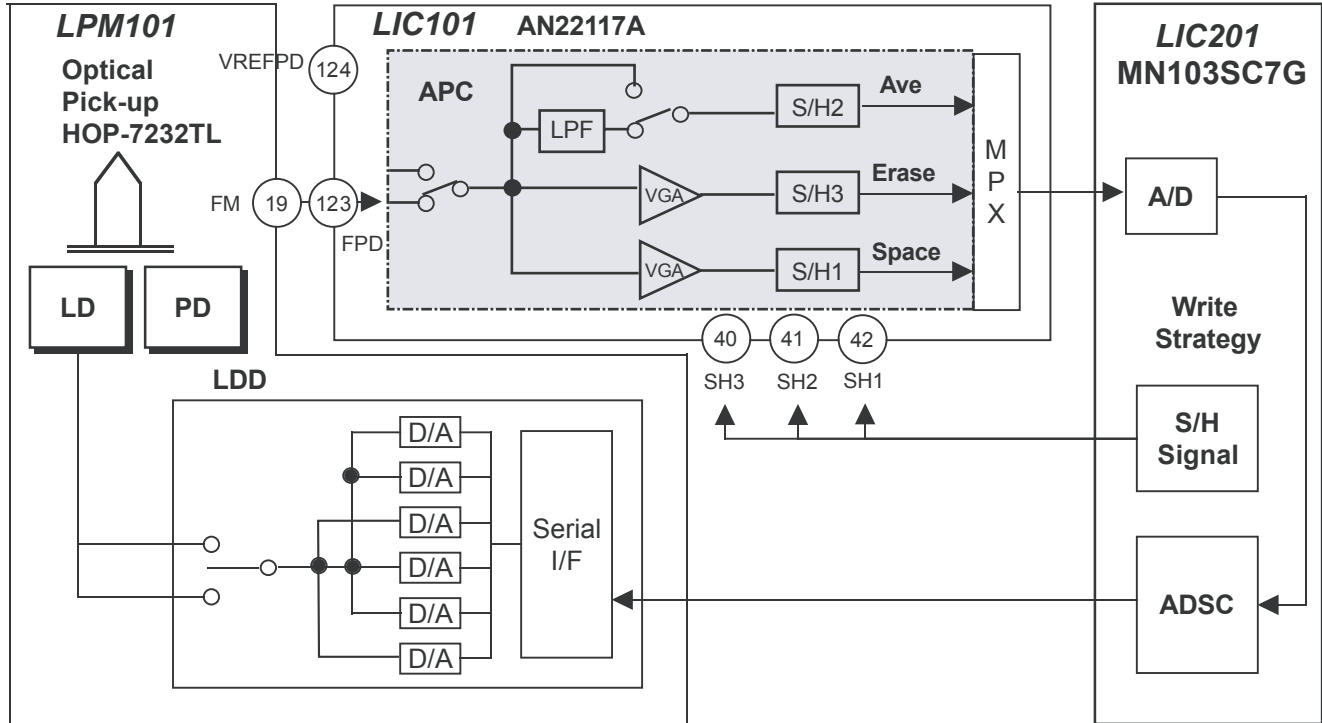

### 1-2. ALPC (Automatic Laser Power Control) Circuit Operation

The ALPC block detects the laser output power of the front monitor. The power signal detected with the PD for front monitor detection is input the voltage from the VPD pin(123Pin), the reference signal of the input signal is input from the VREFPD pin(124Pin). The ALPC block generates the signals from the input laser power signals in the following detection systems. This block has four detection paths:All average value path, multi pulse average/peak value detection path, erase/bottom value detection path, space/playback power value detection path.

## 2. FOCUS/TRACKING/SLED SERVO CIRCUIT

### 2-1. Focus, Tracking & Sled Servo Process

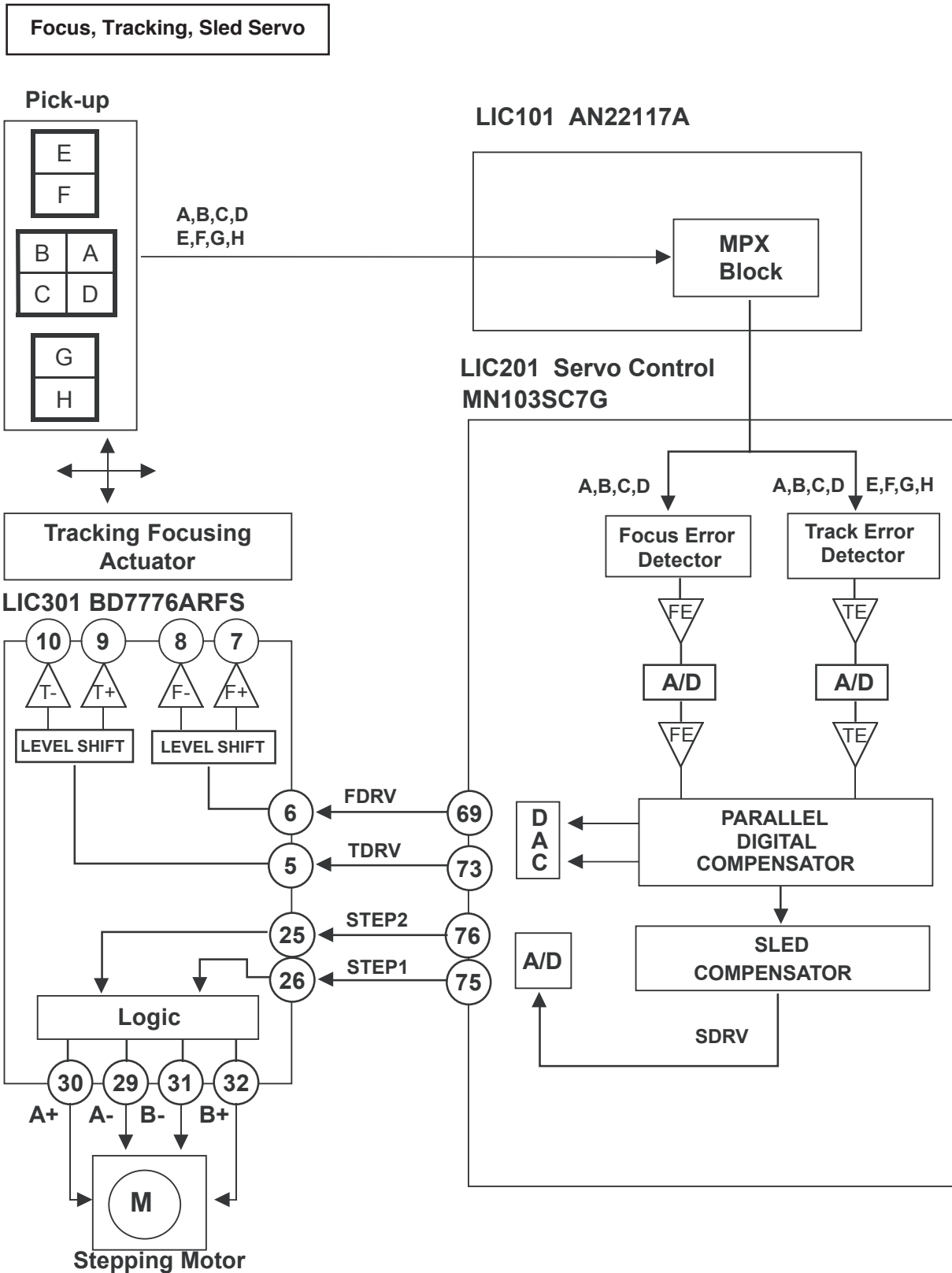

### 3. SPINDLE SERVO CIRCUIT

#### 3-1. Spindle Servo Process

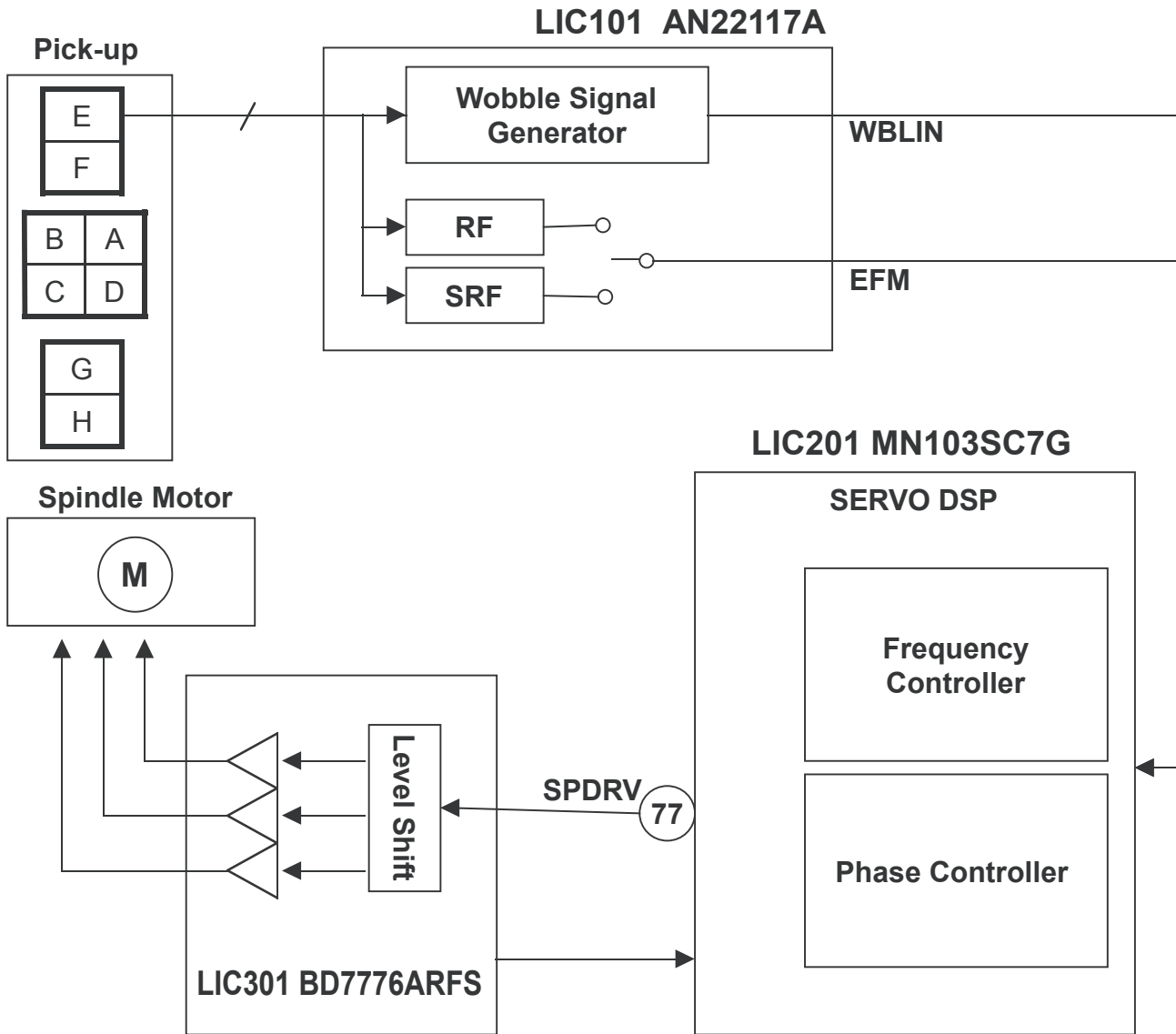

# MAJOR IC INTERNAL BLOCK DIAGRAM AND PIN DESCRIPTION

## 1. LIC101 (AN22117A) : FEP(RF) ANALOG SIGNAL PROCESSOR

- Pin Assignment

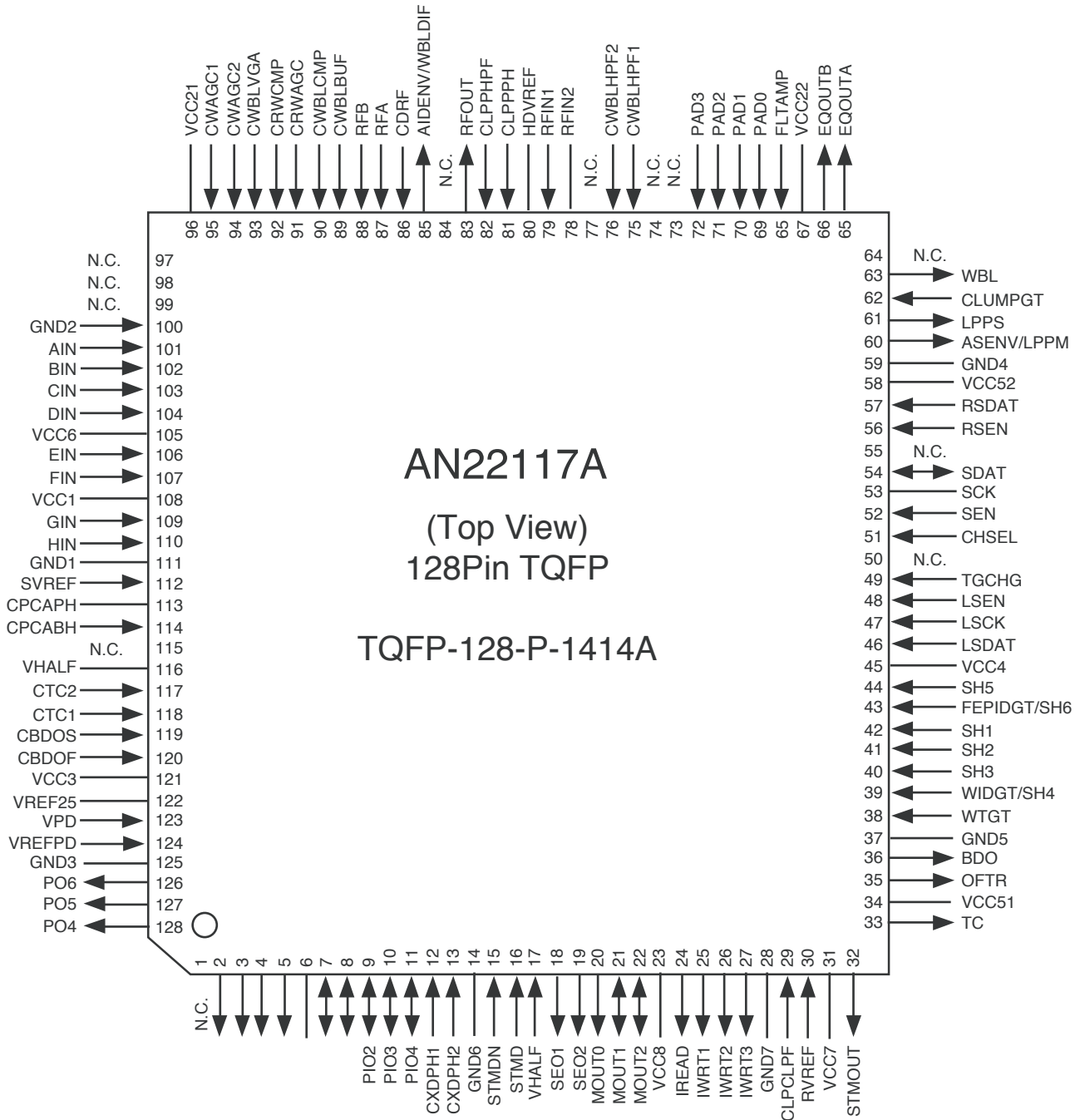

• **Block Diagram**

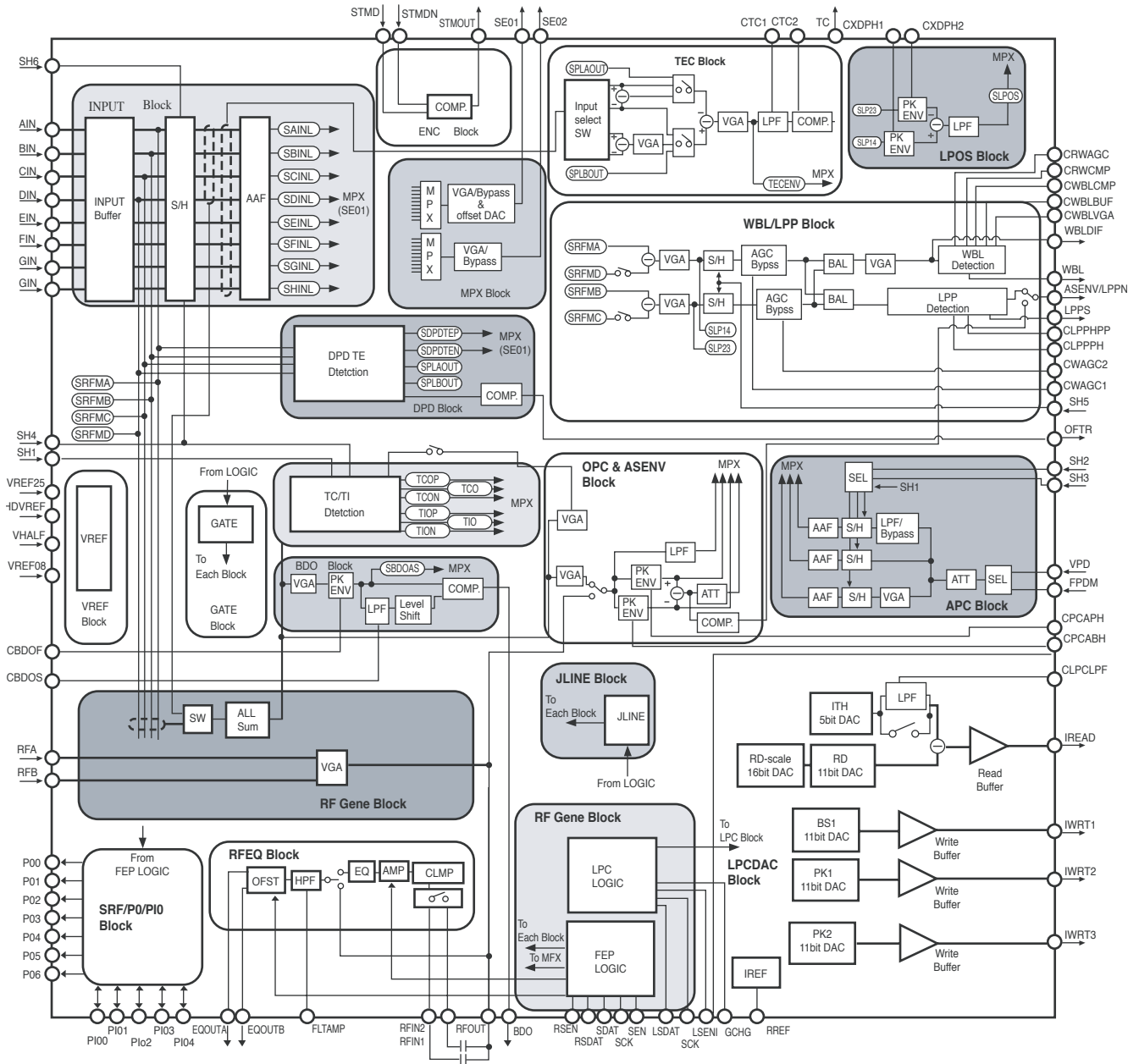

• **Pin Assignment**

Pin no.	Pin Name	Type	Function
1	NC	-	-
2	PO3	O	General CMOS output pin
3	PO2	O	Head Amp/OEIC gain change signal output pin 3.
4	PO1	O	Head Amp/OEIC gain change signal output pin 2.
5	PO0	O	Head Amp/OEIC gain change signal output pin 1.
6	VCC53	PS	Power supply pin for CMOS I/F & LOGIC.
7	PIO0	I/O	General CMOS Input/Output pin 0.
8	PIO1	I/O	General CMOS Input/Output pin 1.
9	PIO2	I/O	General CMOS Input/Output pin 2.
10	PIO3	I/O	General CMOS Input/Output pin 3.
11	PIO4	I/O	General CMOS Input/Output pin 4.
12	CXDPH1	I	PH capacitor connection pin 1 for LPOS.
13	CXDPH2	I	PH capacitor connection pin 2 for LPOS
14	GND6	PS	GND pin for BG.
15	STMDN	I	PD input pin for STM.
16	STMD	I	PD input pin for STM.
17	VREF08	O	0.8V reference voltage output pin (APC).
18	SEO1	O	Output pin 1 after selection of each error signal.
19	SEO2	O	Output pin 2 after selection of each error signal.
20	MOUT0	O	Analog monitor 0.
21	MOUT1	I/O	Analog monitor 1.
22	MOUT2	I/O	Analog monitor 2.
23	VCC8	PS	Power supply pin for LPC (5.0V)
24	IREAD	O	DAC electric current output pin for READ.
25	IWRT1	O	DAC electric current output pin 1 for WRITE.
26	IWRT2	O	DAC electric current output pin 2 for WRITE.
27	IWRT3	O	DAC electric current output pin 3 for WRITE.
28	GND7	PS	GND pin for LPC.
29	CLPCLPF	I	Capacitor connection pin for LPC/DAC LPF.
30	RVREF	I	Capacitor connection pin for reference voltage setting.
31	VCC7	PS	Power supply pin for LPC (3.3V).
32	STMOUT	O	Encoder circuit comparator output.
33	TC	O	Track cross signal output.
34	VCC51	PS	Power supply pin for CMOS I/F & LOGIC(3.3V)
35	OFTR	O	OFTR signal output.
36	BDO	O	BDO output.
37	GND5	PS	Ground pin for CMOS I/F.
38	WTGT	I	Write gate signal input pin (pull-down)
39	WIDGT/SH4	I	VFO through signal input pin. ROPC mark detection sampling signal innput pin (pull-down)
40	SH3	I	PCA average detection, APC space detection/Playback power detection/ Erase detection sample timing signal input pin(pulldown).

Pin no.	Pin Name	Type	Function
41	SH2	I	PCA peak/bottom detection, APC space detection/ Playback power detection/Erase detection sample timing signal input pin (pulldown)
42	SH1	I	ROPC space detection, APC space detection/ Playback power detection sample timing signal input pin(pulldown).
43	FEPIDGT/SH6	I	CAPA through signal input pin/servo sampling signal input pin (pull-down)
44	SH5	I	Sample-and-hold timing signal input pin of wobble S/H at recording (pull-down)
45	VCC4	PS	Power supply pin for internal LOGIC (5.0V)
46	LSDAT	I/O	Serial data input for LPC.
47	LSCK	I	Serial clock enable input LPC.
48	LSEN	I	Serial enable input for LPC.
49	TGCHG	I	LPC DAC bank change control signal input pin.
50	NC	-	-
51	CHSEL	I	Serial MPX channel change data input pin.
52	SEN	I	Serial enable input pin for FEP (pull-down)
53	SCK	I	Serial clock input pin for FEP (pull-up).
54	SDAT	I/O	Serial data input pin for FEP.
55	NC	-	-
56	RSEN	I	Serial enable input for RF (pull-down).
57	RSDAT	I	Serial signal data input for RF
58	VCC52	PS	Power supply pin for CMOS I/F & internal current source power supply pin2 (3.3V)
59	GND4	PS	Ground pin for internal LOGIC
60	ASENV/LPPM	O	ASENV output/LPP mark output pin
61	LPPS	O	LPP space output pin
62	CLUMPGT	I	RFAGC input bias circuit clamp setting input pin (pulldown)
63	WBL	O	WBL binary output
64	NC	-	-
65	EQOUTA	O	Equalizer filter output pin 1.
66	EQOUTB	O	Equalizer filter output pin 2.
67	VCC22	PS	Power supply pin for RFEQ/LPP (5.0V)
68	FLTAMP	I	Filter final stage AMP reference voltage stabilization pin.
69	PAD0	I	A/D input pin 0
70	PAD1	I	A/D input pin 1
71	PAD2	I	A/D input pin 2
72	PAD3	I	A/D input pin 3
73	NC	-	-
74	NC-	-	-
75	CWBLHPF1	I	HPF capacitor connection pin for WBLAGC 1.
76	CWBLHPF2	I	HPF capacitor connection pin for WBLAGC 2.
77	NC	-	-

Pin no.	Pin Name	Type	Function
78	RFIN2	I	RFAGC signal input pin 2.
79	RFIN1	I	RFAGC signal input pin 1.
80	HDVREF	O	2.2V reference voltage output pin.
81	CLPPPH	I	Capacitor connection pin for LPP peak hold
82	CLPPHPF	I	Capacitor connection pin for LPPHPF
83	RFOUT	O	RF signal output pin.
84	NC	-	-
85	AIDENV/WBLDIF	O	ASENV binary output/Differential signal output pin for ADIP detection
86	CDRF	I	CD RF signal input pin.
87	RFA	I	DVD RF differential input pin 1.
88	RFB	I	DVD RF differential input pin 2.
89	CWBLBUF	I	Capacitor connection pin for WBLDIF.
90	CWBLCMP	I	Floating Capacitor connection pin for VGA before WBL binary.
91	CRWAGC	I	AGC adjustment capacitor connection pin for +RW.
92	CRWCMP	I	Floating Capacitor connection pin for VGA before WBLDIF AGC.
93	CWBLVGA2	I	Floating Capacitor connection pin for VGA before SRL.
94	CWAGC2	I	AGC adjustment capacitor connection pin 2 for WBL extraction.
95	CWAGC1	I	AGC adjustment capacitor connection pin 1 for WBL extraction.
96	VCC21	PS	-
97	NC	-	-
98	NC	-	-
99	NC	-	-
100	GND2	PS	Power supply pin for RF gene/WBL (5.0V)
101	AIN	I	DVD Tracking input pin 1.
102	BIN	I	DVD Tracking input pin 2.
103	CIN	I	DVD Tracking input pin 3.
104	DIN	I	DVD Tracking input pin 4.
105	VCC6	PS	Power supply pin for DPD (3.3V)
106	EIN	I	CD main signal input pin 1.
107	FIN	I	CD main signal input pin 2.
108	VCC1	PS	Power supply pin for INPUT MATRIX/SERVO (5.0V)
109	GIN	I	CD servo signal input pin 1.
110	HIN	I	CD servo signal input pin 2.
111	GND1	PS	Ground pin for INPUT MATRIX/SERVO/DPD.
112	SVREF	I	OEIC signal reference level input pin.
113	CPCAPH	I	PCA pick hold capacitor connection pin.
114	CPCABH	I	PCA bottom bold capacitor connection pin.
115	NC	I	-
116	VHALF	O	Reference voltage output pin 1/2 VCC (3.3V).
117	CTC2	I	Floating capacitor connection pin for tracking error binary.



Pin no.	Pin Name	Type	Function
118	CTC1	I	Capacitor connection pin for TC HPF.
119	CBDOS	I	Capacitor connection pin for BDO detecting circuit LPF.
120	CBDOF	I	Capacitor connection pin for BDO detecting circuit Pick detection.
121	VCC3	PS	Power supply pin for APC/OPC/ASENV (5.0V).
122	VREF25	O	2.5V reference voltage output pin.
123	VPD	I	DVD front monitor signal input pin.
124	VREFPD	I	Front light system reference level input pin.
125	GND3	PS	Ground pin for APC/OPC/ASENV.
126	PO6	O	Ground CMOS output pin 6.
127	PO5	O	Ground CMOS output pin 5.
128	PO4	O	Ground CMOS output pin 4.

**I : Input pin    O: Output pin    I/O : I/O pin    PS : Power supply/Ground pin    N.C: Non Connection**

## 2. LIC201 (MN103SC7G) : ENCODER, DECODER & DSP SINGAL PROCESSOR

- Pin Assignment

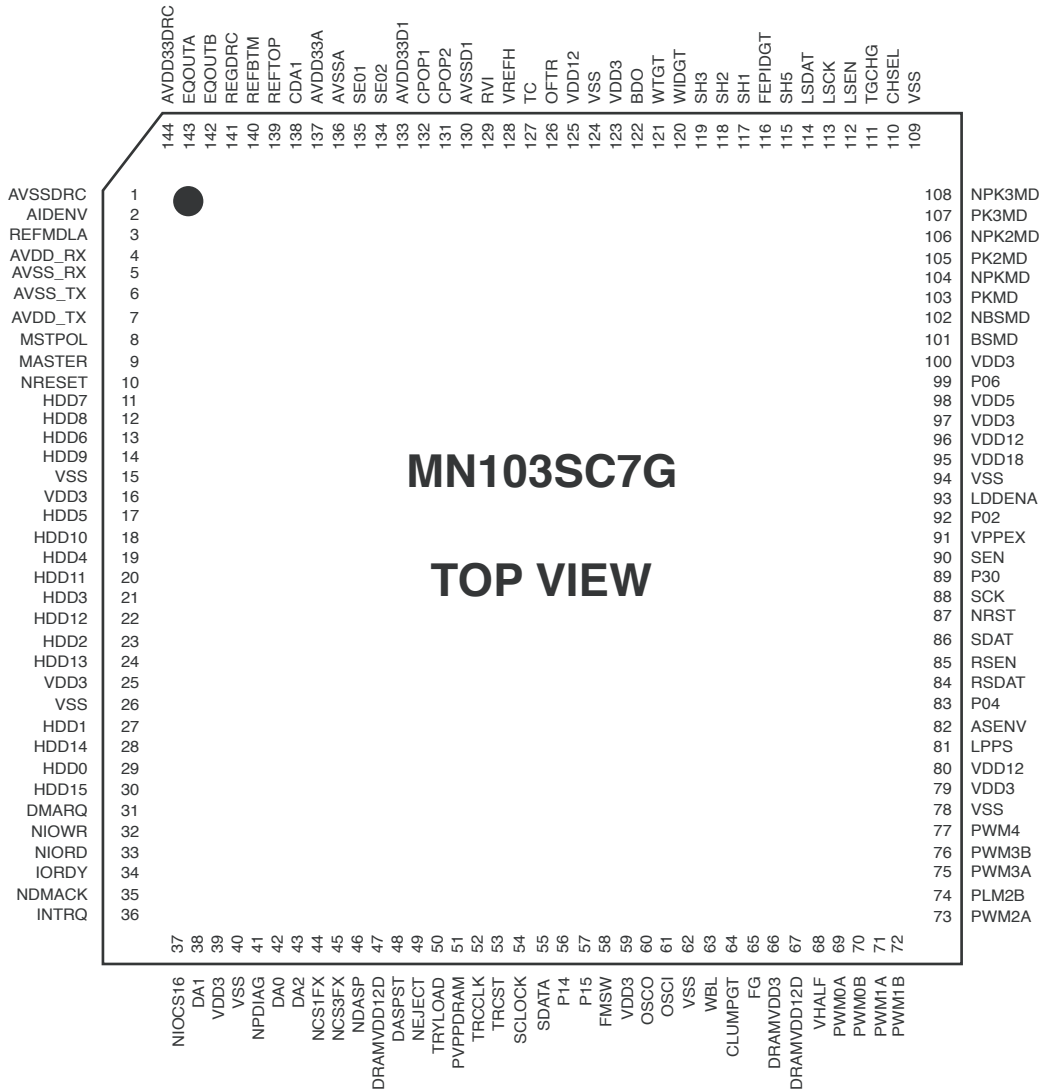

• **Block Diagram (SODC : MN103SC7G)**

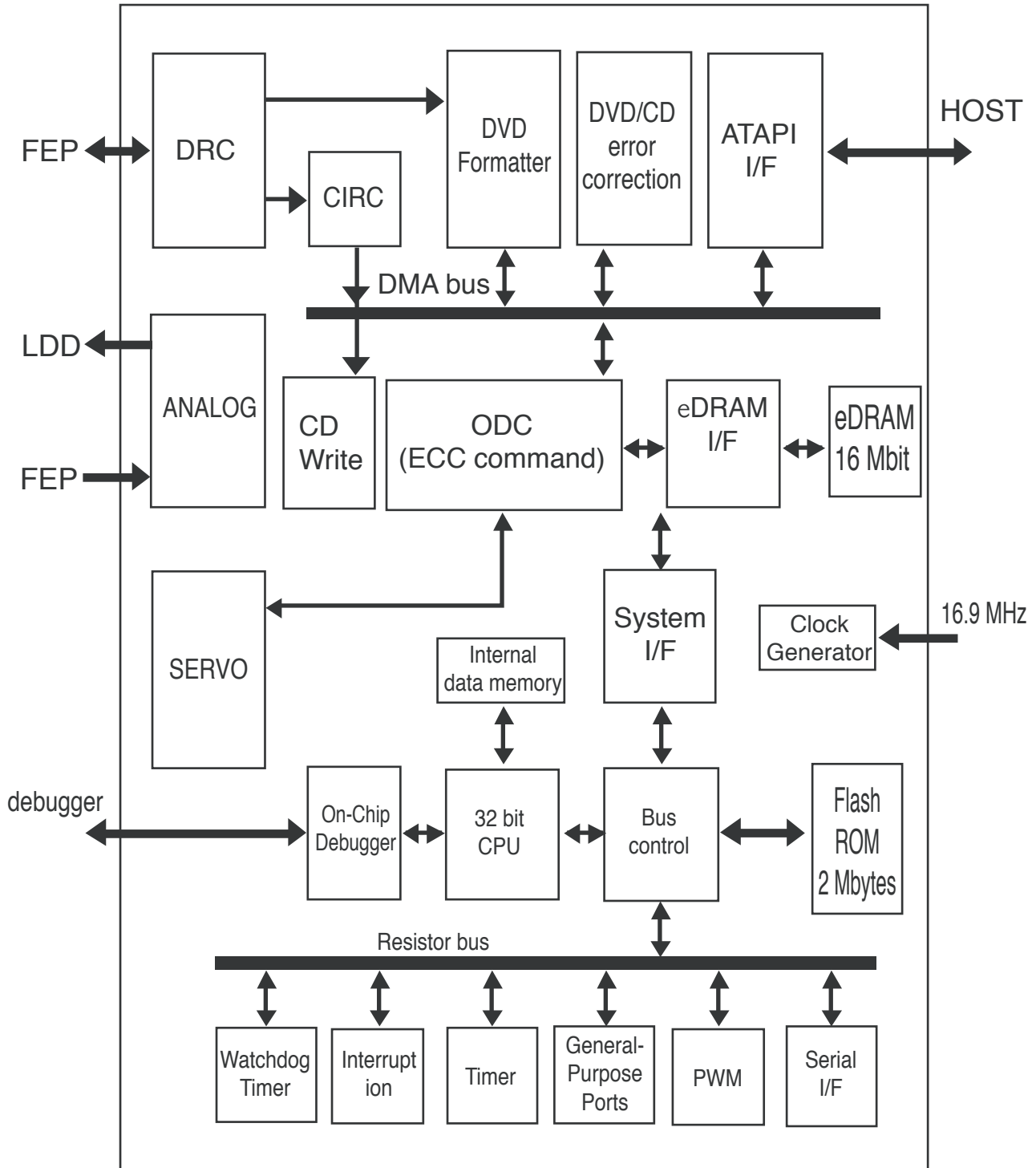

• Pin Table

Pin Number	Pin Name	I/O	Connection Target	Description
1	AVSSDRC	GND	GND	DRC analog Vss
2	AIDENV	I	FEP	TE signal for DVD-RAM
	WBLDIF			ADIP detector signal input
3	REFMDLA	O	Cap	Analog-to-digital converter reference voltage for ADIP
4	AVDD_RX	Power supply	Power supply	Analog power supply (3.3V)
5	AVSS_RX	GND	GND	Analog ground
6	AVSS_TX	GND	GND	Analog ground
7	AVDD_TX	Power supply	Power supply	Analog power supply (3.3V)
8	MSTPOL	I/O	-	MASTER pin polarity switch
	TRCDATA 1		-	Trace data 1
	P17		-	General-purpose I/O (GIO/PWM1)
9	MASTER	I/O	HOST	ATAPI master/slave signal
	P23		-	General-purpose I/O (GIO/TxD0/PWM0)
10	NRESET	I	HOST	ATAPI reset signal
11	HDD7	I/O	HOST	ATAPI data I/O
12	HDD8	I/O	HOST	ATAPI data I/O
13	HDD6	I/O	HOST	ATAPI data I/O
14	HDD9	I/O	HOST	ATAPI data I/O
15	VSS	GND	GND	Digital Vss
16	VDD3	Power supply	Power supply	I/O pad VDD (3.3V)
17	HDD5	I/O	HOST	ATAPI data I/O
18	HDD10	I/O	HOST	ATAPI data I/O
19	HDD4	I/O	HOST	ATAPI data I/O
20	HDD11	I/O	HOST	ATAPI data I/O
21	HDD3	I/O	HOST	ATAPI data I/O
22	HDD12	I/O	HOST	ATAPI data I/O
23	HDD2	I/O	HOST	ATAPI data I/O
24	HDD13	I/O	HOST	ATAPI data I/O
25	VDD3	Power supply	Power supply	I/O pad VDD (3.3V)
26	VSS	GND	GND	Digital Vss
27	HDD1	I/O	HOST	ATAPI data I/O
28	HDD14	I/O	HOST	ATAPI data I/O
29	HDD0	I/O	HOST	ATAPI data I/O
30	HDD15	I/O	HOST	ATAPI data I/O
31	DMARQ	O	HOST	DMA request to ATAPI host
32	NIOWR	I/O	HOST	ATAPI host write signal
33	NIORD	I/O	HOST	ATAPI host read signal
34	IORDY	O	HOST	Ready signal to ATAPI host
35	NDMACK	I	HOST	ATAPI host DMA acknowledge signal

Pin Number	Pin Name	I/O	Connection Target	Description
36	INTRQ	O	HOST	ATAPI Interrupt request to ATAPI host
37	NIOCS16	I/O	HOST	ATAPI host bus width select signal
	P22		-	General-purpose I/O (GIO)
38	DA1	I	HOST	ATAPI host address signal input
39	VDD3	Power supply	Power supply	I/O pad VDD (3.3V)
40	VSS	GND	GND	Digital Vss
41	NPDIAG	I/O	HOST	Diagnostic signal from ATAPI slave to master
42	DA0	I	HOST	ATAPI host address signal
43	DA2	I	HOST	ATAPI host address signal
44	NCS1FX	I	HOST	ATAPI host chip select signal
45	NCS3FX	I	HOST	ATAPI host chip select signal
46	NDASP	I/O	HOST	ATAPI host chip select signal
47	DRAMVDD12D	Power supply	Power supply	DRAM VDD (1.2V)
48	DASPST	I/O	-	DASP setting
	TRCDATA0		-	Trace data 0
	P16		-	General-purpose I/O (GIO/PWM0)
49	NEJECT	I/O	Mecha	Tray eject signal (SODC external interrupt)
	P25		-	General-purpose I/O (GIO)
50	TRYLOAD	I/O	Mecha	Tray eject signal (SODC external interrupt)
	P26		-	General-purpose I/O (GIO)
51	PVPPDRAM	Power supply	Cap	DRAM internal power supply output
52	TRCCLK	I/O	-	Trace clock
	P20		-	General-purpose I/O (GIO/TxD0/PWM0)
53	TRCST	I/O	-	Trace status
	P21		-	General-purpose I/O (GIO/RxT0/PWM1)
54	SCLOCK	I/O	-	Debugger clock
55	SDATA	I/O	-	Debugger data
56	P14	I/O	-	General-purpose I/O(GIO/SerialCLK0/PWM0/external interrupt 3)
	TRCDATA2		-	Trace data 2
	EXTRIG1		-	Trigger 1
57	P15	I/O	-	General-purpose I/O(GIO/RxD0/PWM1/external interrupt 4)
	TRCDATA3		-	Trace data 3
	EXTRIG2		-	Trigger 2
58	FMSW	I/O	PU	Power monitor detector multiplier conversion signal
	P03		-	General-purpose I/O (GIO)
60	OSCO	O	X'tal	Oscillator output
61	OSCI	U	X'tal	Oscillator input (16.9344 MHz)
62	VSS	GND	GND	Digital Vss
63	WBL	I	FEP	Wobble binary signal

Pin Number	Pin Name	I/O	Connection Target	Description
64	CLUMPGT	O	FEP	RF AGC bias circuit clamp signal
65	FG	I	DRIVER	Spindle FG input
66	DRAMVDD3	Power supply	Power supply	DRAM VDD (3.3V)
67	DRAMVDD12D	Power supply	Power supply	DRAM VDD (1.2V)
68	VHALF	I/O	FEP	Drive pin central reference voltage input
69	PWM0A	O	DRIVER	Focus drive differential PWM+ output, focus drive BSDA output.
70	PWM0B	I/O	DRIVER	Focus drive differential PWM- output
	P10		-	General-purpose I/O (GIO/TxD0/SerialCLK0/PMW0)
71	PWM1A	O	DRIVER	Focus 2 (tilt) drive differential PWM+ output, focus 2 drive BSDA output.
72	PWM1B	I/O	DRIVER	Focus 3 (tilt) drive differential PWM-output
	P11			General-purpose I/O (GIO/RxD0/PWM1)
73	PWM2A	I/O	DRIVER	Tracking drive differential PWM+ output, tracking drive BSDA output
	P27			General-purpose I/O (GIO/PWM0)
74	PWM2B	I/O	DRIVER	Tracking drive differential PWM - output
	TX		HOST	IEC60958-compliant digital output
	P12		-	General-purpose I/O (GIO/TxD0)
75	PWM3A	I/O	DRIVER	Traverse drive differential PWM+ output, stepper 1 drive output
	P31		-	General-purpose I/O (GIO/PWM0)
76	PWM3B	I/O	DRIVER	Traverse drive differential PWM- output, stepper 2 drive output
	P31		-	General-purpose I/O (GIO/RxD0/PWM1)
77	PWM4	O	DRIVER	Spindle drive output
78	VSS	GND	GND	Digital Vss
79	VDD3	Power supply	Power supply	I/O pad VDD (3.3V)
80	VDD12	Power supply	Power supply	Internal logic VDD(1.2V)
81	LPPS	I	FEP	LPP space input
82	ASENV	I	FEP	ASENV input
	LPPM			LPP mark input
83	P04	I/O	-	General-purpose I/O (GIO/TxD0/PWM1/external interrupt 1)
	GENE0		Mache	Inner limit switch input
84	RSDAT	I/O	FEP	FEP serial interface data 2 (RF)
85	RSEN	O	FEP	FEP serial interface enable 2 (RF)
86	SDAT	I/O	FEP	FEP serial interface data
87	NRST	I	Reset	IC Reset input (power on reset)
88	VDD3	Power supply	Power supply	I/O pad VDD(3.3)
89	P30	I/O	-	General-purpose I/O (GIO/TxD1)
90	SEN	O	FEP	FEP serial interface enable

Pin Number	Pin Name	I/O	Connection Target	Description
91	VPPEX	Power supply	Power supply	Flash memory power supply Vpp
92	P02	I/O	-	General-purpose I/O (GIO/RxD0/PWM0/external interrupt 0)
	NLDERR		PU	Laser error detection signal
93	LDDENA	O	PU	LDD enable signal
94	VSS	GND	GND	Digital Vss
95	VDD18	Power supply	Power supply	Flash memory power supply Vpp
96	VDD12	Power supply	Power supply	Internal logic VDD (1.2V)
97	VDD3	Power supply	Power supply	I/O pad VDD (1.2V)
98	VDD5	Power supply	Power supply	DRAM VDD (5.0V)
99	P06	I/O	-	General-purpose I/O (GIO/RxD0/PWM1/external interrupt 2)
	HFON		PU	External high frequency module (HFM) ON/OFF
100	VDD3	Power supply	Power supply	I/O pad VDD (1.2V)
101	BSMD	O	PU	BIAS modulation signal differential current output
102	NBSMD	O	PU	NBIAS modulation signal differential current output
103	PKMD	O	PU	PEAK1 modulation signal differential current output
104	NPKMD	O	PU	NPEAK1 modulation signal differential current output
105	PK2MD	O	PU	PEAK2 modulation signal differential current output
106	NPK2MD	O	PU	NPEAK2 modulation signal differential current output
107	PK3MD	I/O	PU	PEAK3 modulation signal differential current output
	SRF1			OEIC gain switching timing adjustment 1 (when using external WTST)
	P00		-	General-purpose I/O (GIO/TxD0/PWM0)
108	NPK3MD	I/O	PU	NPEAK3 modulation signal differential current output
	SRF2			OEIC gain switching timing adjustment 2 (when using external WTST)
	P01		-	General-purpose I/O (GIO/RxD0/PWM1)
109	VSS	GND	GND	Digital Vss
110	CHSEL	I/O	FEP	Serial MPX channel conversion data output signal
	MMOD		-	Test mode selection signal(Do not connect to a pull-up resistor or similar part.)
111	TGCHG	I/O	FEP	Write power switch signal
	P05		-	General-purpose I/O (GIO)
112	LSEN	O	PU	LDD serial interface enable
113	LSCK	O	PU	LDD serial interface clock
114	LSDAT	I/O	PU	LDD serial interface data
115	SH5	I/O	FEP	Write WOBBLE sample and hold sampling signal
116	FEPIDGT	I/O	FEP	CAPA punch out signal
	SH6			Servo S/H sample signal
	P07		-	General-purpose I/O (GIO/SerialCLK1)

Pin Number	Pin Name	I/O	Connection Target	Description
117	SH1	I/O	FEP	Sample timing signal for ROPC space detection, APC space detection, and read power detection
118	SH2	I/O	FEP	Sample timing signal for PCA peak, bottom detection, APC peak detection, and mean valuer detection
119	SH3	I/O	FEP	Sample timing signal for PCA mean value detection, APC space detection, and read power detection, and erase detection
120	WIDGT	I/O	FEP	VFO punch out signal
	SH4			ROPC mark detection sampling signal
	P24		-	General-purpose I/O (GIO/TxD1)
121	WTGT	O	FEP	Write gate
122	BDO	I	FEP	Dropout signal input
123	VDD3	Power supply	Power supply	I/O pad VDD (3.3V)
124	VSS	GND	GND	Digital Vss
125	VDD12	Power supply	Power supply	Internal logic VDD (1.2V)
126	OFTR	I	FEP	Off track signal input
127	TC	I	FEP	Track crossing signal input
128	VREFH	I	FEP	2.2V reference voltage input
129	RVI	I/O	Res.	Fixed current source for LVDS, WBL, and analog blocks
130	AVSSD1	GND	GND	WOBBLE analog Vss
131	CPOP2	I/O	Cap. Res.	Filter connection pin for wobble PLL
132	CPOP1	I/O	Cap. Res.	Filter connection pin for wobble PLL
133	AVDD33DI	Power supply	Power supply	WOBBLE analog VDD (3.3V)
134	SE02	I	FEP	Error signal output after selection, analog input
135	SE01	I	FEP E	rror signal output after selection, analog input
136	AVSSA	GND	GND	Servo analog-to-digital converter analog Vss
137	AVDD33A	Power supply	Power supply	Servo analog-to-digital converter analog VDD (3.3V)
138	CDA1	O	Cap	Smoothing capacitance for DRC-VCO
139	REFTOP	O	Cap	Analog-to-digital converter reference voltage for DRC (TOP)
140	REFBTM	O	Cap	Analog-to-digital converter reference voltage for DRC (BOTTOM)
141	REGDRC	O	Cap	DRC analog-to-digital converter analog VDD (1.2V) Internal regurator output
142	EQOUTB	I	FEP	RF differential signal (NEG)
143	EQOUTA	I	FEP	RF differential signal (POS)
144	AVDD33DRC	Power supply	Power supply	DRC analog-to-digital converter analog VDD (3.3 V)



### 3. LIC301 (BD7776ARFS) : CD-ROM/DVD-ROM 7CH POWER DRIVER

- Block Diagram

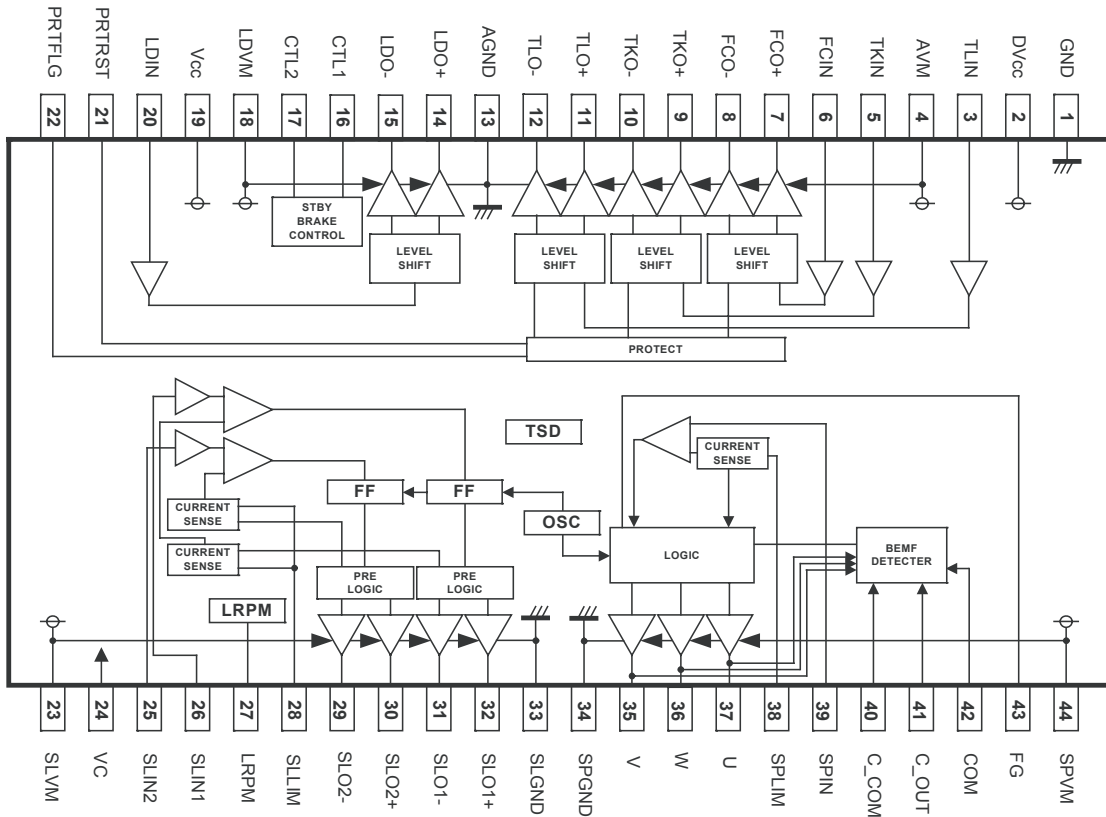

- Pin Function

No	Pin name	Description	No	Pin name	Description
1	GND	GND	23	SLVM	Motor driver power supply
2	DVcc	PWM block control power supply	24	VC	Reference voltage input
3	TLIN	Tilt motor driver input	25	SLIN2	Motor driver input2
4	AVM	Actuator driver block power supply	26	SLIN1	Motor driver input1
5	TKIN	Tracking driver input	27	LRPM	Low speed rotational motor transfer terminal
6	FCIN	Focus driver input	28	SLLIM	Input terminal for slide current limit
7	FCO+	Focus driver inverted output	29	SLO2-	Motor driver 2 non-inverted output
8	FCO-	Focus driver non-inverted output	30	SLO2+	Motor driver 2 inverted output
9	TKO+	Tilt driver inverted output	31	SLO1-	Motor driver 1 non-inverted output
10	TKO-	Tilt driver non-inverted output	32	SLO1+	Motor driver 1 inverted output
11	TLO+	Tracking driver inverted output	33	SLGND	Motor driver power supply GND
12	TLO-	Tracking driver non-inverted output	34	SPGND	Spindle driver power supply GND
13	AGND	BTL driver GND	35	V	Spindle driver output V
14	LDO+	Loading driver inverted output	36	W	Spindle driver output W
15	LDO-	Loading driver non-inverted output	37	U	Spindle driver output U
16	CTL1	Loading driver control input	38	SPLIM	Input terminal for spindle current limit
17	CTL2	Loading driver control input	39	SPIN	Spindle control voltage input
18	LDVM	Loading driver power supply	40	C_COM	Condenser connection terminal (com)
19	Vcc	Power supply	41	C_OUT	Condenser connection terminal (OUT)
20	LDIN	Loading driver input	42	COM	Motor coil input terminal
21	PRTRST	Protect input	43	FG	FG signal output
22	PRTFLG	Protect flag output	44	SPVM	Spindle driver Power supply

# BLOCK DIAGRAM

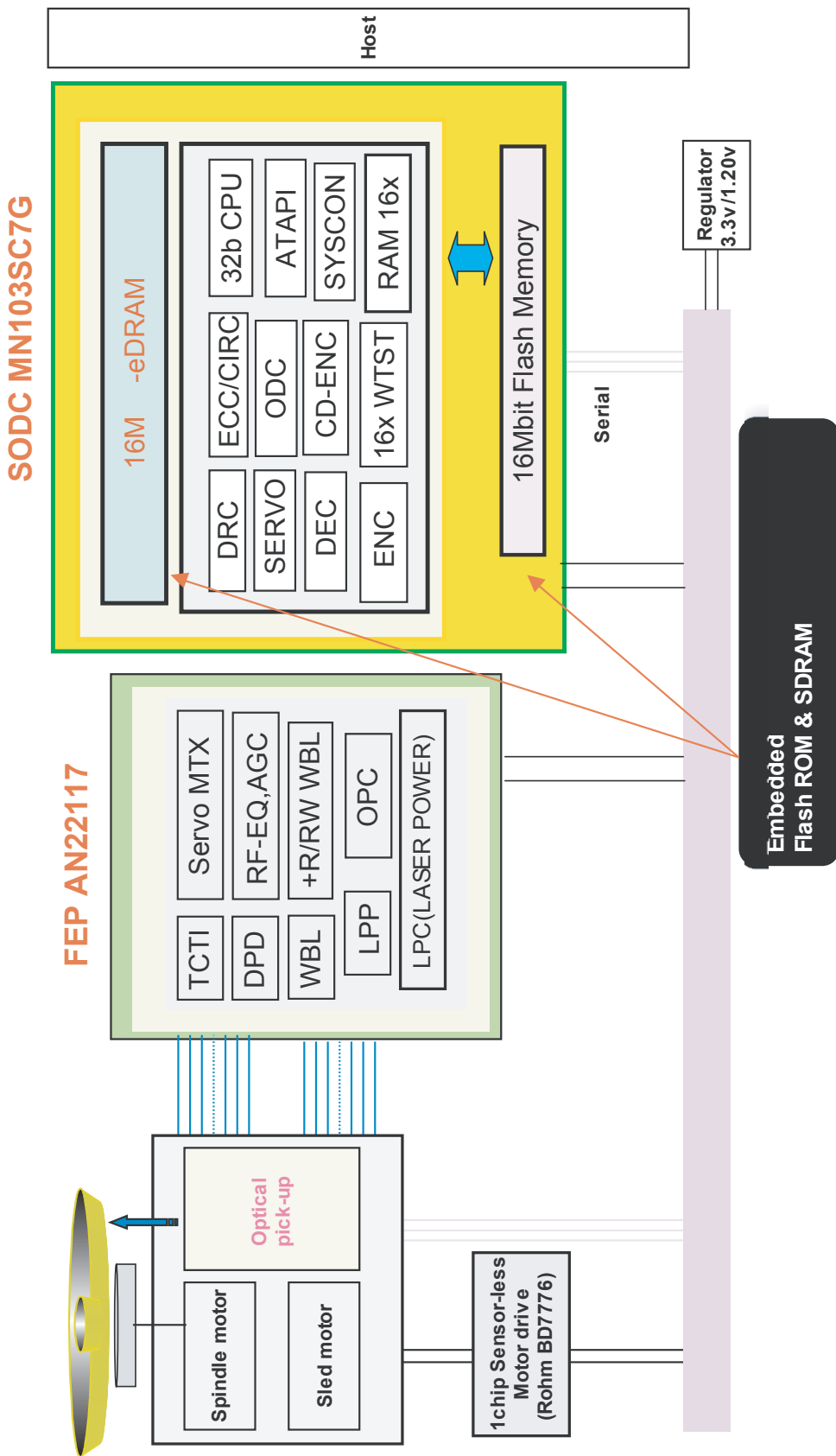

# MEMO

A series of horizontal dotted lines spanning the width of the page, intended for writing a memo.

# CIRCUIT DIAGRAM

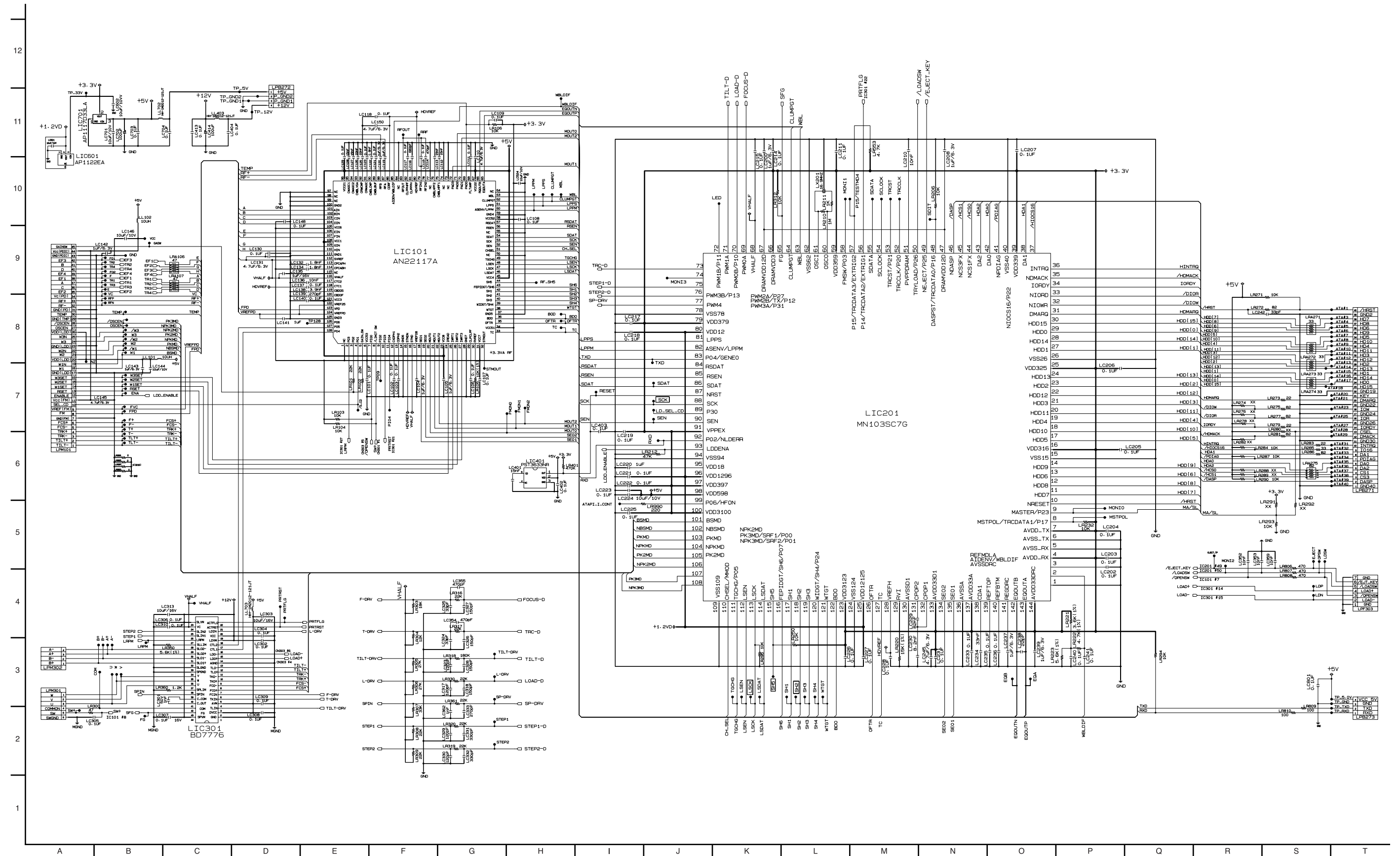

# CIRCUIT VOLTAGE CHART

PIN NO.	VOLTAGE
<b>LIC101</b>	
1	3.32
2	0.00
3	0.00
4	0.00
5	0.00
6	3.32
7	0.00
8	3.21
9	3.32
10	0.00
11	0.00
12	3.32
13	3.51
14	0.00
15	2.22
16	1.67
17	0.82
18	2.09
19	1.60
20	0.85
21	0.82
22	0.65
23	4.97
24	0.00
25	0.00
26	0.00
27	0.00
28	0.00
29	0.00
30	1.00
31	3.32
32	0.00
33	3.32
34	3.32
35	0.00
36	0.00
37	0.00
38	0.00
39	0.00
40	0.00
41	0.00
42	0.00
43	0.00
44	0
45	4.97
46	pulse
47	pulse
48	pulse
49	3.31
50	0.00
51	pulse
52	pulse

PIN NO.	VOLTAGE
53	pulse
54	pulse
55	0.00
56	pulse
57	pulse
58	3.32
59	0.00
60	3.32
61	3.32
62	0.00
63	0.00
64	0.00
65	2.04
66	2.04
67	4.97
68	2.21
69	1.20
70	0.65
71	0.85
72	0.82
73	0.00
74	0.00
75	0.00
76	0.00
77	0.00
78	0.00
79	2.18
80	2.22
81	0.00
82	2.20
83	2.22
84	0.00
85	0.00
86	2.22
87	2.18
88	2.18
89	0.00
90	2.23
91	1.62
92	1.58
93	1.59
94	0.00
95	0.00
96	4.97
97	0.00
98	0.00
99	0.00
100	0.00
101	1.80
102	1.78
103	1.77
104	1.80
105	3.32

PIN NO.	VOLTAGE
106	1.76
107	1.73
108	4.97
109	1.74
110	1.75
111	0.00
112	1.67
113	0.00
114	0.00
115	0.00
116	1.67
117	2.28
118	2.21
119	3.08
120	4.10
121	4.97
122	2.51
123	2.49
124	2.51
125	0.00
126	0.00
127	3.28
128	3.28
<b>LIC201</b>	
1	0.00
2	2.00
3	3.31
4	3.31
5	0.00
6	0.00
7	3.31
8	3.30
9	0.00
10	3.30
11	pulse
12	pulse
13	pulse
14	pulse
15	0.00
16	3.29
17	pulse
18	pulse
19	pulse
20	pulse
21	pulse
22	pulse
23	pulse
24	pulse
25	3.28
26	0.00
27	pulse
28	pulse
29	pulse

PIN NO.	VOLTAGE
30	pulse
31	pulse
32	pulse
33	pulse
34	pulse
35	pulse
36	pulse
37	4.94
38	3.27
39	3.28
40	0.00
41	4.95
42	3.27
43	3.27
44	pulse
45	3.27
46	4.94
47	1.18
48	0.00
49	3.28
50	0.00
51	2.63
52	0.00
53	0.00
54	3.27
55	3.27
56	0.00
57	3.28
58	0.00
59	3.29
60	OSC
61	OSC
62	0.00
63	0.00
64	0.00
65	pulse
66	3.29
67	1.19
68	1.65
69	1.63
70	1.64
71	1.64
72	0.00
73	1.64
74	0.00
75	1.66
76	1.97
77	1.85
78	0.00
79	3.29
80	1.20
81	3.33
82	3.33

PIN NO.	VOLTAGE
83	3.33
84	pulse
85	pulse
86	pulse
87	3.17
88	pulse
89	0.00
90	pulse
91	3.33
92	3.32
93	3.32
94	0.00
95	1.80
96	1.19
97	3.27
98	4.94
99	3.30
100	3.28
101	1.39
102	1.00
103	1.39
104	1.00
105	1.39
106	0.98
107	1.00
108	1.40
109	0.00
110	pulse
111	3.31
112	pulse
113	pulse
114	pulse
115	3.31
116	0.00
117	0.00
118	0.00
119	0.00
120	0.00
121	0.00
122	0.00
123	3.28
124	0.00
125	1.19
126	0.00
127	3.28
128	2.21
129	1.50
130	0.00
131	0.00
132	0.00
133	3.31
134	1.60
135	2.08

PIN NO.	VOLTAGE
136	0.00
137	3.31
138	0.83
139	2.27
140	1.76
141	1.26
142	2.00
143	2.00
144	3.30
<b>LIC301</b>	
1	0.00
2	4.88
3	1.65
4	4.88
5	1.65
6	1.65
7	2.45
8	2.54
9	2.45
10	2.54
11	2.48
12	2.49
13	0.00
14	6.00
15	6.00
16	3.26
17	3.26
18	12.50
19	12.50
20	1.65
21	0.00
22	0.00
23	12.50
24	1.66
25	1.70
26	1.71
27	0.00
28	1.17
29	12.50
30	12.50
31	12.50
32	12.50
33	0.00
34	0.00
35	PULSE
36	PULSE
37	PULSE
38	1.12
39	1.76
40	PULSE
41	PULSE
42	PULSE
43	PULSE

PIN NO.	VOLTAGE
<b>LIC601</b>	
1.GND	0.00
2.VOUT	1.20
3.VIN	3.30
<b>LIC701</b>	
1.GND	0.00
2.VOUT	3.30
3.VIN	4.95

# PRINTED CIRCUIT BOARD DIAGRAMS

## 1. MAIN P.C.BOARD (TOP VIEW)

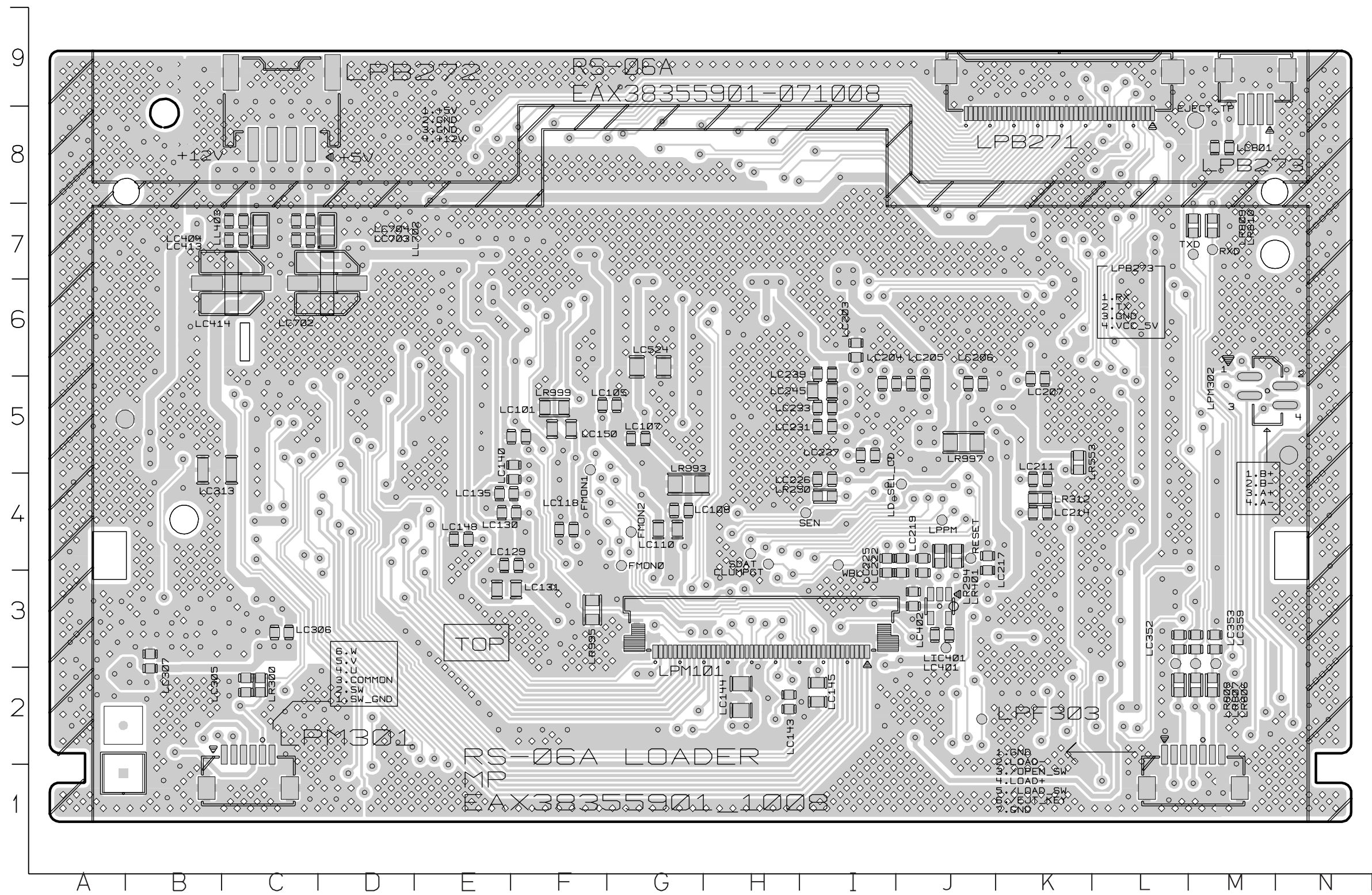

## 2. MAIN P.C.BOARD (BOTTOM VIEW)

