

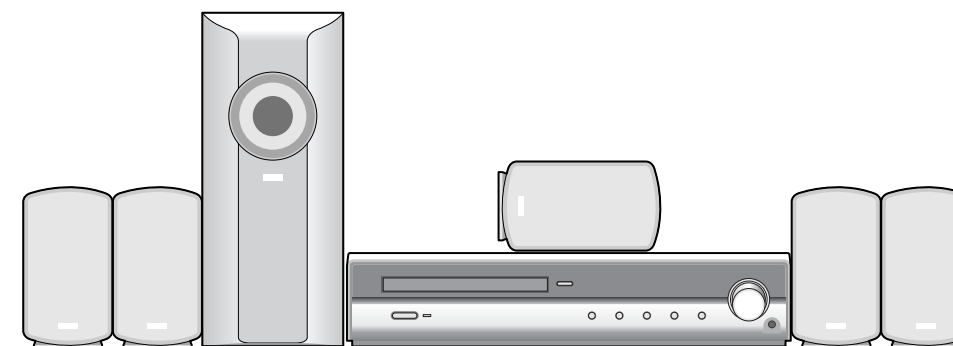

SERVICE MANUAL MODEL:LH-D6245A LHS-D6245T, LHS-D6245W



DVD/CD RECEIVER SERVICE MANUAL



**MODEL:LH-D6245A
LHS-D6245T, LHS-D6245W**

[CONTENTS]

○ SECTION 1. GENERAL

- SERVICING PRECAUTIONS 1-2
- ESD PRECAUTIONS 1-4
- SPECIFICATIONS 1-5
- LOCATION OF CUSTOMER CONTROLS 1-6

○ SECTION 2. AUDIO PART

- AUDIO TROUBLESHOOTING GUIDE 2-1
- BLOCK DIAGRAM 2-5
- SCHEMATIC DIAGRAMS 2-7
- WIRING DIAGRAM 2-17
- PRINTED CIRCUIT DIAGRAMS 2-19

○ SECTION 3. DVD PART

- ELECTRICAL TROUBLESHOOTING GUIDE 3-1
- DETAILS AND WAVEFORMS ON SYSTEM TEST AND DEBUGGING 3-8
- DVD PART SCHEMATIC DIAGRAMS 3-21
- VOLTAGE SHEET ((IC & TR) 3-27
- PRINTED CIRCUIT DIAGRAM 3-29

○ SECTION 4. EXPLODED VIEWS 4-1

○ SECTION 5. SPEAKER PART 5-1

○ SECTION 6. REPLACEMENT PARTS LIST 6-1

SECTION 1. GENERAL

□ SERVICING PRECAUTIONS

NOTES REGARDING HANDLING OF THE PICK-UP

1. Notes for transport and storage

- 1) The pick-up should always be left in its conductive bag until immediately prior to use.
- 2) The pick-up should never be subjected to external pressure or impact.

Storage in conductive bag

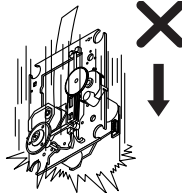
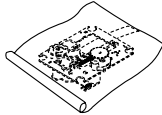

Drop impact

2. Repair notes

- 1) The pick-up incorporates a strong magnet, and so should never be brought close to magnetic materials.
- 2) The pick-up should always be handled correctly and carefully, taking care to avoid external pressure and impact. If it is subjected to strong pressure or impact, the result may be an operational malfunction and/or damage to the printed-circuit board.
- 3) Each and every pick-up is already individually adjusted to a high degree of precision, and for that reason the adjustment point and installation screws should absolutely never be touched.
- 4) Laser beams may damage the eyes!
Absolutely never permit laser beams to enter the eyes!
Also NEVER switch ON the power to the laser output part (lens, etc.) of the pick-up if it is damaged.

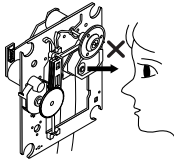

NEVER look directly at the laser beam, and don't let contact fingers or other exposed skin.

5) Cleaning the lens surface

If there is dust on the lens surface, the dust should be cleaned away by using an air bush (such as used for camera lens). The lens is held by a delicate spring. When cleaning the lens surface, therefore, a cotton swab should be used, taking care not to distort this.

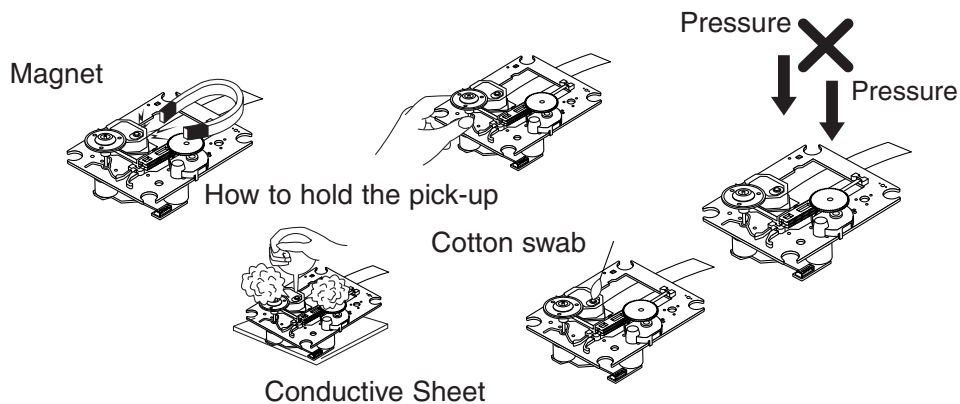

6) Never attempt to disassemble the pick-up.

Spring by excess pressure. If the lens is extremely dirty, apply isopropyl alcohol to the cotton swab. (Do not use any other liquid cleaners, because they will damage the lens.) Take care not to use too much of this alcohol on the swab, and do not allow the alcohol to get inside the pick-up.

NOTES REGARDING COMPACT DISC PLAYER REPAIRS

1. Preparations

- 1) Compact disc players incorporate a great many ICs as well as the pick-up (laser diode). These components are sensitive to, and easily affected by, static electricity. If such static electricity is high voltage, components can be damaged, and for that reason components should be handled with care.
- 2) The pick-up is composed of many optical components and other high-precision components. Care must be taken, therefore, to avoid repair or storage where the temperature or humidity is high, where strong magnetism is present, or where there is excessive dust.

2. Notes for repair

- 1) Before replacing a component part, first disconnect the power supply lead wire from the unit
- 2) All equipment, measuring instruments and tools must be grounded.
- 3) The workbench should be covered with a conductive sheet and grounded.
When removing the laser pick-up from its conductive bag, do not place the pick-up on the bag. (This is because there is the possibility of damage by static electricity.)
- 4) To prevent AC leakage, the metal part of the soldering iron should be grounded.
- 5) Workers should be grounded by an armband (1M Ω)
- 6) Care should be taken not to permit the laser pick-up to come in contact with clothing, in order to prevent static electricity changes in the clothing to escape from the armband.
- 7) The laser beam from the pick-up should NEVER be directly facing the eyes or bare skin.

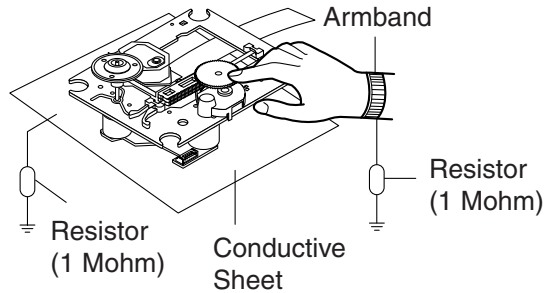

□ ESD PRECAUTIONS

Electrostatically Sensitive Devices (ESD)

Some semiconductor (solid state) devices can be damaged easily by static electricity. Such components commonly are called Electrostatically Sensitive Devices (ESD). Examples of typical ESD devices are integrated circuits and some field-effect transistors and semiconductor chip components. The following techniques should be used to help reduce the incidence of component damage caused by static electricity.

1. Immediately before handling any semiconductor component or semiconductor-equipped assembly, drain off any electrostatic charge on your body by touching a known earth ground. Alternatively, obtain and wear a commercially available discharging wrist strap device, which should be removed for potential shock reasons prior to applying power to the unit under test.
2. After removing an electrical assembly equipped with ESD devices, place the assembly on a conductive surface such as aluminum foil, to prevent electrostatic charge buildup or exposure of the assembly.
3. Use only a grounded-tip soldering iron to solder or unsolder ESD devices.
4. Use only an anti-static solder removal device. Some solder removal devices not classified as "anti-static" can generate electrical charges sufficient to damage ESD devices.
5. Do not use freon-propelled chemicals. These can generate electrical charges sufficient to damage ESD devices.
6. Do not remove a replacement ESD device from its protective package until immediately before you are ready to install it. (Most replacement ESD devices are packaged with leads electrically shorted together by conductive foam, aluminum foil or comparable conductive materials).
7. Immediately before removing the protective material from the leads of a replacement ESD device, touch the protective material to the chassis or circuit assembly into which the device will be installed.

CAUTION : BE SURE NO POWER IS APPLIED TO THE CHASSIS OR CIRCUIT, AND OBSERVE ALL OTHER SAFETY PRECAUTIONS.

8. Minimize bodily motions when handling unpackaged replacement ESD devices. (Otherwise harmless motion such as the brushing together of your clothes fabric or the lifting of your foot from a carpeted floor can generate static electricity sufficient to damage an ESD device).

CAUTION. GRAPHIC SYMBOLS



THE LIGHTNING FLASH WITH APROWHEAD SYMBOL. WITHIN AN EQUILATERAL TRIANGLE, IS INTENDED TO ALERT THE SERVICE PERSONNEL TO THE PRESENCE OF UNINSULATED "DANGEROUS VOLTAGE" THAT MAY BE OF SUFFICIENT MAGNITUDE TO CONSTITUTE A RISK OF ELECTRIC SHOCK.



THE EXCLAMATION POINT WITHIN AN EQUILATERAL TRIANGLE IS INTENDED TO ALERT THE SERVICE PERSONNEL TO THE PRESENCE OF IMPORTANT SAFETY INFORMATION IN SERVICE LITERATURE.

□ SPECIFICATIONS

[General]	Power supply	Refer to main label		
	Power consumption	Refer to main label		
	Mass	3.8 kg		
	External dimensions (W x H x D)	360 x 75 x 314 mm		
	Operating conditions	Temperature: 5°C to 35°C, Operation status: Horizontal		
	Operating humidity	5% to 85%		
[CD/DVD]	Laser	Semiconductor laser, wavelength 650 nm		
	Signal system	NTSC 525/60		
	Frequency response (audio)	200 Hz to 18 kHz		
	Signal-to-noise ratio (audio)	More than 70 dB (1 kHz, NOP, 20 kHz LPF/A-Filter)		
	Dynamic range (audio)	More than 65 dB		
	Harmonic distortion (audio)	1.0 % (1 kHz, at 12W position) (20 kHz LPF/A-Filter)		
[Video]	Video output	1.0 V (p-p), 75Ω, negative sync., RCA jack		
	S-video output	(Y) 1.0 V (p-p), 75Ω, negative sync., Mini DIN 4-pin x 1 (C) 0.3 V (p-p), 75Ω		
[Tuner]	[FM]	Tuning Range	87.5 - 108.0 MHz or 65.0 - 74.0 MHz, 87.5 - 108.0 MHz	
		Intermediate Frequency	10.7 MHz	
		Signal-to Noise Ratio	55 dB (Mono)	
	[AM [MW]]	Frequency Response	180 - 10,000 Hz	
		Tuning Range	522 - 1,611 kHz or 530 - 1,610 kHz	
		Intermediate Frequency	450 kHz	
[Amplifier]	Stereo mode	30W + 30W (6Ω at 1 kHz, THD 10 %)		
	Surround mode (* Depending on the sound mode settings and the source, there may be no sound output.)	Front: 30W + 30W (THD 10 %) Center*: 30W Surround*: 30W + 30W (6Ω at 1 kHz, THD 10 %) Subwoofer*: 50W (8Ω at 30 Hz, THD 10 %)		
	Outputs	S-VIDEO MONITOR PHONES: (32Ω, 20mW)		
[Speakers]		Satellite Speaker (LHS-D6245T)	Passive Subwoofer (LHS-D6245W)	
	Type	1 Way 1 Speaker	1 Way 1 Speaker	
	Impedance	6Ω	8Ω	
	Frequency Response	130 - 20,000 Hz	50 - 1,500 Hz	
	Sound Pressure Level	85 dB/W (1m)	82 dB/W (1m)	
	Rated Input Power	25W	60W	
	Max. Input Power	50W	120W	
	Net Dimensions (W x H x D)	90 x 138.5 x 100 mm	160 x 350 x 345 mm	
Net Weight	0.89 kg	4.5 kg		
[Supplied Accessories]	Speakers	6	Speaker cables	5
	Remote control	1	Batteries (AAA)	2
	AM loop antenna	1	FM antenna	1
	SCART-RCA Adapter	1	Video cable	1

Designs and specifications are subject to change without notice.

LOCATION OF CUSTOMER CONTROLS

FRONT PANEL

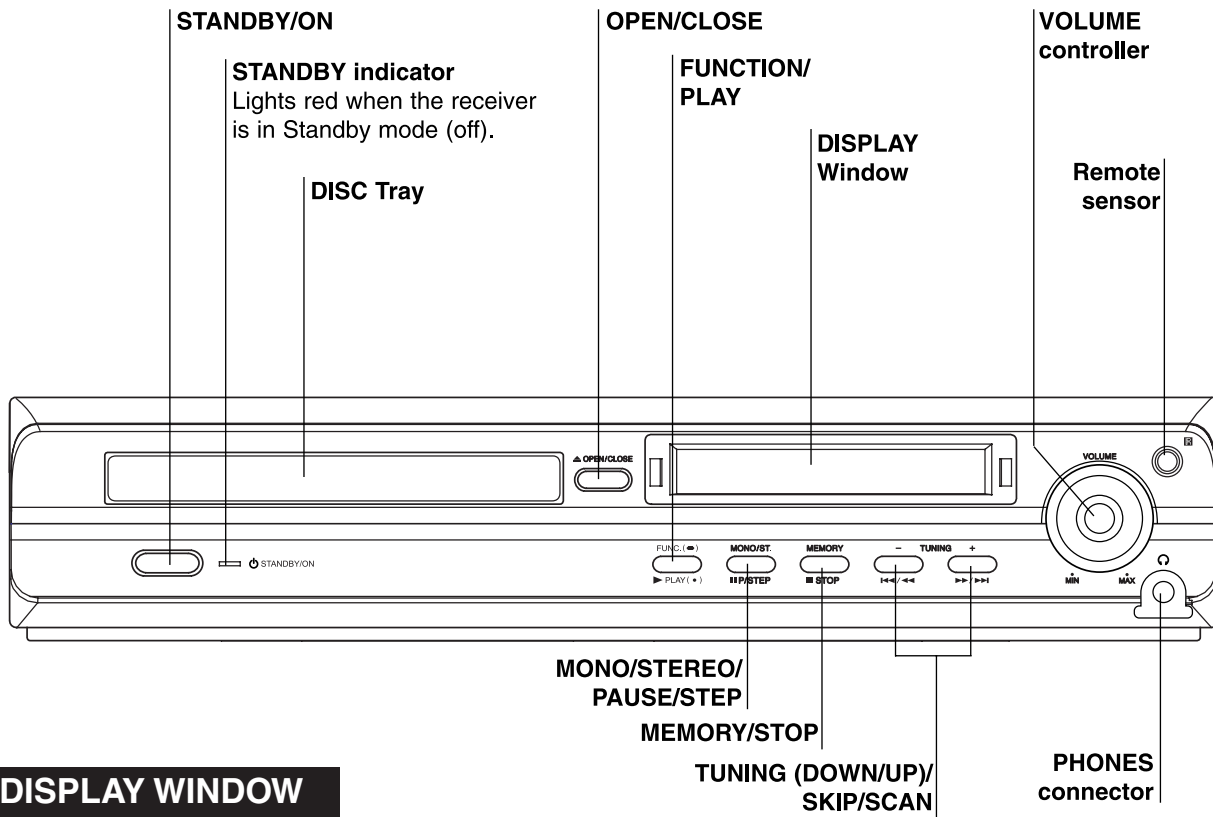

DISPLAY WINDOW

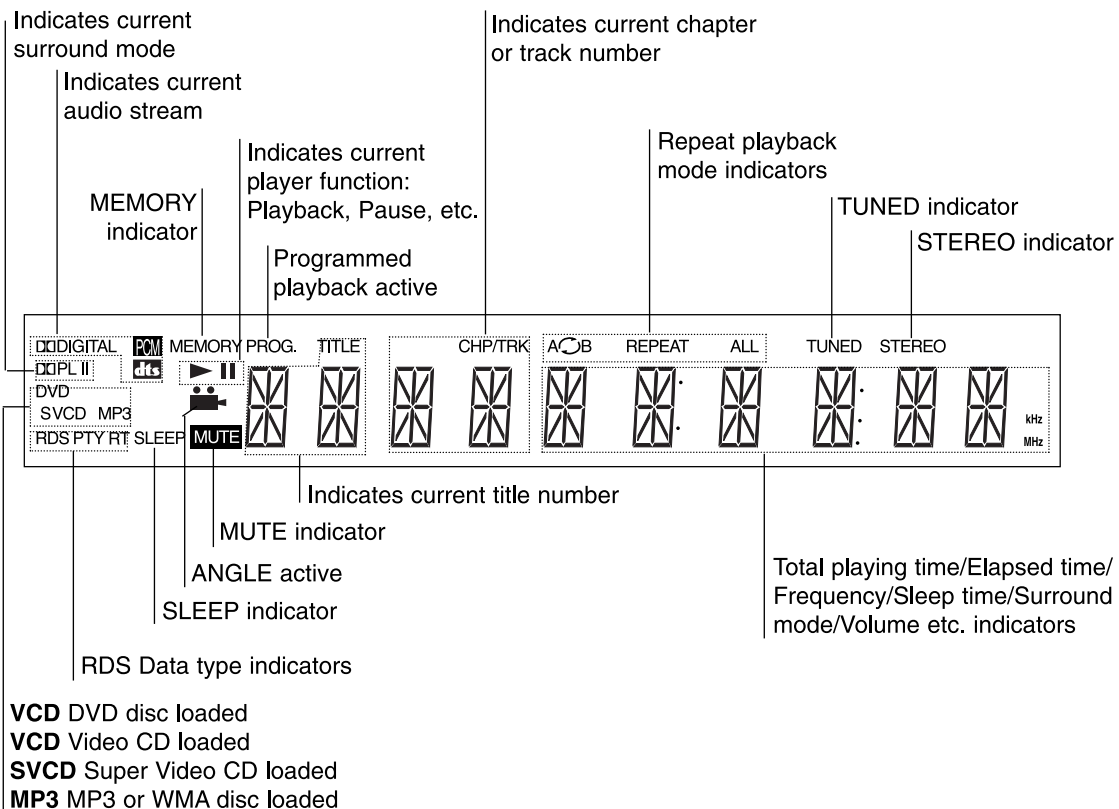

REAR PANEL

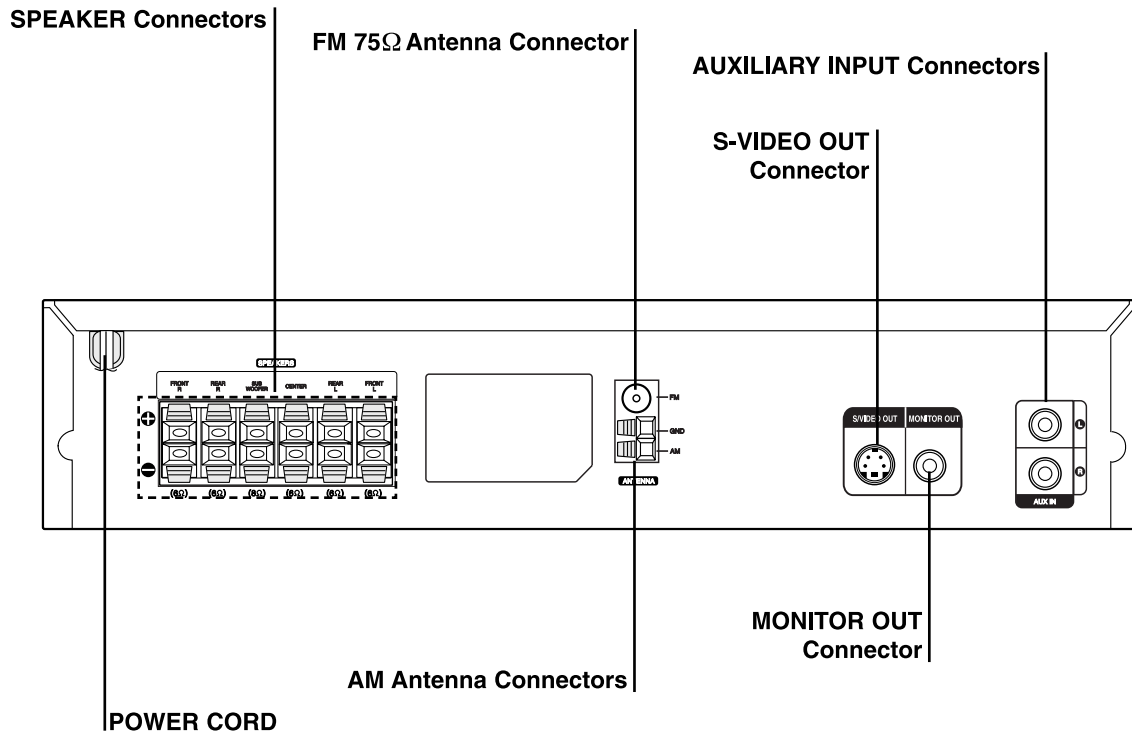

Do not touch the inner pins of the jacks on the rear panel. Electrostatic discharge may cause permanent damage to the unit.

Remote Control

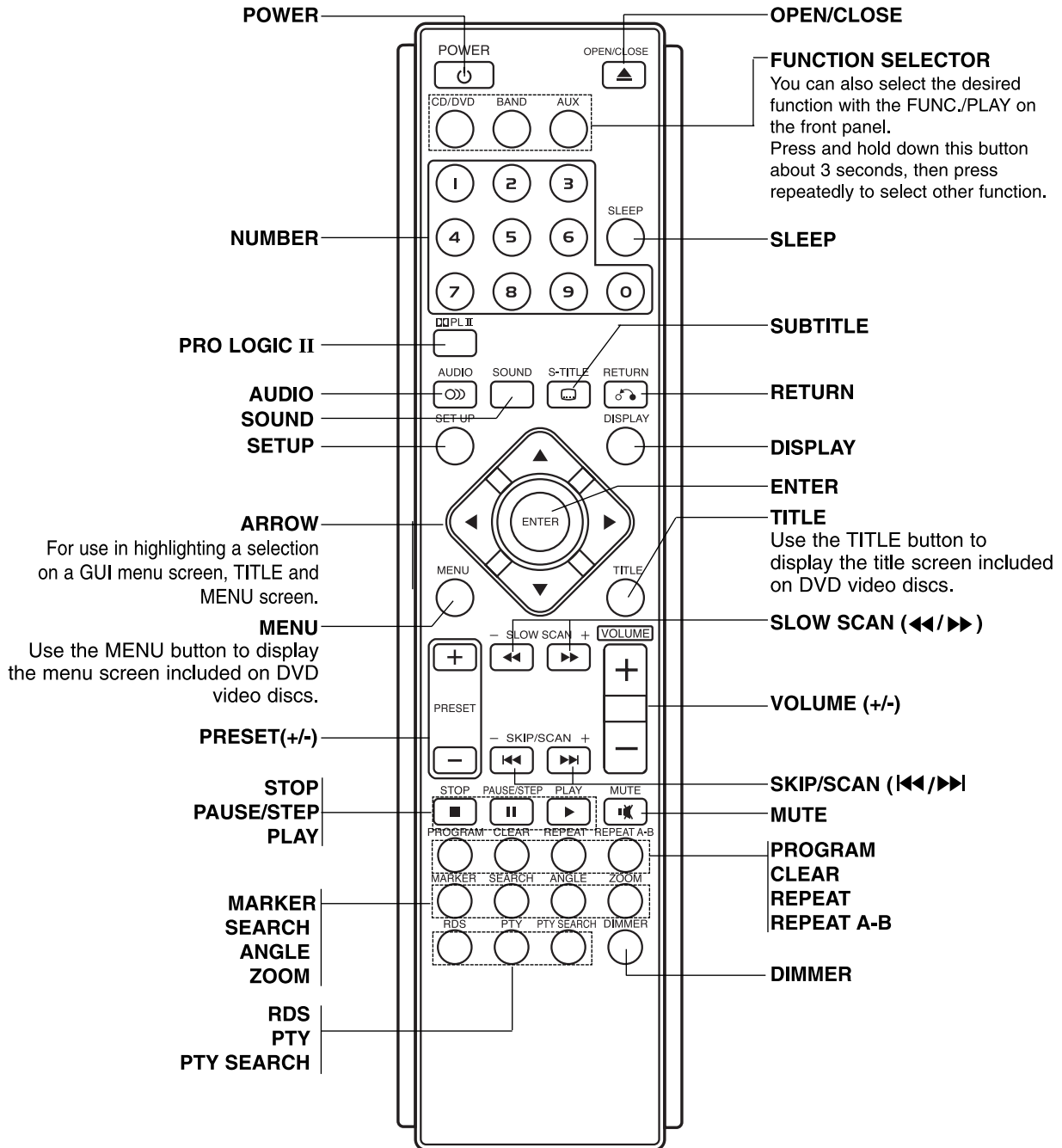

Remote Control Operation Range

Point the remote control at the remote sensor and press the buttons.

- **Distance:** About 23 ft (7 m) from the front of the remote sensor
- **Angle:** About 30° in each direction in front of the remote sensor

Remote control battery installation

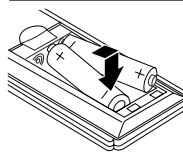

Remove the battery cover on the rear of the remote control, and insert two R03 (size AAA) batteries with ⊕ and ⊖ aligned correctly.

⚠ Caution

Do not mix old and new batteries. Never mix different types of batteries (standard, alkaline, etc.).

SECTION 2. AUDIO PART

□ AUDIO TROUBLESHOOTING GUIDE

1. POWER SUPPUY CIRCUIT

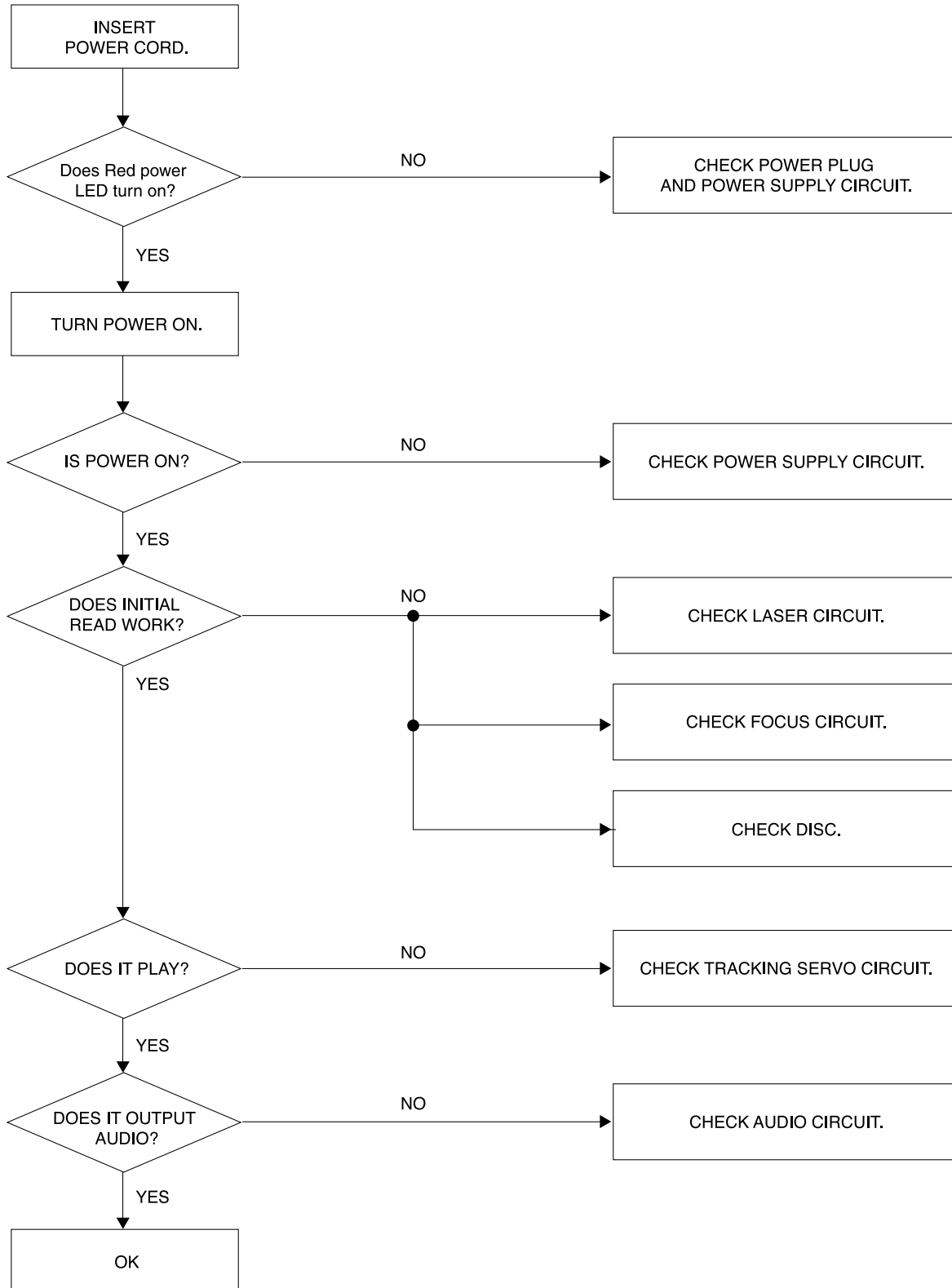

2. FRONT CIRCUIT (1/2)

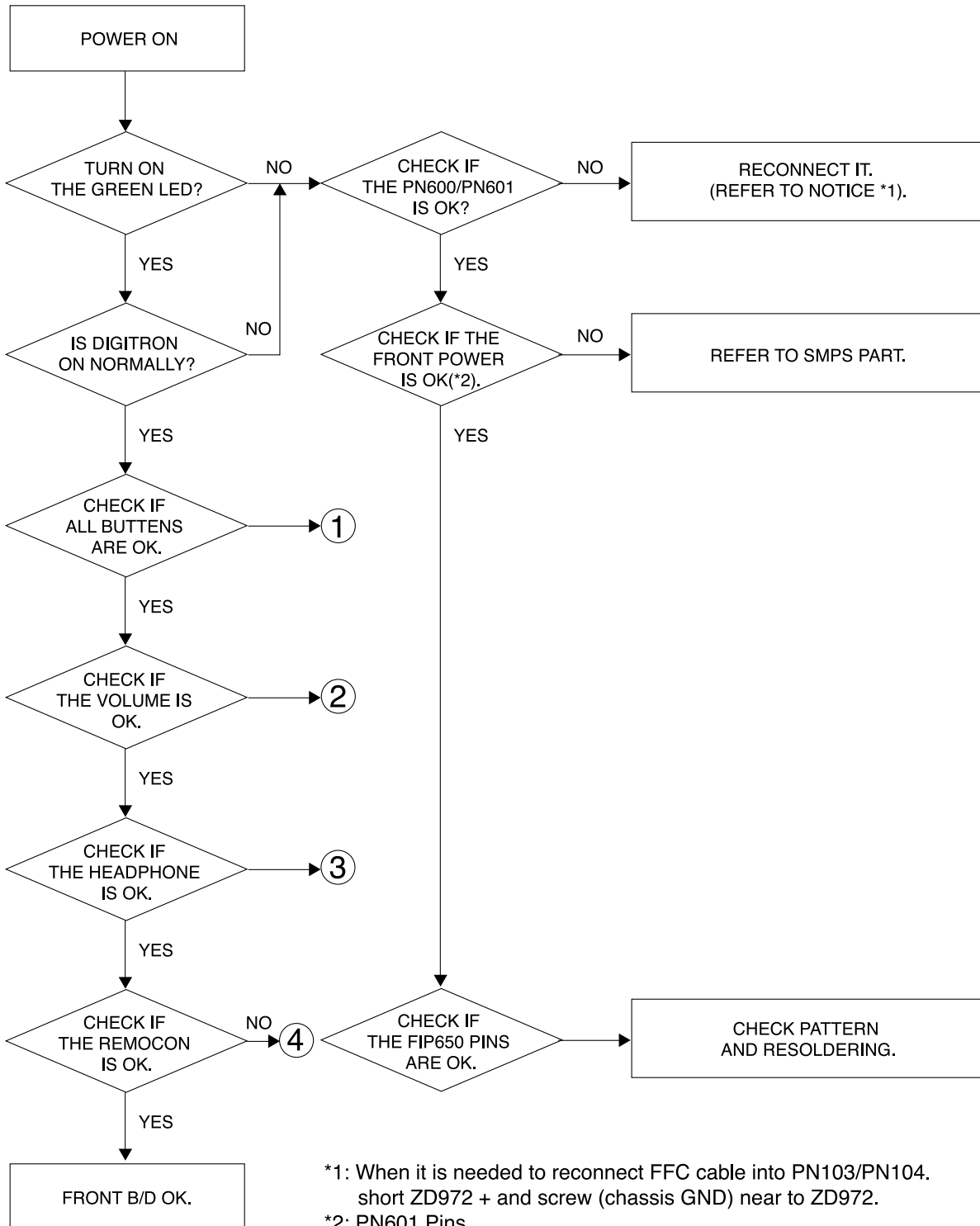

*1: When it is needed to reconnect FFC cable into PN103/PN104. short ZD972 + and screw (chassis GND) near to ZD972.

*2: PN601 Pins

PIN1 : 1.9V
 PIN2 : -23.0V
 PIN3 : -27.5V
 PIN4 : 5.0V
 PIN11 : -34.0V

3. FRONT CIRCUIT (2/2)

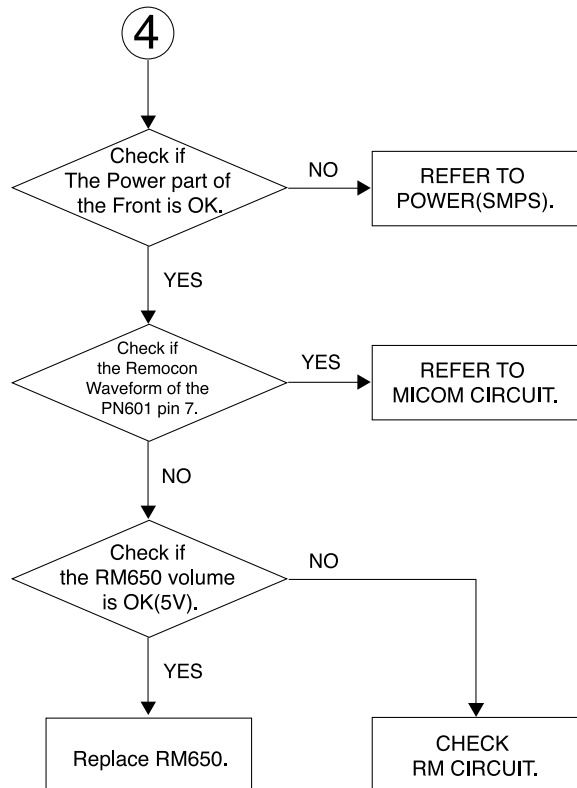
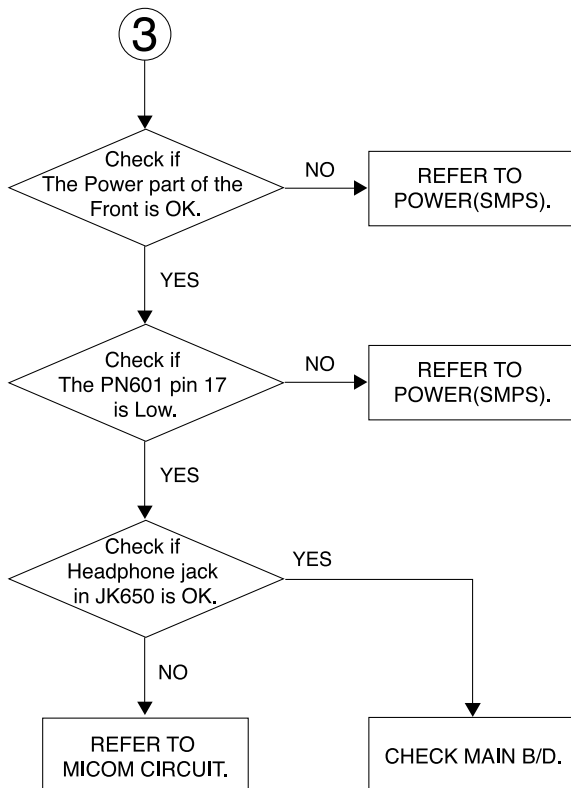
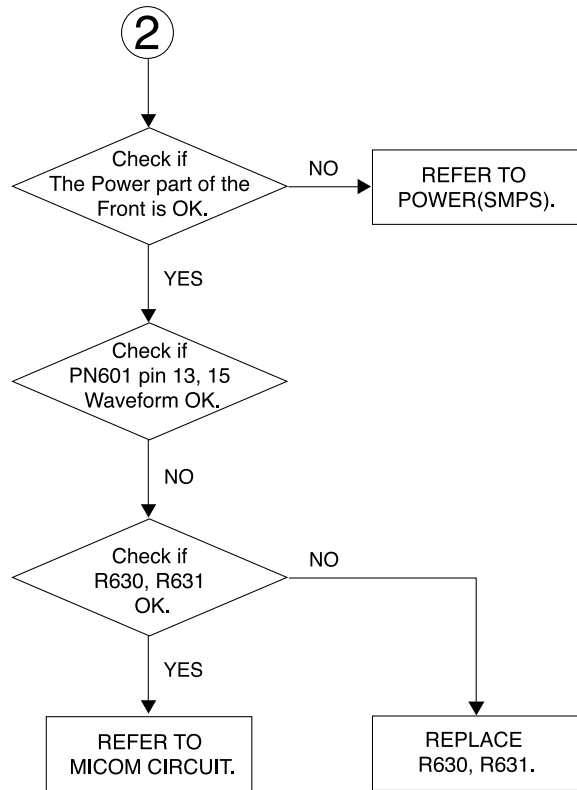
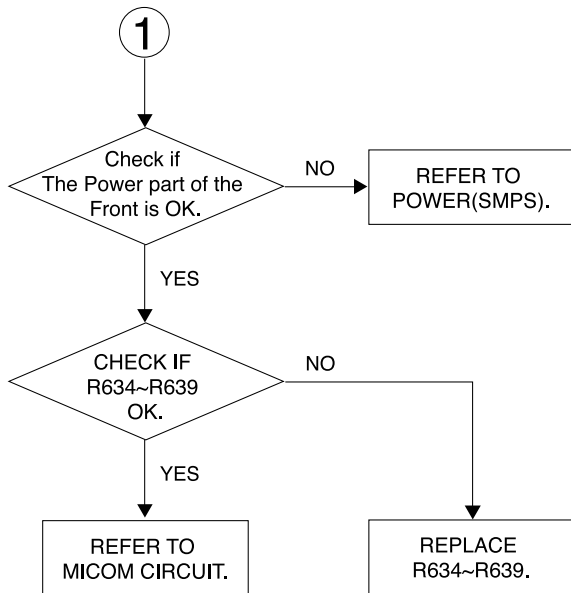

MEMO

□ BLOCK DIAGRAM

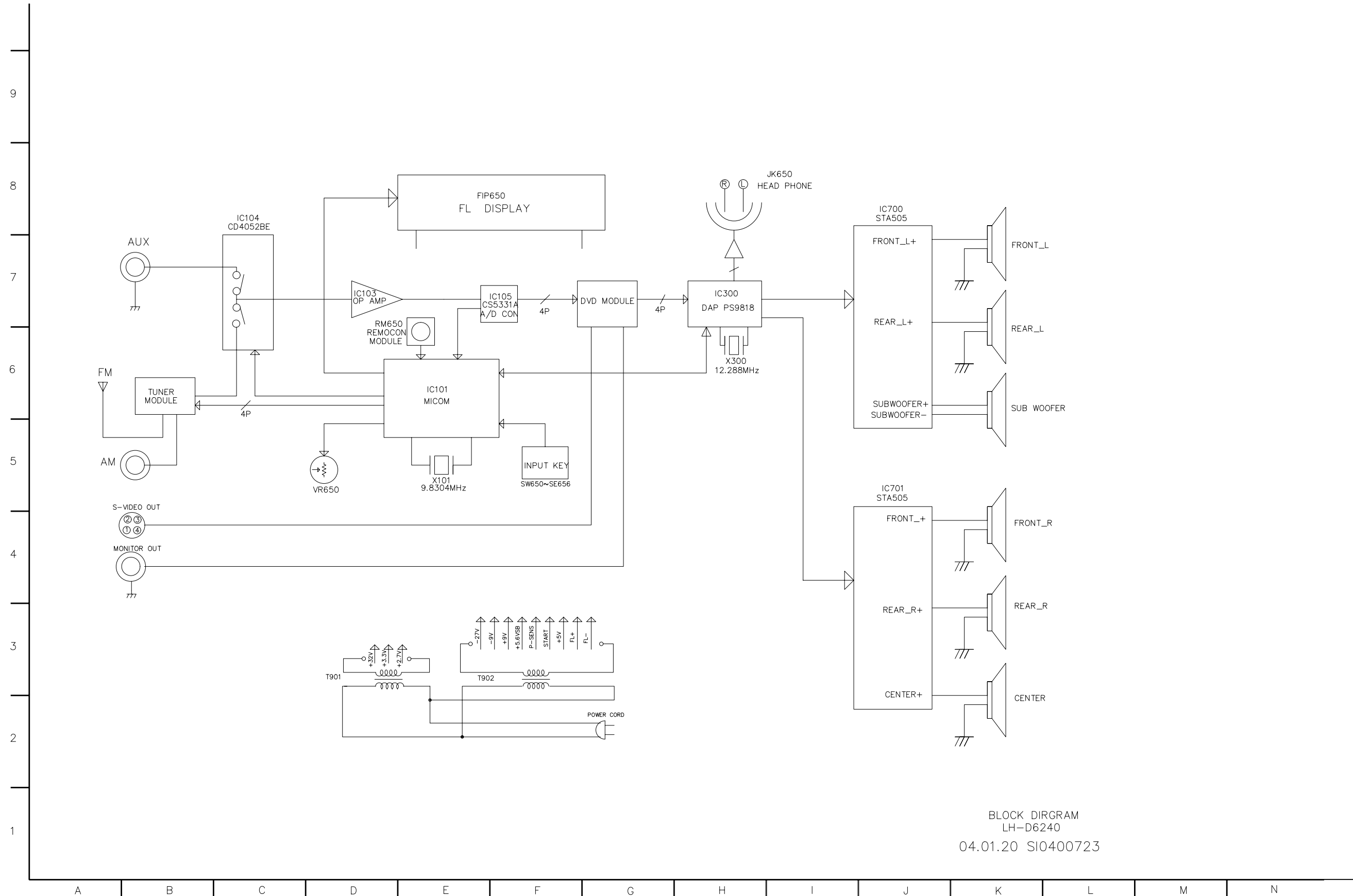

BLOCK DIAGRAM
LH-D6240
04.01.20 SIO400723

SCHEMATIC DIAGRAMS

POWER (SMPS) SCHEMATIC DIAGRAM

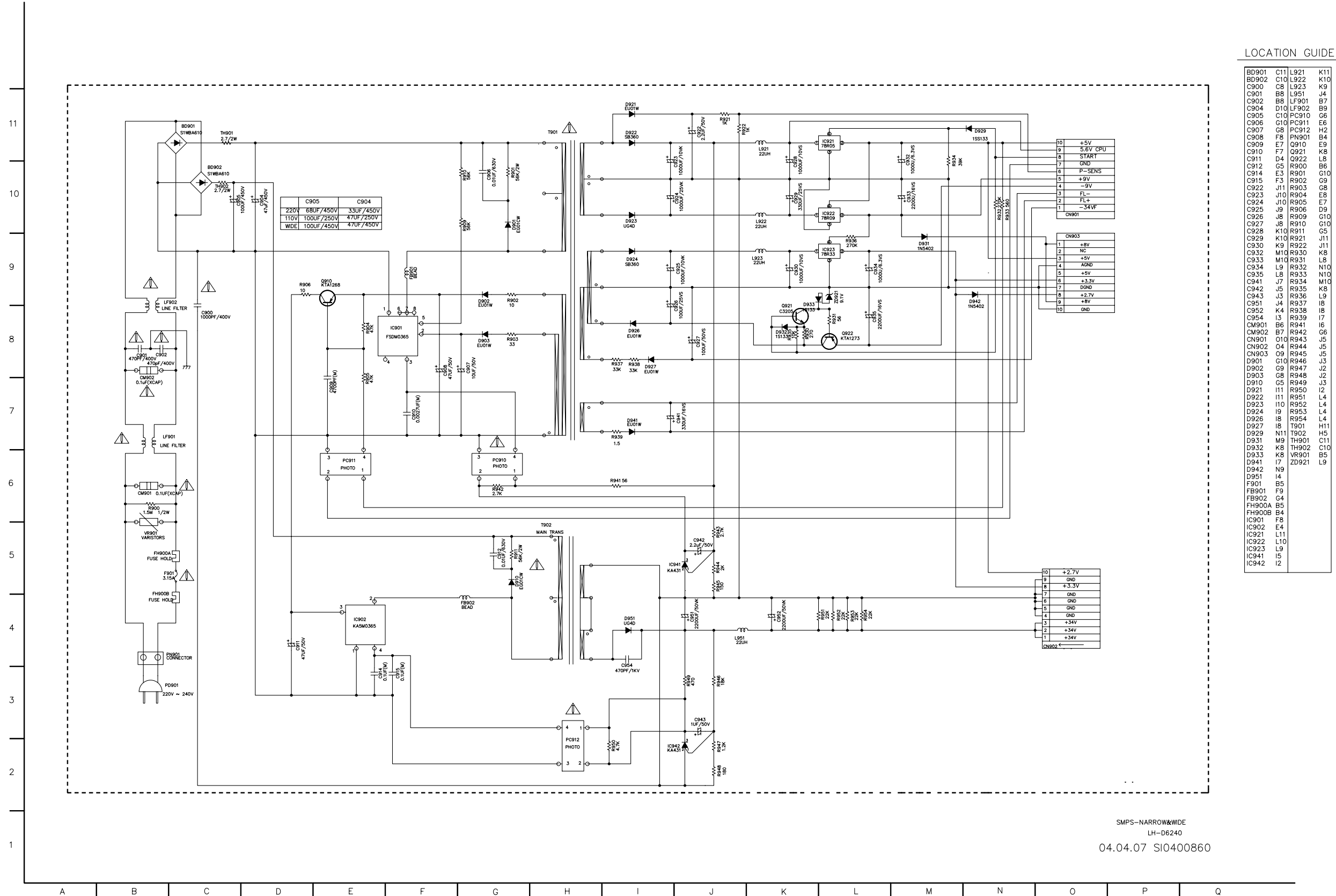

SMPS-NARROW&WIDE
LH-D6240
04.04.07 SI0400860

• μ-COM SCHEMATIC DIAGRAM

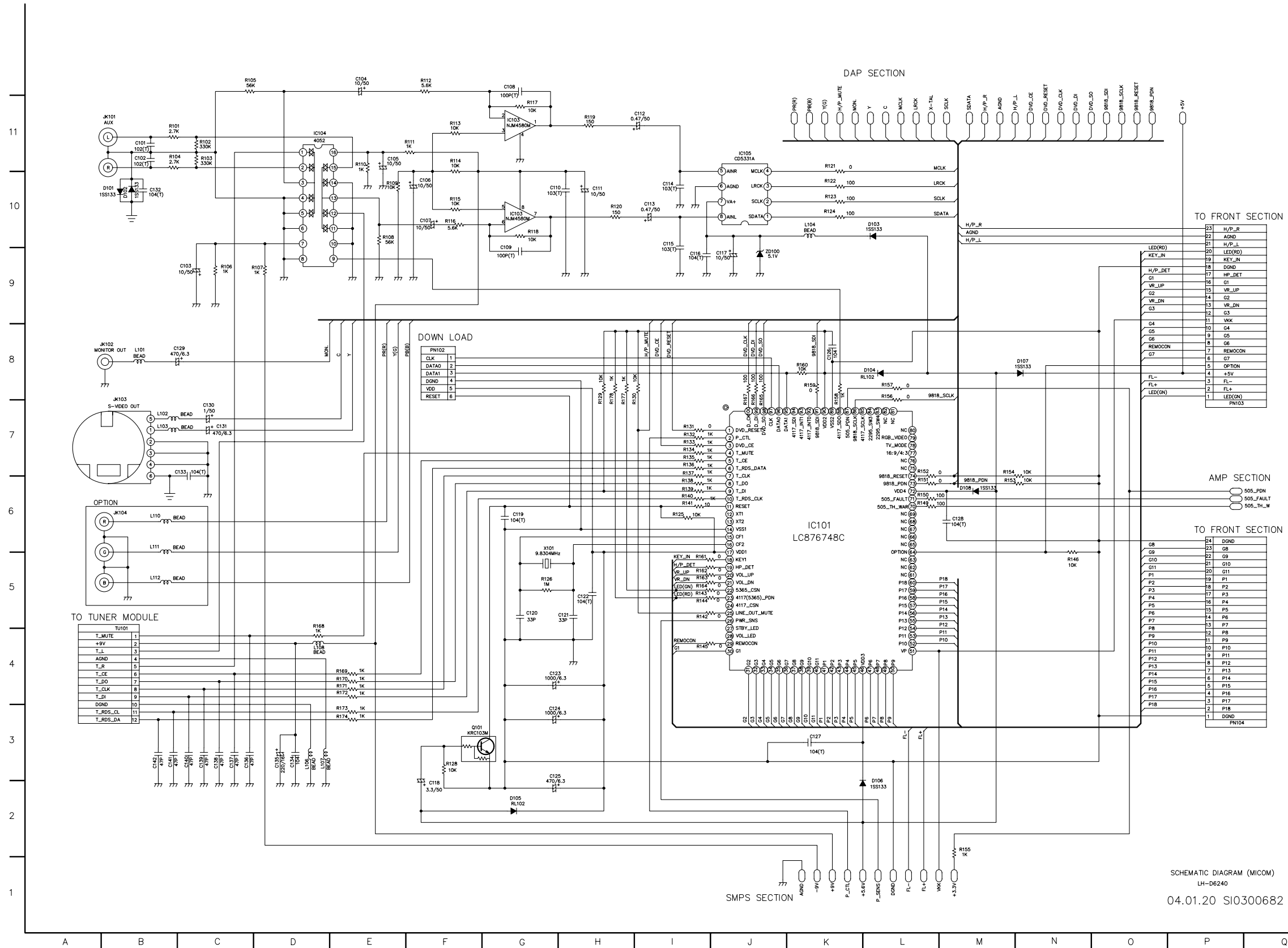

LOCATION GUIDE

C101	B11	P1	K3	R153	M7
C102	B11	P1	O5	R154	M7
C103	C9	P10	M4	R155	M2
C104	E12	P10	O4	R156	L8
C105	E11	P11	M5	R157	L8
C106	F10	P11	O4	R158	K8
C107	F10	P12	M5	R159	K8
C108	G12	P12	O4	R160	K8
C109	G10	P13	M5	R161	I6
C110	G10	P13	O4	R162	I5
C111	H10	P14	M5	R163	I5
C112	I11	P14	O4	R164	I5
C113	I10	P15	M5	R165	J8
C114	I10	P15	O4	R166	J8
C115	I10	P16	M5	R167	J8
C116	I10	P16	O4	R168	D5
C117	J10	P17	M5	R169	E4
C118	F3	P17	O4	R170	E4
C119	G6	P18	M5	R171	E4
C120	G5	P18	O4	R172	E4
C121	H5	P2	K3	R173	E4
C122	H5	P2	O5	R174	E3
C123	G4	P3	K3	R177	H8
C124	G4	P3	O5	R178	H8
C125	G3	P4	K3	SCLK	M11
C126	K8	P4	O5	SCLK	L10
C127	K3	P5	K3	SDATA	M11
C128	M6	P5	O5	SDATA	L10
C129	B8	P6	L3	TU101	B5
C130	C8	P6	O5	X-TAL	L11
C131	C7	P7	L3	X101	G6
C132	B10	P7	O5	ZD100	J10
C133	B7	P8	L3		
C134	D3	P8	O5		
C135	D3	P9	L3		
C136	C3	P9	O4		
C137	C3	PN102	F8		
C138	C3	PN103	P8		
C139	C3	PN104	P3		
C140	C3	Q101	F3		
C141	B3	R101	B11		
C142	B3	R102	C11		
D101	B10	R103	C11		
D102	B10	R104	B11		
D103	L10	R105	O12		
D104	L8	R106	C9		
D105	G2	R107	C9		
D106	L3	R108	E10		
D107	N8	R109	E10		
D108	M6	R110	E11		
G1	I4	R111	E11		
G1	O9	R112	F12		
G10	K3	R113	F11		
G10	O5	R114	F11		
G11	K3	R115	F10		
G11	O5	R116	F10		
G2	J3	R117	G11		
G2	O9	R118	G10		
G3	J3	R119	H11		
G3	O9	R120	H10		
G4	J3	R121	K11		
G4	O9	R122	K10		
G5	O3	R123	K10		
G6	J3	R125	I6		
G6	O8	R126	G5		
G7	J3	R128	F3		
G7	O8	R129	H8		
G8	K3	R130	I8		
G8	O6	R131	I7		
G9	K3	R132	I7		
IC101	K6	R133	I7		
IC103	G11	R134	I7		
IC104	D11	R135	I7		
IC105	J11	R136	I7		
JK101	B11	R137	I7		
JK102	A8	R138	I7		
JK103	B8	R139	I6		
JK104	B6	R140	I6		
L101	B8	R141	I6		
L102	B7	R142	I5		
L103	B7	R143	I5		
L104	K10	R144	I5		
L106	D3	R145	I4		
L107	D3	R146	N5		
L108	D4	R149	L6		
L110	B6	R150	L6		
L111	B6	R151	L7		
L112	B5	R152	L7		

SCHEMATIC DIAGRAM (MICOM)
LH-D6240
04.01.20 SI0300682

• FRONT & POWER(2nd) SCHEMATIC DIAGRAM

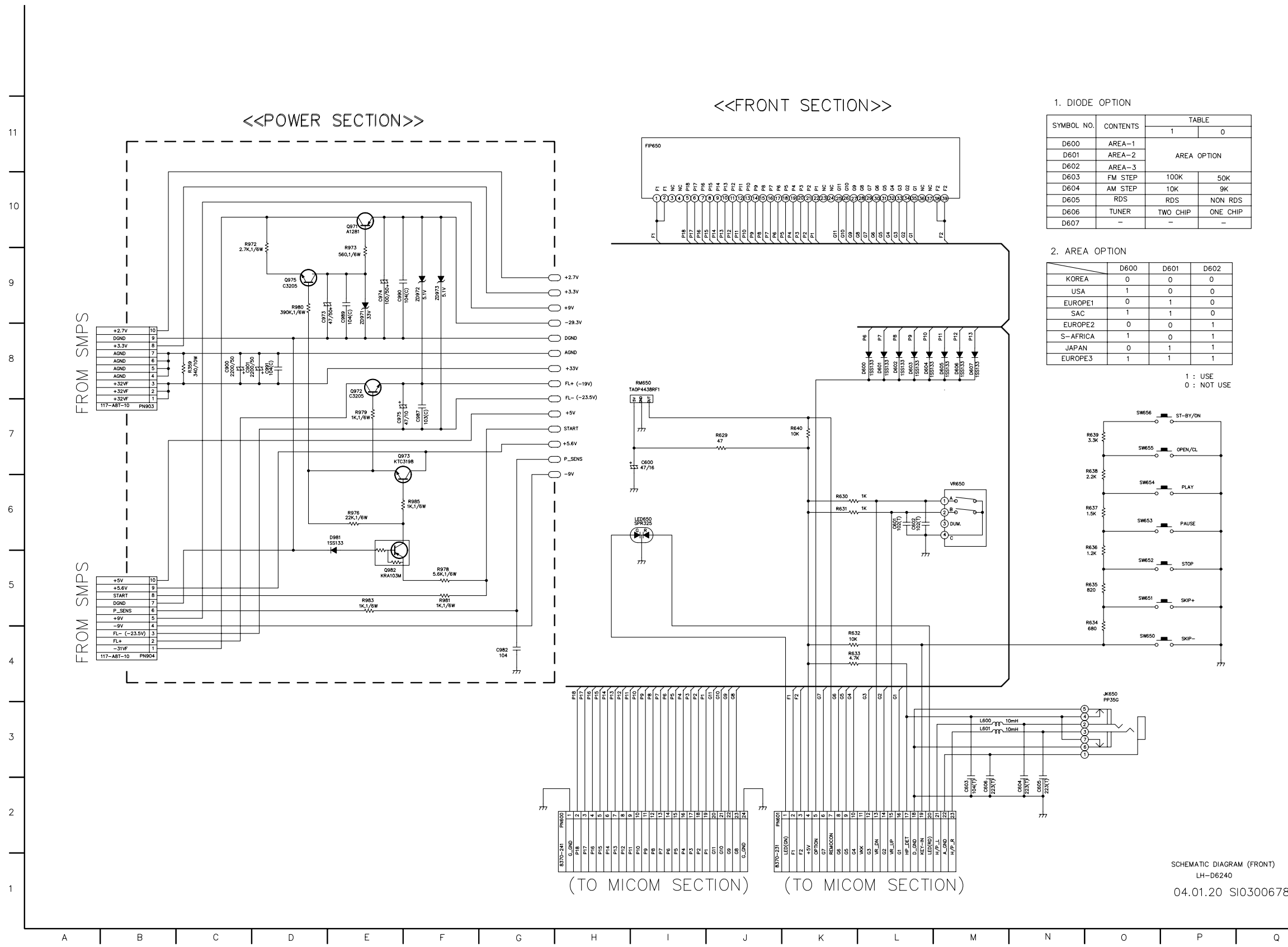

LOCATION GUIDE

C600	I7	P14	H4
C601	L6	P14	J10
C602	L6	P15	H4
C603	M2	P15	J10
C604	N2	P16	H4
C605	N2	P16	I10
C606	M2	P17	H4
C900	C8	P17	I10
C901	C8	P18	H4
C973	D9	P18	I10
C974	E9	P2	I4
C975	E7	P2	K10
C982	G4	P3	I4
C987	F7	P3	K10
C989	E9	P4	I4
C990	E9	P4	K10
C991	D8	P5	I4
D600	L8	P5	K10
D601	L8	P6	I4
D602	L8	P6	L8
D603	L8	P6	J10
D604	L8	P7	I4
D605	M8	P7	L8
D607	M8	P8	I4
D981	E6	P8	L8
DGND	H8	P8	J10
F1	K4	P9	I4
F1	I10	P9	L8
F2	K4	P9	J10
F2	M10	PN600	H2
FIP650	I11	PN601	J2
FL+	H8	PN904	B#
FL-	H7	Q971	E10
G1	L4	Q972	E8
G1	L10	Q973	E7
G10	J4	Q975	D9
G10	K10	Q982	E5
G11	J4	R359	C8
G11	K10	R629	J7
G2	L4	R630	K6
G2	L10	R631	K6
G3	L4	R632	K4
G3	L10	R633	K4
G4	K4	R634	O5
G4	L10	R635	O5
G5	K4	R636	O6
G5	L10	R637	O6
G6	K4	R638	O7
G6	L10	R639	O7
G7	K4	R640	K7
G7	L10	R972	C10
G8	J4	R973	E9
G8	L10	R976	E6
G9	J4	R978	F5
G9	K10	R979	E7
G9	K10	R980	D9
JK650	O4	R980	D9
L600	M3	R981	F5
L601	M3	R983	E5
LED650	I6	R985	F6
P1	I4	RM650	I8
P1	K10	START	H7
P10	I4	SW650	O4
P10	L8	SW651	O5
P10	J10	SW652	O5
P11	H4	SW653	O6
P11	M8	SW654	O6
P11	J10	SW655	O7
P12	H4	SW656	O7
P12	M8	VR650	M6
P12	J10	ZD971	E8
P13	H4	ZD972	F9
P13	M8	ZD973	F9
P13	J10		

1. DIODE OPTION

SYMBOL NO.	CONTENTS	TABLE	
		1	0
D600	AREA-1		
D601	AREA-2	AREA OPTION	
D602	AREA-3		
D603	FM STEP	100K	50K
D604	AM STEP	10K	9K
D605	RDS	RDS	NON RDS
D606	TUNER	TWO CHIP	ONE CHIP
D607	-	-	-

2. AREA OPTION

	D600	D601	D602
KOREA	0	0	0
USA	1	0	0
EUROPE1	0	1	0
SAC	1	1	0
EUROPE2	0	0	1
S-AFRICA	1	0	1
JAPAN	0	1	1
EUROPE3	1	1	1

1 : USE
0 : NOT USE

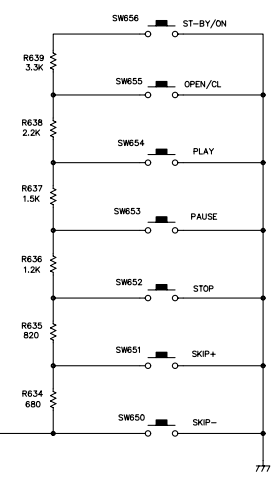

SCHEMATIC DIAGRAM (FRONT)
LH-D6240
04.01.20 SI0300678

• DAP SCHEMATIC DIAGRAM

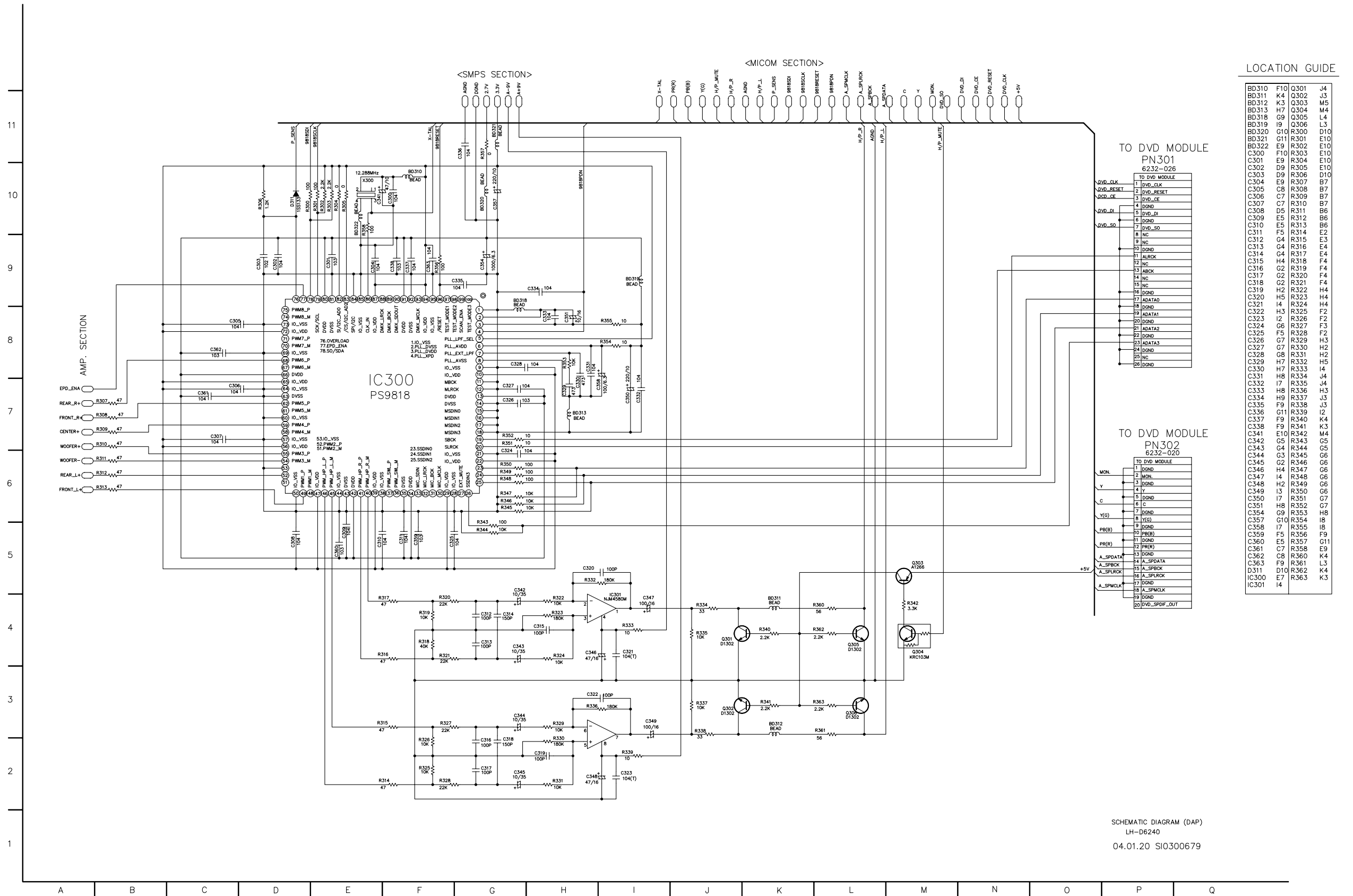

LOCATION GUIDE

BD310	F10	Q301	J4
BD311	K4	Q302	J3
BD312	K3	Q303	M5
BD313	H7	Q304	M4
BD318	G9	Q305	L4
BD319	I9	Q306	L3
BD320	G10	R300	D10
BD321	G11	R301	E10
BD322	E9	R302	E10
C300	F10	R303	E10
C301	E9	R304	E10
C302	D9	R305	E10
C303	D9	R306	D10
C304	E9	R307	B7
C305	C8	R308	B7
C306	C7	R309	B7
C307	C7	R310	B7
C308	D5	R311	B6
C309	E5	R312	B6
C310	E5	R313	B6
C311	F5	R314	E2
C312	G4	R315	E3
C313	G4	R316	E4
C314	G4	R317	E4
C315	H4	R318	F4
C316	G2	R319	F4
C317	G2	R320	F4
C318	G2	R321	F4
C319	H2	R322	H4
C320	H5	R323	H4
C321	I4	R324	H4
C322	H3	R325	F2
C323	I2	R326	F2
C324	G6	R327	F3
C325	F5	R328	F2
C326	G7	R329	H3
C327	G7	R330	H2
C328	G8	R331	H2
C329	H7	R332	H5
C330	H7	R333	I4
C331	H8	R334	J4
C332	I7	R335	J4
C333	H8	R336	H3
C334	H9	R337	J3
C335	F9	R338	J3
C336	G11	R339	I2
C337	F9	R340	K4
C338	F9	R341	K3
C341	E10	R342	M4
C342	G5	R343	G5
C343	G4	R344	G5
C344	G3	R345	G6
C345	G2	R346	G6
C346	H4	R347	G6
C347	I4	R348	G6
C348	H2	R349	G6
C349	I3	R350	G6
C350	I7	R351	G7
C351	H8	R352	G7
C354	G9	R353	H8
C357	G10	R354	I8
C358	I7	R355	I8
C359	F5	R356	F9
C360	E5	R357	G11
C361	C7	R358	E9
C362	C8	R360	K4
C363	F9	R361	L3
D311	D10	R362	K4
IC300	E7	R363	K3
IC301	I4		

SCHMATIC DIAGRAM (DAP)
LH-D6240
04.01.20 SIO300679

• AMP SCHEMATIC DIAGRAM

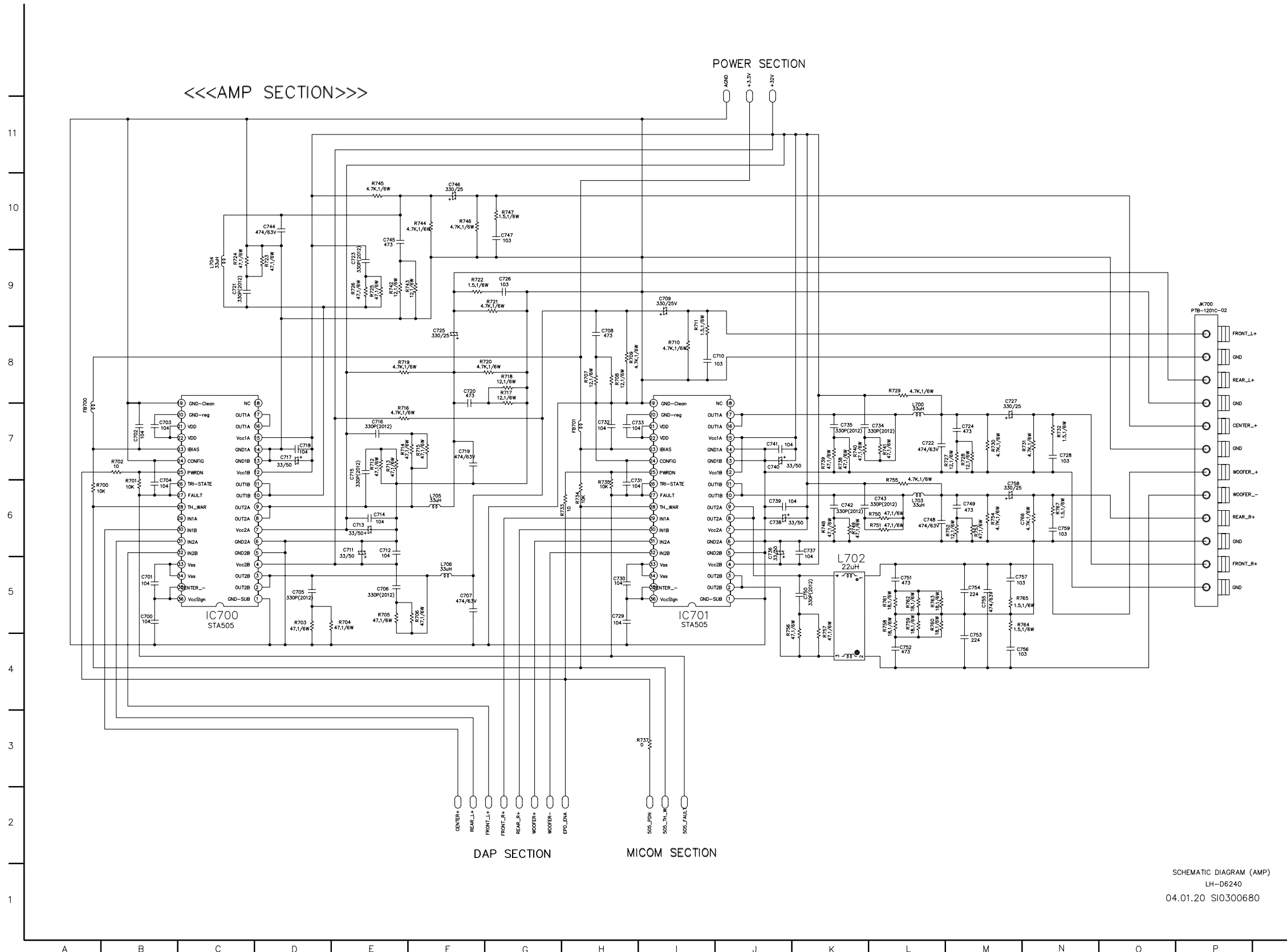

LOCATION GUIDE

C700	B5	L704	C9
C701	B5	L705	F6
C702	B7	L706	F5
C703	B7	R700	B6
C704	B6	R701	B6
C705	D5	R702	B7
C706	E5	R703	D5
C707	F5	R704	E5
C708	H8	R705	E5
C709	I9	R706	F5
C710	J8	R707	H8
C711	E6	R708	H8
C712	E6	R709	I8
C713	E6	R710	I8
C714	E6	R711	I8
C715	E7	R712	E7
C716	E7	R713	E7
C717	D7	R714	F7
C718	D7	R715	F7
C719	F7	R716	E7
C720	F8	R717	G8
C721	C9	R718	G8
C722	L7	R719	E8
C723	E9	R720	G8
C724	M7	R721	G9
C725	F8	R722	F9
C726	G9	R723	D9
C727	M8	R724	C9
C728	N7	R725	E9
C729	H5	R726	E9
C730	H5	R727	M7
C731	I6	R728	M7
C732	H7	R729	L8
C733	I7	R730	M7
C734	L7	R731	N7
C735	K7	R732	N7
C736	J5	R733	H6
C737	K6	R734	H6
C738	J6	R735	H6
C739	J6	R737	I3
C740	J7	R738	K7
C741	J7	R739	K7
C742	K6	R740	K7
C743	L6	R741	L7
C744	D10	R742	E9
C745	E10	R743	F9
C746	F10	R744	F10
C747	G10	R745	E10
C748	L6	R746	F10
C749	M6	R747	G10
C750	K5	R748	K6
C751	L5	R749	K6
C752	L4	R750	L6
C753	M4	R751	L6
C754	M5	R752	M6
C755	M5	R753	M6
C756	N4	R754	M6
C757	N5	R755	L6
C758	M6	R756	K4
C759	N6	R757	K4
C760	N6	R758	L5
C761	N6	R759	L5
C762	N6	R760	L5
C763	N6	R761	L5
C764	N6	R762	L5
C765	N6	R763	L5
C766	N6	R764	N5
C767	N6	R765	N5
C768	N6	R766	N5
C769	N6	R767	N6

SCHEMATIC DIAGRAM (AMP)
LH-D6240
04.01.20 SI0300680

WIRING DIAGRAM

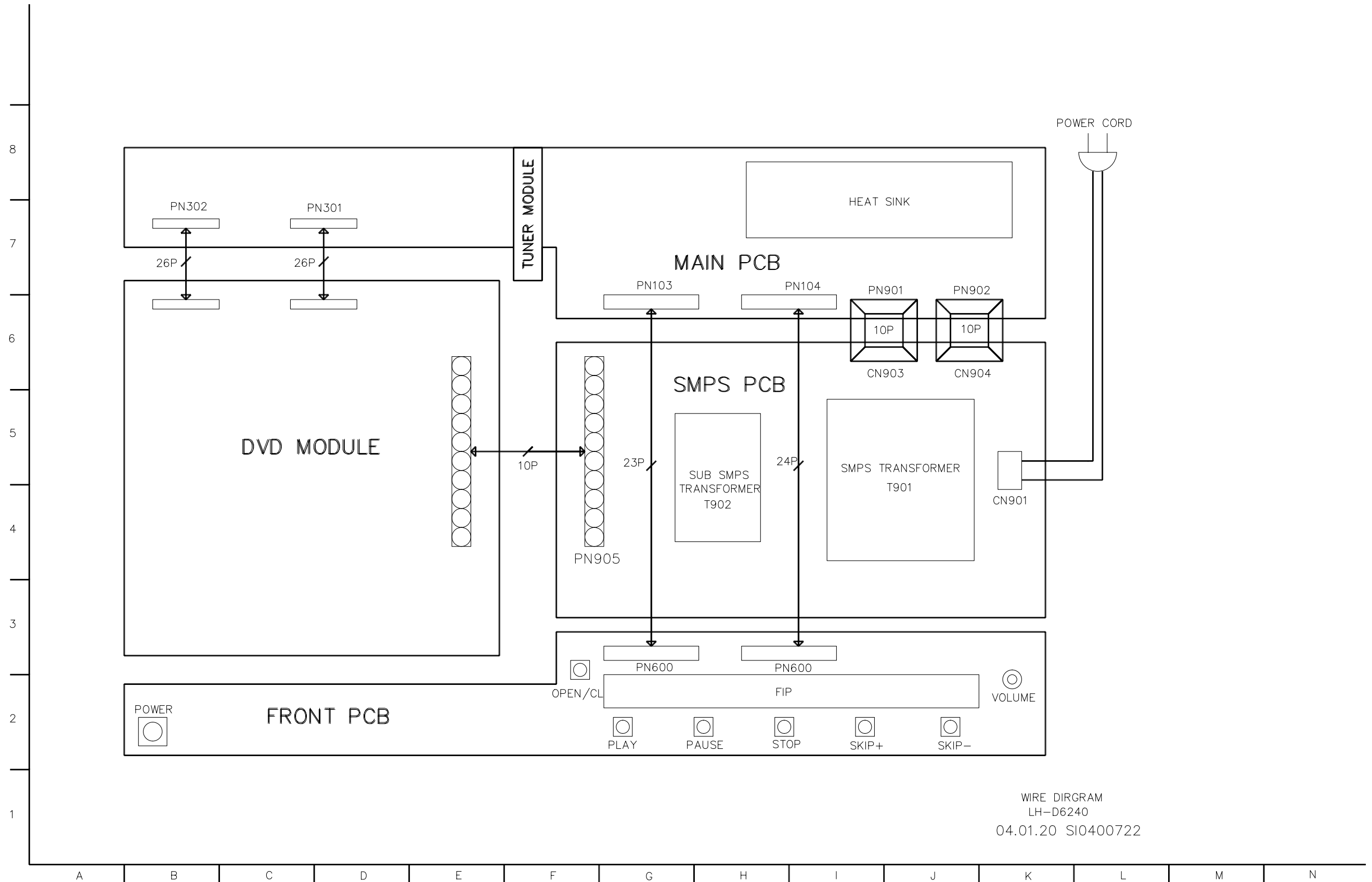

WIRE DIRGRAM
LH-D6240
04.01.20 SI0400722

PRINTED CIRCUIT BOARD DIAGRAMS

MAIN P.C. BOARD DIAGRAM (SOLDER SIDE)

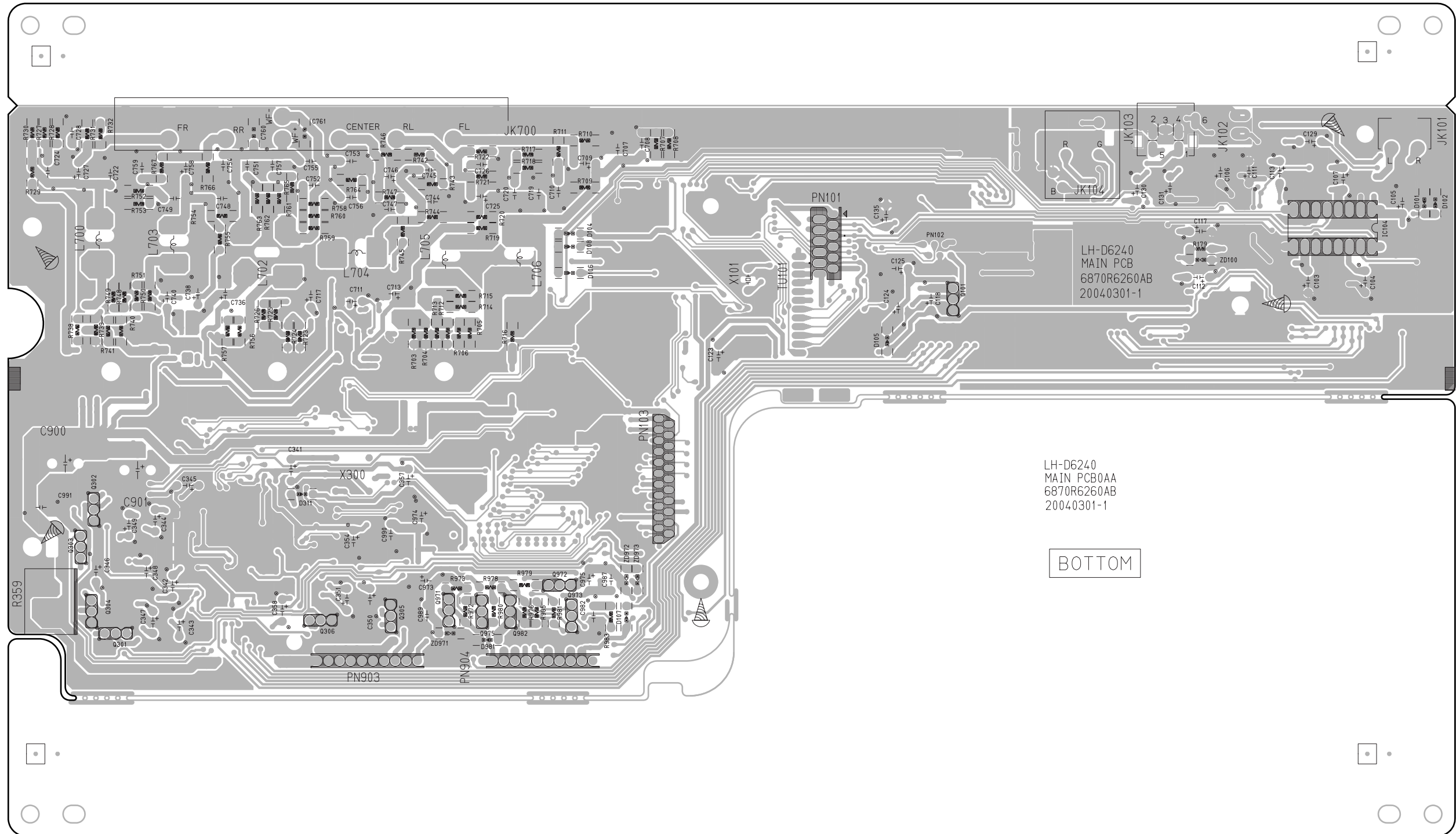

• MAIN P.C. BOARD DIAGRAM (COMPONENT SIDE)

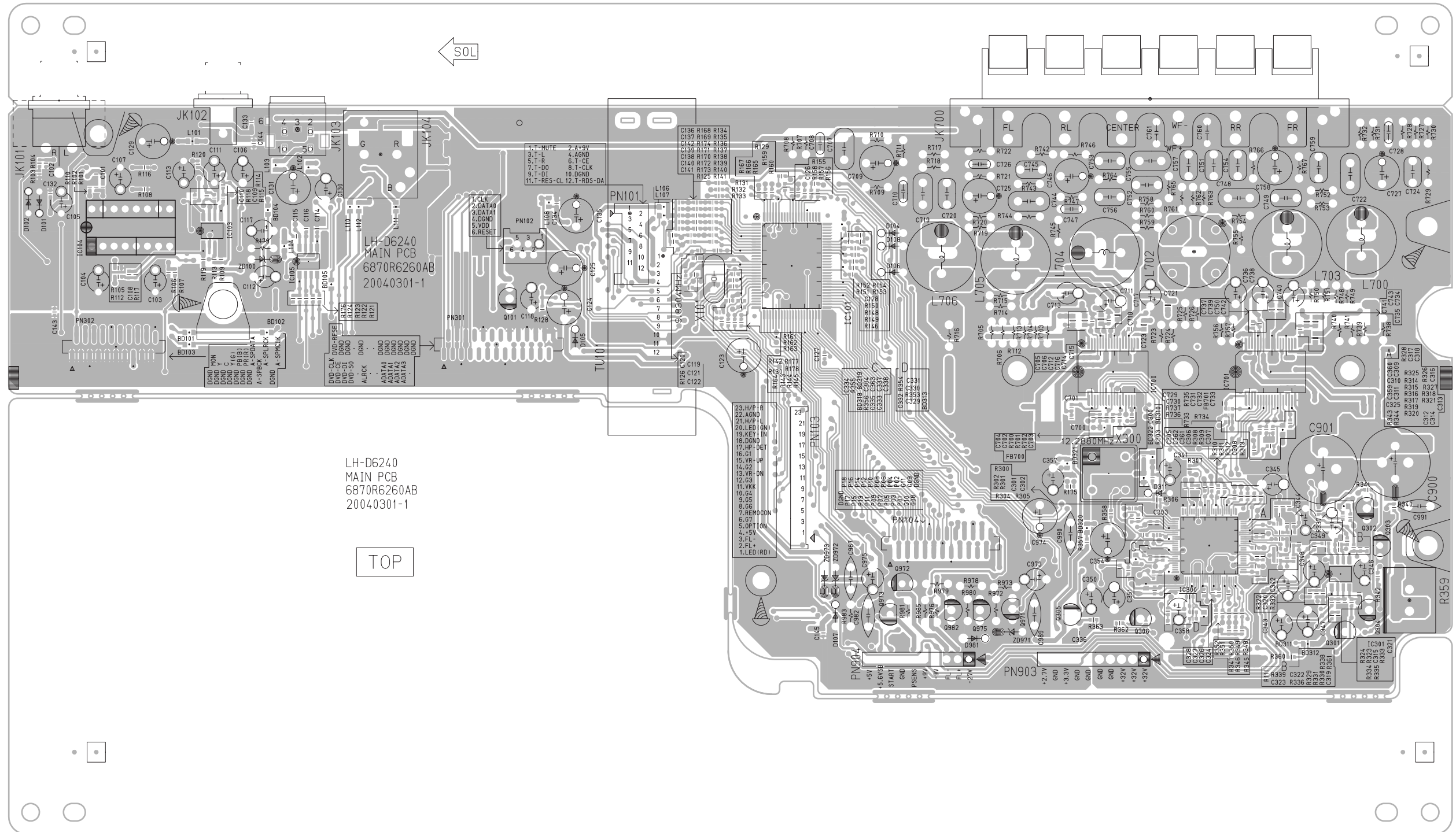

• POWER(SMPS) P.C. BOARD (SOLDER SIDE)

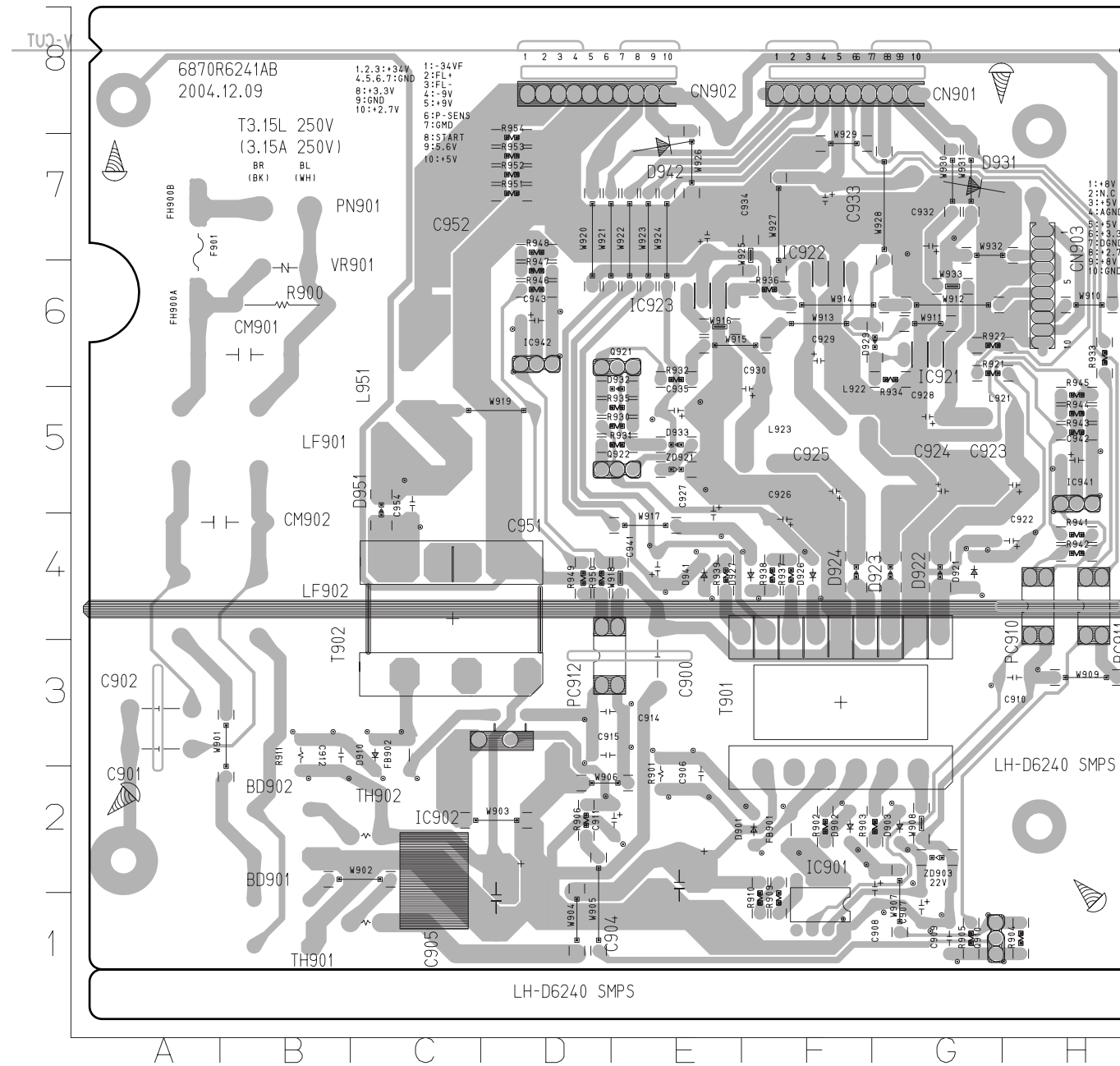

BD901	B1	D903	G2	R903	G2
BD902	B2	D910	C3	R904	H1
C900	E3	D921	G4	R905	G1
C901	A3	D922	G4	R906	D2
C902	A3	D923	G4	R909	F1
C904	E2	D924	F4	R910	F1
C905	D1	D926	F4	R911	B3
C906	E2	D927	F4	R921	G6
C907	G1	D929	G6	R922	G6
C908	G2	D931	G7	R930	E5
C909	G1	D932	E5	R931	E5
C910	H3	D933	E5	R932	E6
C911	E2	D941	E4	R933	H6
C912	B3	D942	E7	R934	G6
C914	D3	D951	C5	R935	E5
C915	D3	FB901	F2	R936	F6
C922	H4	FB902	C3	R937	F4
C923	H5	FH900A	A6	R938	F4
C924	G5	FH900B	A7	R939	E4
C925	F5	IC901	F1	R941	H4
C926	F4	IC902	D3	R942	H4
C927	E4	IC921	G6	R943	H5
C928	G5	IC922	F6	R944	H5
C929	F6	IC923	E6	R945	H5
C930	F5	IC941	H5	R946	D6
C932	G7	IC942	D6	R947	D6
C933	F7	L921	G5	R948	D7
C934	E7	L922	F5	R949	D4
C935	E5	L923	F5	R950	D4
C941	E4	L951	C6	R951	D7
C942	H5	LF901	B5	R952	D7
C943	D6	LF902	B4	R953	D7
C951	C5	PC910	H4	R954	D7
C952	C6	PC911	H4	T901	F3
C954	C5	PC912	D4	T902	C4
CM901	B6	PN901	B7	TH901	C1
CM902	B4	Q910	G1	TH902	C2
CN901	F8	Q921	E6	VR901	B6
CN902	E8	Q922	E5	ZD903	G2
CN903	H7	R900	B6	ZD921	E5
D901	F2	R901	E2		
D902	F2	R902	F2		

• FRONT P.C. BOARD DIAGRAM (SOLDER SIDE)

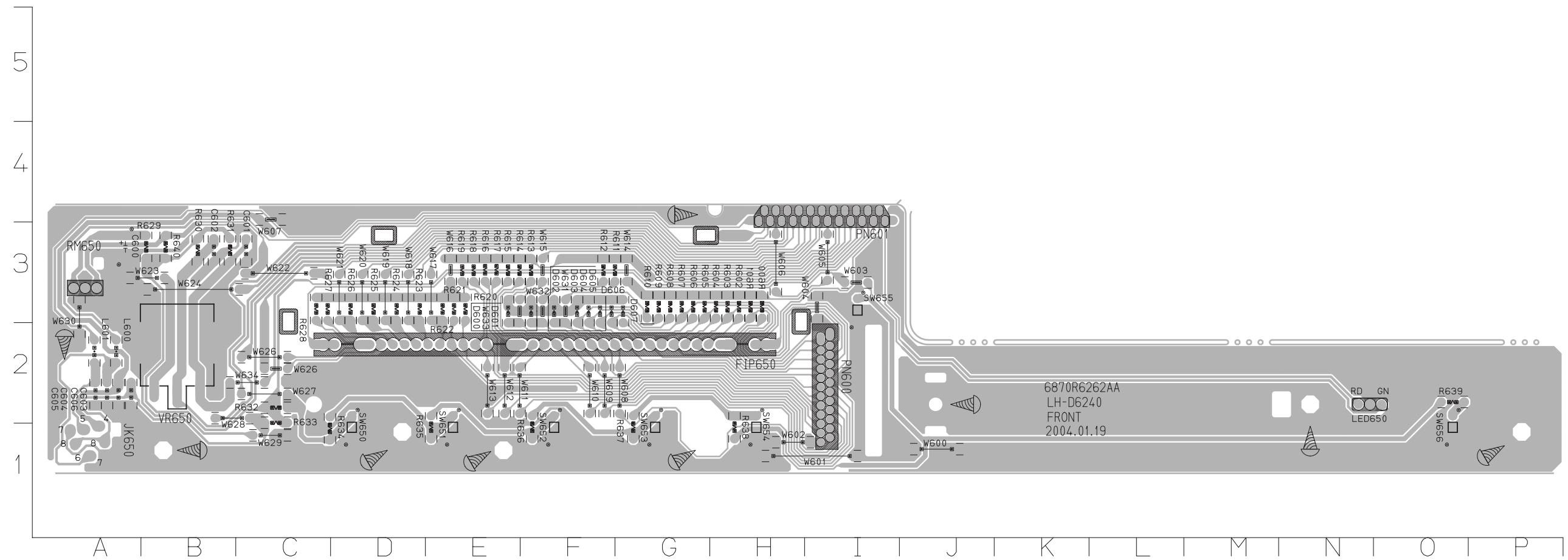

SECTION 3. DVD PART

DVD TROUBLESHOOTING GUIDE

1. Power check flow

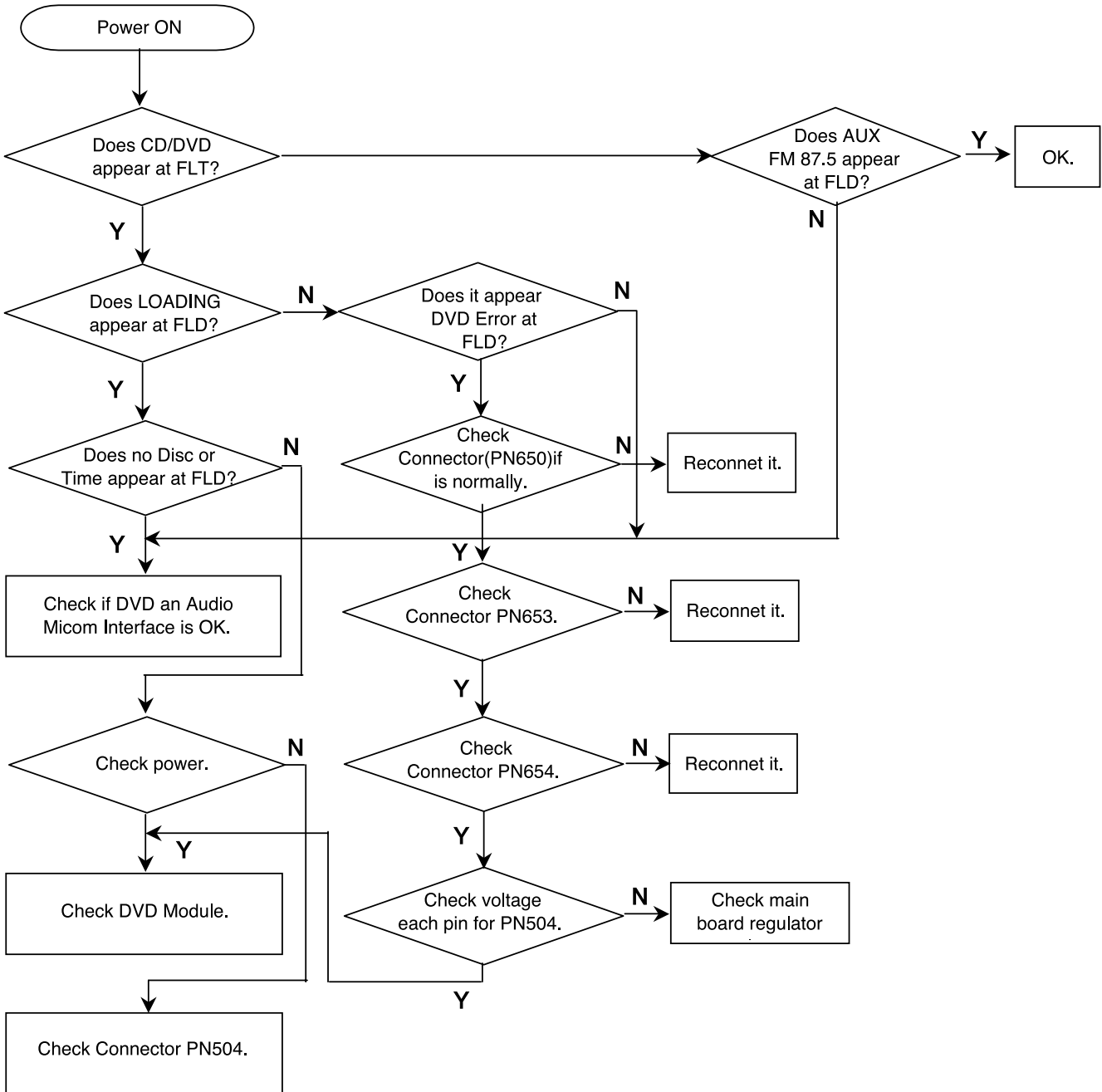

2. Test & debug flow

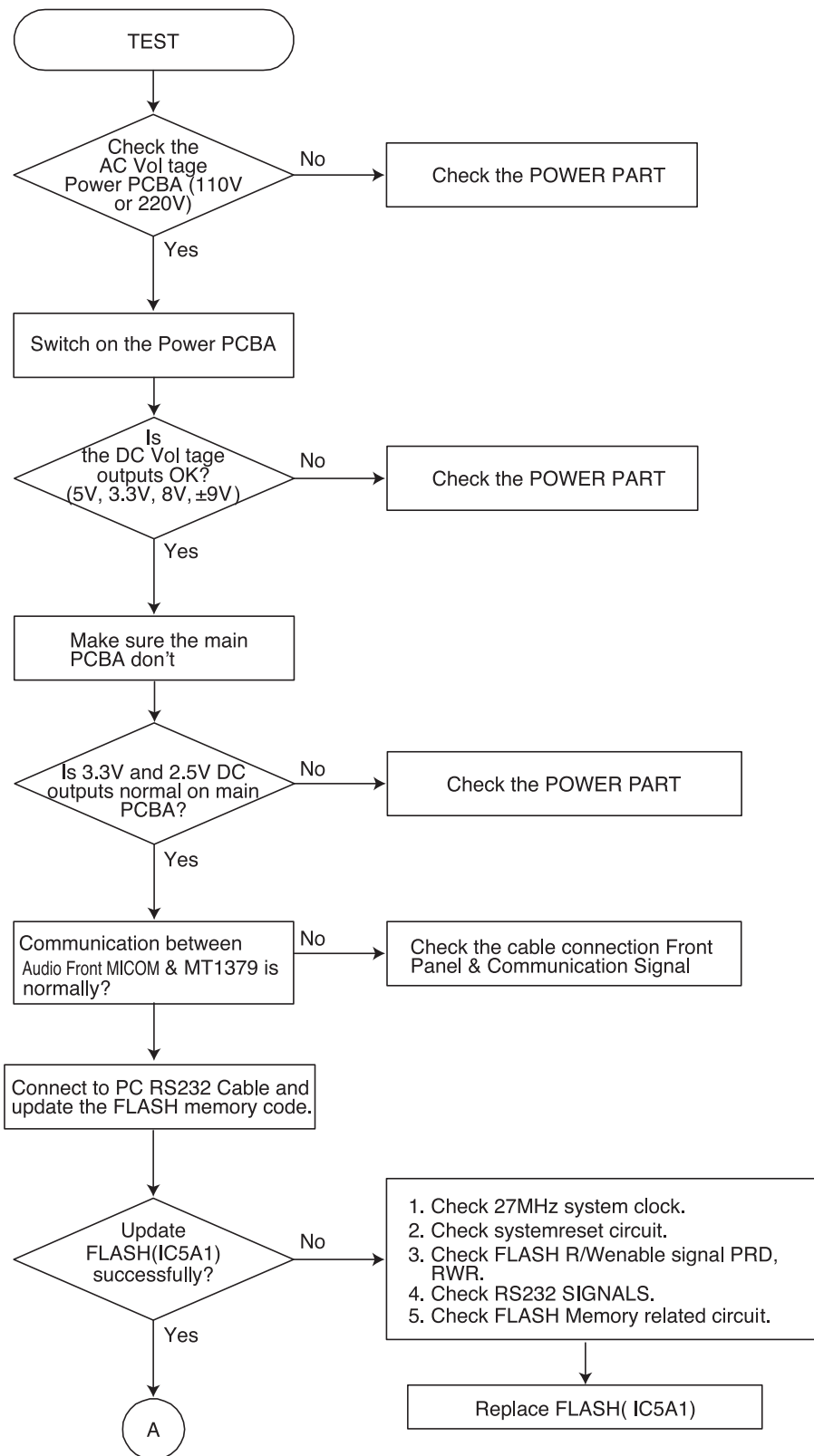

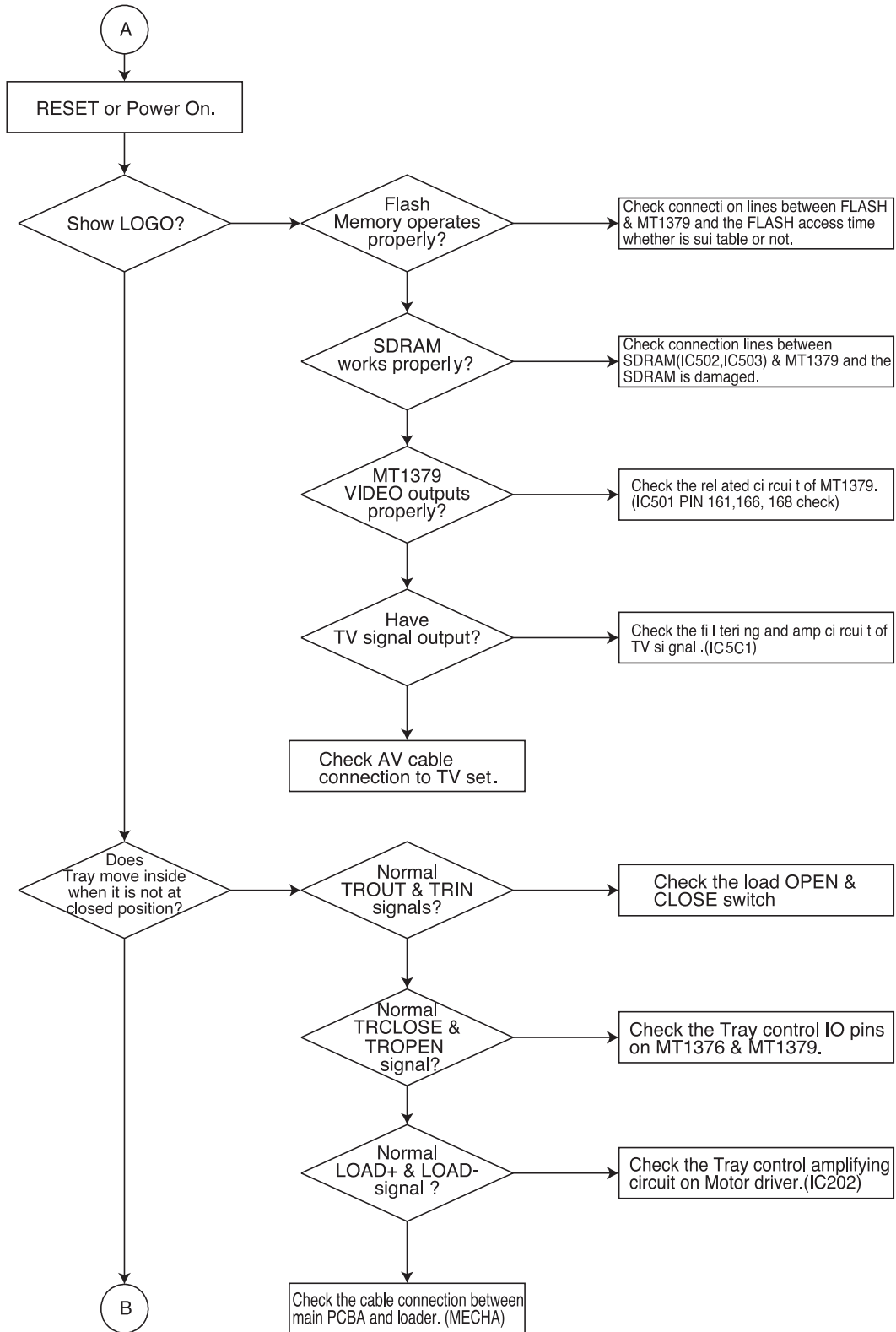

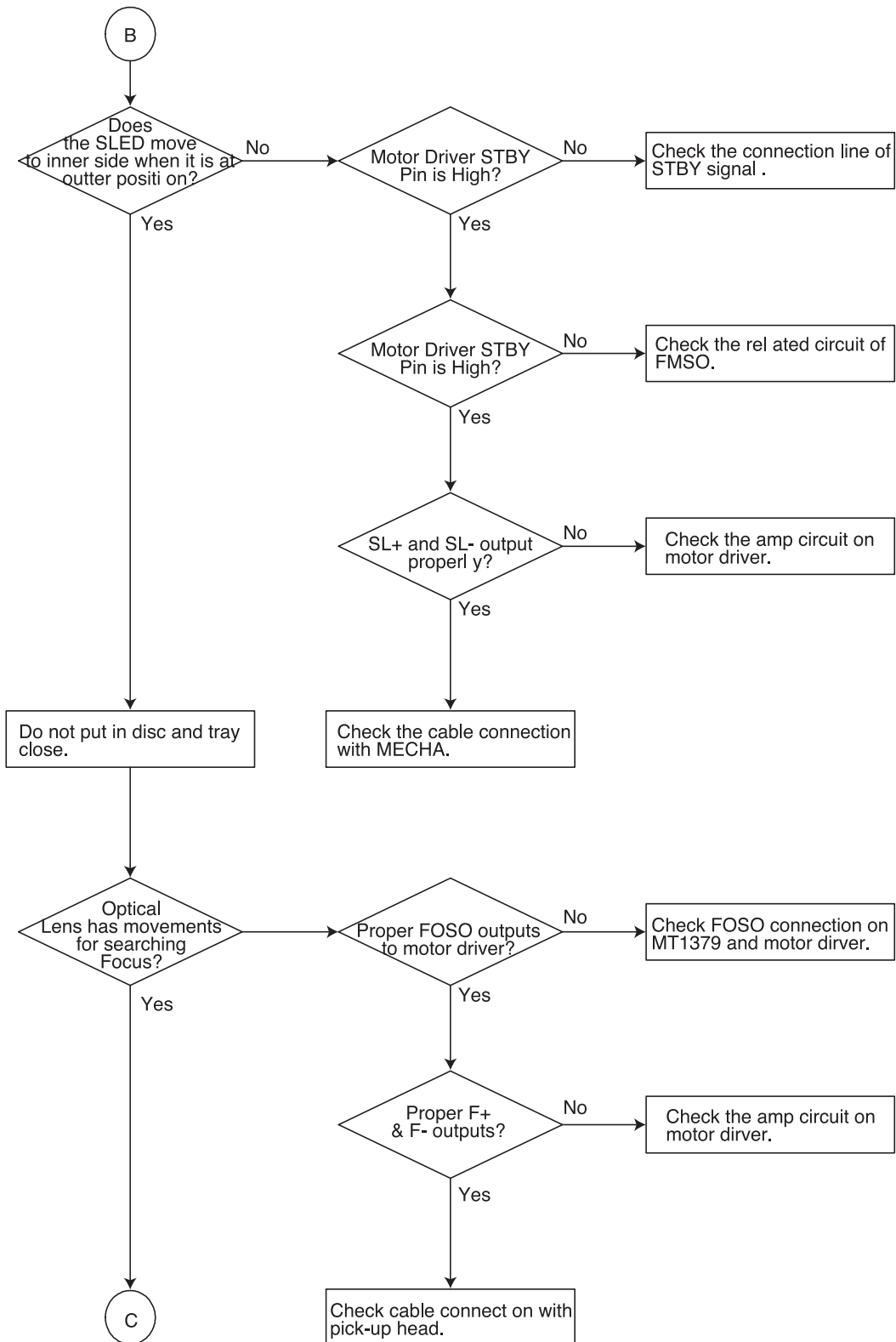

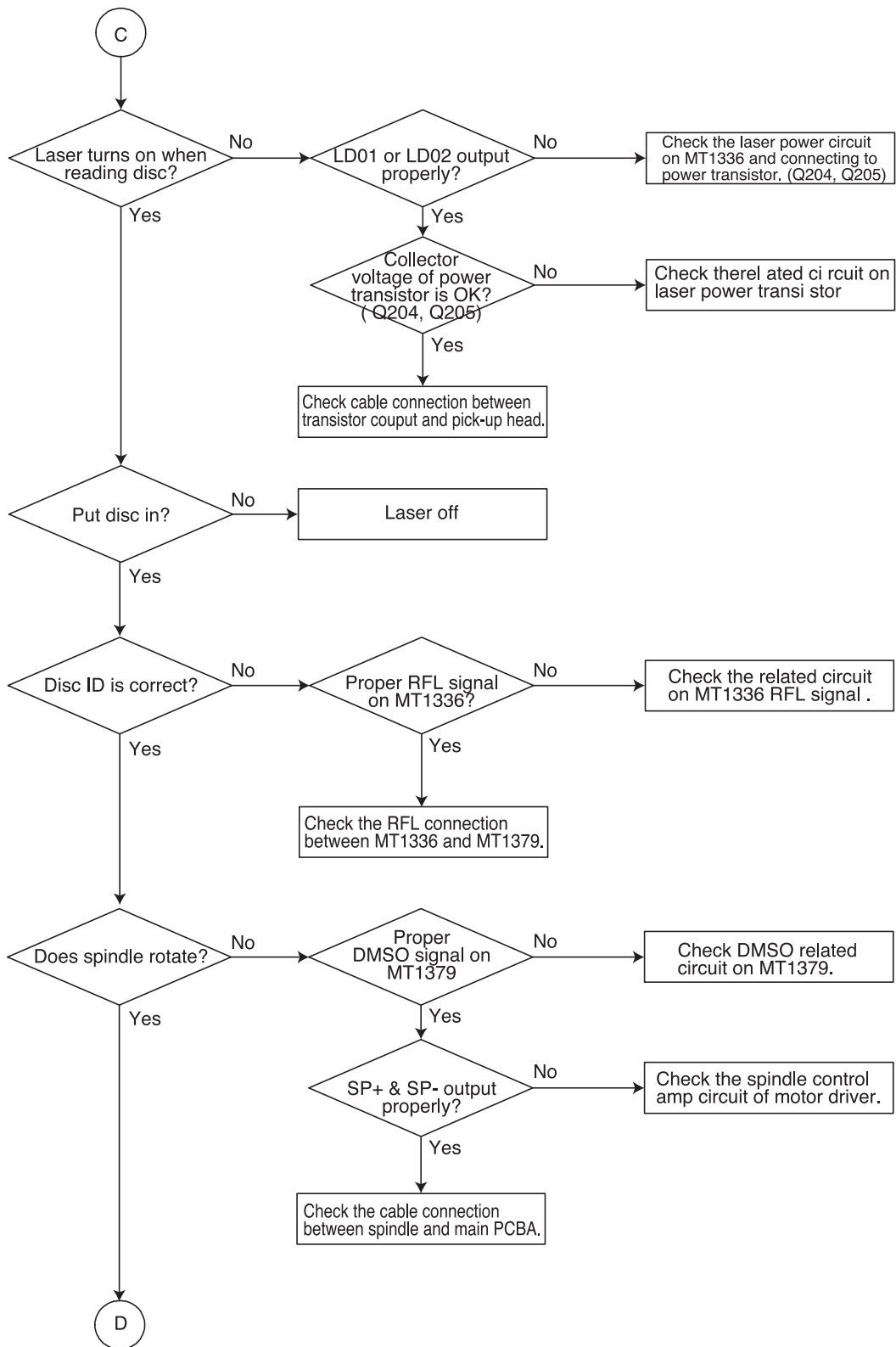

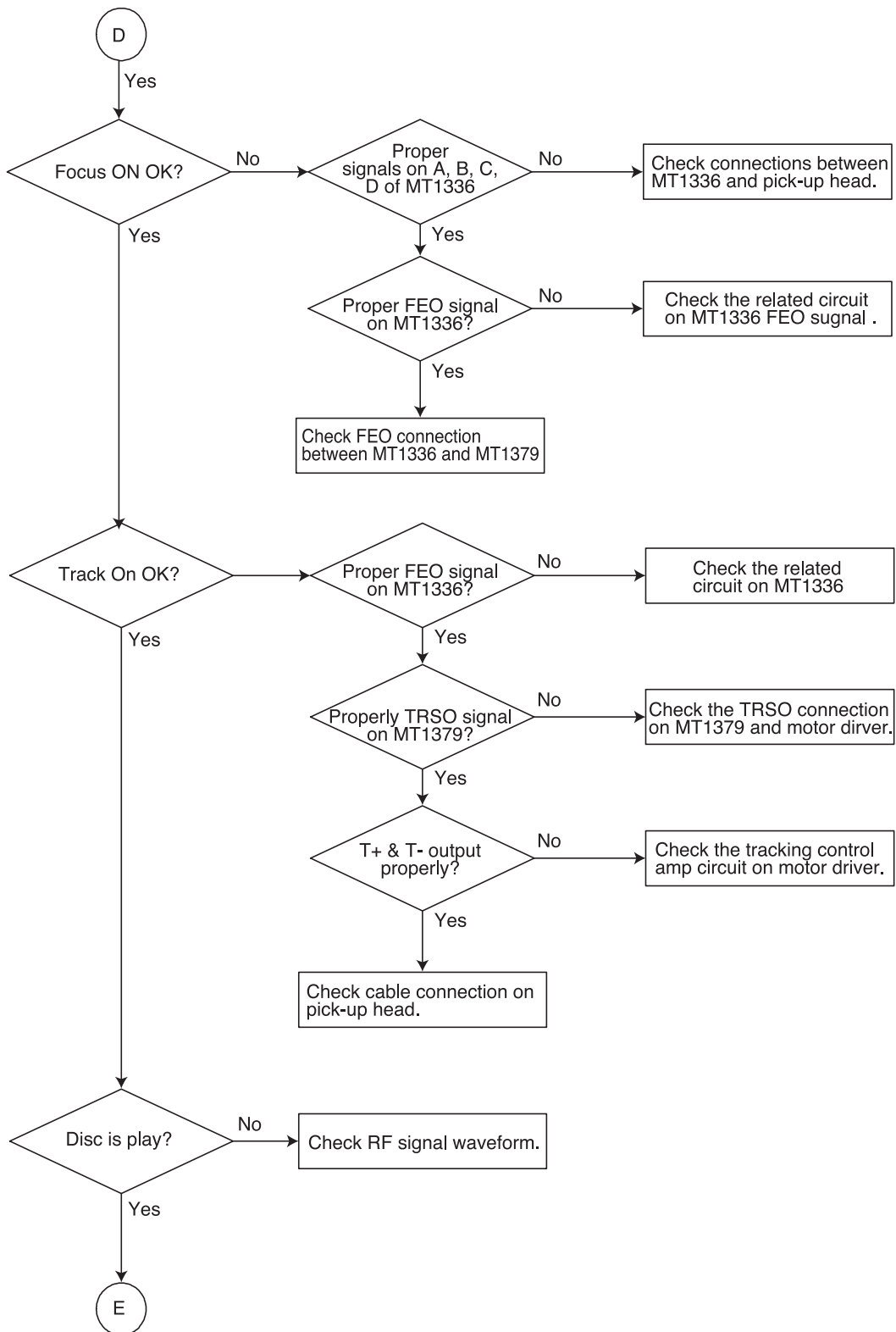

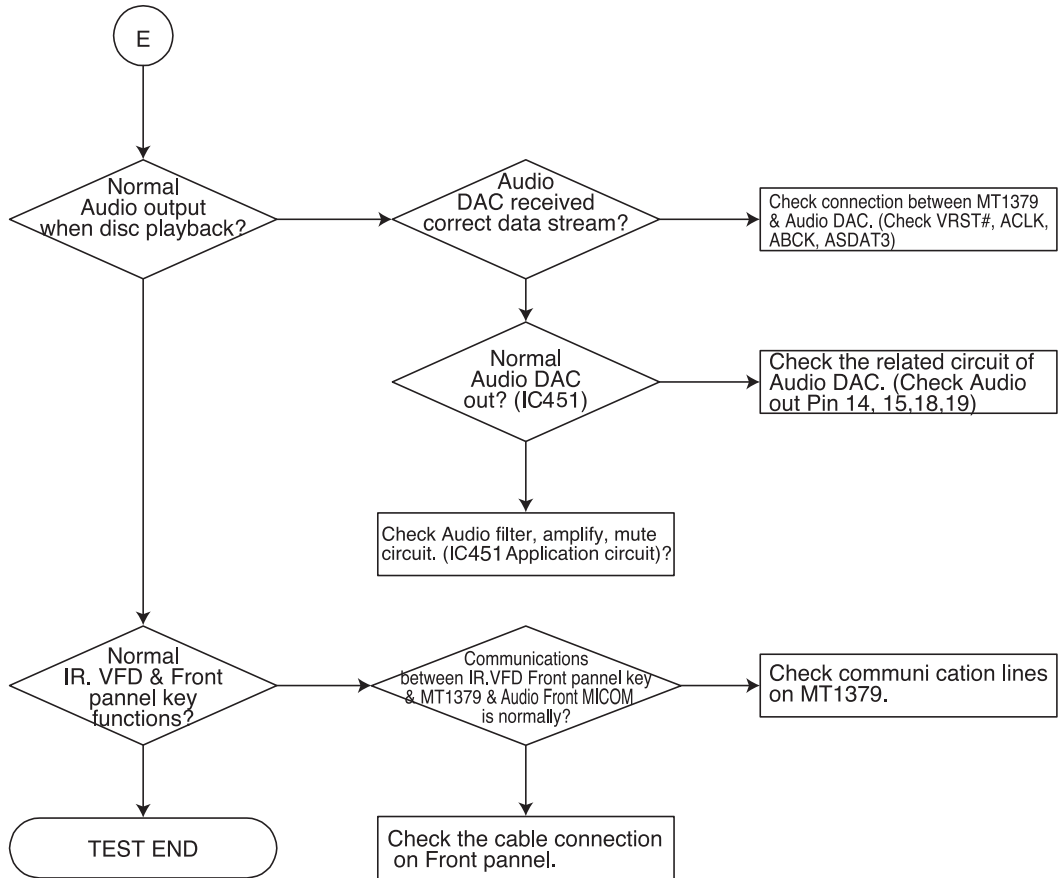

□ DETAILS AND WAVEFORMS ON SYSTEM TEST AND DEBUGGING

1. SYSTEM 27MHz CLOCK,RESET,FLASH R/W SIGNAL

1) MT1379 main clock is at 27MHz(X501)

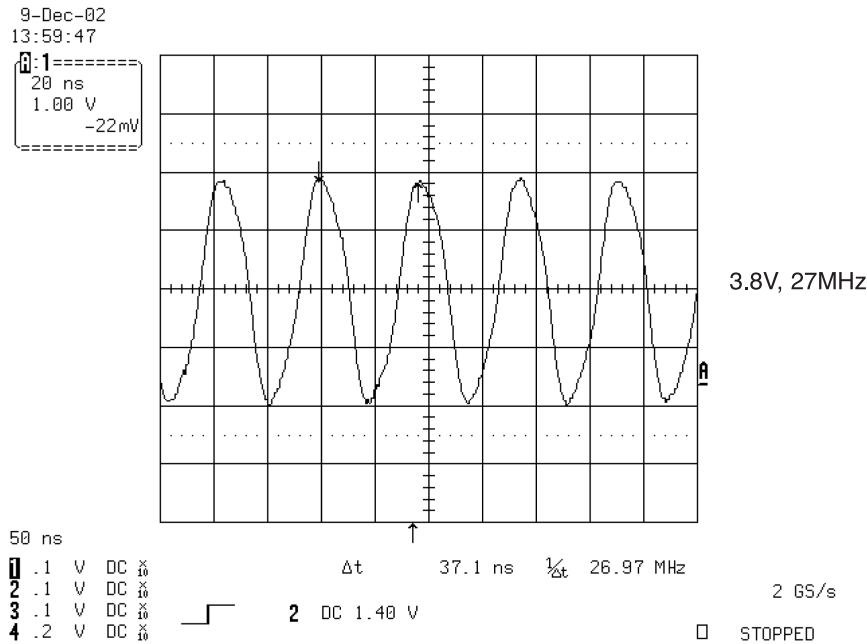

FIG 1-1

2) MT1336 reset is high active

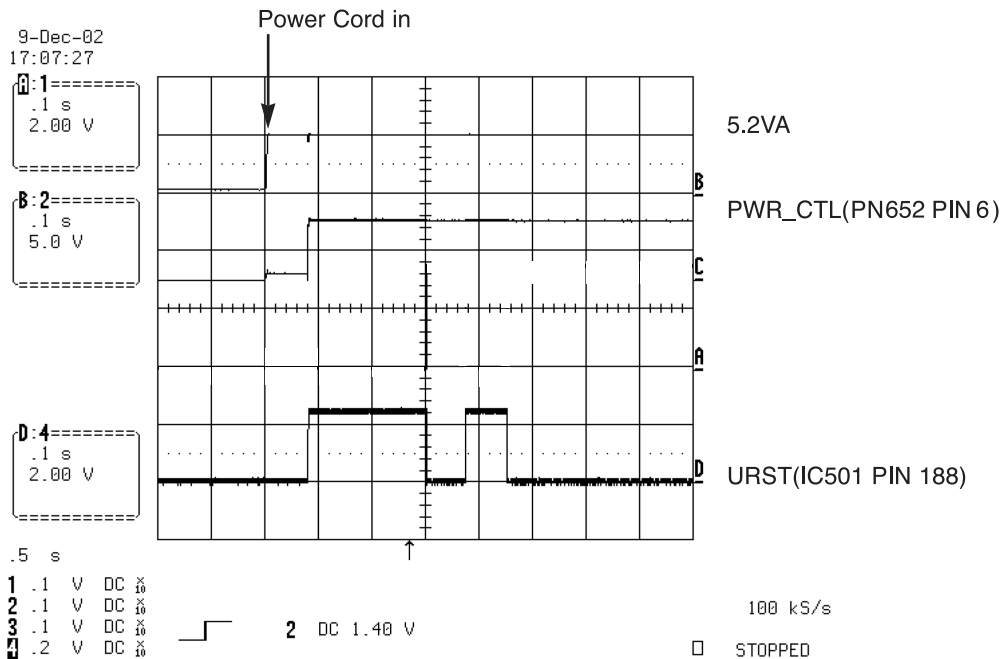

FIG 1-2

3) RS232 waveform during procedure(Downloading)

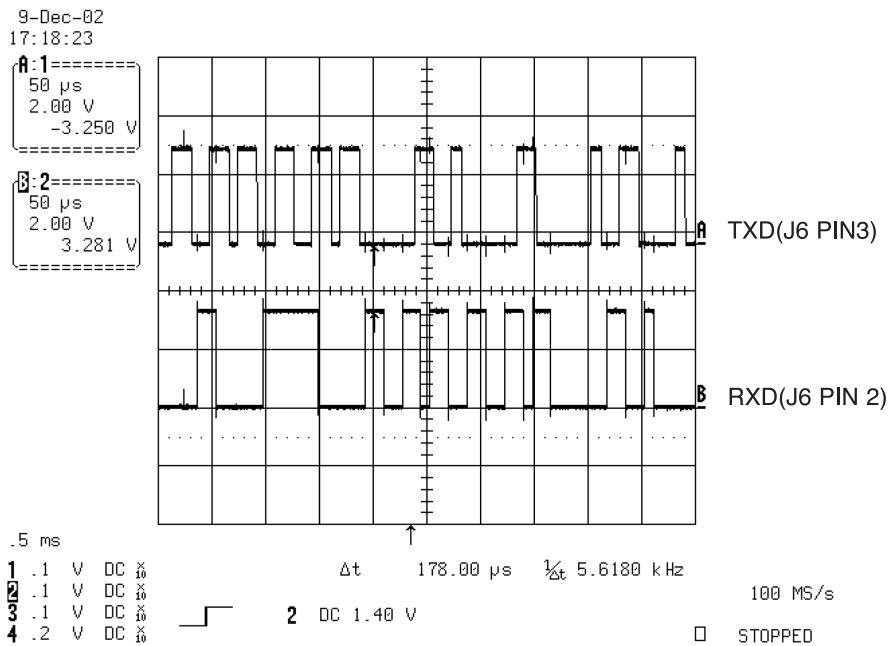

FIG 1-3

4) Flash R/W enable signal during download(Downloading)

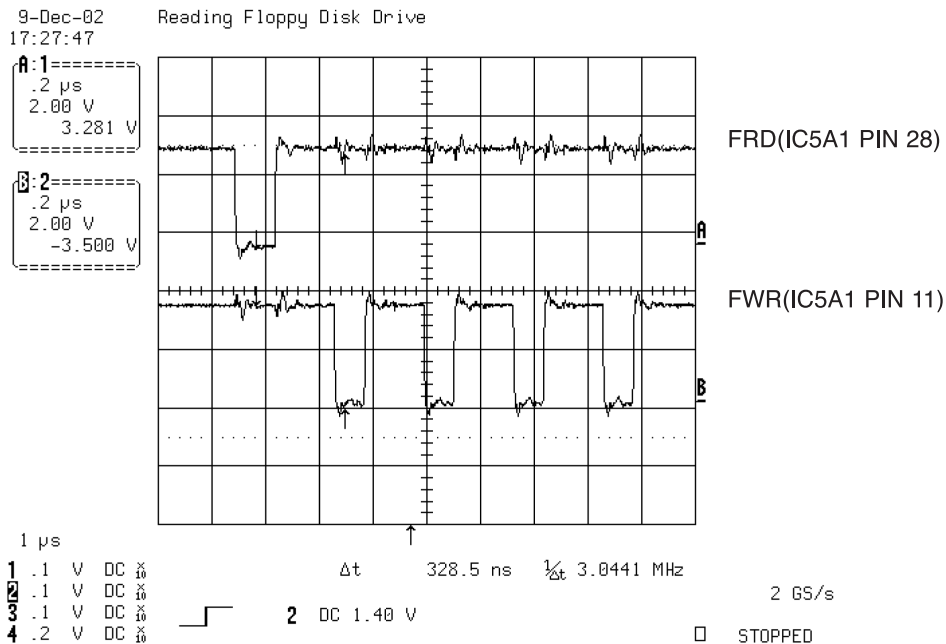

FIG 1-4

2. SDRAM CLOCK

1) MT1379 main clock is at 27MHz(X501)

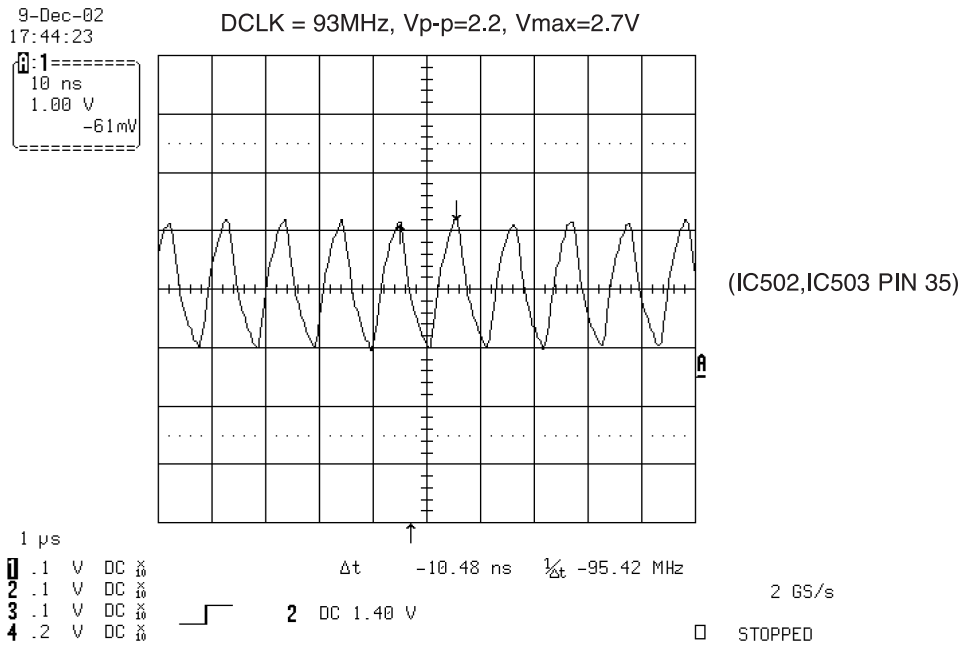

FIG 2-1

3. TRAY OPEN/CLOSE SIGNAL

1) Tray open/close waveform

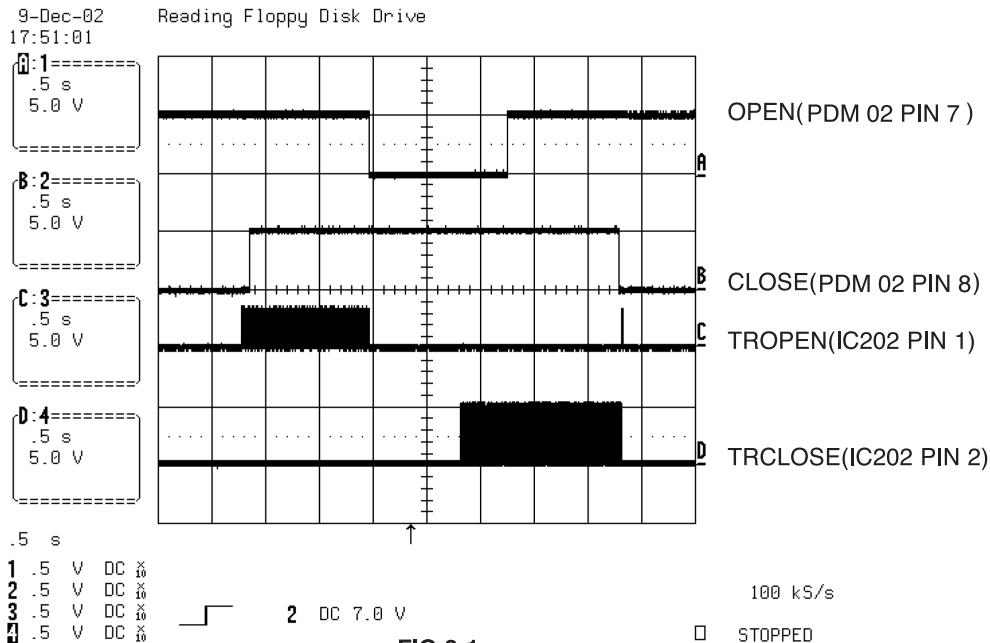

FIG 3-1

2) Tray close waveform

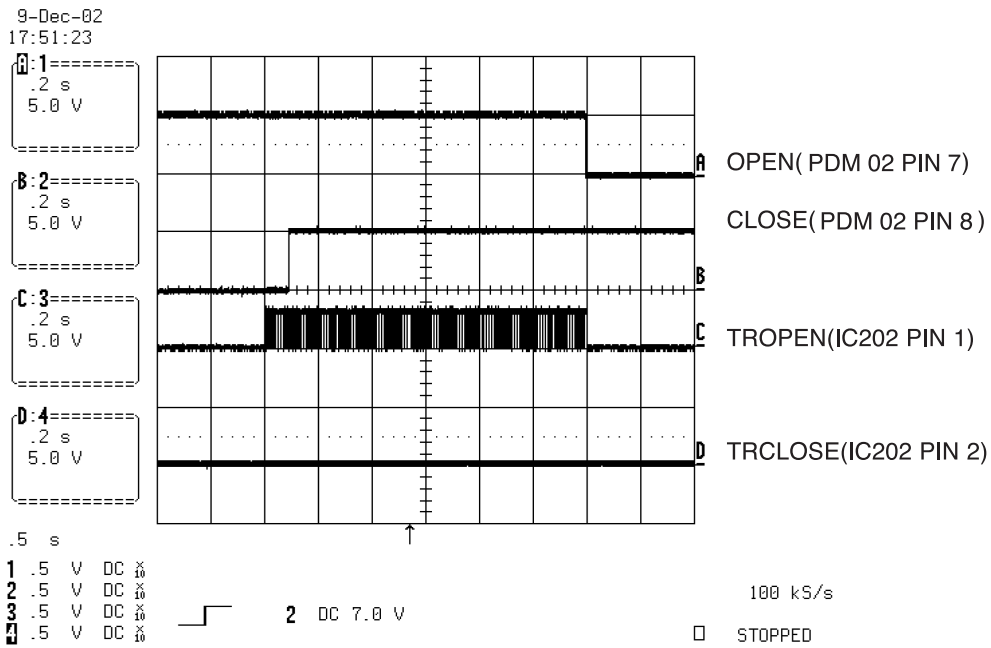

FIG 3-2

3) Tray open waveform

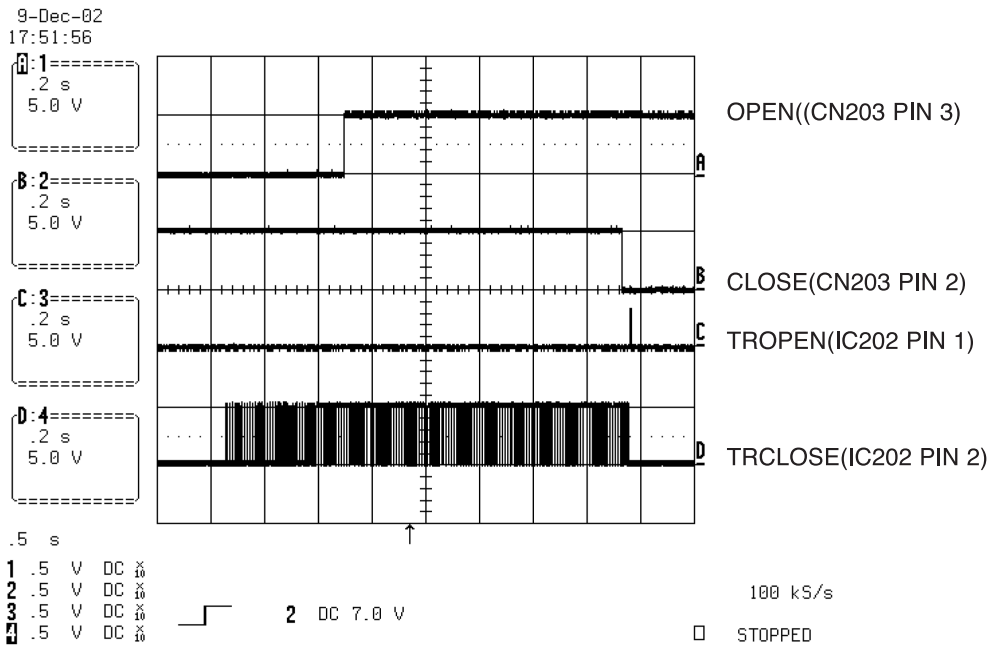

FIG 3-3

4. SLED CONTROL RELATED SIGNAL (NO DISC CONDITION)

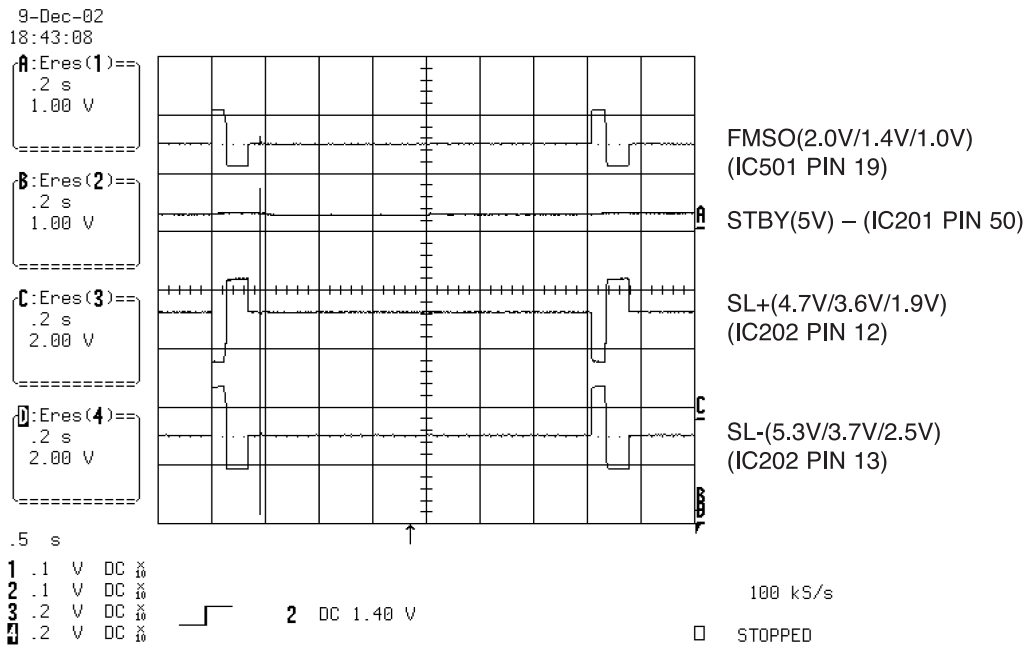

FIG 4-1

5. LENS CONTROL RELATED SIGNAL(NO DISC CONDITION)

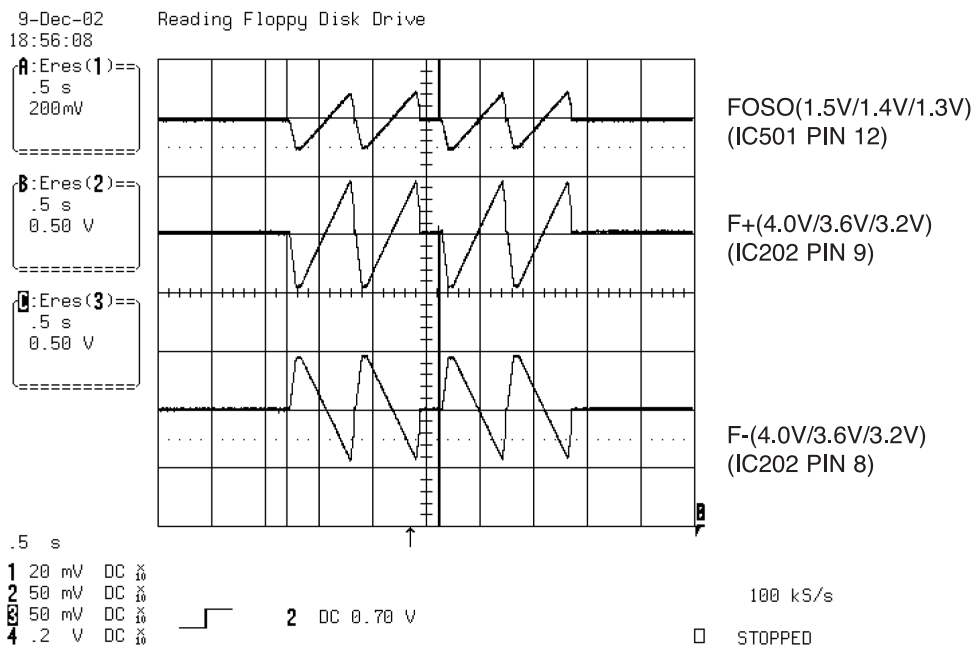

FIG 5-1

6. LASER POWER CONTROL RELATED SIGNAL (NO DISC CONDITION)

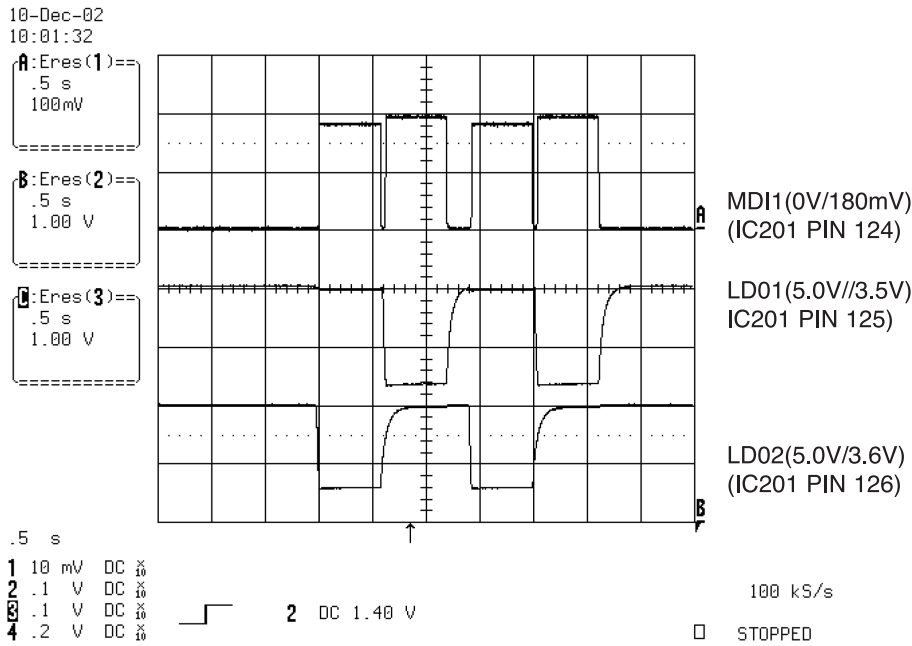

FIG 6-1

7. DISC TYPE JUDGEMENT WAVEFORM

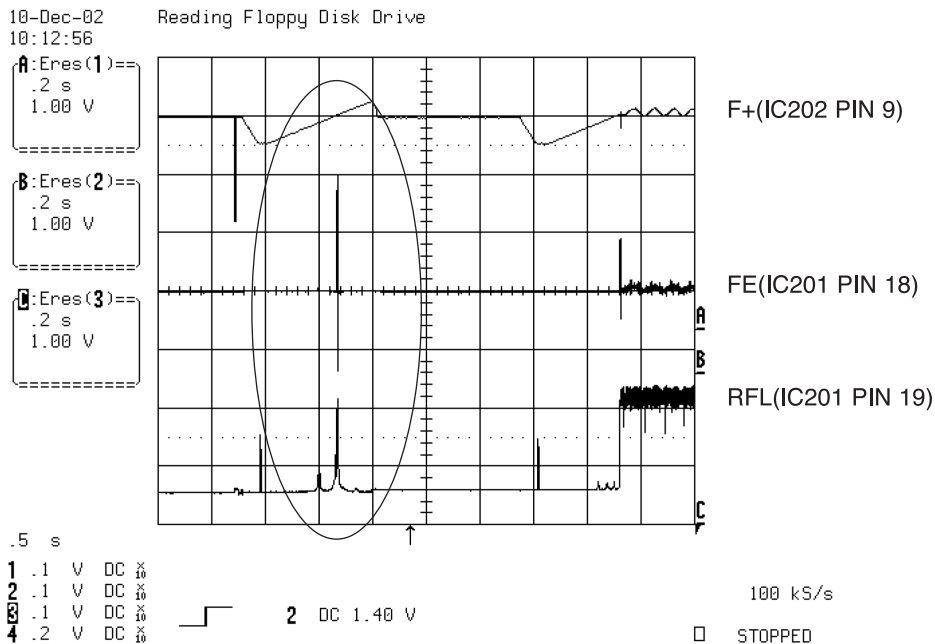

FIG 7-1 (DVD)

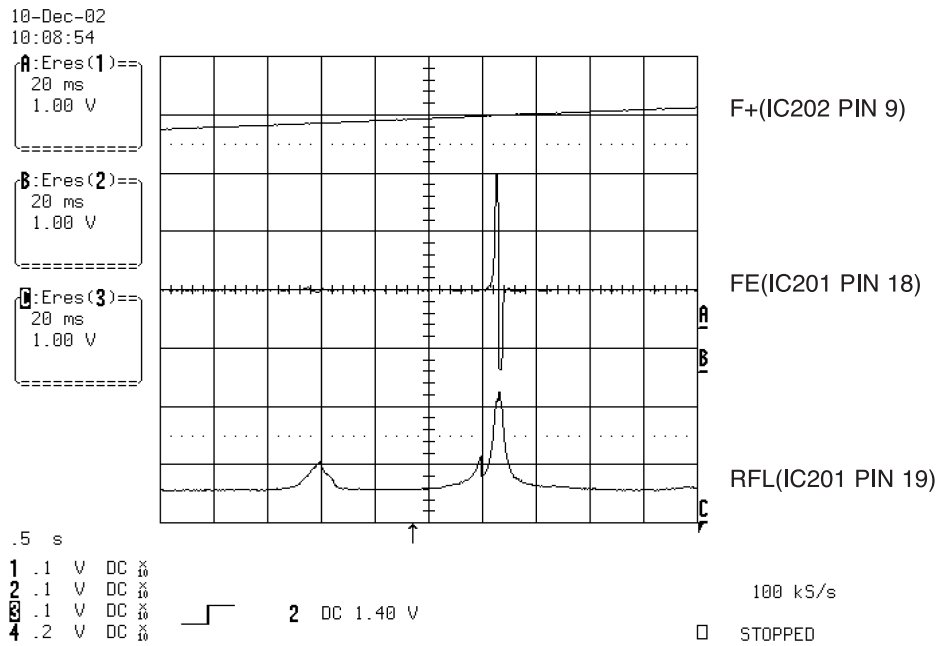

FIG 7-2 (DVD)

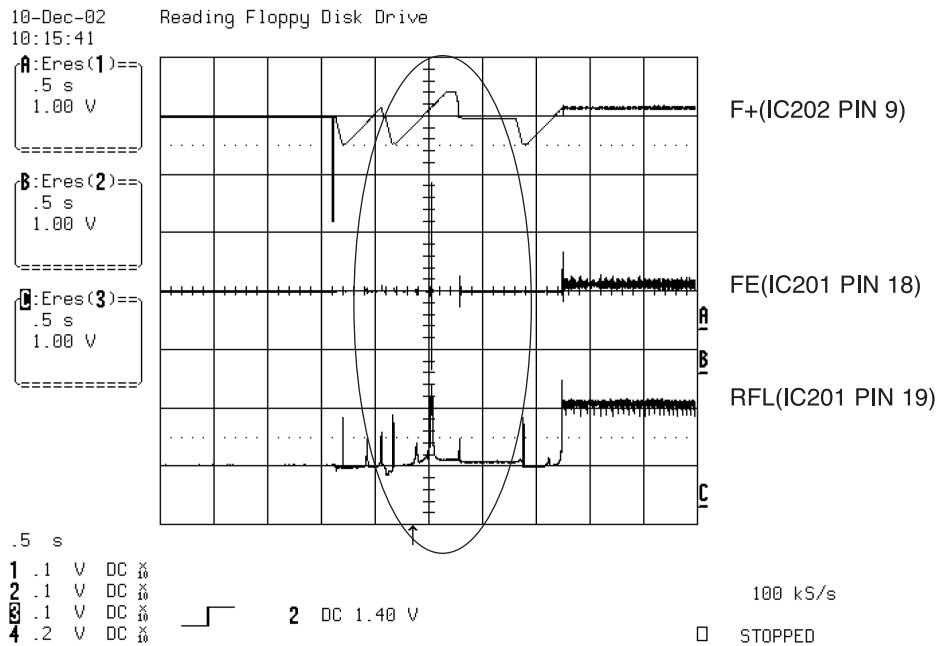

FIG 7-3 (CD)

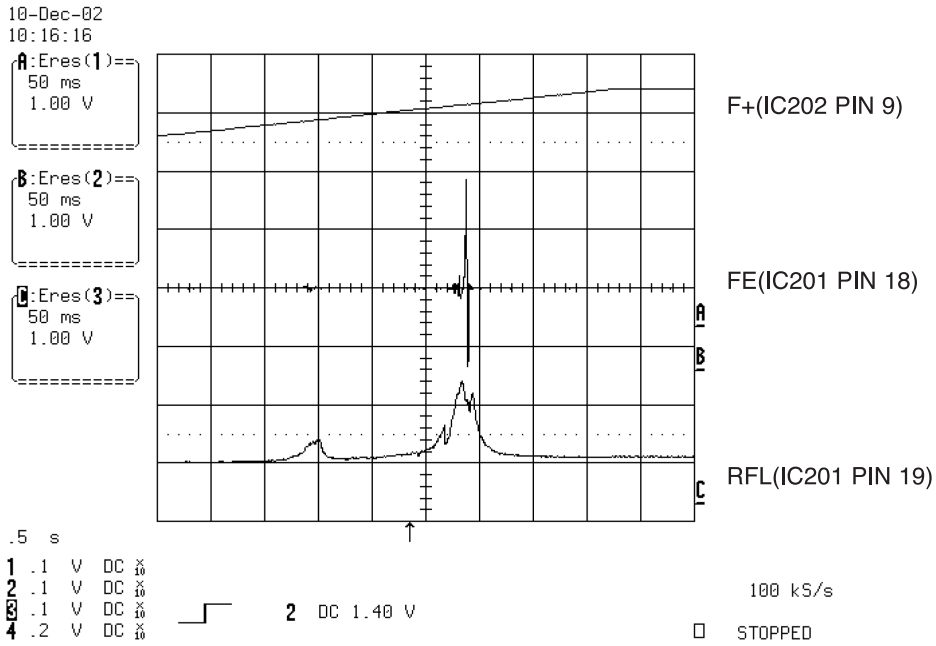

FIG 7-4 (CD)

8. FOCUS ON WAVEFORM

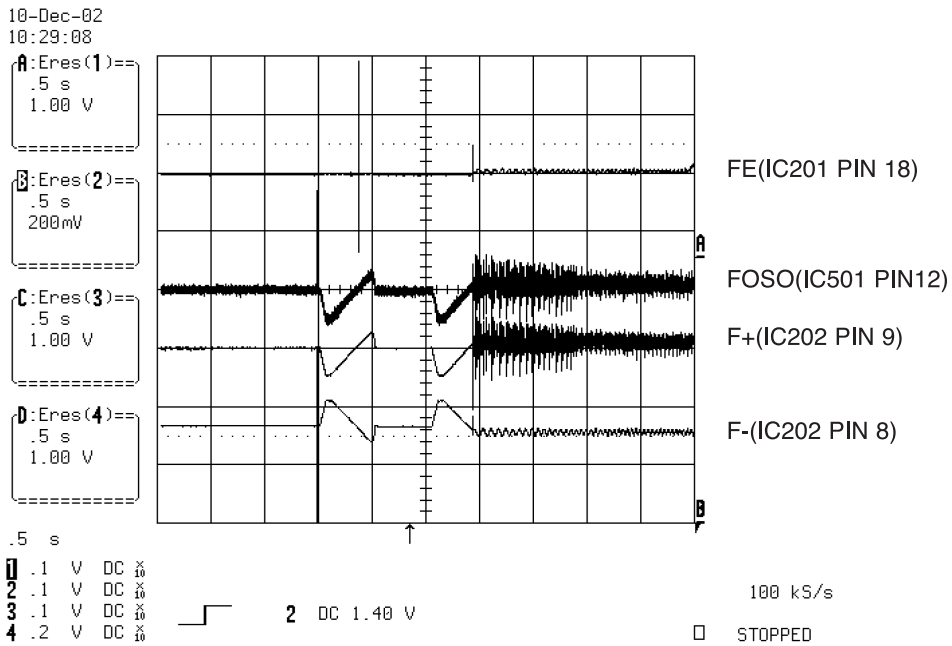

FIG 8-1 (DVD)

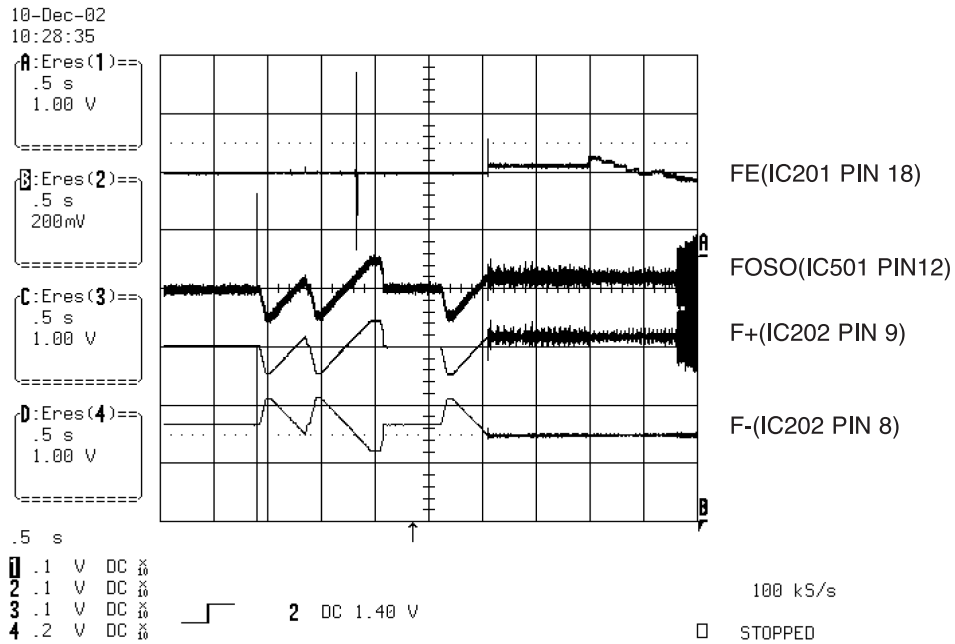

FIG 8-2 (CD)

9. SPINDLE CONTROL WAVEFORM (NO DISC CONDITION)

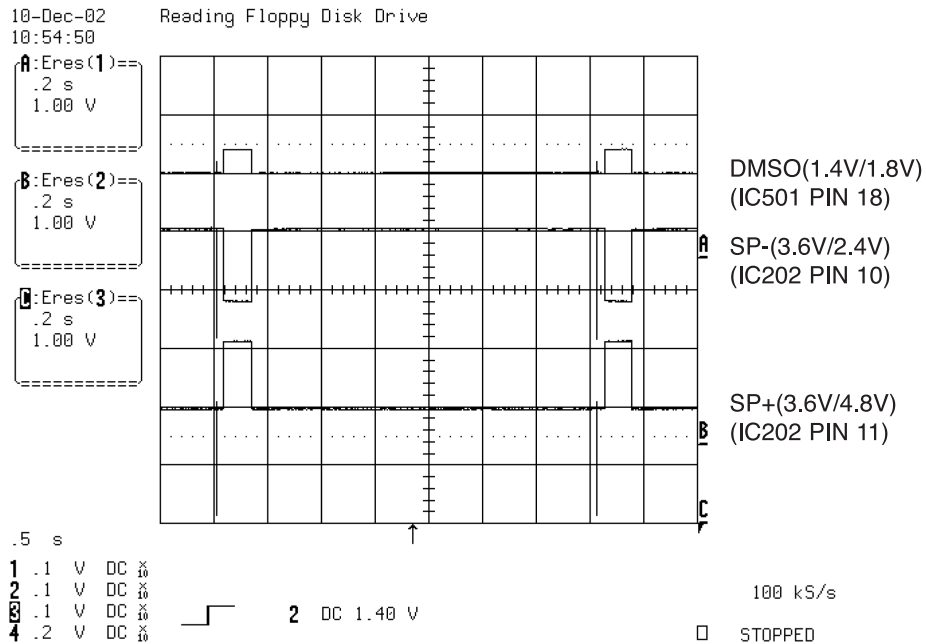

FIG 9-1

10. TRACKING CONTROL RELATED SIGNAL(System checking)

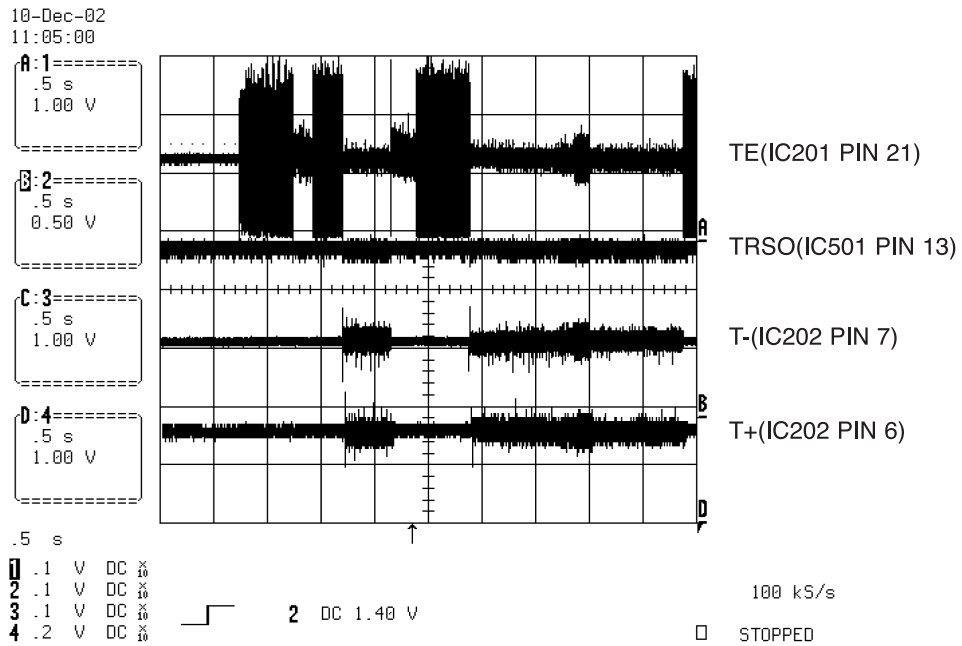

FIG 10-1(DVD)

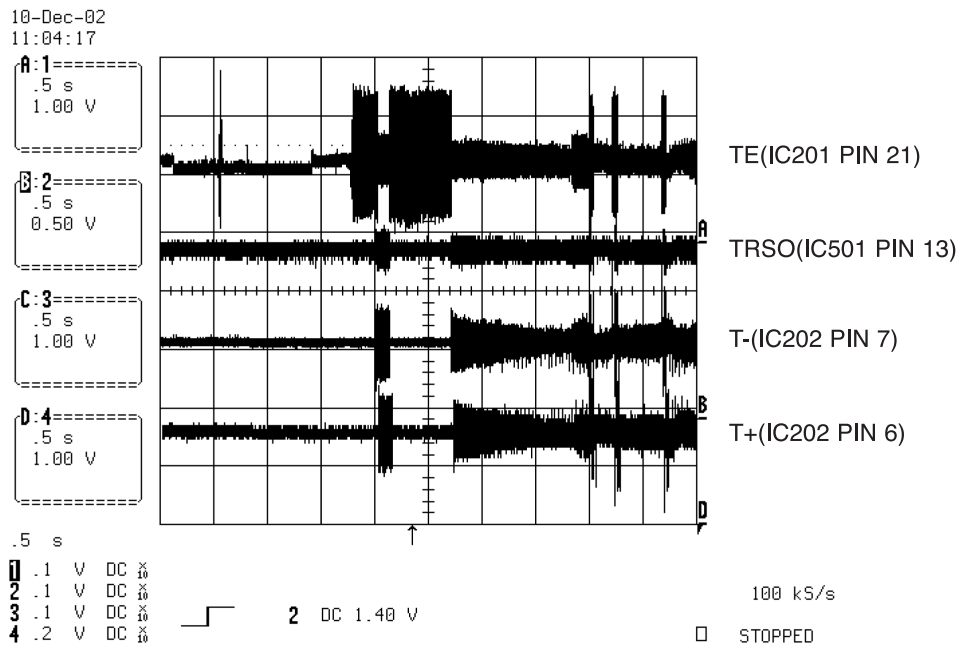

FIG 10-2(CD)

11. RF WAVEFORM

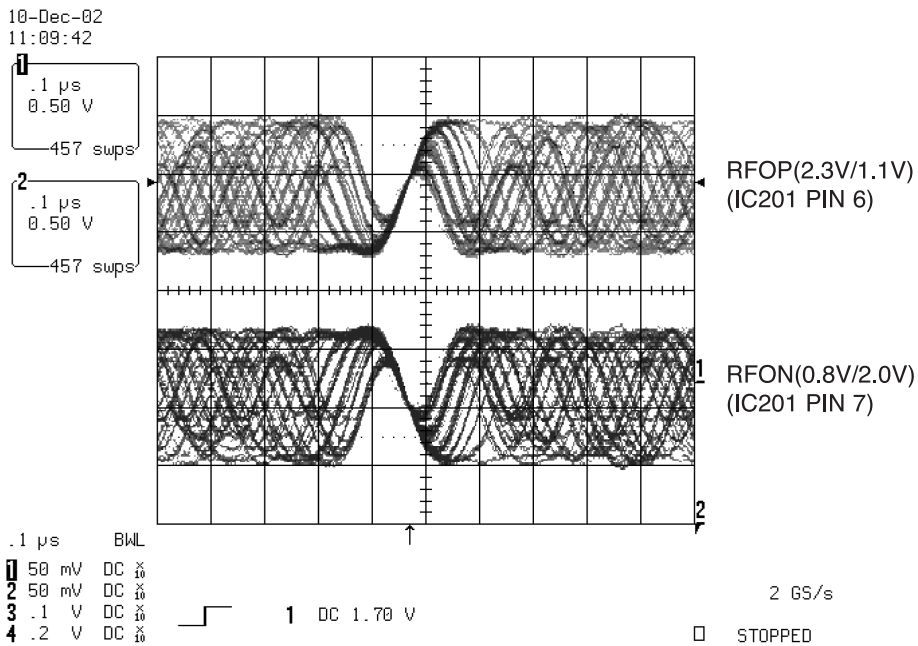

FIG 11-1

12. MT1379 AUDIO OPTICAL AND COAXIAL OUTPUT (ASPDIF)

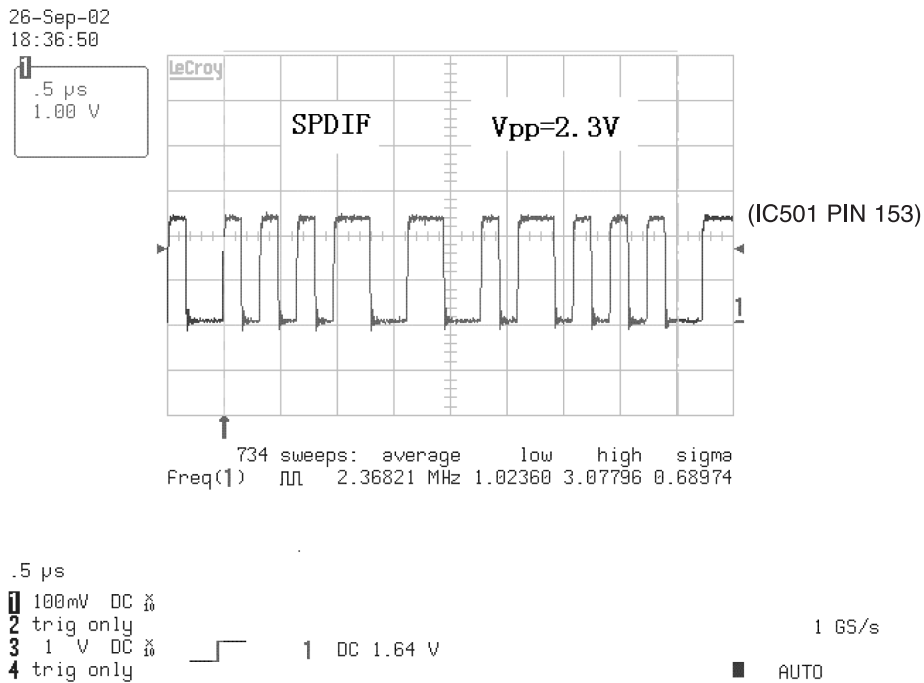

FIG 12-1

13. MT1379 VIDEO OUTPUT WAVEFORM

1) Full colorbar signal(CVBS)

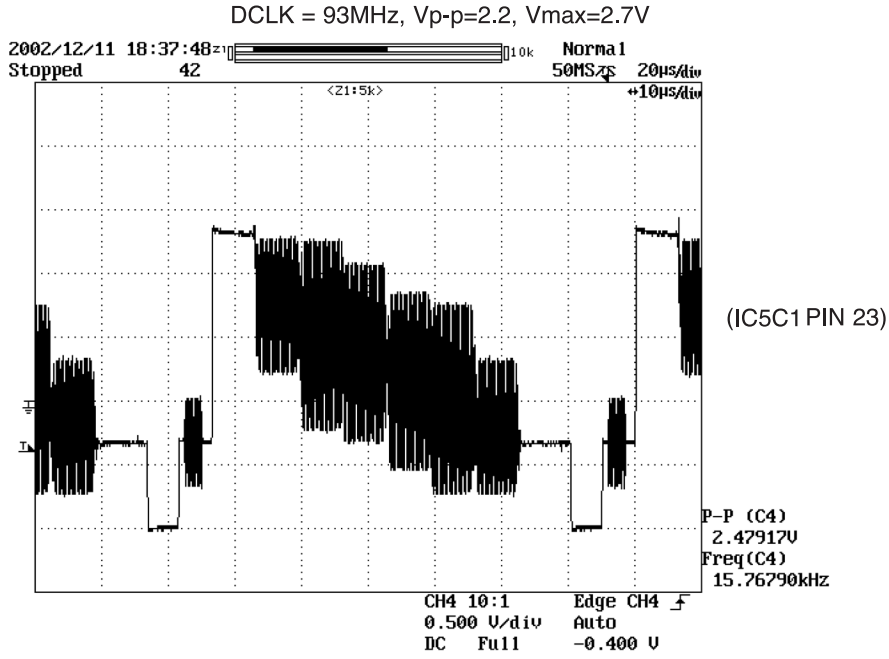

FIG 13-1

2) Y

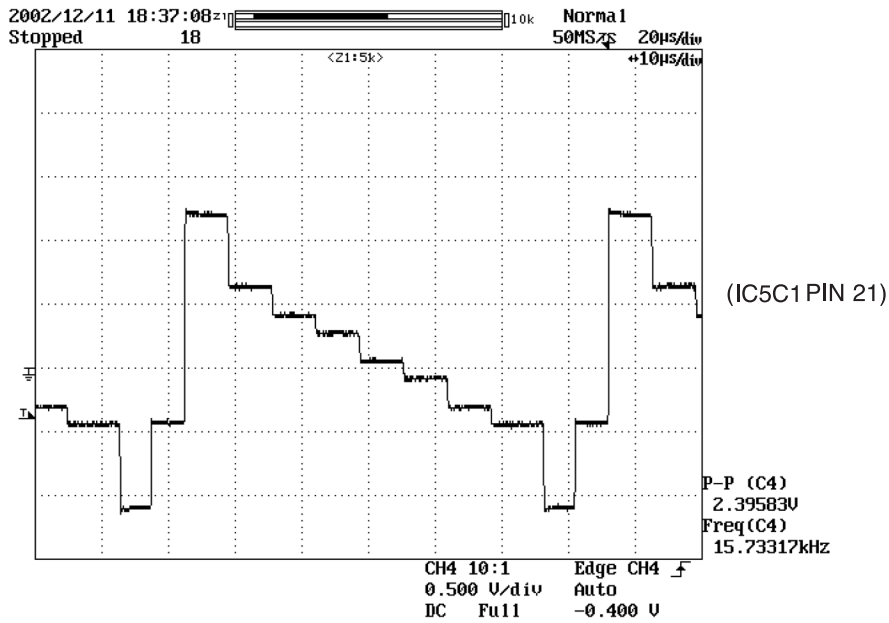

FIG 13-2

3) C

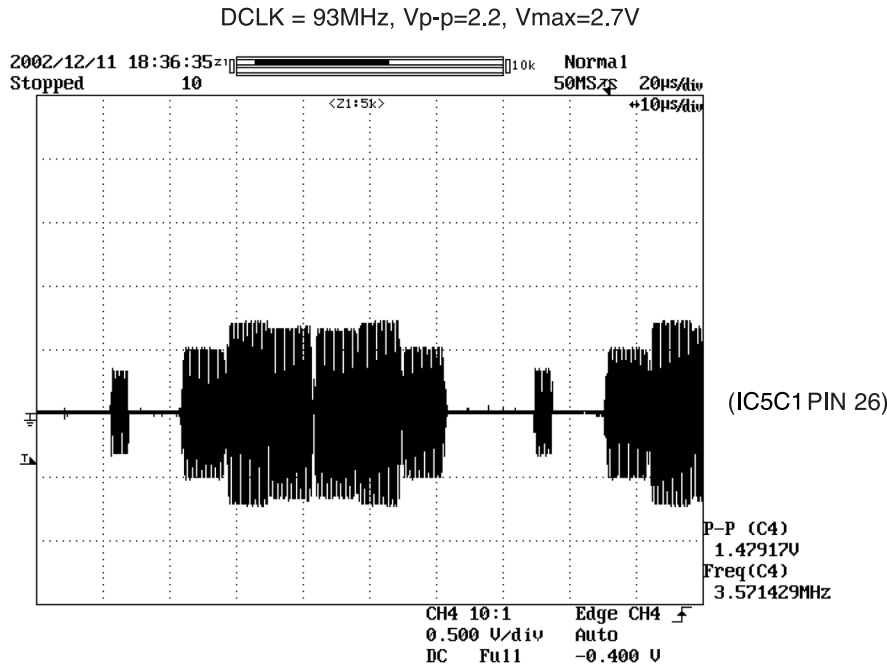

FIG 13-3

14. AUDIO OUTPUT FORM AUDIO DAC

1) Audio related Signal

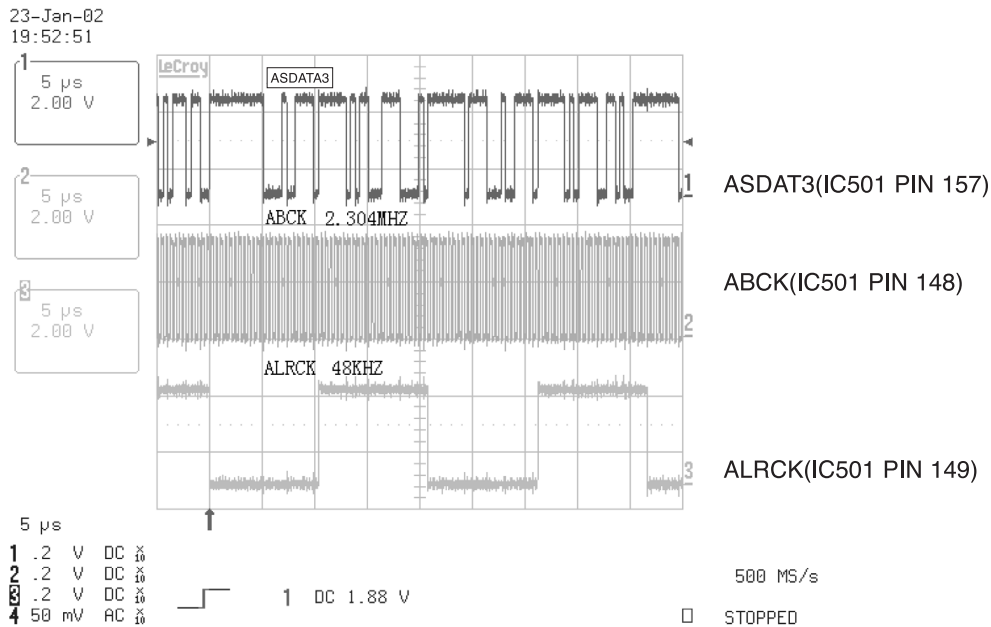
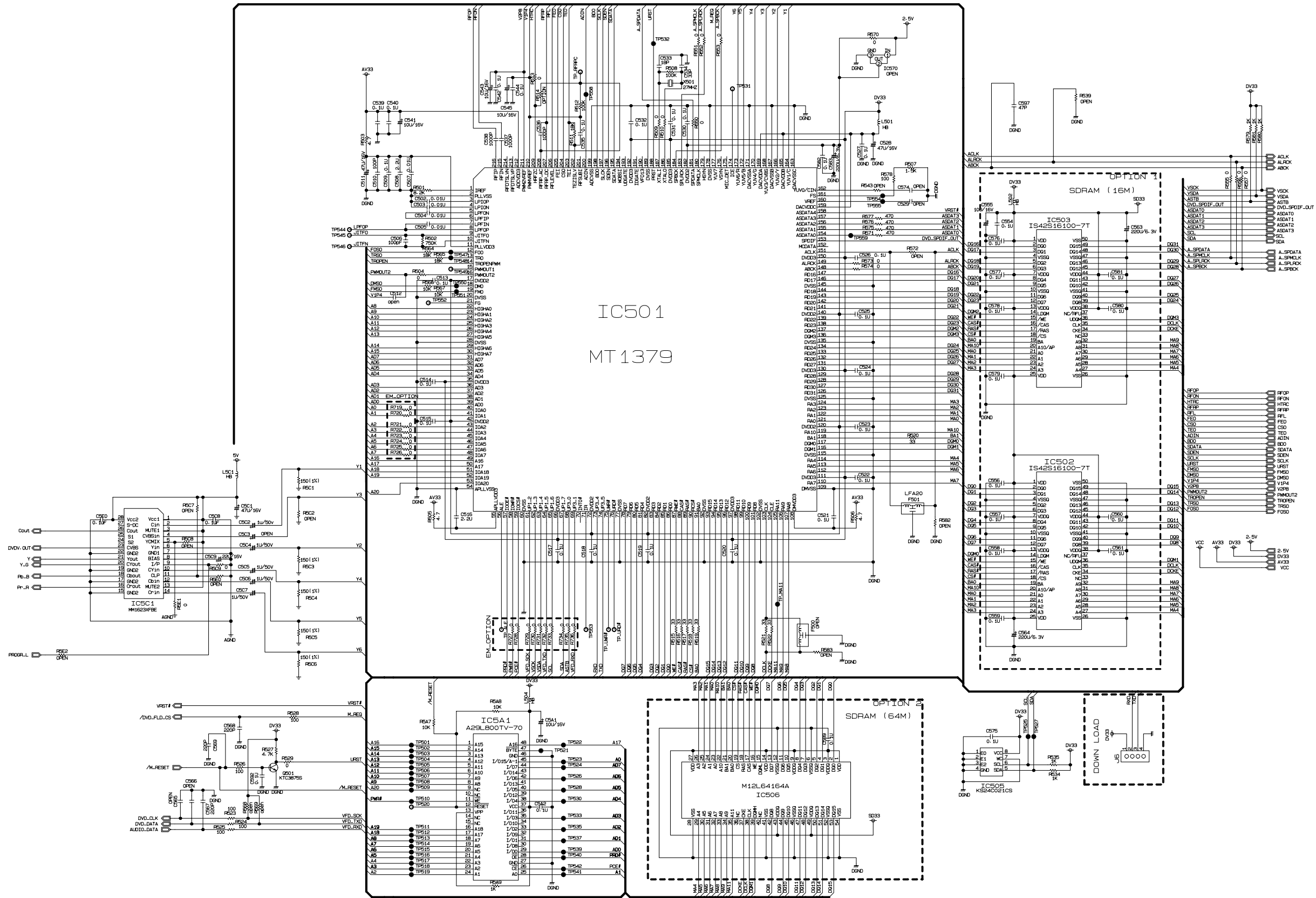

FIG 14-1

DVD PART SCHEMATIC DIAGRAMS

MPEG SCHEMATIC DIAGRAM



• SERVO SCHEMATIC DIAGRAM

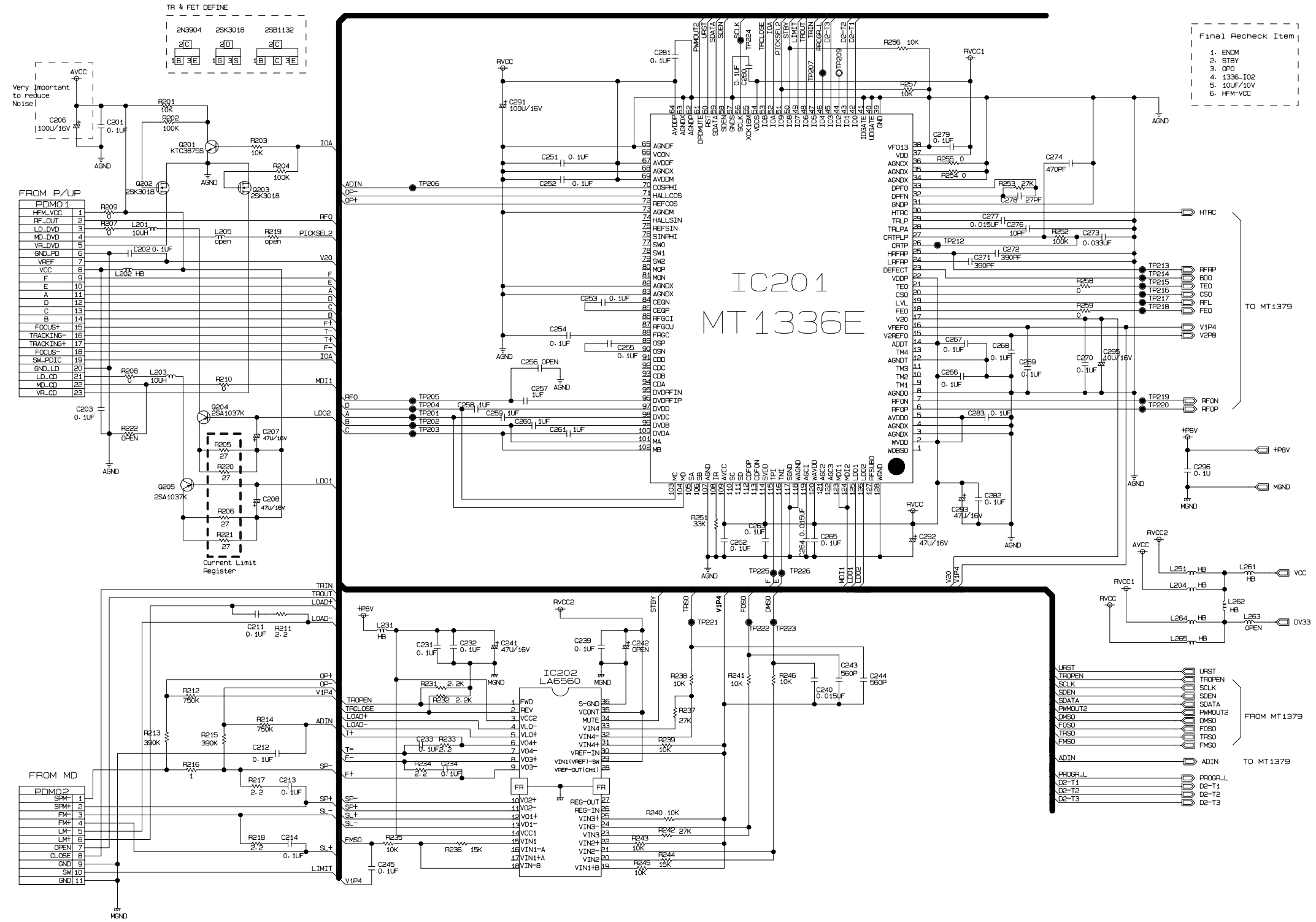

• AUDIO SCHEMATIC DIAGRAM

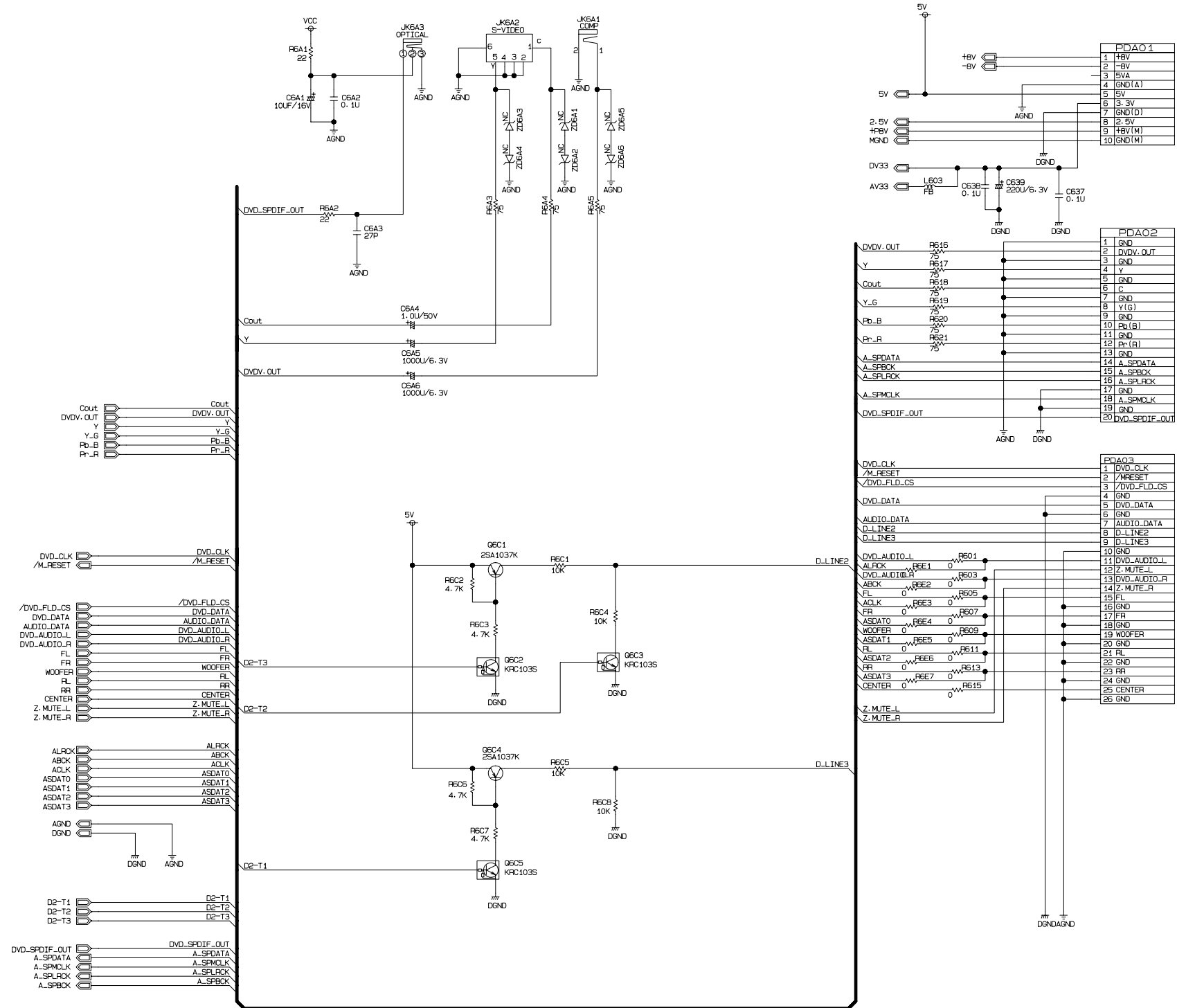

VOLTAGE SHEET (IC& TR)

PIN	IC201(MT1338E)		IC202(MOTOR)		IC401(CS4391)		IC402(AMP)		IC5C1(MM1623XFBE)		IC501(MT1379)		IC502(SDRAM)		IC505(EEPROM)		IC510(BUFFER)	
	STOP	PLAY	STOP	PLAY	STOP	PLAY	STOP	PLAY	STOP	PLAY	STOP	PLAY	STOP	PLAY	STOP	PLAY	STOP	PLAY
1	1.03	2.99	0	0	3.28	3.29	5.52	5.49	5.09	5.08	1.22	1.22	3.27	3.28	0	0	0	0
2	5.11	5.08	0	0	3.28	3.28	5.52	5.48	2.43	2.42	0	0	1.18	1.26	0	0	2.59	2.55
3	0	0	8.04	8.01	0	1.65	5.51	5.47	5.09	5.08	0.96	0.9	1.1	1.52	0	0	0	0
4	0	0	0.12	0.06	1.63	1.64	0	0	1.45	0	2	2.06	0	0	0	0	2.59	2.56
5	5.11	5.07	0	0.06	1.64	1.65	5.51	5.48	0	0	0	1.51	0.66	1.07	3.28	3.29	0	0
6	0	1.95	3.64	3.69	1.59	1.61	5.51	5.48	1.45	1.69	1.48	1.47	0.85	1.12	3.28	3.29	3.24	3.23
7	0	0	3.62	3.61	0	0	5.52	5.47	0	0	0	1.56	3.27	3.28	0	0	0	0
8	0	0	3.64	3.53	3.28	0	12.03	12.03	2.47	2.46	3.2	1.52	0.51	0.97	3.28	3.29	0.14	0.08
9	5.11	0	3.6	3.76	3.28	3.29			0	0	0.12	0.06	3.06	0			0	0
10	5.11	5.08	3.62	2.43	0	0			1.14	1.76	0.12	0.06	0	0			0	0
11	5.11	5.08	3.63	4.85	5.01	5.01			0	0	3.25	3.25	0.06	0.98			0.15	0.09
12	0	0	3.62	3.72	2.31	2.31			2.42	2.42	1.41	1.49	3.18	0.87			0	0
13	5.11	0	3.64	3.57	4.96	0			5.09	5.08	1.41	1.41	3.27	3.28			0.15	0.08
14	5.11	5.08	8.04	8.01	1.42	2.41			2.43	2.42	0	0	2.94	2.56			5.19	5.19
15	2.84	2.81	1.45	1.48	2.4	2.39			0	0	1.42	1.42	0.47	0.42			0.14	0.09
16	1.45	1.43	0.27	1.39	0	0			2.49	2.47	3.3	0	2.93	3.01			5.25	5.24
17	2.08	2.07	0.29	1.32	5.11	5.09			0	0	2.53	2.53	3.21	3.22			0.15	0.08
18	1.37	1.42	1.45	1.43	2.41	2.41			2.48	2.47	1.42	2.27	2.87	2.95			5.23	5.23
19	0.69	2.3	1.45	1.43	2.43	2.43			0	0	1.42	1.39	0.15	1.32			0	0
20	2.4	0	1.45	0.82	0	0			1.18	2.3	0	0	0	0.05			5.25	5.25
21	2.35	0	1.45	1.43					1.76	2.17	2.61	2.58	3.09	1.32				
22	5.11	5.08	1.45	1.43					0	0	0.75	1.46	3.09	1.32				
23	0	0	1.47	1.37					1.76	2.24	2.83	1	3.09	1.32				
24	2.59	3.2	1.45	1.43					0	0	1.9	0.89	3.09	1.33				
25	0.19	1.88	1.45	1.43					0	0	1.72	0.39	3.27	3.29				
26	1.58	0	0.95	0.91					0	0	0.68	0.31	0	0				
27	2.56	3.13	0	0					0.06	0.05	2.84	3.16	0.15	1.36				
28	2	2.01	1.45	1.43					5.09	0	0	0	1.84	2.36				
29	2	2.06	5.15	5.11							2.85	0.66	1	2.32				
30	2.96	1.52	1.45	1.43							1.83	0.49	0.54	1.75				
31	0	0	1.45	1.43							0.91	1.39	0.06	0.06				
32	0.06	2.07	1.45	1.43							1.43	1.2	0.05	0.06				
33	0.07	2.07	1.46	1.45							1.51	1.57	0	0				
34	0	0	5.08	5.06							1.51	1.43	0.73	1.26				
35	0	0	5.15	5.11							3.3	3.29	1.48	1.55				
36	0	0	0	0							0.81	1.26	2.91	2.53				
37	5.13	0									1.45	1.02	0.07	0				
38	0	0									1.82	1.6	3.27	3.28				
39	0	0									1.2	1.5	1.06	1.05				
40	0	0									2	2.06	0.47	0.98				
41	0	0									2.17	1.95	0	0				
42	5.12	5.09									2.53	2.52	0	0.6				
43	5.12	5.09									1.96	1.9	1.12	1.24				
44	5.12	5.09									1.79	1.9	3.27	3.28				
45	5.12	5.09									0.8	1.72	1.21	0.99				
46	5.12	5.09									0.8	1.96	1.31	1.34				
47	0	0									0.8	1.84	0	0				
48	5.12	5.09									3.3	2.63	1.43	1.44				
49	5.12	0									0	0.13	0.88	1.01				
50	5.08	5.06									0	0.07	0	0				
51	5.09	5.07									0	0						
52	5.1	0									0	0						
53	0	0									0	0						
54	5.13	0									0	0						
55	0.09	0.2									3.25	3.27						
56	1.61	0									1.21	1.18						
57	0	0									0	0						
58	0	0									3.29	3.29						
59	0	0									0	0						
60	0	0									0	0						
61	3.28	0									2.59	2.57						
62	0	0									2.58	2.58						
63	0	0									0	0						
64	0	0									2.59	2.56						
65	0	0									3.29	3.29						
66	0.26	0									3.3	3.29						
67	5.12	5.08									3.29	3.29						
68	0	0									2.57	2.56						
69	5.12	0									5.19	5.18						
70	3.21	2.03									2.59	2.57						
71	3.46	2.2									0.12	0.08						
72	2.81	0									2.53	2.52						
73	0	0									2.59	2.57						
74	0.21	0.09									3.29	3.29						
75	0.22	0									2.61	2.61						
76	0	0.1									3.27	3.24						
77	0.21	0.09									0	0						
78	0.23	0.09									0.94	1.04						
79	0.21	0.08									0.78	1.06						
80	0.23	0.08									0.89	1.15						

PRINTED CIRCUIT DIAGRAM

DVD P.C. BOARD(SOLDER SIDE)

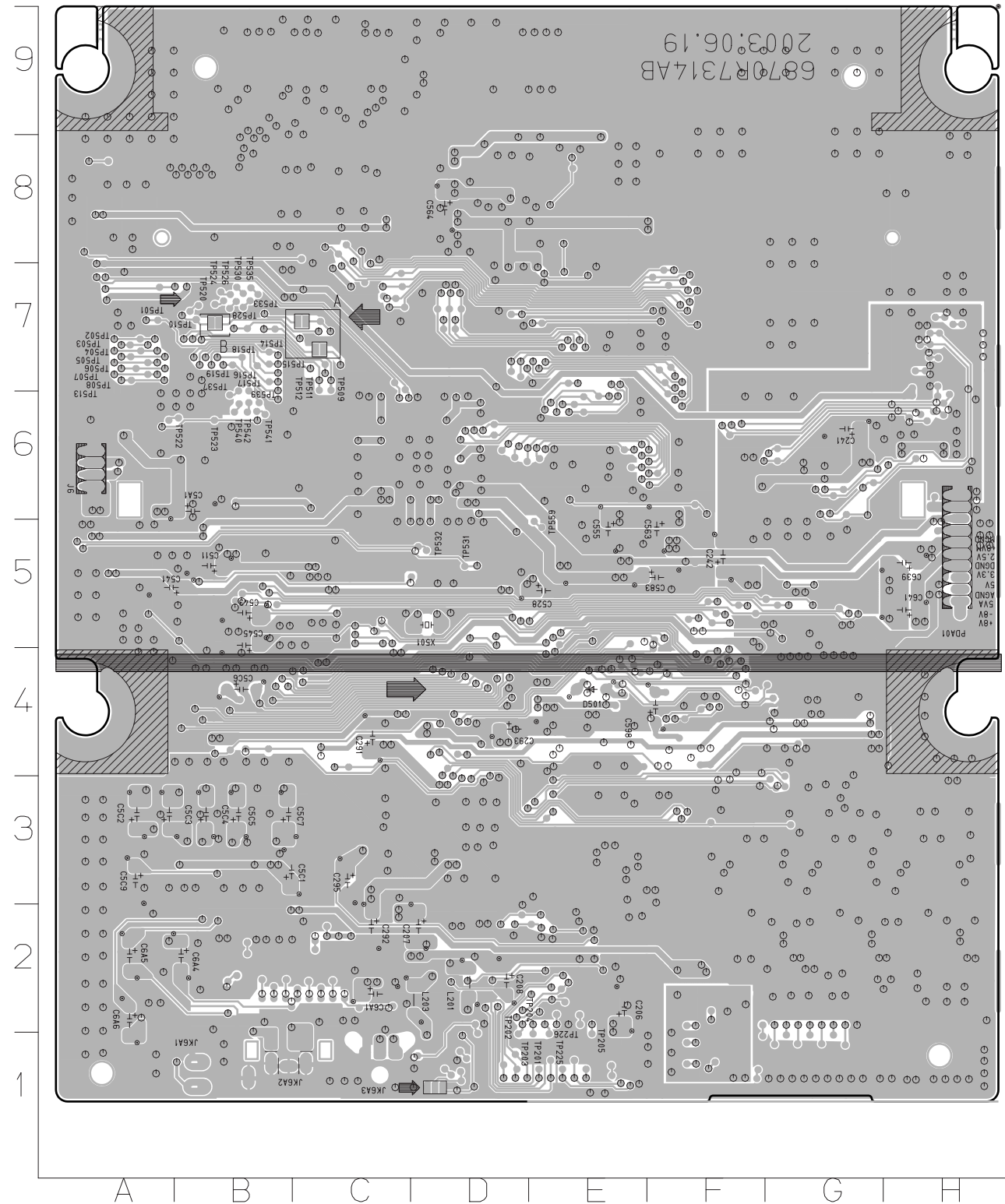

TP201	E1
TP202	D1
TP203	D1
TP204	E1
TP205	E1
TP225	E1
TP226	E1
TP501	A7
TP502	A7
TP503	A7
TP504	A7
TP505	A7
TP506	A7
TP507	A7
TP508	A7
TP509	C7
TP510	B7
TP511	C7
TP512	C7
TP513	A7
TP514	B7
TP515	B7
TP516	B7
TP517	B7
TP518	B7
TP519	B7
TP520	B7
TP522	B6
TP523	B6
TP524	B7
TP525	F4
TP526	B7
TP527	F4
TP528	B7
TP530	B7
TP531	D5
TP532	D5
TP533	B7
TP535	B7
TP537	B6
TP539	B6
TP540	B6
TP541	B6
TP542	B6
TP559	E5

• DVD P.C. BOARD (COMPONENT SIDE)

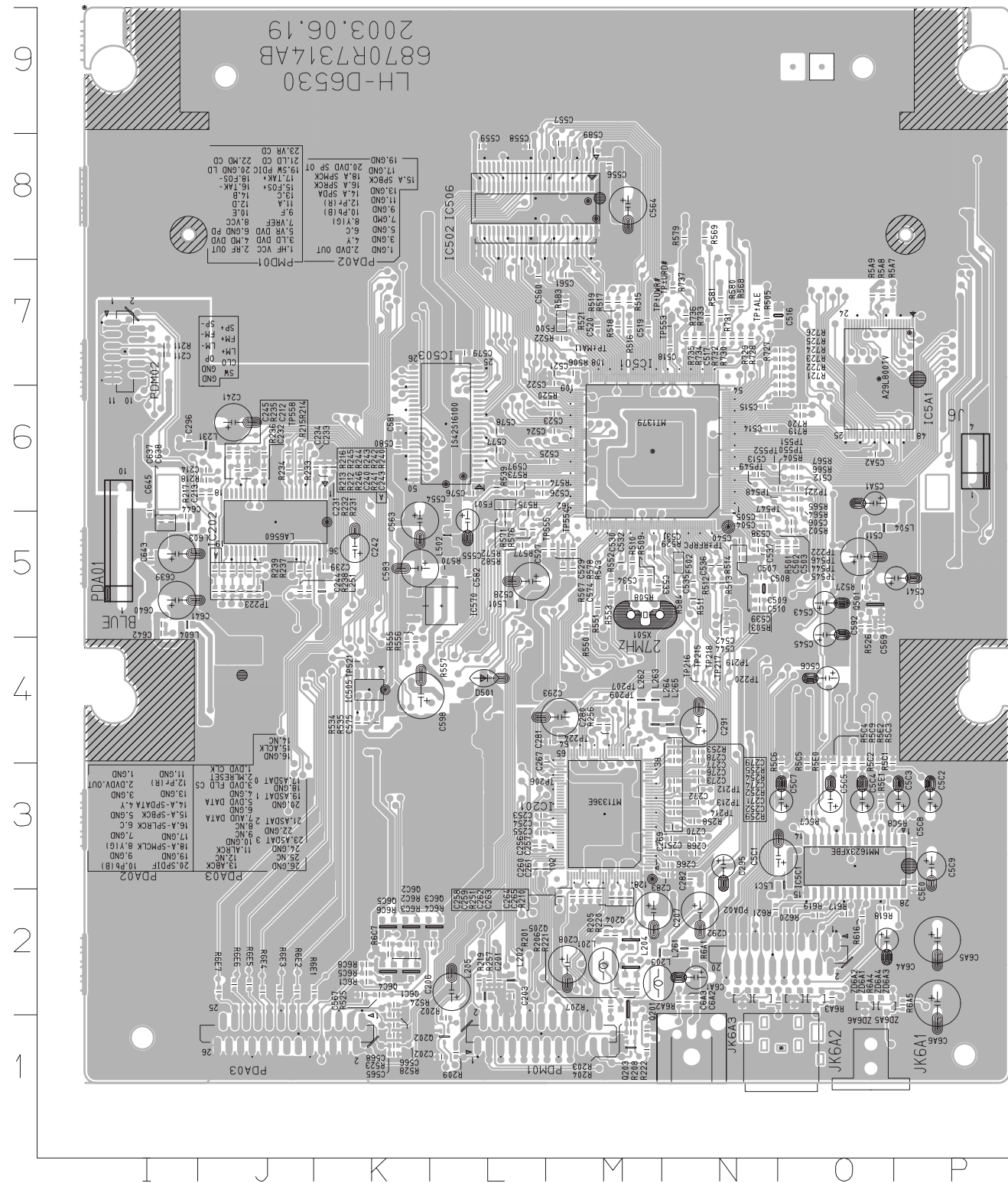

C201	L2	C504	N5	C577	L6	L205	L2	R239	J5	R567	O6	R720	O6
C202	L1	C505	N5	C578	L6	L231	J6	R240	J5	R568	N7	R721	O6
C203	L2	C506	O5	C579	L7	L251	K5	R241	J5	R569	N8	R722	O6
C206	L2	C507	N5	C580	K6	L261	N2	R242	J5	R570	L5	R723	O7
C207	M2	C508	N5	C581	K6	L262	M4	R243	J5	R571	L5	R724	O7
C208	M2	C509	N5	C582	L5	L263	M4	R244	J5	R572	L5	R725	O7
C211	17	C510	N5	C583	K5	L264	M4	R245	J5	R573	L6	R726	O7
C212	J6	C511	O5	C589	M8	L265	N4	R246	J5	R574	L6	R727	N7
C213	J6	C512	O6	C592	O5	L501	L5	R251	M2	R575	L5	R728	N7
C214	J6	C513	N6	C597	L6	L502	L5	R252	N3	R576	L5	R729	N7
C231	K6	C514	N6	C598	K4	L504	O5	R253	N4	R577	L5	R730	N7
C232	J6	C515	N6	C5A1	O6	L5C1	O3	R254	N4	R578	M5	R731	N7
C233	J6	C516	O7	C5A2	O6	L603	I5	R255	N4	R579	N8	R732	N7
C234	J6	C517	N7	C5C1	O3	L604	I5	R256	M4	R580	N7	R733	N7
C239	K5	C518	N7	C5C2	P3	PDA01	I5	R257	L2	R581	N7	R734	N7
C240	J5	C519	M7	C5C3	P3	PDA02	N2	R258	N3	R582	L5	R735	N7
C241	J6	C520	M7	C5C4	O3	PDA03	J1	R259	N3	R583	M7	R736	N7
C242	K5	C521	M7	C5C5	O3	PDM01	L1	R501	O5	R584	N5	R737	N7
C243	J5	C522	M7	C5C6	O4	PDM02	I7	R502	O5	R5A7	O7	TP206	M3
C244	J5	C523	M6	C5C7	O3	Q201	M2	R503	N5	R5A8	O7	TP207	M4
C245	J6	C524	M6	C5C8	P3	Q202	L1	R504	O6	R5A9	O7	TP209	M4
C251	N3	C525	M6	C5C9	P3	Q203	M1	R505	N7	R5C1	O3	TP212	N3
C252	N3	C526	L6	C5E0	P3	Q204	M2	R506	M7	R5C2	O3	TP213	N3
C253	L3	C527	L5	C637	I5	Q205	M2	R507	M5	R5C3	O3	TP214	N3
C254	L3	C528	L5	C638	I5	Q501	O5	R508	M5	R5C4	O3	TP215	N4
C255	L3	C529	M5	C639	I5	Q6C1	K2	R509	M5	R5C5	O3	TP216	N4
C256	L3	C530	M5	C640	I5	Q6C2	K2	R510	M5	R5C6	O3	TP217	N4
C257	L3	C531	M5	C641	I5	Q6C3	L2	R511	N5	R5C7	O3	TP218	N4
C258	M2	C532	M5	C642	I5	Q6C4	K2	R512	N5	R5C8	O3	TP219	N4
C259	M2	C533	M5	C643	I5	Q6C5	K2	R513	N5	R5C9	O3	TP220	N4
C260	L3	C534	M5	C644	I5	R201	M2	R514	N5	R5E0	O3	TP221	O6
C261	L3	C535	N5	C645	I6	R202	L1	R515	M7	R5E1	O3	TP222	O5
C262	M2	C536	N5	C6A1	N2	R203	M1	R516	M7	R5E2	O3	TP223	J5
C263	M2	C537	N5	C6A2	N2	R204	M1	R517	M7	R616	O2	TP224	M4
C264	M2	C538	N5	C6A3	N2	R205	M2	R518	M7	R617	O2	TP521	K4
C265	M2	C539	N5	C6A4	O2	R206	M2	R519	M7	R618	O2	TP544	O5
C266	N3	C540	N5	C6A5	P2	R207	M2	R520	M6	R619	O2	TP545	O5
C267	M4	C541	P5	C6A6	P2	R208	M1	R521	M7	R620	O2	TP546	O5
C268	N3	C542	N5	D501	L4	R209	L1	R522	M7	R621	N2	TP547	N6
C269	N3	C543	O5	F500	M7	R210	M2	R523	K1	R6A1	N2	TP548	O6
C270	N3	C544	N5	F501	L6	R211	I7	R524	K2	R6A2	N2	TP549	N6
C271	N3	C545	O5	F502	N5	R212	J5	R525	K2	R6A3	O2	TP550	O6
C272	N3	C554	L6	IC201	M3	R213	J5	R526	O5	R6A4	O2	TP551	O6
C273	N3	C555	L5	IC202	J5	R214	J6	R527	O5	R6A5	P2	TP552	N6
C274	N3	C556	M8	IC501	M6	R215	J6	R528	K1	R6C1	K2	TP553	N7
C276	N3	C557	M8	IC502	L8	R216	J5	R529	M5	R6C2	K2	TP554	M5
C277	N3	C558	L8	IC503	L6	R217	J6	R534	K4	R6C3	K2	TP555	M5
C278	N4	C559	L8	IC505	K4	R218	J6	R535	K4	R6C4	L2	TP558	J6
C279	N4	C560	L7	IC506	L8	R219	L2	R539	L6	R6C5	K2	TP±ALE	N7
C280	M4	C561	M7	IC570	L5	R220	M2	R543	M5	R6C6	K2	TP±MA11	M7
C281	M4	C563	K5	IC5A1	O7	R221	M2	R550	M5	R6C7	K2	TP±RFRPN5	
C282	N3	C564	M8	IC5C1	O3	R222	M1	R551	M5	R6C8	K2	TP±URD#N7	
C283	N3	C565	K1	J6	P6	R231	K6	R552	M5	R6E1	K2	TP±UWR#N7	
C291	N4	C566	K1	JK6A1	O1	R232	K6	R553	M5	R6E2	J2	X501	M5
C292	N2	C567	K2	JK6A2	O1	R233	J6	R555	K4	R6E3	J2	ZD6A1	N2
C293	M4	C568	K1	JK6A3	N1	R234	J6	R556	K4	R6E4	J2	ZD6A2	N2
C295	N3	C569	O5	L201	M2	R235	J6	R557	L4	R6E5	J2	ZD6A3	O2
C296	16	C574	M5	L202	L2	R236	J6	R564	O6	R6E6	J2	ZD6A4	O2
C502	O5	C575	K4	L203	M2	R237	J6	R565	O6	R6E7	J2	ZD6A5	O2
C503	O5	C576	L6	L204	M2	R238	J5	R566	O6	R719	O6	ZD6A6	O2

SECTION 4. EXPLODED VIEWS

□ CABINET AND MAIN FRAME SECTION

NOTE) Refer to "SECTION 6 REPLACEMENT PARTS LIST" in order to look for the part number of each part.

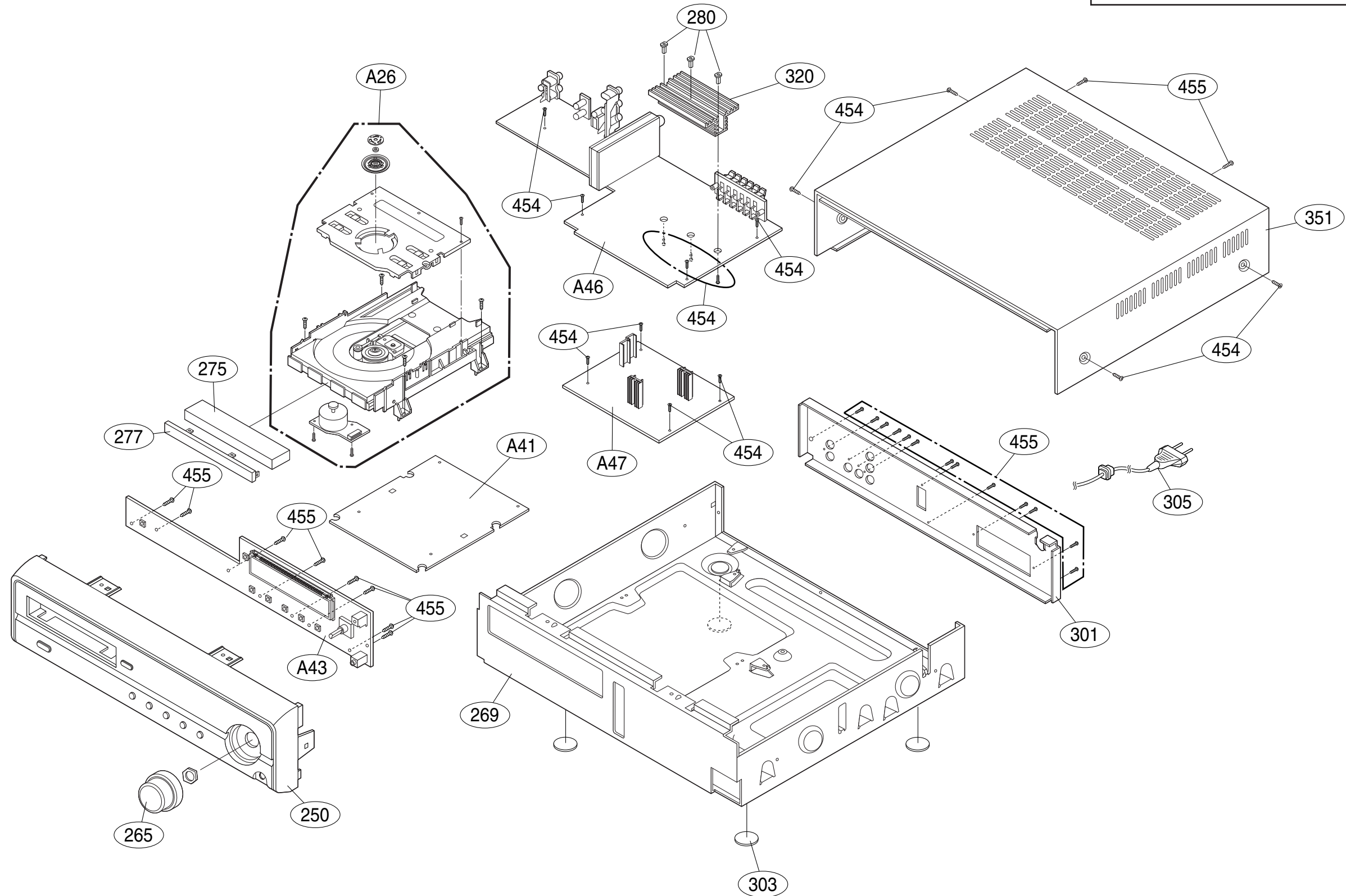

• DECK MECHANISM EXPLODED VIEW

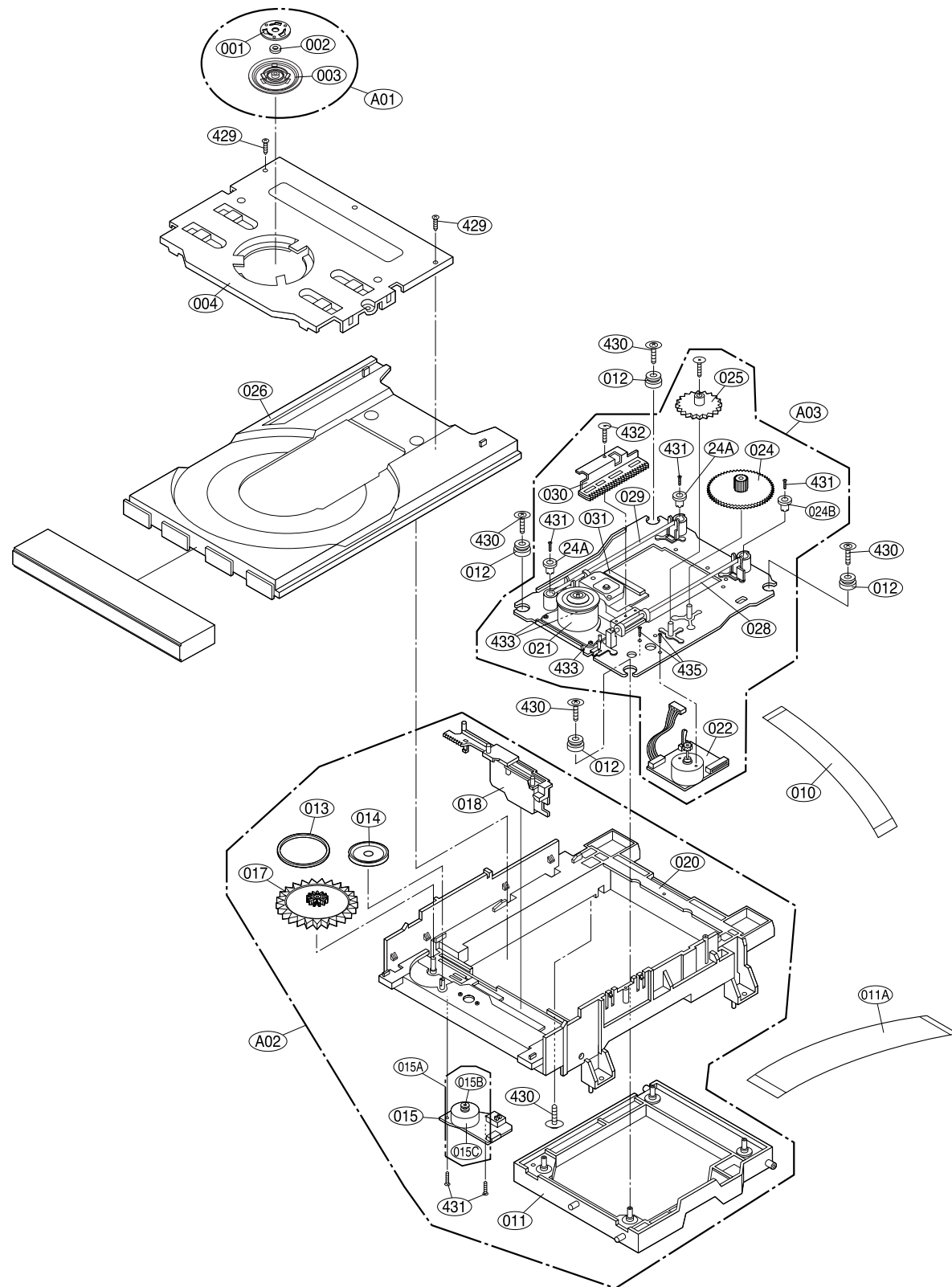

LOCA. NO.	PART NO.	DESCRIPTION	SPECIFICATION
A26	6721RJ0381C	DECK ASSEMBLY,AUDIO	DECK/MECHA DP-7A -HZ-MITSUMI VA9
A01	4861R-0016D	CLAMP ASSEMBLY	DECK/MECHA DISC DP-7C(7A) -HZ
A02	3041R-M018A	BASE ASSEMBLY	MAIN DP-7A-HZ
A03	3041R-M044D	BASE ASSEMBLY	SLED DP-7A-HZ -MITSUMI VA9
001	3300R-0547A	PLATE	CLAMP
002	5016H-1016B	MAGNET	CLAMP(LDM-R608,10*5,1*1.5T)
003	4860R-0021A	CLAMP	UPPER DP7
004	4930R-0402A	HOLDER	CLAMP DP-7A
010	6850R-GK12A	CABLE,FLAT	P=1.0 FFC UL2896(0.05X0.65) 11
011	3210R-M002A	FRAME	UP/DOWN MOLD DP7C
011A	6850R-JW14B	CABLE,FLAT	P=1.0 FFC UL2896(0.035X0.7) 23
012	5040R-0075D	RUBBER	DAMPER DP7 (YAMAUCHI 30)
013	4400R-0006B	BELT	DECK/MECHA DP2-5, DP7C,DP7A OT
014	4470R-0055A	GEAR	PULLEY
015	6871R-J4415A	PWB(PCB) ASSEMBLY,JACK(AUDIO)	PWB(PCB) TOTAL LOADING-HZ
015A	4681R-1023G	MOTOR ASSEMBLY	DECK/MECHA LOADING-HZ
015B	4560R-0008A	PULLEY	MOTOR
015C	4680R-E010A	MOTOR(MECH)	FEEDING BCZ3B51 SANKYO FOR DP7
017	4470R-0056A	GEAR	LOADING
018	4974R-0023A	GUIDE	UP/DOWN
020	3040R-D001A	BASE	MAIN MOLD DP-7AUDIO
021	4680R-C011A	MOTOR(MECH)	SPINDLE JCL9B68 SANKYO FOR COM
022	4681R-0034D	MOTOR ASSEMBLY	DECK/MECHA FEEDING DP-7C(7A) -
024	4470R-0131A	GEAR	PINION DP7C
024A	5006R-0044A	CAP	SKEW-T DP7C
024B	5006R-0043A	CAP	SKEW DP7C
025	4470R-0130A	GEAR	MIDDLE DP7C
026	3390R-0012A	TRAY	DISC(DP-5RM MULTI)
028	4370R-0082B	SHAFT	DECK/MECHA PU R DP-7C OTHER
029	4370R-0082A	SHAFT	PU DP-7C
030	4471R-0013D	GEAR ASSEMBLY	DECK/MECHA RACK DP-7C(7A) -HZ
031	6716DPH005B	PICK UP,DVD	PVR-502W R52 0219 MITSUMI PLAY
429	1SZZR-0012A	SCREW,DRAWING	B-TITE
430	1SZZH-1003A	SCREW,DRAWING	+ D2.0 6MM SWRCH16A/NIY 4.5MM
431	1SZZH-1007B	SCREW,DRAWING	+ D2.0 6MM SWRCH16A/ZNBK 4MM 1
432	1SZZR-0023B	SCREW,DRAWING	+ 1 D1.7 L6.0 SWRCH16A/FZY RAC
433	1SZZR-0050A	SCREW,DRAWING	+ 1 D2.0 L4.5 SWRCH16A/ZNY S-T
435	1SZZR-0011A	SCREW,DRAWING	MACHINE

MEMO

MEMO

SECTION 5. SPEAKER SECTION

□ MODEL : LHS-D6245W

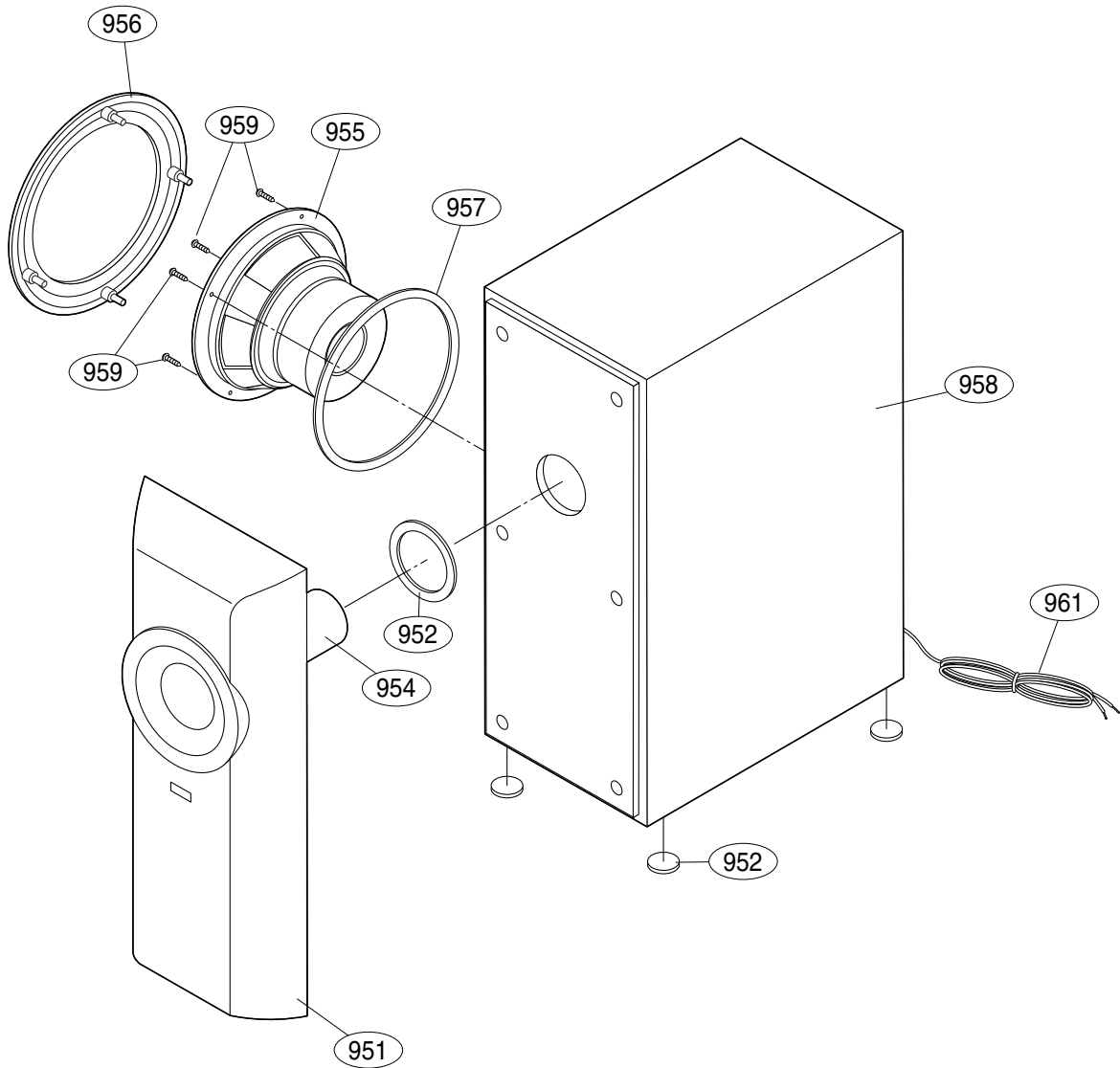

□ MODEL : LHS-D6245T

