



SERVICE MANUAL

MODELS : LH-T360SE/LH-T3602SE/LH-T3600SE/LH-T361SE/LH-T3630X



DVD/CD RECEIVER

SERVICE MANUAL

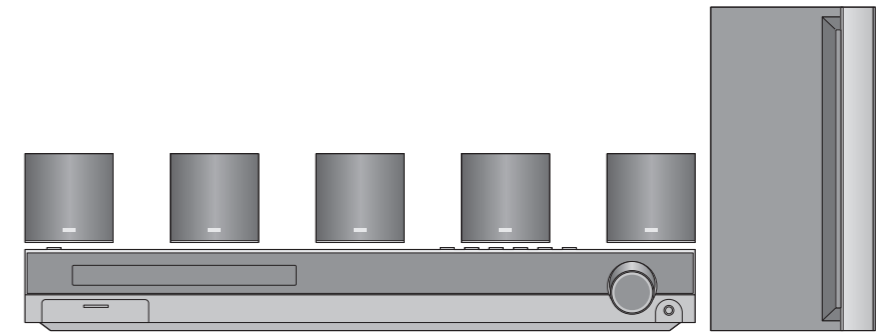

**MODELS : LH-T360SE/LH-T3602SE/LH-T3600SE/
LH-T361SE/LH-T3630X**

LG Electronics Inc.

[CONTENTS]

SECTION 1. GENERAL

- SERVICING PRECAUTIONS 1-2
- ESD PRECAUTIONS 1-4
- SERVICE INFORMATION FOR EEPROM 1-5
- SPECIFICATIONS 1-6

SECTION 2. AUDIO PART

- AUDIO TROUBLESHOOTING GUIDE 2-1
- WIRING DIAGRAM 2-4
- BLOCK DIAGRAM 2-6
- CIRCUIT DIAGRAMS 2-8
- PRINTED CIRCUIT DIAGRAMS 2-32

SECTION 3. DVD & AMP PART

- ELECTRICAL TROUBLESHOOTING GUIDE 3-1
- DVD & AMP CIRCUIT DIAGRAMS 3-22
- PRINTED CIRCUIT DIAGRAMS 3-30

SECTION 4. EXPLODED VIEWS 4-1

SECTION 5. SPEAKER PART 5-1

SECTION 6. REPLACEMENT PARTS LIST 6-1

SECTION 1. GENERAL

SERVICING PRECAUTIONS

NOTES REGARDING HANDLING OF THE PICK-UP

1. Notes for transport and storage

- 1) The pick-up should always be left in its conductive bag until immediately prior to use.
- 2) The pick-up should never be subjected to external pressure or impact.

Storage in conductive bag

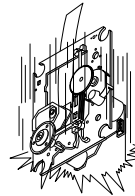
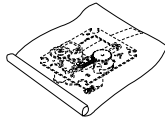

Drop impact

2. Repair notes

- 1) The pick-up incorporates a strong magnet, and so should never be brought close to magnetic materials.
- 2) The pick-up should always be handled correctly and carefully, taking care to avoid external pressure and impact. If it is subjected to strong pressure or impact, the result may be an operational malfunction and/or damage to the printed-circuit board.
- 3) Each and every pick-up is already individually adjusted to a high degree of precision, and for that reason the adjustment point and installation screws should absolutely never be touched.
- 4) Laser beams may damage the eyes!
Absolutely never permit laser beams to enter the eyes!
Also NEVER switch ON the power to the laser output part (lens, etc.) of the pick-up if it is damaged.

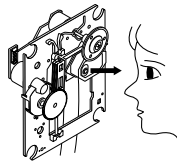

NEVER look directly at the laser beam, and don't let contact fingers or other exposed skin.

5) Cleaning the lens surface

If there is dust on the lens surface, the dust should be cleaned away by using an air bush (such as used for camera lens). The lens is held by a delicate spring. When cleaning the lens surface, therefore, a cotton swab should be used, taking care not to distort this.

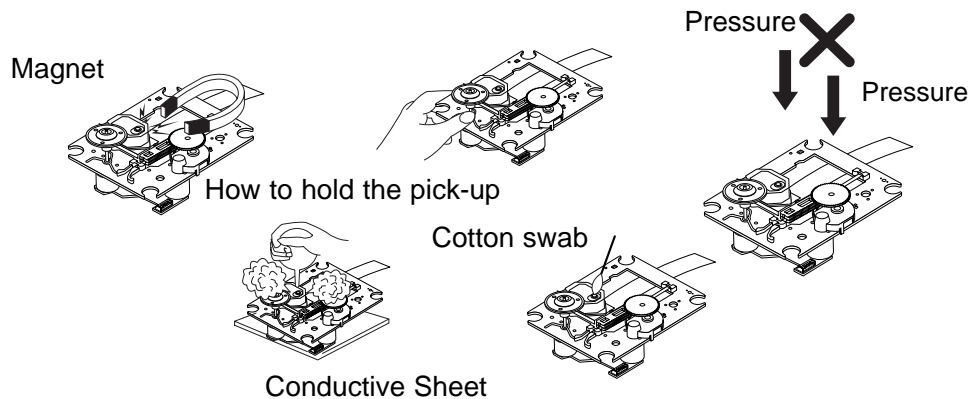

6) Never attempt to disassemble the pick-up.

Spring by excess pressure. If the lens is extremely dirty, apply isopropyl alcohol to the cotton swab. (Do not use any other liquid cleaners, because they will damage the lens.) Take care not to use too much of this alcohol on the swab, and do not allow the alcohol to get inside the pick-up.

NOTES REGARDING COMPACT DISC PLAYER REPAIRS

1. Preparations

- 1) Compact disc players incorporate a great many ICs as well as the pick-up (laser diode). These components are sensitive to, and easily affected by, static electricity. If such static electricity is high voltage, components can be damaged, and for that reason components should be handled with care.
- 2) The pick-up is composed of many optical components and other high-precision components. Care must be taken, therefore, to avoid repair or storage where the temperature or humidity is high, where strong magnetism is present, or where there is excessive dust.

2. Notes for repair

- 1) Before replacing a component part, first disconnect the power supply lead wire from the unit
- 2) All equipment, measuring instruments and tools must be grounded.
- 3) The workbench should be covered with a conductive sheet and grounded.
When removing the laser pick-up from its conductive bag, do not place the pick-up on the bag. (This is because there is the possibility of damage by static electricity.)
- 4) To prevent AC leakage, the metal part of the soldering iron should be grounded.
- 5) Workers should be grounded by an armband (1M Ω)
- 6) Care should be taken not to permit the laser pick-up to come in contact with clothing, in order to prevent static electricity changes in the clothing to escape from the armband.
- 7) The laser beam from the pick-up should NEVER be directly facing the eyes or bare skin.

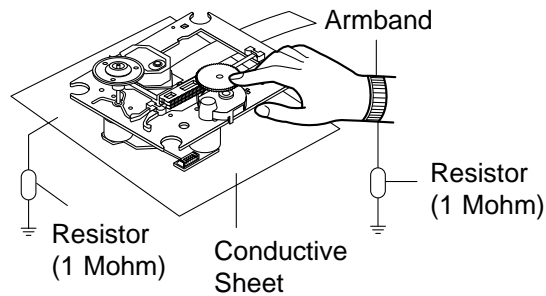

ESD PRECAUTIONS

Electrostatically Sensitive Devices (ESD)



Some semiconductor (solid state) devices can be damaged easily by static electricity. Such components commonly are called Electrostatically Sensitive Devices (ESD). Examples of typical ESD devices are integrated circuits and some field-effect transistors and semiconductor chip components. The following techniques should be used to help reduce the incidence of component damage caused by static electricity.

1. Immediately before handling any semiconductor component or semiconductor-equipped assembly, drain off any electrostatic charge on your body by touching a known earth ground. Alternatively, obtain and wear a commercially available discharging wrist strap device, which should be removed for potential shock reasons prior to applying power to the unit under test.
2. After removing an electrical assembly equipped with ESD devices, place the assembly on a conductive surface such as aluminum foil, to prevent electrostatic charge buildup or exposure of the assembly.
3. Use only a grounded-tip soldering iron to solder or unsolder ESD devices.
4. Use only an anti-static solder removal device. Some solder removal devices not classified as "anti-static" can generate electrical charges sufficient to damage ESD devices.
5. Do not use freon-propelled chemicals. These can generate electrical charges sufficient to damage ESD devices.
6. Do not remove a replacement ESD device from its protective package until immediately before you are ready to install it. (Most replacement ESD devices are packaged with leads electrically shorted together by conductive foam, aluminum foil or comparable conductive materials).
7. Immediately before removing the protective material from the leads of a replacement ESD device, touch the protective material to the chassis or circuit assembly into which the device will be installed.

CAUTION : BE SURE NO POWER IS APPLIED TO THE CHASSIS OR CIRCUIT, AND OBSERVE ALL OTHER SAFETY PRECAUTIONS.

8. Minimize bodily motions when handling unpackaged replacement ESD devices. (Otherwise harmless motion such as the brushing together of your clothes fabric or the lifting of your foot from a carpeted floor can generate static electricity sufficient to damage an ESD device).

CAUTION. GRAPHIC SYMBOLS

	THE LIGHTNING FLASH WITH APROWHEAD SYMBOL. WITHIN AN EQUILATERAL TRIANGLE, IS INTENDED TO ALERT THE SERVICE PERSONNEL TO THE PRESENCE OF UNINSULATED "DANGEROUS VOLTAGE" THAT MAY BE OF SUFFICIENT MAGNITUDE TO CONSTITUTE A RISK OF ELECTRIC SHOCK.
	THE EXCLAMATION POINT WITHIN AN EQUILATERAL TRIANGLE IS INTENDED TO ALERT THE SERVICE PERSONNEL TO THE PRESENCE OF IMPORTANT SAFETY INFORMATION IN SERVICE LITERATURE.

SERVICE INFORMATION FOR EEPROM

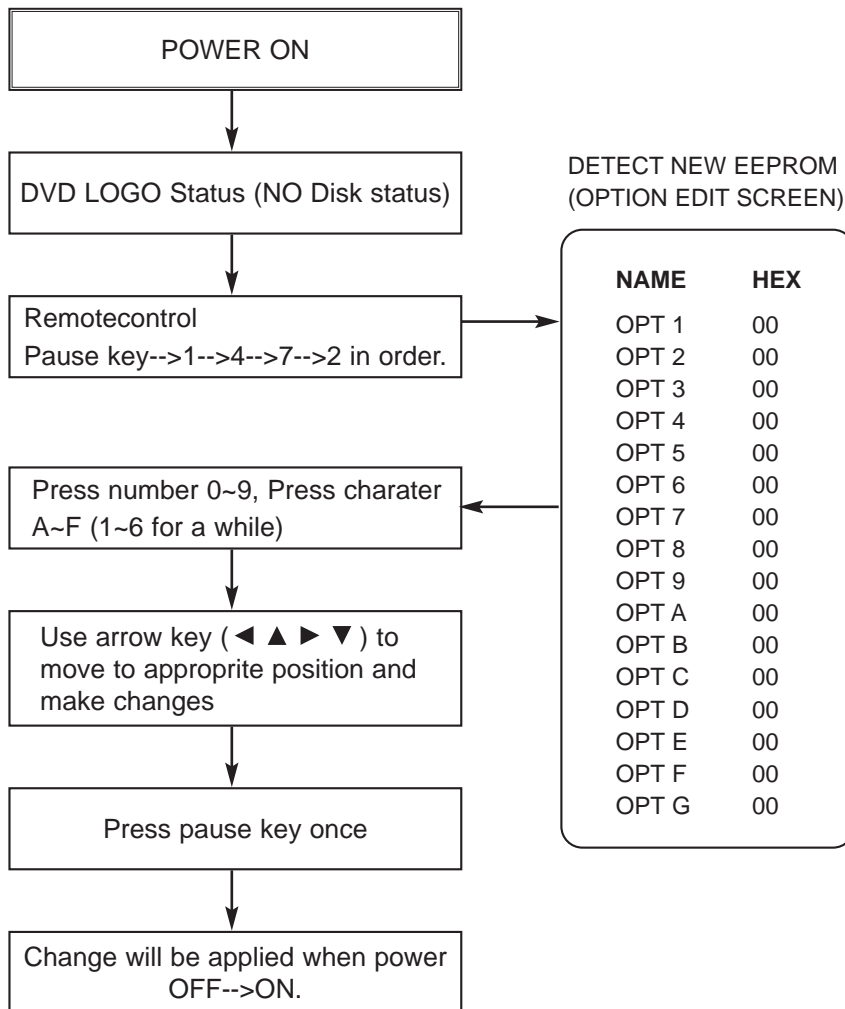

* OPTION

- NTSC model doesn't have VCR option and use DVD option B~F as VCR option. (only DVD exist)
- PAL model has another separate VCR option. (Both VCR and DVD exist)

SPECIFICATIONS

GENERAL

Power supply	Refer to main label
Power consumption	Refer to main label
Net Weight	3.9 kg
External dimensions (W x H x D)	430 x 57 x 295 mm
Operating conditions	Temperature: 5°C to 35°C, Operation status: Horizontal
Operating humidity	5% to 85%

CD/DVD

Laser	Semiconductor laser, wavelength 650 nm
Signal system	PAL 625/50, NTSC 525/60
Frequency response (audio)	150 Hz to 18 kHz
Signal-to-noise ratio (audio)	More than 75 dB (1 kHz, NOP -6 dB, 20 kHz LPF/A-Filter)
Dynamic range (audio)	More than 70 dB
Harmonic distortion (audio)	0.5 % (1 kHz, at 1W position) (20 kHz LPF)

VIDEO

Video output	1.0 V (p-p), 75 Ω, negative sync., SCART (TO TV)
--------------	--

TUNER

FM

Tuning Range	87.5 - 108.0 MHz or 65.0 - 74.0 MHz, 87.5 - 108.0 MHz
Intermediate Frequency	10.7 MHz
Signal-to Noise Ratio	60 dB (Mono)
Frequency Response	140 - 8,000 Hz

AM [MW]

Tuning Range	522 - 1,620 kHz or 520 - 1,720 kHz
Intermediate Frequency	450 kHz

AMPLIFIER(LH-T36's)

Stereo mode	45W + 45W (Rated Output Power 30W, 4Ω at 1 kHz, THD 10 %)
Surround mode	Front: 45W + 45W (Rated Output Power 30W, THD 10 %)
(* Depending on the sound mode settings and the source, there may be no sound output.)	Center*: 45W
	Surround*: 45W + 45W(Rated Output Power 30W, 4Ω at 1 kHz, THD 10 %)
	Subwoofer*: 75W (Rated Output Power 60W, 8Ω at 30 Hz, THD 10 %)
Input	AUX IN
Outputs	MONITOR, PHONES: (32 Ω, 1.0 V)

SPEAKERS(LHS-36SE)

	Front/Rear/Center Speaker (LHS-36SES)	Passive Subwoofer (LHS-36SEW)
Type	1 Way 1 Speaker	1 Way 1 Speaker
Impedance	4 Ω	8 Ω
Frequency Response	150 - 20,000 Hz	65 - 1,500 Hz
Sound Pressure Level	85 dB/W (1m)	87 dB/W (1m)
Rated Input Power	45 W	75 W
Max. Input Power	90 W	150 W
Net Dimensions (W x H x D)	105 x 99 x 83 mm	175 x 351 x 270 mm
Net Weight	0.45kg	3.4kg

SECTION 2. AUDIO PART

AUDIO TROUBLESHOOTING GUIDE

1. POWER SUPPLY CIRCUIT

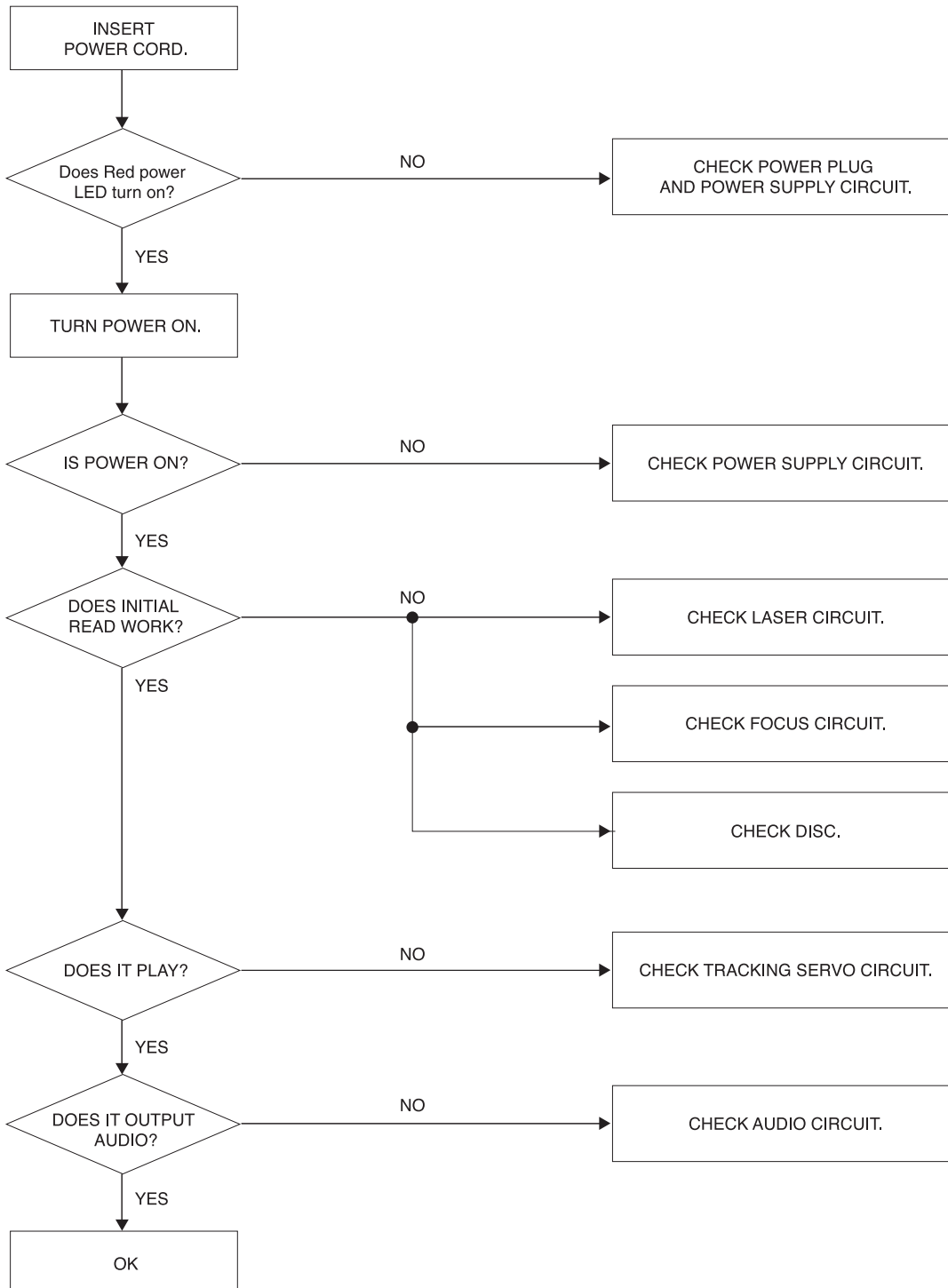

2. FRONT CIRCUIT (1/2)

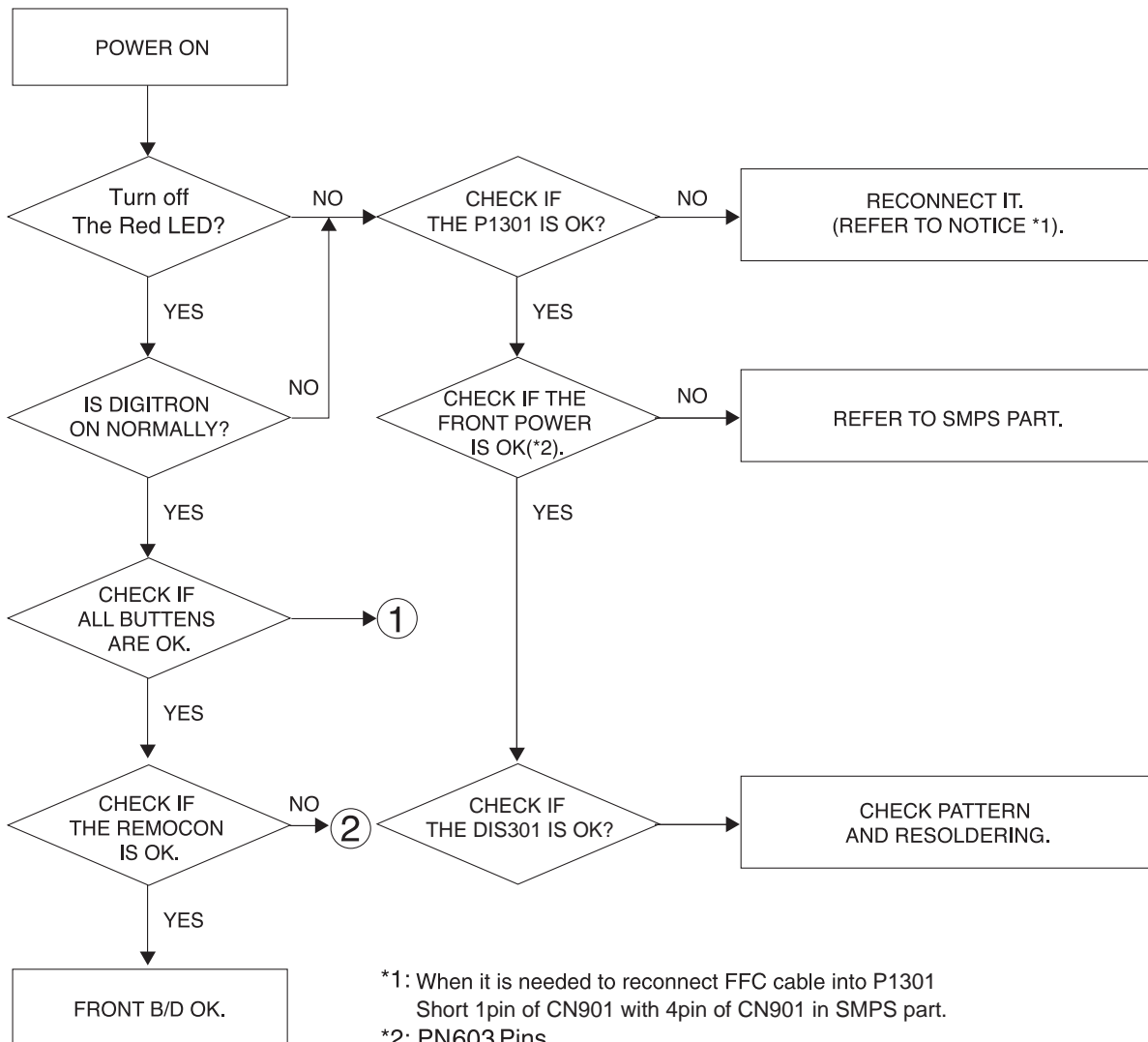

3. FRONT CIRCUIT (2/2)

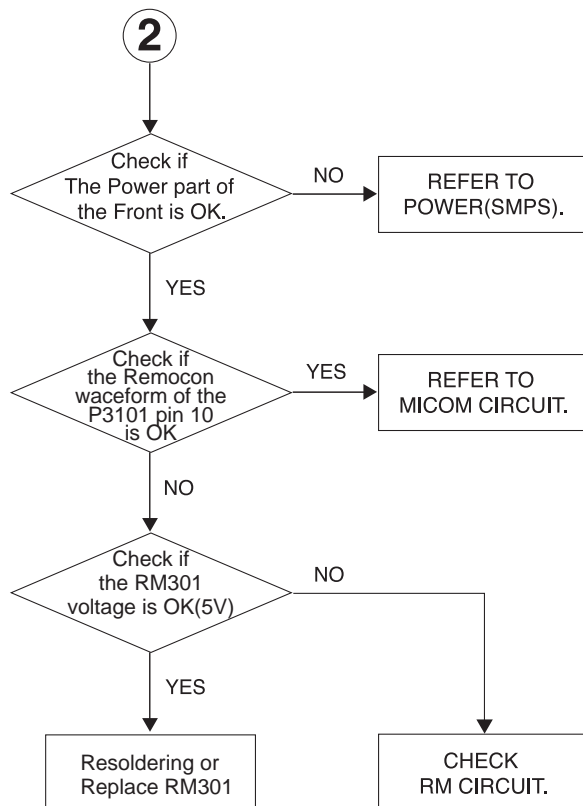
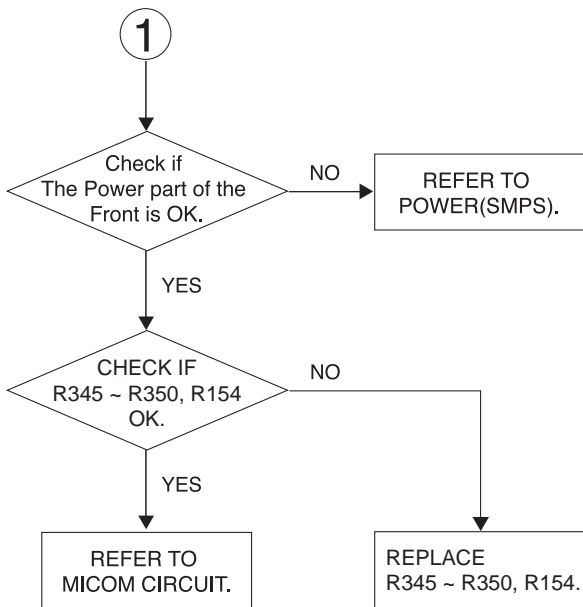

MEMO

A series of horizontal dotted lines for writing.

WIRING DIAGRAM

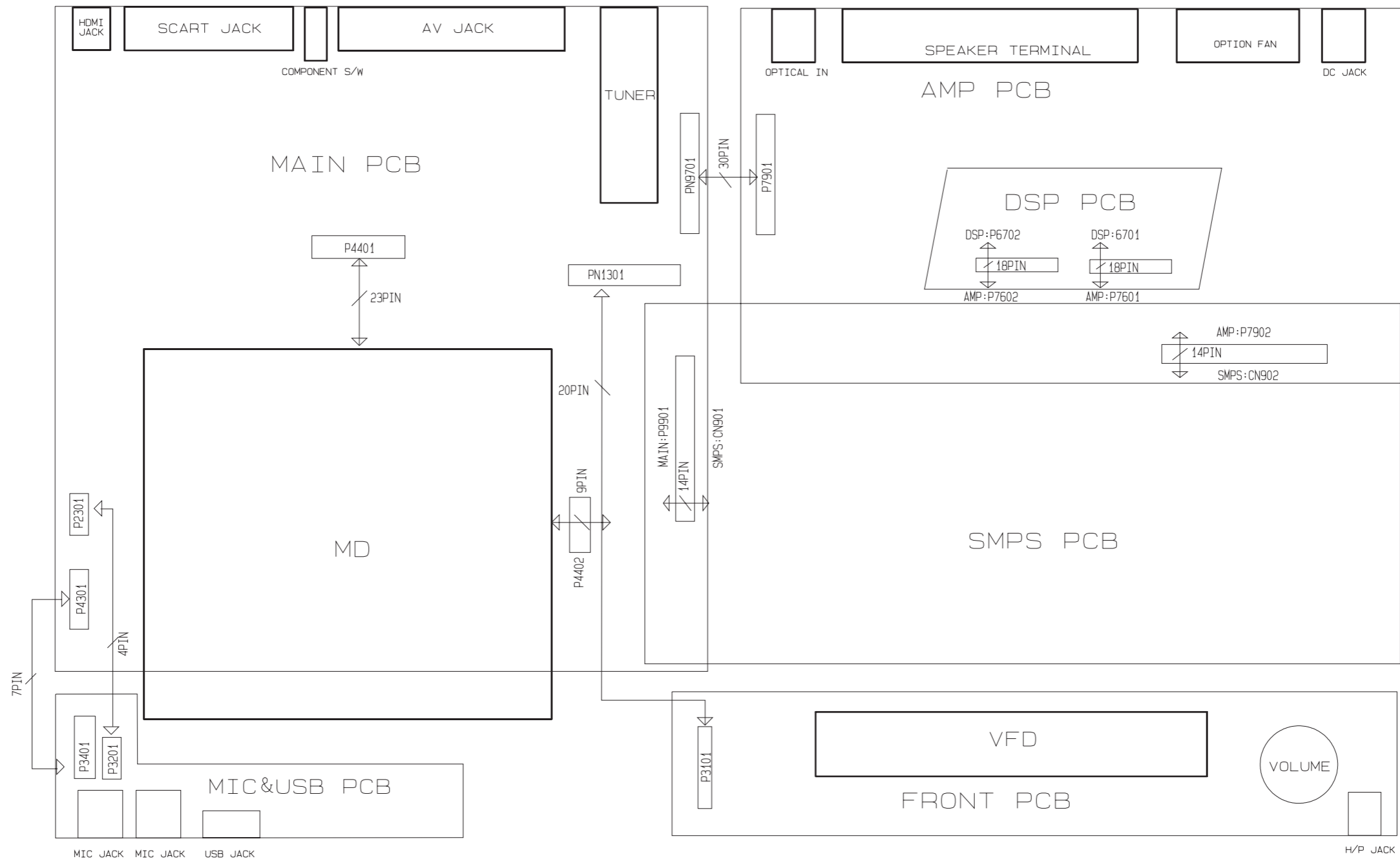

EMATIC DIAGRAM (WIRING DIAGRAM)

LH-T9655

BLOCK DIAGRAM

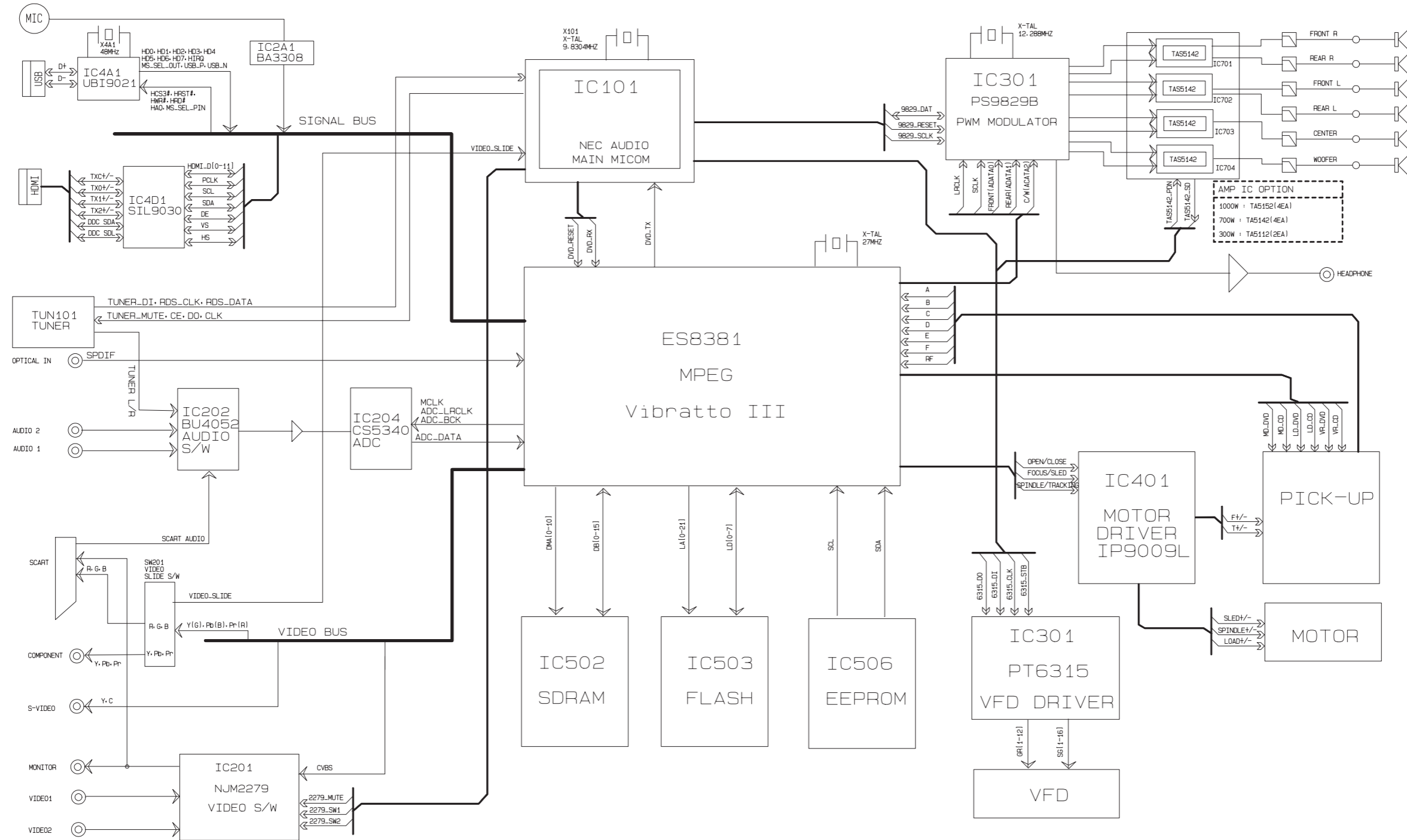

CIRCUIT DIAGRAMS

1. SMPS(POWER) CIRCUIT DIAGRAM (1000W, LH-T96's)

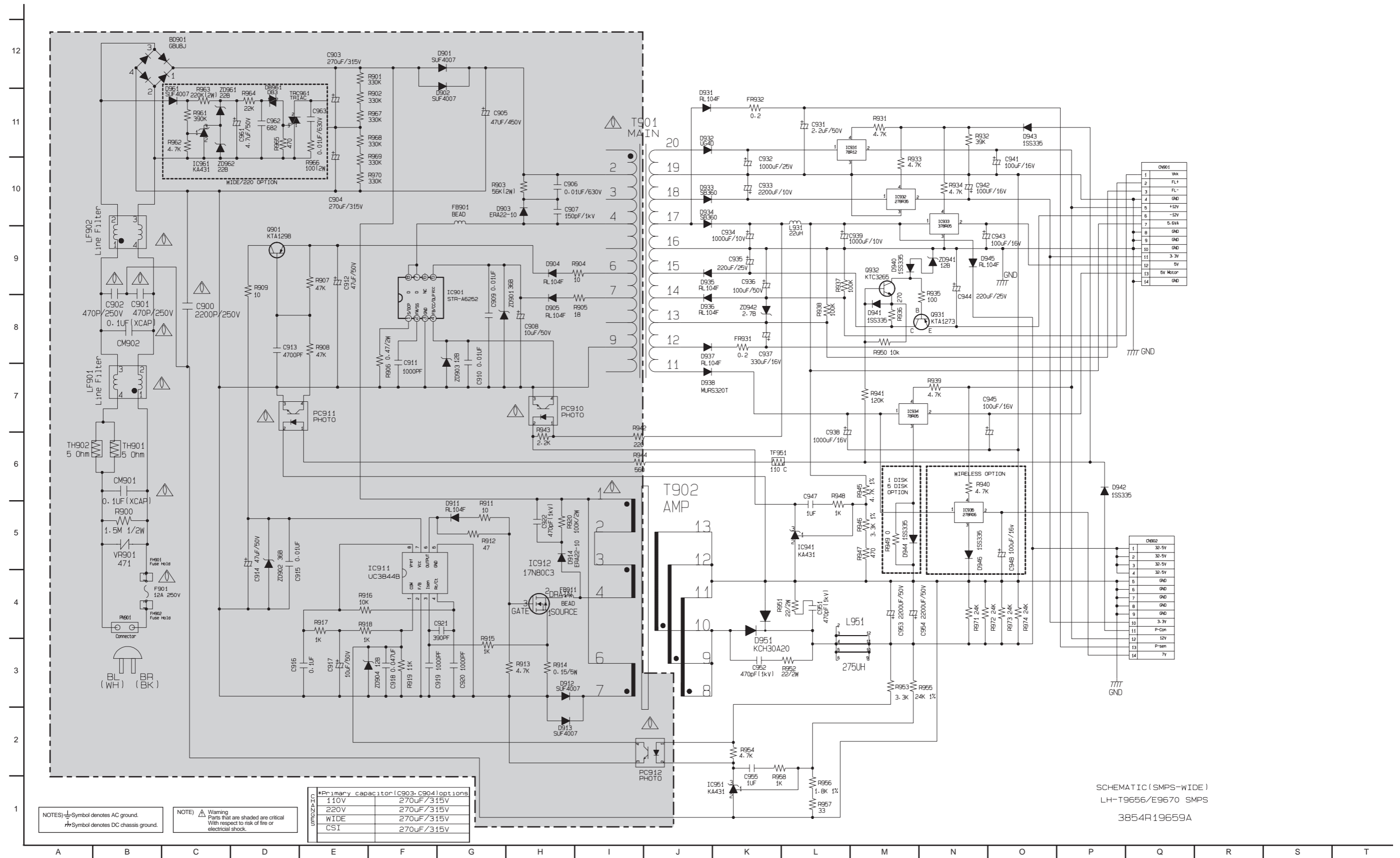

2. SMPS(POWER) CIRCUIT DIAGRAM (700W, LH-T76's)

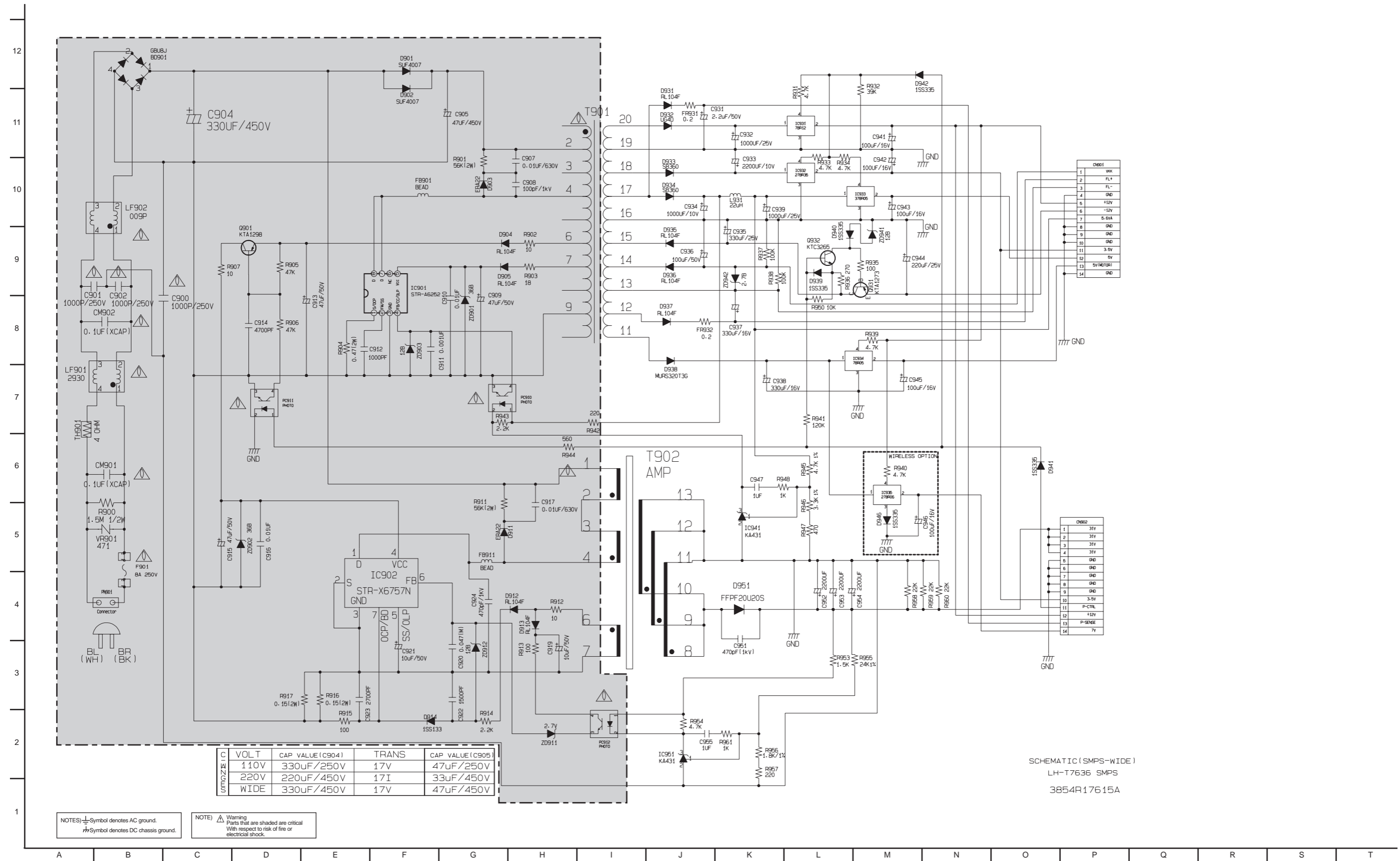

3. SMPS(POWER) CIRCUIT DIAGRAM (300W, LH-T36's)

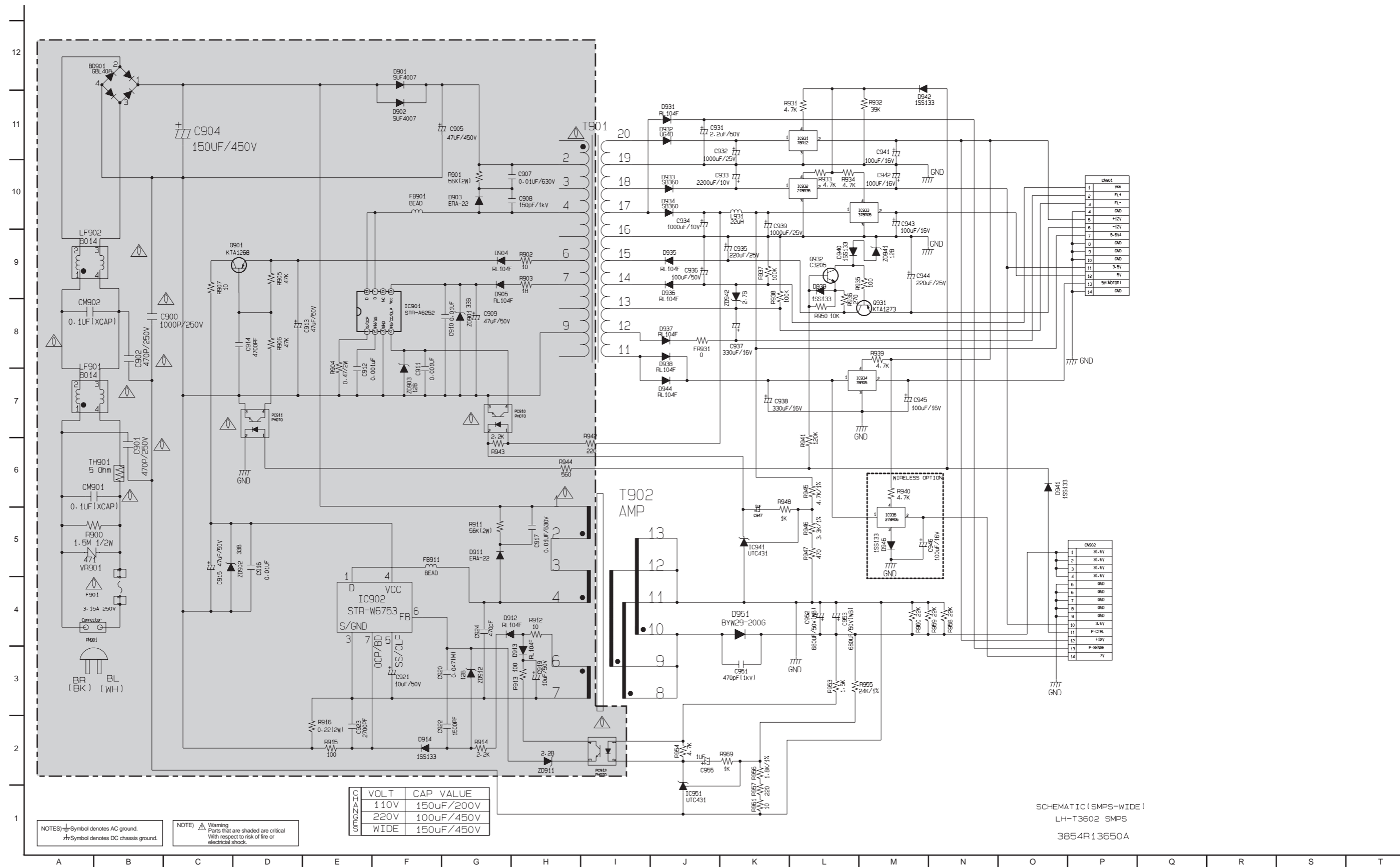

NOTES) Symbol denotes AC ground.
 Symbol denotes DC chassis ground.
 NOTE) Warning Parts that are shaded are critical With respect to risk of fire or electrical shock.

WIRE COLOR	VOLT	CAP VALUE
BROWN	110V	150uF/200V
RED	220V	100uF/450V
WIDE	WIDE	150uF/450V

SCHEMATIC (SMPS-WIDE)
 LH-T3602 SMPS
 3854R13650A

4. POWER INTERFACE CIRCUIT DIAGRAM

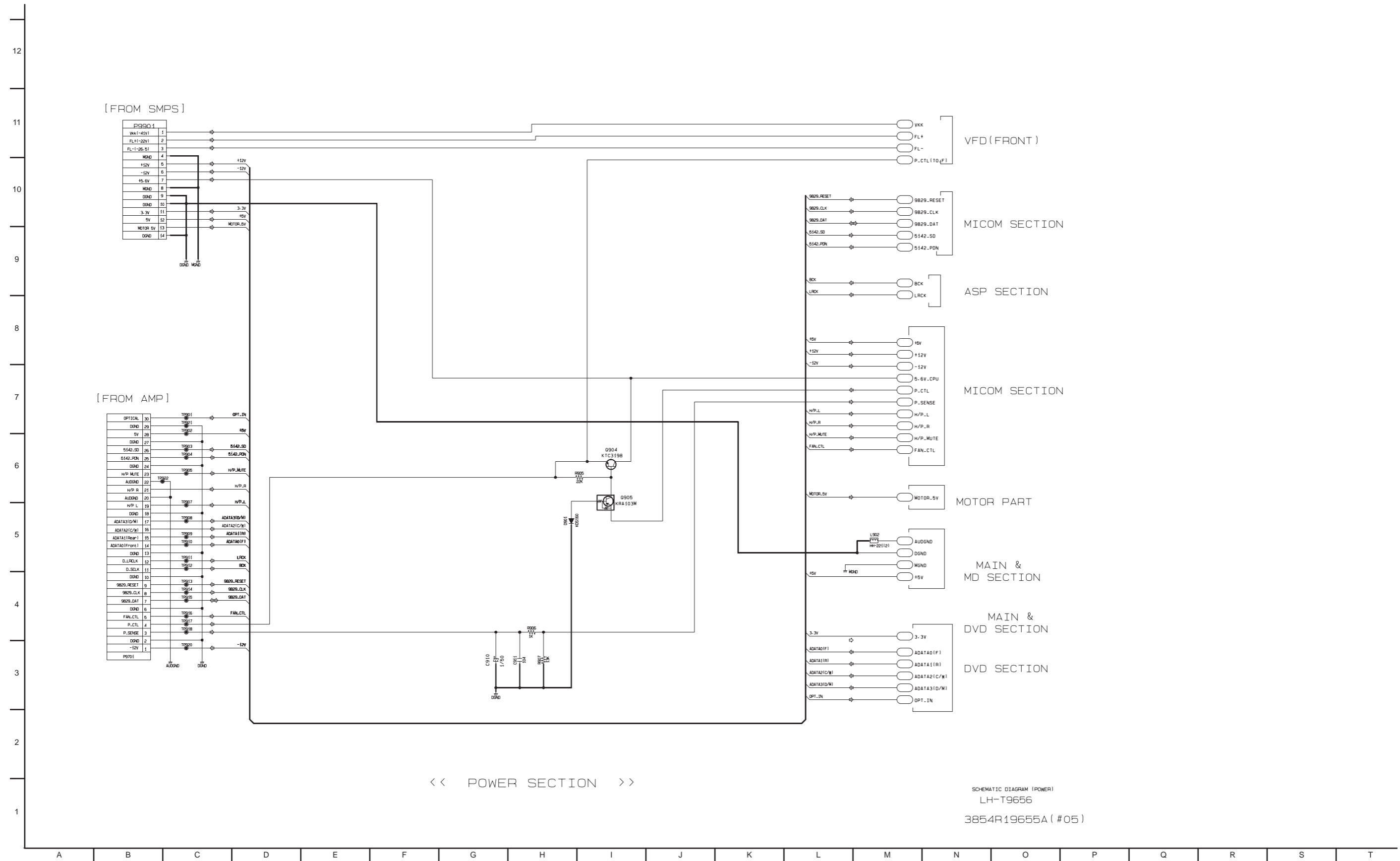

<< POWER SECTION >>

SCHEMATIC DIAGRAM (POWER)
LH-T9656
3854R19655A (#05)

5. μ-COM(MAIN) CIRCUIT DIAGRAM

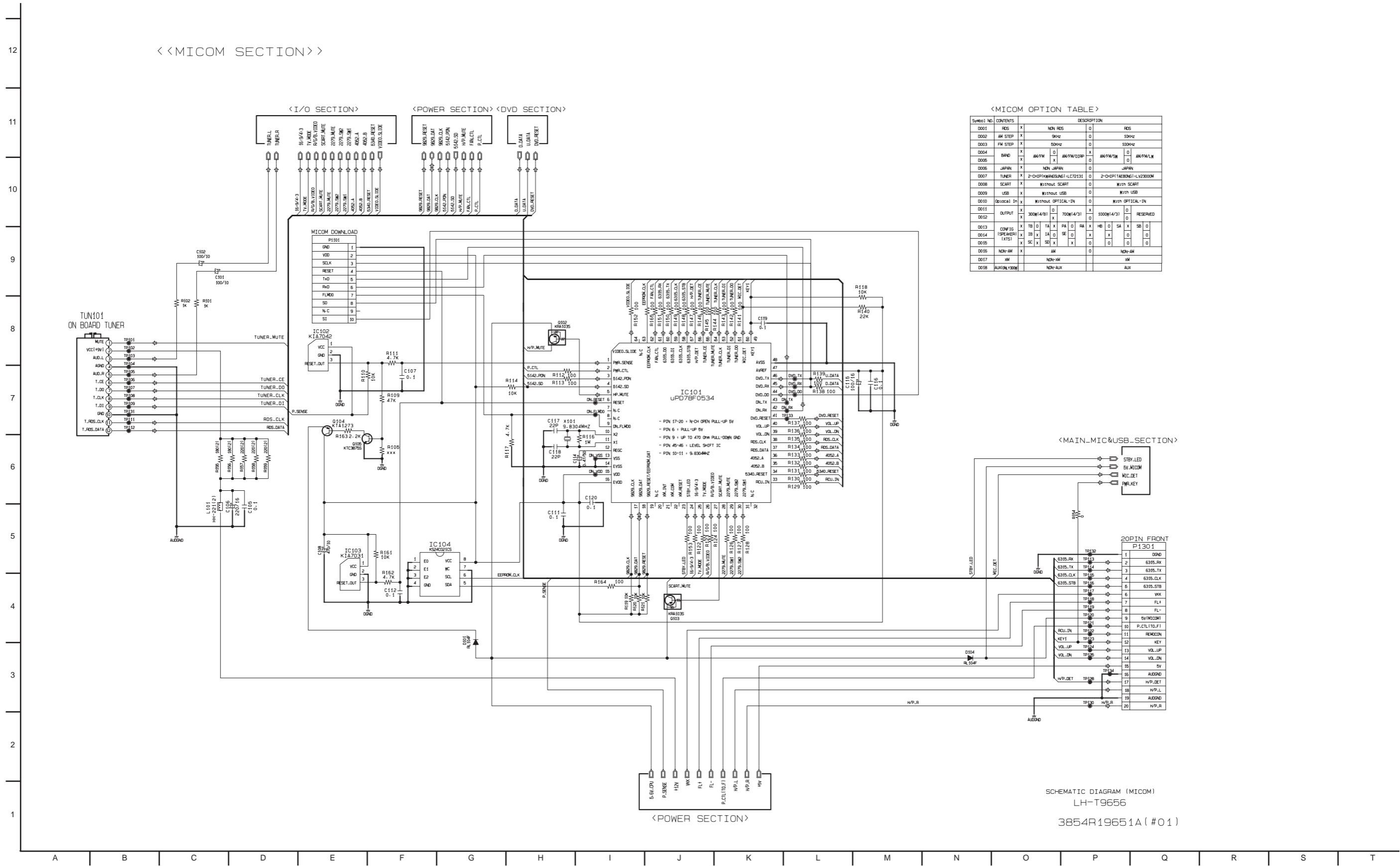

<MICOM OPTION TABLE>

SymNo1 No.	CONTENTS	DESCRIPTION
0001	RES	NON-RES
0002	AM STEP	50kHz
0003	FM STEP	50kHz
0004	BAND	AM/FM
0005	JAPAN	NON-JAPAN
0006	TUNER	2-CHIP(TAKEMING) / LC72131
0007	SCART	Without SCART
0008	USB	Without USB
0009	Optical In	Without OPTICAL-IN
0010	OUTPUT	300W(4/3)
0011	CONFID	TA X PA X RA X HB X SA X SB X
0012	CONFID	TA X PA X RA X HB X SA X SB X
0013	CONFID	TA X PA X RA X HB X SA X SB X
0014	CONFID	TA X PA X RA X HB X SA X SB X
0015	CONFID	TA X PA X RA X HB X SA X SB X
0016	NON-AM	AM
0017	AM	NON-AM
0018	AUX1/100M	NON-AUX

SCHEMATIC DIAGRAM (MICOM)
LH-T9656
3854R19651A (#01)

6. SERVO CIRCUIT DIAGRAM

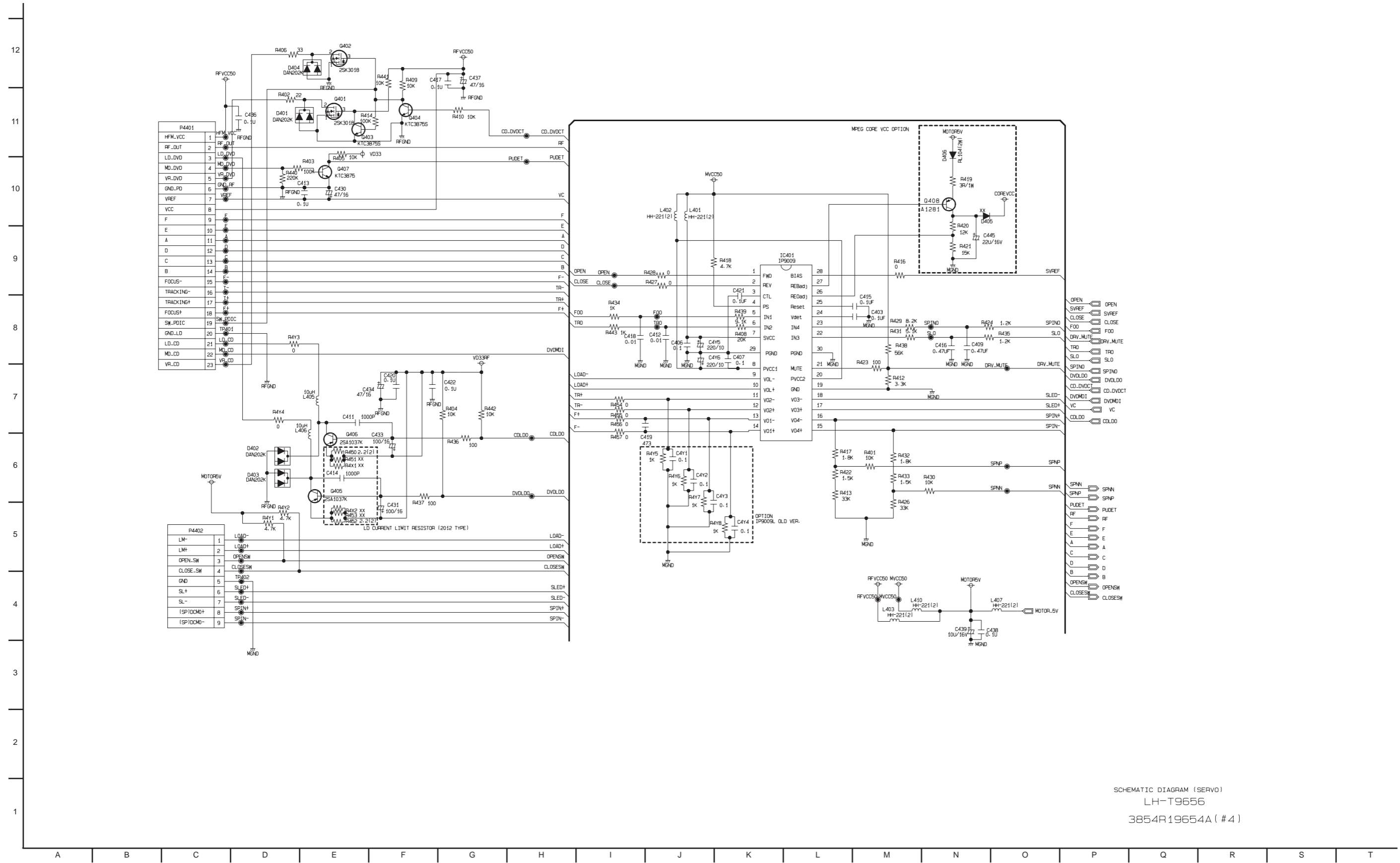

SCHEMATIC DIAGRAM (SERVO)
LH-T9656
3854R19654A (#4)

7. I/O CIRCUIT DIAGRAM

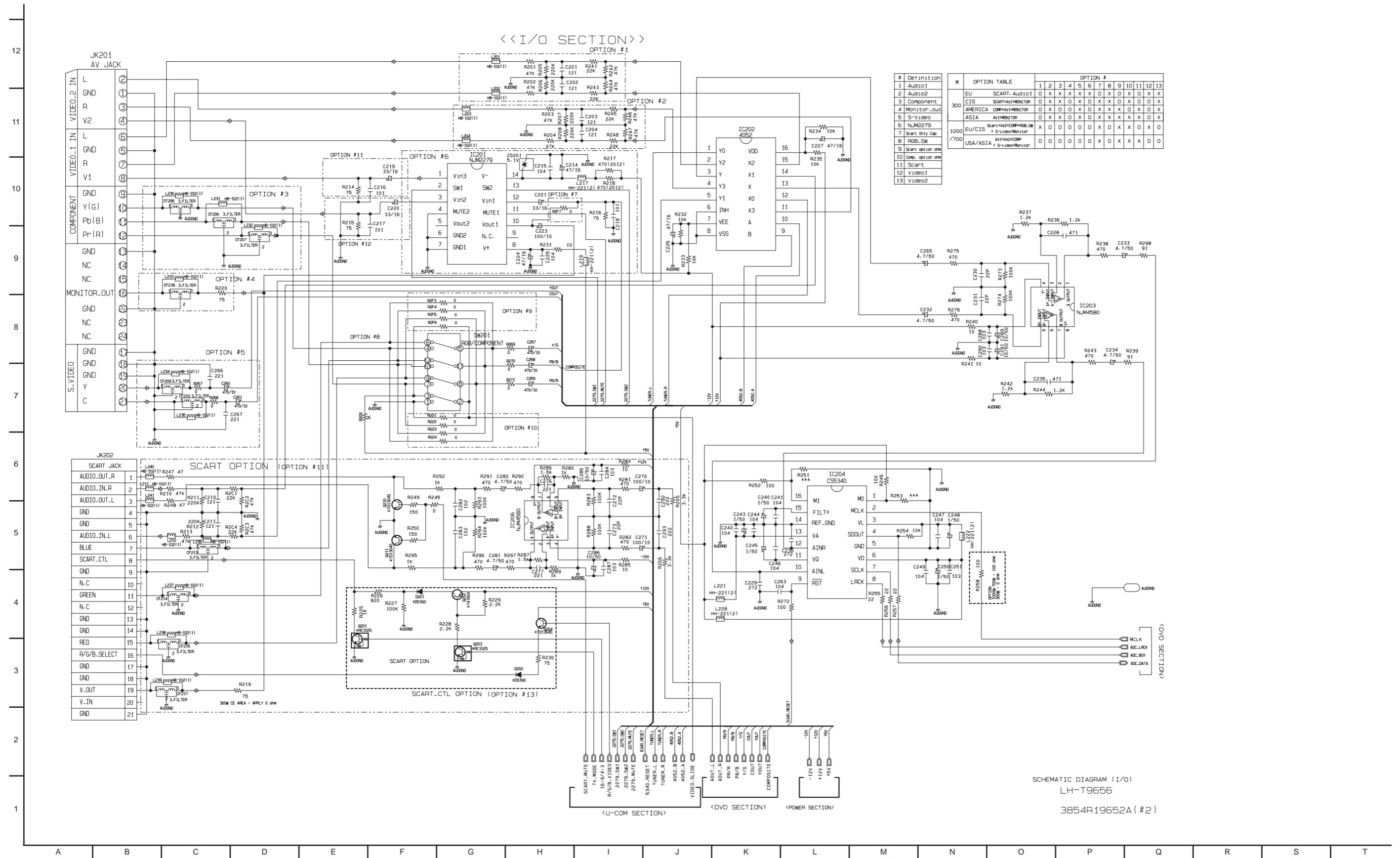

8. MIC CIRCUIT DIAGRAM

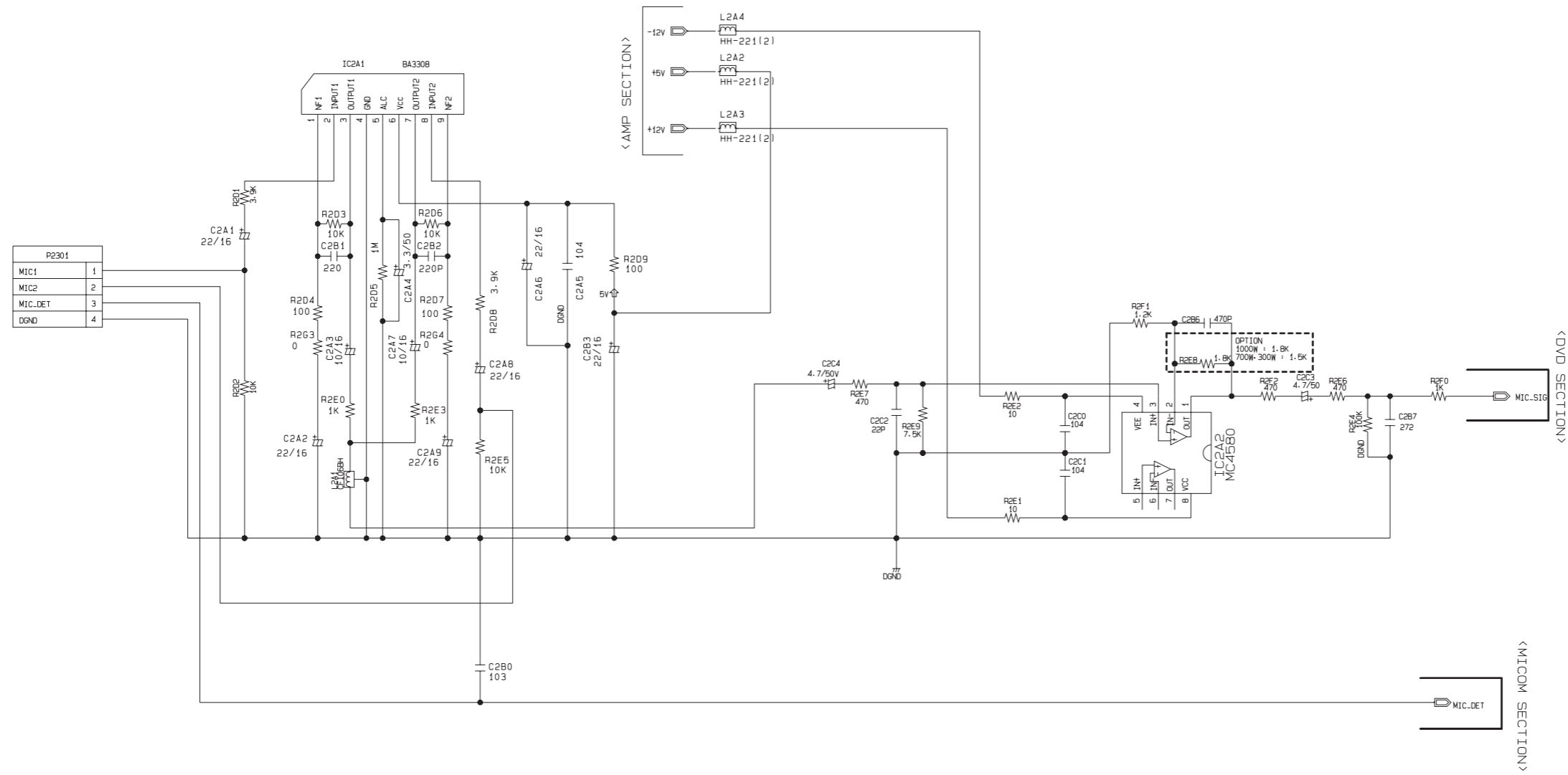

SCHEMATIC DIAGRAM (MIC)

LH-T9656

3854R19660A (#6)

9. USB CIRCUIT DIAGRAM

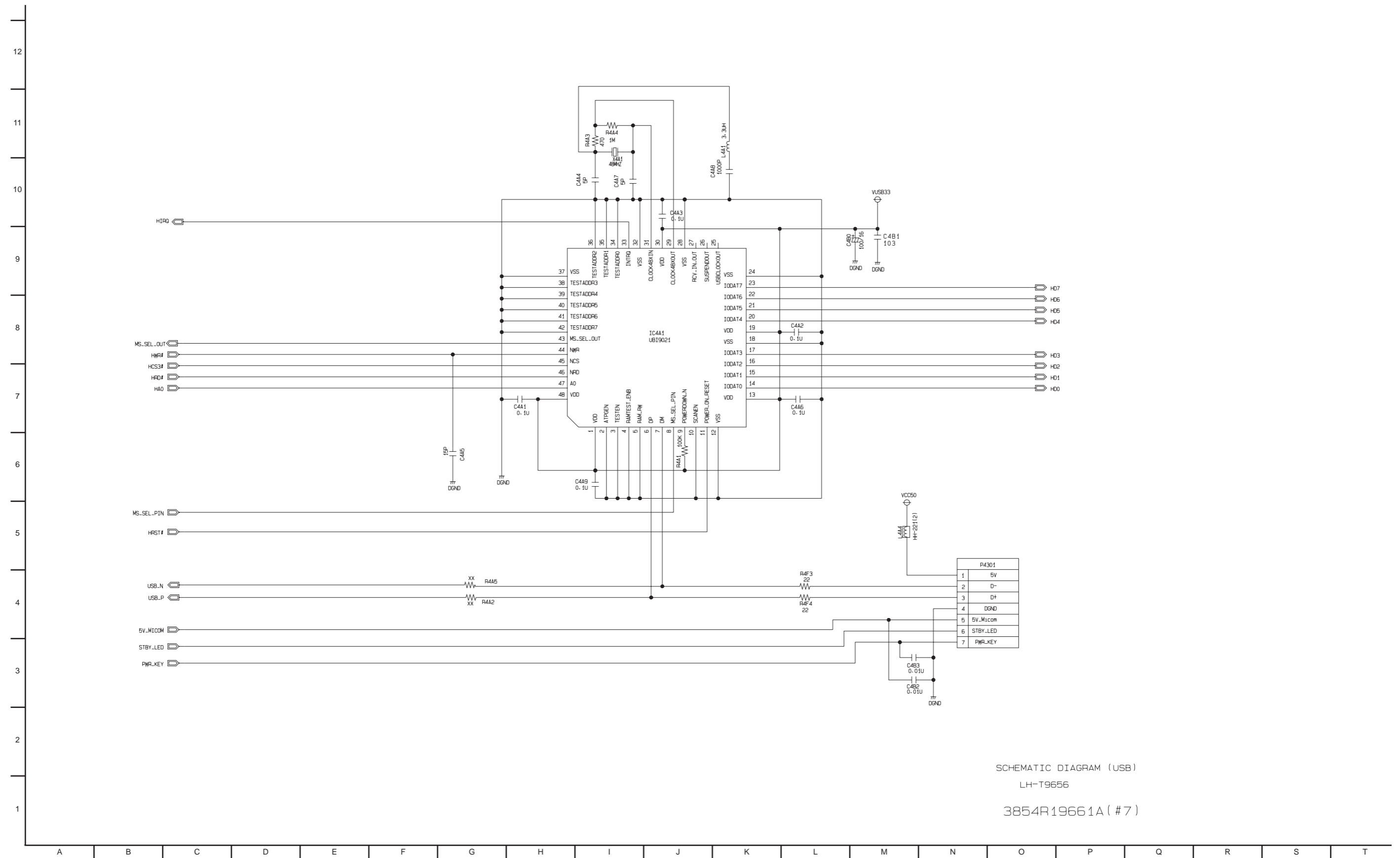

SCHEMATIC DIAGRAM (USB)
LH-T9656
3854R19661A (#7)

10. MIC & USB CIRCUIT DIAGRAM

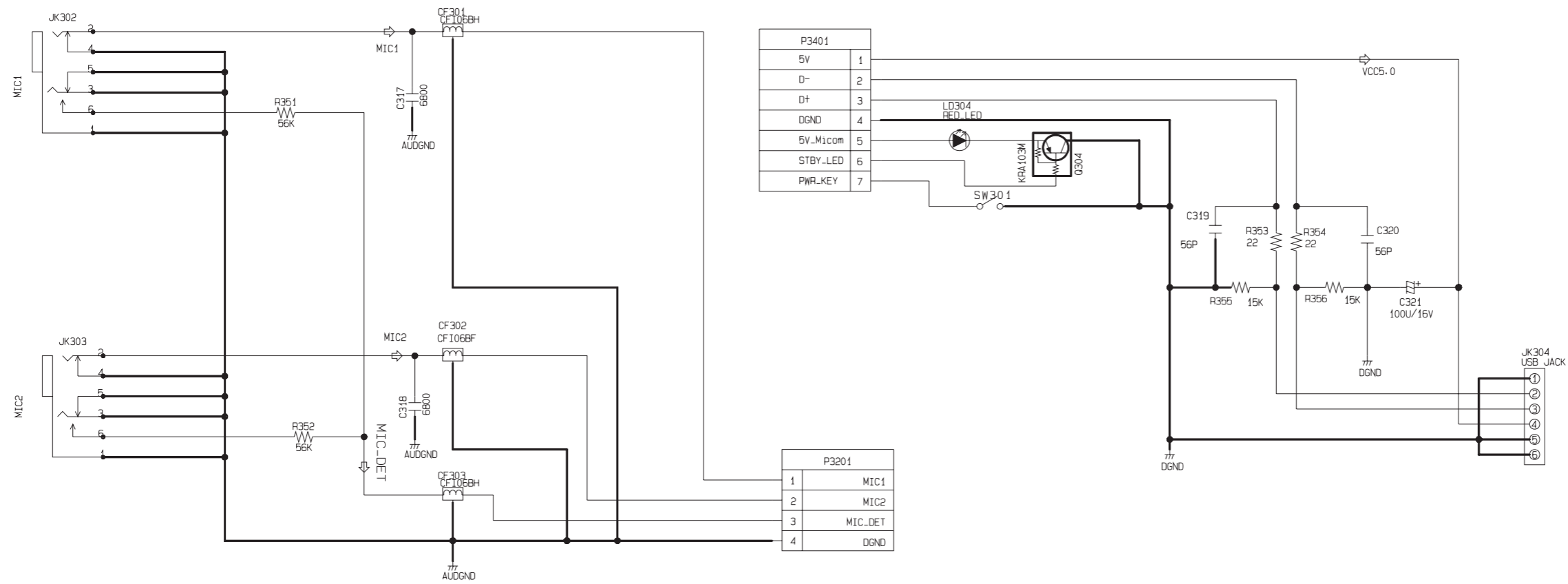

SCHMATIC DIAGRAM (MIC&USB)
LH-T9656

3854R19658A (#02)

12. FRONT CIRCUIT DIAGRAM

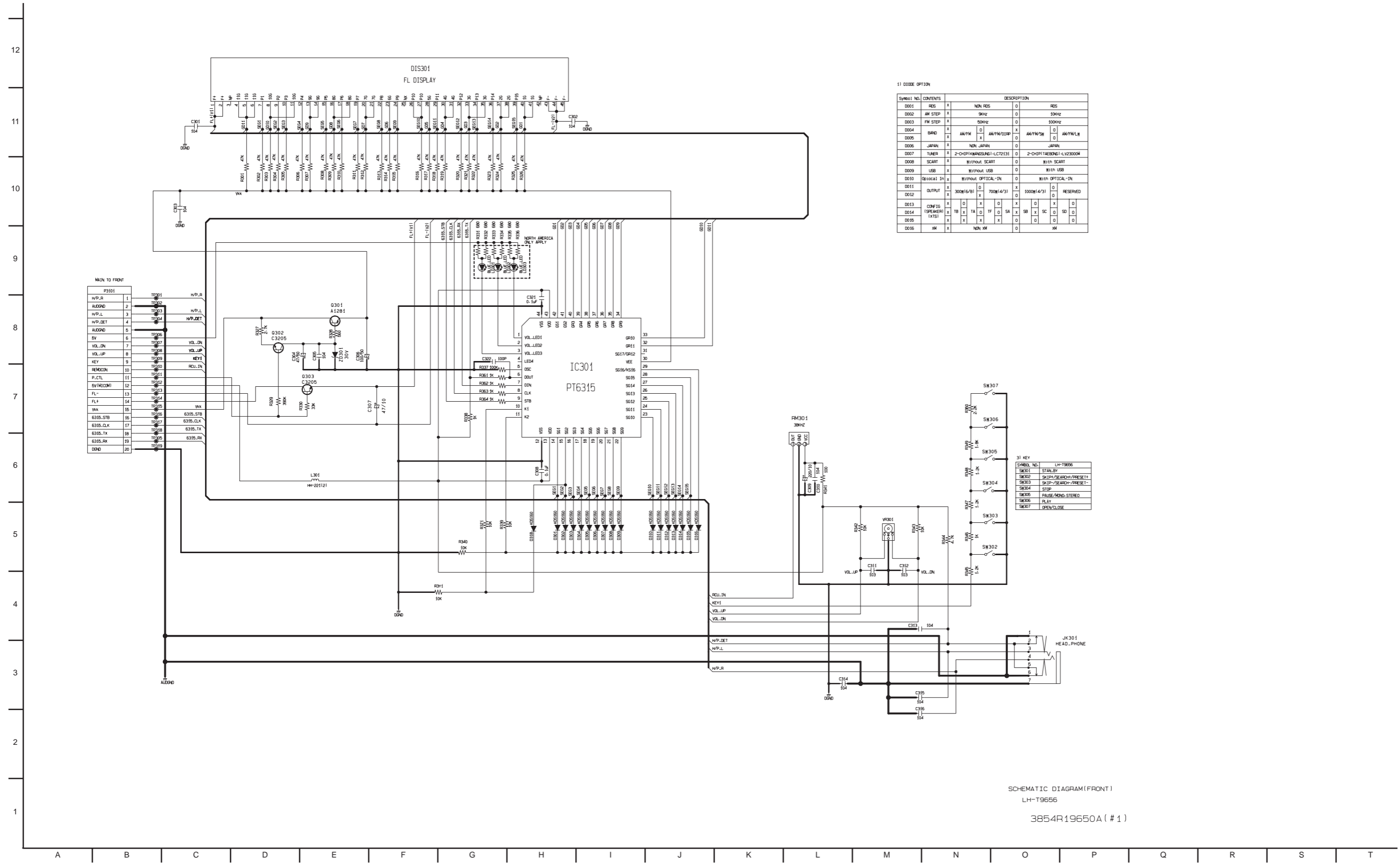

11 DIODE OPTION

Symbol No.	CONTENTS	DESCRIPTION
D001	RES	NON RES
D002	AM STEP	90Hz
D003	FM STEP	500Hz
D004	BAND	AM/FM
D005	JAPAN	NON JAPAN
D006	TUNER	2-CHIP/TUNING/AGC
D007	SCART	Without SCART
D008	USB	Without USB
D009	Optical In	Without OPTICAL-IN
D010	OUTPUT	300W(6/9) 700W(4/3) 1000W(4/3)
D011	COMP 10 (SPECIFIER) (KTS)	TR TA TF SA SB SC SD SE
D012	RESERVED	
D013	RESERVED	
D014	RESERVED	
D015	RESERVED	
D016	NON	NON

31 KEY

Symbol No.	DESCRIPTION
SK301	STANDBY
SK302	SKIP/SEARCH/PRESET1
SK303	SKIP/SEARCH/PRESET1-
SK304	STOP
SK305	PAUSE/MONO/STEREO
SK306	PLAY
SK307	OPEN/CLOSE

SCHEMATIC DIAGRAM(FRONT)
LH-T9656
3854R19650A (# 1)

PRINTED CIRCUIT BOARD DIAGRAMS

1. MAIN P.C. BOARD DIAGRAM (TOP VIEW)

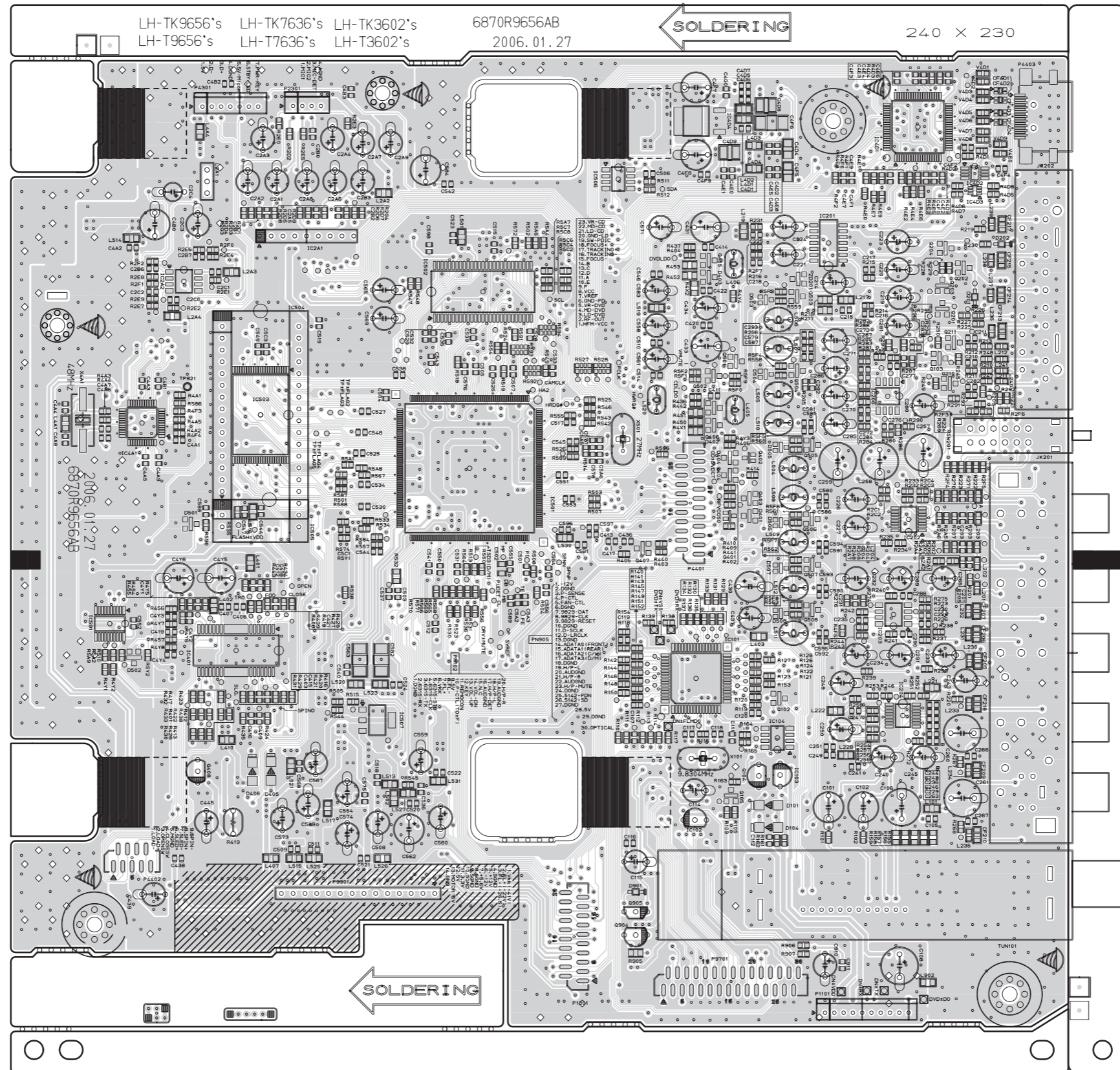

2. MAIN P.C. BOARD DIAGRAM (BOTTOM VIEW)

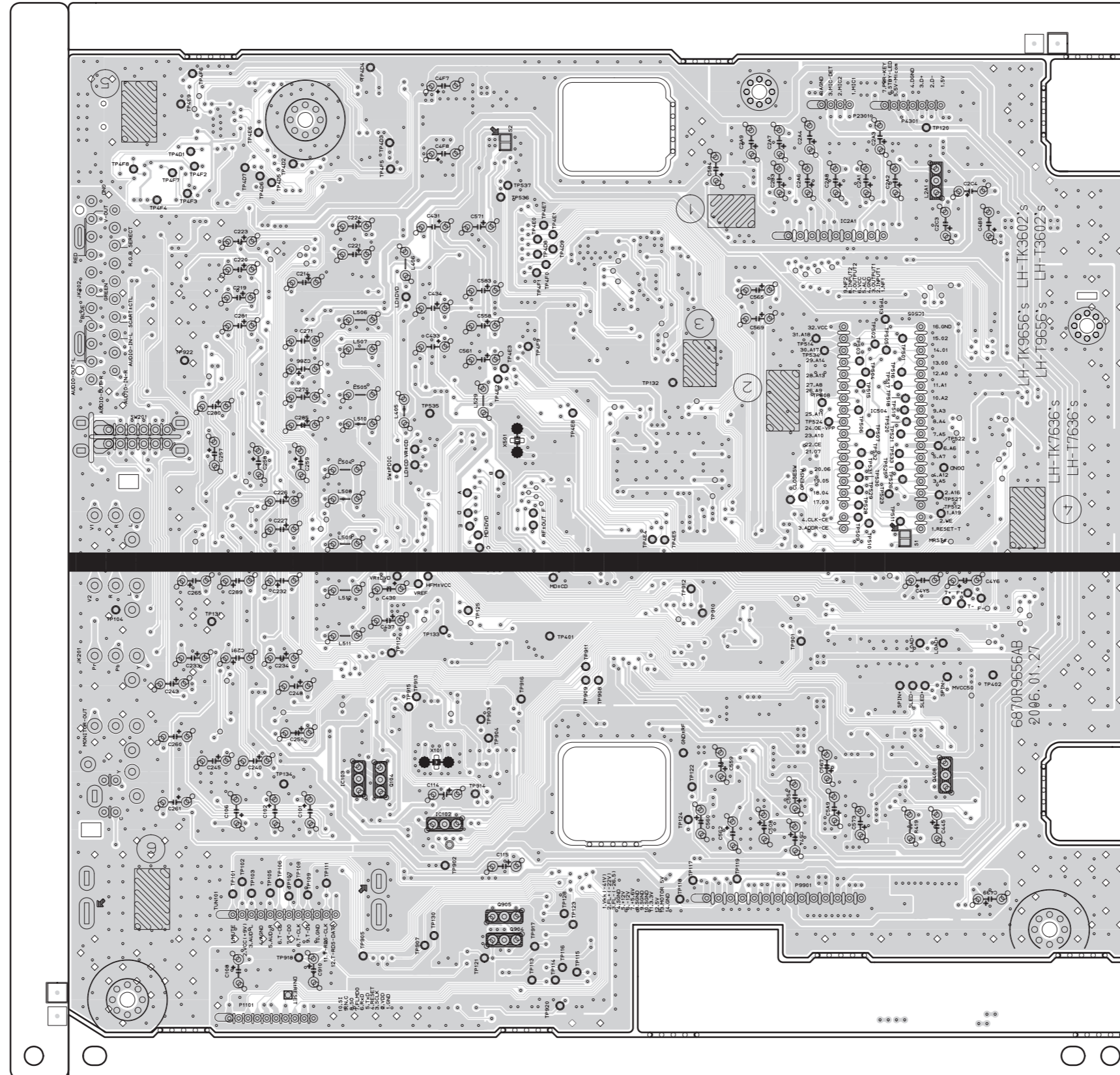

3. SMPS P.C. BOARD (1000W, LH-T96'S) (TOP VIEW)

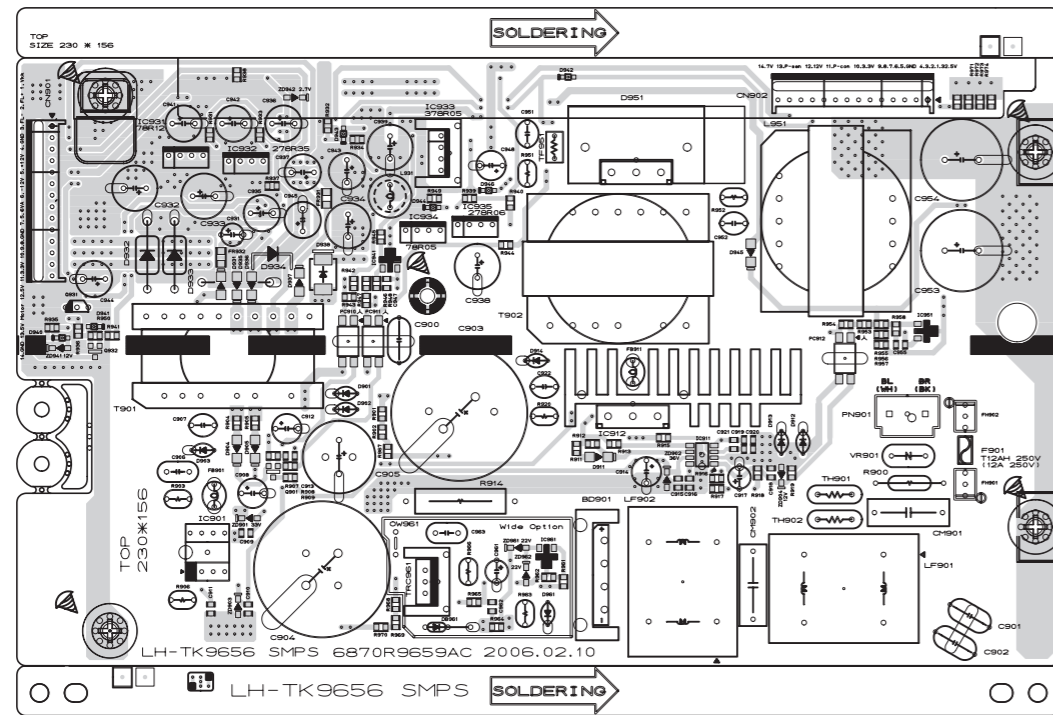

(BOTTOM VIEW)

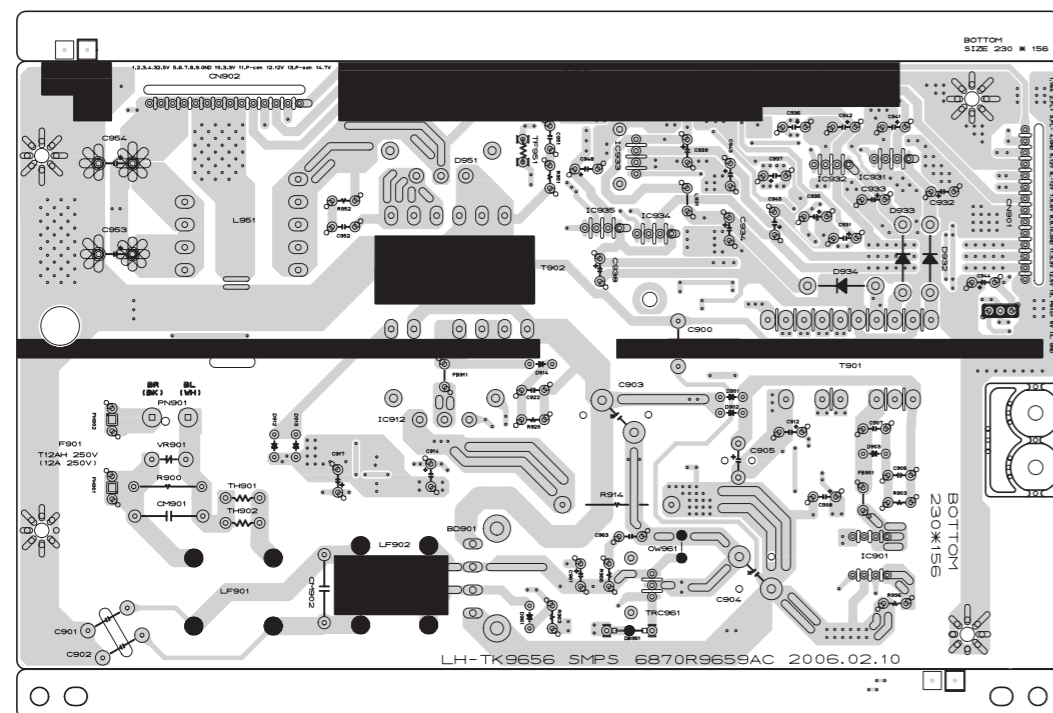

4. SMPS P.C. BOARD (700W, LH-T76'S)

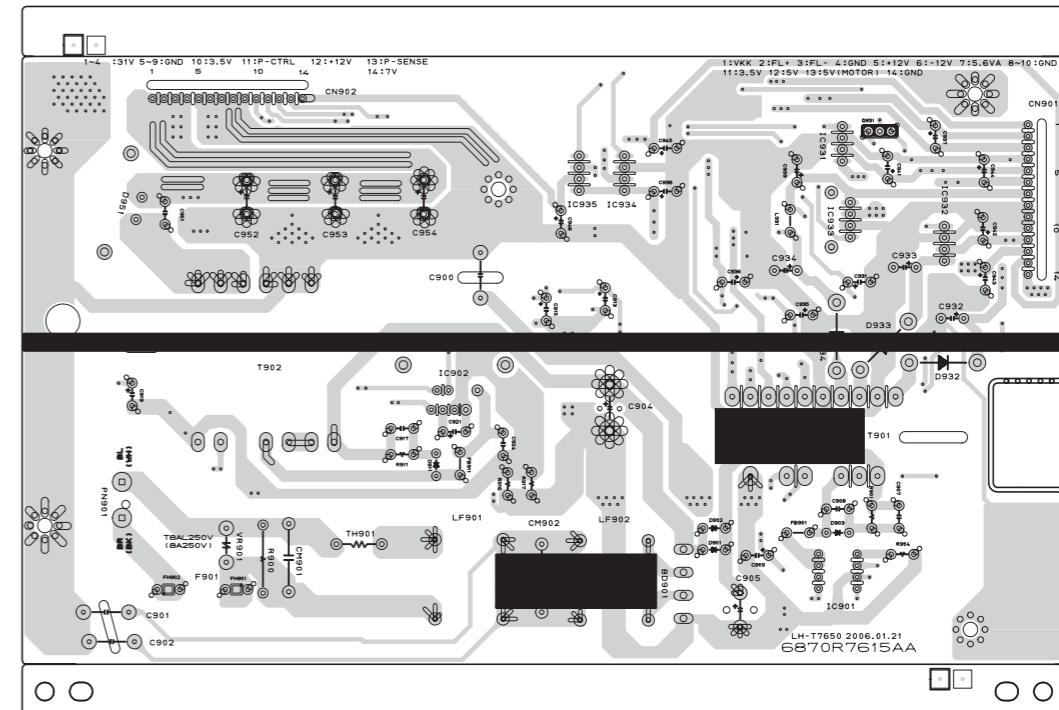

5. SMPS P.C. BOARD (300W, LH-T36'S)

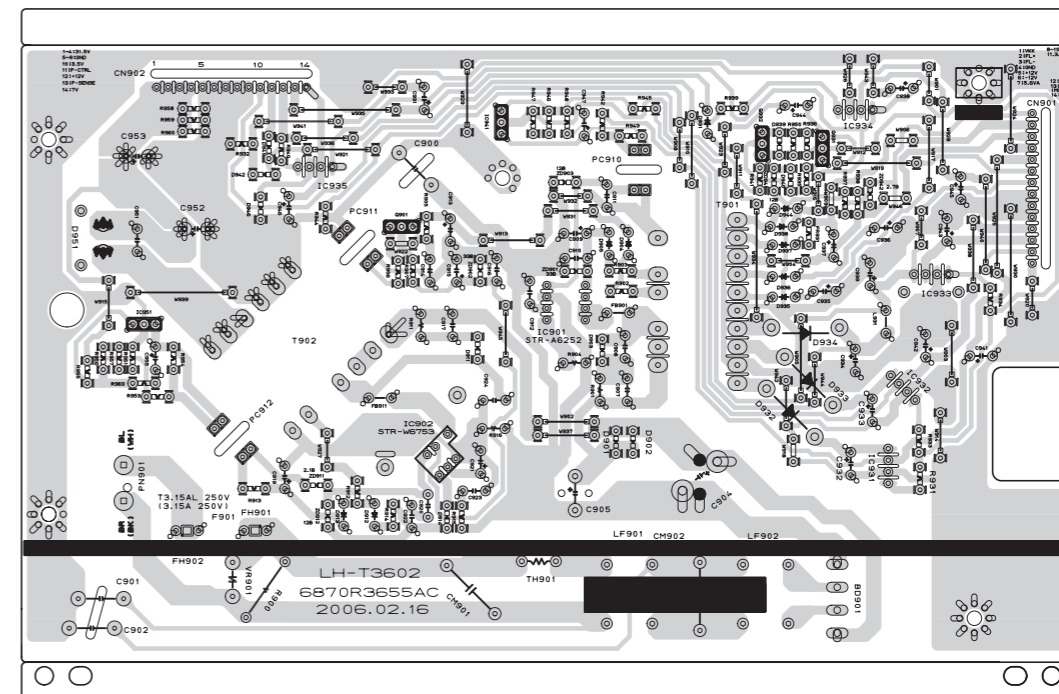

SECTION 3. DVD & AMP PART

ELECTRICAL TROUBLESHOOTING GUIDE

1. System operation flow

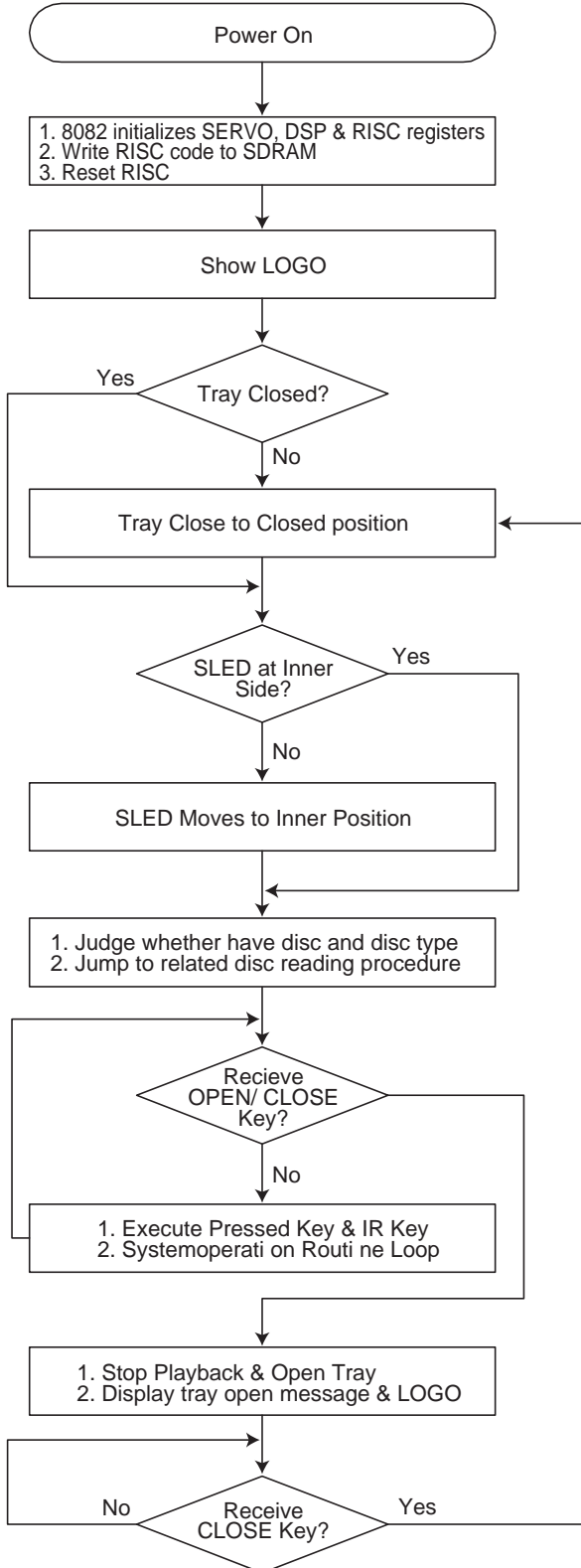

2. Test & debug flow

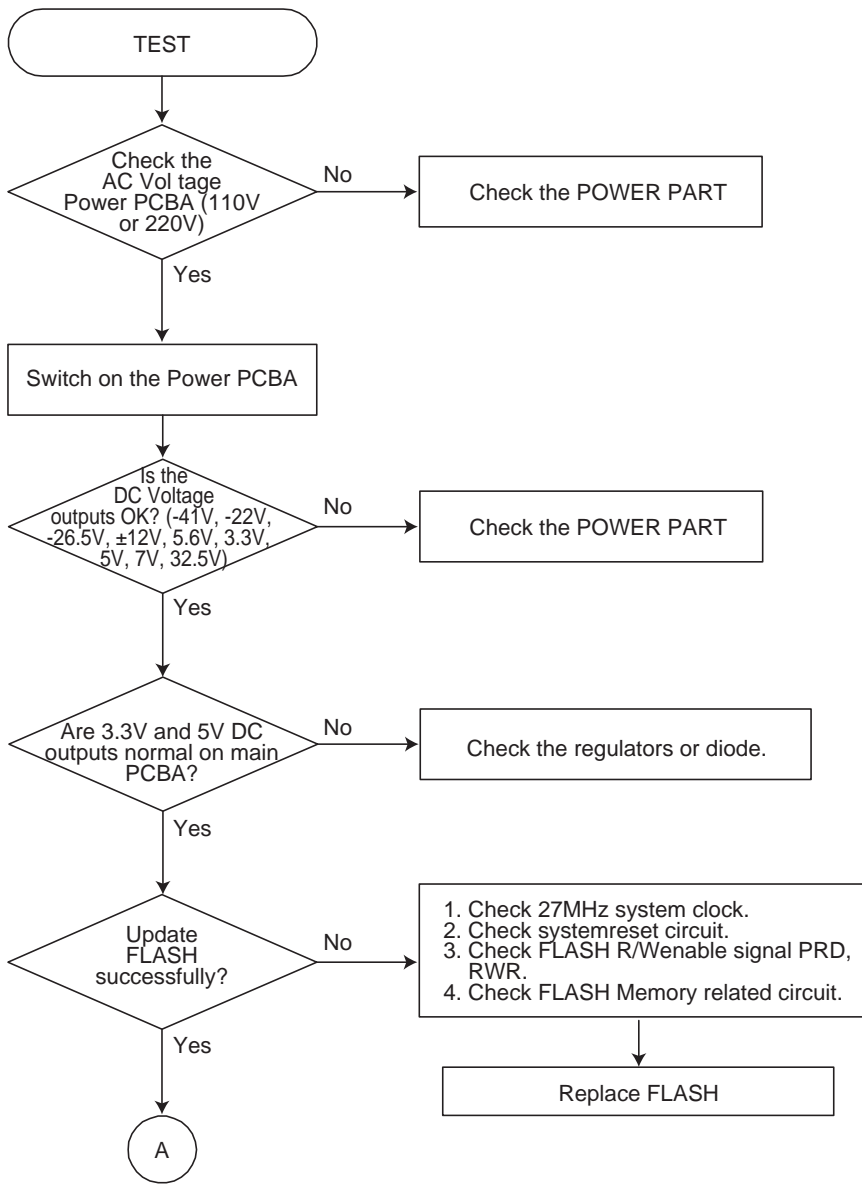

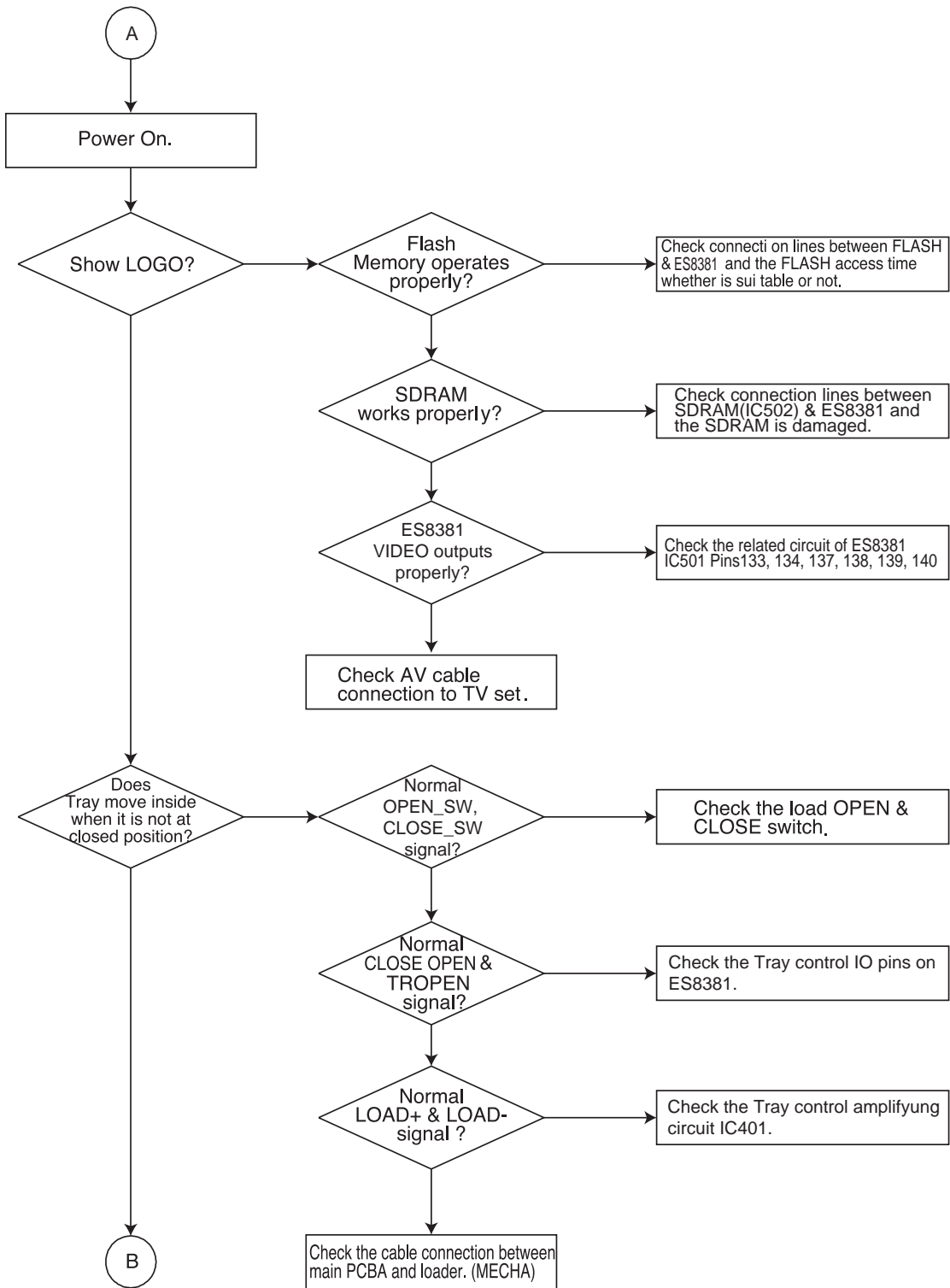

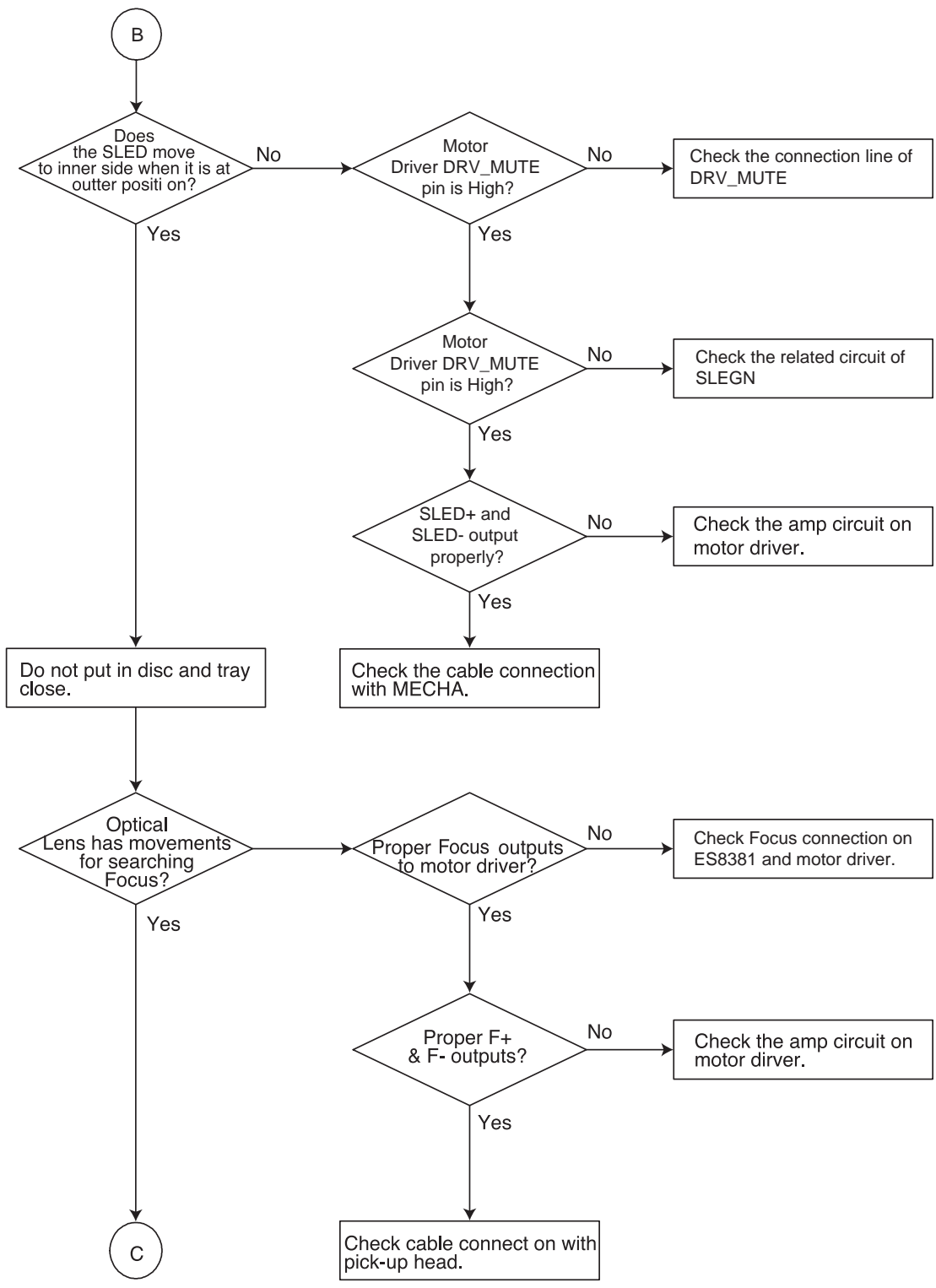

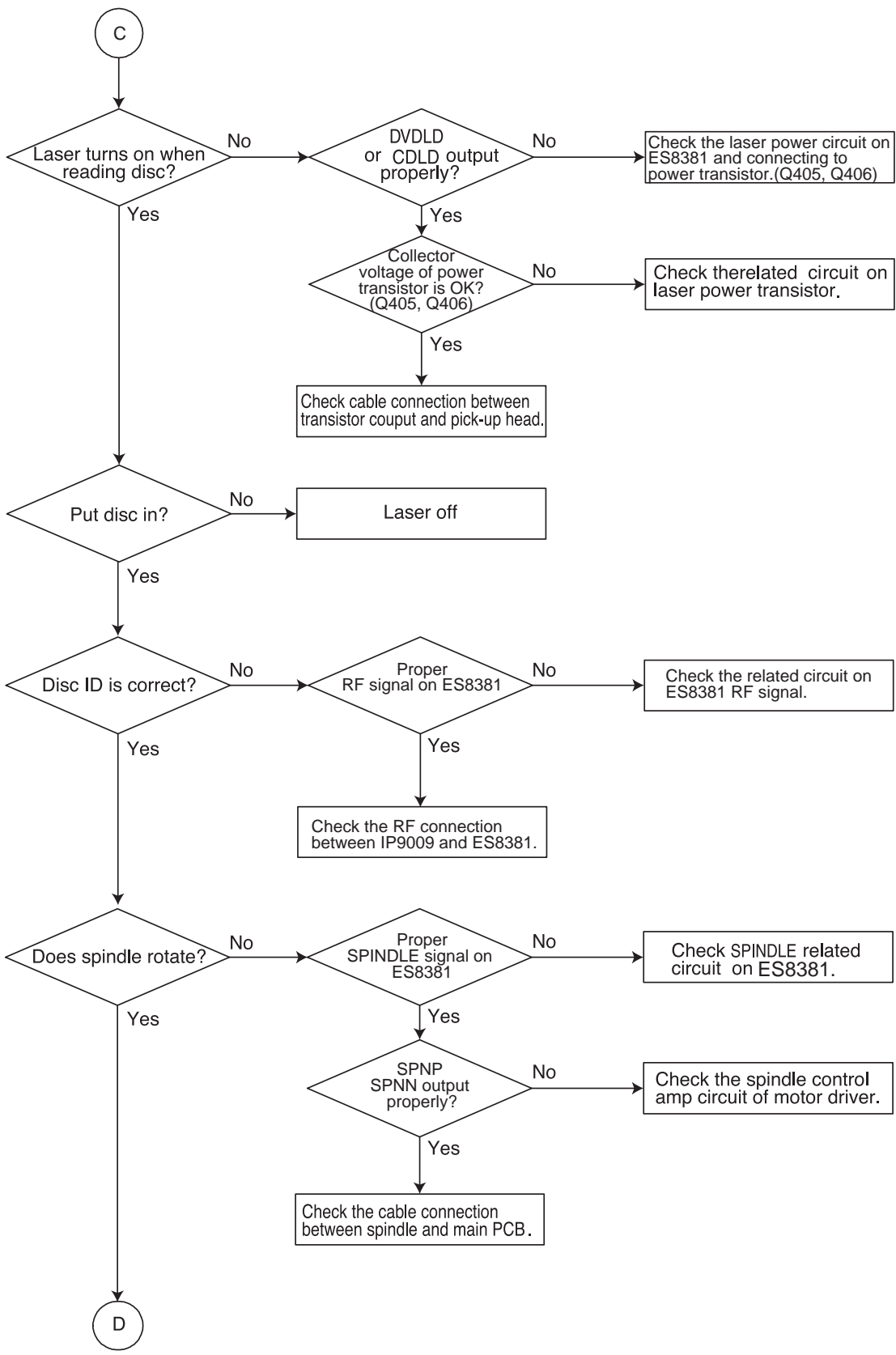

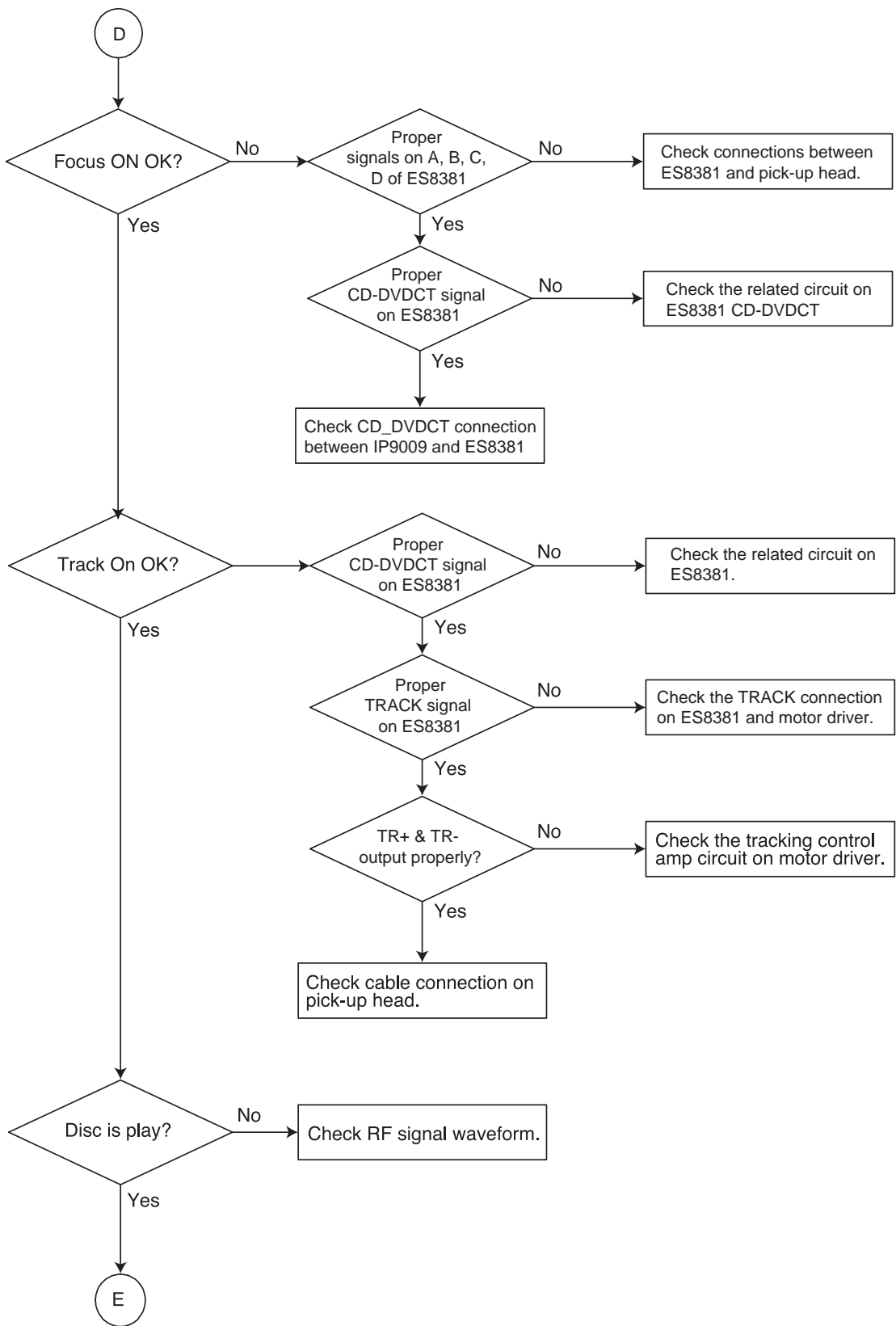

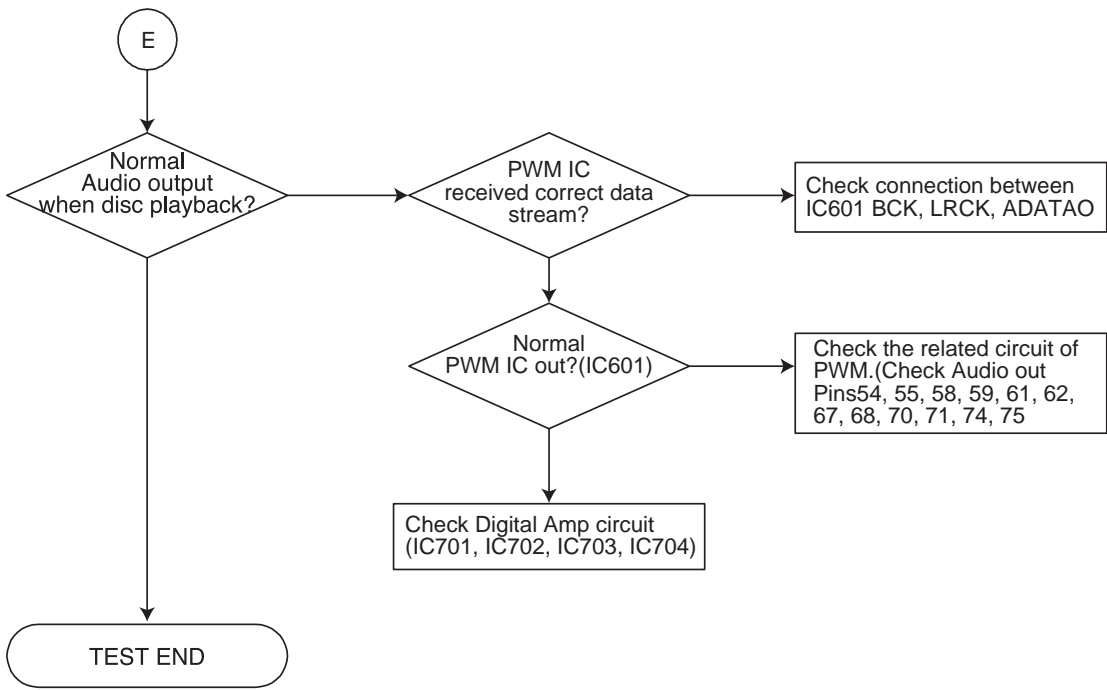

3. AUDIO μ -COM Circuit(DVD & AMP)

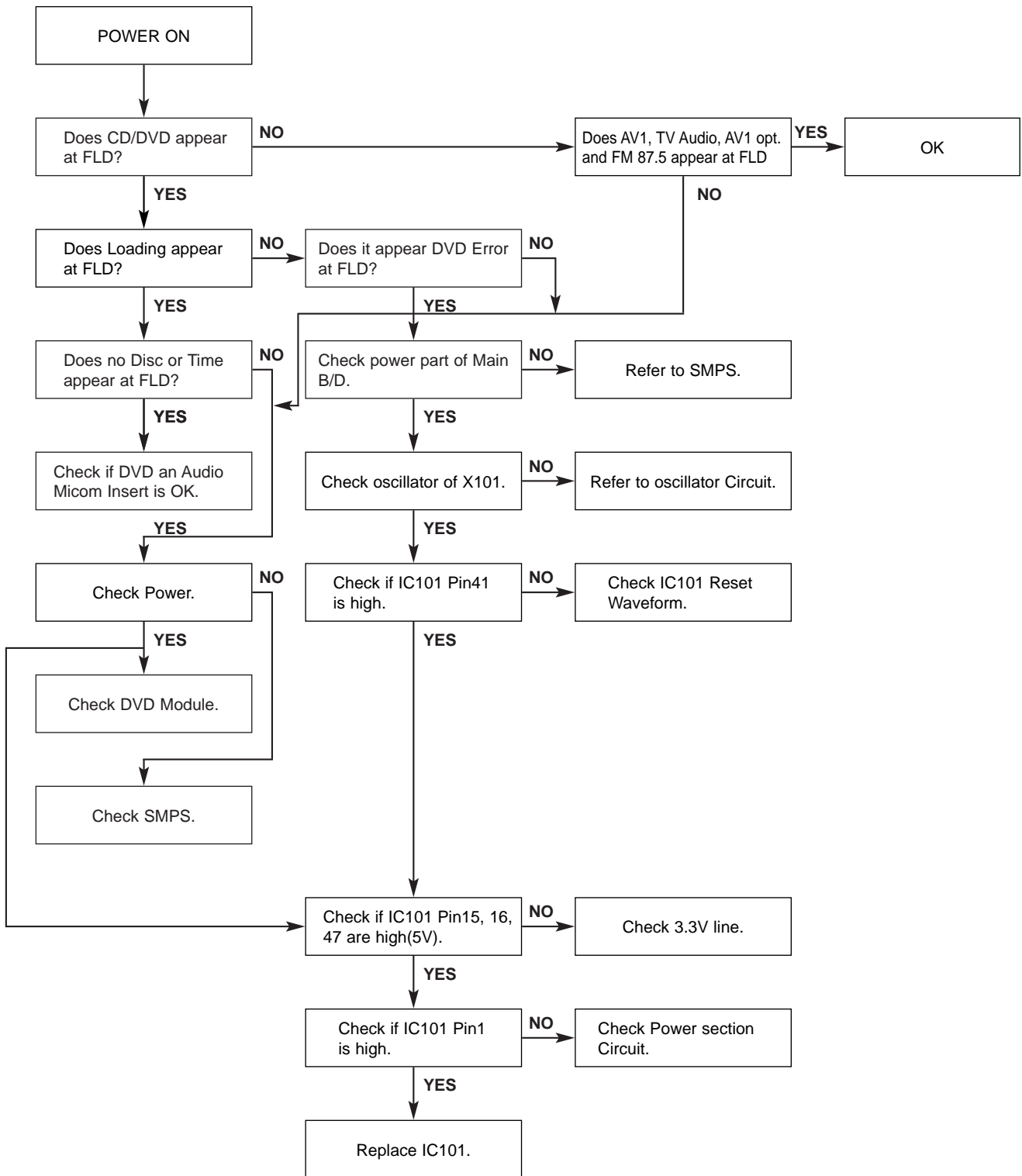

DETAILS AND WAVEFORMS ON SYSTEM TEST AND DEBUGGING

1. SYSTEM 27MHz CLOCK,RESET,FLASH R/W SIGNAL

1) ES8381 main clock is at 27MHz(X501)

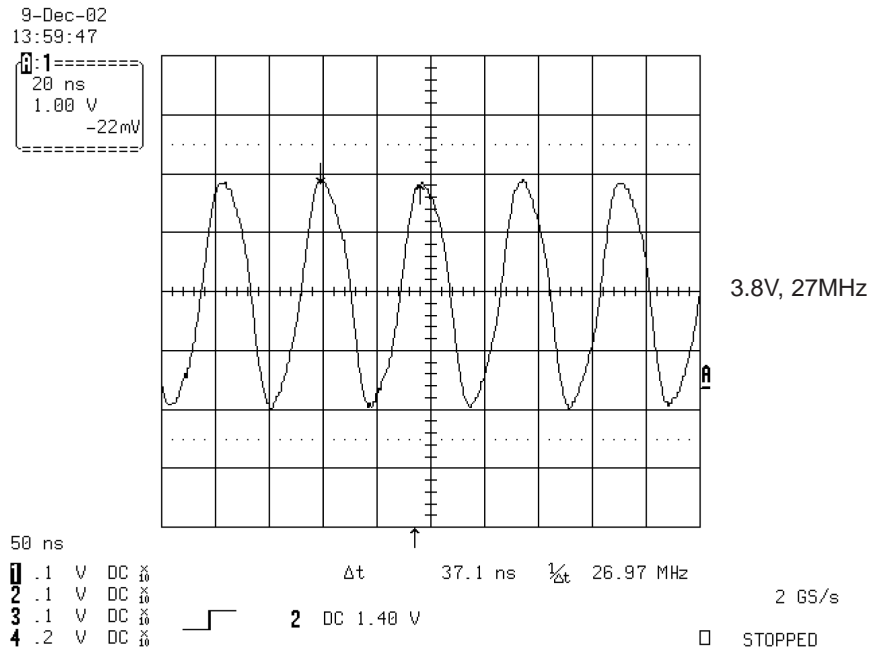

FIG 1-1

2) ES8381 reset is high active.

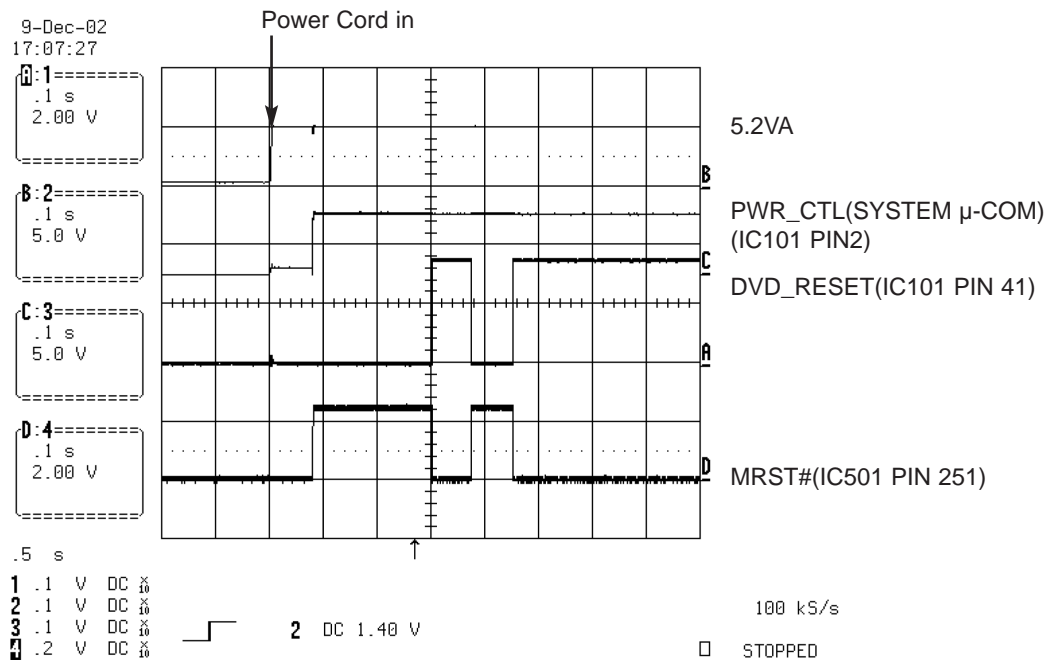

FIG 1-2

3) Flash R/W enable signal during download(Downloading)

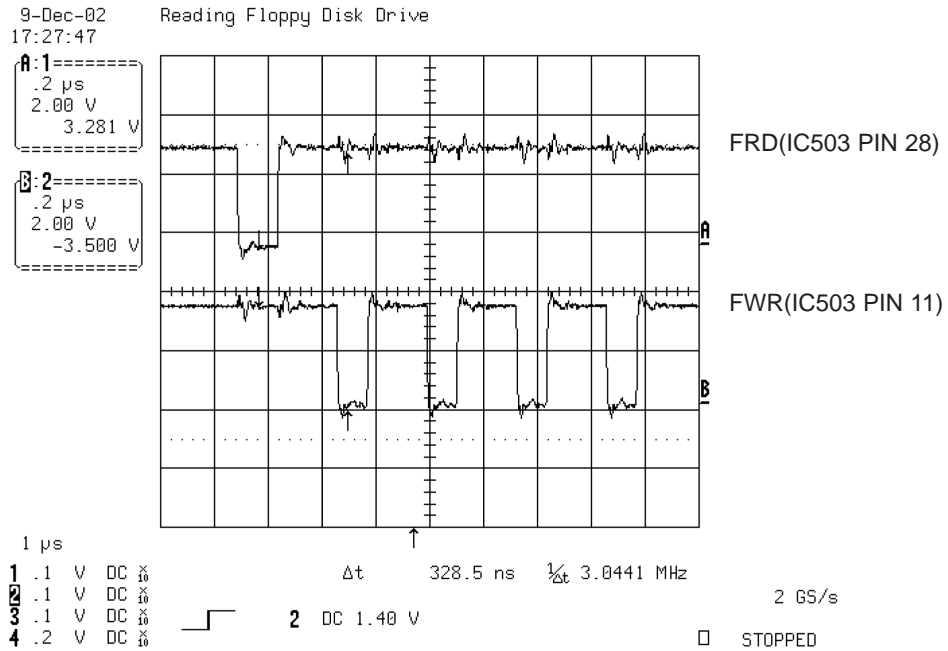

FIG 1-4

2. SDRAM CLOCK

1) ES8381 main clock is at 27MHz(X501)

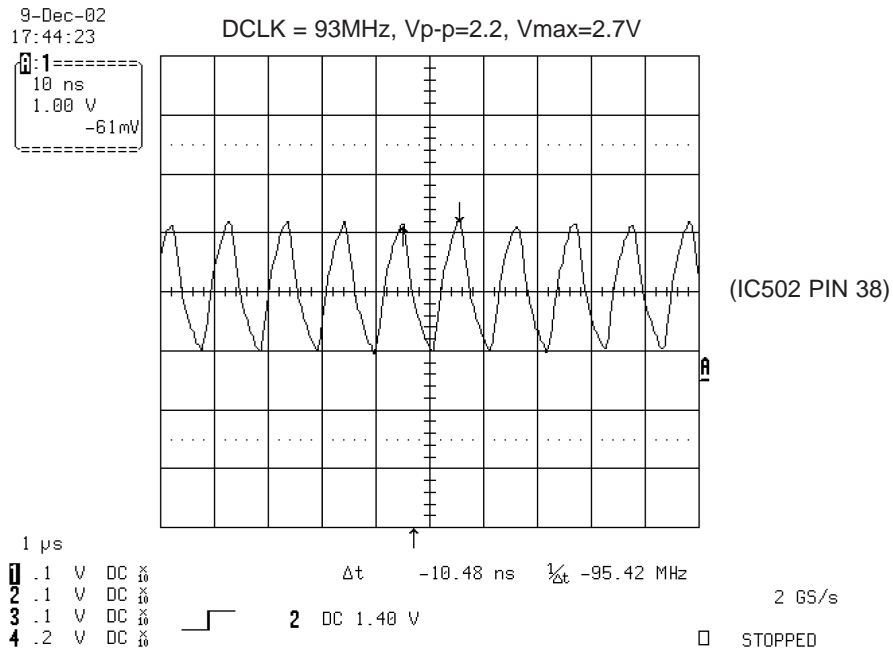

FIG 2-1

3. TRAY OPEN/CLOSE SIGNAL

1) Tray open/close waveform

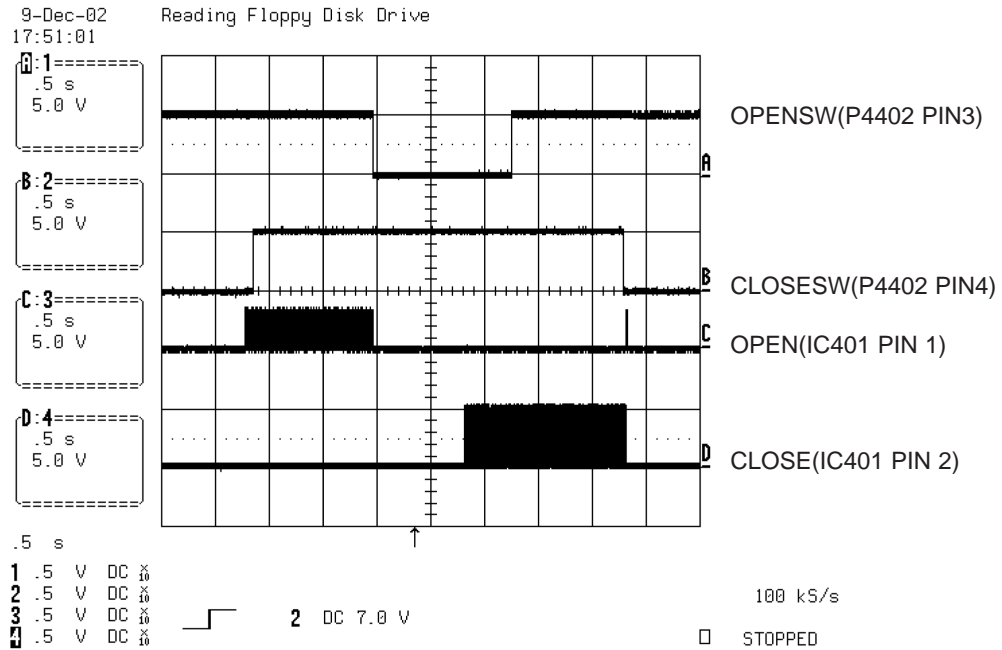

FIG 3-1

2) Tray close waveform

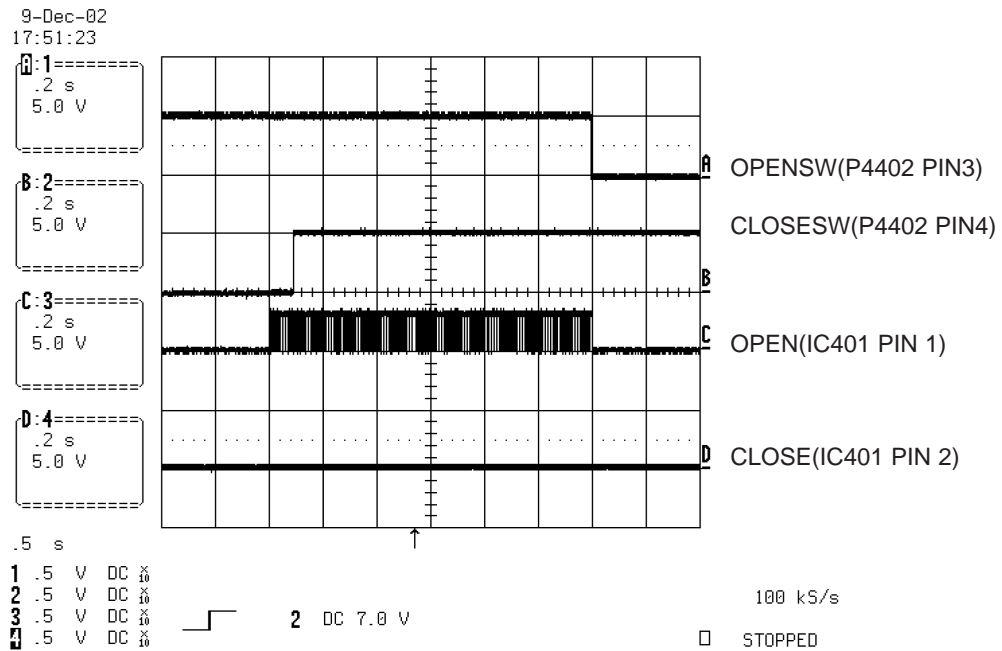

FIG 3-2

3) Tray open waveform

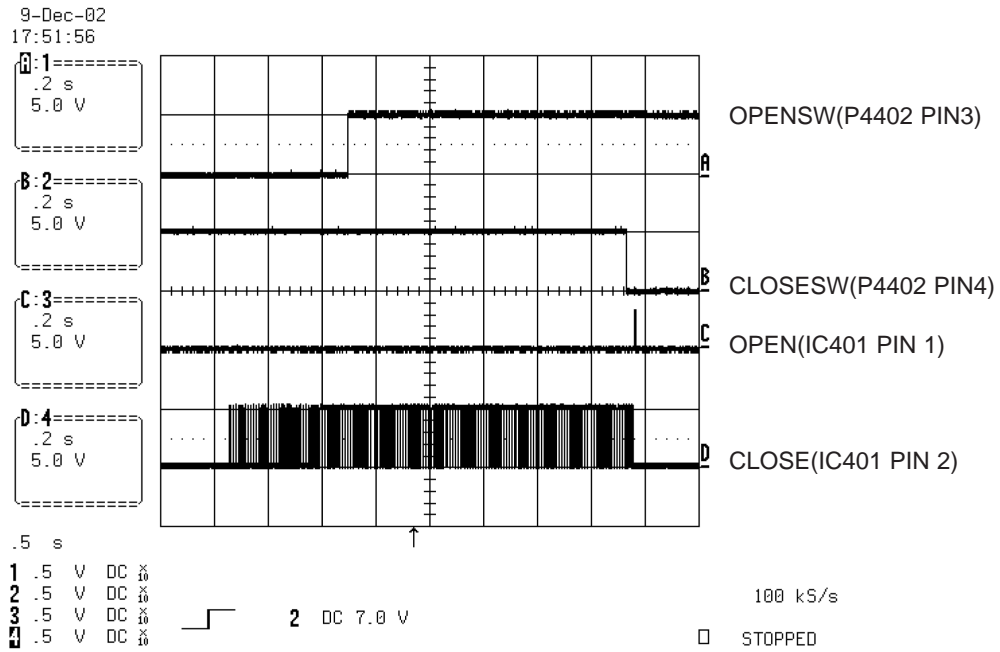

FIG 3-3

4. SLED CONTROL RELATED SIGNAL (NO DISC CONDITION)

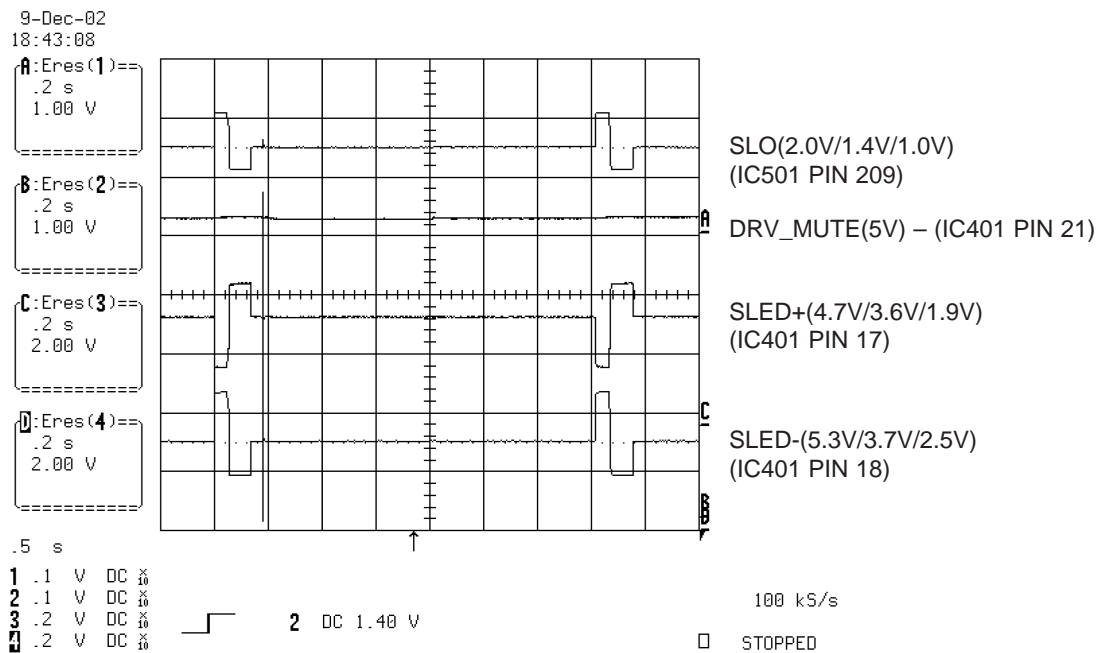

FIG 4-1

5. LENS CONTROL RELATED SIGNAL(NO DISC CONDITION)

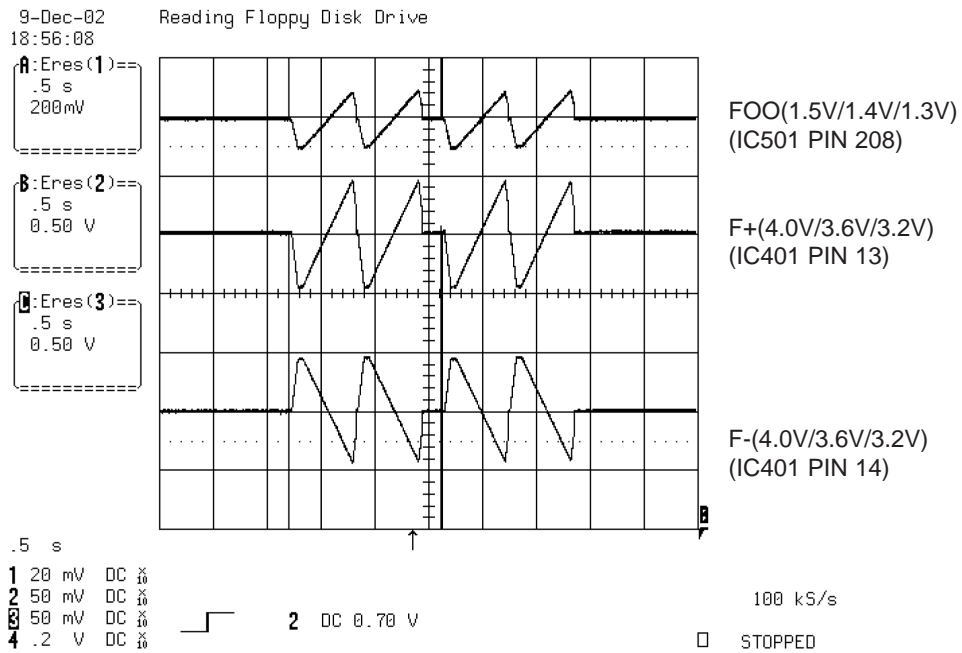

FIG 5-1

6. LASER POWER CONTROL RELATED SIGNAL(NO DISC CONDITION)

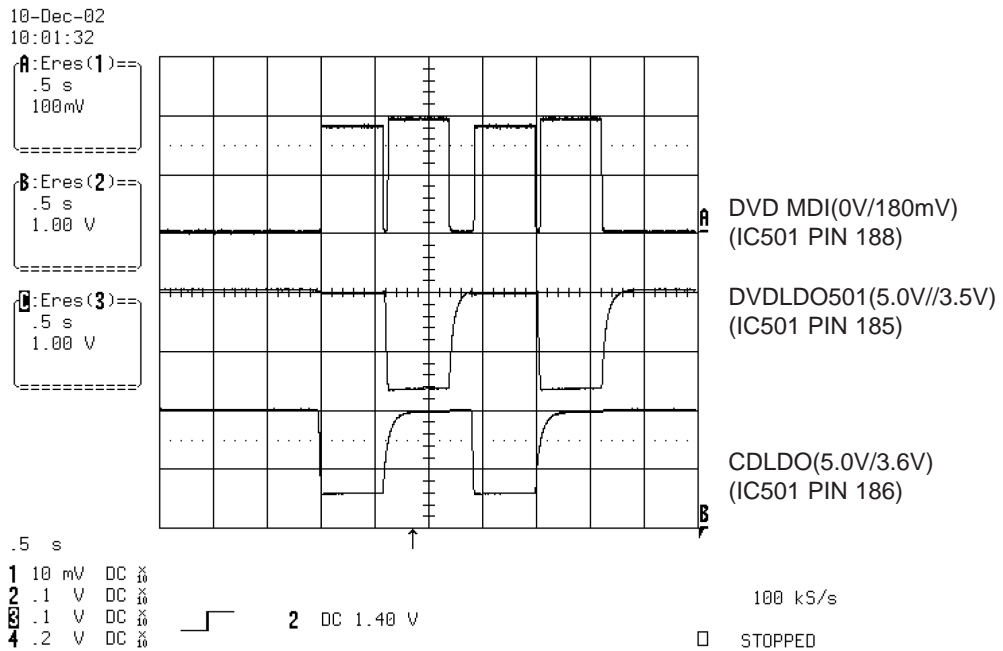

FIG 6-1

7. DISC TYPE JUDGEMENT WAVEFORMS

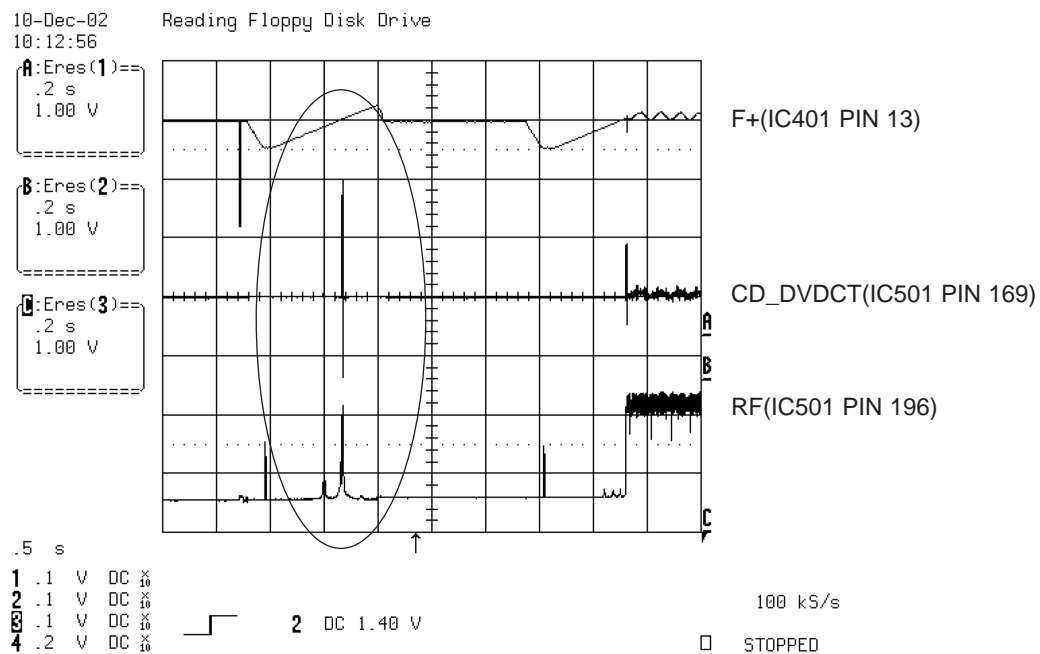

FIG 7-1 (DVD)

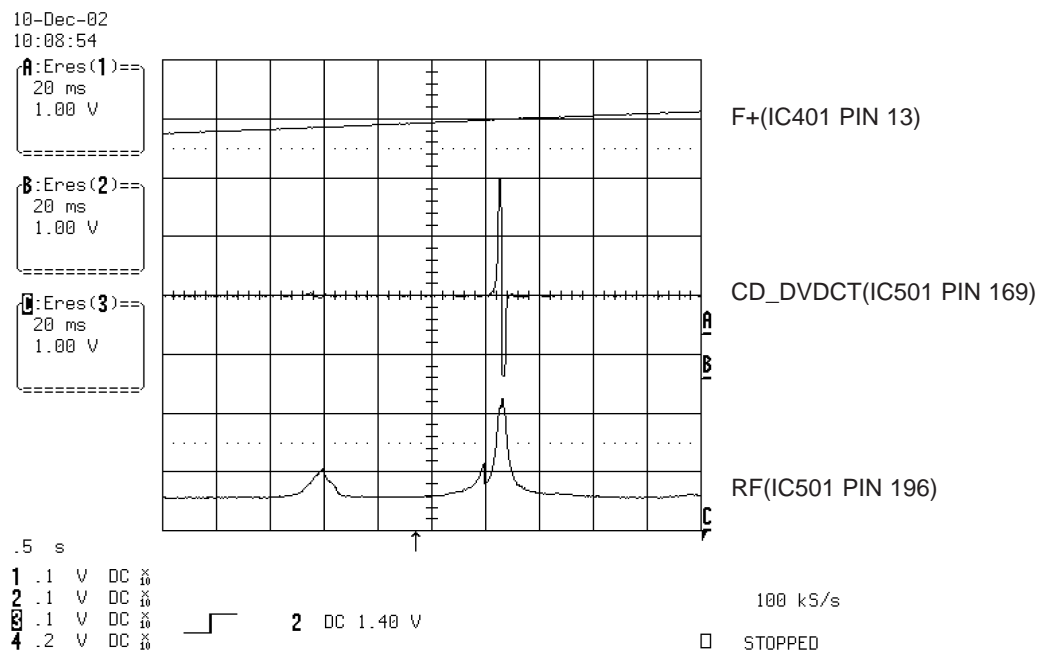

FIG 7-2 (DVD)

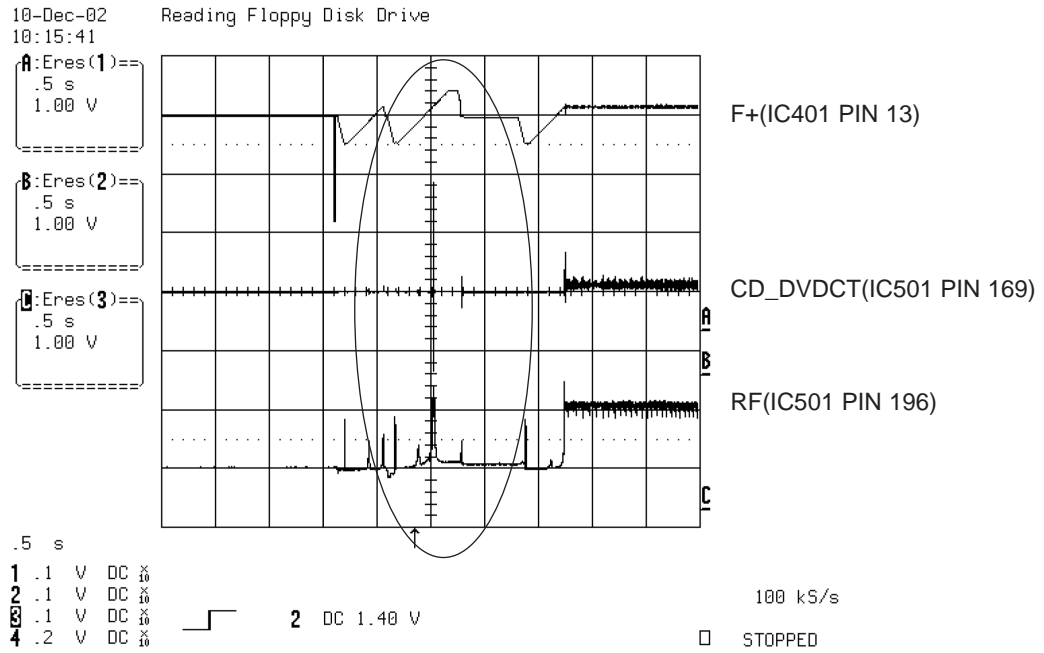

FIG 7-3 (CD)

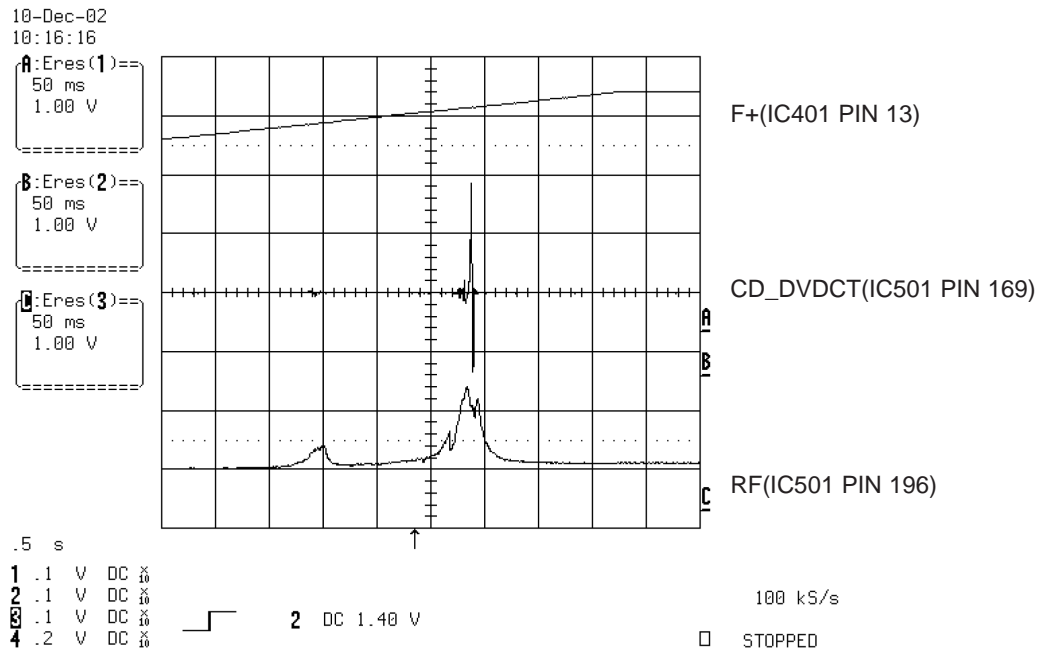

FIG 7-4 (CD)

8. FOCUS ON WAVEFORMS

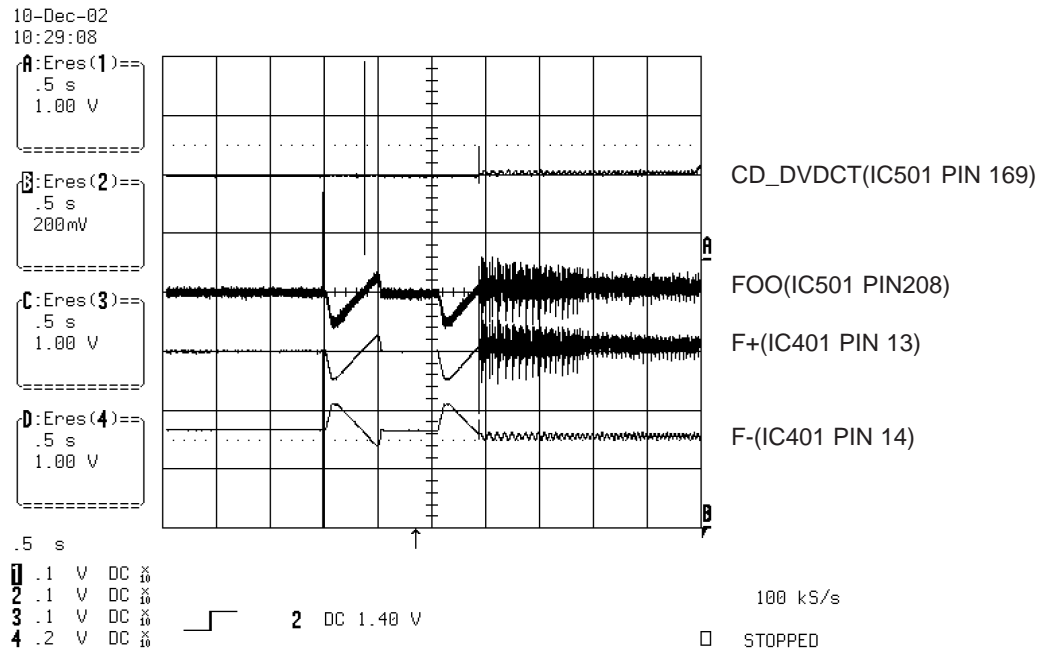

FIG 8-1 (DVD)

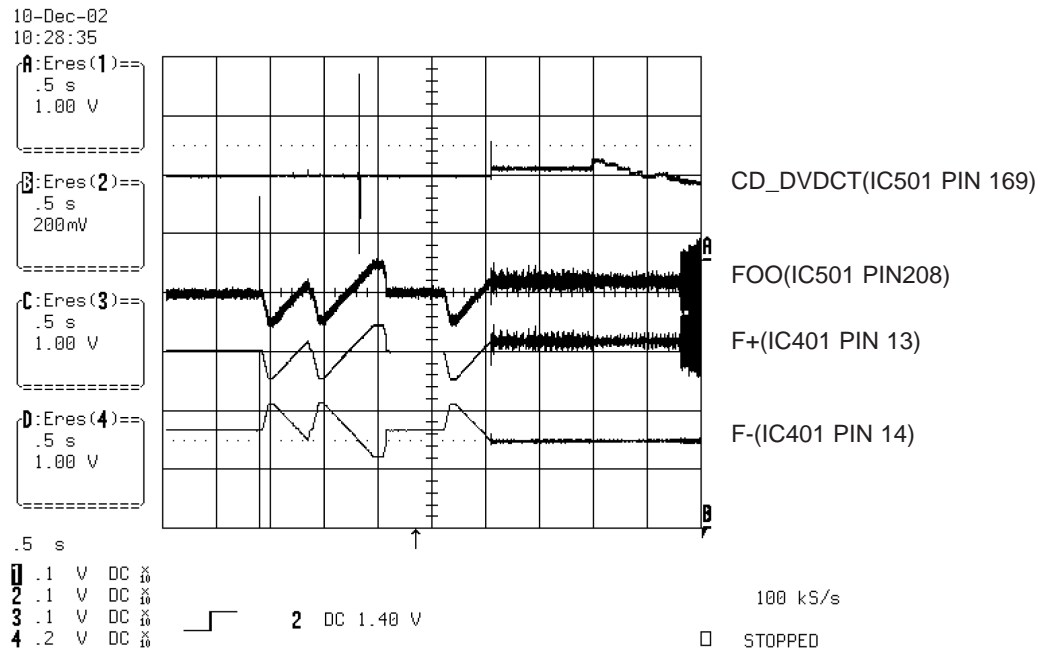

FIG 8-2 (CD)

9. SPINDLE CONTROL WAVEFORMS (NO DISC CONDITION)

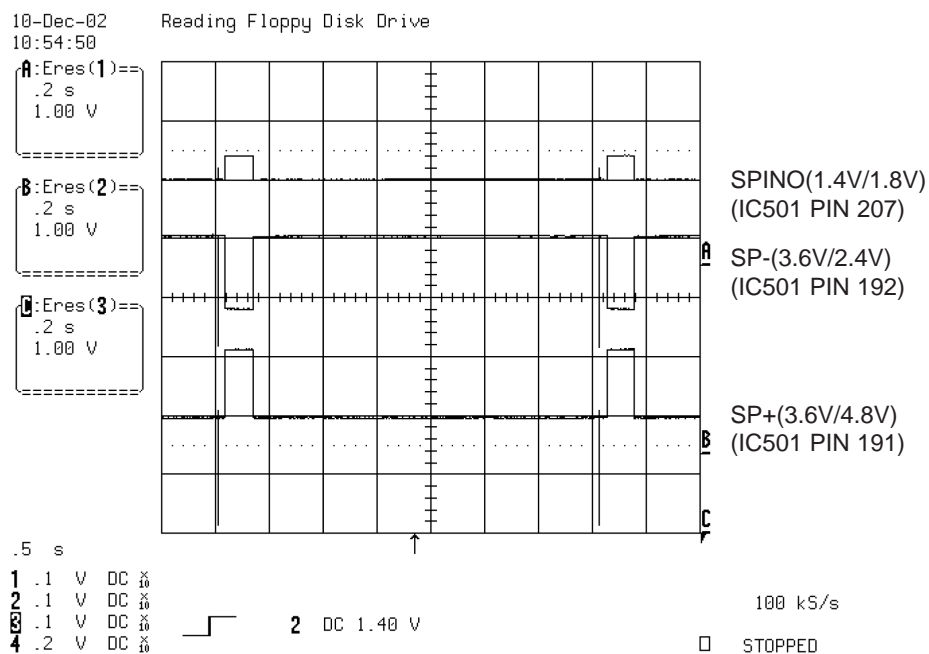

FIG 9-1

10. TRACKING CONTROL RELATED SIGNAL(System checking)

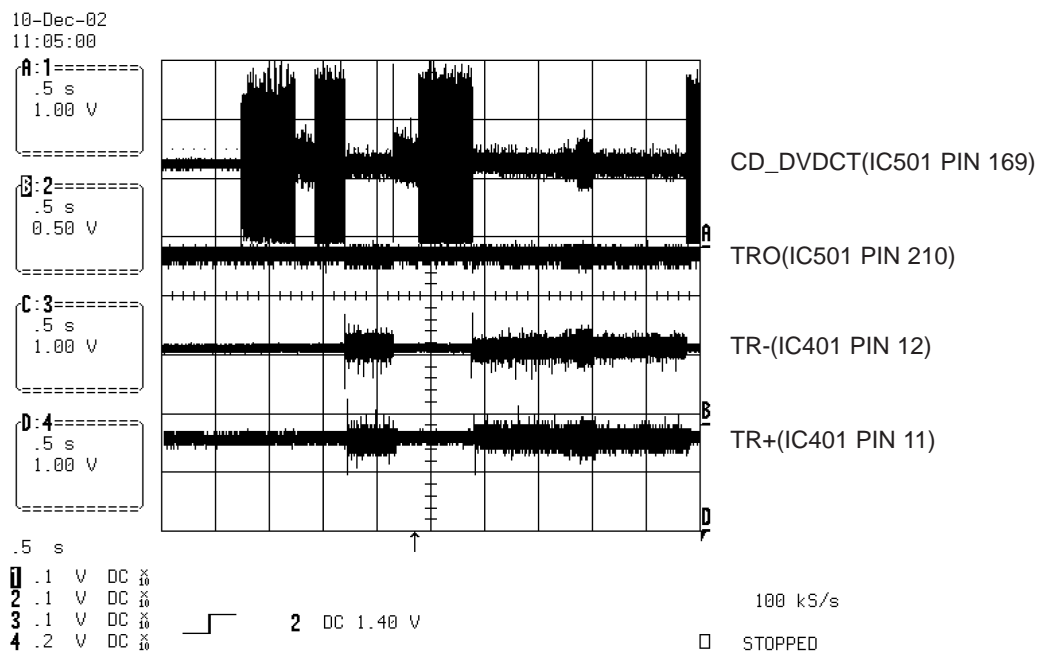

FIG 10-1(DVD)

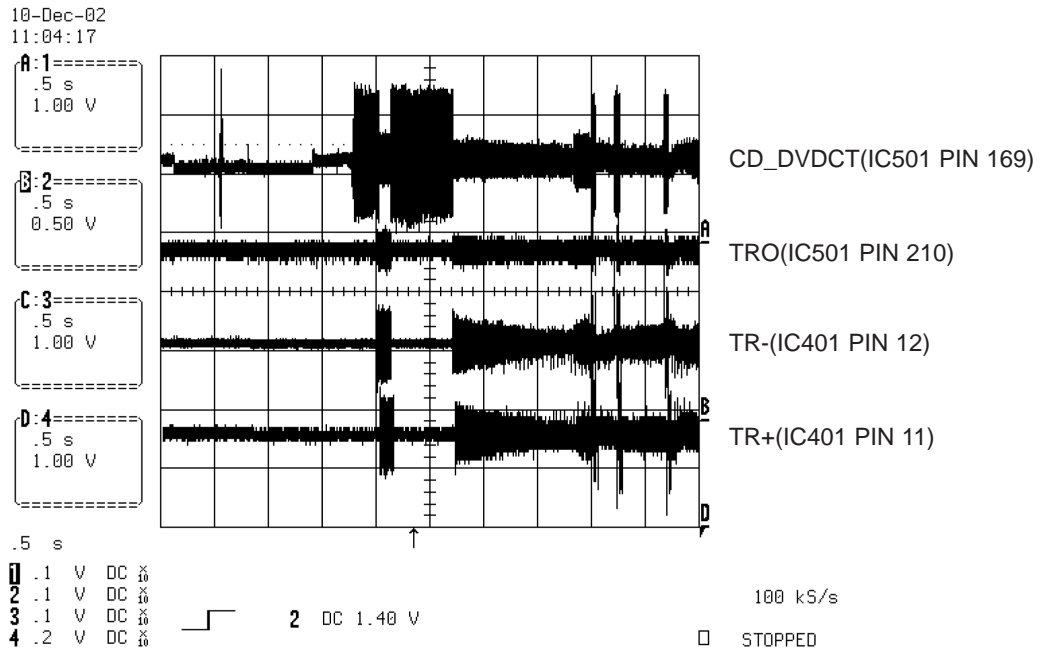

FIG 10-2(CD)

12. ES6698FD VIDEO OUTPUT WAVEFORMS

1) Full colorbar signal(COMPOSIT)

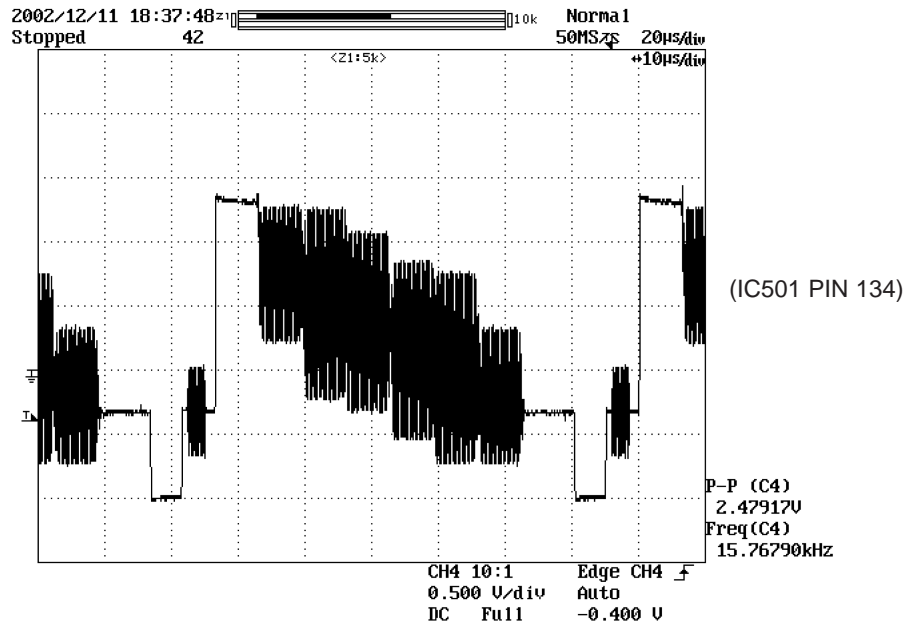

FIG 12-1

2) Y

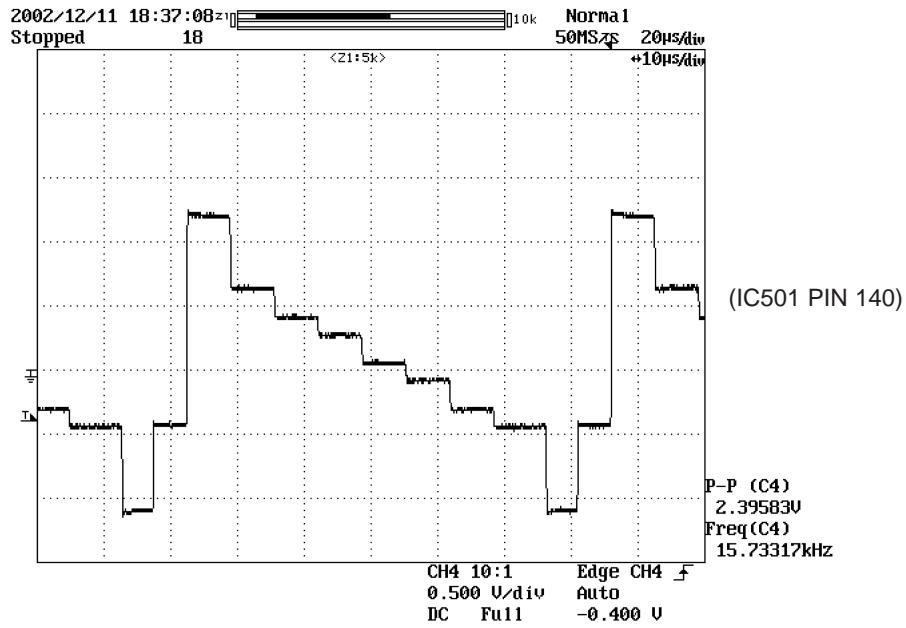

FIG 12-2

13. AUDIO OUTPUT FROM PWM IC

1) Audio L/R

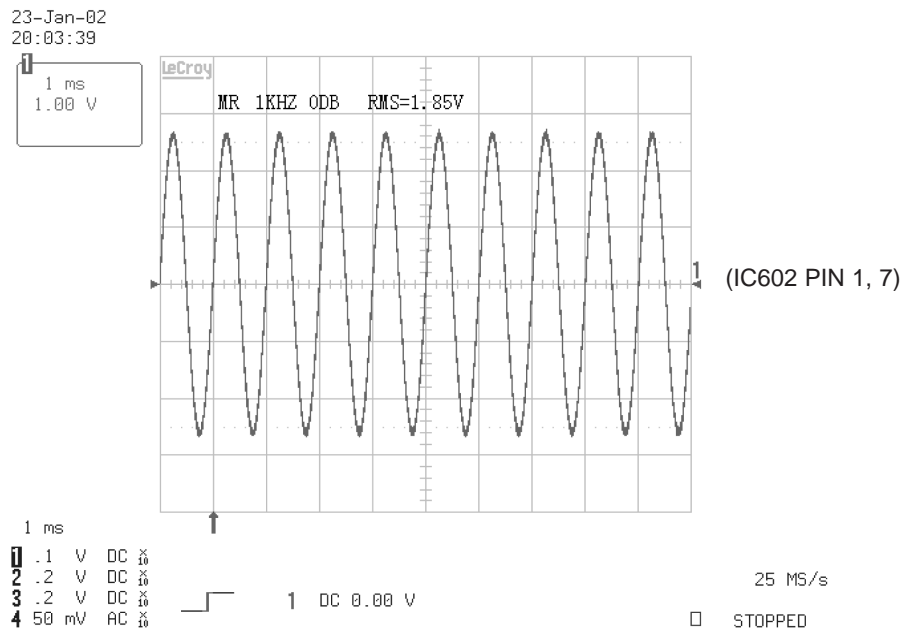

FIG 13-1

2) Audio related Signal

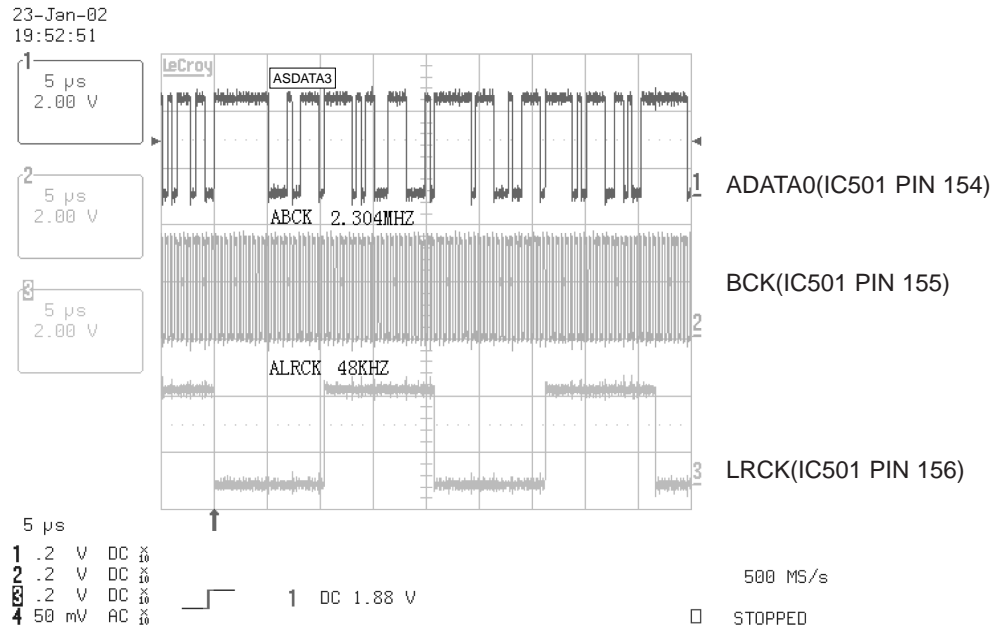
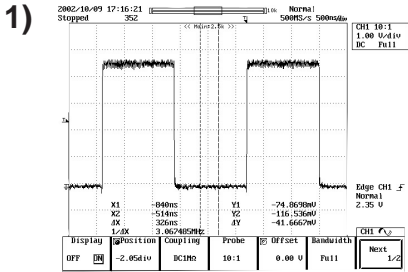
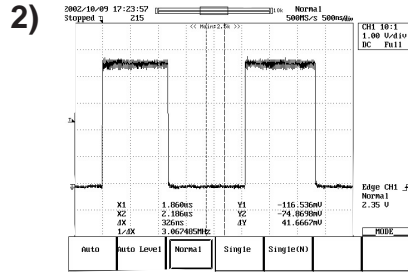

FIG 13-2

14. DVD & AMP WAVEFORMS



- R620 → TP611
- or
- R621 TP612



- R618 → TP609
- or
- R619 TP610

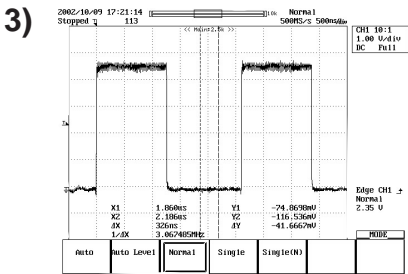

- R612 → TP603
- or
- R613 TP604

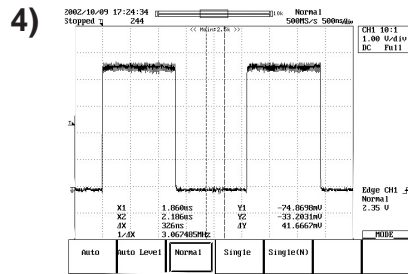

- R610 → TP601
- or
- R611 TP602

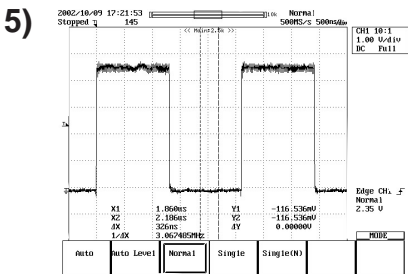

- R614 → TP605
- or
- R615 TP606

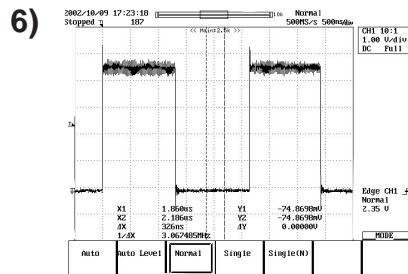

- R616 → TP607
- or
- R617 TP608

MEMO

A series of horizontal dotted lines for writing.

2. DSP CIRCUIT DIAGRAM

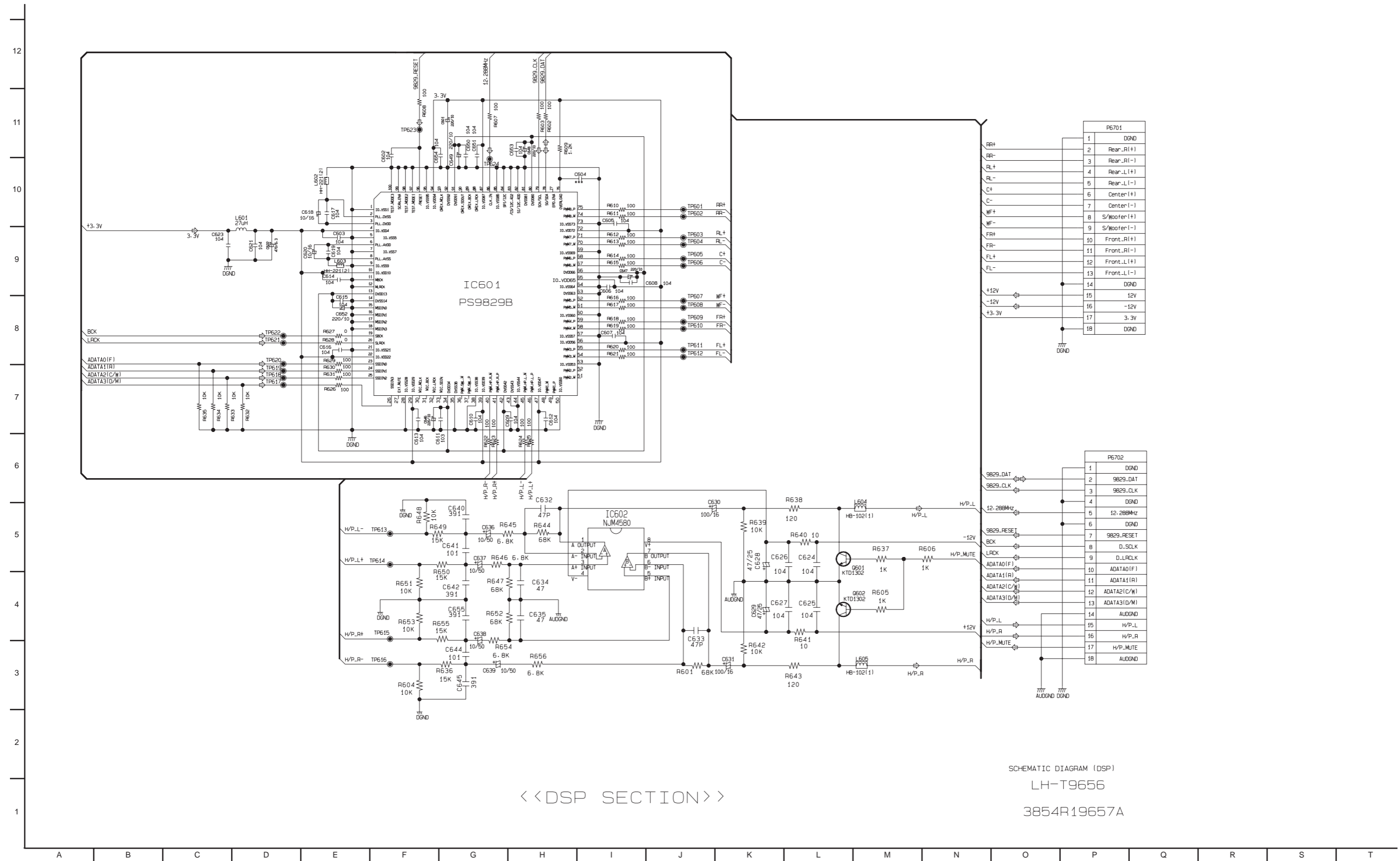

SCHMATIC DIAGRAM (DSP)

LH-T9656

3854R19657A

<< DSP SECTION >>

3. AMP CIRCUIT DIAGRAM(700W/1000W, LH-T76/96'S)

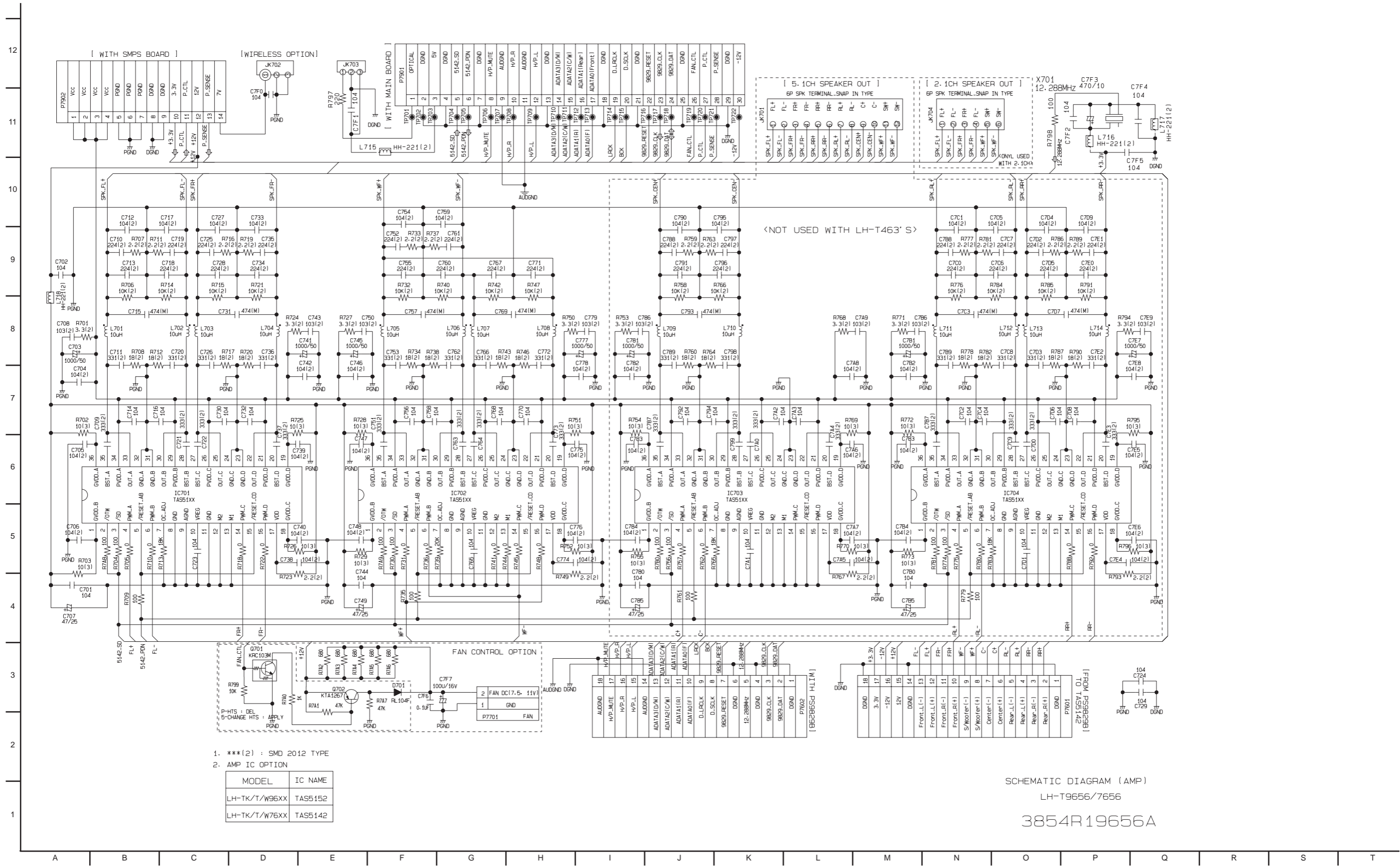

- 1. ***[2] : SMD 2012 TYPE
- 2. AMP IC OPTION

MODEL	IC NAME
LH-TK/T/W96XX	TAS5152
LH-TK/T/W76XX	TAS5142

SCHMATIC DIAGRAM (AMP)
LH-T9656/7656
3854R19656A

4. AMP CIRCUIT DIAGRAM(300W, LH-T36'S)

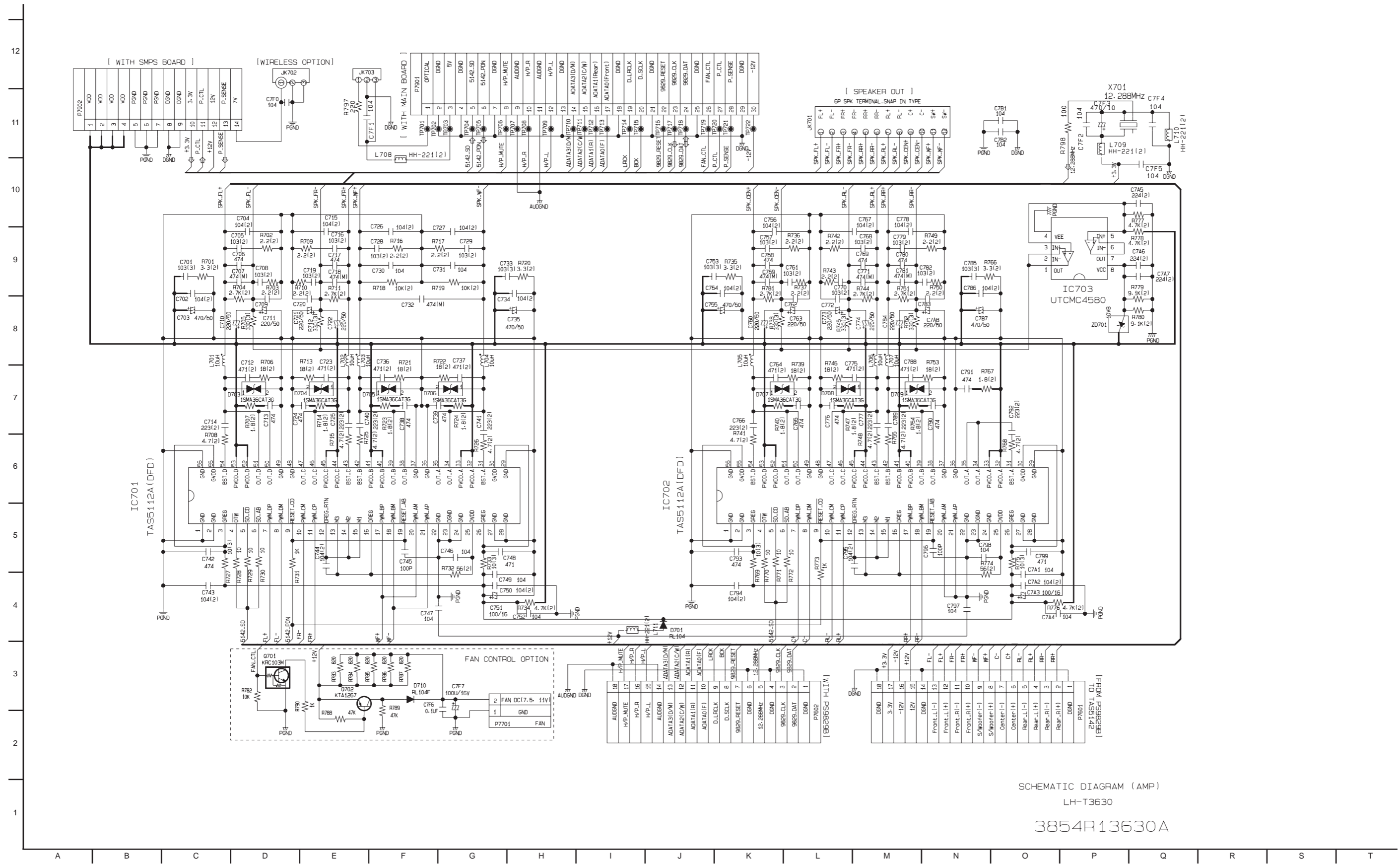

SCHMATIC DIAGRAM (AMP)
LH-T3630
3854R13630A

PRINTED CIRCUIT BOARD DIAGRAMS

1. DSP P.C. BOARD DIAGRAM

(TOP VIEW)

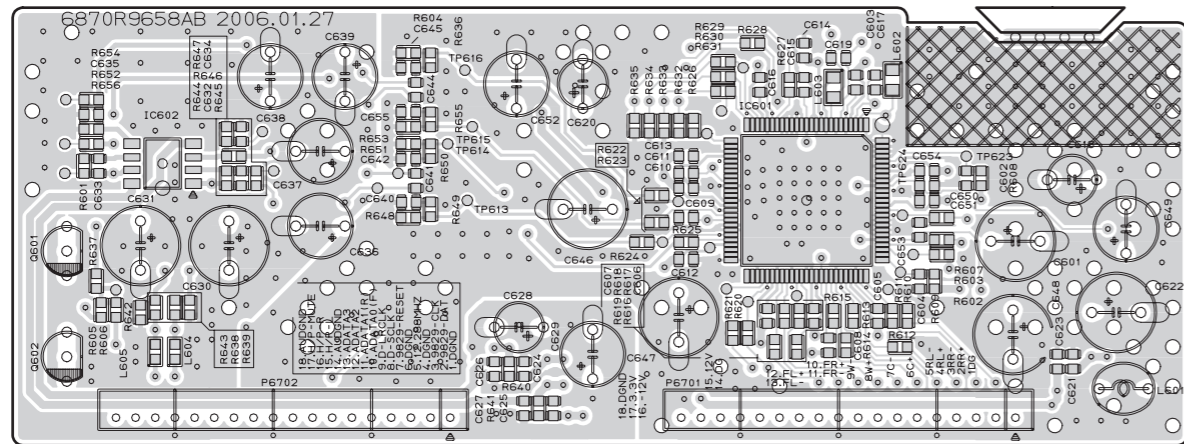

(BOTTOM VIEW)

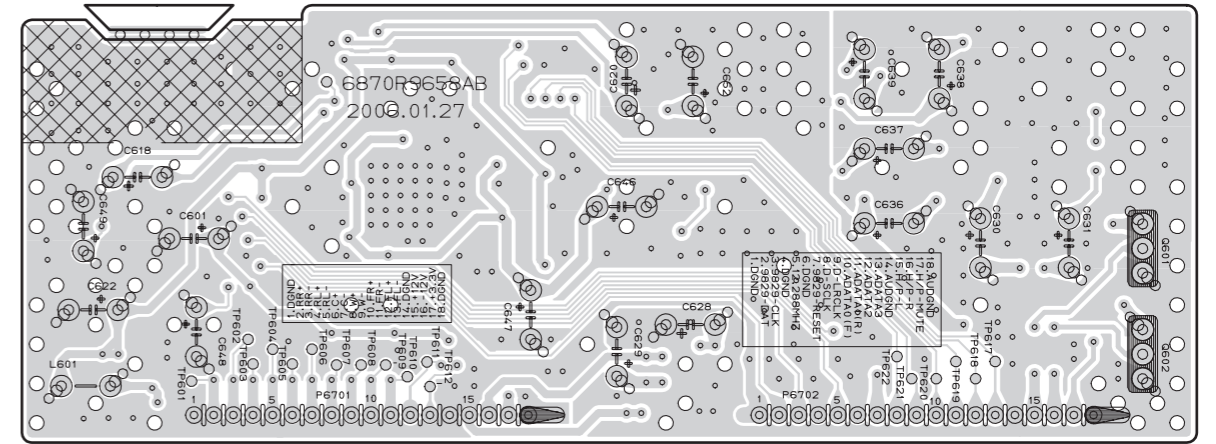

**2. AMP P.C. BOARD DIAGRAM_300W (LH-T36's)
(TOP VIEW)**

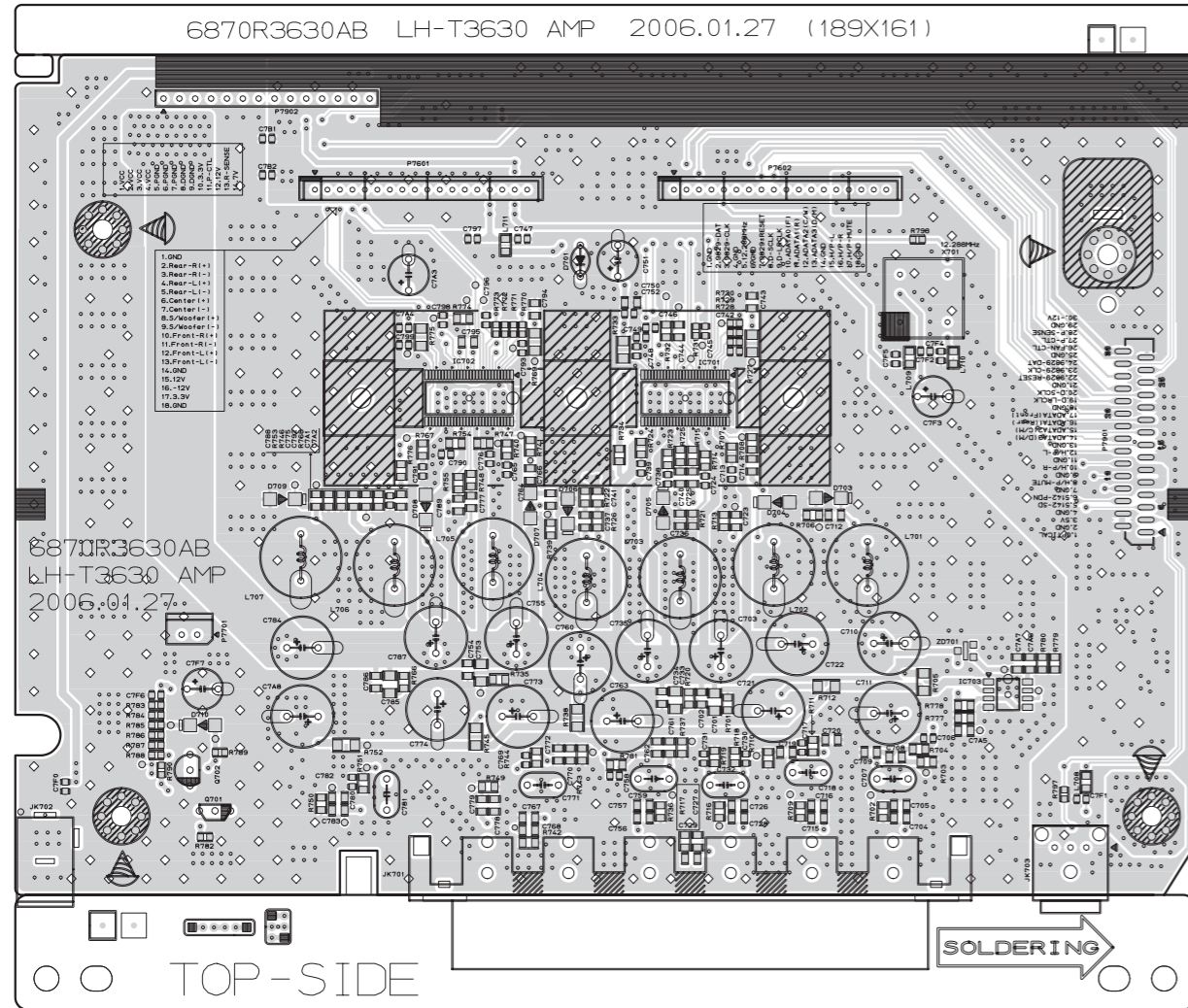

(BOTTOM VIEW)

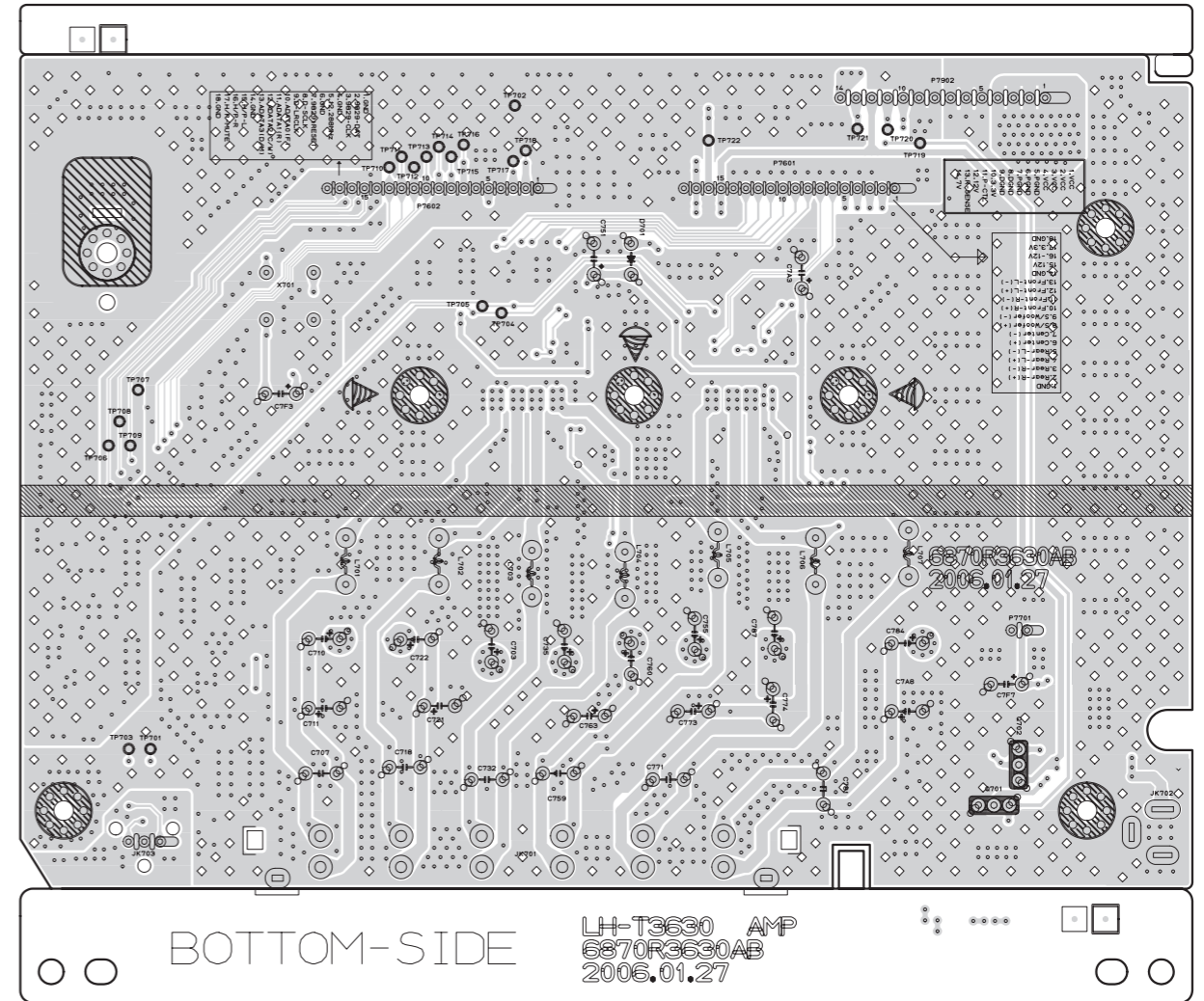

SECTION 4. EXPLODED VIEWS

• CABINET AND MAIN FRAME SECTION_LH-TK36's

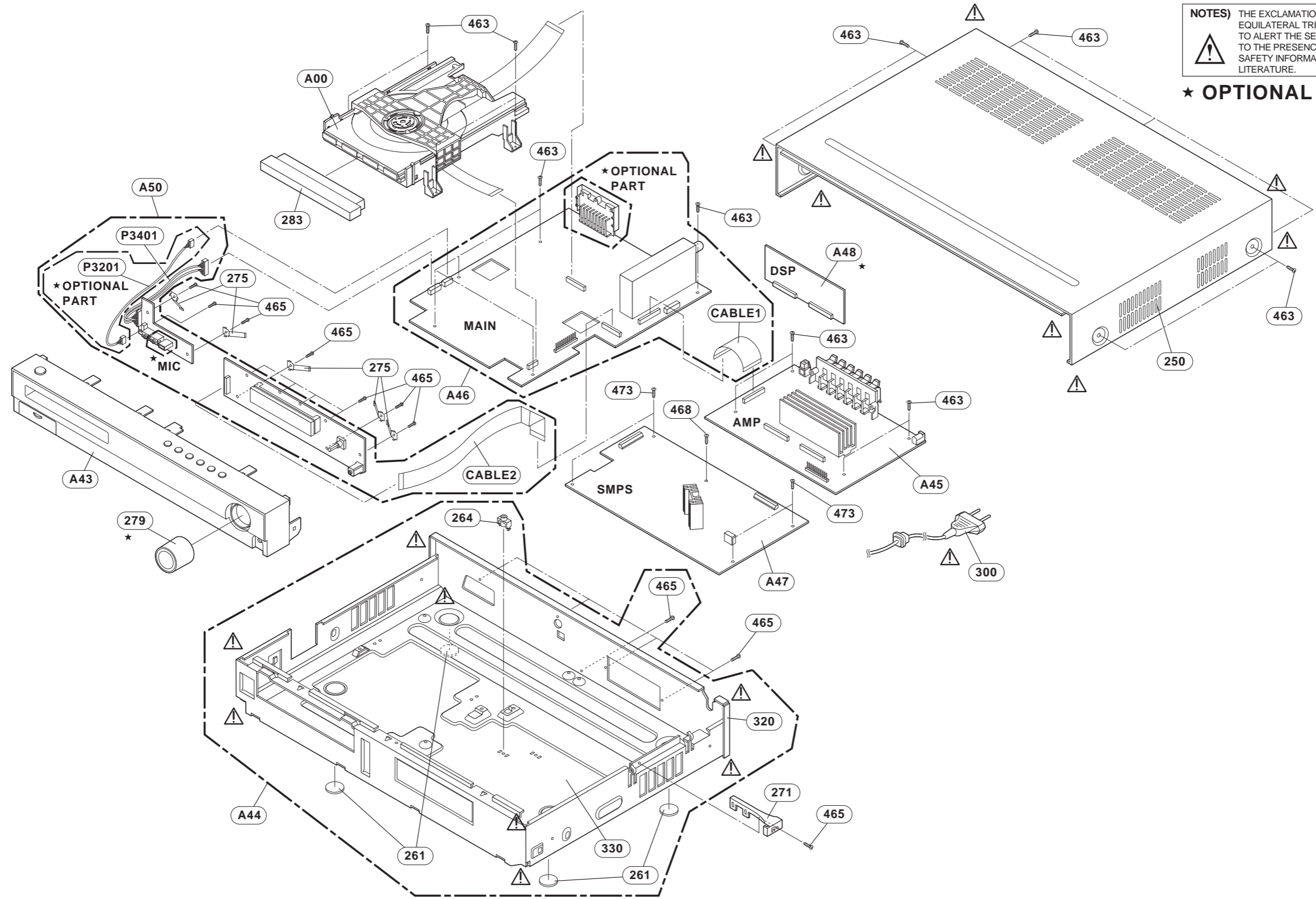

NOTES) THE EXCLAMATION POINT WITHIN AN EQUILATERAL TRIANGLE IS INTENDED TO ALERT THE SERVICE PERSONNEL TO THE PRESENCE OF IMPORTANT SAFETY INFORMATION IN SERVICE LITERATURE.

★ OPTIONAL PART

• DECK MECHANISM EXPLODED VIEW(DP-10T)

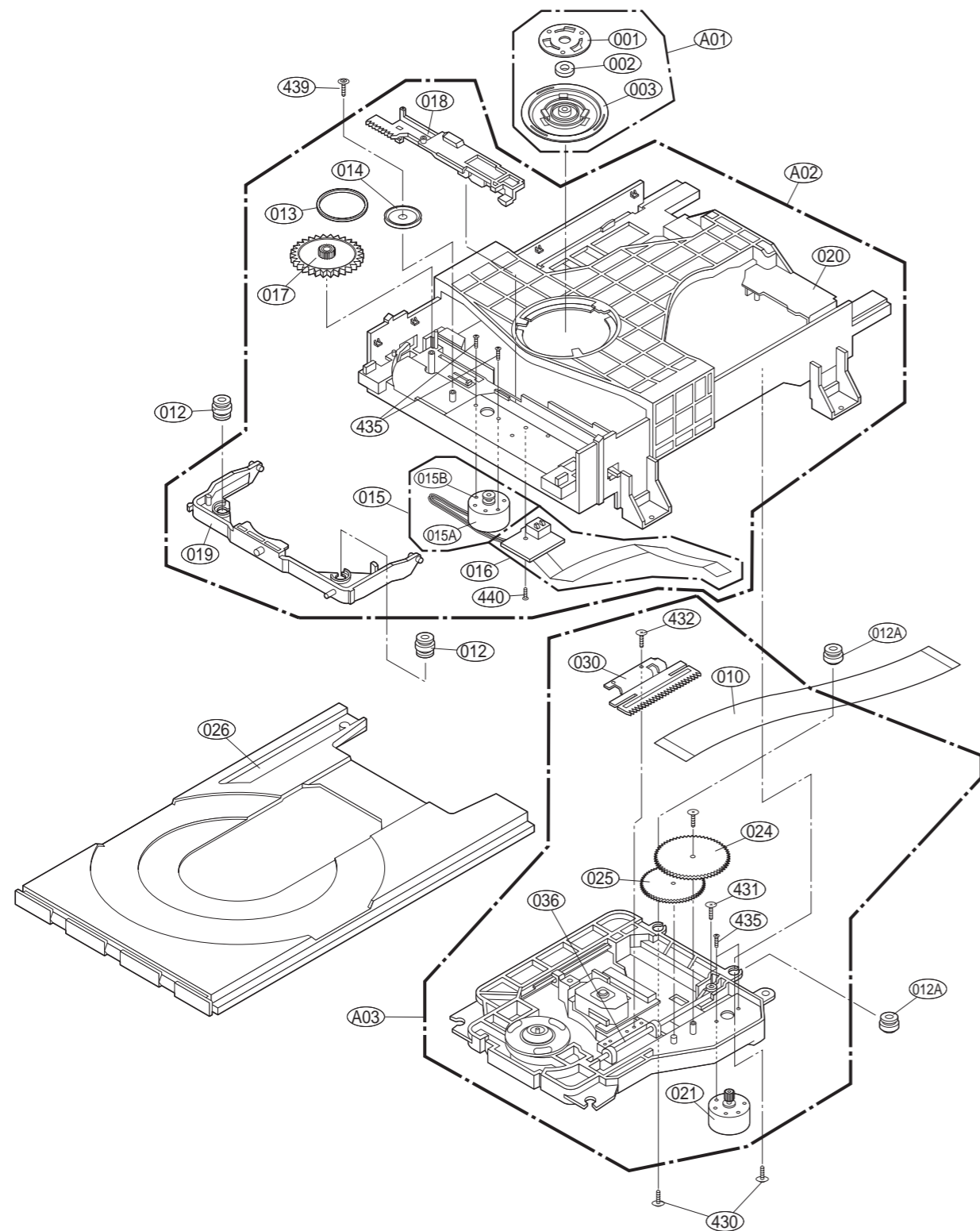

• Packing Accessory Section

★ OPTIONAL PART

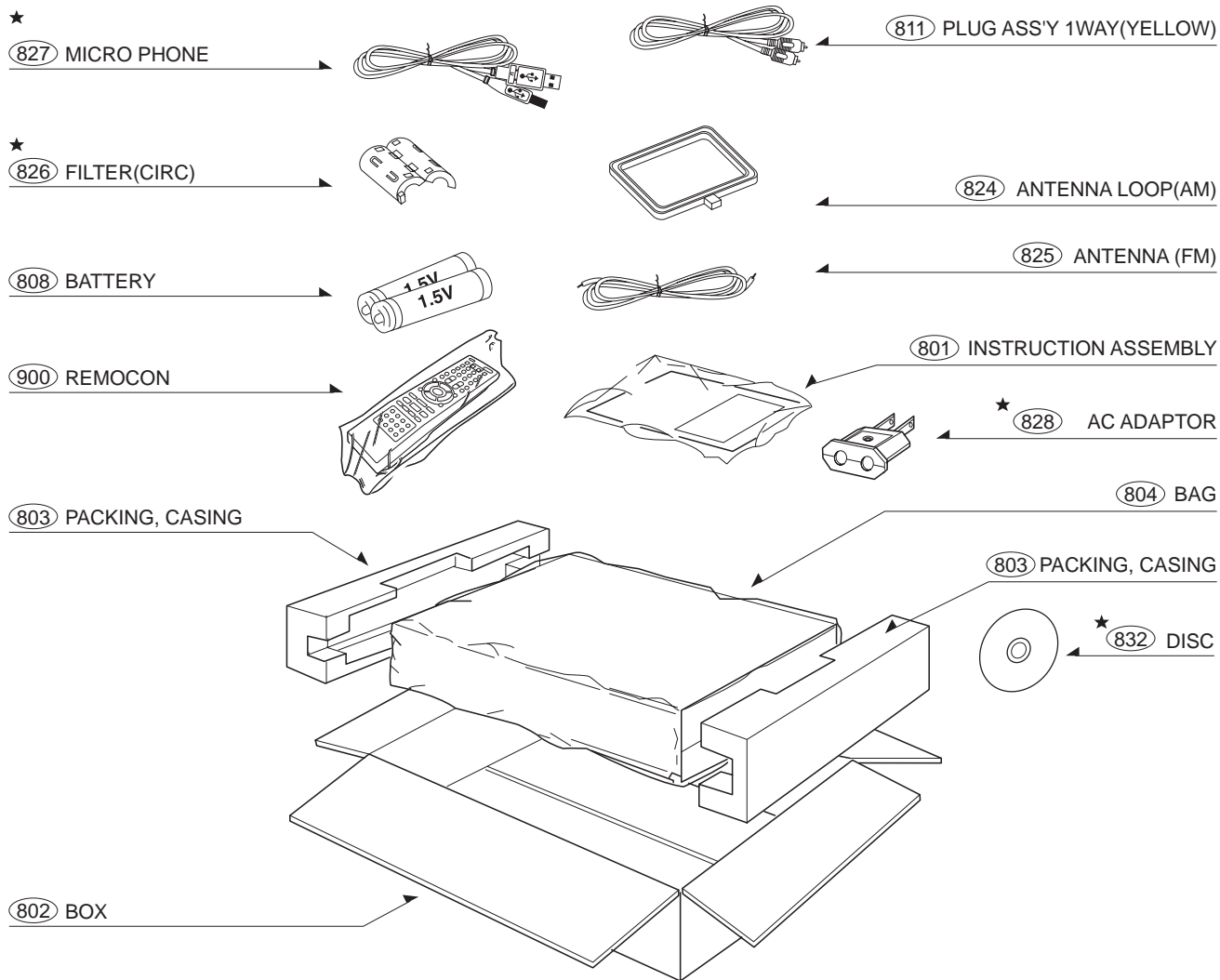

MEMO

A series of horizontal dotted lines for writing.

SECTION 5. SPEAKER SECTION

1. LHS-36SE

- FRONT/REAR/CENTER SPEAKER(LHS-36SES)

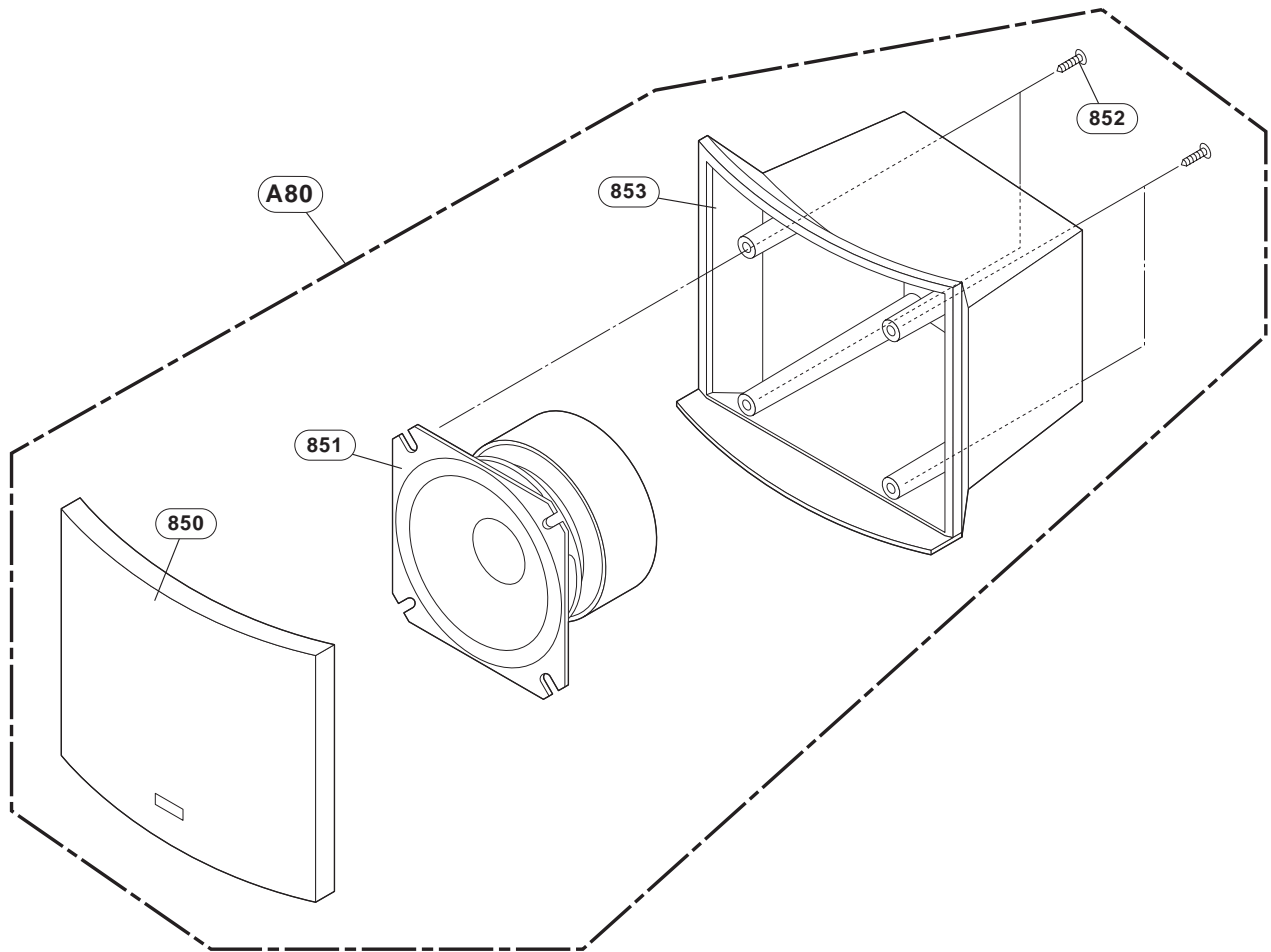

• PASSIVE SUBWOOFER SPEAKER(LHS-36SEW)

