



SERVICE MANUAL

MODELS : LH-T550SB, LH-T551SB, LH-T553SB LHS-55SBC, LHS-55SBS, LHS-55SBW

LG Electronics Inc.



DVD/CD RECEIVER

SERVICE MANUAL

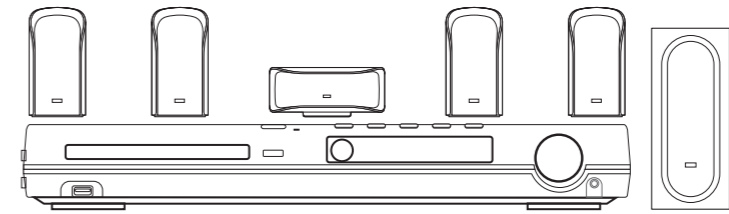

**MODELS : LH-T550SB, LH-T551SB, LH-T553SB
LHS-55SBC, LHS-55SBS,
LHS-55SBW**

[CONTENTS]

SECTION 1. GENERAL

- SERVICING PRECAUTIONS 1-2
- ESD PRECAUTIONS 1-4
- SPECIFICATIONS 1-5

SECTION 2. AUDIO PART

- AUDIO TROUBLESHOOTING GUIDE 2-1
- WIRING DIAGRAM 2-4
- BLOCK DIAGRAM 2-6
- SCHEMATIC DIAGRAMS 2-8
- PRINTED CIRCUIT DIAGRAMS 2-22

SECTION 3. DVD & AMP PART

- ELECTRICAL TROUBLESHOOTING GUIDE 3-1
- DVD PART SCHEMATIC DIAGRAMS 3-22

SECTION 4. EXPLODED VIEWS 4-1

SECTION 5. SPEAKER PART 5-1

SECTION 6. REPLACEMENT PARTS LIST 6-1

SECTION 1. GENERAL

SERVICING PRECAUTIONS

NOTES REGARDING HANDLING OF THE PICK-UP

1. Notes for transport and storage

- 1) The pick-up should always be left in its conductive bag until immediately prior to use.
- 2) The pick-up should never be subjected to external pressure or impact.

Storage in conductive bag

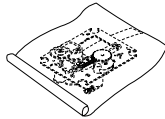

Drop impact

2. Repair notes

- 1) The pick-up incorporates a strong magnet, and so should never be brought close to magnetic materials.
- 2) The pick-up should always be handled correctly and carefully, taking care to avoid external pressure and impact. If it is subjected to strong pressure or impact, the result may be an operational malfunction and/or damage to the printed-circuit board.
- 3) Each and every pick-up is already individually adjusted to a high degree of precision, and for that reason the adjustment point and installation screws should absolutely never be touched.
- 4) Laser beams may damage the eyes!
Absolutely never permit laser beams to enter the eyes!
Also NEVER switch ON the power to the laser output part (lens, etc.) of the pick-up if it is damaged.



NEVER look directly at the laser beam, and don't let contact fingers or other exposed skin.

5) Cleaning the lens surface

If there is dust on the lens surface, the dust should be cleaned away by using an air bush (such as used for camera lens). The lens is held by a delicate spring. When cleaning the lens surface, therefore, a cotton swab should be used, taking care not to distort this.

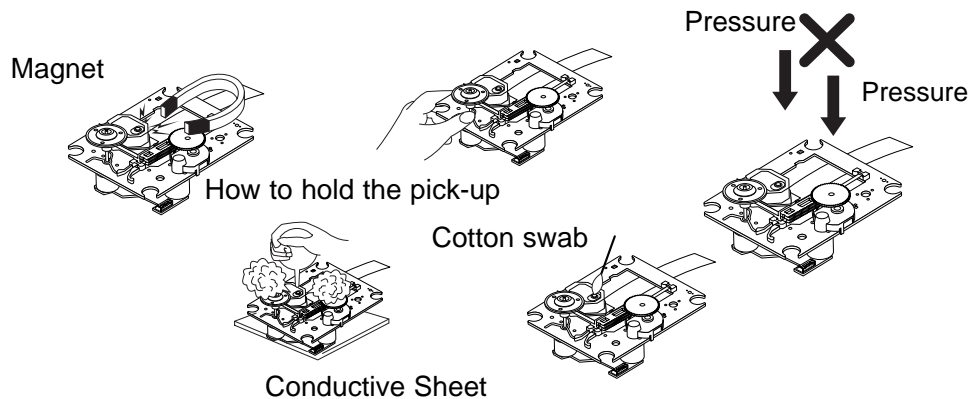

6) Never attempt to disassemble the pick-up.

Spring by excess pressure. If the lens is extremely dirty, apply isopropyl alcohol to the cotton swab. (Do not use any other liquid cleaners, because they will damage the lens.) Take care not to use too much of this alcohol on the swab, and do not allow the alcohol to get inside the pick-up.

NOTES REGARDING COMPACT DISC PLAYER REPAIRS

1. Preparations

- 1) Compact disc players incorporate a great many ICs as well as the pick-up (laser diode). These components are sensitive to, and easily affected by, static electricity. If such static electricity is high voltage, components can be damaged, and for that reason components should be handled with care.
- 2) The pick-up is composed of many optical components and other high-precision components. Care must be taken, therefore, to avoid repair or storage where the temperature or humidity is high, where strong magnetism is present, or where there is excessive dust.

2. Notes for repair

- 1) Before replacing a component part, first disconnect the power supply lead wire from the unit
- 2) All equipment, measuring instruments and tools must be grounded.
- 3) The workbench should be covered with a conductive sheet and grounded.
When removing the laser pick-up from its conductive bag, do not place the pick-up on the bag. (This is because there is the possibility of damage by static electricity.)
- 4) To prevent AC leakage, the metal part of the soldering iron should be grounded.
- 5) Workers should be grounded by an armband (1M Ω)
- 6) Care should be taken not to permit the laser pick-up to come in contact with clothing, in order to prevent static electricity changes in the clothing to escape from the armband.
- 7) The laser beam from the pick-up should NEVER be directly facing the eyes or bare skin.

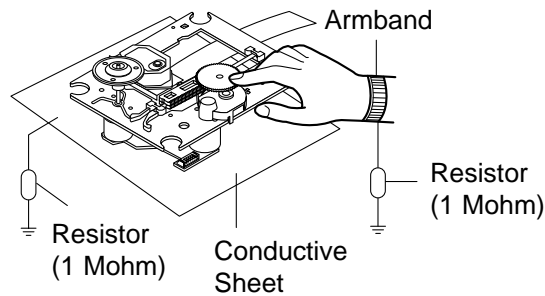

ESD PRECAUTIONS

Electrostatically Sensitive Devices (ESD)



Some semiconductor (solid state) devices can be damaged easily by static electricity. Such components commonly are called Electrostatically Sensitive Devices (ESD). Examples of typical ESD devices are integrated circuits and some field-effect transistors and semiconductor chip components. The following techniques should be used to help reduce the incidence of component damage caused by static electricity.

1. Immediately before handling any semiconductor component or semiconductor-equipped assembly, drain off any electrostatic charge on your body by touching a known earth ground. Alternatively, obtain and wear a commercially available discharging wrist strap device, which should be removed for potential shock reasons prior to applying power to the unit under test.
2. After removing an electrical assembly equipped with ESD devices, place the assembly on a conductive surface such as aluminum foil, to prevent electrostatic charge buildup or exposure of the assembly.
3. Use only a grounded-tip soldering iron to solder or unsolder ESD devices.
4. Use only an anti-static solder removal device. Some solder removal devices not classified as "anti-static" can generate electrical charges sufficient to damage ESD devices.
5. Do not use freon-propelled chemicals. These can generate electrical charges sufficient to damage ESD devices.
6. Do not remove a replacement ESD device from its protective package until immediately before you are ready to install it. (Most replacement ESD devices are packaged with leads electrically shorted together by conductive foam, aluminum foil or comparable conductive materials).
7. Immediately before removing the protective material from the leads of a replacement ESD device, touch the protective material to the chassis or circuit assembly into which the device will be installed.

CAUTION : BE SURE NO POWER IS APPLIED TO THE CHASSIS OR CIRCUIT, AND OBSERVE ALL OTHER SAFETY PRECAUTIONS.

8. Minimize bodily motions when handling unpackaged replacement ESD devices. (Otherwise harmless motion such as the brushing together of your clothes fabric or the lifting of your foot from a carpeted floor can generate static electricity sufficient to damage an ESD device).

CAUTION. GRAPHIC SYMBOLS

	THE LIGHTNING FLASH WITH APOWHEAD SYMBOL. WITHIN AN EQUILATERAL TRIANGLE, IS INTENDED TO ALERT THE SERVICE PERSONNEL TO THE PRESENCE OF UNINSULATED "DANGEROUS VOLTAGE" THAT MAY BE OF SUFFICIENT MAGNITUDE TO CONSTITUTE A RISK OF ELECTRIC SHOCK.
	THE EXCLAMATION POINT WITHIN AN EQUILATERAL TRIANGLE IS INTENDED TO ALERT THE SERVICE PERSONNEL TO THE PRESENCE OF IMPORTANT SAFETY INFORMATION IN SERVICE LITERATURE.

SPECIFICATIONS

GENERAL

Power supply	Refer to main label
Power consumption	Refer to main label
Weight	3.9 kg
External dimensions (W x H x D)	430 x 54 x 350 mm
Operating conditions Temperature:	5°C to 35°C, Operation status: Horizontal
Operating humidity	5% to 85%

CD/DVD

Laser	Semiconductor laser, wavelength 650 nm
Signal system	PAL 625/50, NTSC 525/60
Frequency response (audio)	200 Hz to 20 kHz
Signal-to-noise ratio (audio)	More than 75 dB (1 kHz, NOP, 20 kHz LPF/A-Filter)
Dynamic range (audio)	More than 70 dB
Harmonic distortion (audio)	0.5 % (1 kHz, at 12W position) (20 kHz LPF/A-Filter)

VIDEO

Video input	1.0 V (p-p), 75 Ω, negative sync., RCA jack x 1
Video output	1.0 V (p-p), 75 Ω, negative sync., RCA jack x 1
S-video output	(Y) 1.0 V (p-p), 75 Ω, negative sync., Mini DIN 4-pin x 1 (C) 0.3 V (p-p), 75 Ω
Component Video output	(Y) 1.0 V (p-p), 75 Ω, negative sync., RCA jack x 1 (Pb)/(Pr) 0.7 V (p-p), 75 Ω, RCA jack x 1

TUNER

FM

Tuning Range	87.5 - 108.0 MHz or 65.0 - 74.0 MHz, 87.5 - 108.0 MHz
Intermediate Frequency	10.7 MHz
Signal-to Noise Ratio	60 dB (Mono)
Frequency Response	140 - 10,000 Hz

AM [MW]

Tuning Range	522 - 1,620 kHz or 520 - 1,720 kHz
Intermediate Frequency	450 kHz

AMPLIFIER

Stereo mode	70W + 70W (8Ω at 1 kHz, THD 10 %)
Surround mode	Front: 70W + 70W (THD 10 %) Center*: 70W
(* Depending on the sound mode settings and the source, there may be no sound output.)	Surround*: 70W + 70W (8Ω at 1 kHz, THD 10 %) Subwoofer*: 150W (4Ω at 30 Hz, THD 10 %)
Input	AV IN
Outputs	S-VIDEO, MONITOR, PHONES: (32 Ω, 10.V)

SPEAKERS

	Front Speaker	Center Speaker	Subwoofer
Type	1 Way 1 Speaker	1 Way 1 Speaker	1 Way 1 Speaker
Impedance	8 Ω	8 Ω	4 Ω
Frequency Response	110 - 20,000 Hz	110 - 20,000 Hz	40 - 1,500 Hz
Sound Pressure Level	82 dB/W (1m)	82 dB/W (1m)	82 dB/W (1m)
Rated Input Power	70W	70W	150W
Max. Input Power	140W	140W	300W
Net Dimensions	140x222x153 mm	300x116x91 mm	195x402x360 mm
Net Weight	0.95 kg	1.0 kg	5.6 kg

SECTION 2. AUDIO PART

AUDIO TROUBLESHOOTING GUIDE

1. POWER SUPPLY CIRCUIT

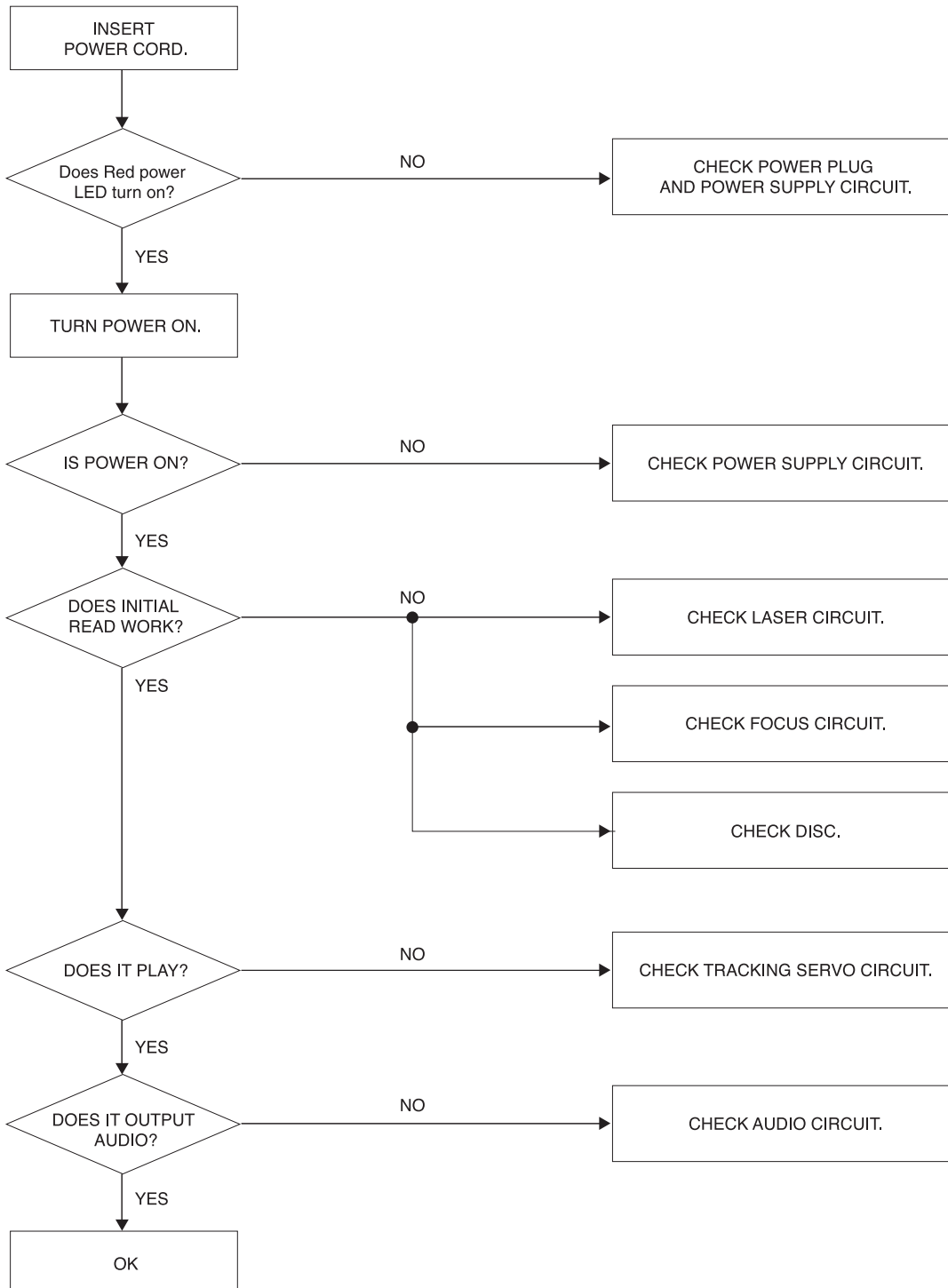

2. FRONT CIRCUIT (1/2)

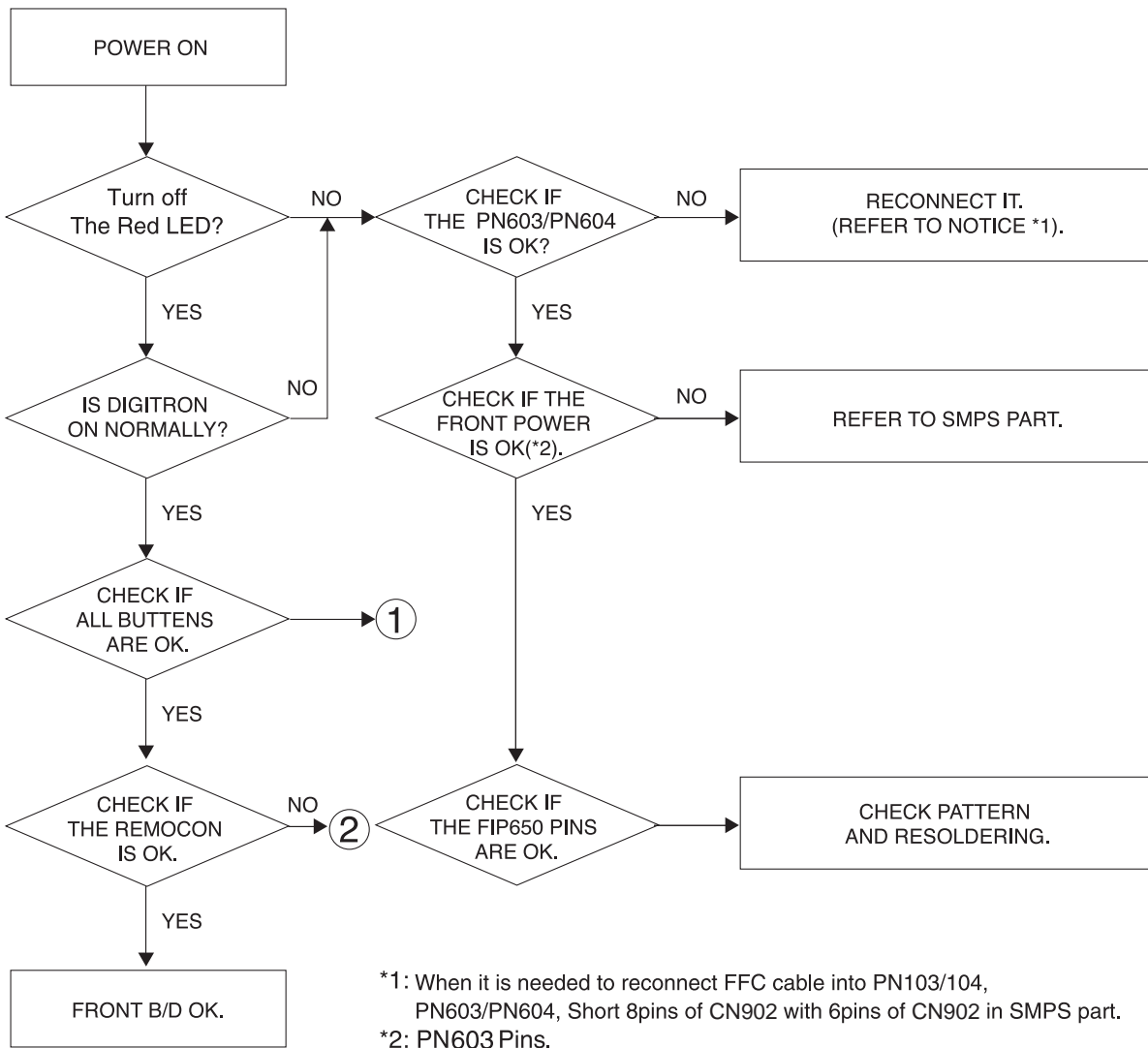

*1: When it is needed to reconnect FFC cable into PN103/104, PN603/PN604, Short 8pins of CN902 with 6pins of CN902 in SMPS part.

*2: PN603 Pins.

PIN1 : -32.4 VKK

PIN3 : -27.5 FL-

PIN4 : -23.7 FL+

PIN9 : +5.0

3. FRONT CIRCUIT (2/2)

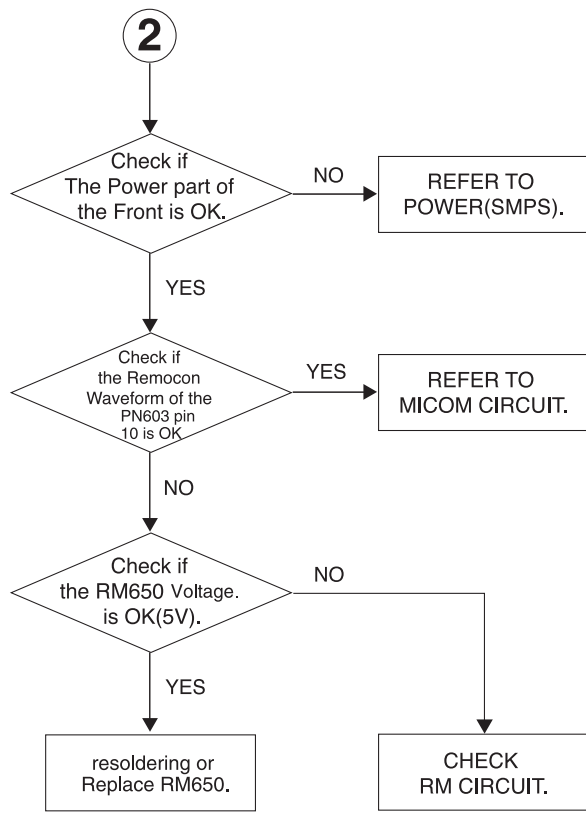
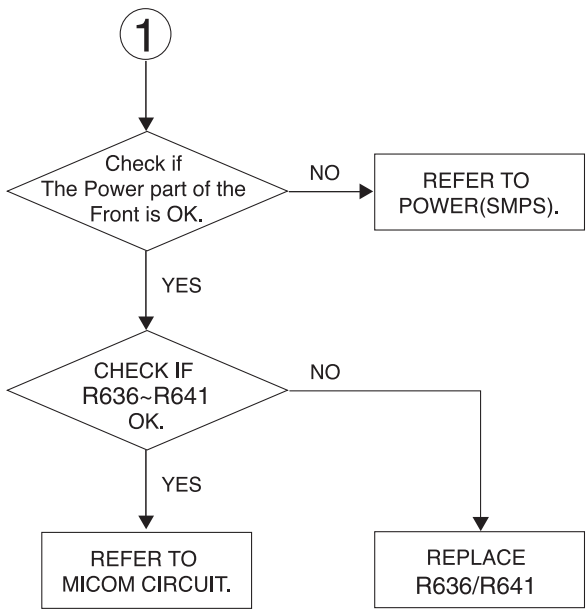

WIRING DIAGRAM

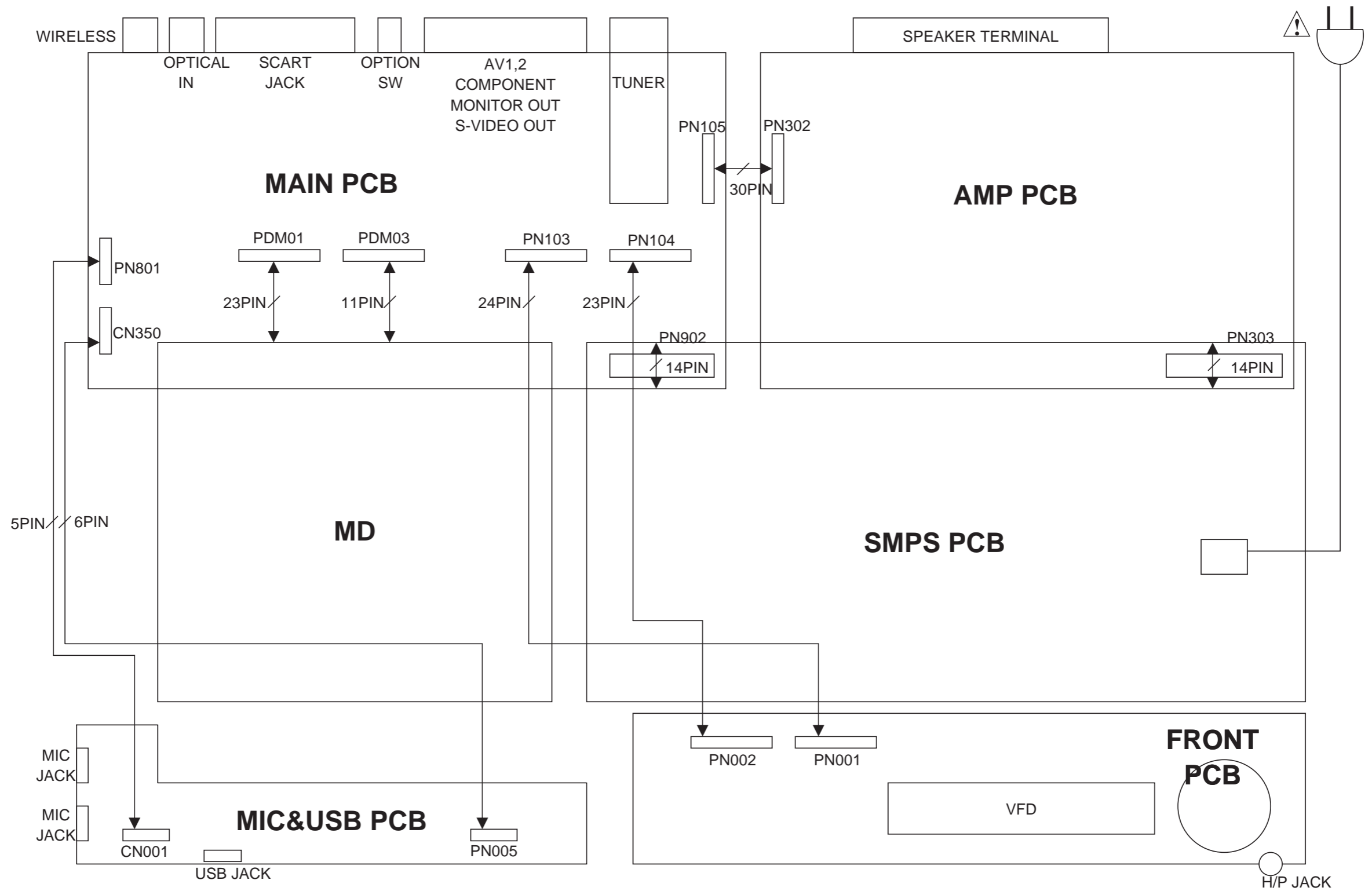

BLOCK DIAGRAM

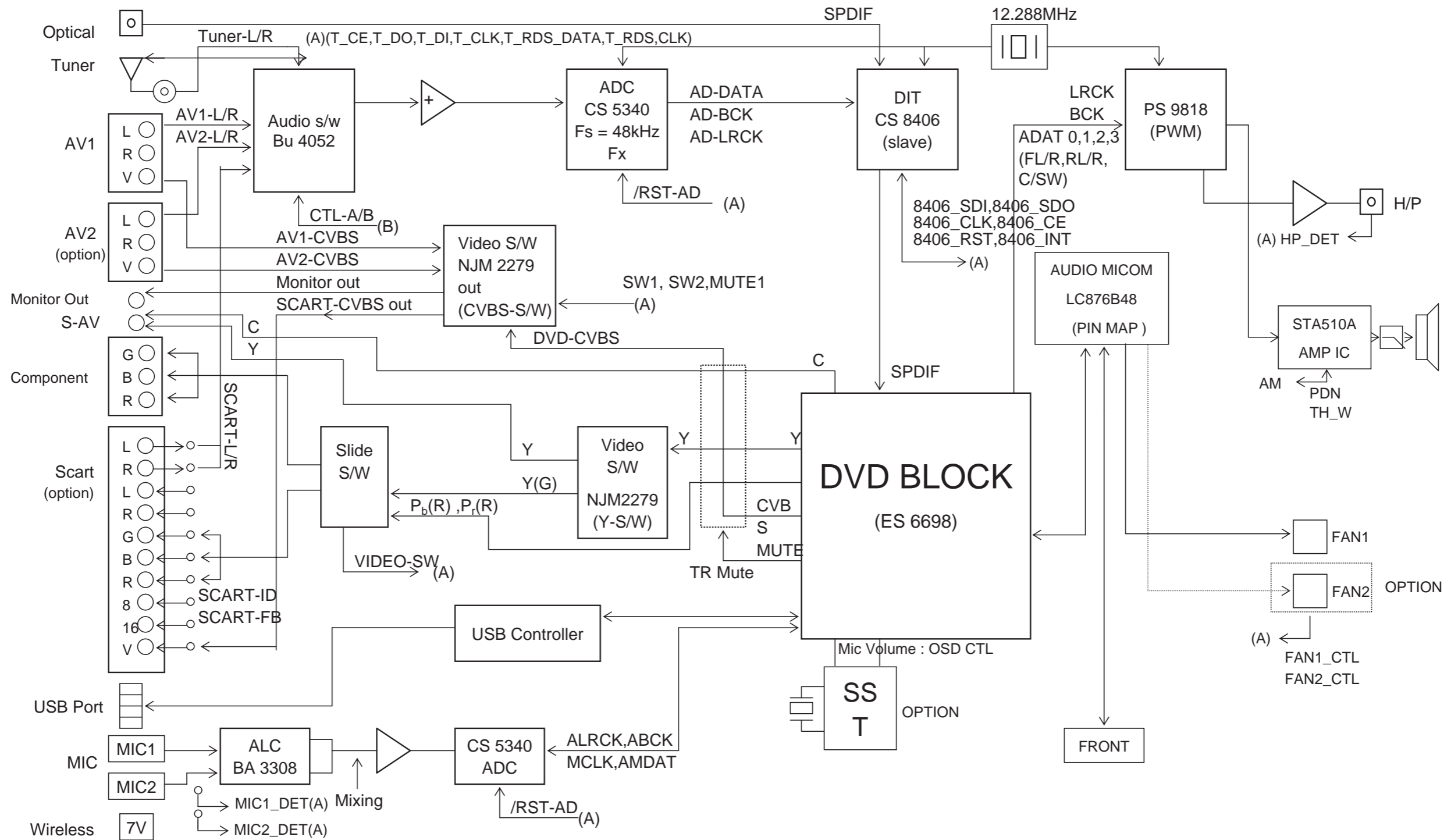

SCHEMATIC DIAGRAMS

1. POWER SCHEMATIC DIAGRAM_1

NOTES) ⚠ Warning
Parts that are shaded are critical
With respect to risk of fire or
electrical shock.

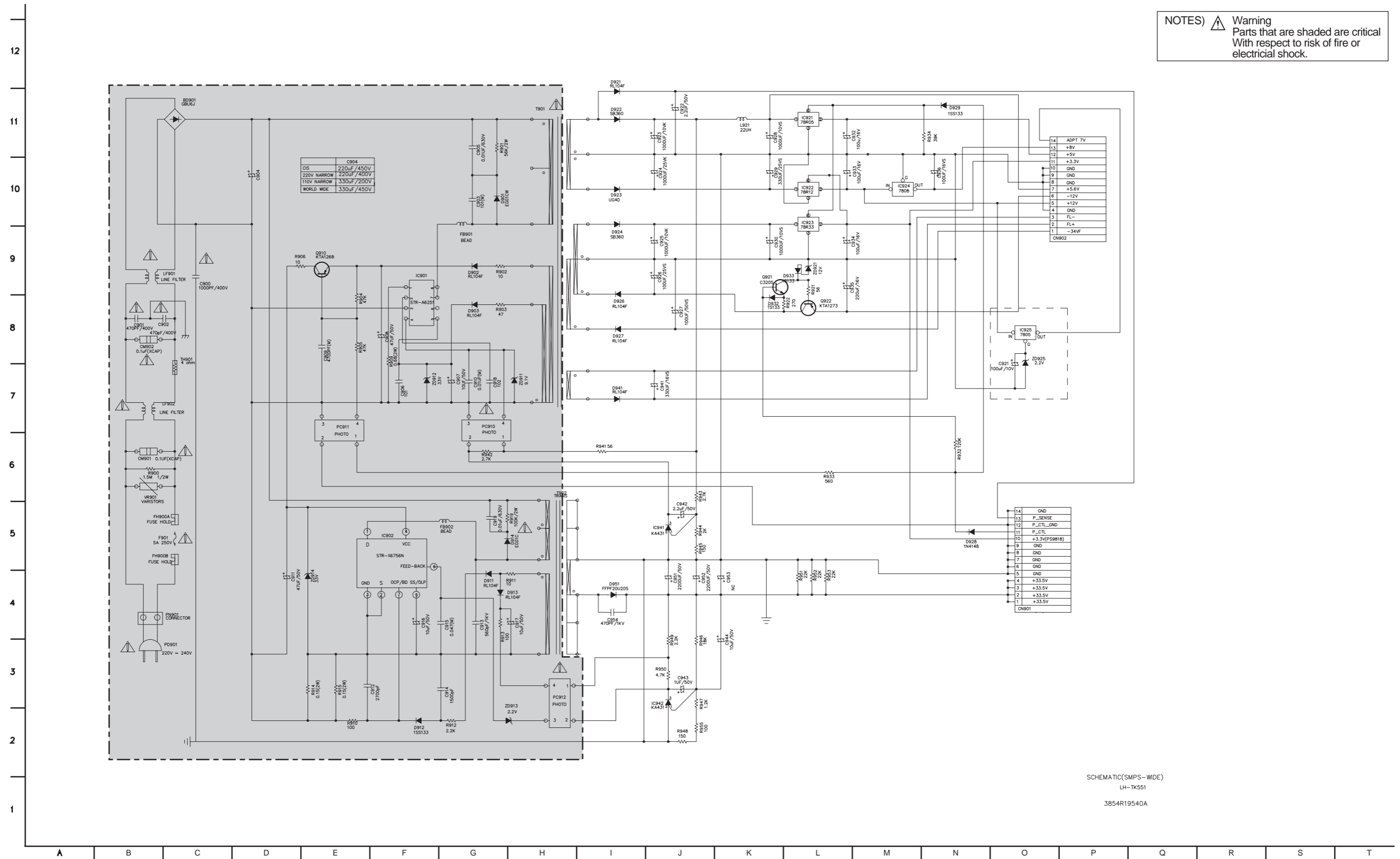

SCHEMATIC(SMPS-WIDE)
LH-TK551
3854R19540A

2. POWER SCHEMATIC DIAGRAM_2

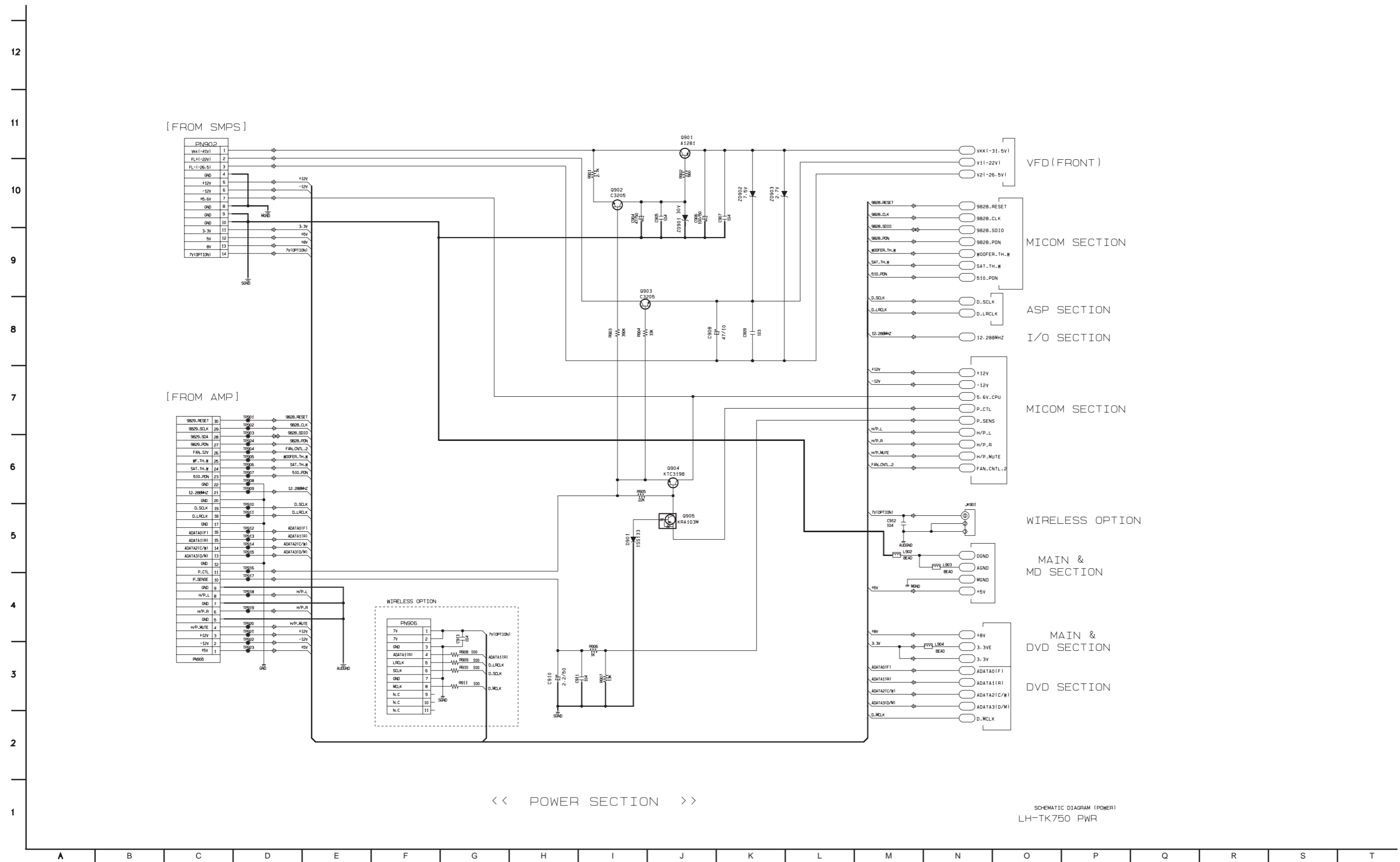

SCHEMATIC DIAGRAM (POWER)
LH-TK750 PWR

3. MICOM SCHEMATIC DIAGRAM

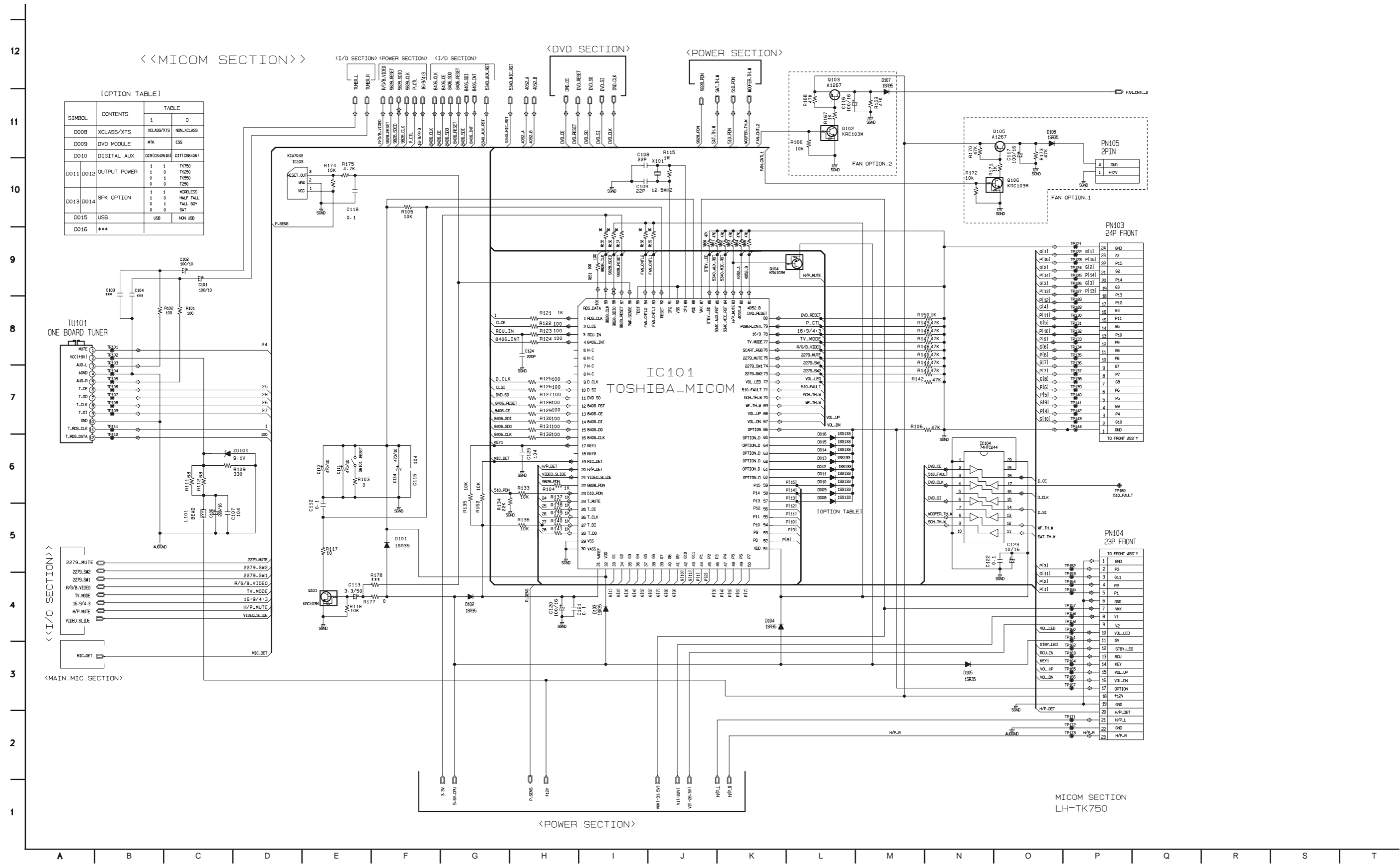

4. FRONT SCHEMATIC DIAGRAM

12
11
10
9
8
7
6
5
4
3
2
1

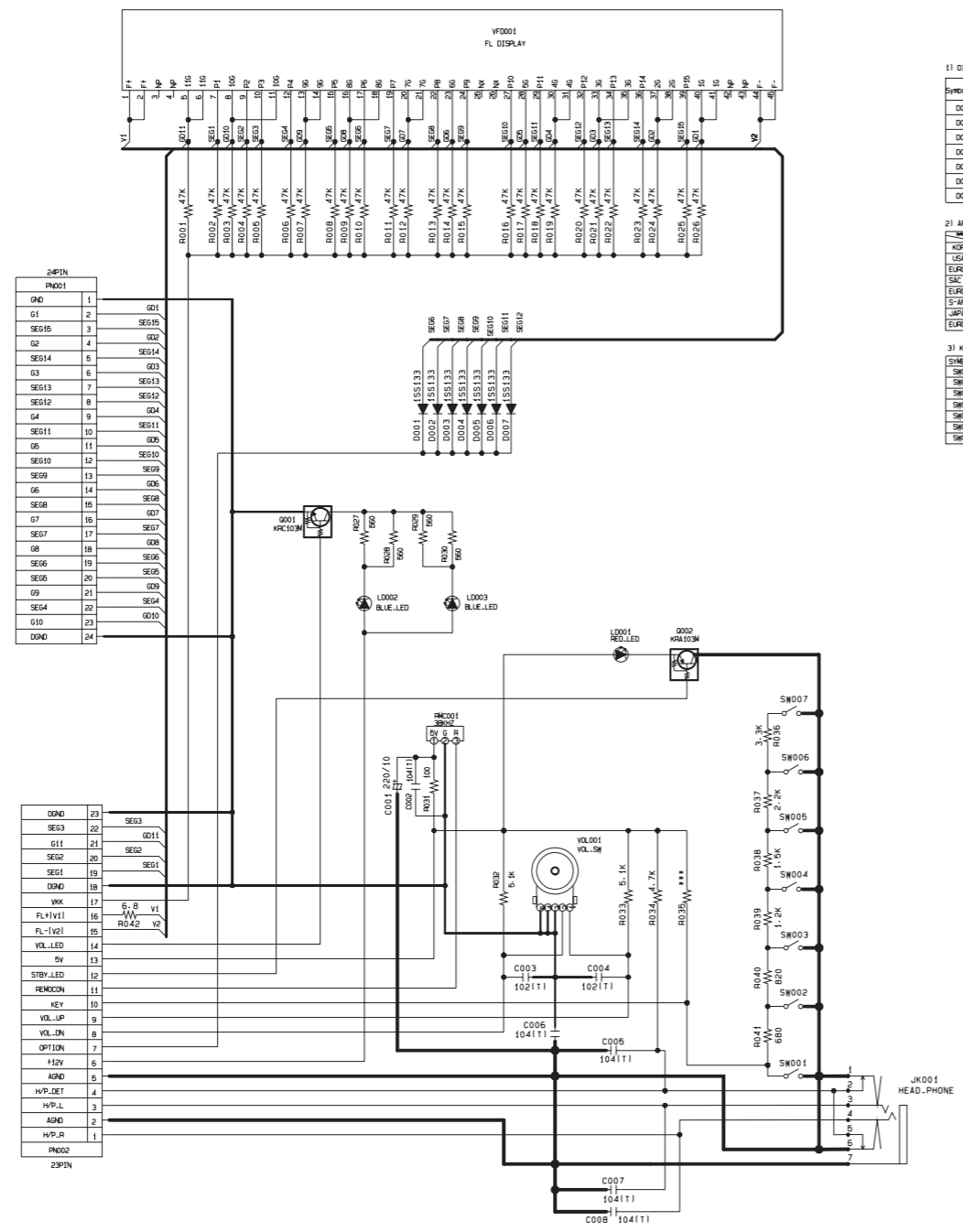

1) DIODE OPTION

SYMBOL NO.	CONTENTS	TABLE
D001	AREA-1	1 0
D002	AREA-2	
D003	AREA-3	REMARK
D004	FM STND	10K 50K
D005	AM STND	10K 5K
D006	RES	NON RES RES
D007	SCART	NON SCART

2) AREA OPTION

AREA	D001	D002	D003
KOR	0	0	0
USA	1	0	0
EUROPE1	0	1	0
SAC	1	1	0
EUROPE2	0	0	1
AFRICA	1	0	1
JAPAN	0	1	1
EUROPE3	1	1	1

3) KEY

SYMBOL NO.	LH-T750
SW001	SKIP/SEARCH/PRESET1
SW002	SKIP/SEARCH/PRESET1
SW003	STOP
SW004	PAUSE/MONO/STEREO
SW005	PLAY
SW006	OPEN/CLOSE
SW007	STAN-BY

SCHEMATIC DIAGRAM(FRONT)
LH-TK750 (FRONT #013)

A B C D E F G H I J K L M N O P Q R S T

5. DSP& SCHEMATIC DIAGRAM

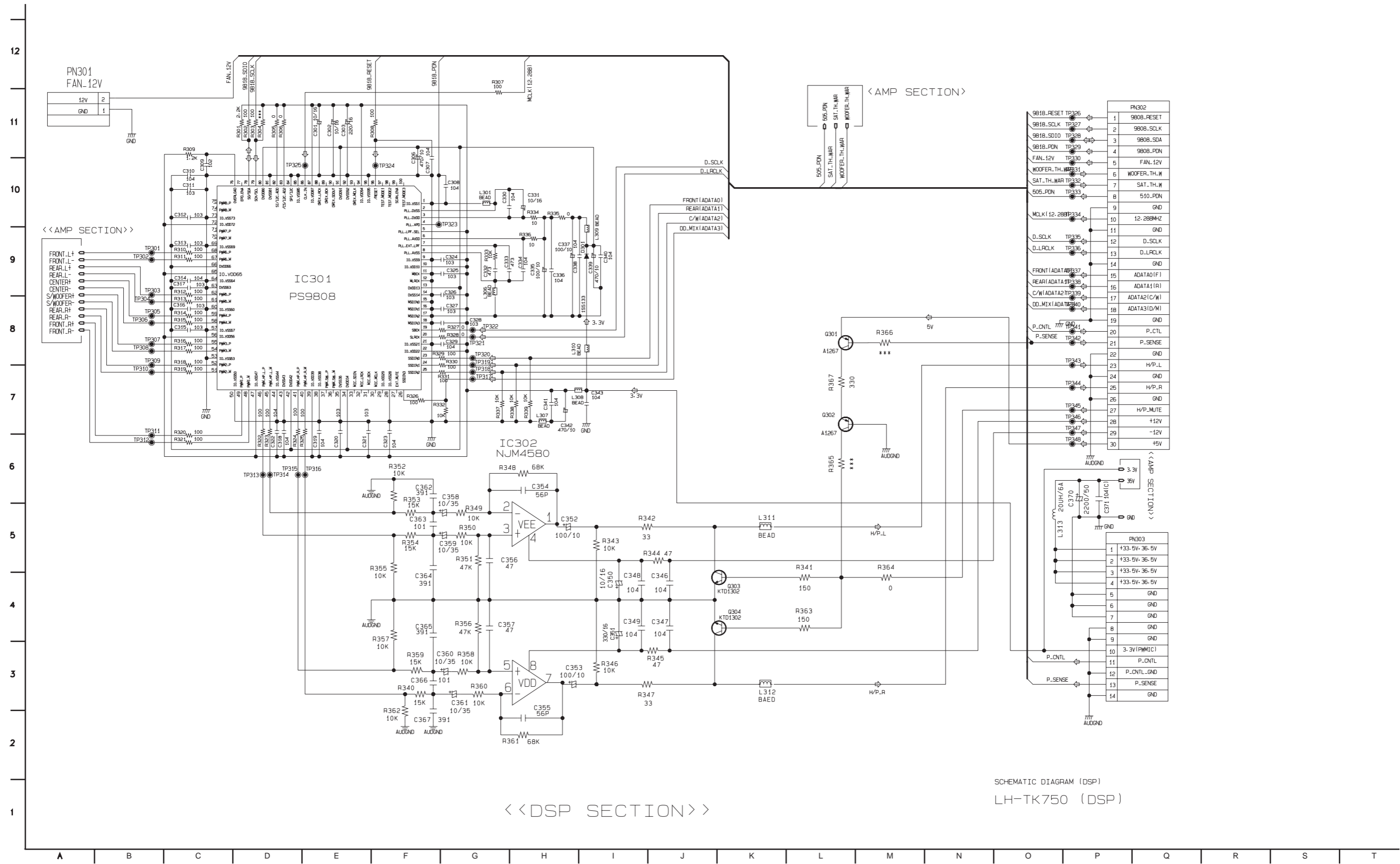

6. I/O SCHEMATIC DIAGRAM

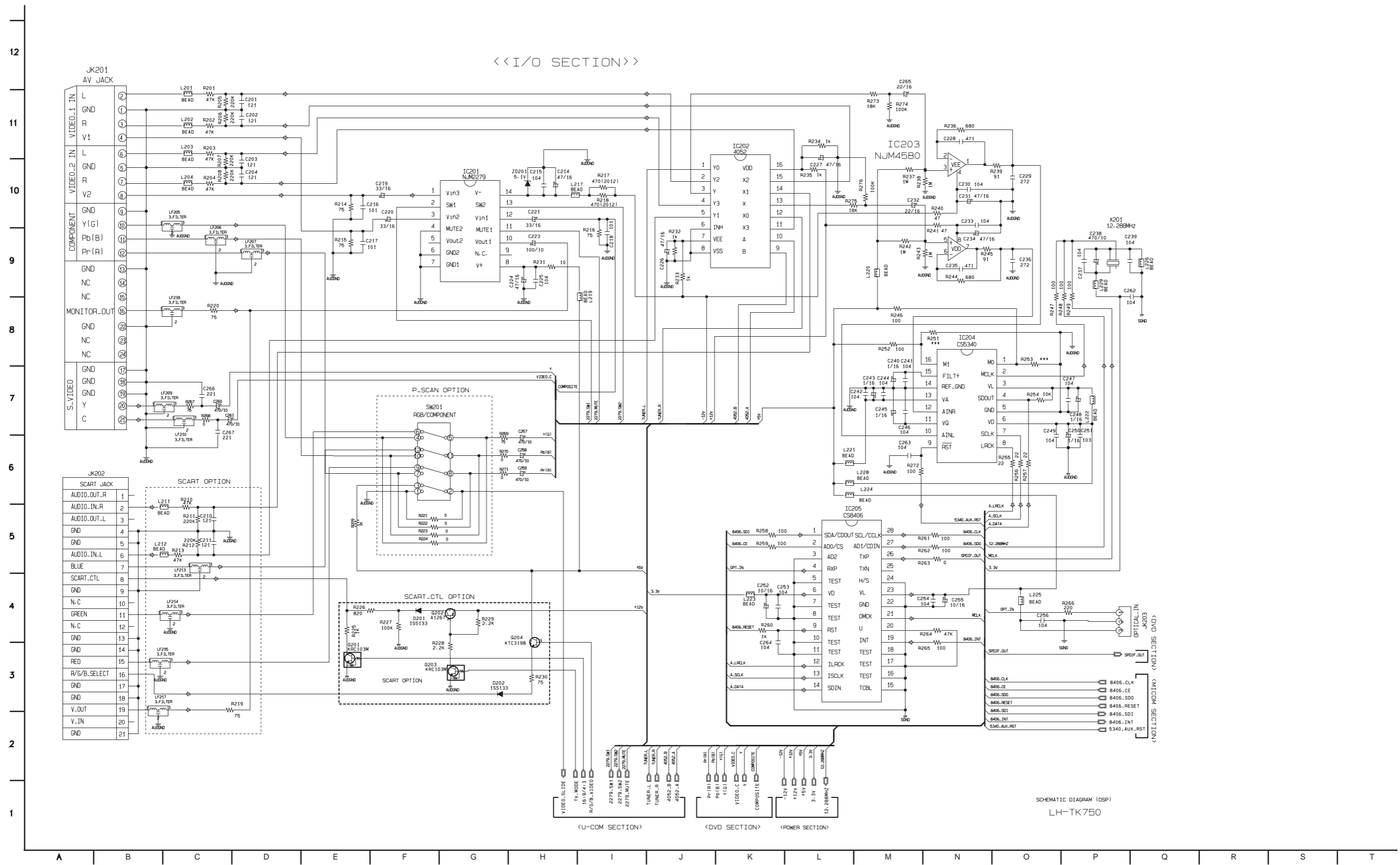

7. MAIN MIC SCHEMATIC DIAGRAM

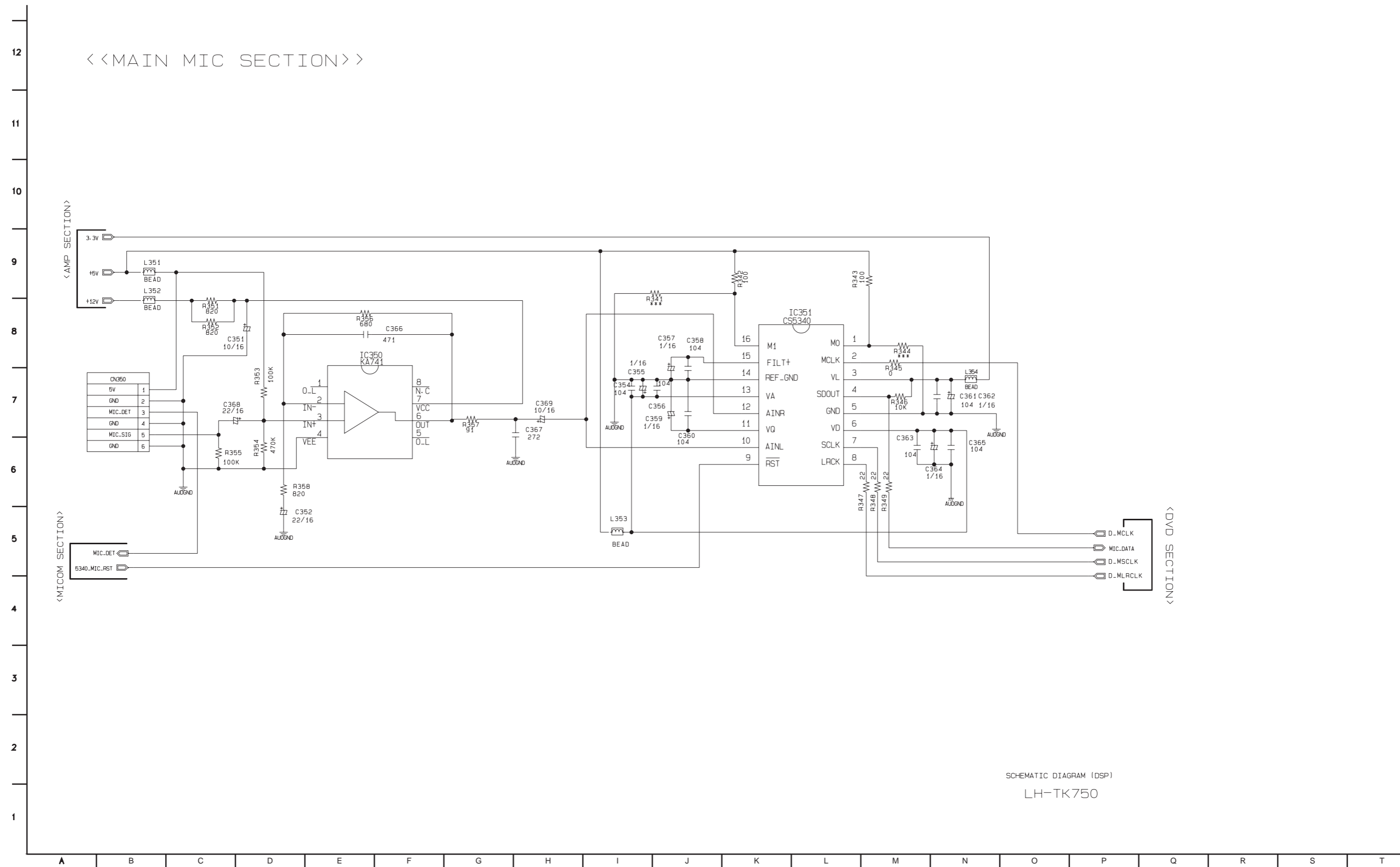

PRINTED CIRCUIT BOARD DIAGRAMS

1. MAIN/DVD P.C. BOARD DIAGRAM (TOP VIEW)

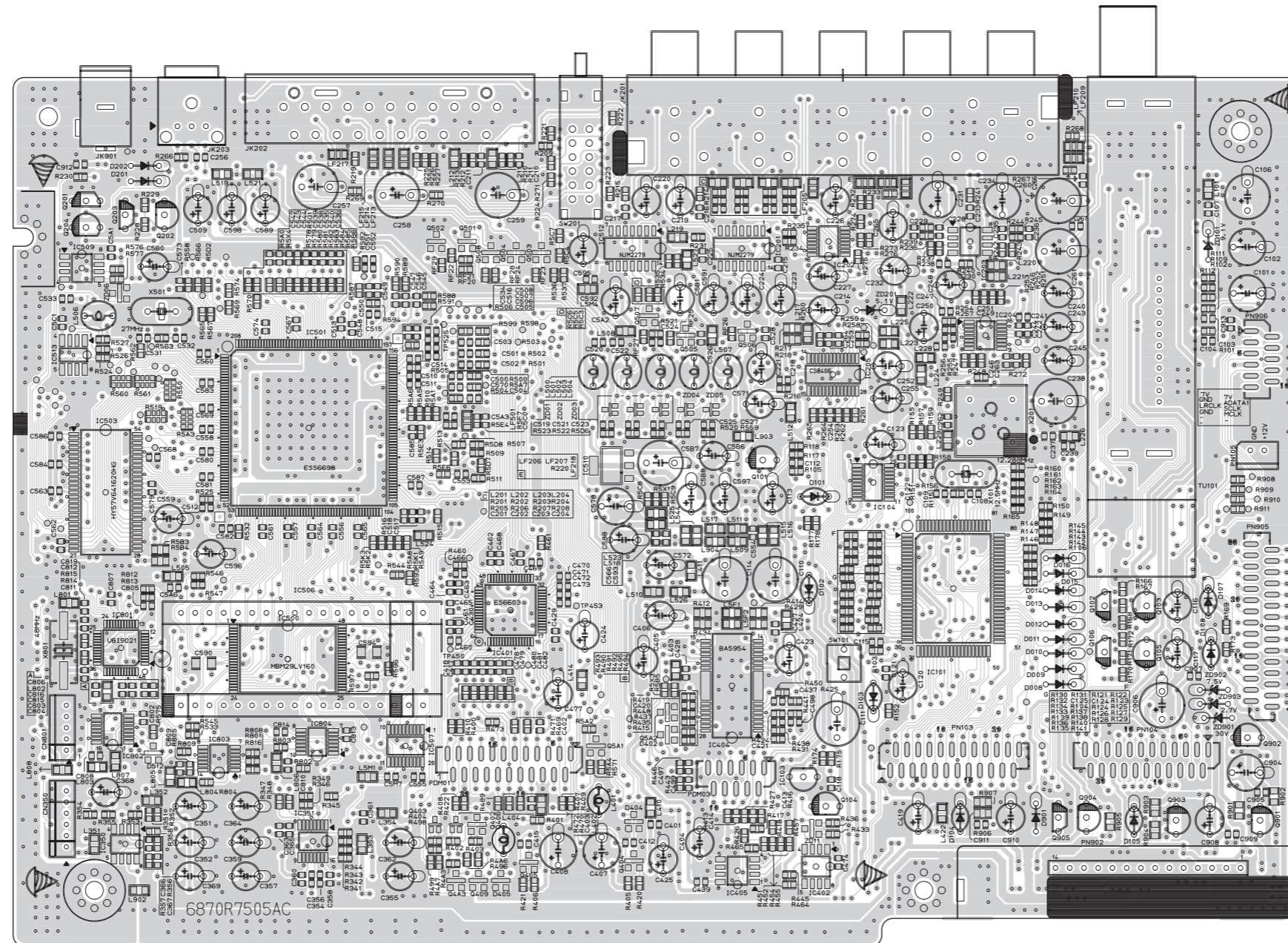

2. MAIN/DVD P.C. BOARD DIAGRAM (BOTTOM VIEW)

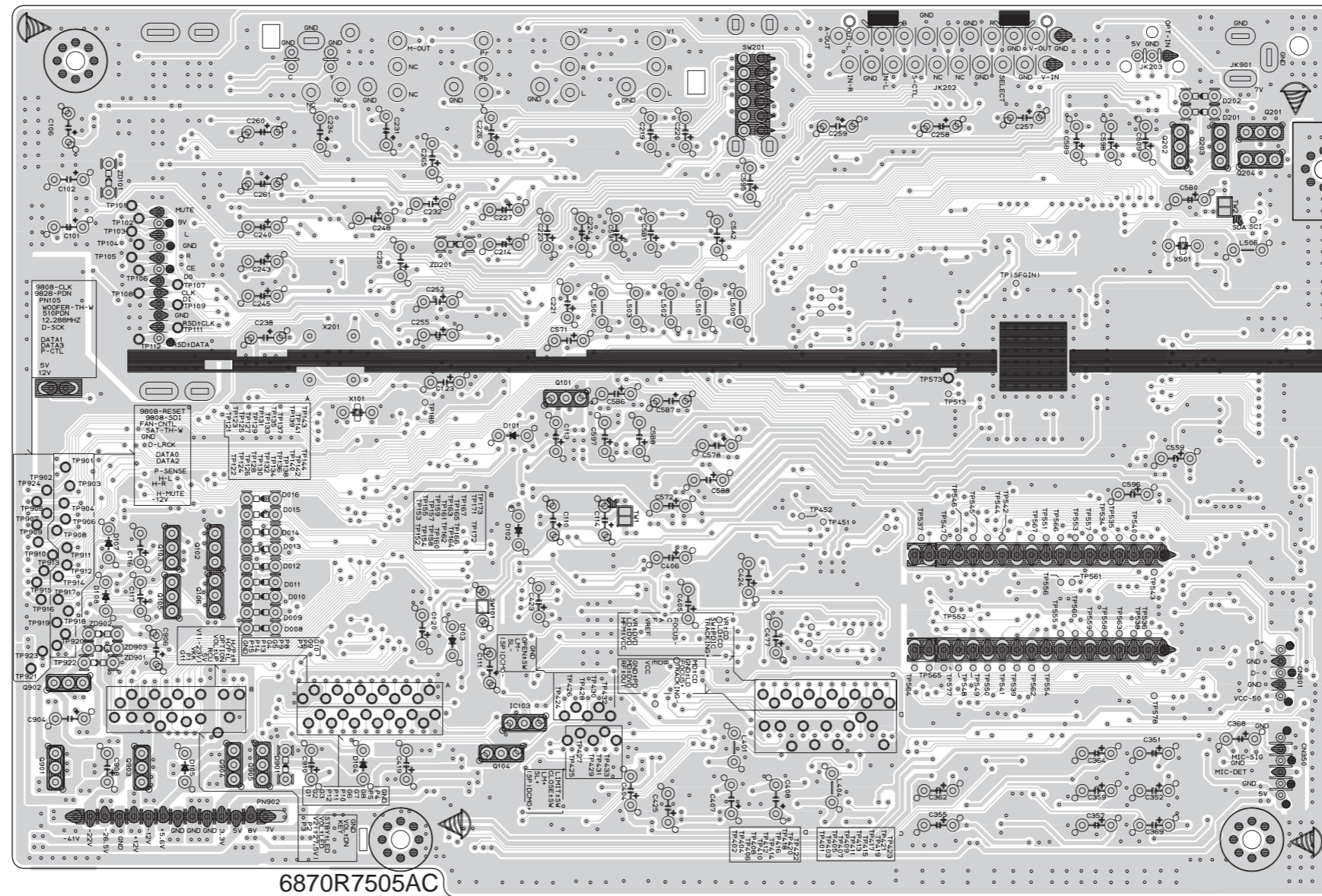

3. FRONT MIC P.C. BOARD

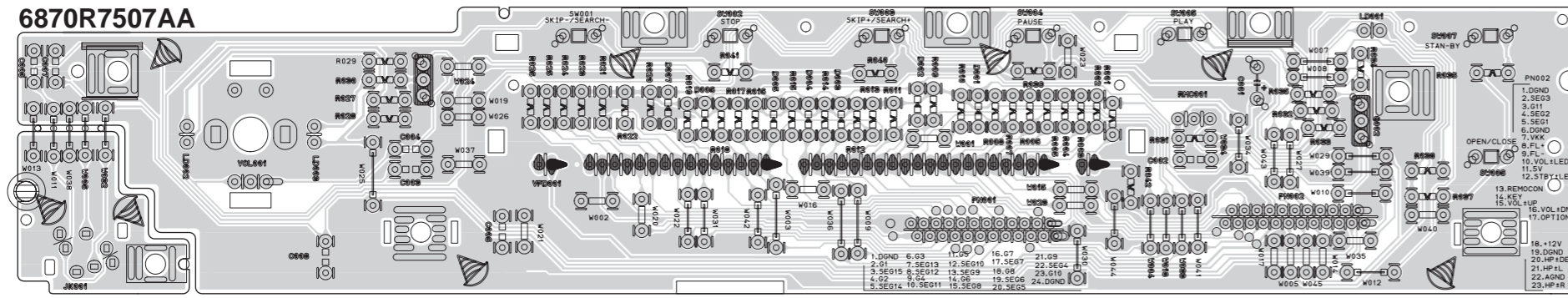

4. SMPS P.C. BOARD (5 TOOL)

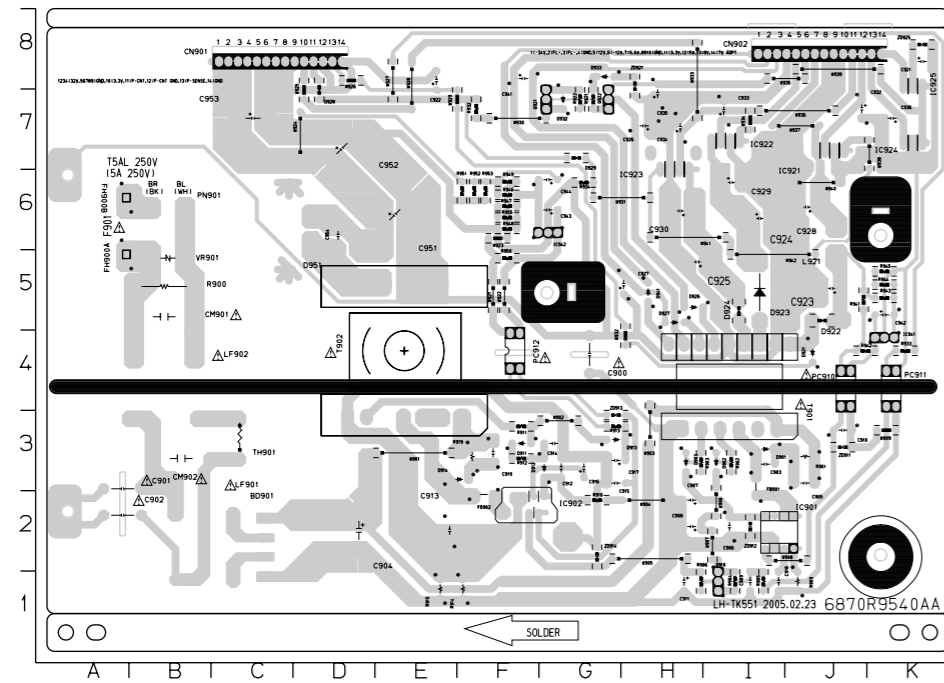

LOCATION GUIDE

B0901	C2	CM902	B3	R900	B5
C900	G4	CN901	C8	R901	J3
C901	A3	CN902	J8	R902	I3
C902	A2	D901	I3	R903	H3
C903	I3	D902	I3	R904	I1
C904	D2	D903	H3	R905	I1
C905	J3	D911	F3	R906	H1
C906	I2	D912	G3	R909	J1
C907	H2	D913	G3	R910	G2
C908	H2	D914	F3	R911	F3
C909	I1	D921	J4	R912	F3
C910	J3	D922	J5	R913	G3
C911	H1	D923	I5	R914	F1
C912	G3	D924	I5	R915	E1
C913	E2	D926	H5	R919	F3
C914	G3	D927	H5	R921	G7
C915	G3	D928	D7	R922	G7
C916	G3	D929	G7	R932	F7
C917	G3	D932	G7	R933	K4
C918	I1	D933	G8	R934	G6
C919	F3	D941	H5	R941	J5
C920	K8	D951	D6	R942	J4
C922	E8	FB901	I3	R943	K5
C923	J5	FB902	F2	R944	K5
C924	I6	FH900A	A5	R945	K5
C925	H5	FH900B	A6	R946	F6
C926	H7	IC901	J2	R947	F6
C927	H5	IC902	F2	R948	F6
C928	J6	IC921	J7	R949	F6
C929	I6	IC922	I7	R950	F5
C930	H6	IC923	H6	R951	F6
C932	J7	IC924	K7	R952	F6
C933	I7	IC925	K8	R953	F6
C934	H7	IC941	K4	R955	F6
C935	H7	IC942	G6	T901	I4
C936	K7	L921	J6	T902	E4
C941	F8	LF901	B2	TH901	C3
C942	K5	LF902	B4	VR901	B5
C943	G6	PC910	J4	ZD911	J3
C944	G6	PC911	K4	ZD912	I2
C951	E6	PC912	F4	ZD913	G3
C952	C7	PN901	B6	ZD914	G2
C953	D7	Q910	I1	ZD921	H8
C954	D6	Q921	G7	ZD925	K8
CM901	B5	Q922	G7		

NOTES: ⚠ Warning
Parts that are shaded are critical
With respect to risk of fire or
electrical shock.

5. JACK P.C. BOARD (TOP VIEW)

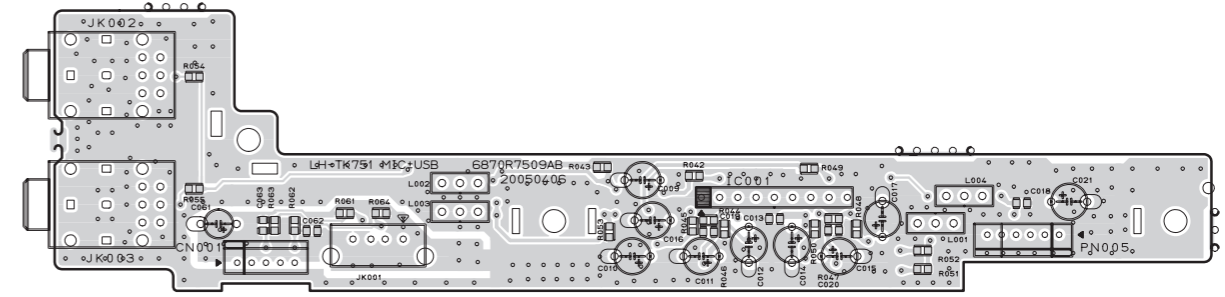

(7 TOOL)

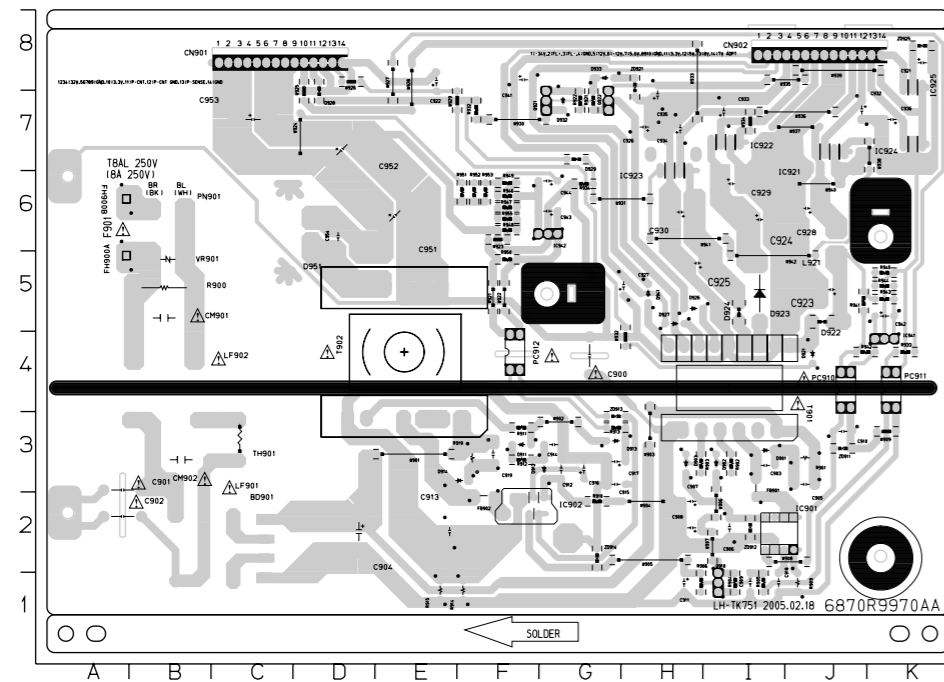

LOCATION GUIDE

B0901	C2	CM902	B3	R900	B5
C900	G4	CN901	C8	R901	J3
C901	A3	CN902	J8	R902	I3
C902	A2	D901	I3	R903	H3
C903	I3	D902	I3	R904	I1
C904	D2	D903	H3	R905	I1
C905	J3	D911	F3	R906	H1
C906	I2	D912	G3	R909	J1
C907	H2	D913	G3	R910	G2
C908	H2	D914	F3	R911	F3
C909	I1	D921	J4	R912	F3
C910	J3	D922	J5	R913	G3
C911	H1	D923	I5	R914	F1
C912	G3	D924	I5	R915	E1
C913	E2	D926	H5	R919	F3
C914	G3	D927	H5	R921	G7
C915	G3	D928	D7	R922	G7
C916	G3	D929	G7	R932	F7
C917	G3	D932	G7	R933	K4
C918	I1	D933	G8	R934	G6
C919	F3	D941	H5	R941	J5
C920	K8	D951	D6	R942	J4
C922	E8	FB901	I3	R943	K5
C923	J5	FB902	F2	R944	K5
C924	I6	FH900A	A5	R945	K5
C925	H5	FH900B	A6	R946	F6
C926	H7	IC901	J2	R947	F6
C927	H5	IC902	F2	R948	F6
C928	J6	IC921	J7	R949	F6
C929	I6	IC922	I7	R950	F5
C930	H6	IC923	H6	R951	F6
C932	J7	IC924	K7	R952	F6
C933	I7	IC925	K8	R953	F6
C934	H7	IC941	K4	R955	F6
C935	H7	IC942	G6	T901	I4
C936	K7	L921	J6	T902	E4
C941	F8	LF901	B2	TH901	C3
C942	K5	LF902	B4	VR901	B5
C943	G6	PC910	J4	ZD911	J3
C944	G6	PC911	K4	ZD912	I2
C951	E6	PC912	F4	ZD913	G3
C952	C7	PN901	B6	ZD914	G2
C953	D7	Q910	I1	ZD921	H8
C954	D6	Q921	G7	ZD925	K8
CM901	B5	Q922	G7		

NOTES: ⚠ Warning
Parts that are shaded are critical
With respect to risk of fire or
electrical shock.

(BOTTOM VIEW)

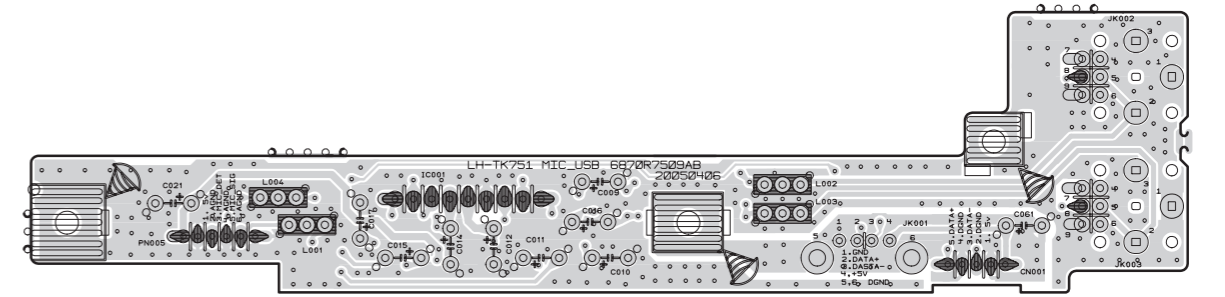

6. AMP P.C. BOARD

(TOP VIEW)

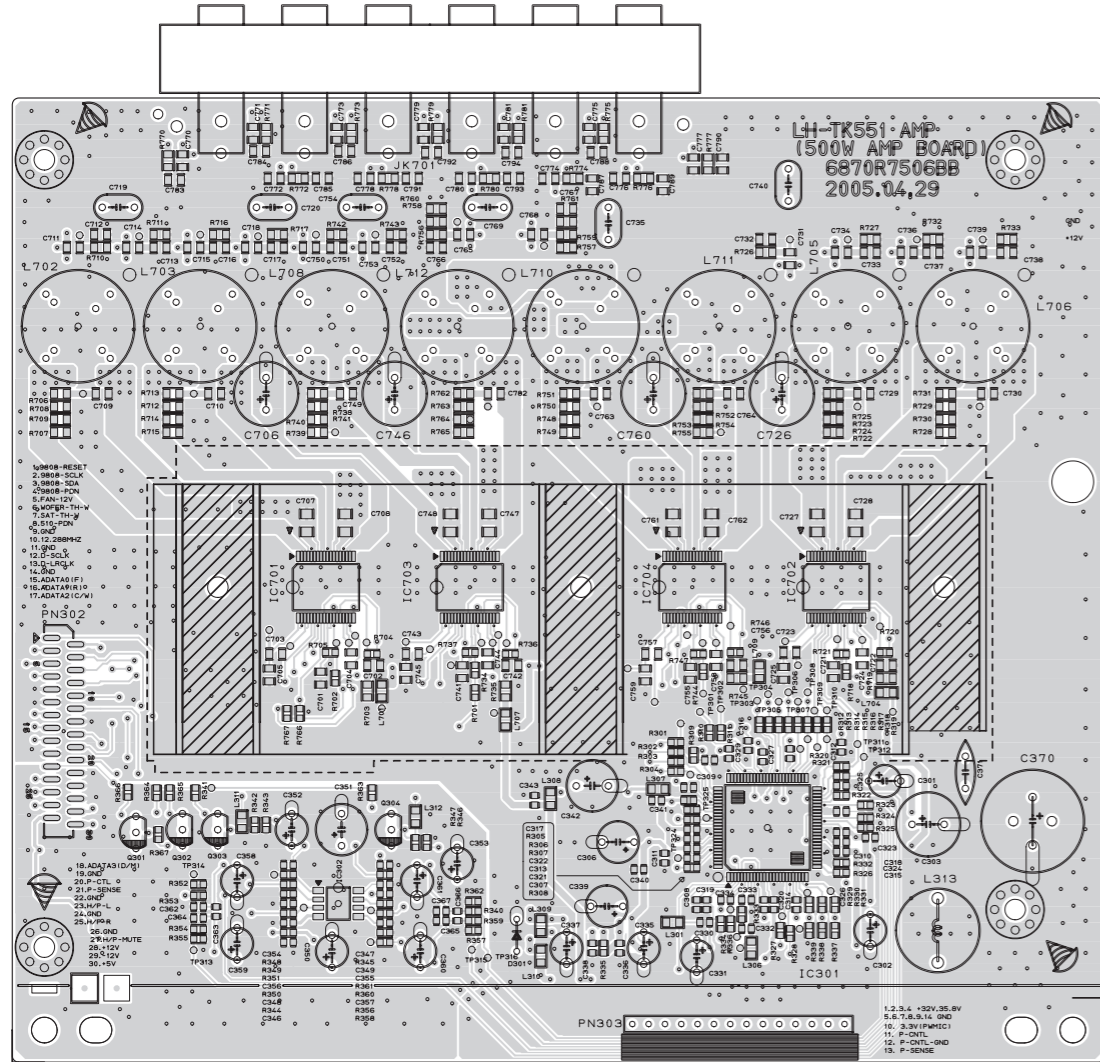

(BOTTOM VIEW)

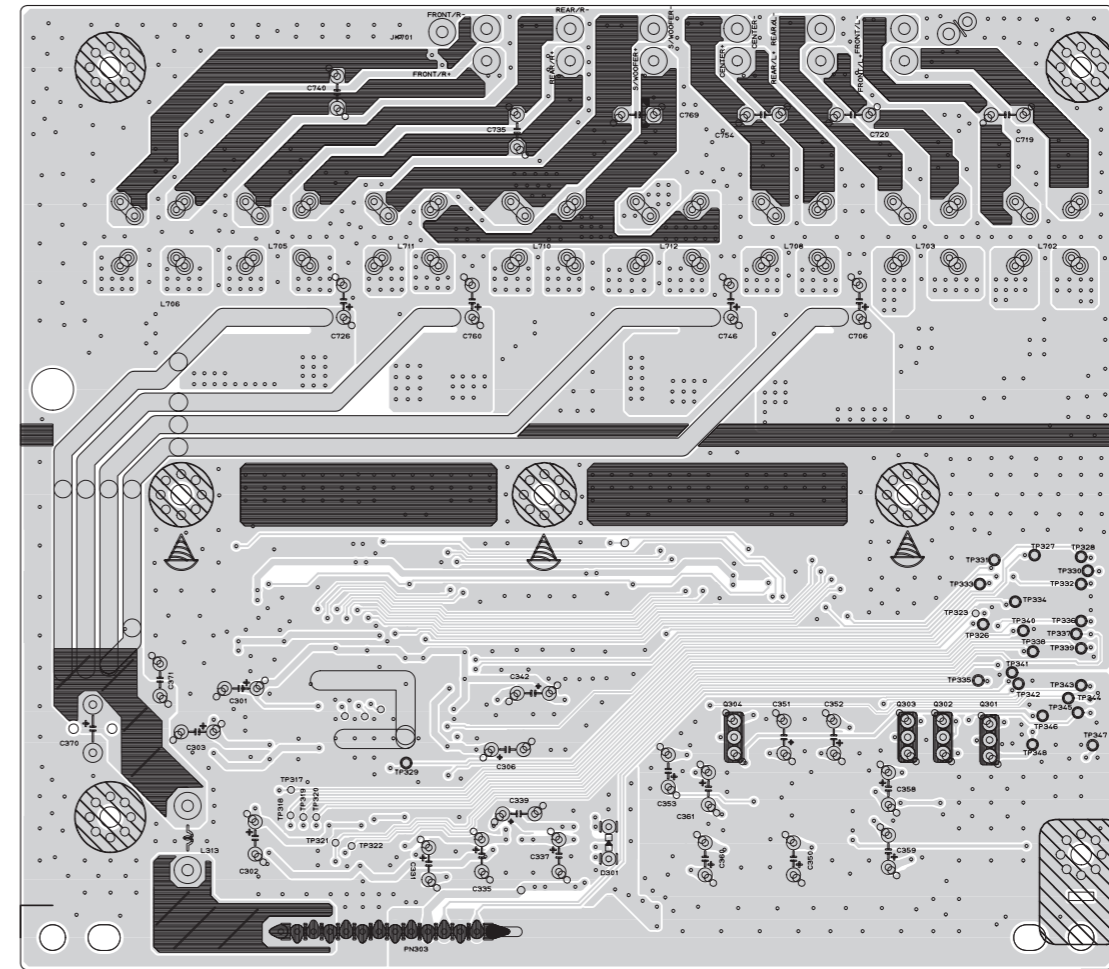

SECTION 3. DVD & AMP PART

ELECTRICAL TROUBLESHOOTING GUIDE

1. System operation flow

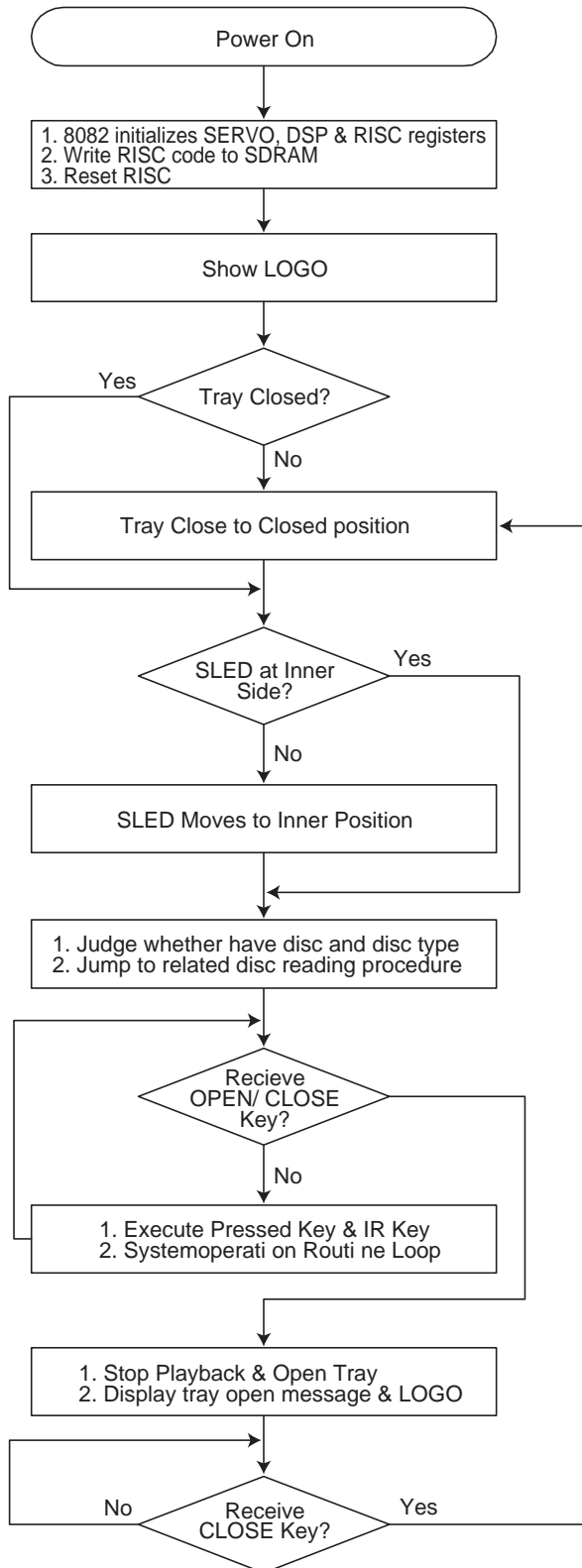

2. Test & debug flow

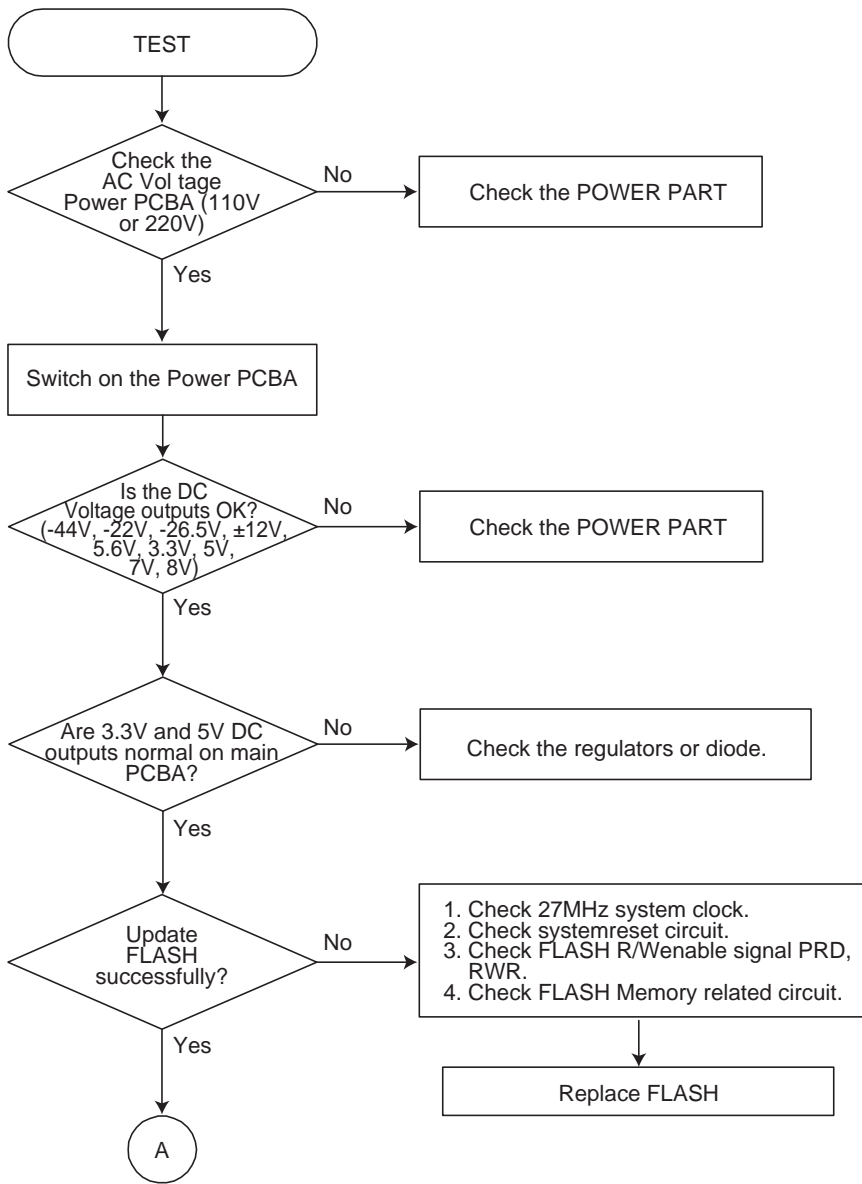

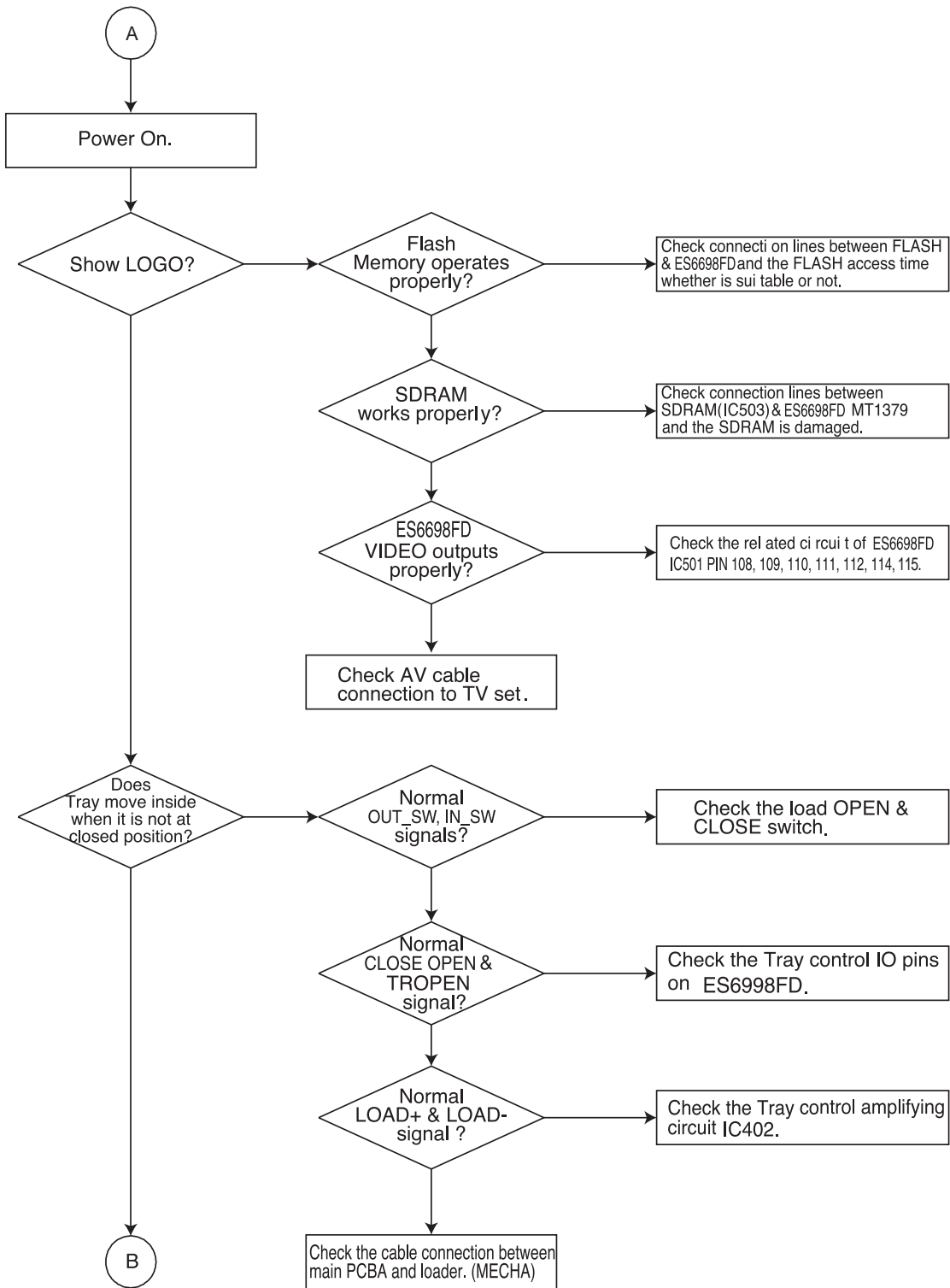

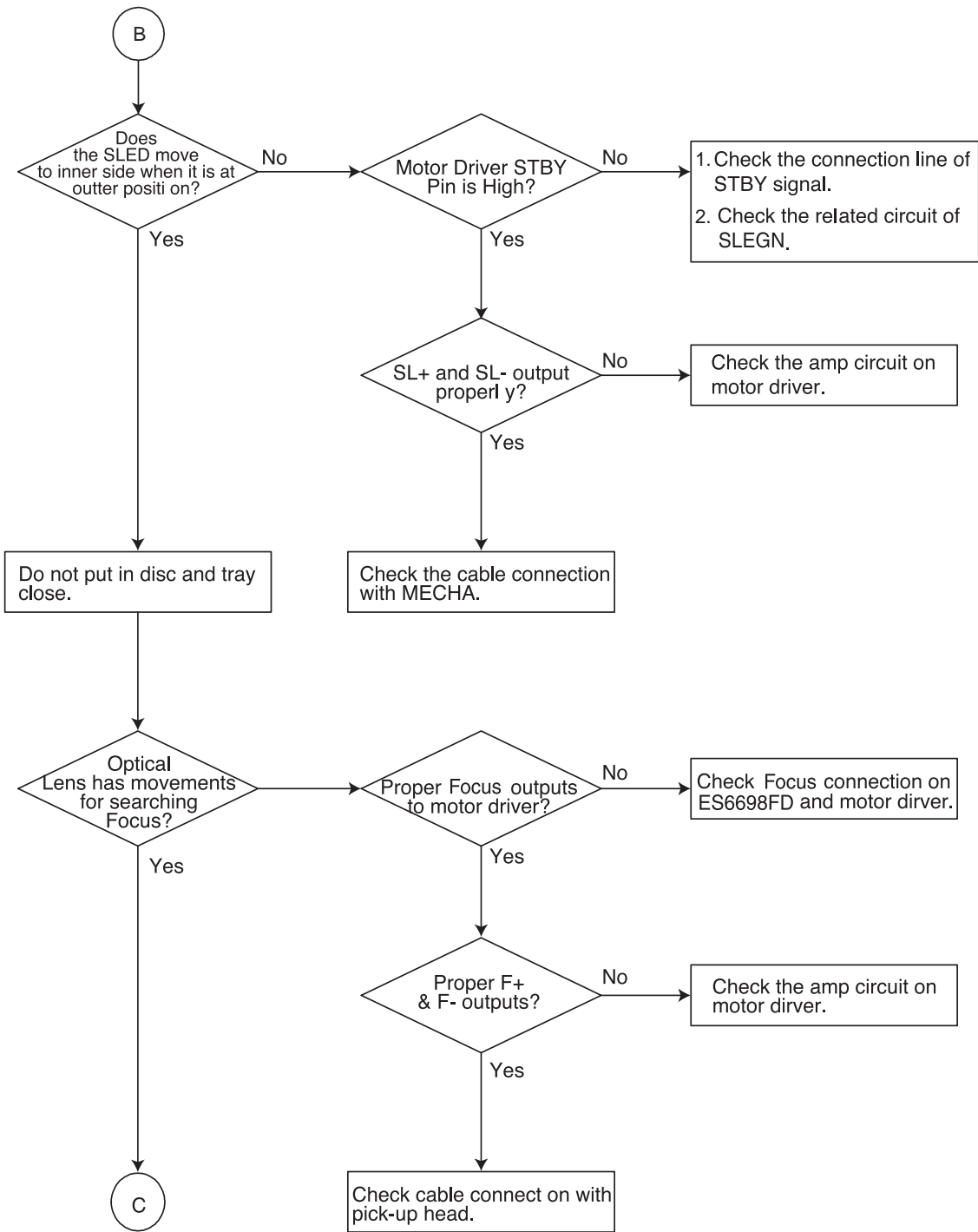

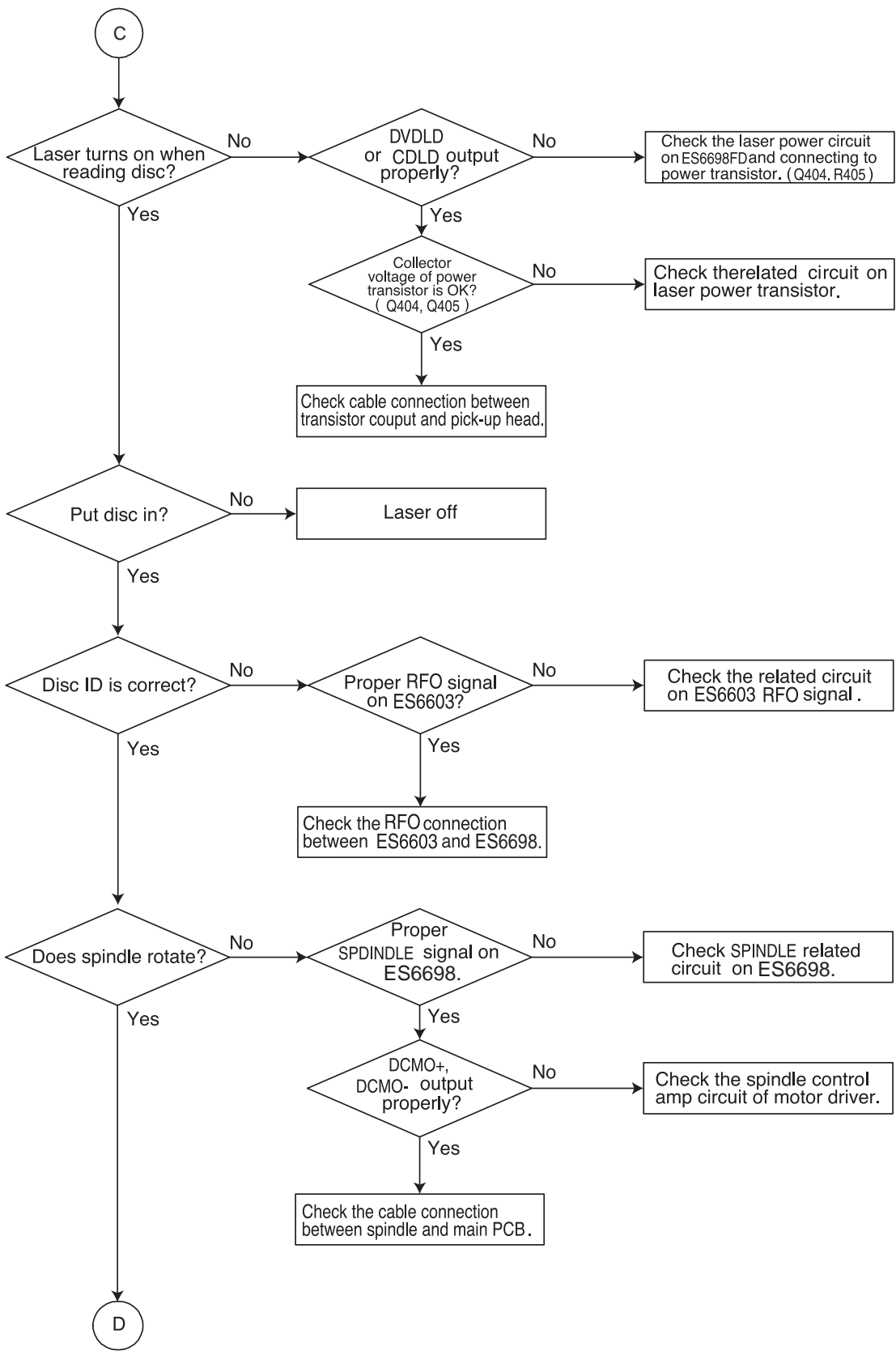

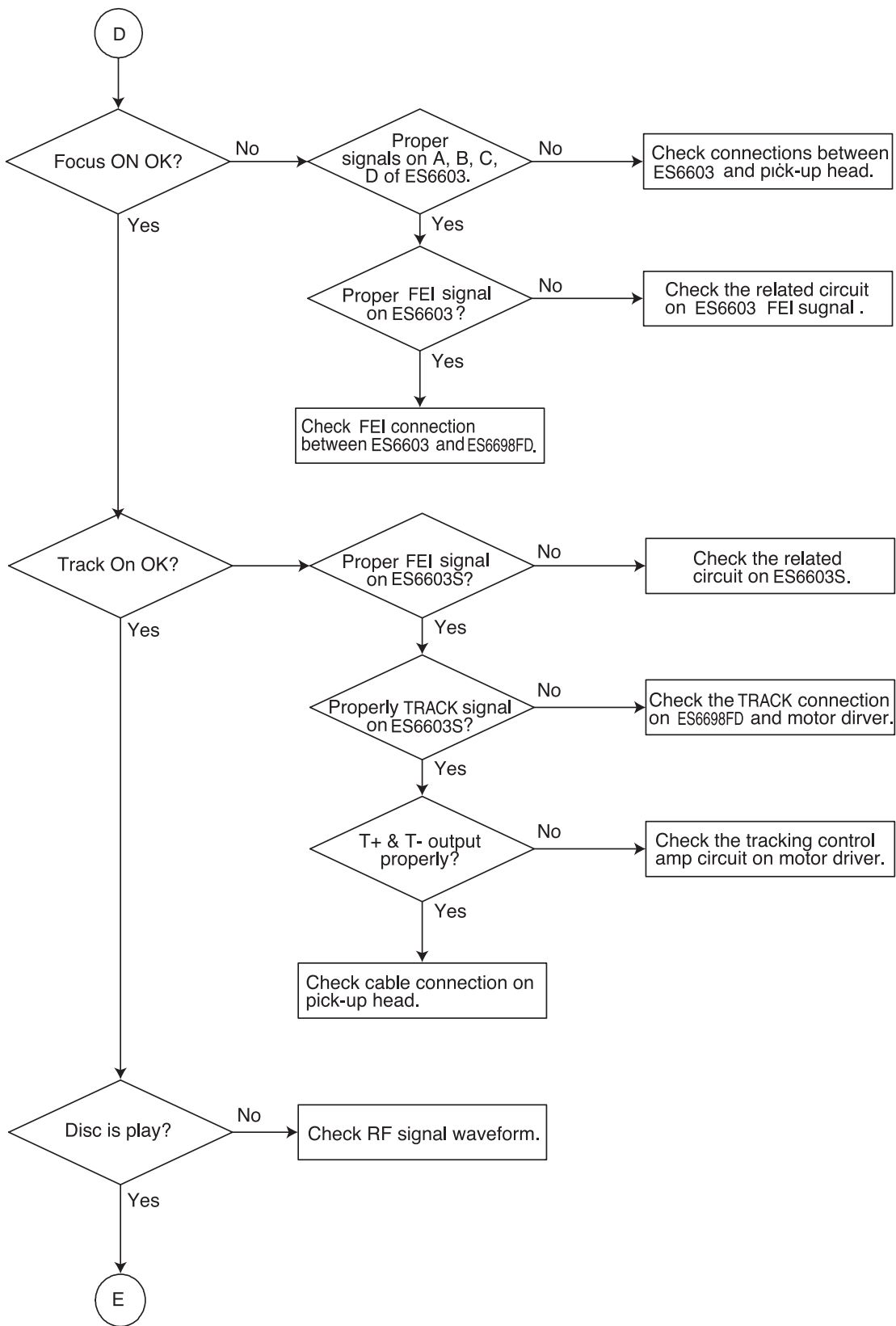

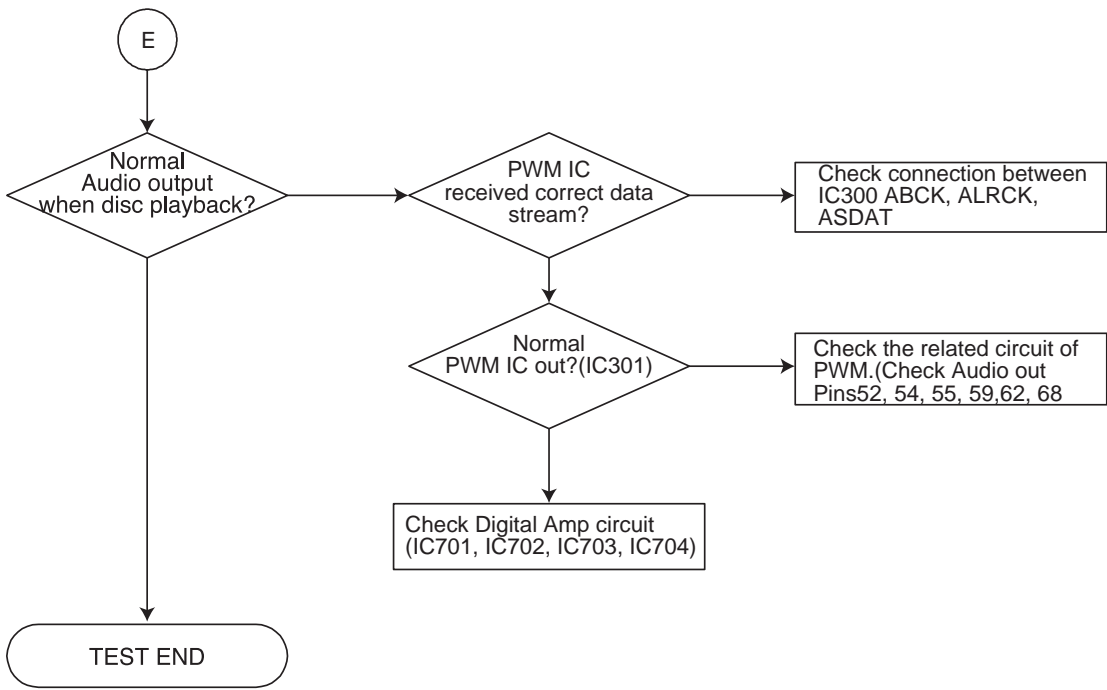

3. AUDIO μ -COM Circuit(DVD & AMP)

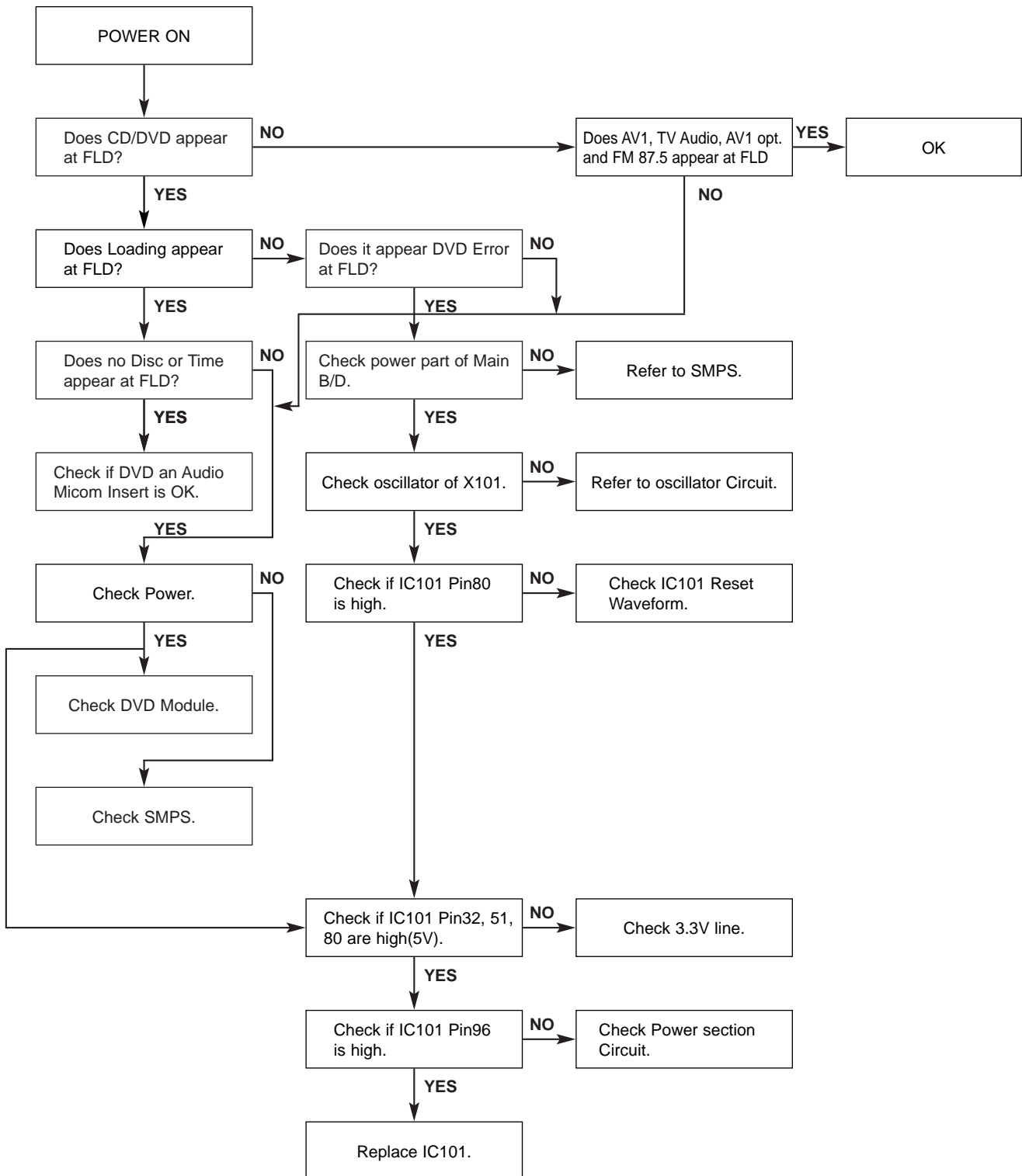

DETAILS AND WAVEFORMS ON SYSTEM TEST AND DEBUGGING

1. SYSTEM 27MHz CLOCK,RESET,FLASH R/W SIGNAL

1) ES6698FD main clock is at 27MHz(X501)

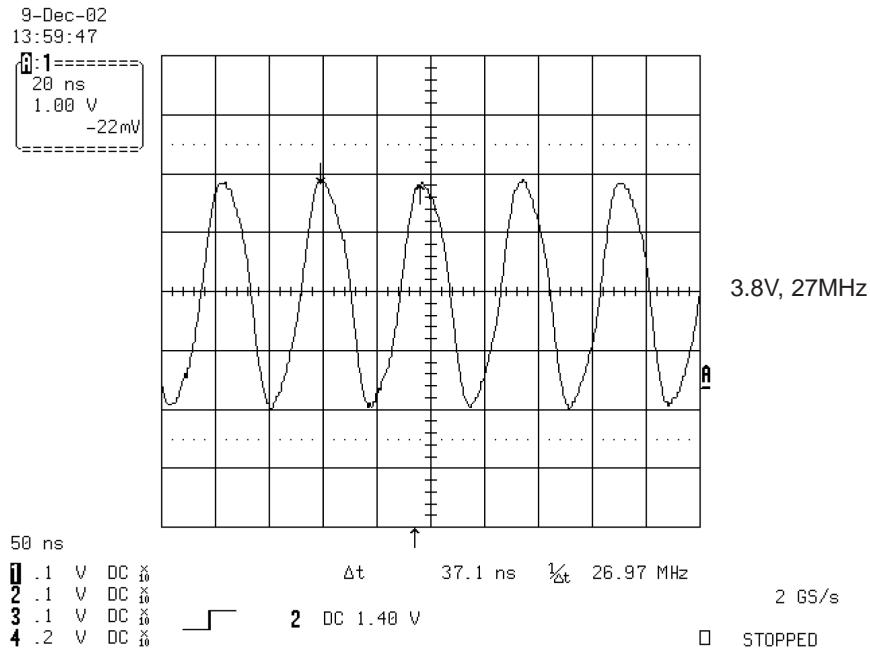

FIG 1-1

2) ES6698FD reset is high active.

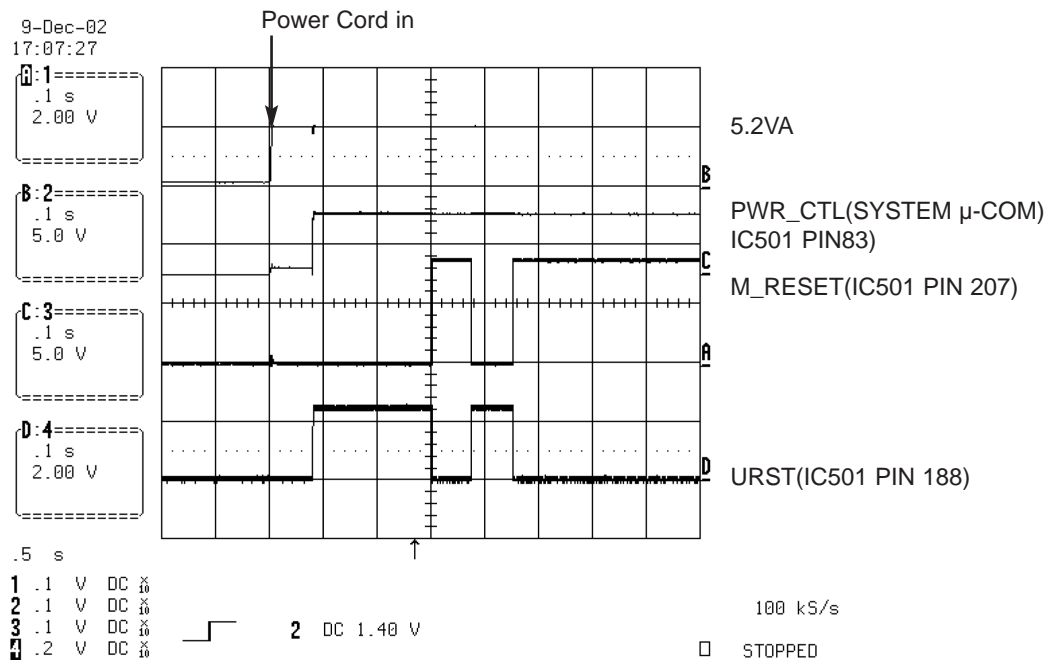

FIG 1-2

4) Flash R/W enable signal during download(Downloading)

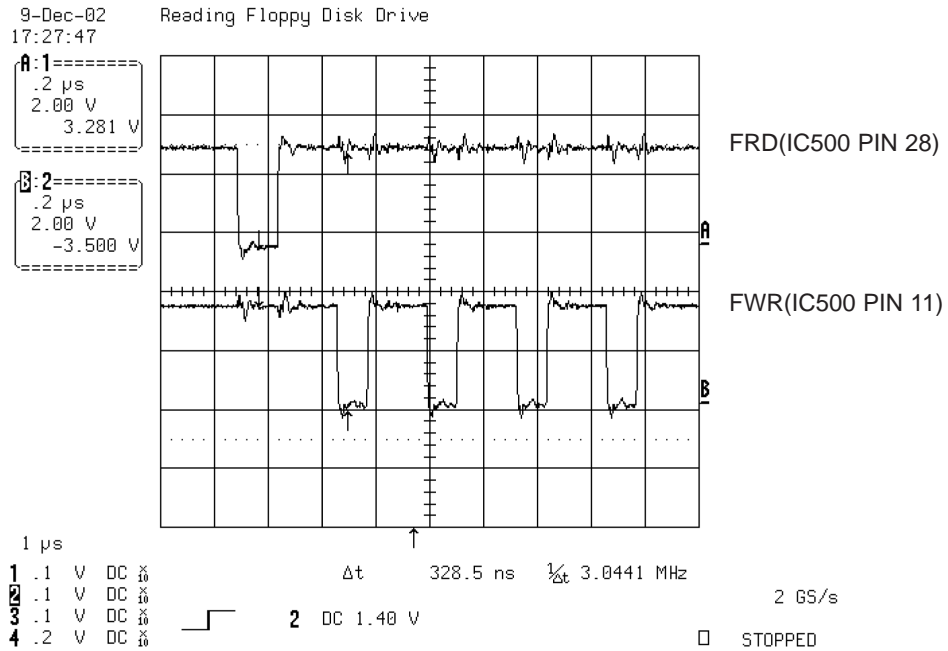

FIG 1-4

2. SDRAM CLOCK

1) ES6698FD main clock is at 27MHz(X501)

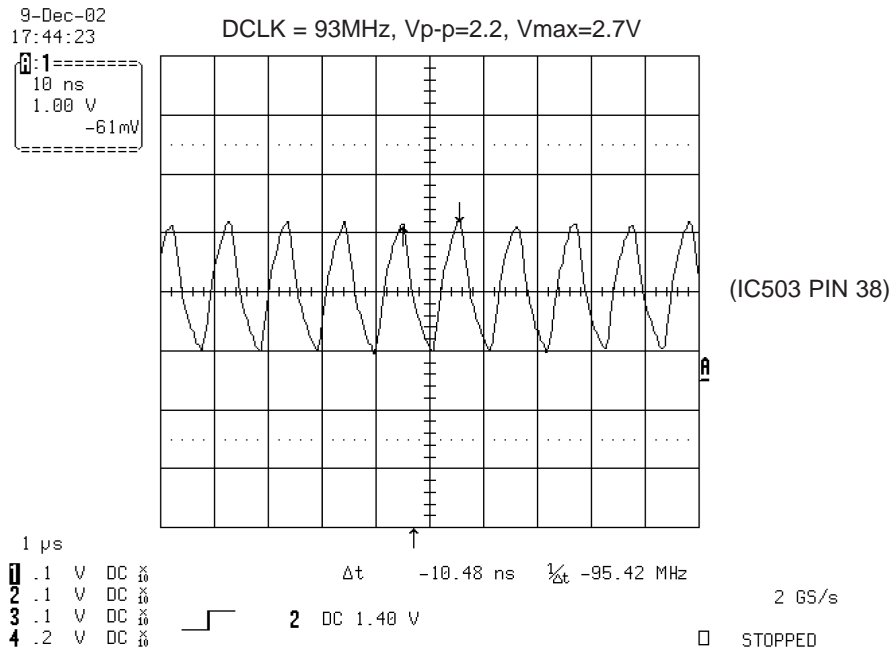

FIG 2-1

3. TRAY OPEN/CLOSE SIGNAL

1) Tray open/close waveform

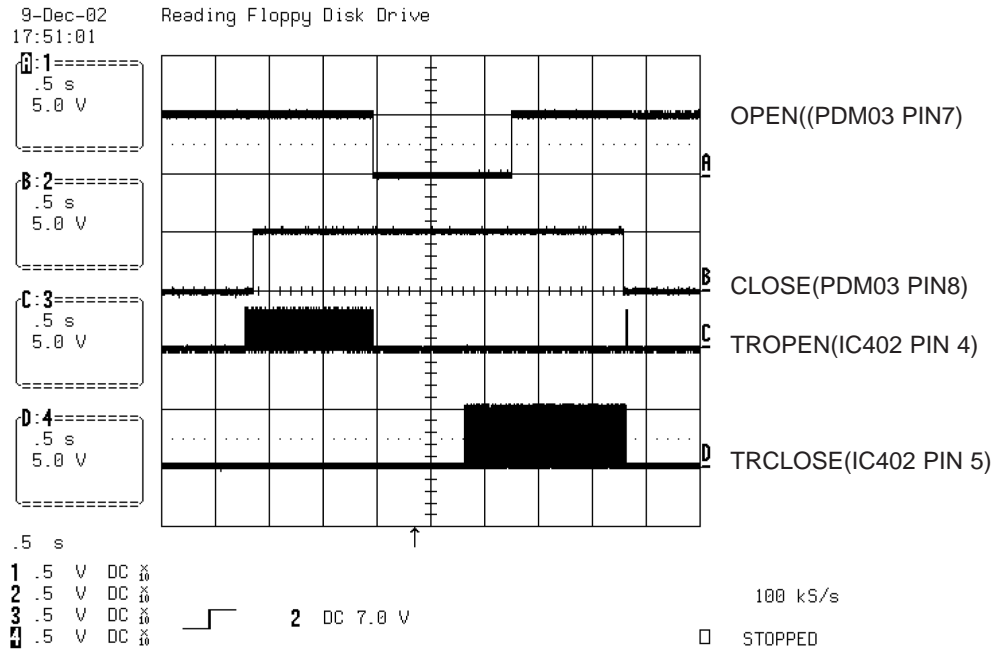

FIG 3-1

2) Tray close waveform

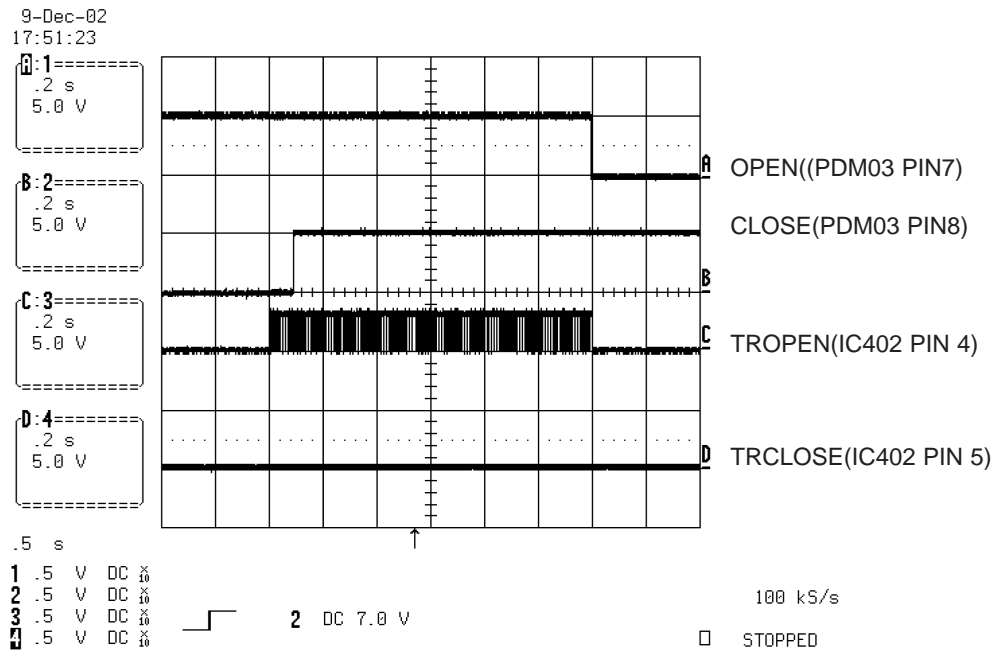

FIG 3-2

3) Tray open waveform

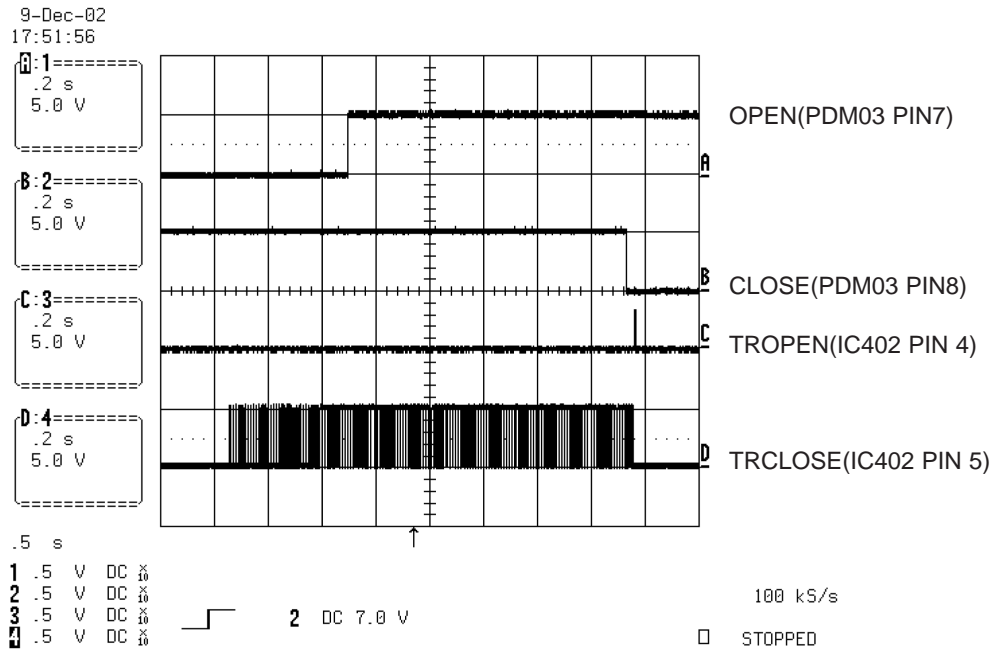

FIG 3-3

4. SLED CONTROL RELATED SIGNAL (NO DISC CONDITION)

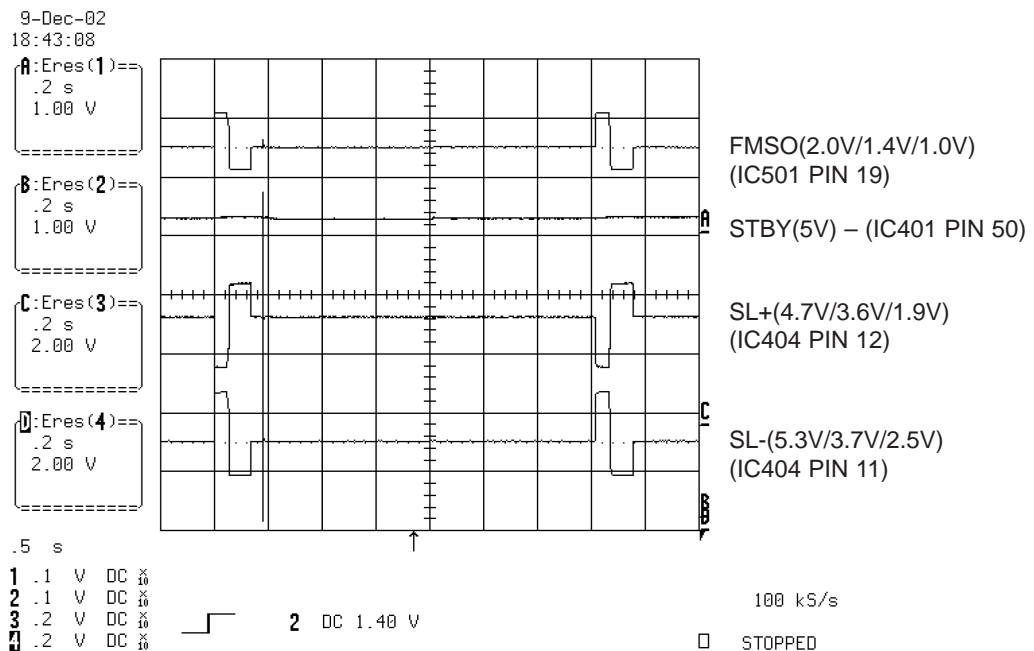

FIG 4-1

5. LENS CONTROL RELATED SIGNAL(NO DISC CONDITION)

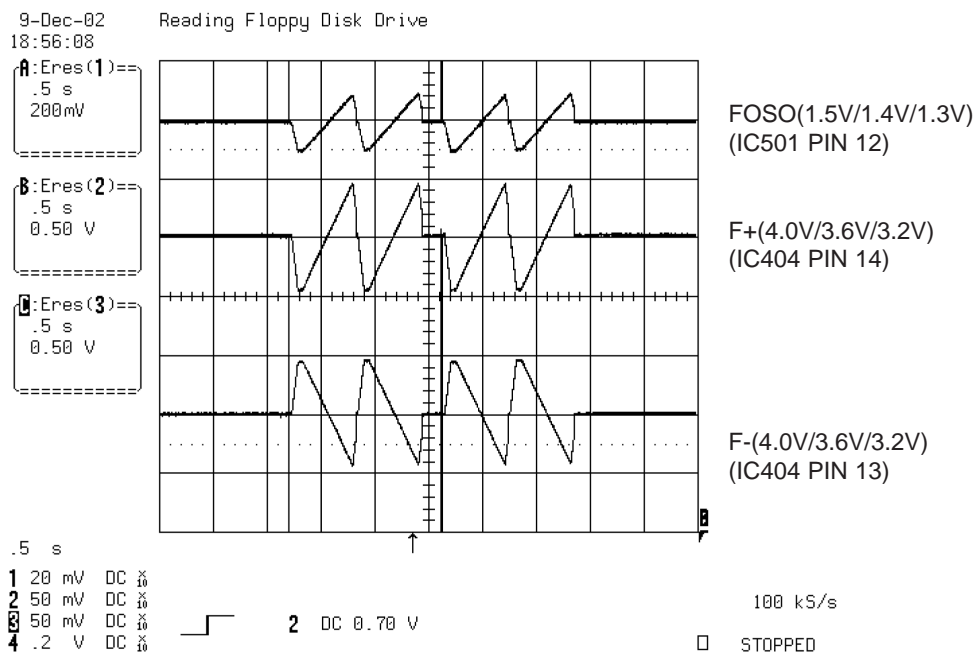

FIG 5-1

6. LASER POWER CONTROL RELATED SIGNAL(NO DISC CONDITION)

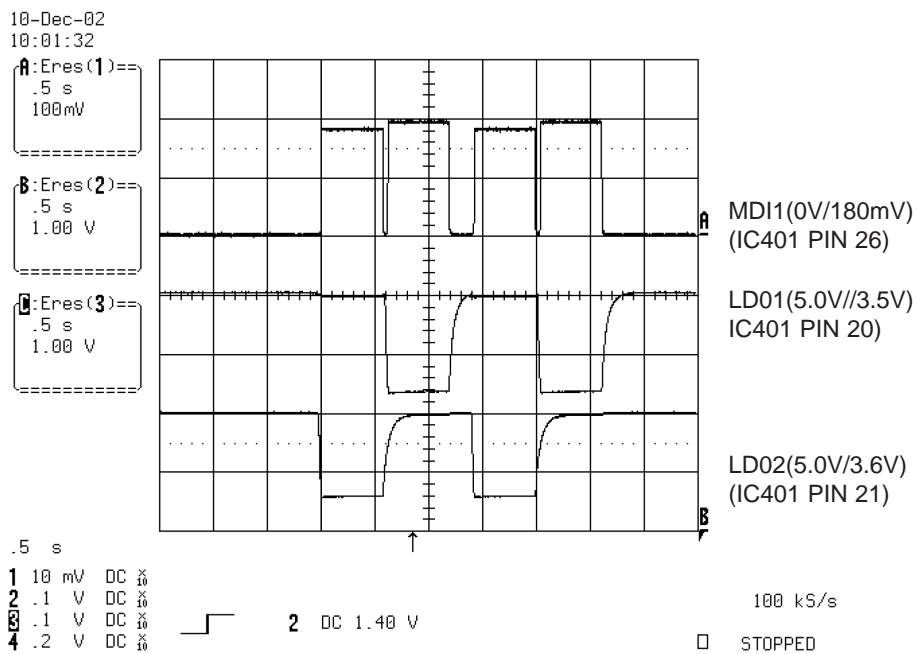

FIG 6-1

7. DISC TYPE JUDGEMENT WAVEFORMS

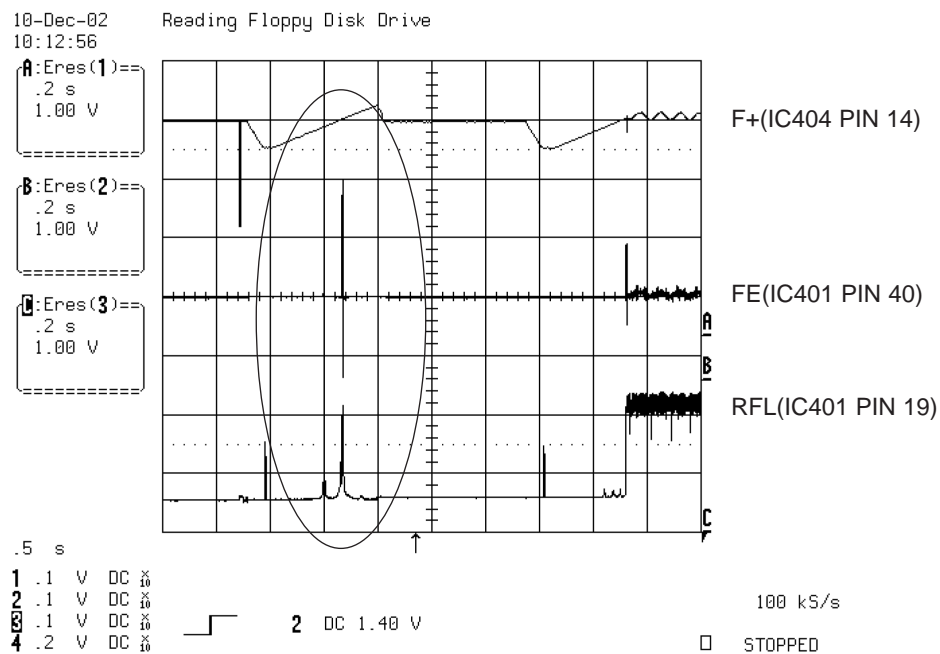

FIG 7-1 (DVD)

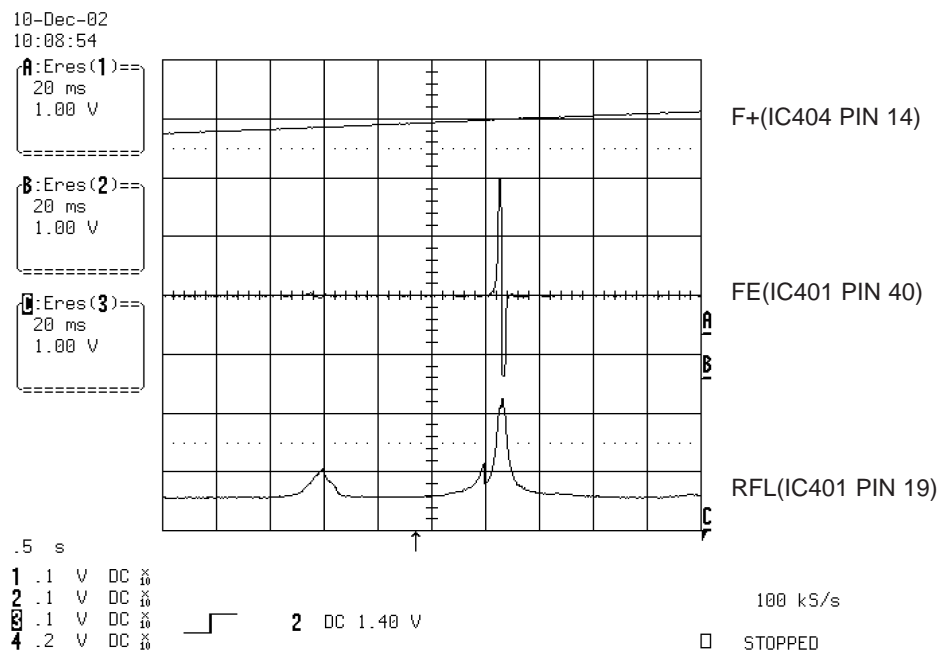

FIG 7-2 (DVD)

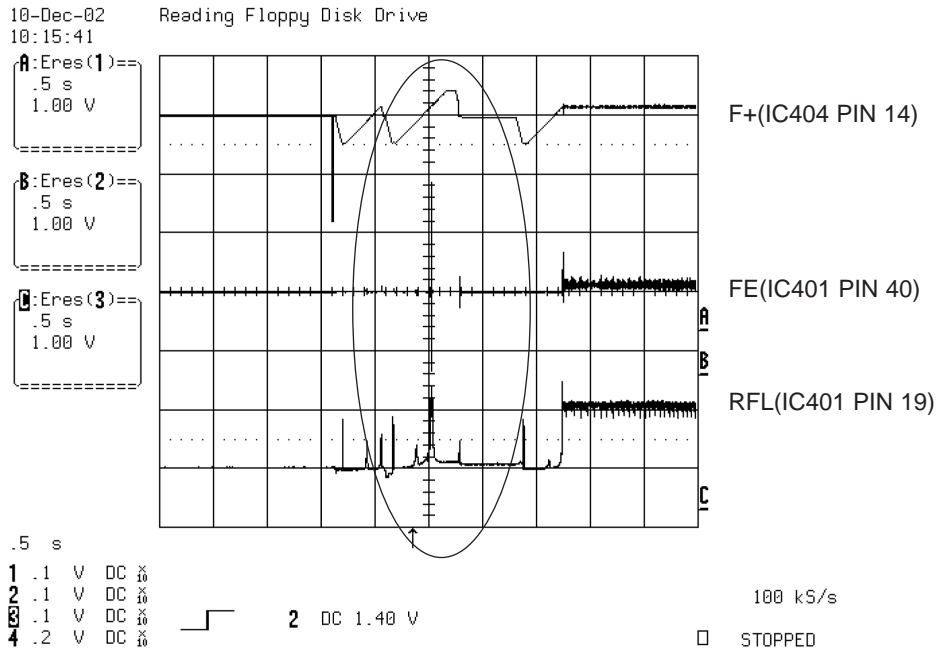

FIG 7-3 (CD)

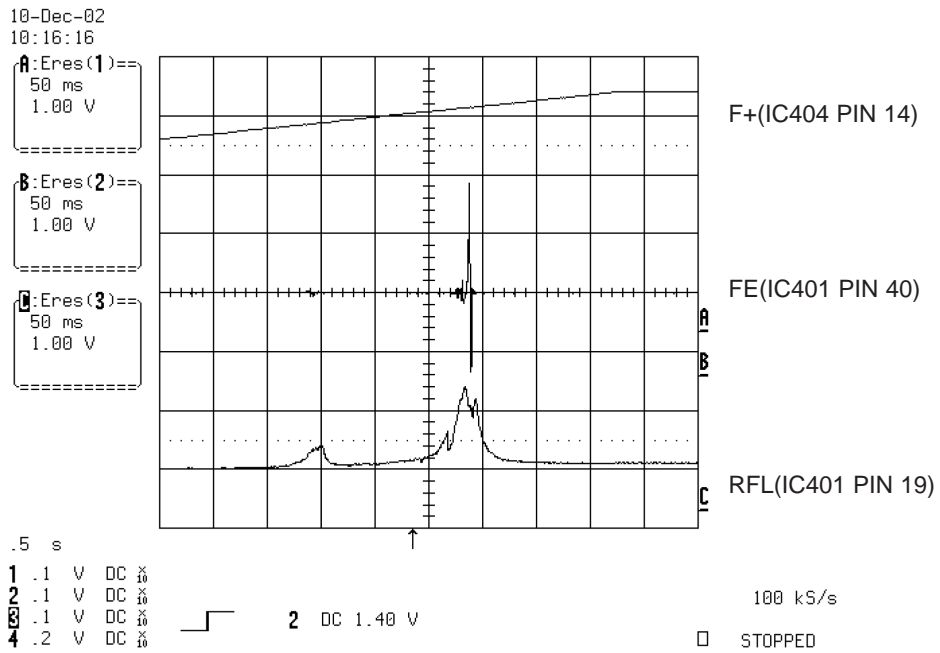

FIG 7-4 (CD)

8. FOCUS ON WAVEFORMS

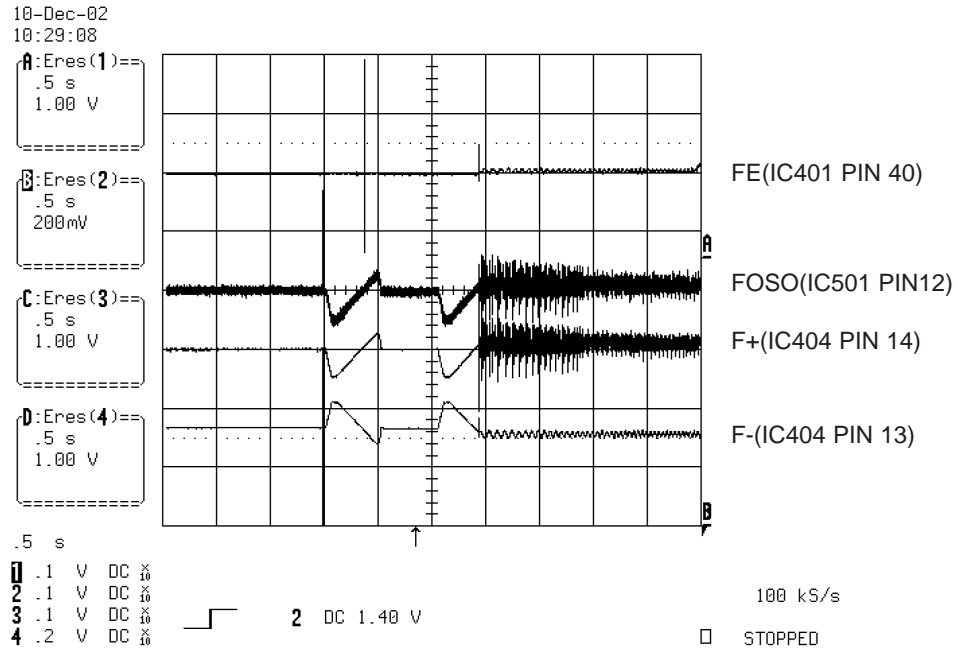

FIG 8-1 (DVD)

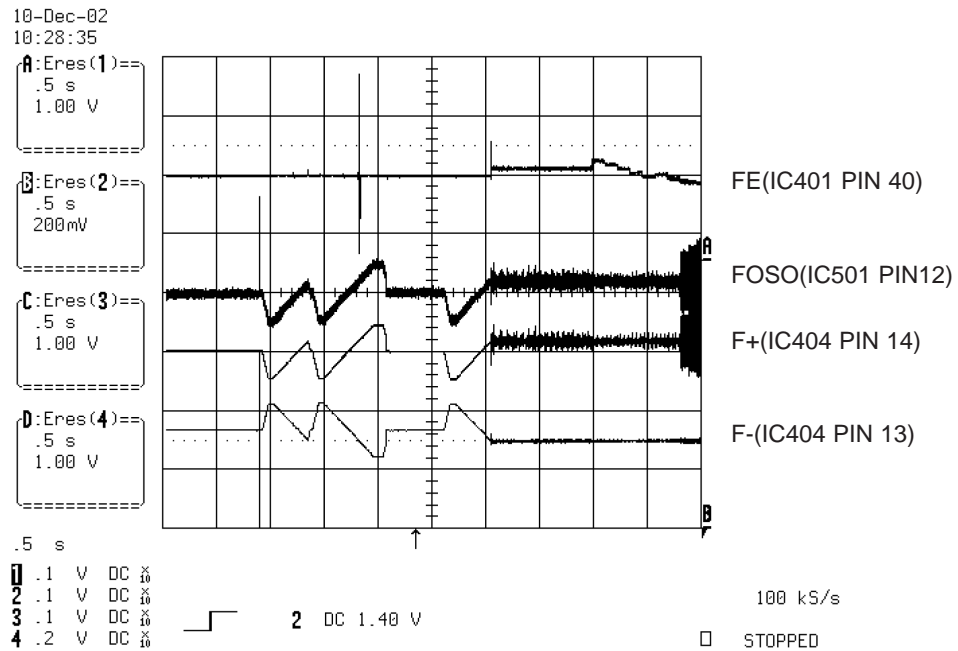

FIG 8-2 (CD)

9. SPINDLE CONTROL WAVEFORMS (NO DISC CONDITION)

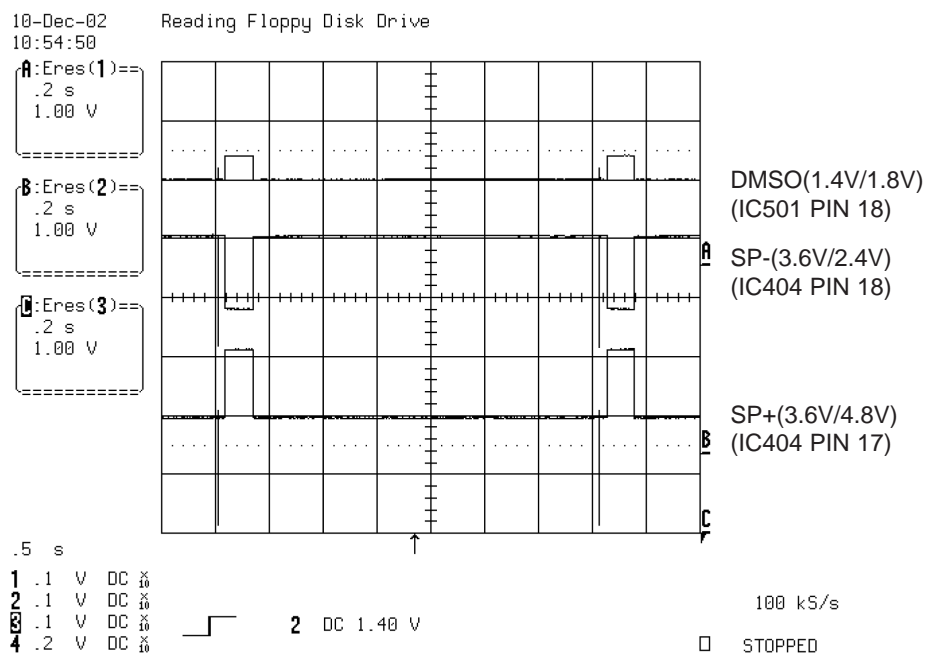

FIG 9-1

10. TRACKING CONTROL RELATED SIGNAL(System checking)

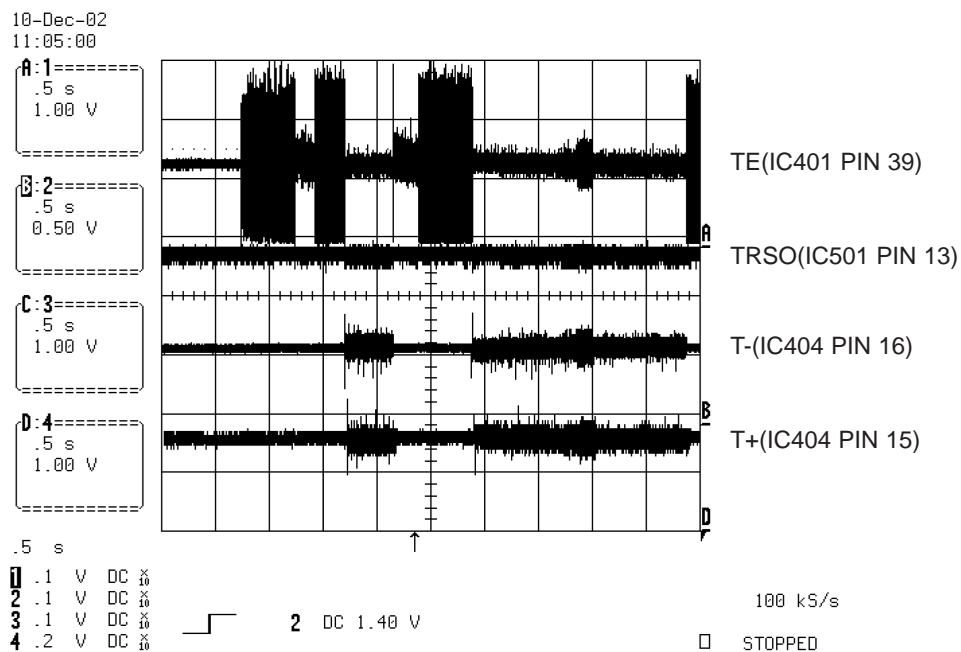

FIG 10-1(DVD)

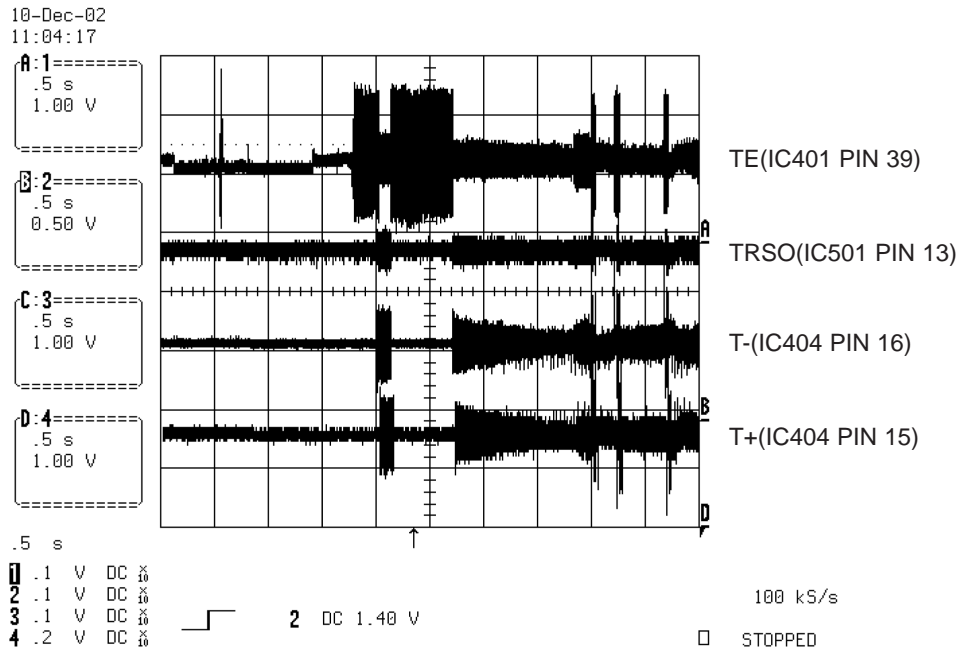

FIG 10-2(CD)

11. RF WAVEFORM

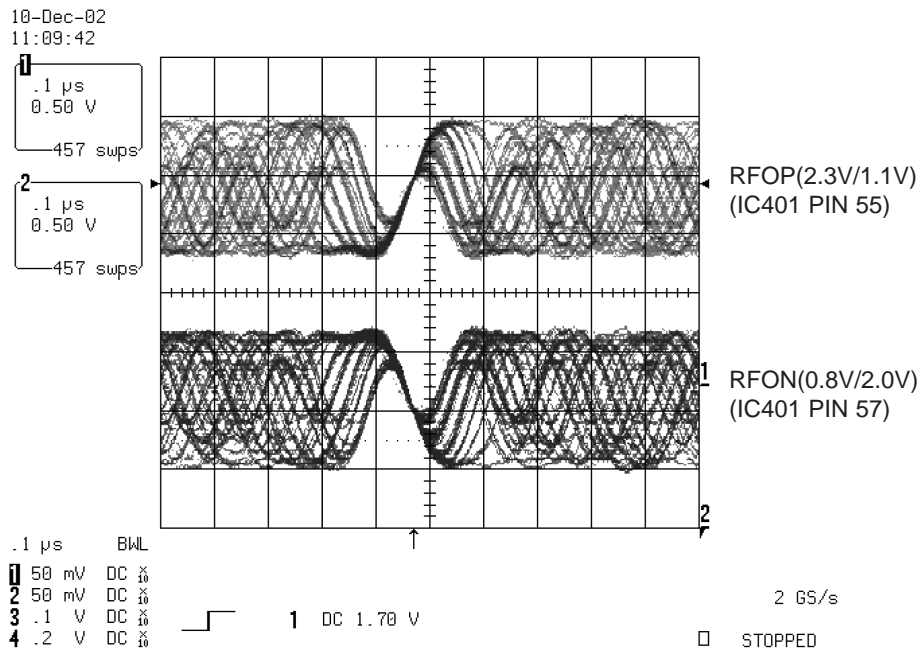

FIG 11-1

12. ES6698FD VIDEO OUTPUT WAVEFORMS

1) Full colorbar signal(COMPOSIT)

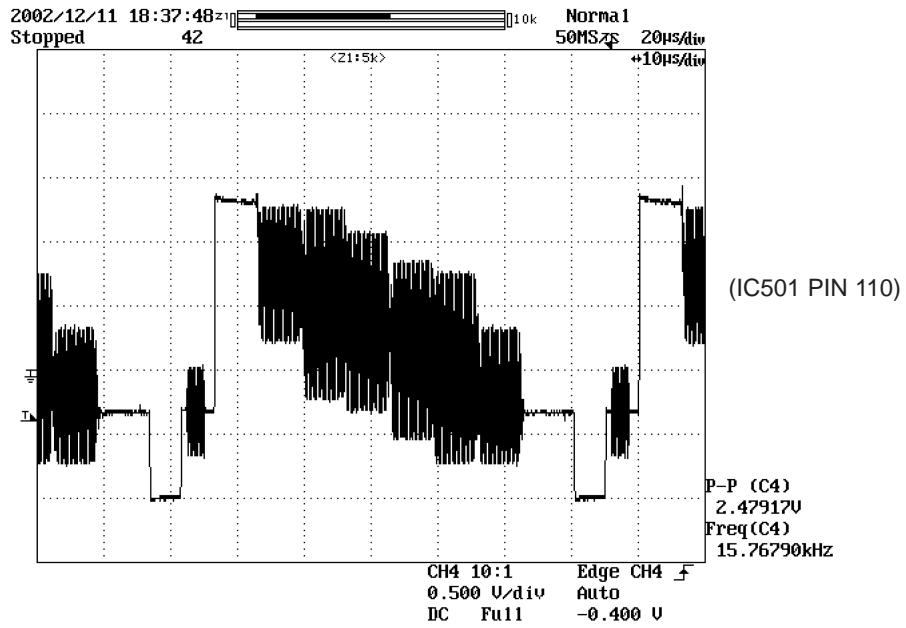

FIG 12-1

2) Y

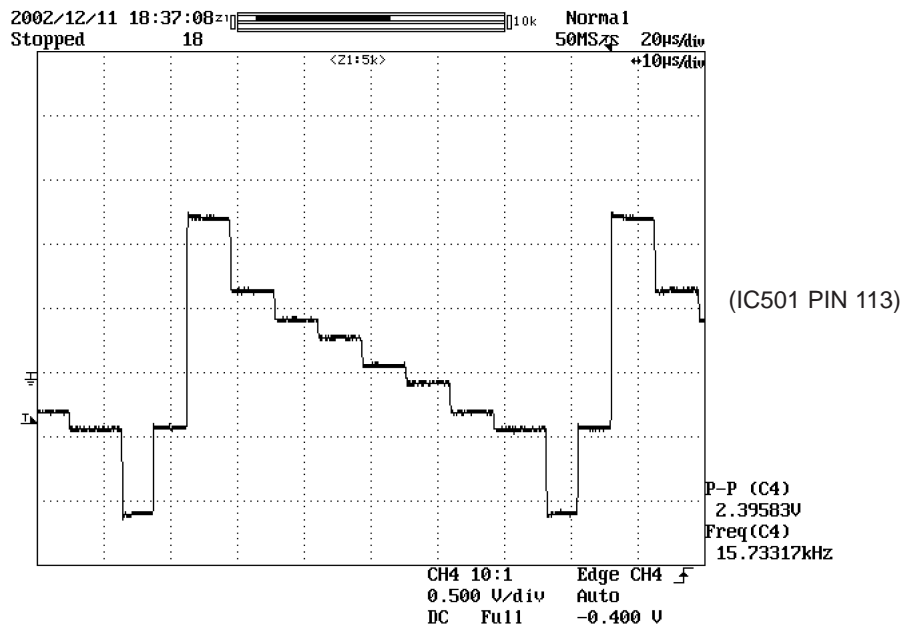

FIG 12-2

13. AUDIO OUTPUT FROM PWM IC

1) Audio L/R

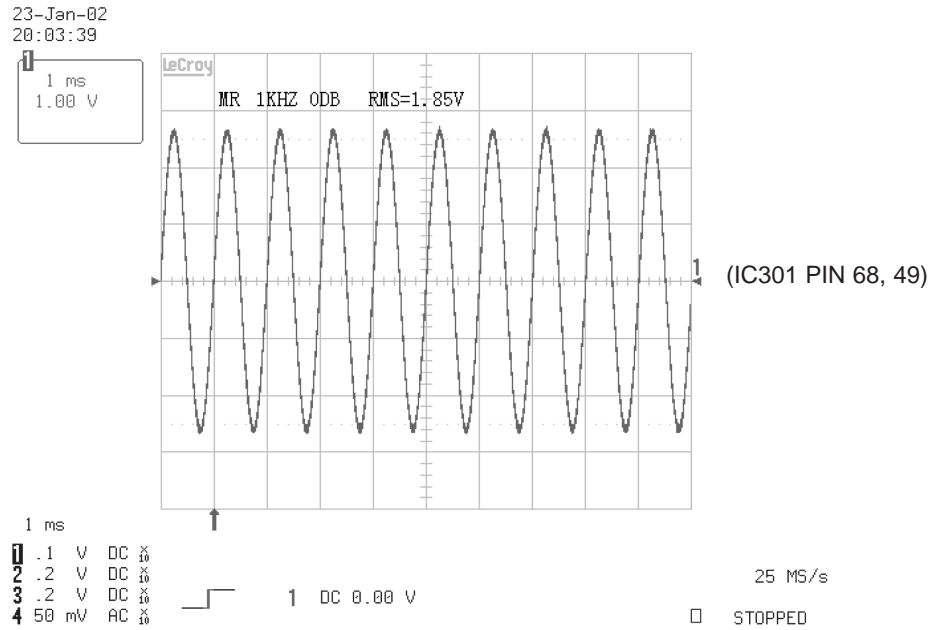

FIG 13-1

2) Audio related Signal

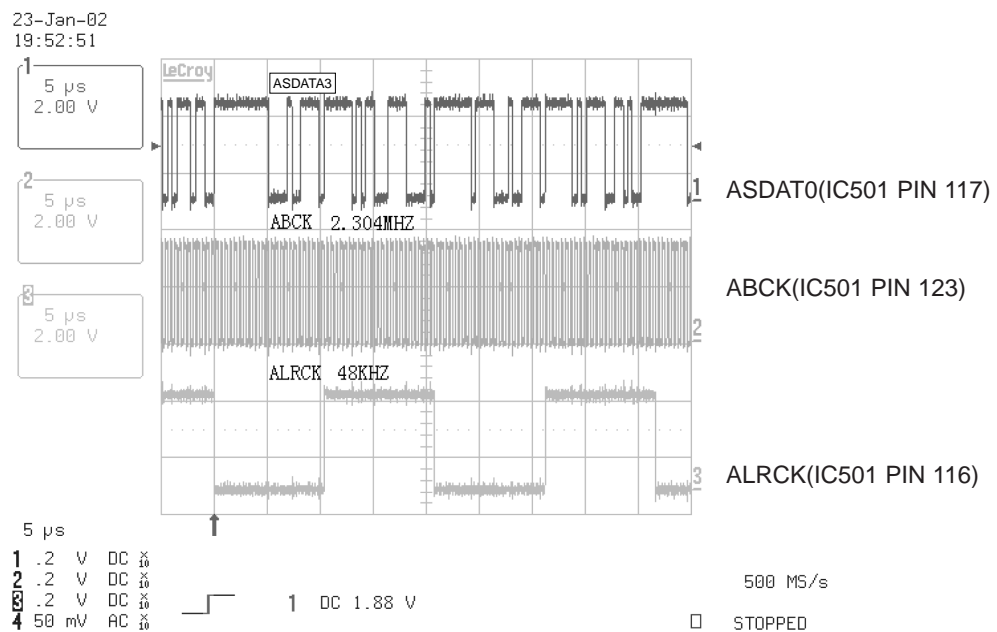
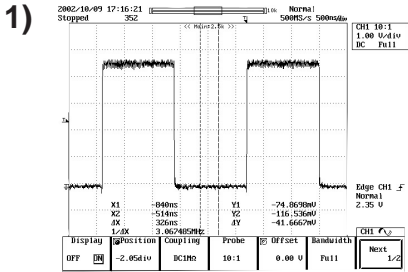
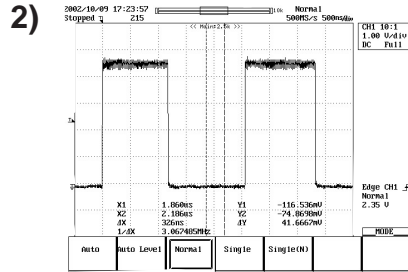

FIG 13-2

14. DVD & AMP WAVEFORMS



- R310 → TP301
- or
- R311 TP302



- R320 → TP311
- or
- R321 TP312

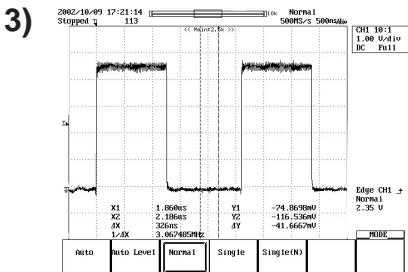

- R312 → TP303
- or
- R313 TP304

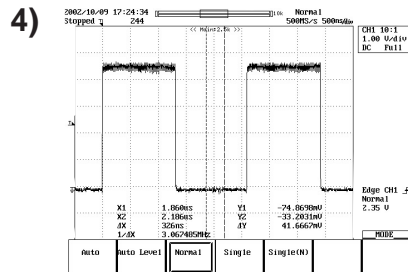

- R318 → TP307
- or
- R319 TP308

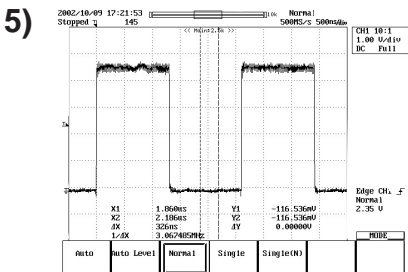

- R314 → TP305
- or
- R315 TP304

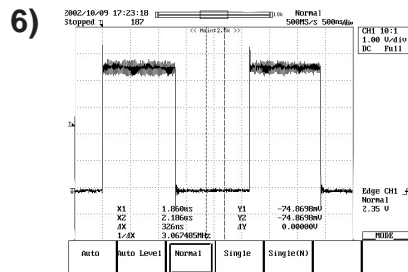

- R318 → TP309
- or
- R319 TP310

MEMO

A series of horizontal dotted lines for writing.

DVD PART SCHEMATIC DIAGRAMS

1. DVD MPEG & DSP SCHEMATIC DIAGRAM

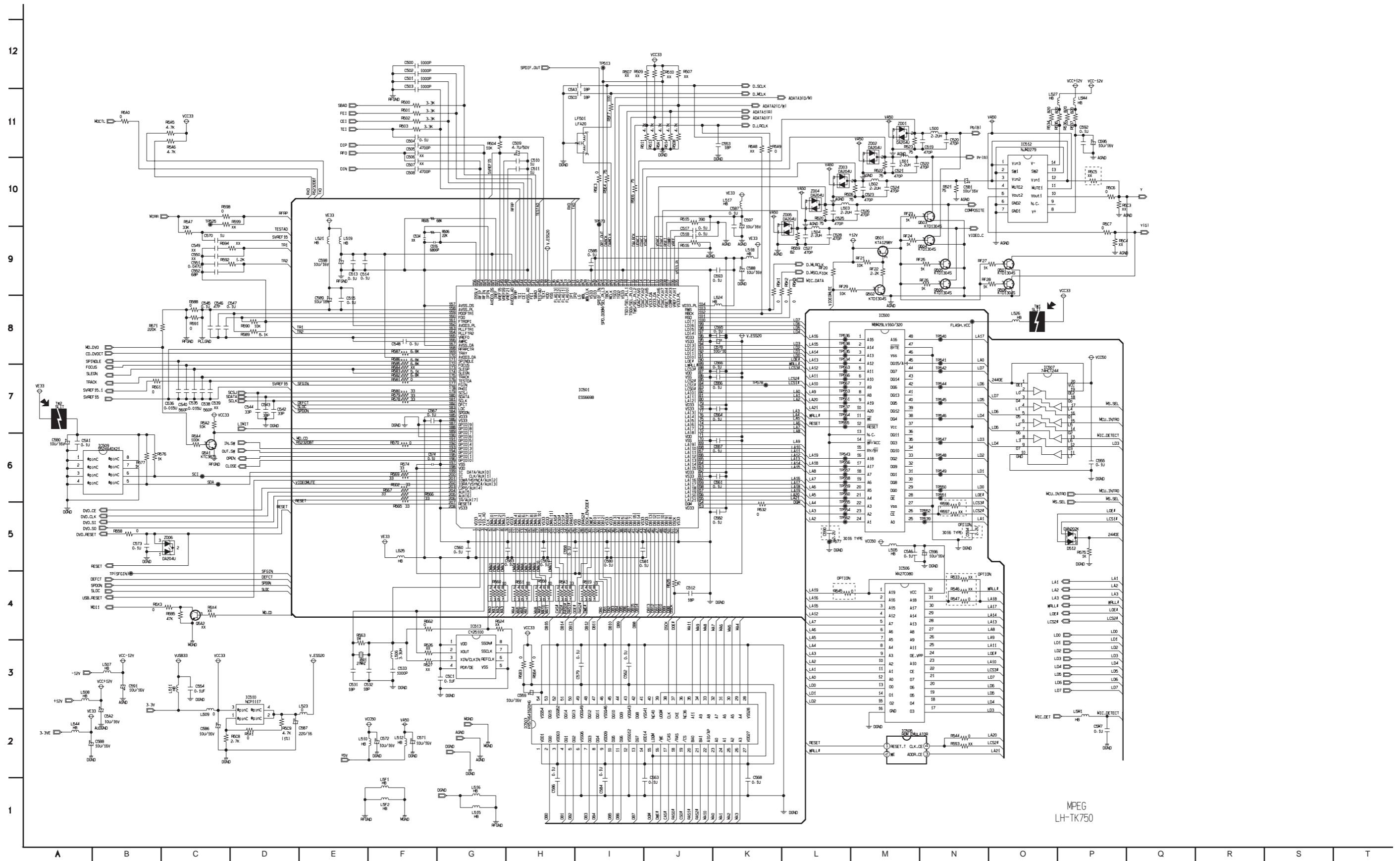

3. FRONT MIC SCHEMATIC DIAGRAM

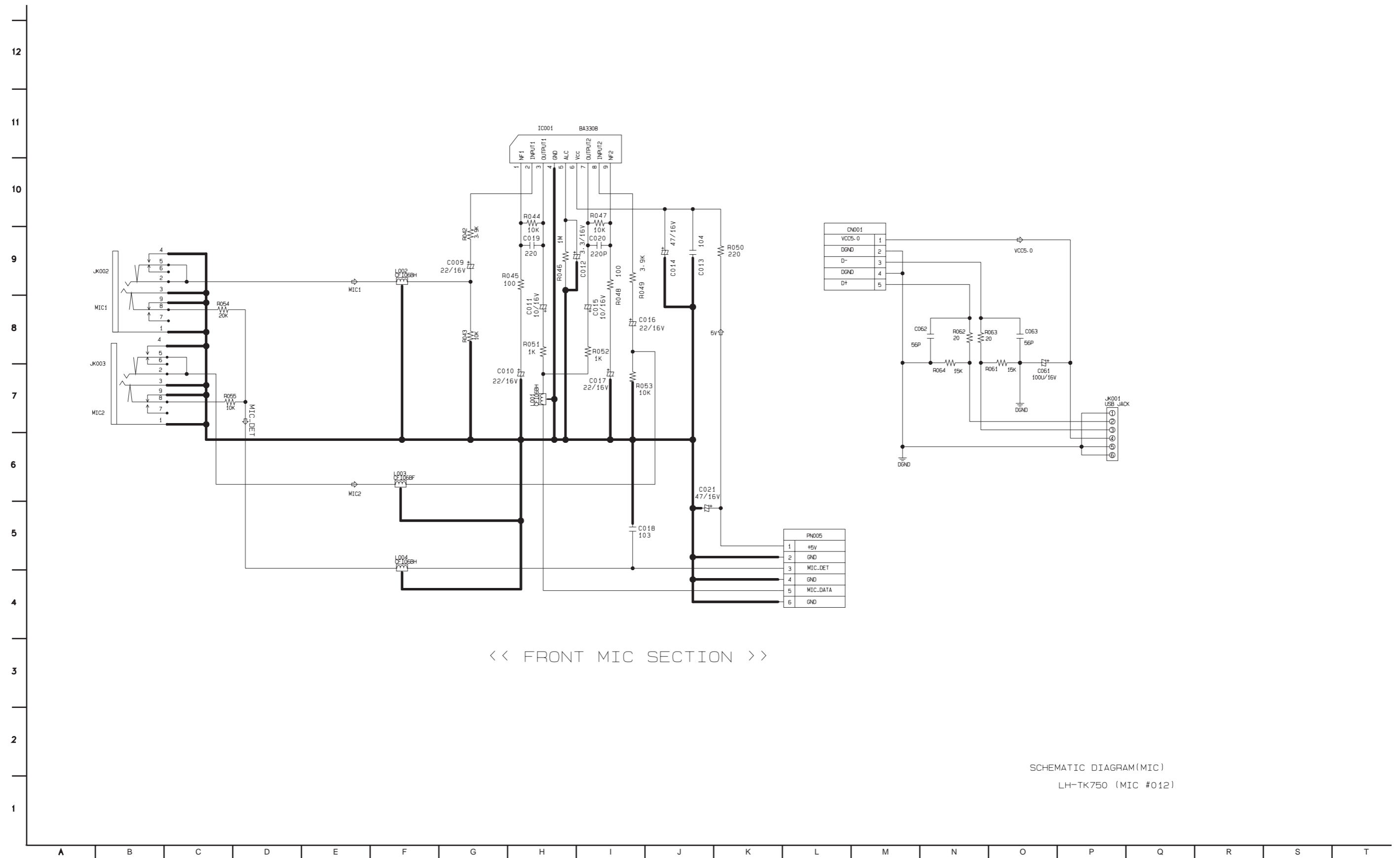

SCHEMATIC DIAGRAM(MIC)
LH-TK750 (MIC #012)

4. USB CONTROLLER SCHEMATIC DIAGRAM

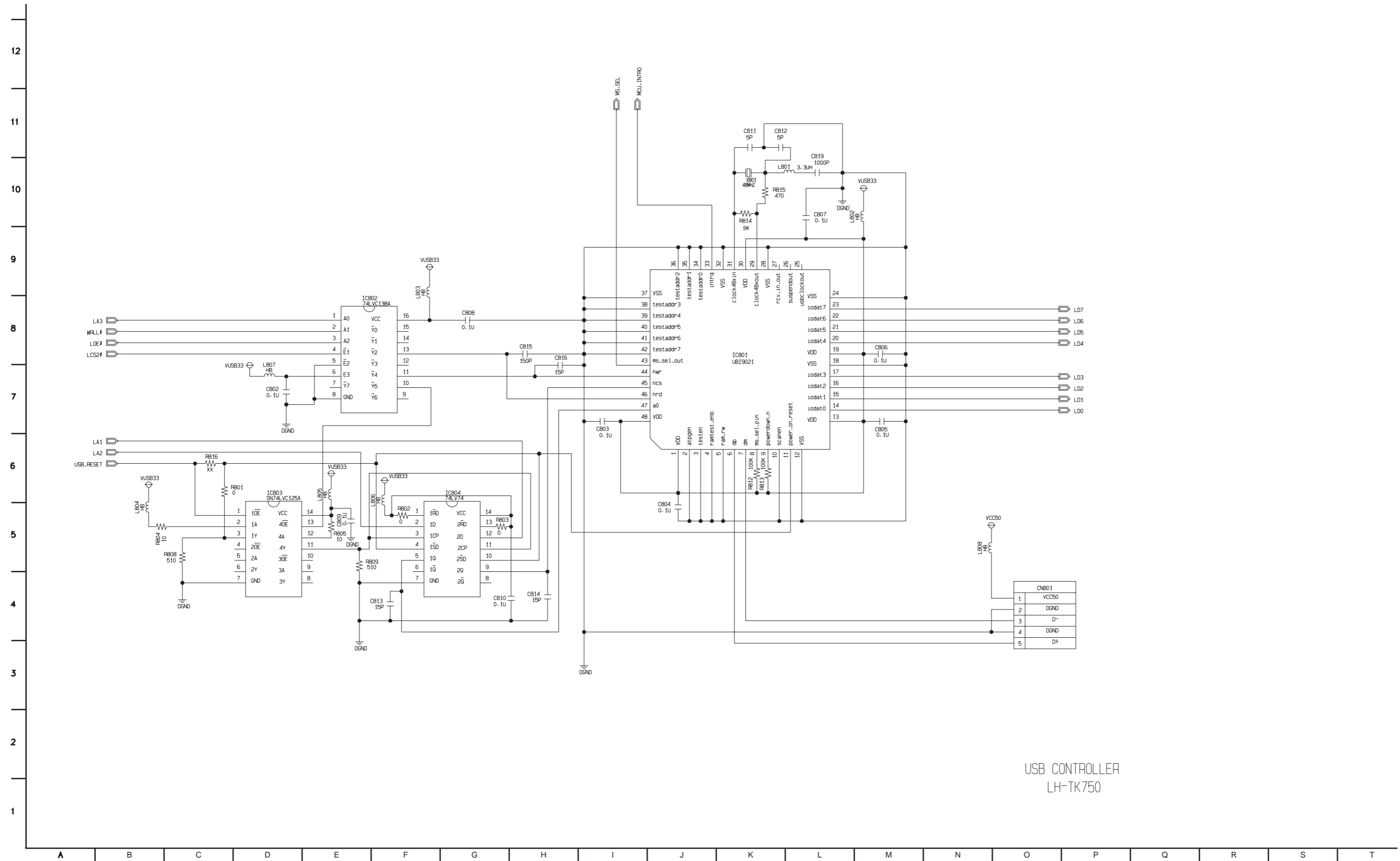

USB CONTROLLER
LH-TK750

5. AMP SCHEMATIC DIAGRAM (5TOOL)

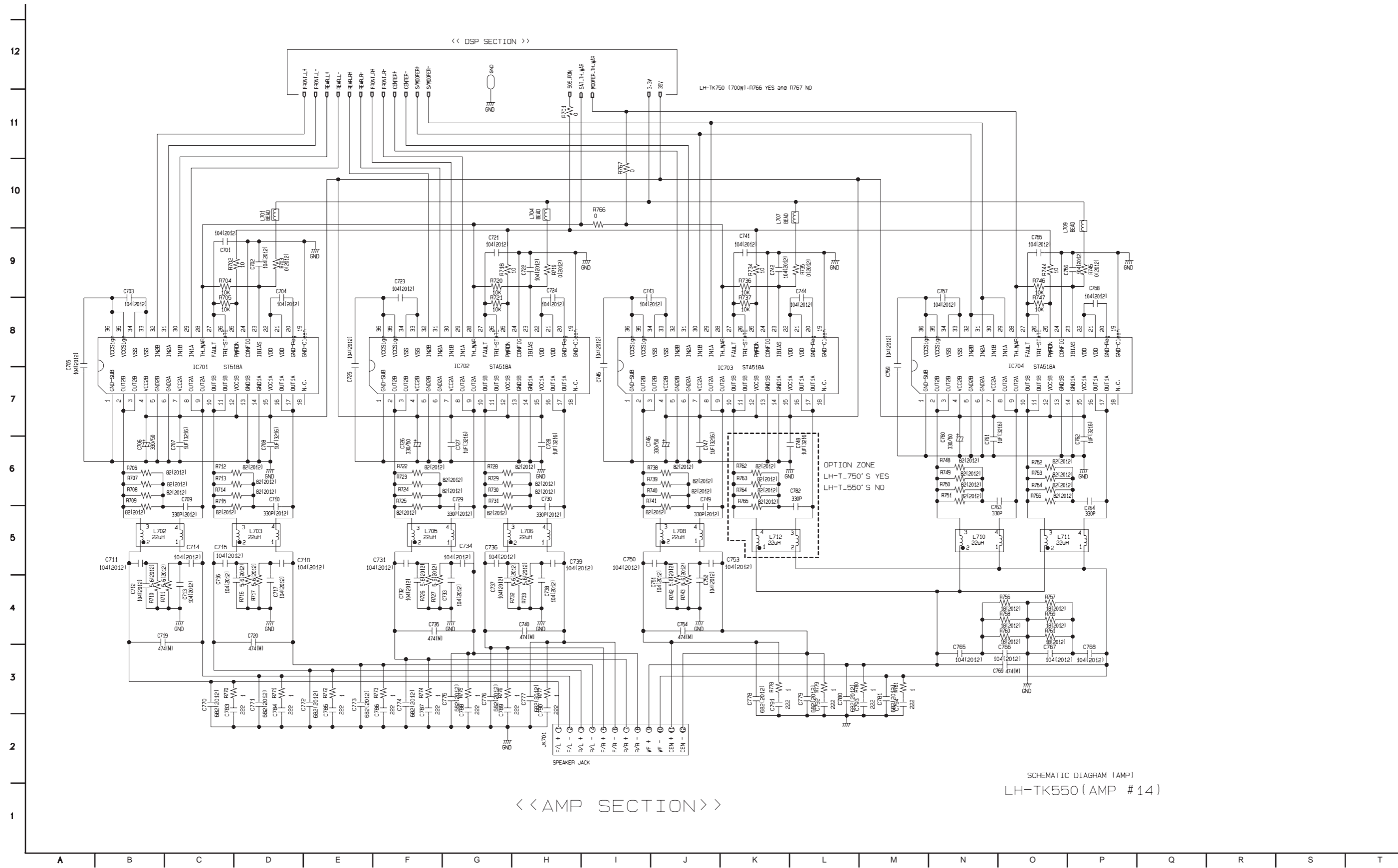

6. AMP SCHEMATIC DIAGRAM (7TOOL)

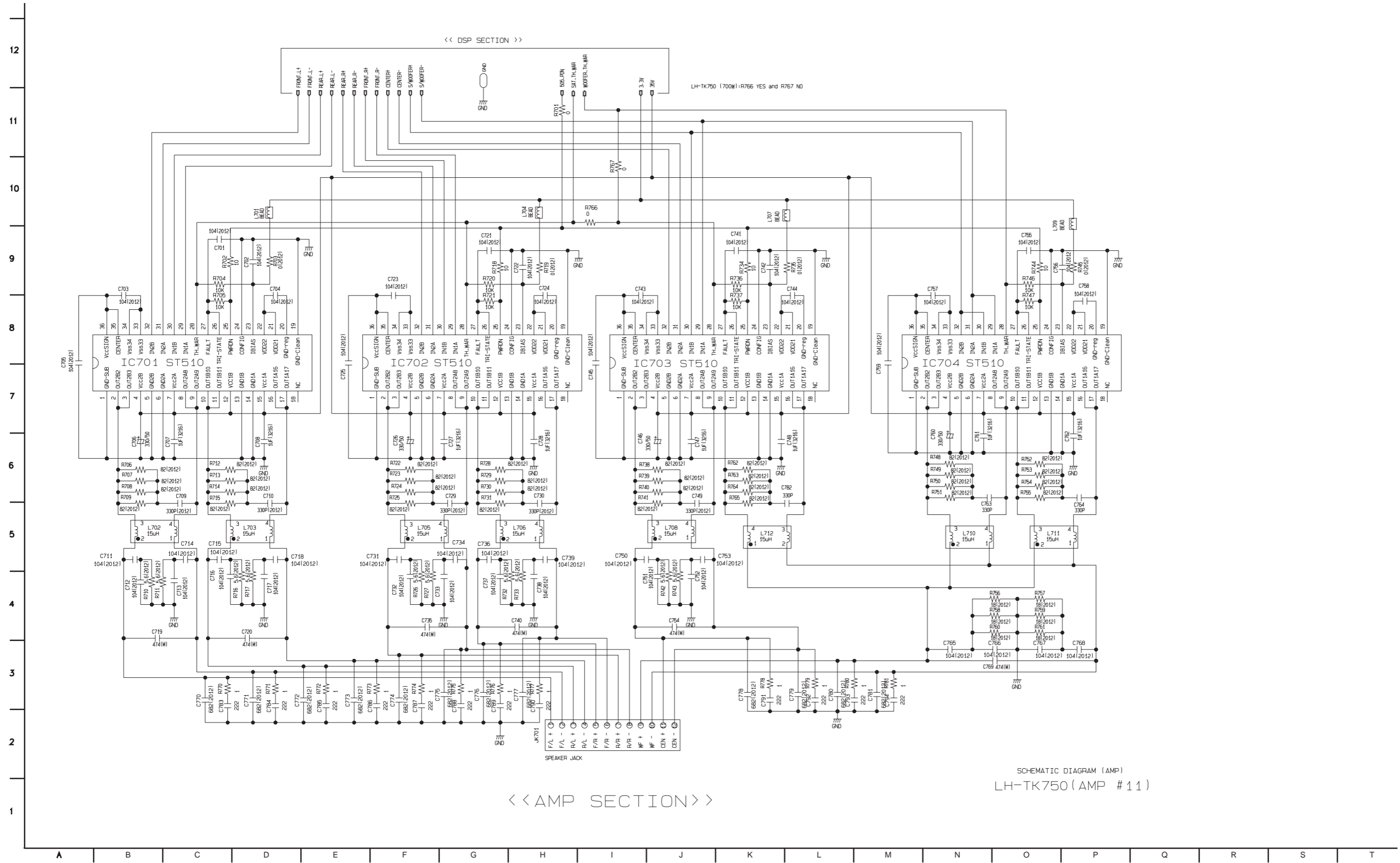

<< AMP SECTION >>

SCHEMATIC DIAGRAM (AMP)
LH-TK750 (AMP # 11)

• DECK MECHANISM EXPLODED VIEW

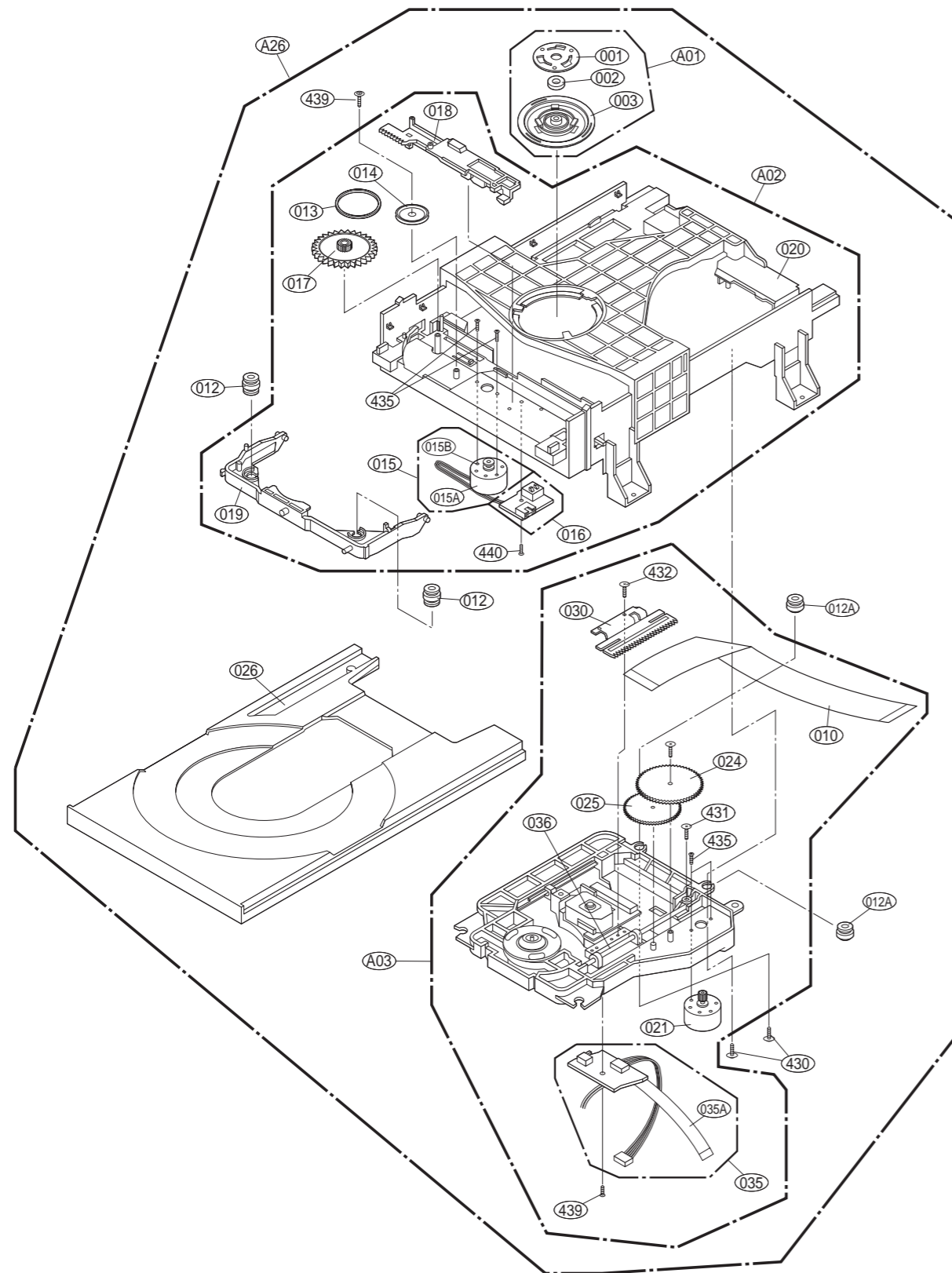

NSP : Non SVC Parts

LOCA. NO.	PART NO.	DESCRIPTION	SPECIFICATION	REMARKS
A26	6721RJ0870E	DECK ASSEMBLY,AUDIO	HOME THEATER LH-TK750/550/250	
A01	4861R-0016B	CLAMP ASSEMBLY	DISC DP7 - SH	
A02	3041R-T001A	BASE ASSEMBLY	MAIN DP-9T-ESS	
A03	3041R-T001B	BASE ASSEMBLY	SLED DP-9T-DI -ESS-SAMSUNG	
001	3300R-0547A	PLATE	CLAMP	NSP
002	5016H-1016B	MAGNET	CLAMP(LDM-R608,10*5,1*1.5T)	NSP
003	4860R-0021A	CLAMP	UPPER DP7	NSP
010	6850R-JW14B	CABLE,FLAT	P=1.0 FFC UL2896(0.035X0.7) 23	
012	5040R-0083A	RUBBER	DVD DP-6, DP-8 FRONT RIGHT 20	
012A	5040R-0110A	RUBBER	DVD REAR DP8 RIGHT 20 OTHER BL	
013	4400R-0006B	BELT	DECK/MECHA DP2-5, DP7C,DP7A OT	
014	4470R-0154A	GEAR	DECK/MECHA DP8 PULLEY MOLD	
015	4681R-A015A	MOTOR ASSEMBLY	DECK/MECHA LOADING DP-9 SH	
015A	4680R-E008A	MOTOR(MECH)	FEEDING RF-300EA-1D390 MABUCHI	NSP
015B	4560R-0008A	PULLEY	MOTOR	
016	6871R-9294A	PWB(PCB) ASSEMBLY,TOTAL	DP-9C LOADING	
017	4470R-0176A	GEAR	DVD DP-9 LOADING MOLD	
018	4974R-0067A	GUIDE	DVD DP-9C UP/DOWN MOLD	
019	3210R-M008A	FRAME	DP-9C UP/DOWN MOLD	
020	3040R-M066A	BASE	MAIN DP-9T MOLD	NSP
021	4681R-B009B	MOTOR ASSEMBLY	DECK/MECHA DP9 FEEDING	
024	4470R-0179A	GEAR	DVD DP-9 PINION MOLD	
025	4470R-0178A	GEAR	DVD DP-9 MIDDLE MOLD	
026	3390R-0033A	TRAY	DVD DP-9T(9T-SLIM) DISK MOLD	
030	4470R-0180A	GEAR	DVD DP-9 RACK MOLD	
035	6871R-9295B	PWB(PCB) ASSEMBLY,TOTAL	DP-9T FEEDING	
035A	6850R-GK22Y	CABLE,FLAT	P=1.0 FFC UL2896(0.05X0.65) 11	
036	4370R-0136A	SHAFT	DVD PU, DR-02 SUS-420J2 OTHER	
430	1SZZR-0064B	SCREW,DRAWING	+ 1 D1.7 L7.0 SWCH18A/BZN DP8	
431	1SZZR-0062A	SCREW,DRAWING	+ 1 D1.7 L4.5 SWCH18A/NI DP8 P	
432	1SZZR-0072A	SCREW,DRAWING	+ 1 D1.7 L4.5 SWRCH18A/FZY DP8	
435	1SZZR-0011A	SCREW,DRAWING	MACHINE	
439	1SZZR-0075A	SCREW,DRAWING	+ 1 D1.7 L10.0 SWRCH18A/FZW DP	
440	1SZZH-1007B	SCREW,DRAWING	+ D2.0 6MM SWRCH16A/ZNBK 4MM 1	

• Packing Accessory Section

★ OPTIONAL PART

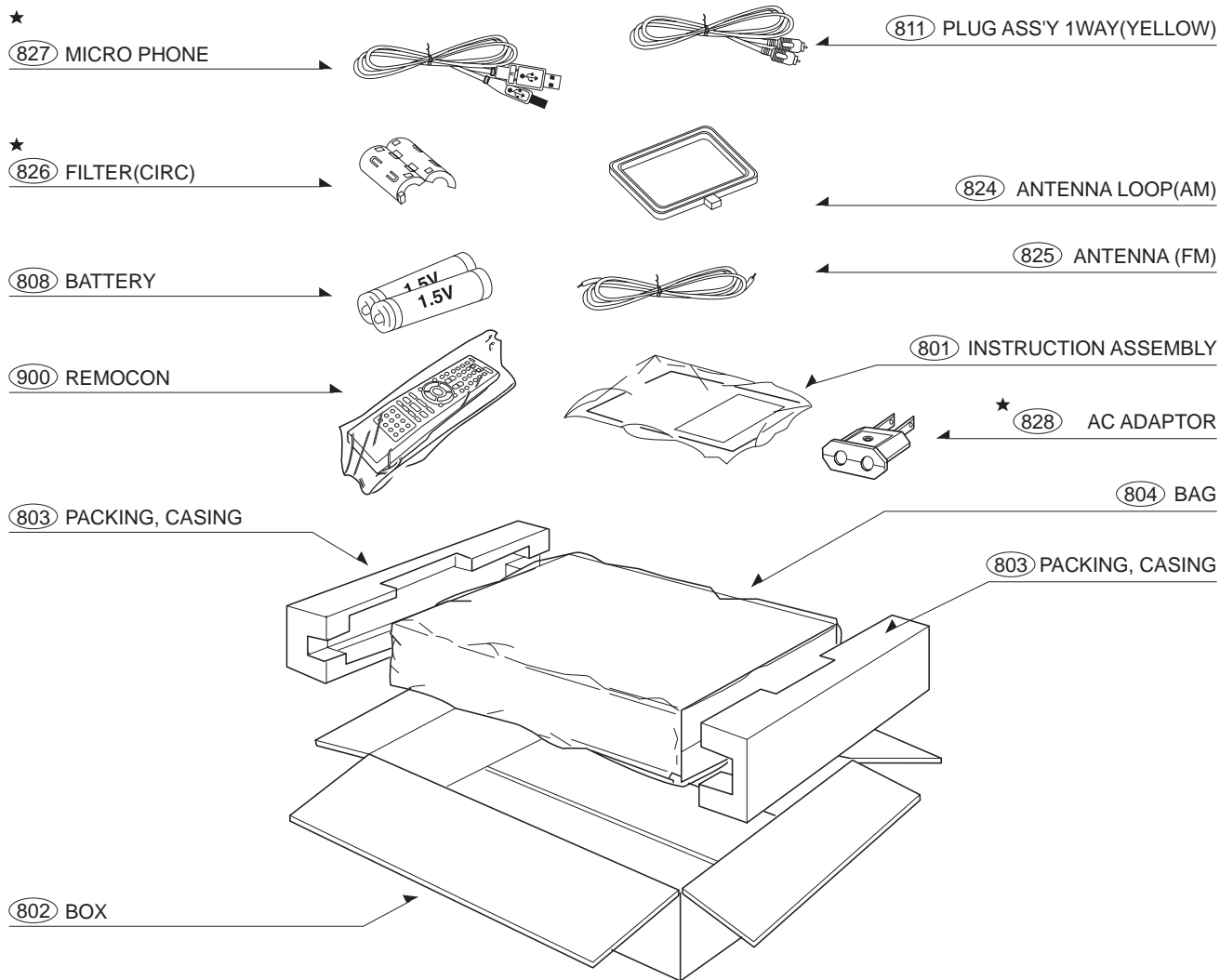

MEMO

A series of horizontal dotted lines for writing.

SECTION 5. SPEAKER SECTION

- **CENTER SPEAKER**

MODEL : LHS-55SBC

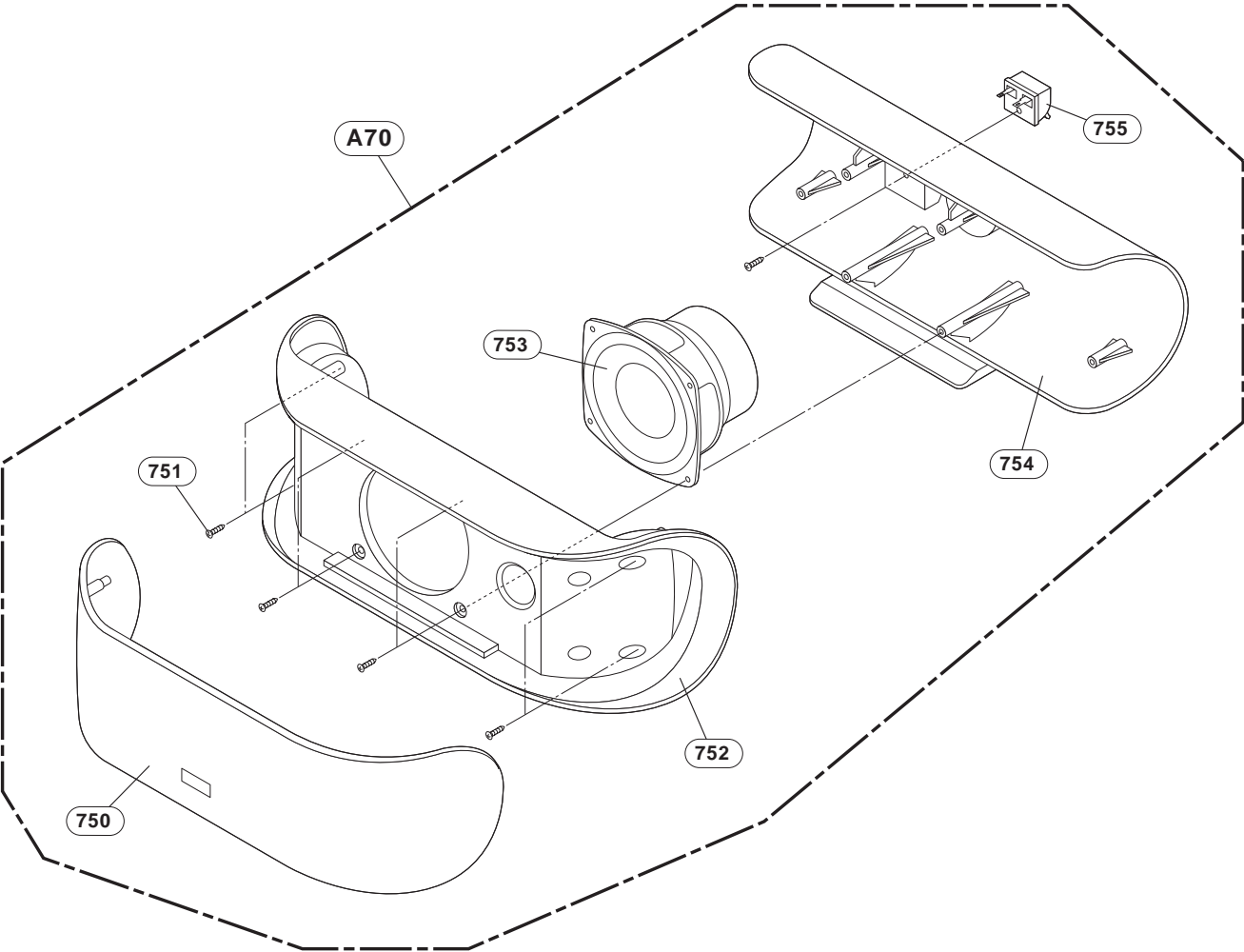

• FRONT/REAR SPEAKER

MODEL : LHS-55SBS

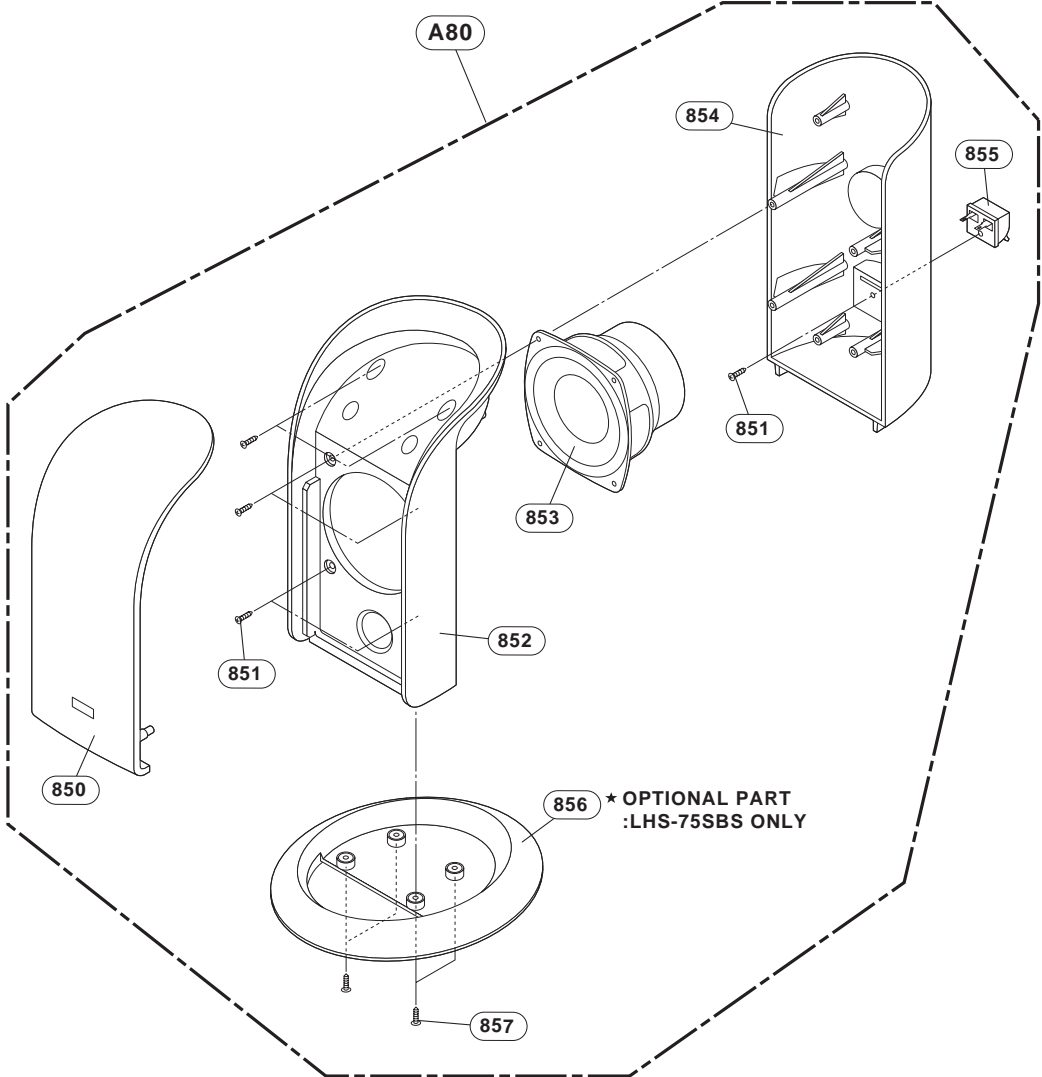

• **SUB WOOFER SPEAKER**

MODEL : LHS-55SBW

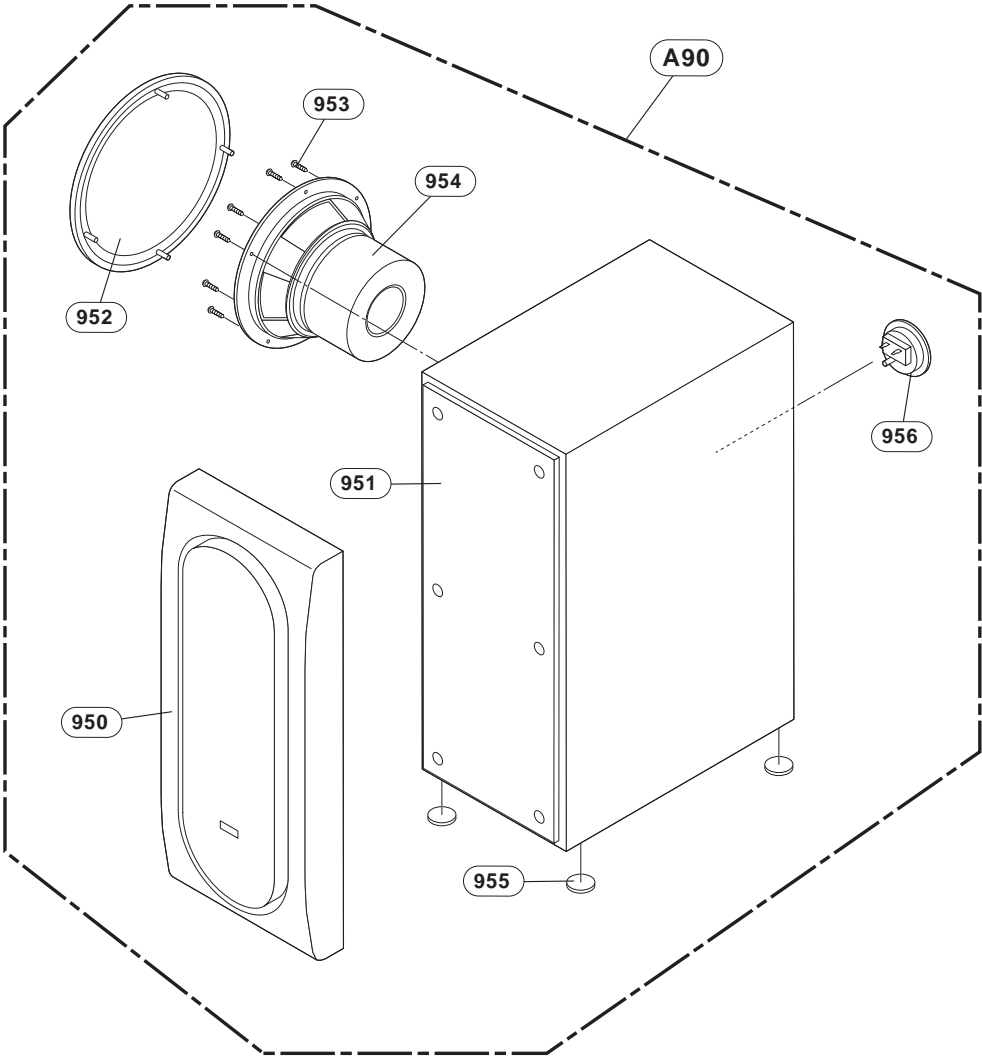

MEMO

A series of horizontal dotted lines for writing.