



SERVICE MANUAL

MODELS : XH-T5020X / XH-T5025X / LH-T5025X

# DVD/CD RECEIVER

# SERVICE MANUAL



**MODELS : XH-T5020X / XH-T5025X**  
**LH-T5025X**

# [CONTENTS]

## **SECTION 1. GENERAL**

- SERVICING PRECAUTIONS ..... 1-2
- ESD PRECAUTIONS ..... 1-4
- SERVICE INFORMATION FOR EEPROM ..... 1-5
- SPECIFICATIONS ..... 1-7

## **SECTION 2. AUDIO PART**

- AUDIO TROUBLESHOOTING GUIDE ..... 2-1
- WIRING DIAGRAM ..... 2-4
- BLOCK DIAGRAM ..... 2-6
- CIRCUIT DIAGRAMS ..... 2-8
- PRINTED CIRCUIT DIAGRAMS ..... 2-26

## **SECTION 3. DVD & AMP PART**

- ELECTRICAL TROUBLESHOOTING GUIDE ..... 3-1
- AMP CIRCUIT DIAGRAMS ..... 3-23
- PRINTED CIRCUIT DIAGRAMS ..... 3-29

## **SECTION 4. EXPLODED VIEWS ..... 4-1**

## **SECTION 5. SPEAKER PART ..... 5-1**

## **SECTION 6. REPLACEMENT PARTS LIST ..... 6-1**

# SECTION 1. GENERAL

## SERVICING PRECAUTIONS

### NOTES REGARDING HANDLING OF THE PICK-UP

#### 1. Notes for transport and storage

- 1) The pick-up should always be left in its conductive bag until immediately prior to use.
- 2) The pick-up should never be subjected to external pressure or impact.

Storage in conductive bag

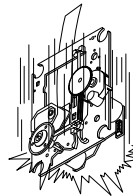
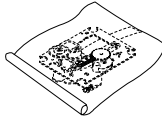

Drop impact

#### 2. Repair notes

- 1) The pick-up incorporates a strong magnet, and so should never be brought close to magnetic materials.
- 2) The pick-up should always be handled correctly and carefully, taking care to avoid external pressure and impact. If it is subjected to strong pressure or impact, the result may be an operational malfunction and/or damage to the printed-circuit board.
- 3) Each and every pick-up is already individually adjusted to a high degree of precision, and for that reason the adjustment point and installation screws should absolutely never be touched.
- 4) Laser beams may damage the eyes!  
Absolutely never permit laser beams to enter the eyes!  
Also NEVER switch ON the power to the laser output part (lens, etc.) of the pick-up if it is damaged.

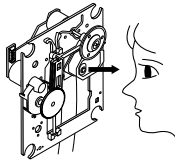

NEVER look directly at the laser beam, and don't allow contact fingers or other exposed skin.

#### 5) Cleaning the lens surface

If there is dust on the lens surface, the dust should be cleaned away by using an air bush (such as used for camera lens). The lens is held by a delicate spring. When cleaning the lens surface, therefore, a cotton swab should be used, taking care not to distort this.

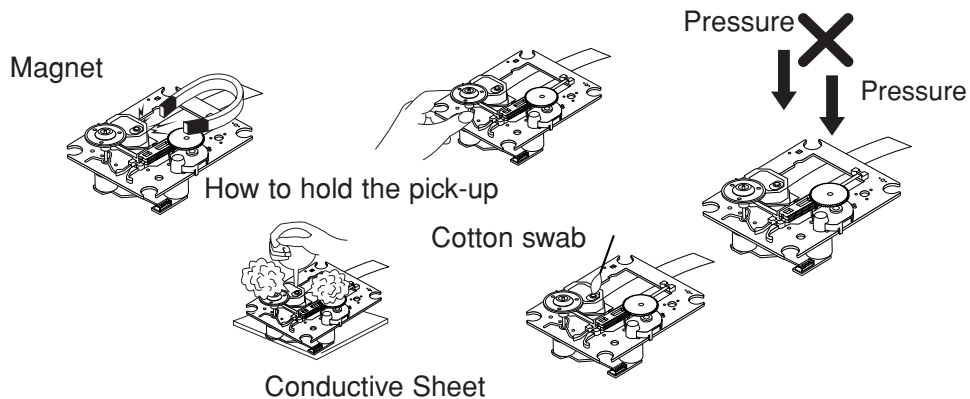

#### 6) Never attempt to disassemble the pick-up.

Spring by excess pressure. If the lens is extremely dirty, apply isopropyl alcohol to the cotton swab. (Do not use any other liquid cleaners, because they will damage the lens.) Take care not to use too much of this alcohol on the swab, and do not allow the alcohol to get inside the pick-up.

# NOTES REGARDING COMPACT DISC PLAYER REPAIRS

## 1. Preparations

- 1) Compact disc players incorporate a great many ICs as well as the pick-up (laser diode). These components are sensitive to, and easily affected by, static electricity. If such static electricity is high voltage, components can be damaged, and for that reason components should be handled with care.
- 2) The pick-up is composed of many optical components and other high-precision components. Care must be taken, therefore, to avoid repair or storage where the temperature or humidity is high, where strong magnetism is present, or where there is excessive dust.

## 2. Notes for repair

- 1) Before replacing a component part, first disconnect the power supply lead wire from the unit
- 2) All equipment, measuring instruments and tools must be grounded.
- 3) The workbench should be covered with a conductive sheet and grounded.  
When removing the laser pick-up from its conductive bag, do not place the pick-up on the bag. (This is because there is the possibility of damage by static electricity.)
- 4) To prevent AC leakage, the metal part of the soldering iron should be grounded.
- 5) Workers should be grounded by an armband (1M  $\Omega$ )
- 6) Care should be taken not to permit the laser pick-up to come in contact with clothing, in order to prevent static electricity changes in the clothing to escape from the armband.
- 7) The laser beam from the pick-up should NEVER be directly facing the eyes or bare skin.

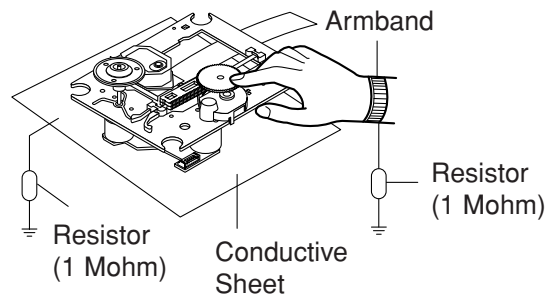



# ESD PRECAUTIONS

## Electrostatically Sensitive Devices (ESD)



Some semiconductor (solid state) devices can be damaged easily by static electricity. Such components commonly are called Electrostatically Sensitive Devices (ESD). Examples of typical ESD devices are integrated circuits and some field-effect transistors and semiconductor chip components. The following techniques should be used to help reduce the incidence of component damage caused by static electricity.

1. Immediately before handling any semiconductor component or semiconductor-equipped assembly, drain off any electrostatic charge on your body by touching a known earth ground. Alternatively, obtain and wear a commercially available discharging wrist strap device, which should be removed for potential shock reasons prior to applying power to the unit under test.
2. After removing an electrical assembly equipped with ESD devices, place the assembly on a conductive surface such as aluminum foil, to prevent electrostatic charge buildup or exposure of the assembly.
3. Use only a grounded-tip soldering iron to solder or unsolder ESD devices.
4. Use only an anti-static solder removal device. Some solder removal devices not classified as "anti-static" can generate electrical charges sufficient to damage ESD devices.
5. Do not use freon-propelled chemicals. These can generate electrical charges sufficient to damage ESD devices.
6. Do not remove a replacement ESD device from its protective package until immediately before you are ready to install it. (Most replacement ESD devices are packaged with leads electrically shorted together by conductive foam, aluminum foil or comparable conductive materials).
7. Immediately before removing the protective material from the leads of a replacement ESD device, touch the protective material to the chassis or circuit assembly into which the device will be installed.

**CAUTION : BE SURE NO POWER IS APPLIED TO THE CHASSIS OR CIRCUIT, AND OBSERVE ALL OTHER SAFETY PRECAUTIONS.**

8. Minimize bodily motions when handling unpackaged replacement ESD devices. (Otherwise harmless motion such as the brushing together of your clothes fabric or the lifting of your foot from a carpeted floor can generate static electricity sufficient to damage an ESD device).

## CAUTION. GRAPHIC SYMBOLS

	THE LIGHTNING FLASH WITH APROWHEAD SYMBOL. WITHIN AN EQUILATERAL TRIANGLE, IS INTENDED TO ALERT THE SERVICE PERSONNEL TO THE PRESENCE OF UNINSULATED "DANGEROUS VOLTAGE" THAT MAY BE OF SUFFICIENT MAGNITUDE TO CONSTITUTE A RISK OF ELECTRIC SHOCK.
	THE EXCLAMATION POINT WITHIN AN EQUILATERAL TRIANGLE IS INTENDED TO ALERT THE SERVICE PERSONNEL TO THE PRESENCE OF IMPORTANT SAFETY INFORMATION IN SERVICE LITERATURE.

# SERVICE INFORMATION FOR EEPROM(DVD PART)

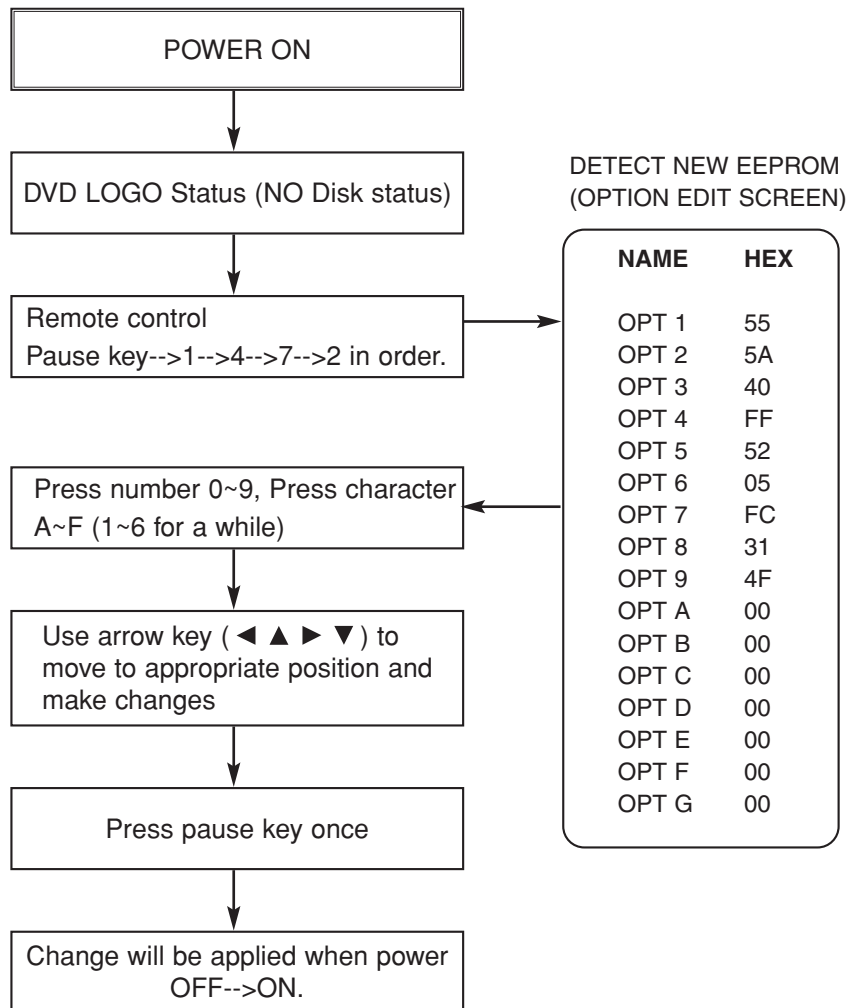

# SERVICE INFORMATION FOR EEPROM(AMP PART)

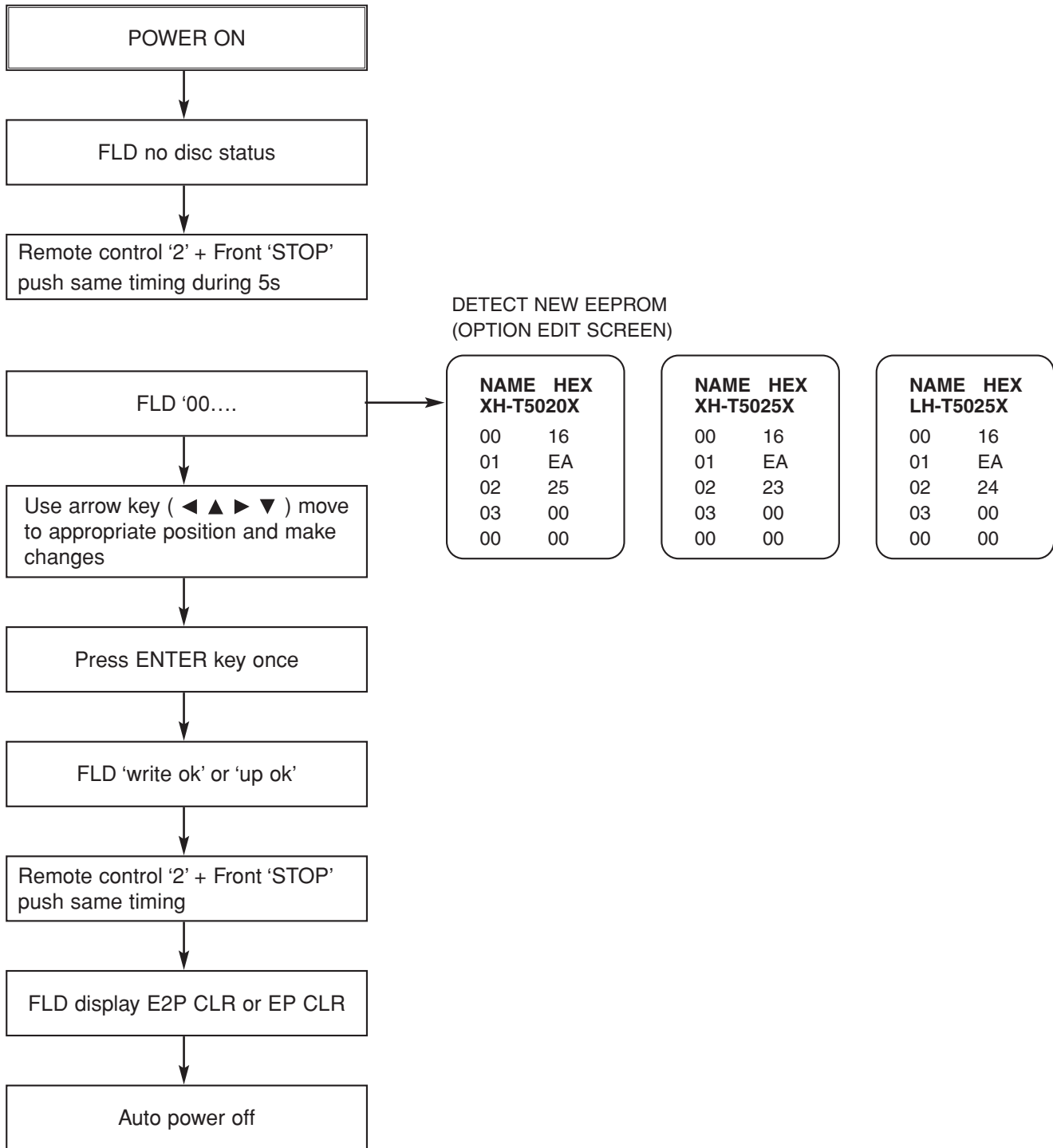

# SPECIFICATIONS

## GENERAL

Power supply	Refer to main label.
Power consumption	Refer to main label.
Net Weight	3.6 kg
External dimensions (W x H x D)	430 x 70 x 311 mm
Operating conditions	Temperature: 5°C to 35°C, Operation status: Horizontal
Operating humidity	5% to 85%
Laser	Semiconductor laser, wavelength 650 nm

## CD/DVD

Signal system	PAL 625/50, NTSC 525/60
Frequency response (audio)	200 Hz to 18 kHz
Signal-to-noise ratio (audio)	More than 75 dB (1 kHz, NOP -6 dB, 20 kHz LPF/A-Filter)
Dynamic range (audio)	More than 70 dB
Harmonic distortion (audio)	0.5 % (1 kHz, at 1W position) (20 kHz LPF)

## VIDEO

Video input	1.0 V (p-p), 75 Ω, negative sync., RCA jack x 1
Video output	1.0 V (p-p), 75 Ω, negative sync., RCA jack x 1/SCART (TO TV)
COMPONENT VIDEO OUT	(Y) 1.0 V (p-p), 75 ohms, negative sync, RCA jack x 1 (PB)/(PR) 0.7 V (p-p), 75 ohms, RCA jack x 1

## TUNER

### FM

Tuning Range	87.5 - 108.0 MHz or 65.0 - 74.0 MHz, 87.5 - 108.0 MHz
Intermediate Frequency	10.7 MHz
Signal-to Noise Ratio	60 dB (Mono)
Frequency Response	140 - 8,000 Hz

### AM [MW]

Tuning Range	522 - 1,620 kHz or 520 - 1,720 kHz
Intermediate Frequency	450 kHz

## AMPLIFIER

Stereo mode	70 W + 70 W (4Ω at 1 kHz, THD 10 %)
Surround mode	Front: 70 W + 70 W (THD 10 %) Center*: 70 W Surround*: 70 W + 70 W (4Ω at 1 kHz, THD 10 %) Subwoofer*: 150 W (3Ω at 30 Hz, THD 10 %)
(* Depending on the sound mode settings and the source, there may be no sound output.)	
Inputs	AUDIO IN, OPTICAL IN
Outputs	MONITOR OUT, EURO AV (TO TV) OUT, COMPONENT VIDEO OUT

## SPEAKERS (SH52PH)

	Front Speaker (SH52PH-F)	Center speaker (SH52PH-C)	Rear Speaker (SH52PH-S)	Passive Subwoofer (SH52PH-W)
Type	2 Way 3 Speaker	2 Way 3 Speaker	1 Way 1 Speaker	1 Way 1 Speaker
Impedance	4Ω	4Ω	4Ω	3Ω
Frequency Response	100 - 20000 Hz	150 - 20000 Hz	130 - 20000 Hz	40 - 1500 Hz
Sound Pressure Level	82 dB/W (1m)	82 dB/W (1m)	82 dB/W (1m)	80 dB/W (1m)
Rated Input Power	70 W	70 W	70 W	150 W
Max. Input Power	140 W	140 W	140 W	300 W
Net Dimensions (W x H x D)	260 x 1100 x 260 mm	330 x 86 x 121 mm	114 x 208.5 x 83 mm	212 x 395 x 341 mm
Net Weight	3.0 kg	1.15 kg	0.55 kg	6.0 kg

**SPEAKERS (SH52TH)**

	Front Speaker (SH52TH-F)	Center speaker (SH52TH-C)	Rear Speaker (SH52TH-S)	Passive Subwoofer (SH52TH-W)
Type	2 Way 3 Speaker	2 Way 3 Speaker	2 Way 3 Speaker	1 Way 1 Speaker
Impedance	4Ω	4Ω	4Ω	3Ω
Frequency Response	100 - 20000 Hz	150 - 20000 Hz	130 - 20000 Hz	40 - 1500 Hz
Sound Pressure Level	82 dB/W (1m)	82 dB/W (1m)	82 dB/W (1m)	80 dB/W (1m)
Rated Input Power	70 W	70 W	70 W	150 W
Max. Input Power	140 W	140 W	140 W	300 W
Net Dimensions (W x H x D)	260 x 1100 x 260 mm	330 x 86 x 121 mm	260 x 1100 x 260 mm	212 x 395 x 341 mm
Net Weight	3.0 kg	1.15 kg	0.55 kg	6.0 kg

**SPEAKERS (SH52SH)**

	Front/Rear Speaker (SH52SH-S)	Center speaker (SH52SH-C)	Passive Subwoofer (SH52SH-W)
Type	1 Way 1 Speaker	1 Way 2 Speaker	1 Way 1 Speaker
Impedance	4 Ω	4 Ω	3 Ω
Frequency Response	130 - 20000 Hz	130 - 20000 Hz	40 - 1500 Hz
Sound Pressure Level	82 dB/W (1m)	82 dB/W (1m)	80 dB/W (1m)
Rated Input Power	70 W	70 W	150 W
Max. Input Power	140 W	140 W	300 W
Net Dimensions (W x H x D)	114 x 208.5 x 83 mm	330 x 86 x 121 mm	212 x 395 x 341 mm
Net Weight	0.55 kg	1.15 kg	6.0 kg

# SECTION 2. AUDIO PART

## AUDIO TROUBLESHOOTING GUIDE

### 1. POWER SUPPLY CIRCUIT

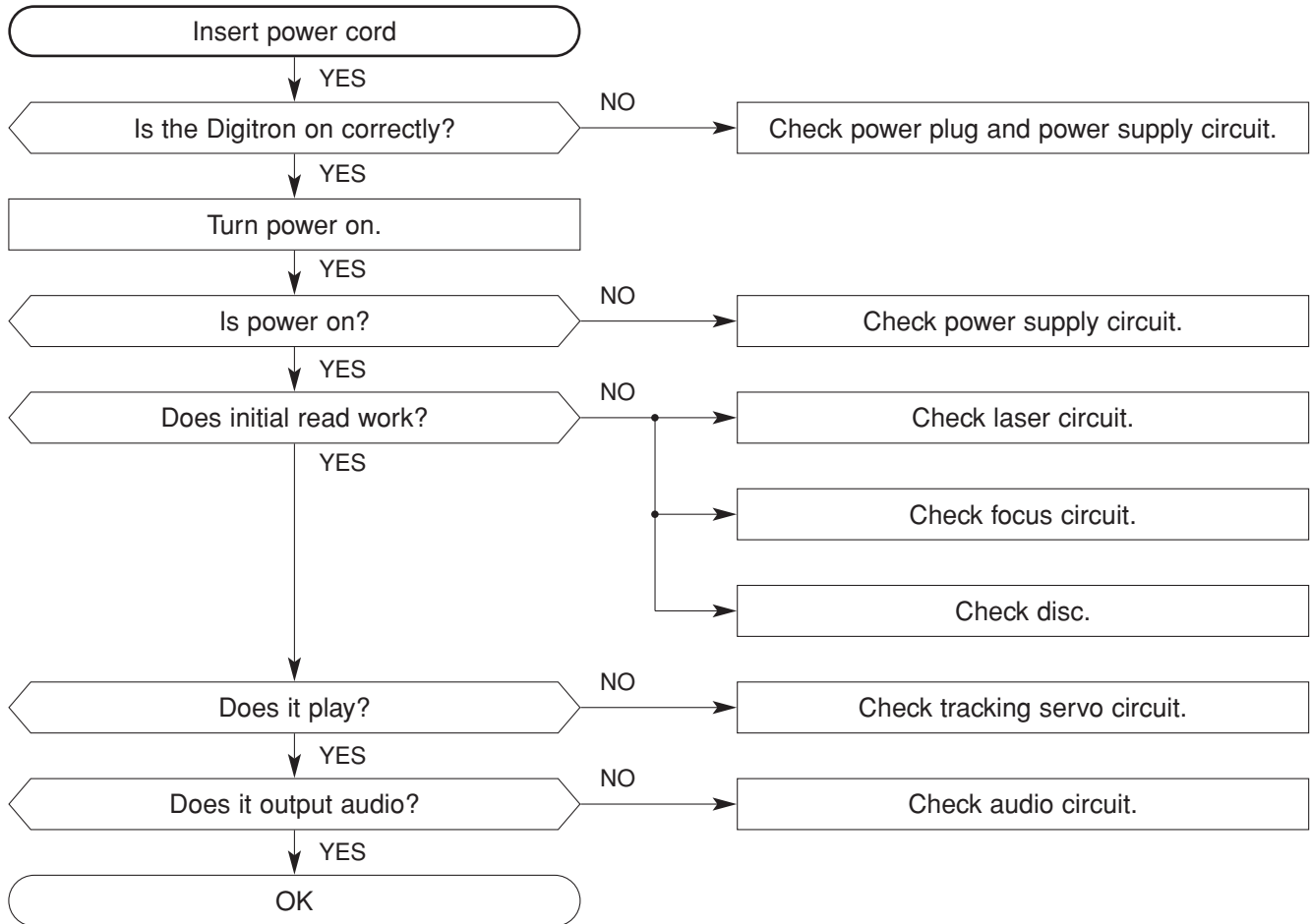

## 2. FRONT CIRCUIT (1/2)

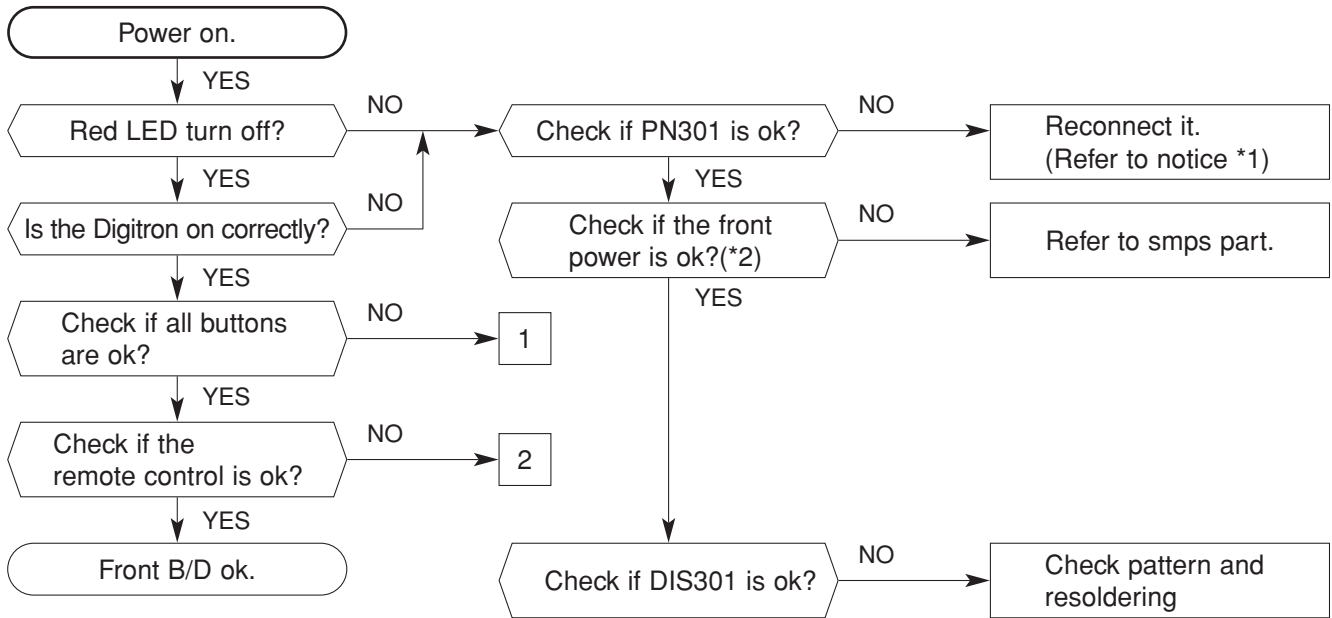

\*1 : When it is needed to reconnected FFC cable into PN301  
Short 1pin of PN103 with 18pin of CN901 in amp part

\*2 : PN603 Pins.  
PIN1 : -35 VKK  
PIN2 : -30 FL+  
PIN3 : -33 FL-  
PIN7 : +5V  
PIN13 : +5VA

### 3. FRONT CIRCUIT (2/2)

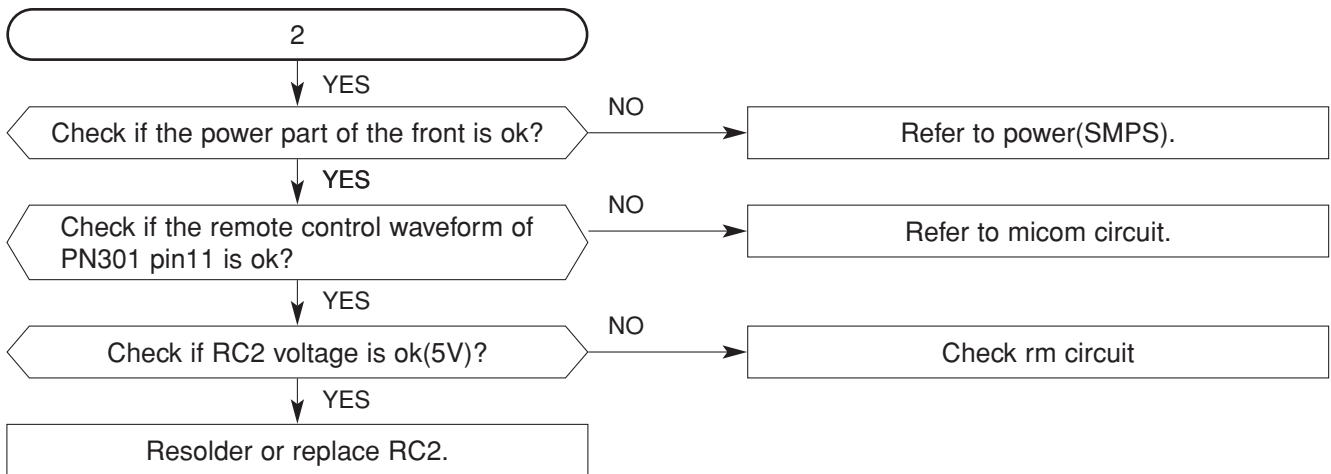
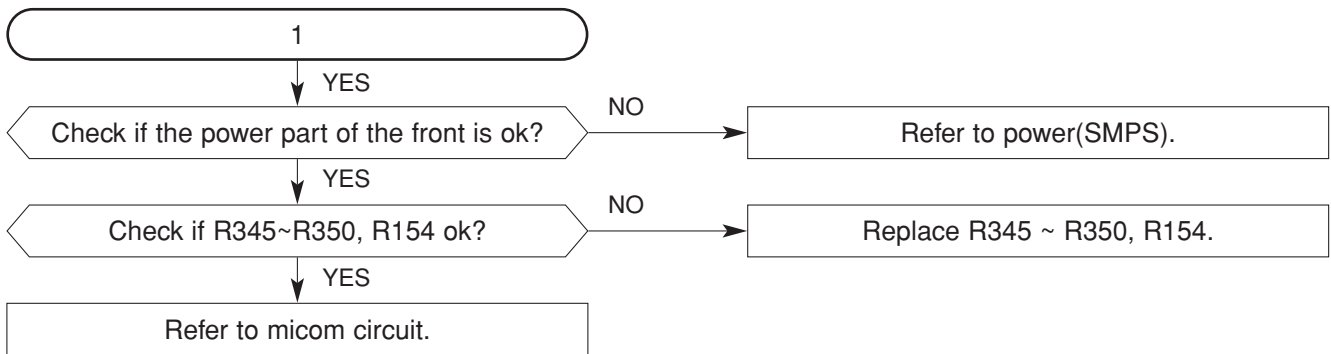





# WIRING DIAGRAM

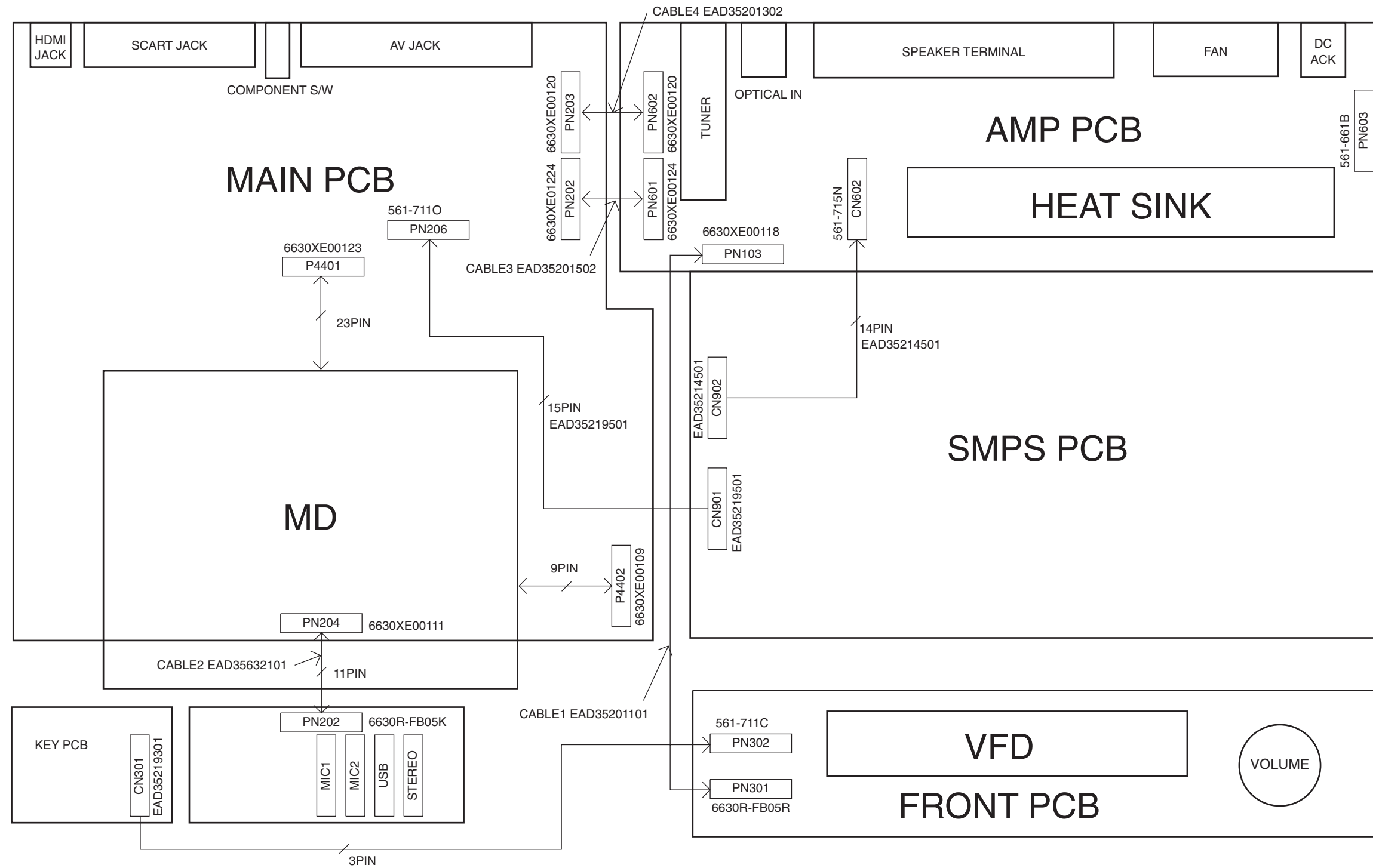

# BLOCK DIAGRAM

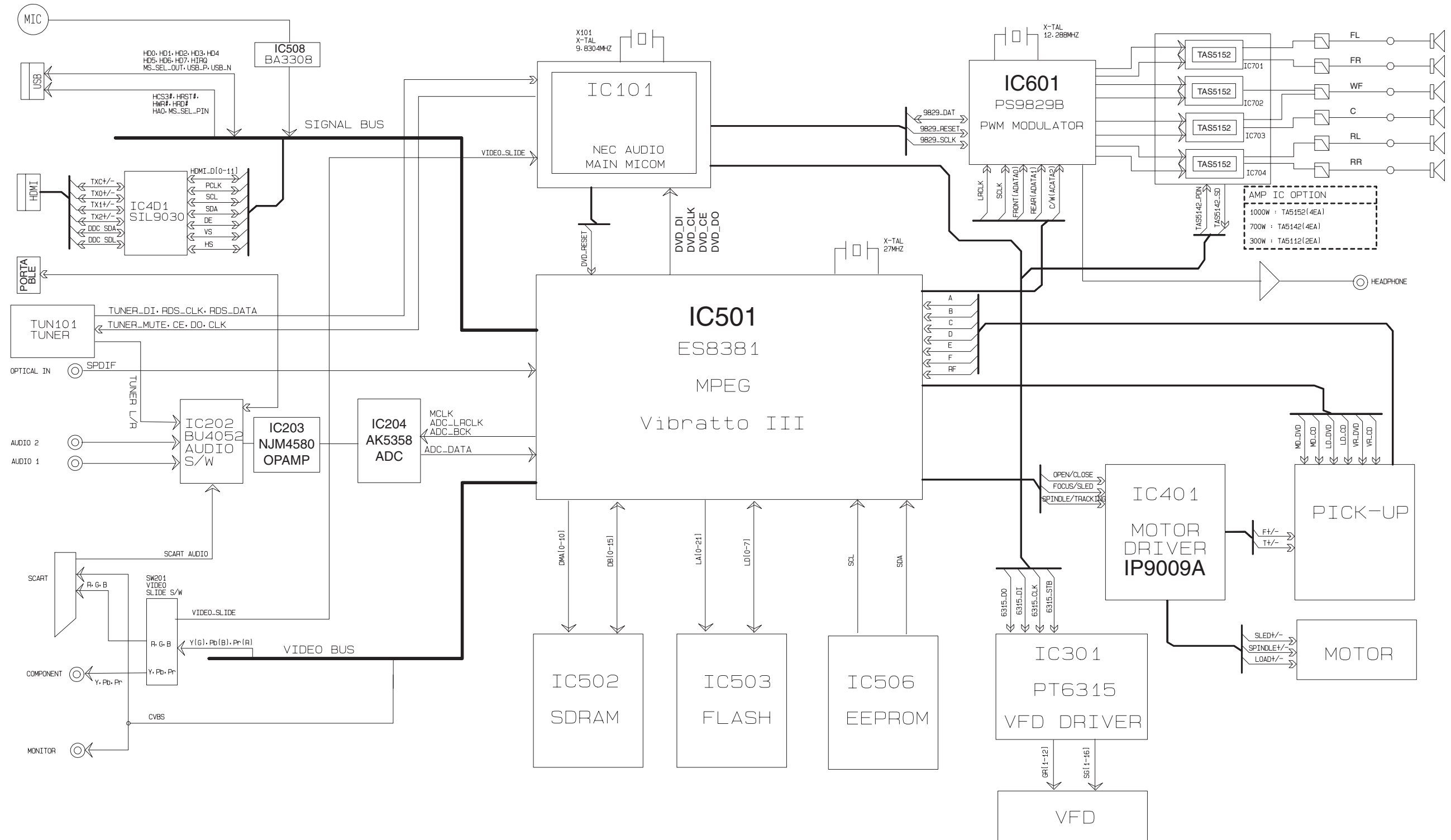

# CIRCUIT DIAGRAMS

## 1. SMPS(POWER) CIRCUIT DIAGRAM

### IMPORTANT SAFETY NOTICE

WHEN SERVICING THIS CHASSIS, UNDER NO CIRCUMSTANCES SHOULD THE ORIGINAL DESIGN BE MODIFIED OR ALTERED WITHOUT PERMISSION FROM THE LG CORPORATION. ALL COMPONENTS SHOULD BE REPLACED ONLY WITH TYPES IDENTICAL TO THOSE IN THE ORIGINAL CIRCUIT. SPECIAL

COMPONENTS ARE SHADED ON THE SCHEMATIC FOR EASY IDENTIFICATION.

THIS CIRCUIT DIAGRAM MAY OCCASIONALLY DIFFER FROM THE ACTUAL CIRCUIT USED. THIS WAY, IMPLEMENTATION OF THE LATEST SAFETY AND PERFORMANCE IMPROVEMENT CHANGES INTO THE SET IS NOT DELAYED UNTIL THE NEW SERVICE LITERATURE IS PRINTED.

### NOTE :

1. Shaded(■) parts are critical for safety. Replace only with specified part number.
2. Voltages are DC-measured with a digital voltmeter during Play mode.

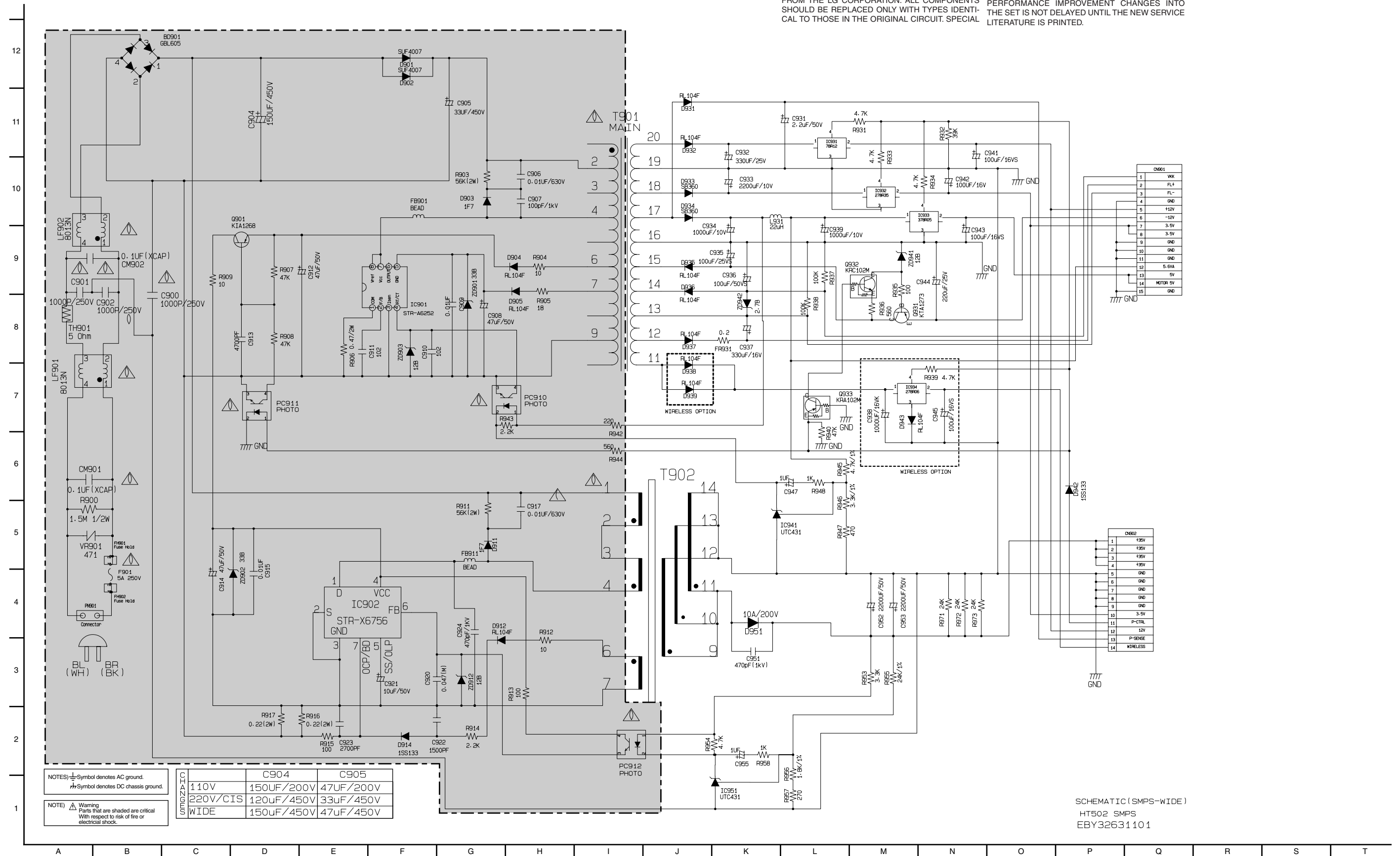

## 2. POWER INTERFACE CIRCUIT DIAGRAM

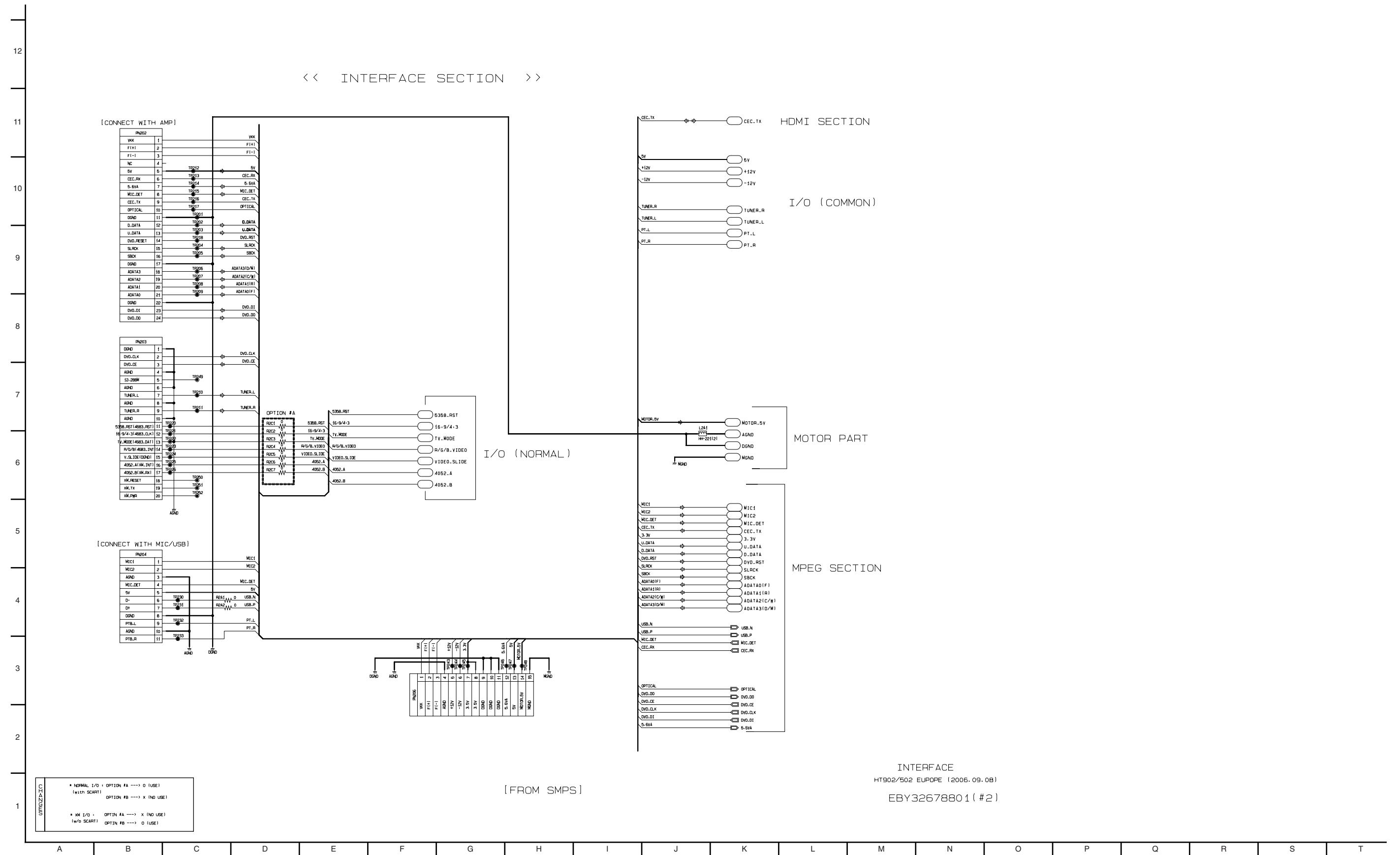

### 3. MPEG CIRCUIT DIAGRAM

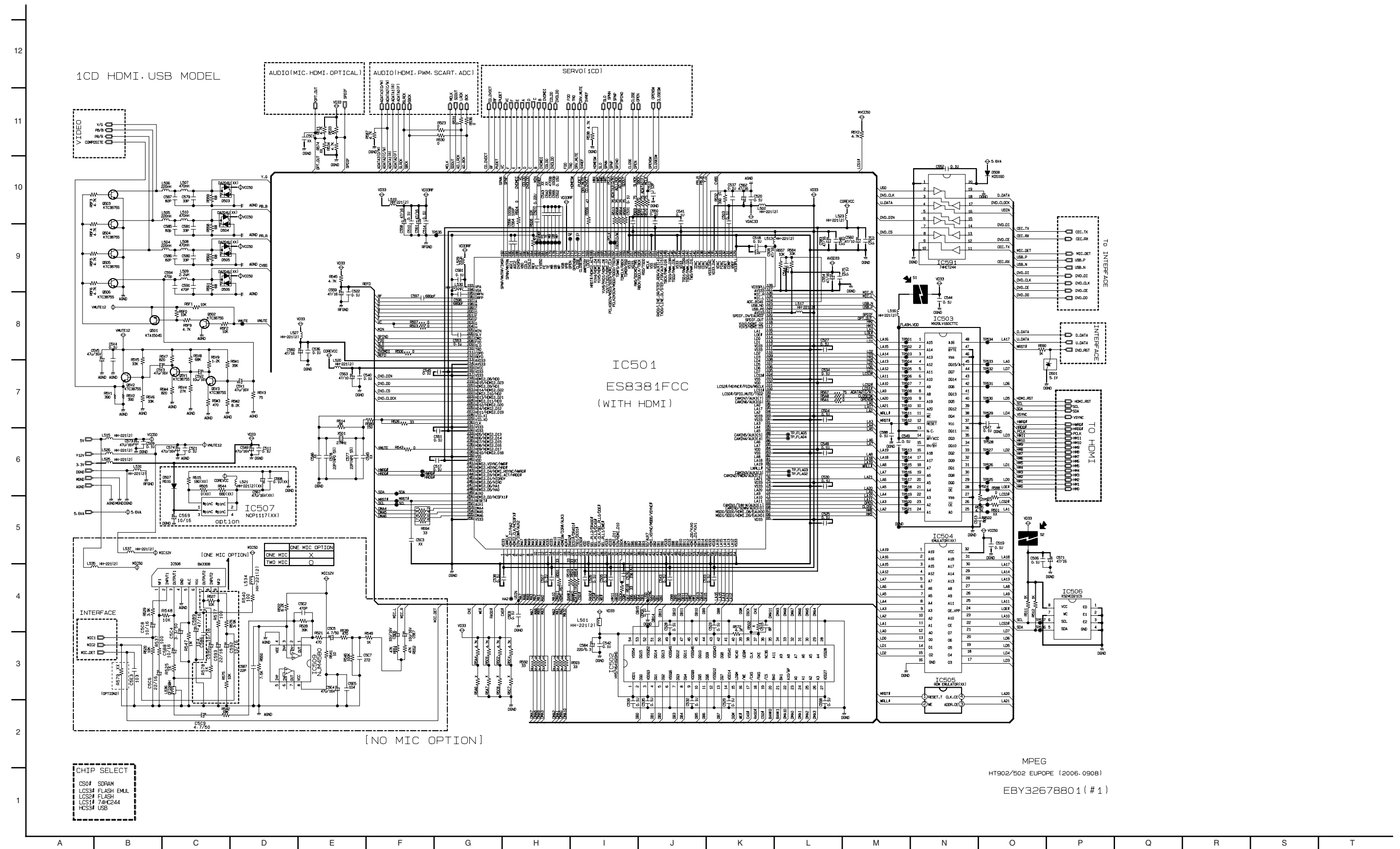

# 4. SERVO CIRCUIT DIAGRAM

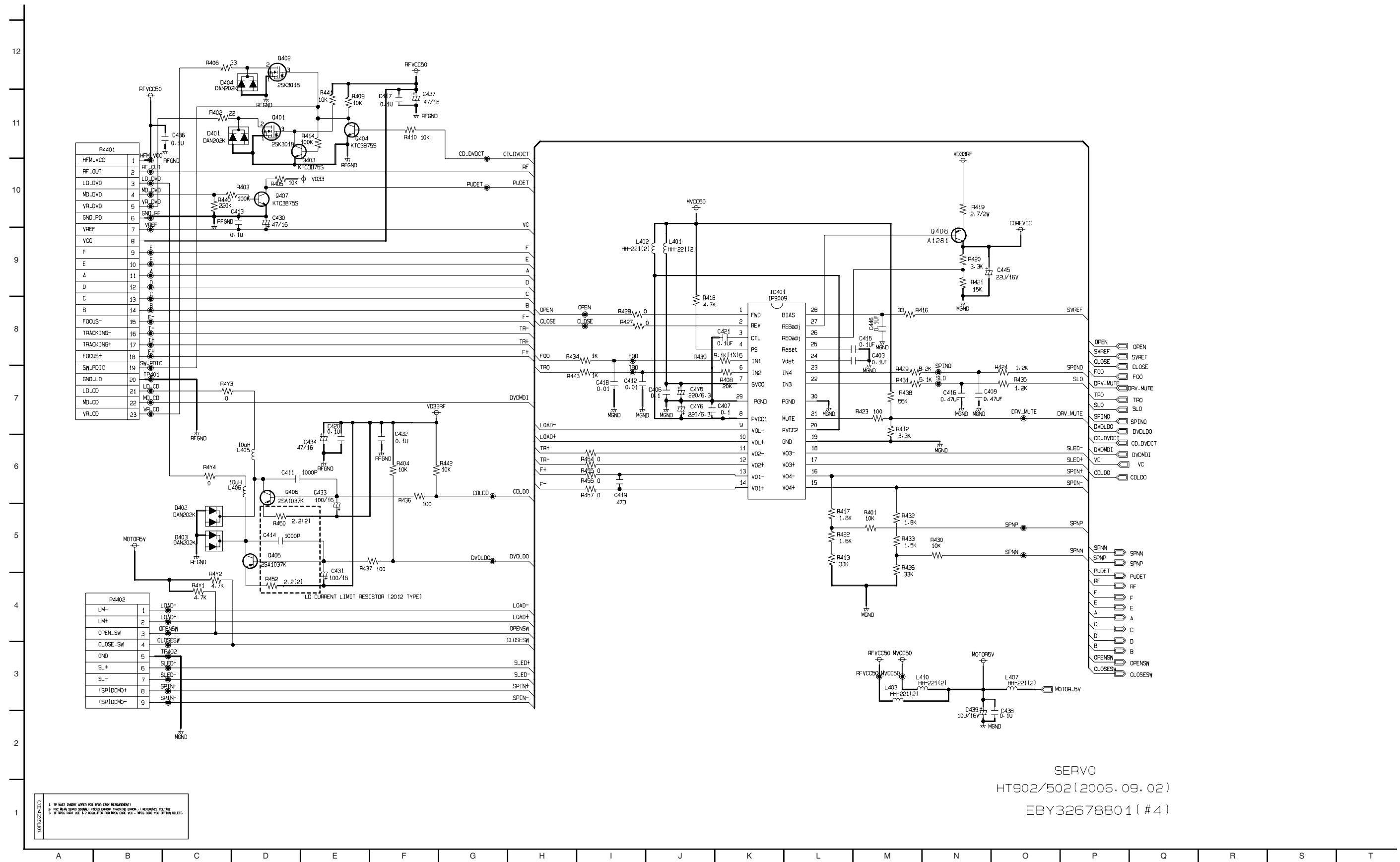

SERVO  
HT902/502 (2006.09.02)  
EBY32678801 (#4)

1. TO MEET PRESET OPEN FOR EASY MEASUREMENT  
2. FOR NEAR ZERO SIGNAL, FOCUS ERROR, TRACKING ERROR, A REFERENCE VOLTAGE  
3. IF WIRE PART USE 1.0 RESISTOR FOR WIRE CORE VCC - WIRE CORE VCC OPTION DELETE.

# 5. I/O CIRCUIT DIAGRAM

<< I/O SECTION >>

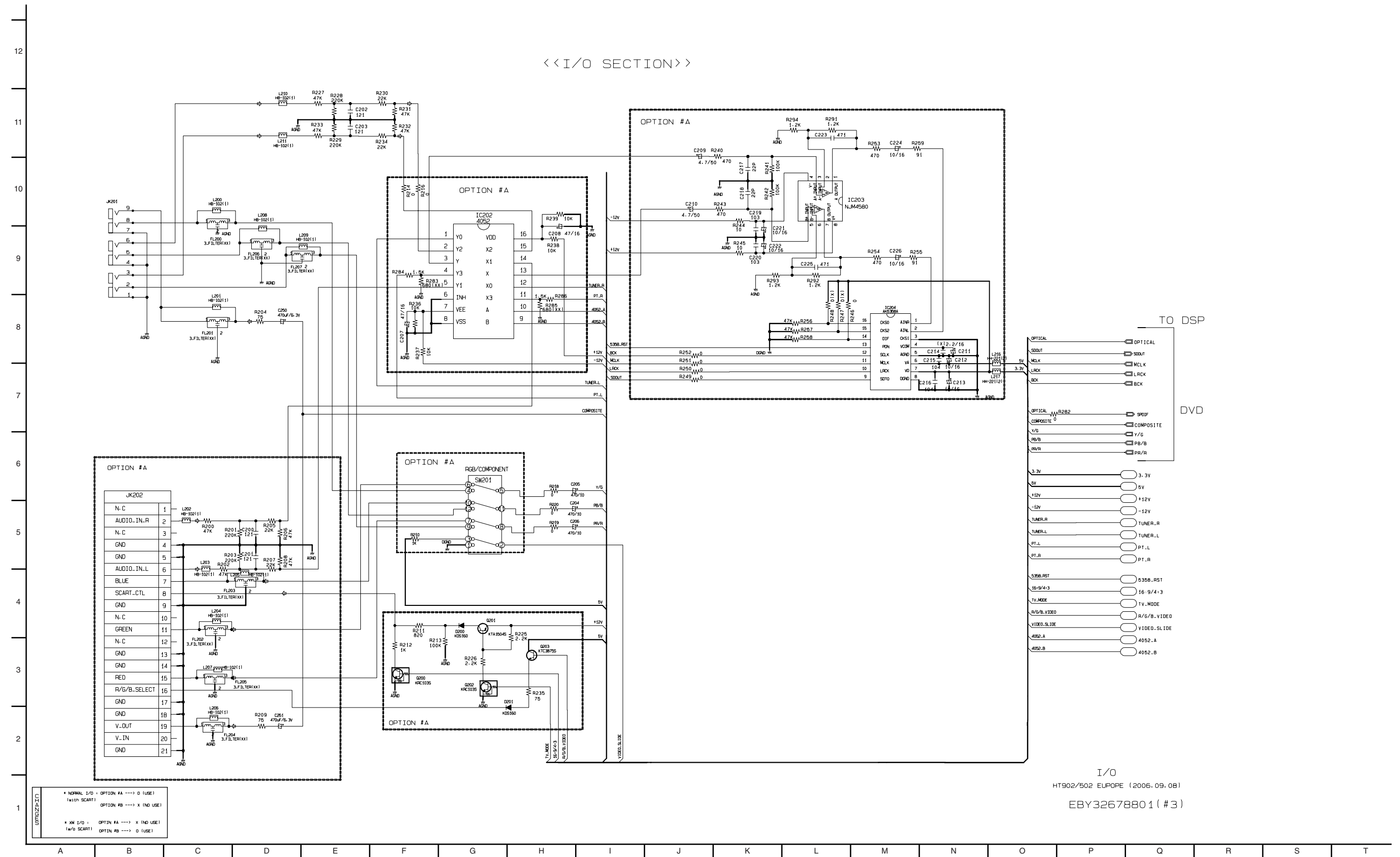

I/O  
HT902/502 EUROPE (2006.09.08)  
EBY32678801 (#3)



# 6. MIC & USB & PTB CIRCUIT DIAGRAM

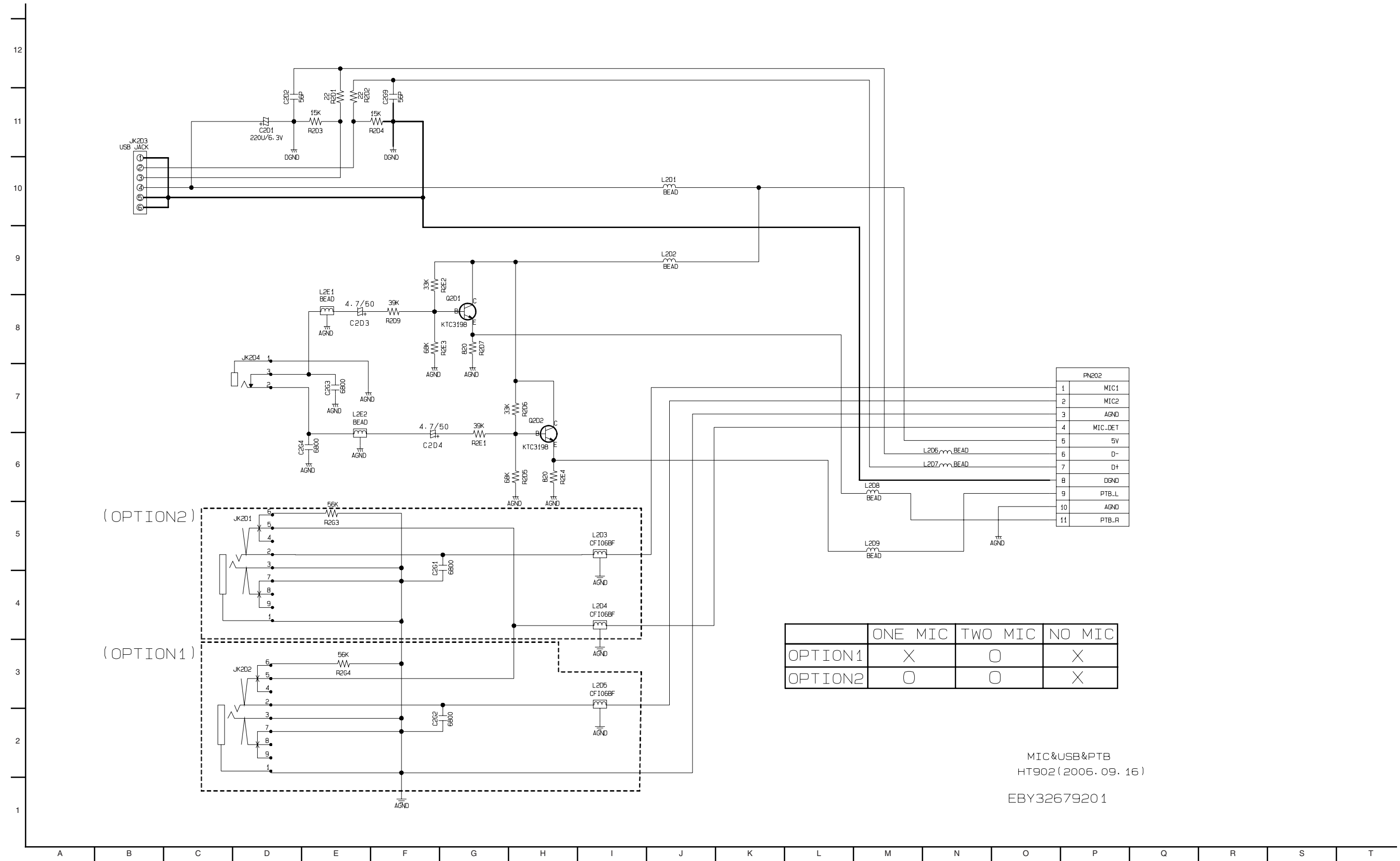

PN202	
1	MIC1
2	MIC2
3	AGND
4	MIC_DET
5	5V
6	D-
7	D+
8	DGND
9	PTB.L
10	AGND
11	PTB.R

	ONE MIC	TWO MIC	NO MIC
OPTION1	X	O	X
OPTION2	O	O	X

MIC&USB&PTB  
HT902 ( 2006. 09. 16 )  
EBY32679201

## 7. POWER KEY CIRCUIT DIAGRAM

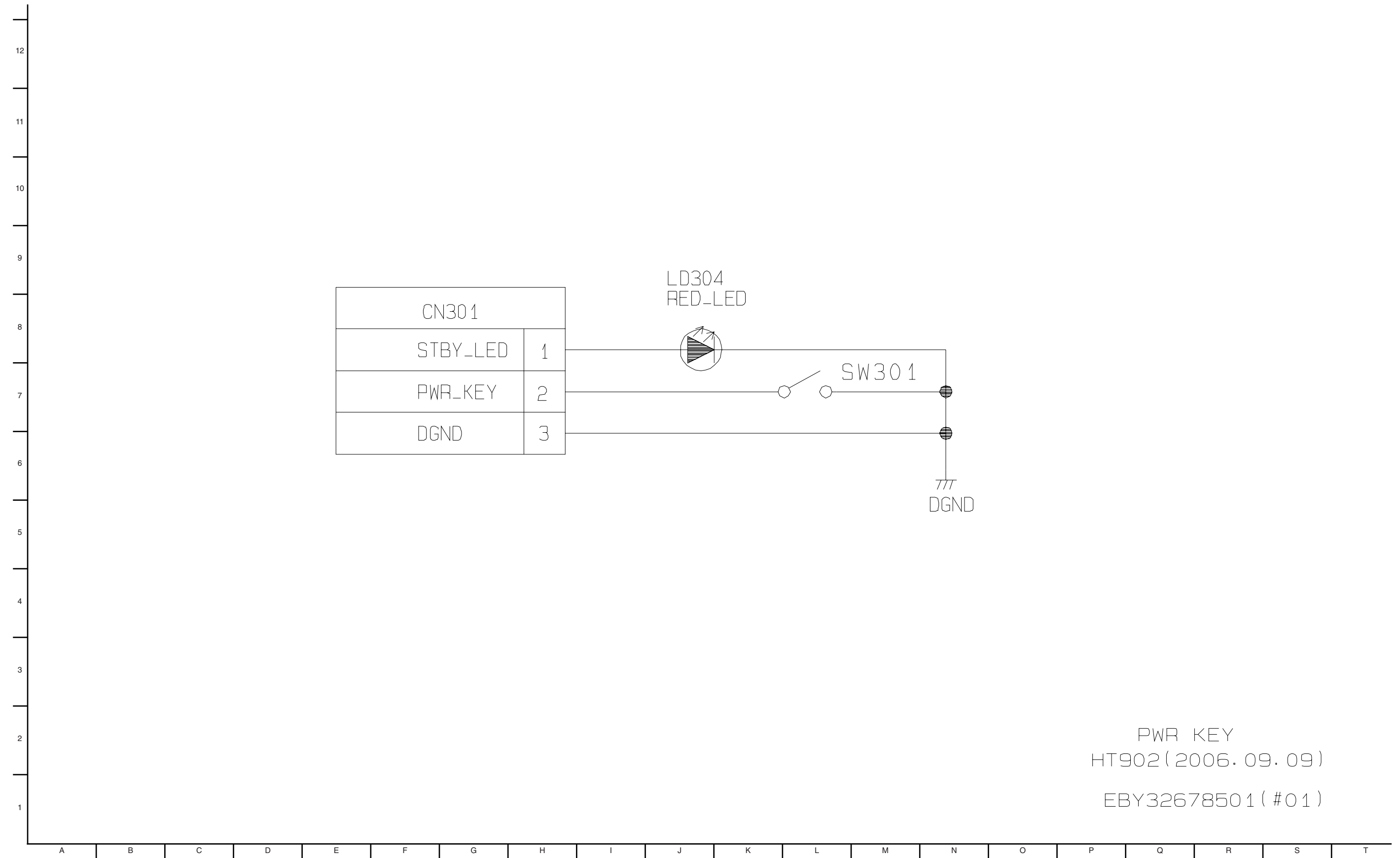

PWR KEY  
 HT902(2006.09.09)  
 EBY32678501(#01)

# 8. TIMER CIRCUIT DIAGRAM

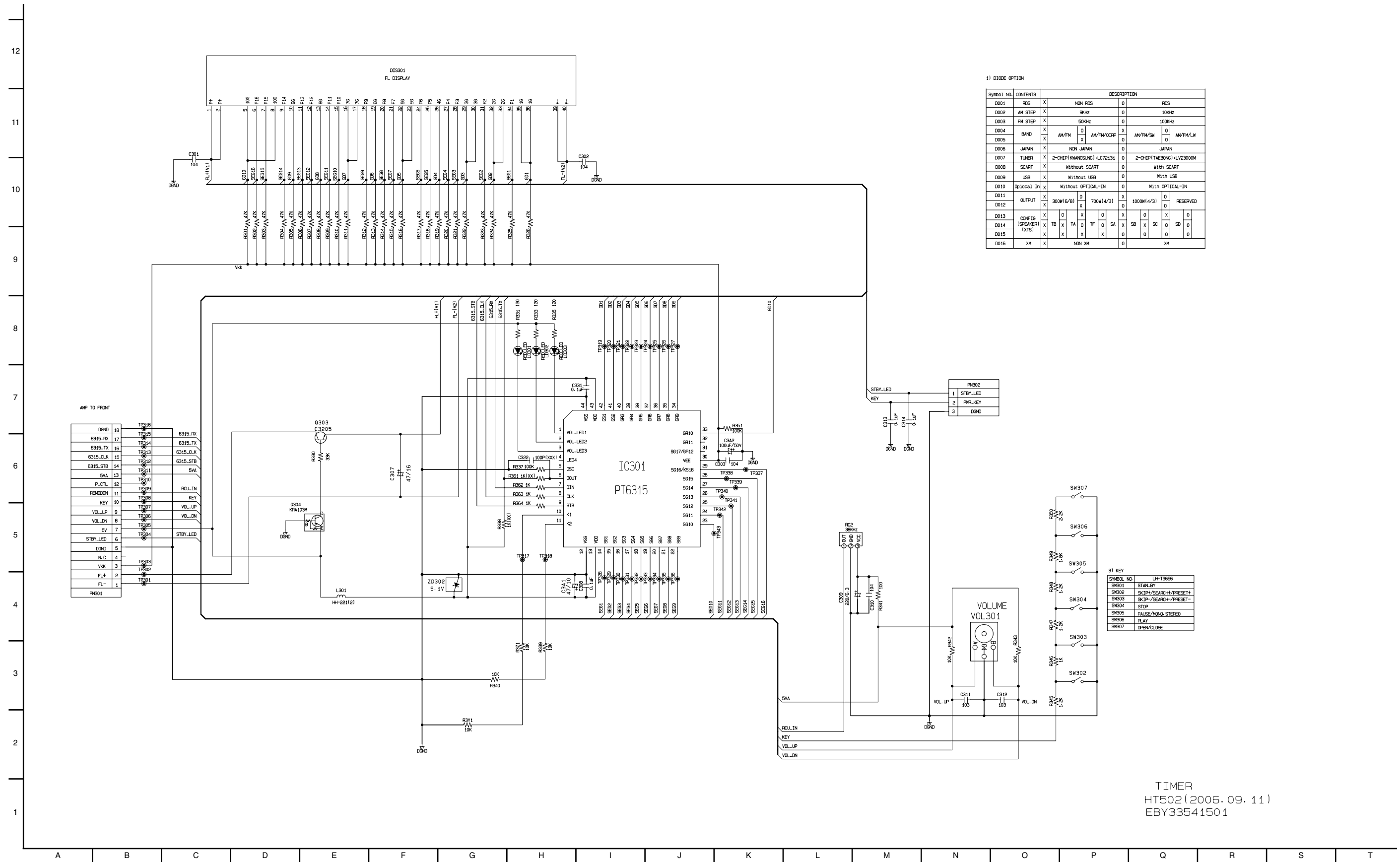

1) DIODE OPTION

SYMBOL NO.	CONTENTS	DESCRIPTION	
D001	RDS	X	RDS
D002	AM STEP	X	NON RDS
D003	FM STEP	X	RDS
D004	BAND	X	50KHz
D005	BAND	X	100KHz
D006	JAPAN	X	AM/FM
D007	TUNER	X	AM/FM/STB
D008	SCART	X	AM/FM/LM
D009	USB	X	Without SCART
D010	Optical In	X	Without USB
D011	OUTPUT	X	With SCART
D012	OUTPUT	X	With USB
D013	CONFIG (SPEAKER)	X	Without OPTICAL-IN
D014	(XTS)	X	With OPTICAL-IN
D015	XM	X	Without OPTICAL-IN
D016	XM	X	With OPTICAL-IN

3) KEY

SYMBOL NO.	DESCRIPTION
SW301	STANBY
SW302	SKIP/SEARCH/PRESET
SW303	SKIP/SEARCH/PRESET
SW304	STOP
SW305	PAUSE/MONO-STEREO
SW306	PLAY
SW307	OPEN/CLOSE

TIMER  
HT502 (2006.09.11)  
EBY33541501

# 9. HDMI CIRCUIT DIAGRAM

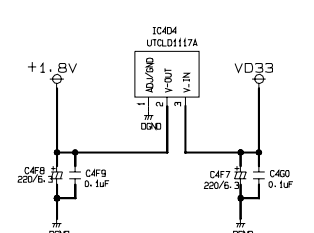
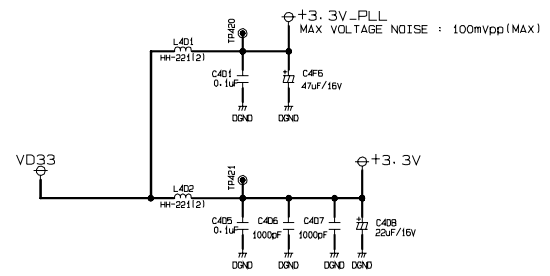

Designers should include decoupling and bypass cap at each power pin in the layout. Transmitter chip should be placed as closely as possible to the HDMI connector.

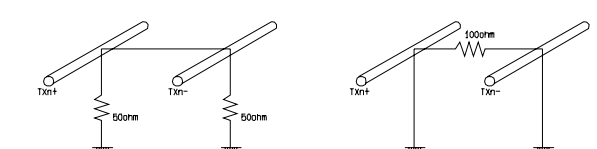

The impedance of between the each TMSD line and ground must be 50-ohm. Traces should have 100 ohm differential impedance for each differential pair. The differential lines should be routed as directly as possible from transmitter to connector.

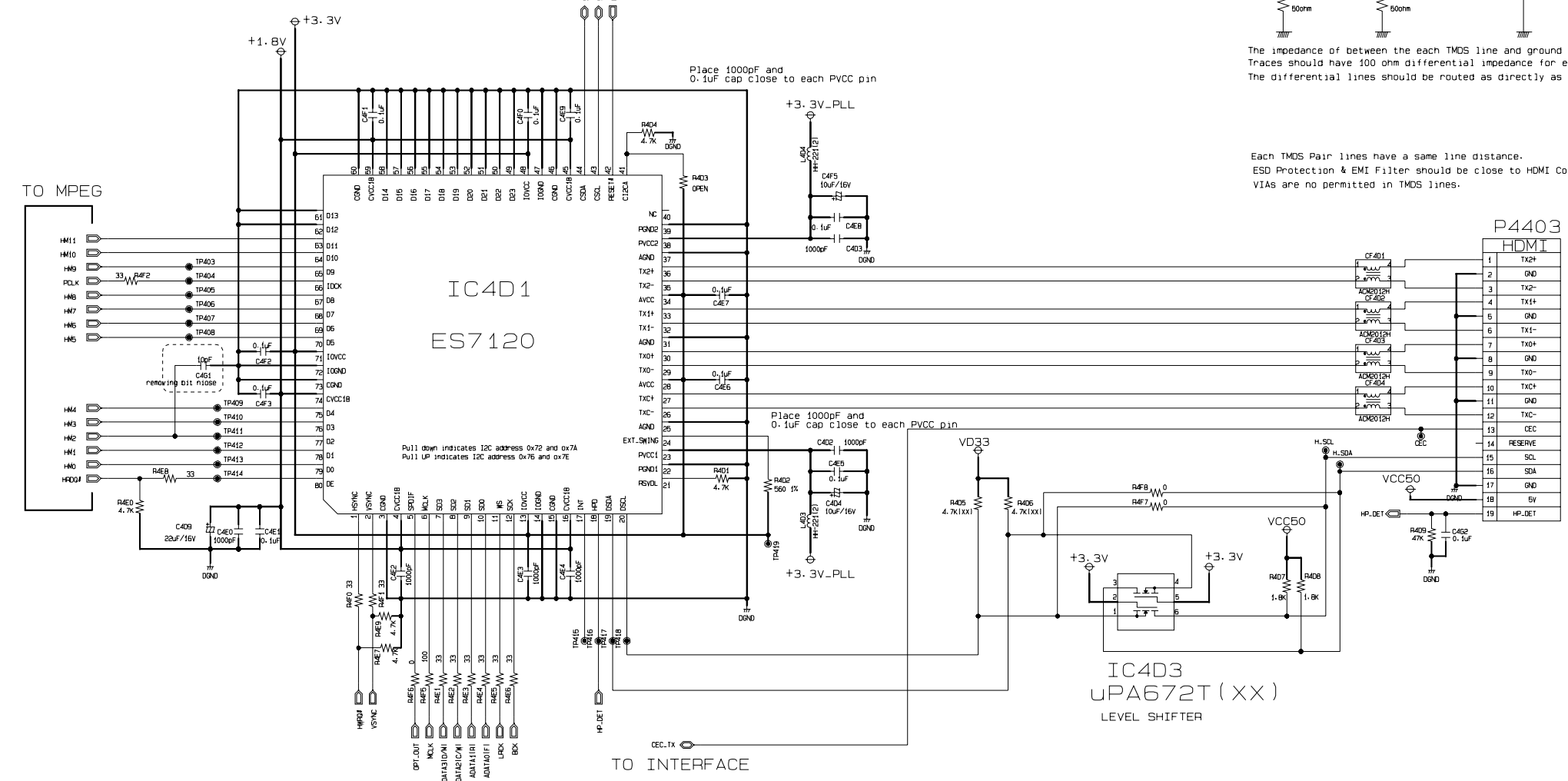

Each TMSD Pair lines have a same line distance. ESD Protection & EMI Filter should be close to HDMI Connector. VIAs are no permitted in TMSD lines.

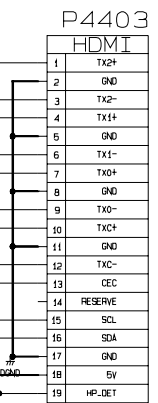

HDMI  
HT902/502 (2006. 09. 02)  
EBY32678801 (#5)

# PRINTED CIRCUIT BOARD DIAGRAMS

## 1. MAIN P.C. BOARD DIAGRAM ( TOP VIEW )

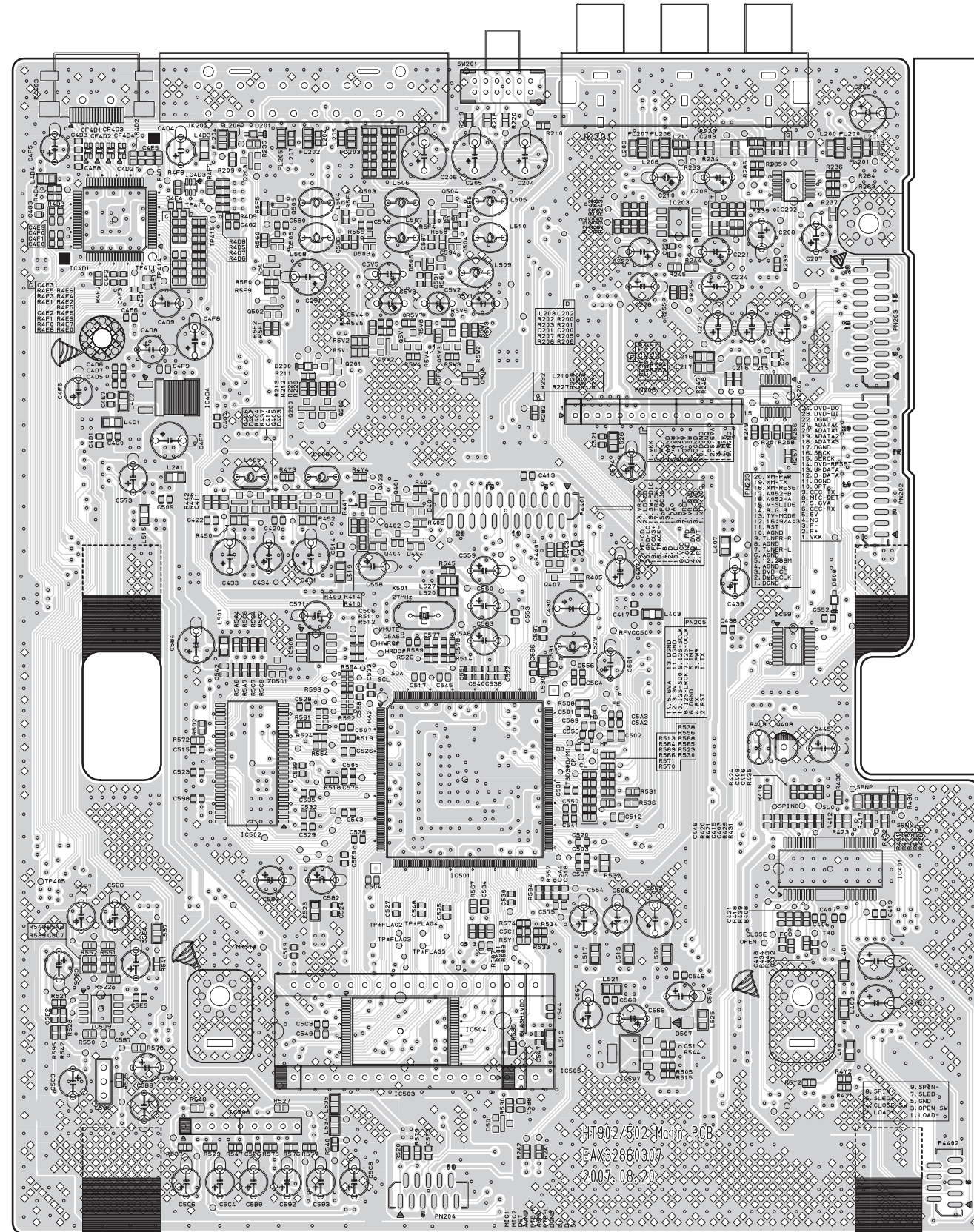



## 2. MAIN P.C. BOARD DIAGRAM ( BOTTOM VIEW )

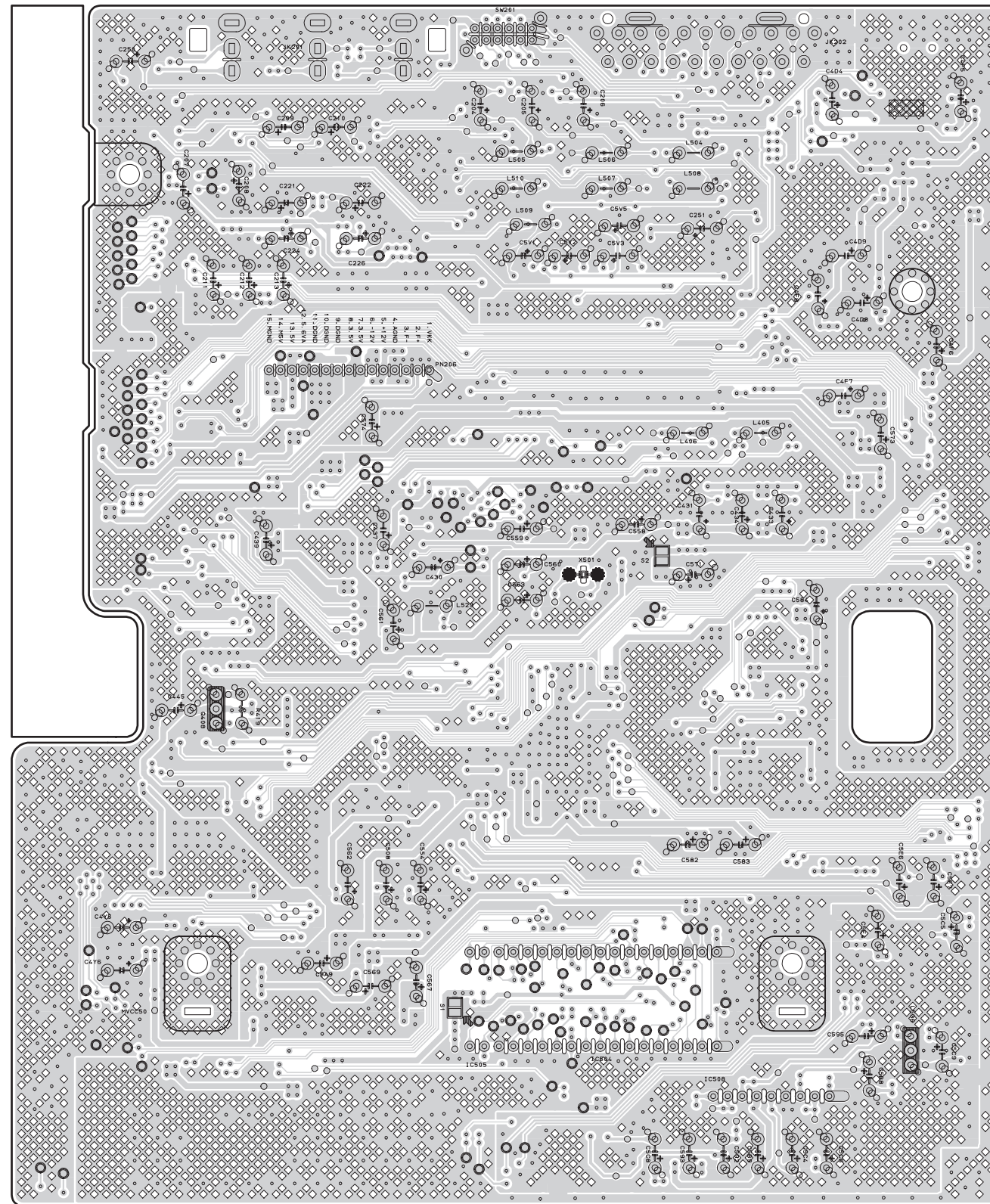

### 3. SMPS P.C. BOARD

NOTES) ⚠ Warning  
Parts that are shaded are critical  
with respect to risk of fire or  
electrical shock.

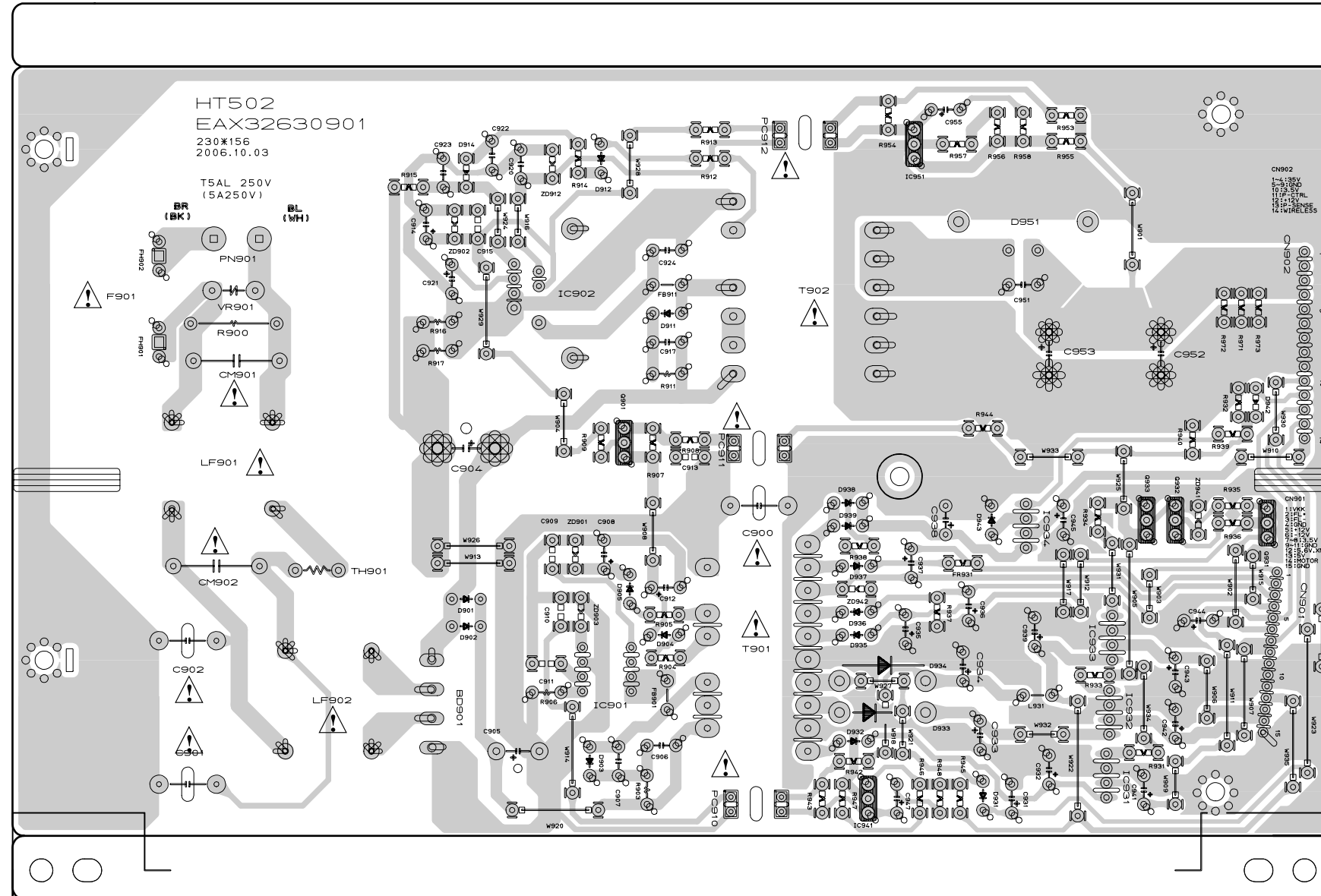

## 4. KEY P.C. BOARD

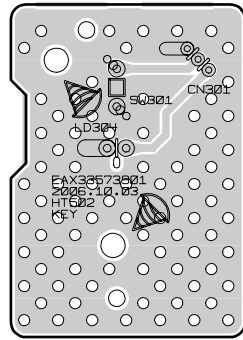

## 5. TIMER P.C. BOARD

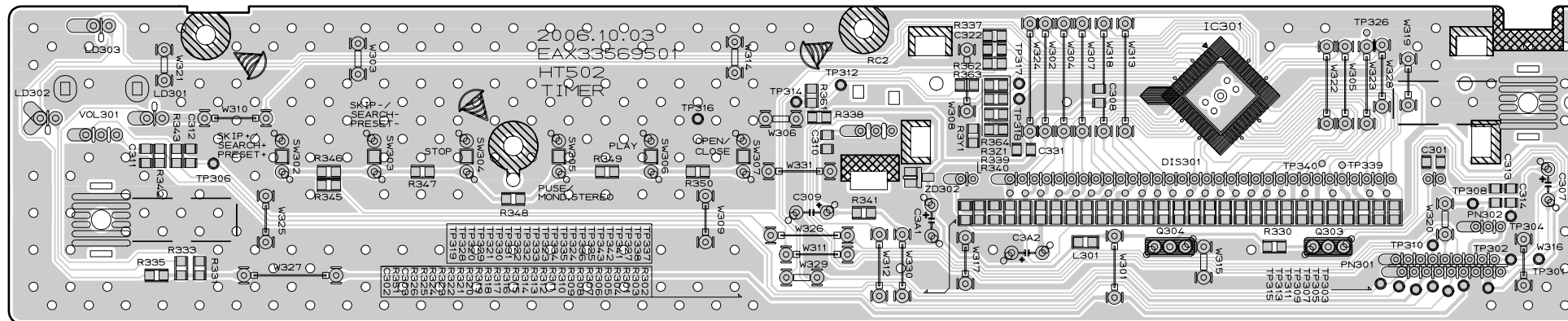



## 6. USB P.C. BOARD

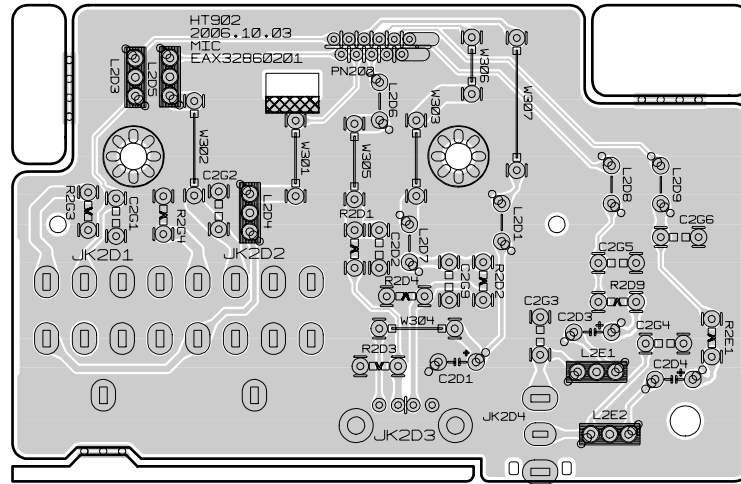

# SECTION 3. DVD & AMP PART

## ELECTRICAL TROUBLESHOOTING GUIDE

### 1. AMP PROTECTION

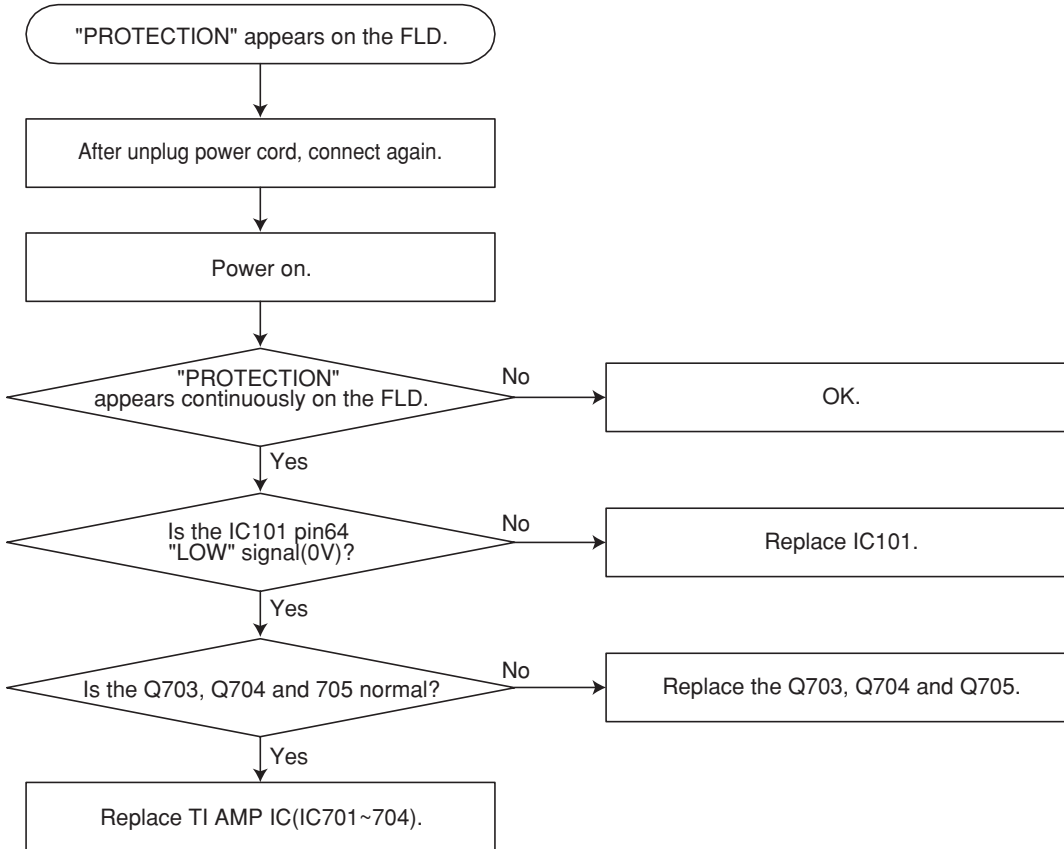

## 2. SYSTEM OPERATION FLOW

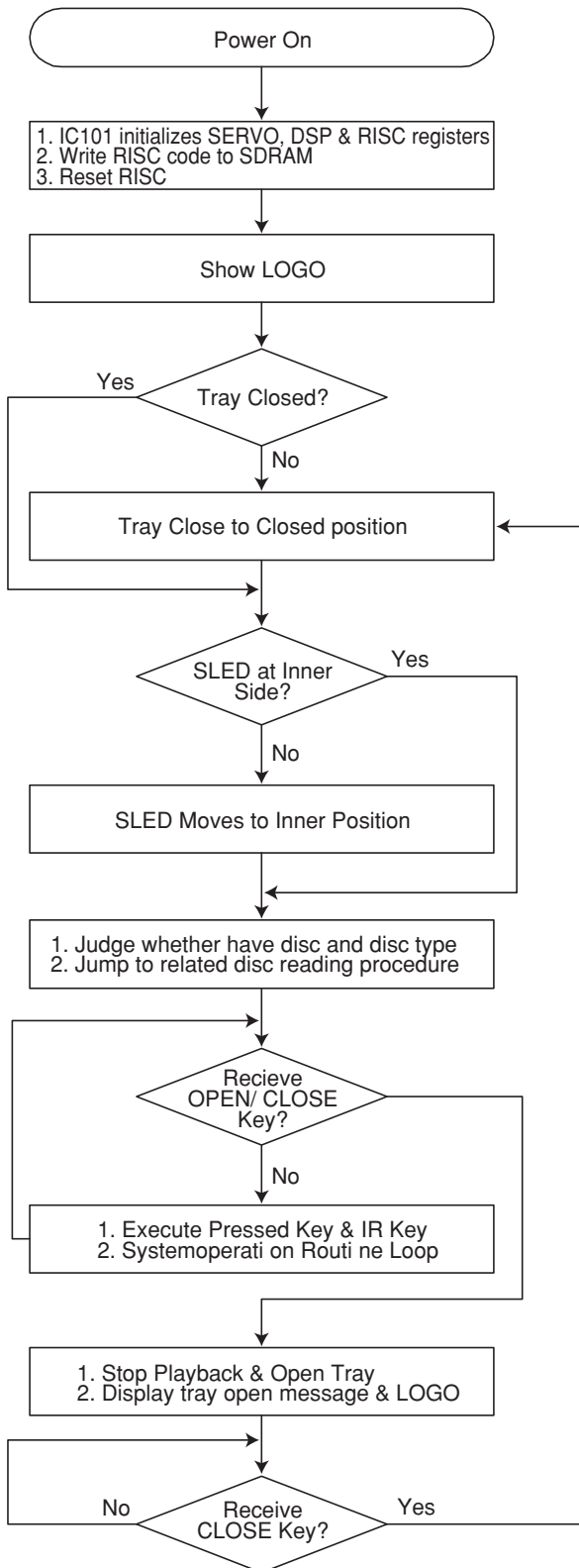

### 3. TEST & DEBUG FLOW

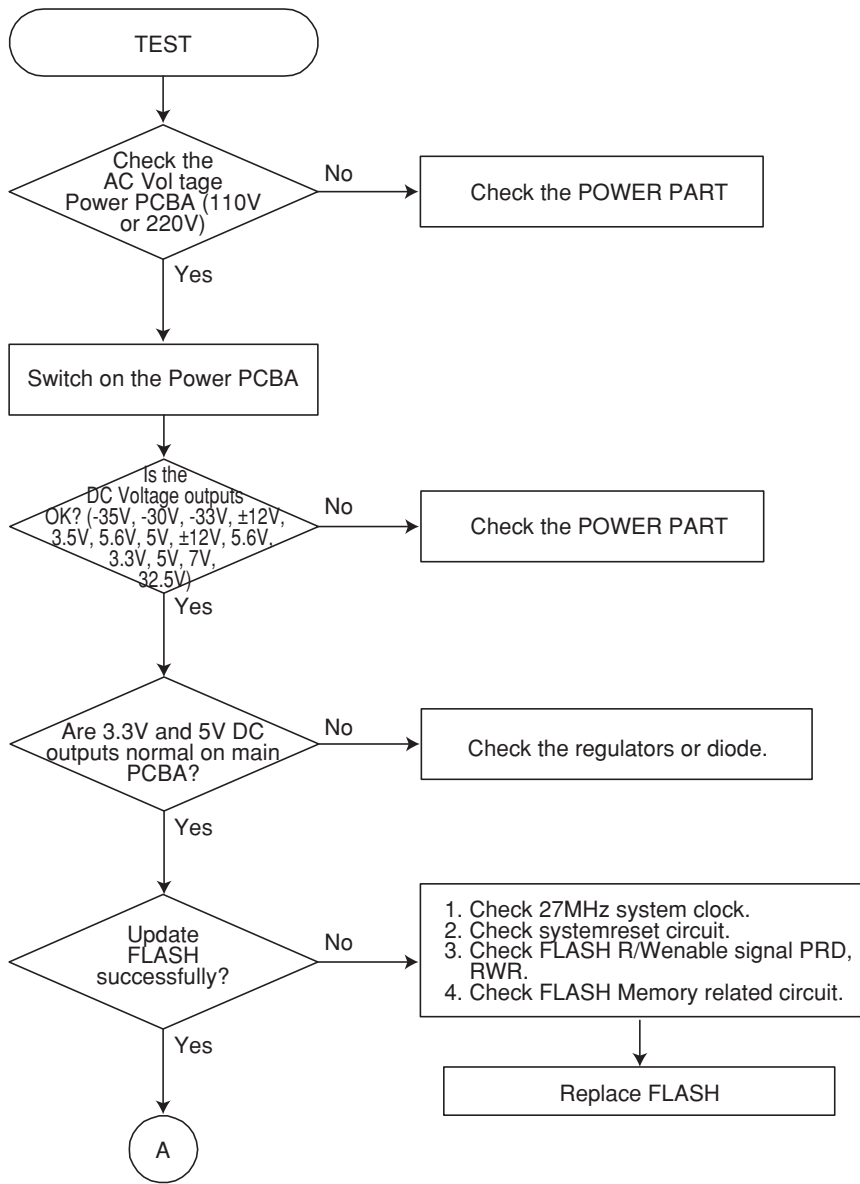

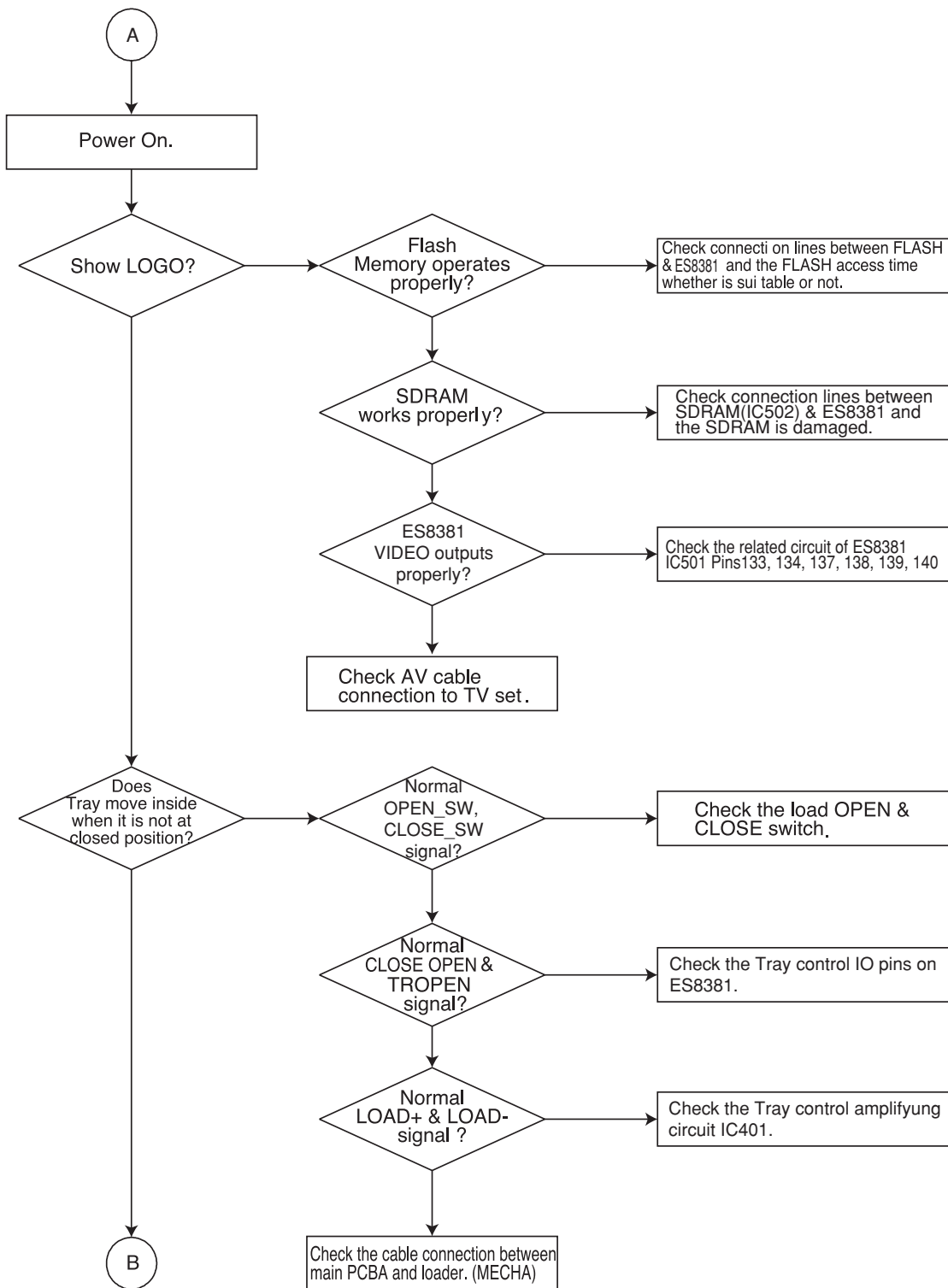

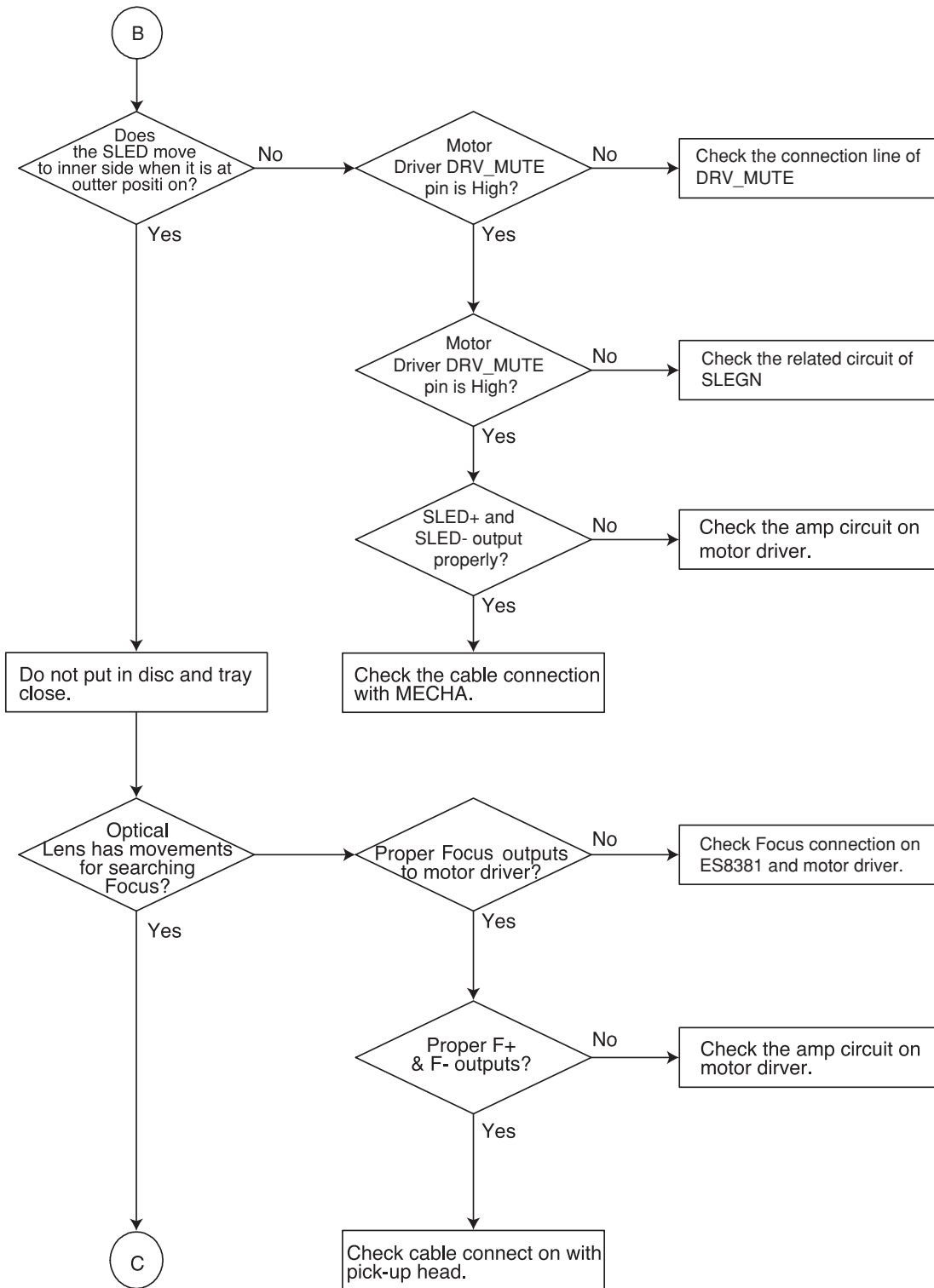

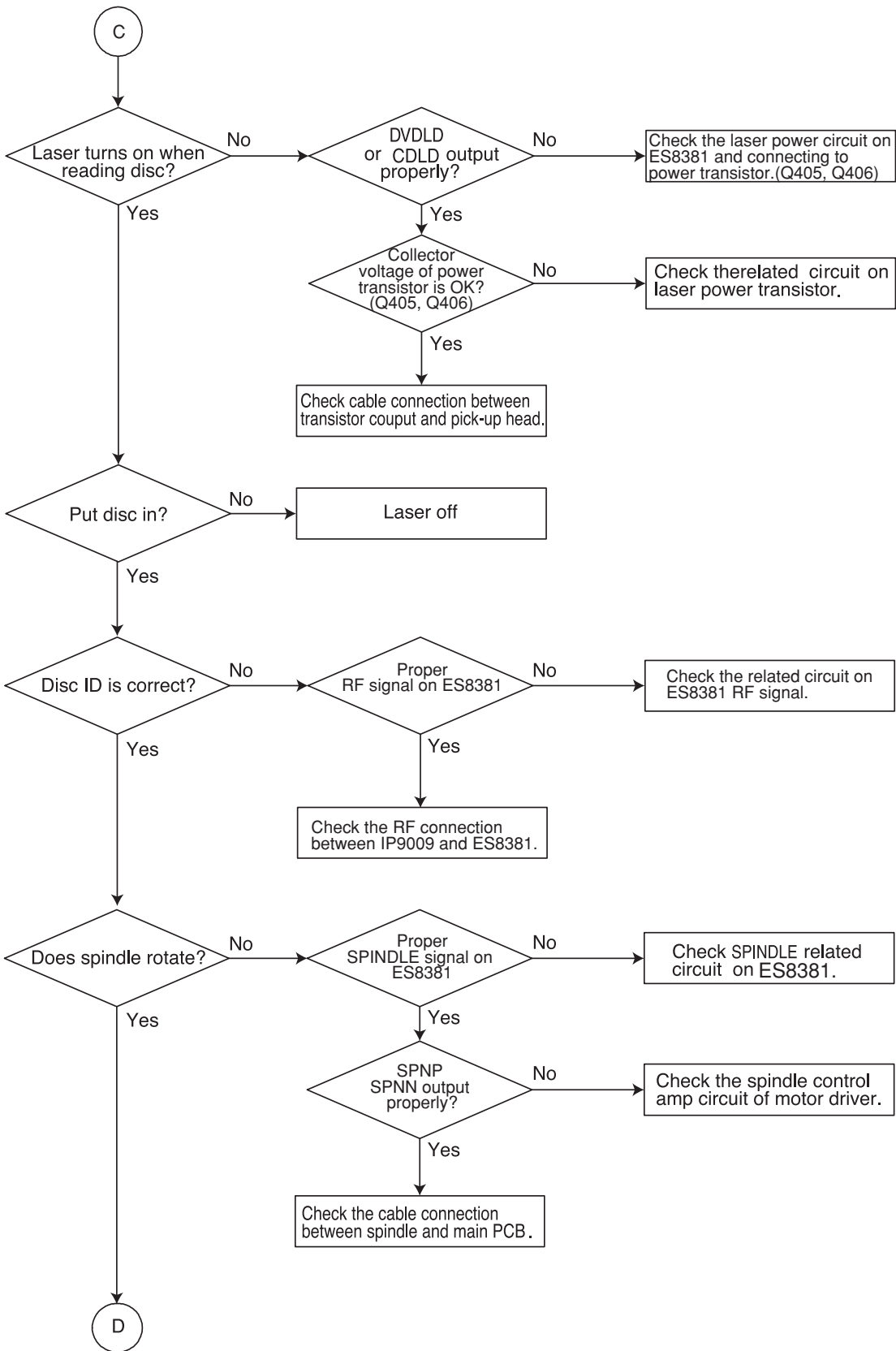

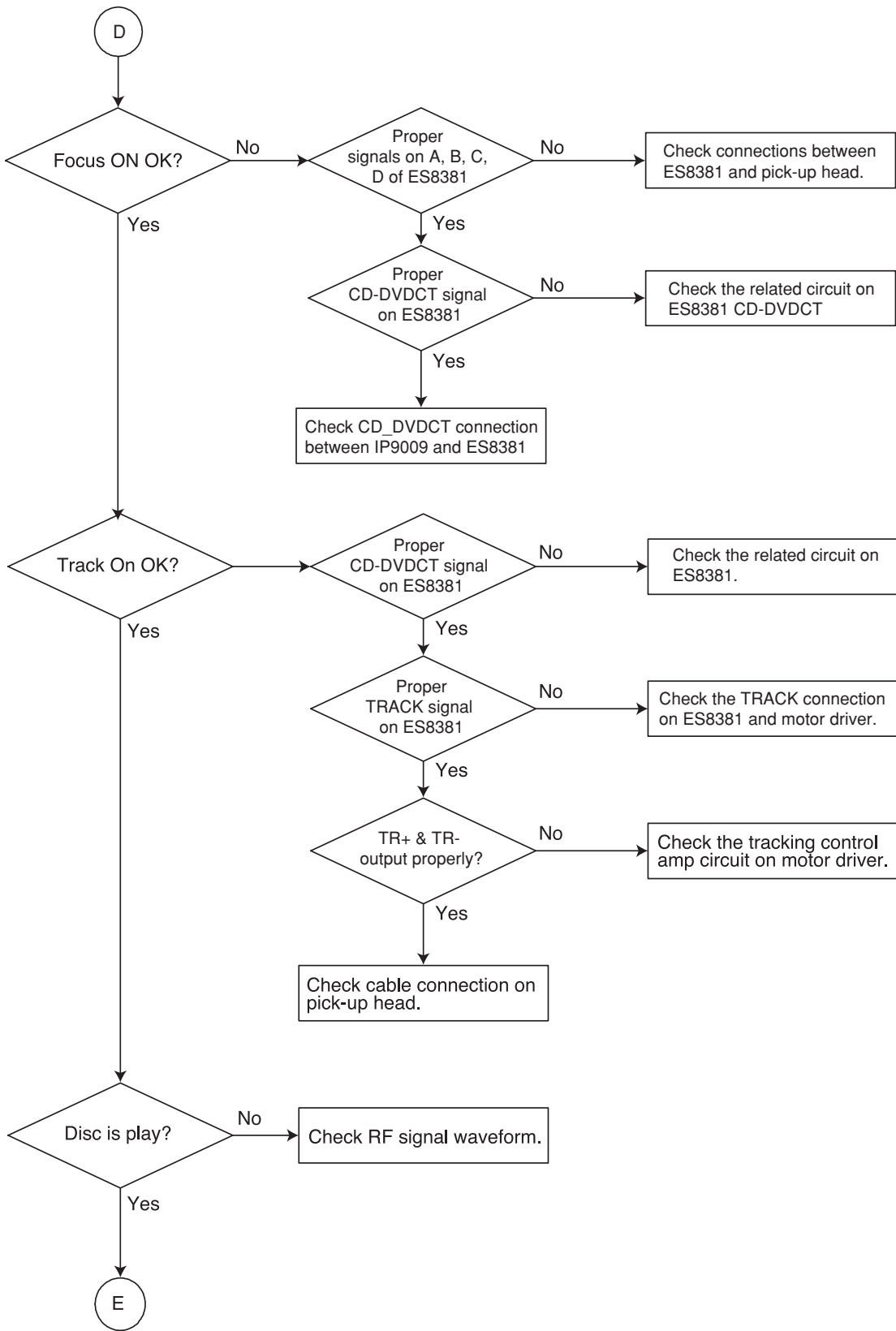



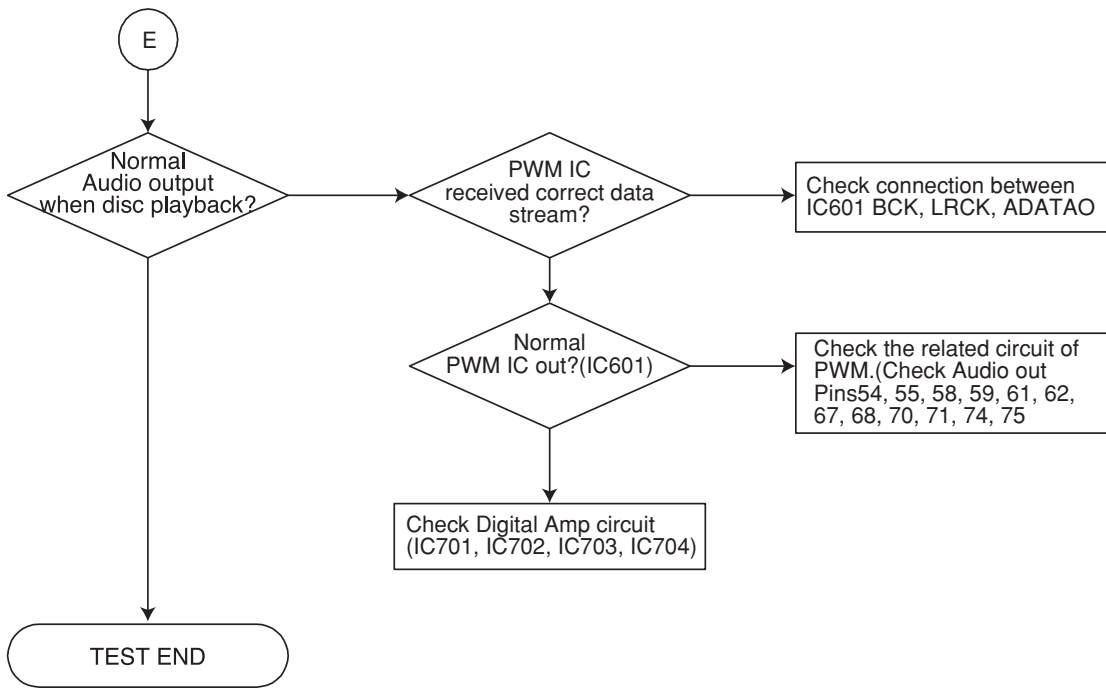

#### 4. AUDIO $\mu$ -COM CIRCUIT(DVD & AMP)

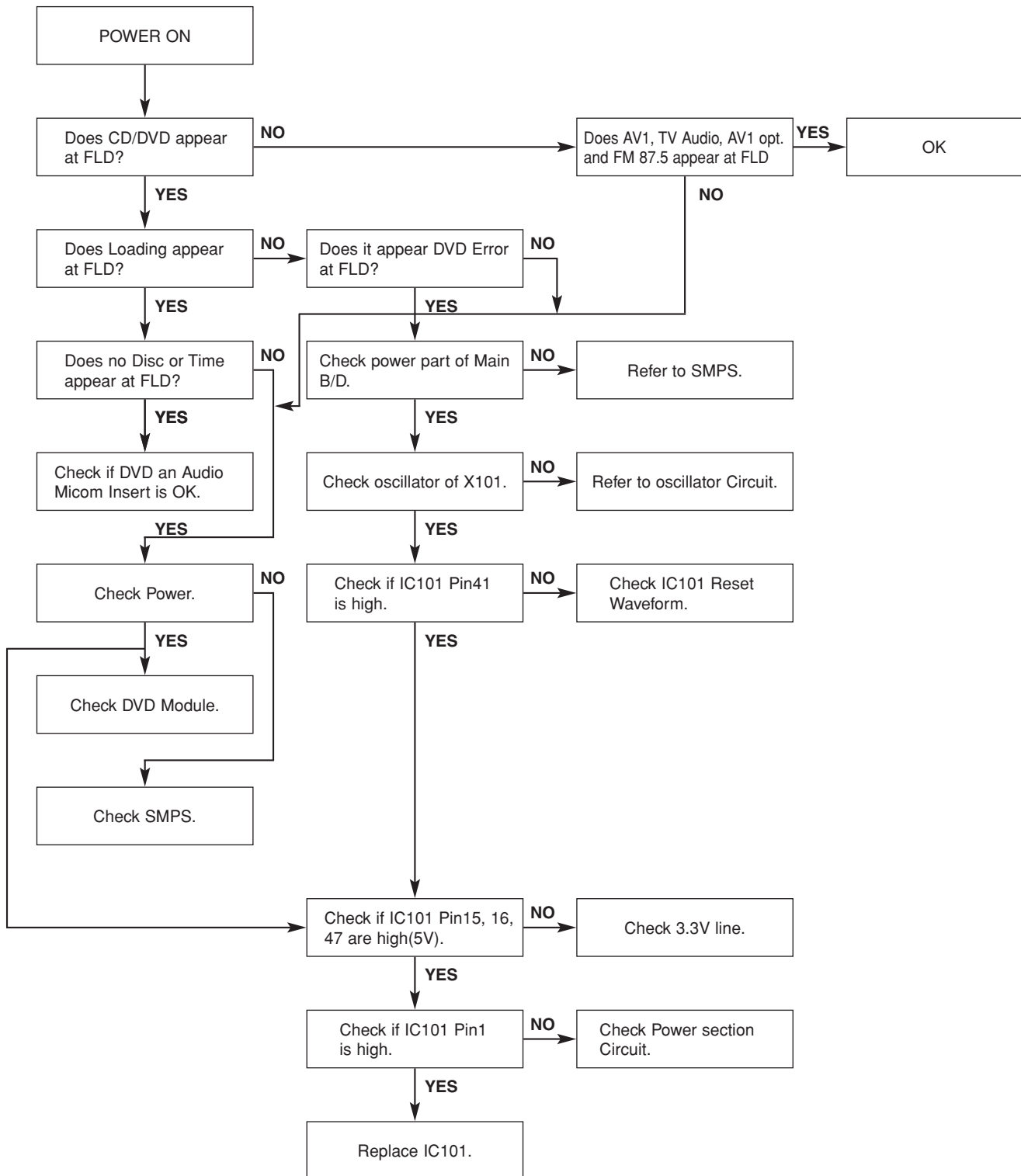

# DETAILS AND WAVEFORMS ON SYSTEM TEST AND DEBUGGING

## 1. SYSTEM 27MHz CLOCK,RESET,FLASH R/W SIGNAL

### 1) ES8381 main clock is at 27MHz(X501)

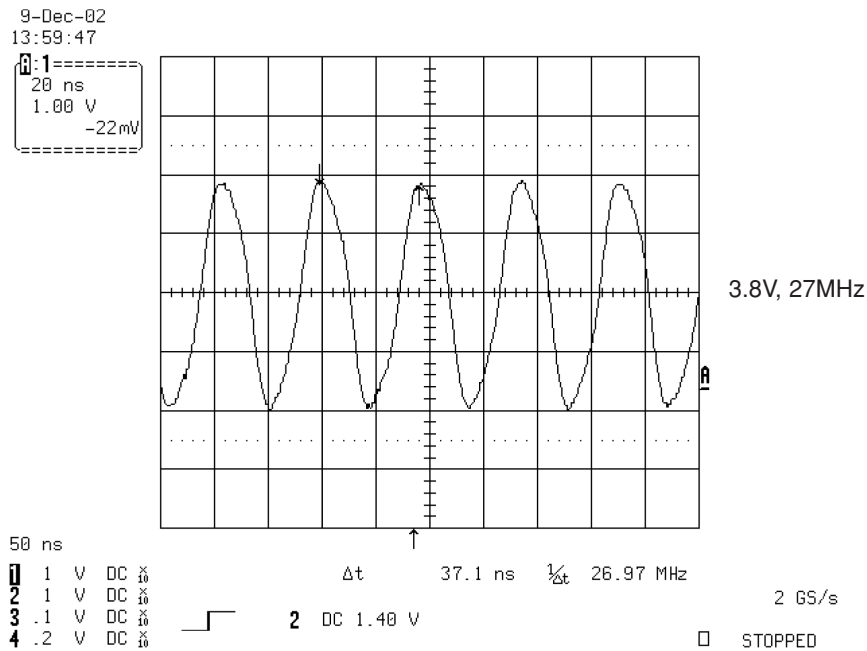

FIG 1-1

### 2) ES8381 reset is high active.

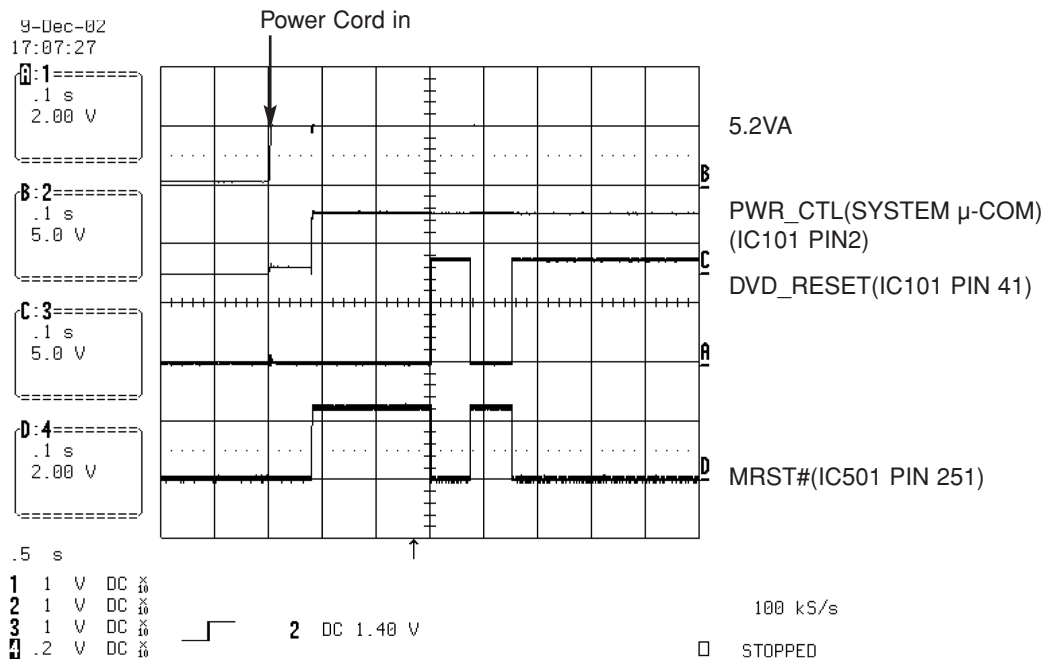

FIG 1-2

### 3) Flash R/W enable signal during download(Downloading)

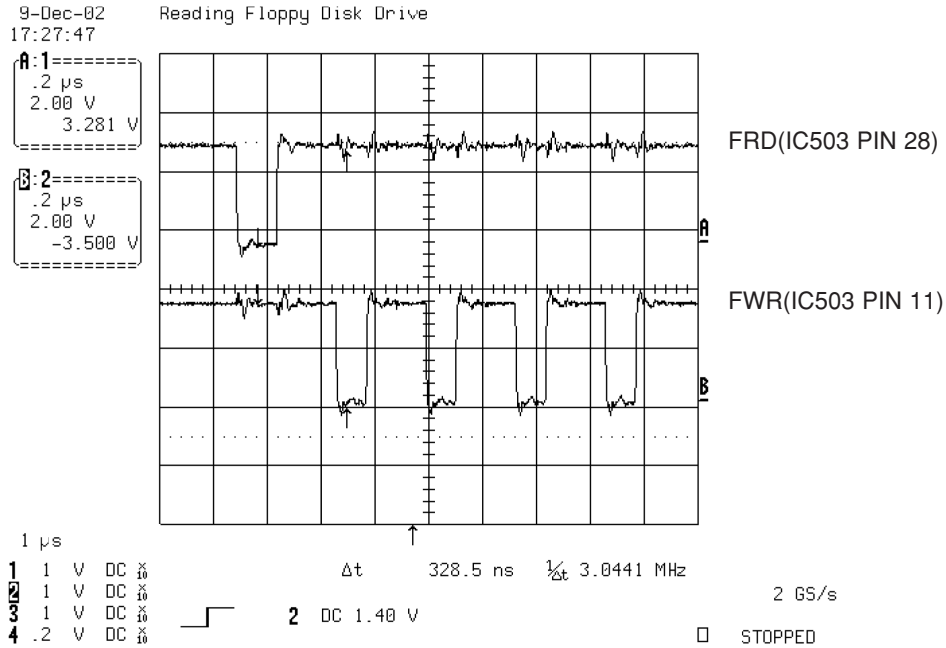

FIG 1-4

## 2. SDRAM CLOCK

### 1) ES8381 main clock is at 27MHz(X501)

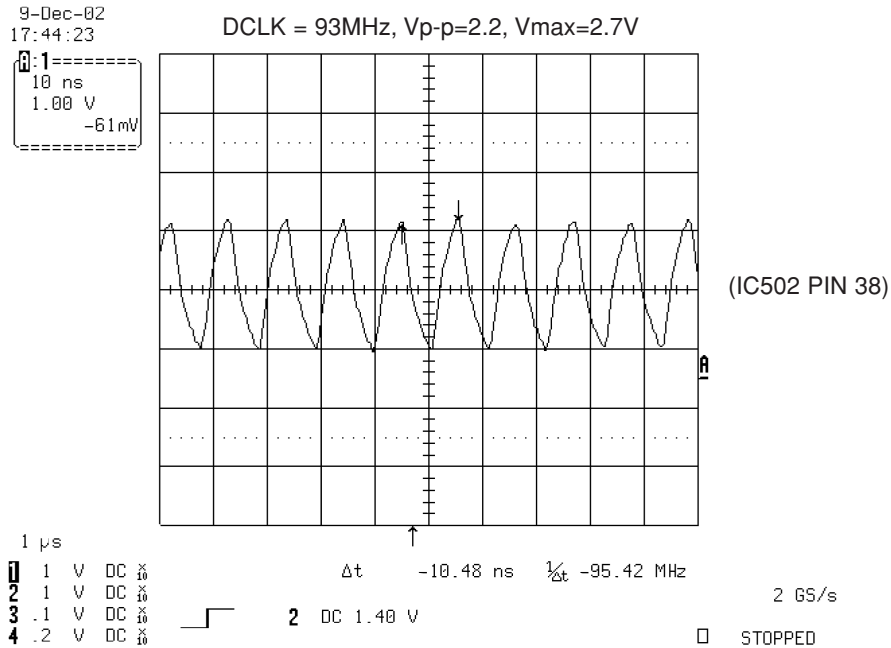

FIG 2-1

### 3. TRAY OPEN/CLOSE SIGNAL

#### 1) Tray open/close waveform

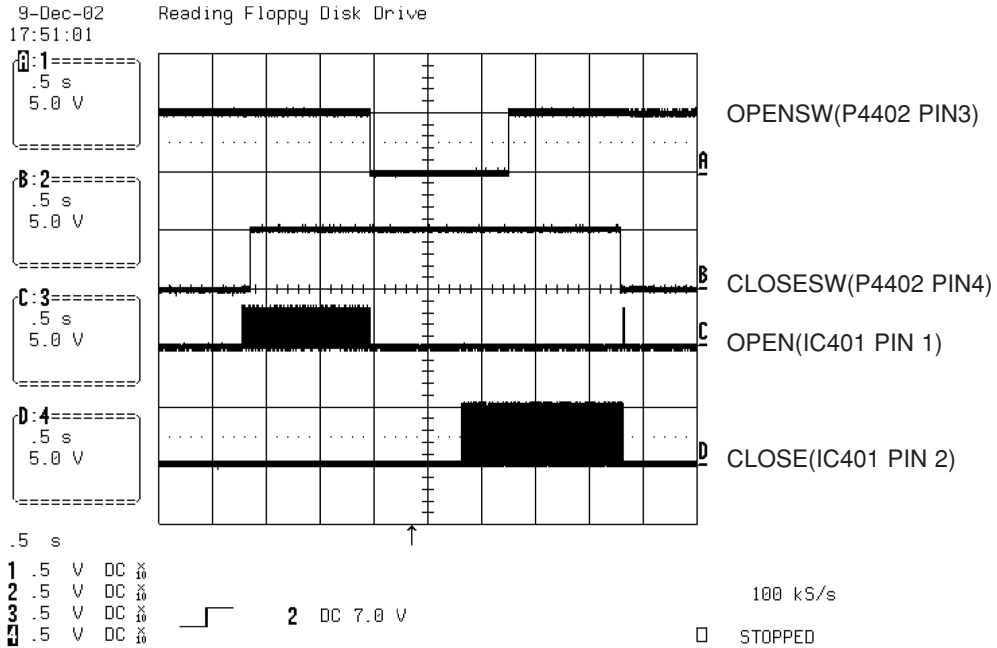

FIG 3-1

#### 2) Tray close waveform

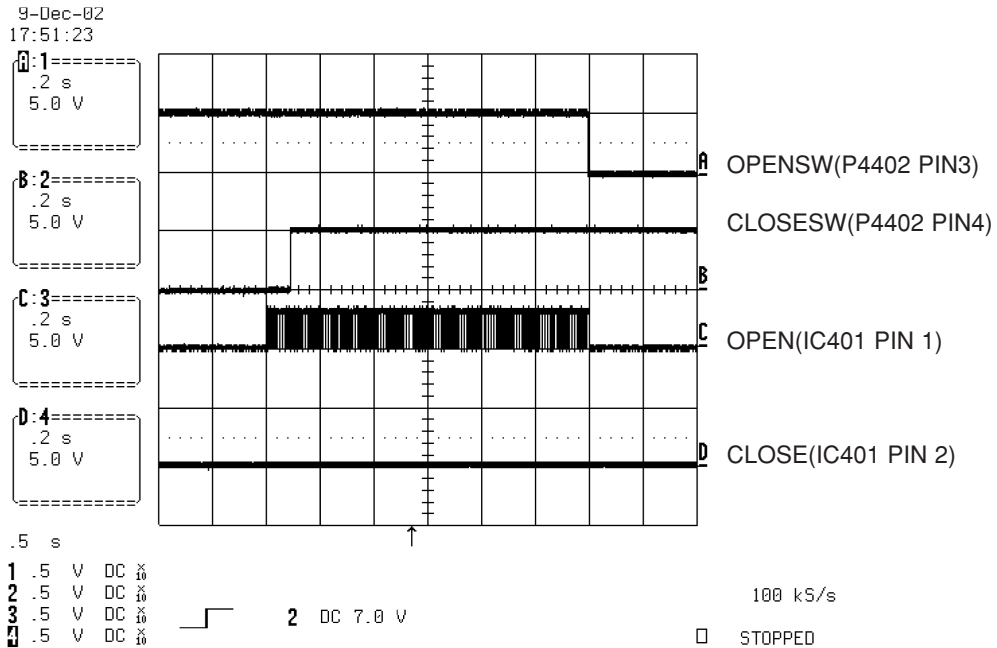

FIG 3-2

### 3) Tray open waveform

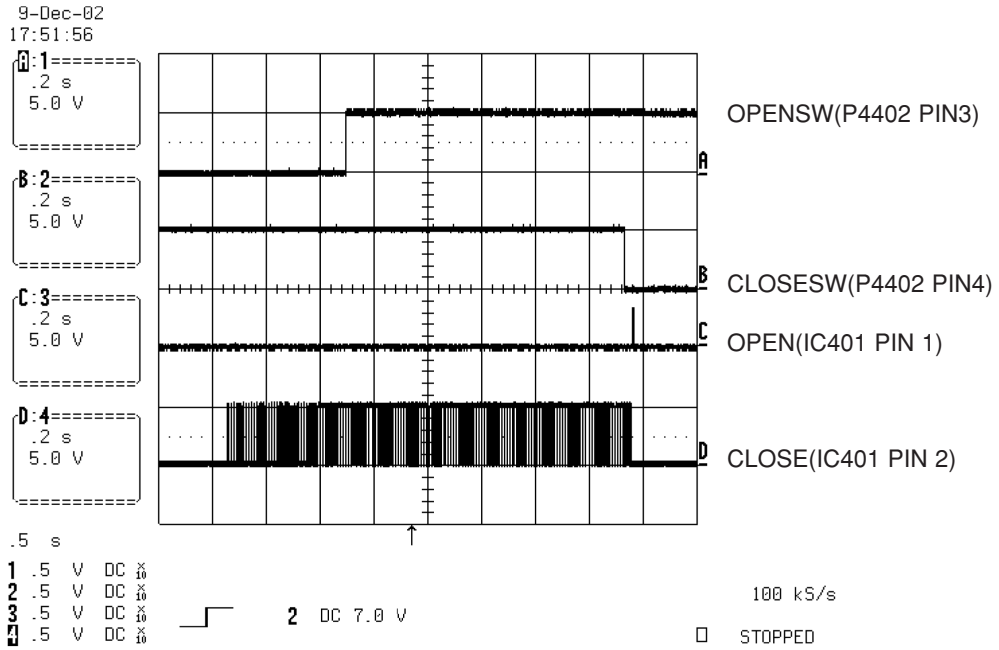

FIG 3-3

### 4. SLED CONTROL RELATED SIGNAL (NO DISC CONDITION)

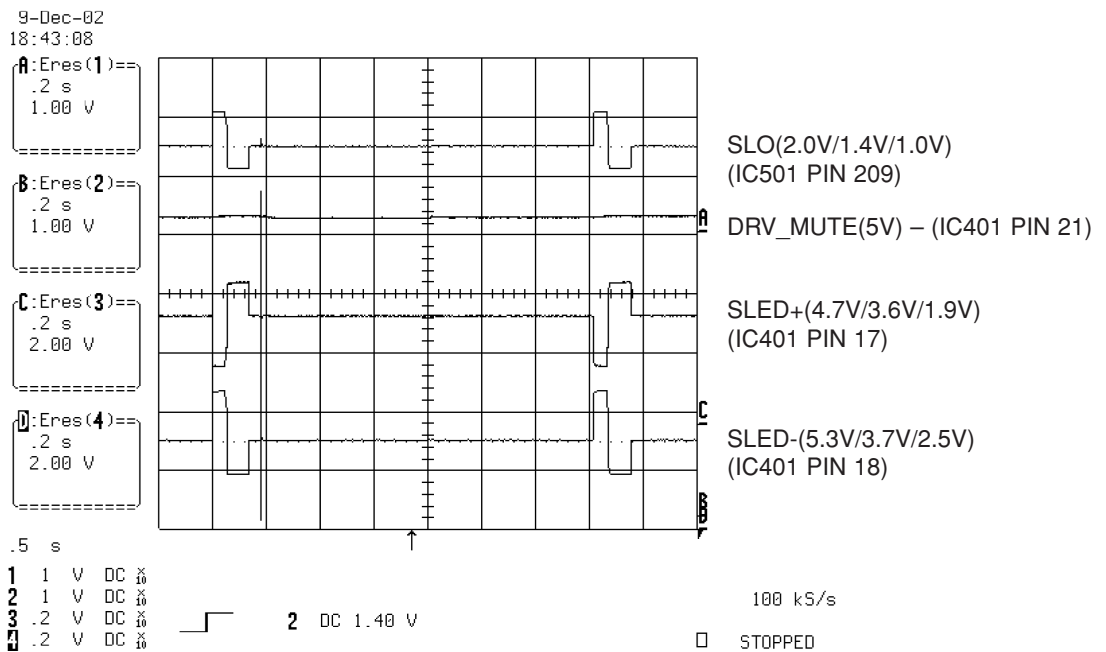

FIG 4-1

## 5. LENS CONTROL RELATED SIGNAL(NO DISC CONDITION)

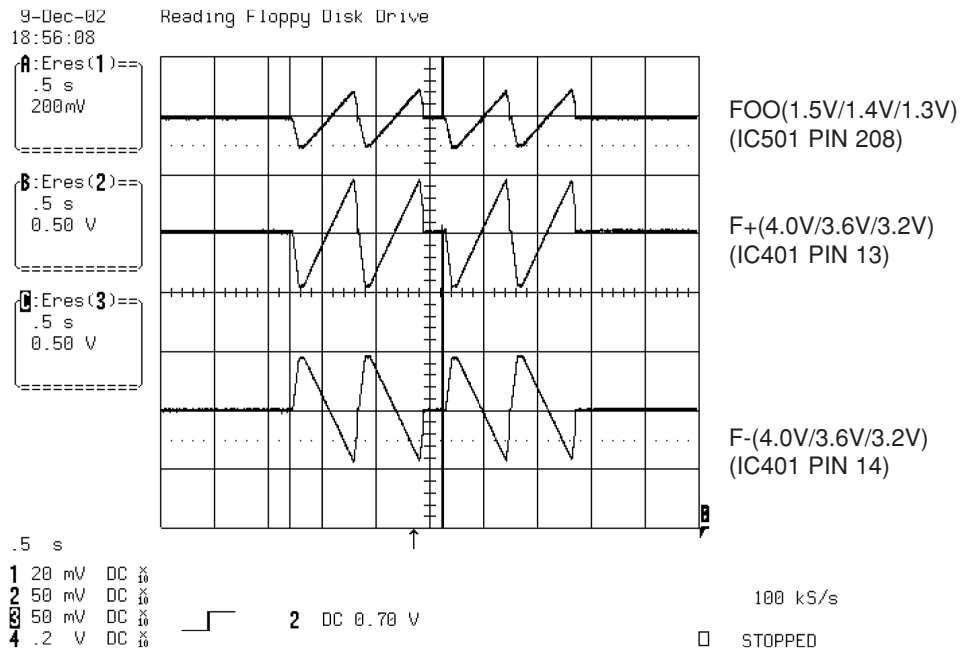

FIG 5-1

## 6. LASER POWER CONTROL RELATED SIGNAL(NO DISC CONDITION)

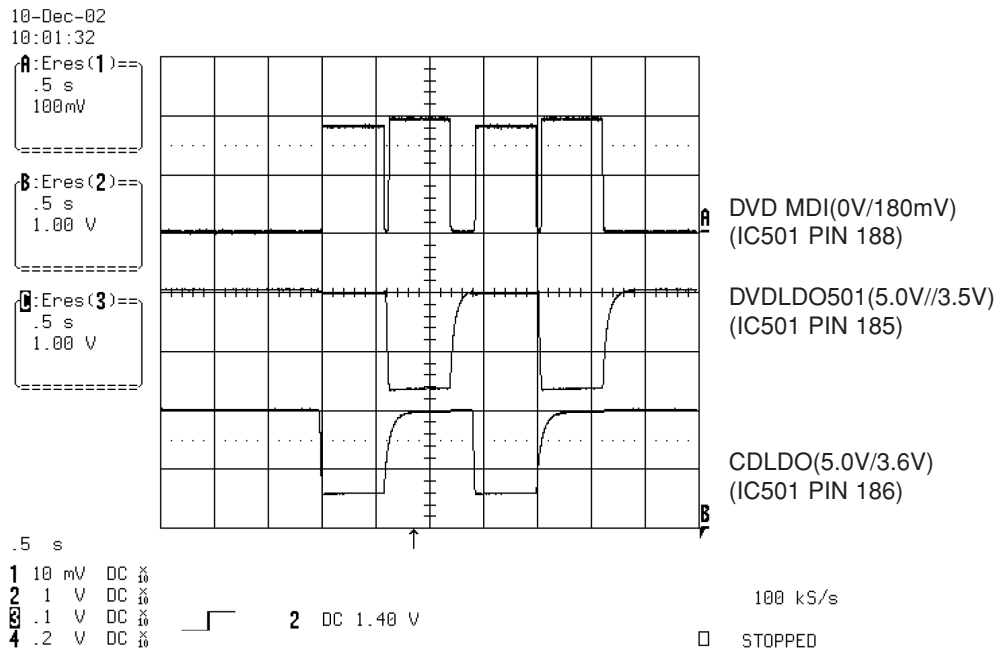

FIG 6-1

## 7. DISC TYPE JUDGEMENT WAVEFORMS

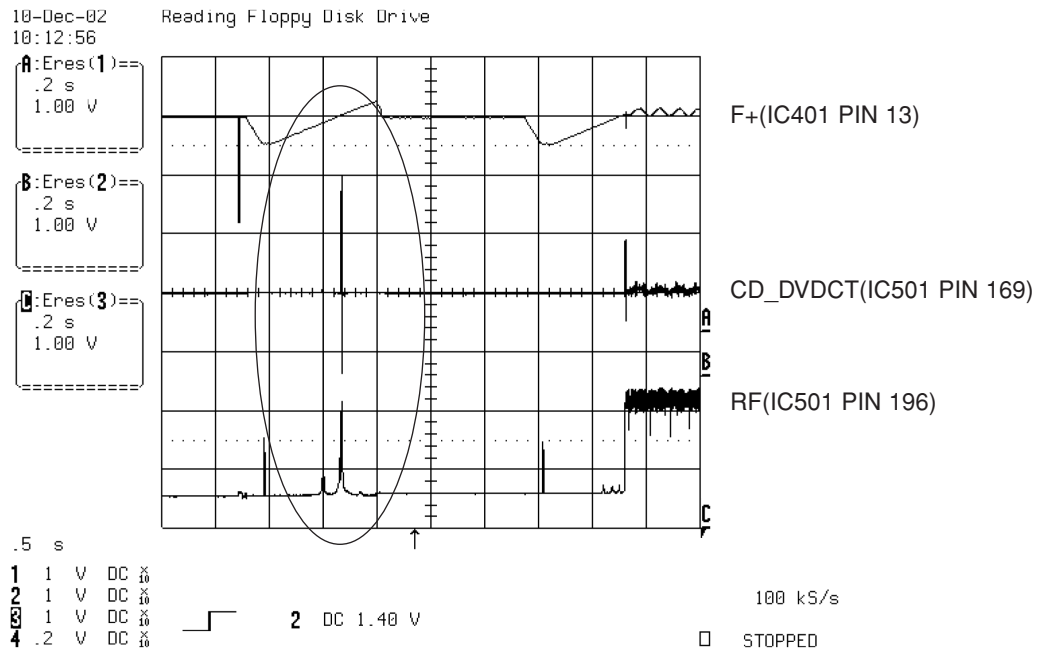

FIG 7-1 (DVD)

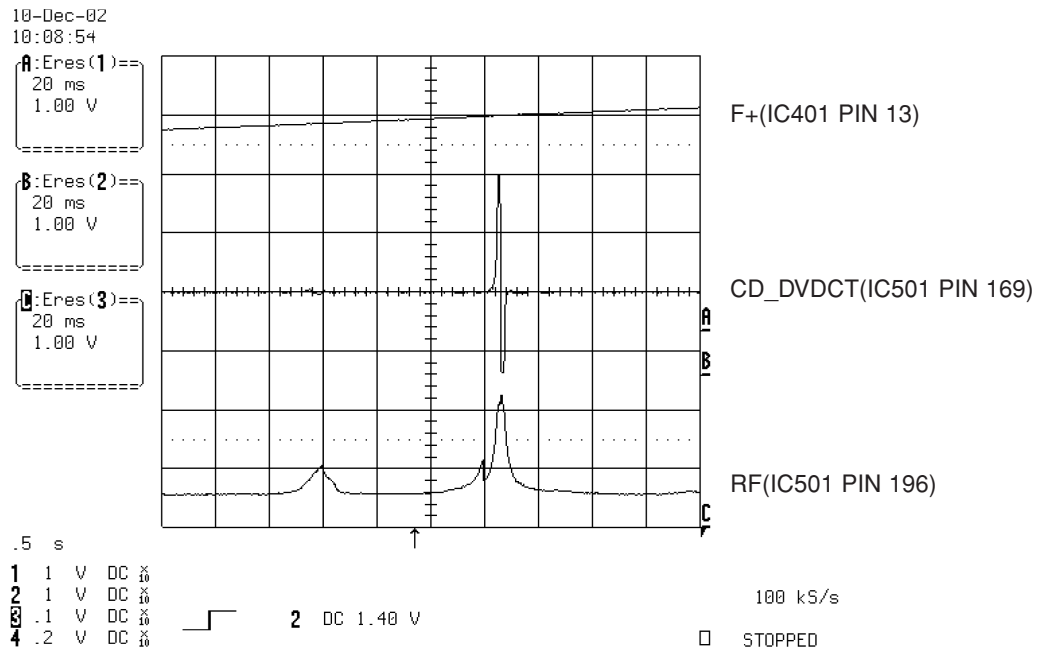

FIG 7-2 (DVD)



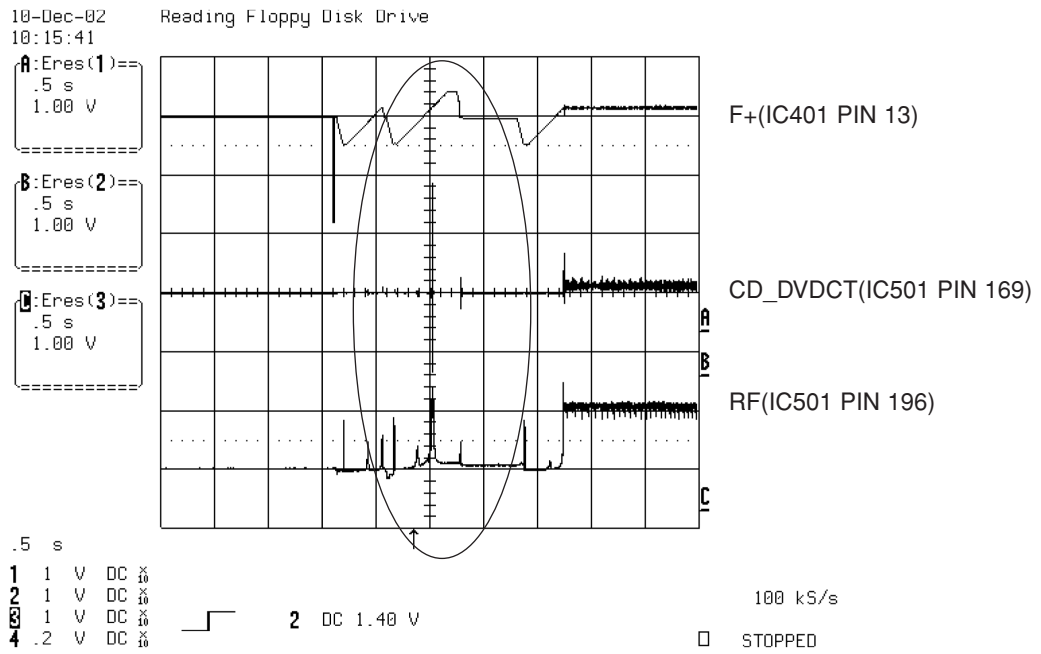

FIG 7-3 (CD)

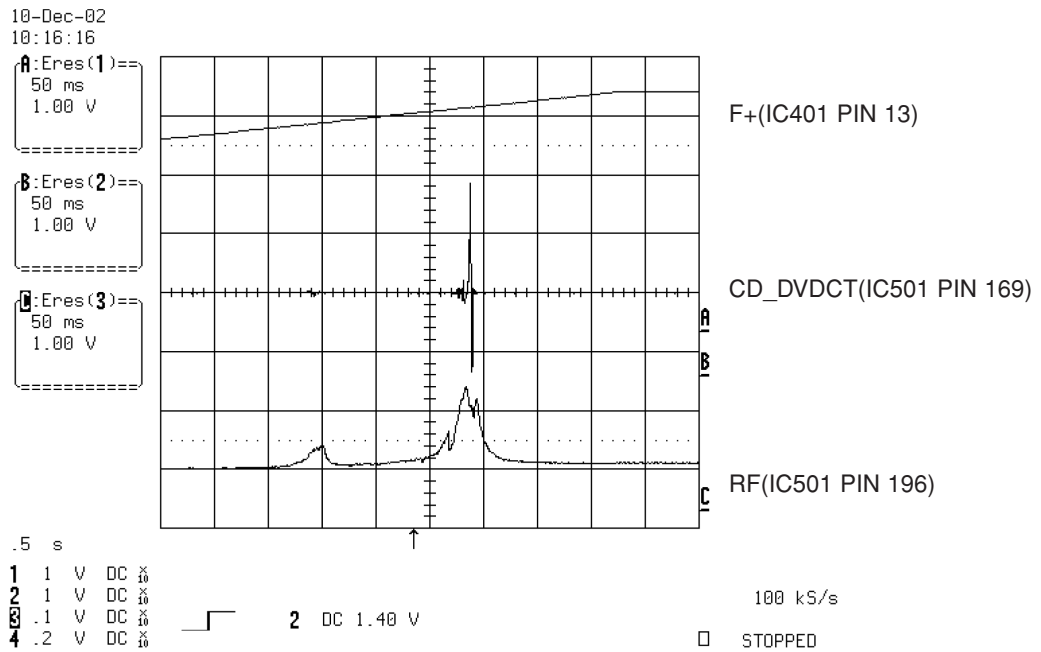

FIG 7-4 (CD)

## 8. FOCUS ON WAVEFORMS

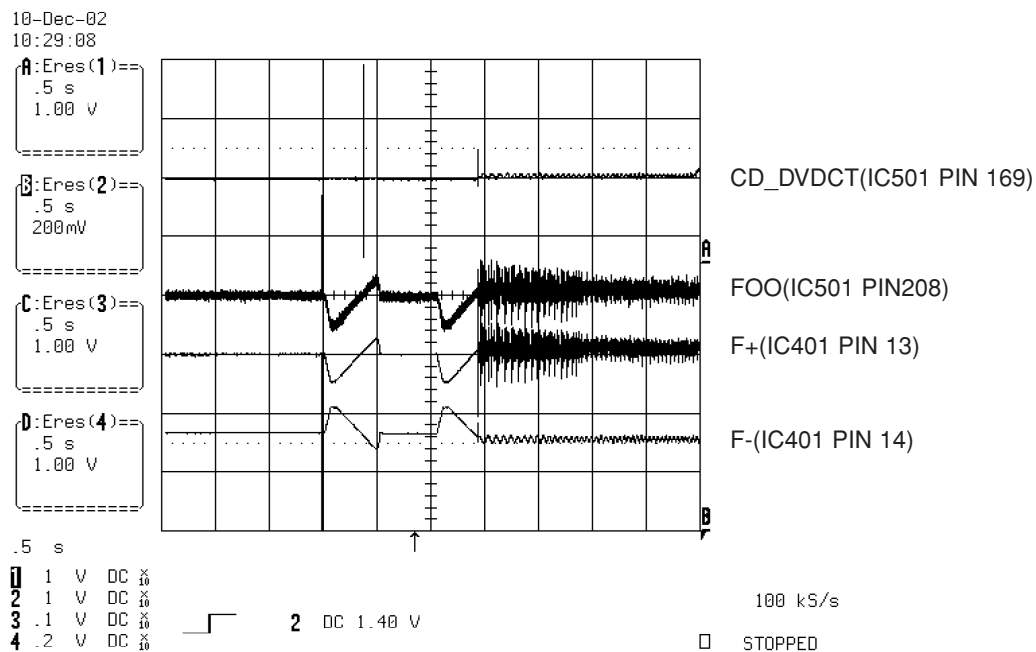

FIG 8-1 (DVD)

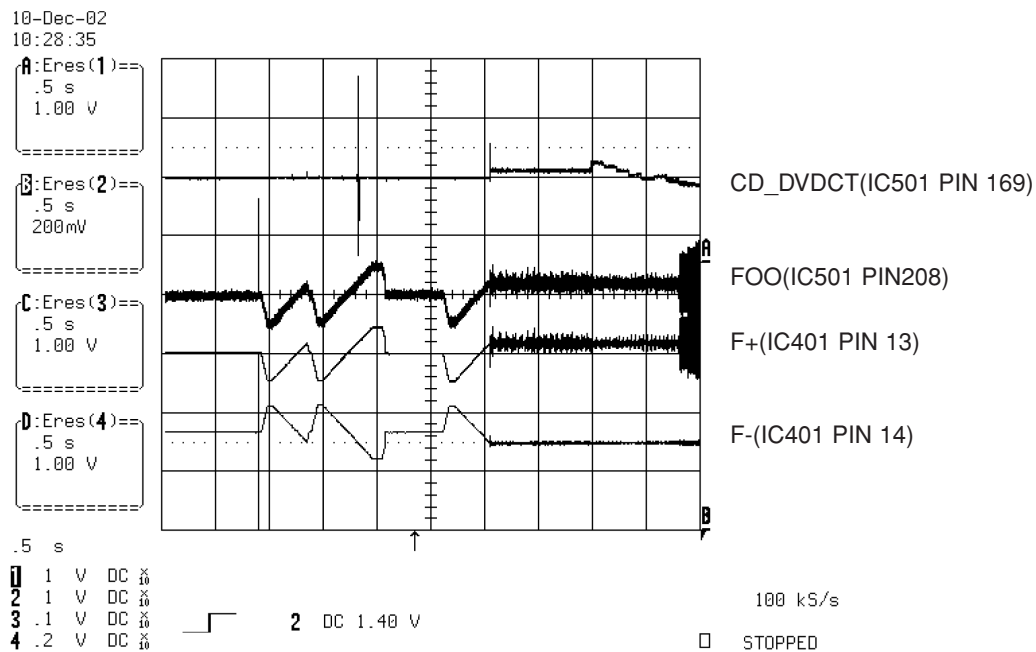

FIG 8-2 (CD)

## 9. SPINDLE CONTROL WAVEFORMS (NO DISC CONDITION)

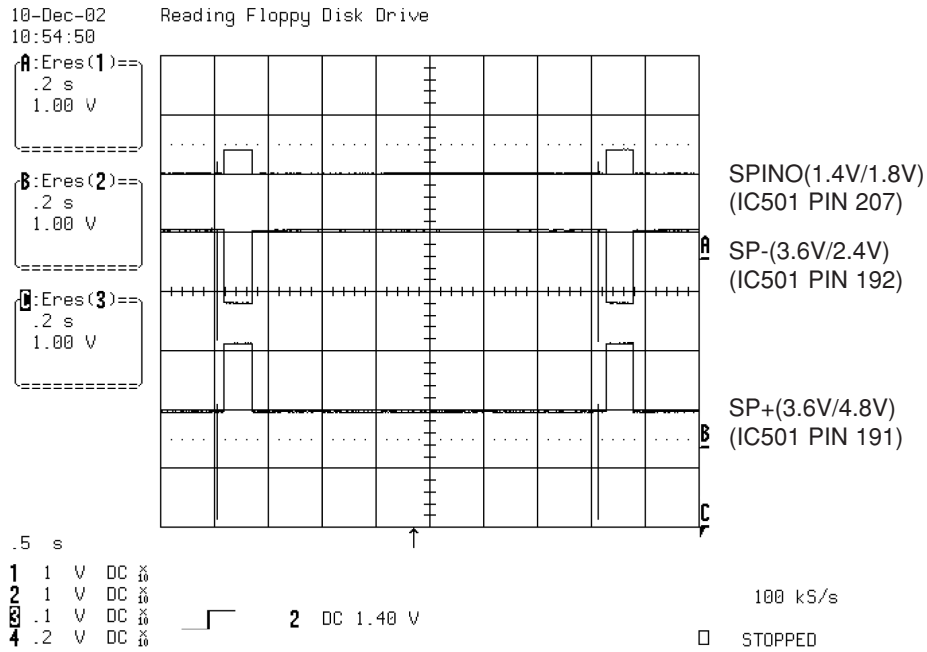

FIG 9-1

## 10. TRACKING CONTROL RELATED SIGNAL(System checking)

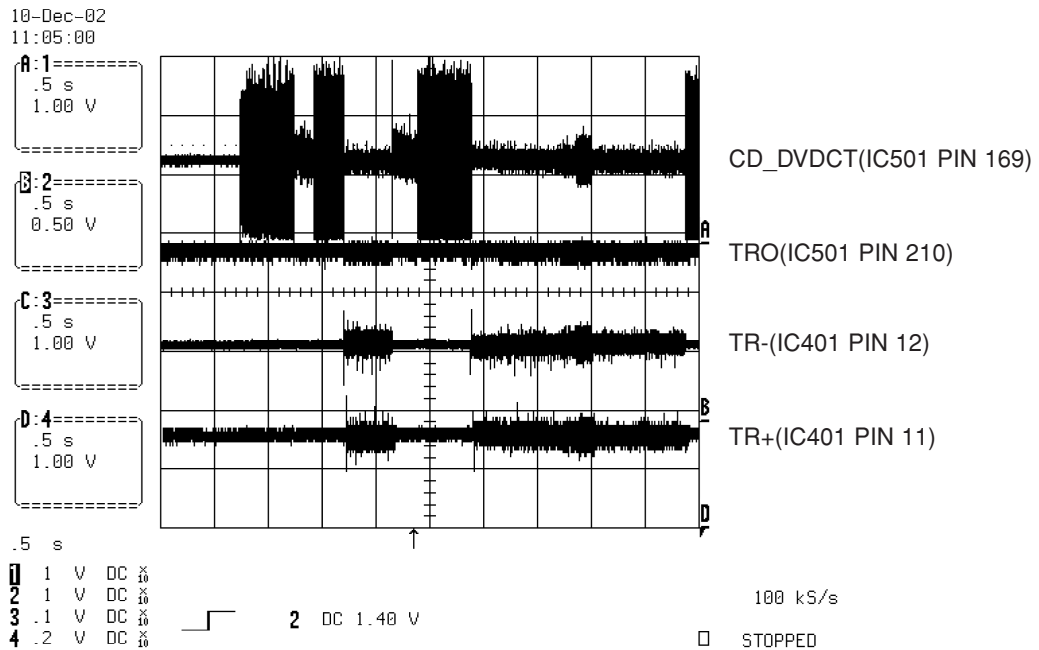

FIG 10-1(DVD)

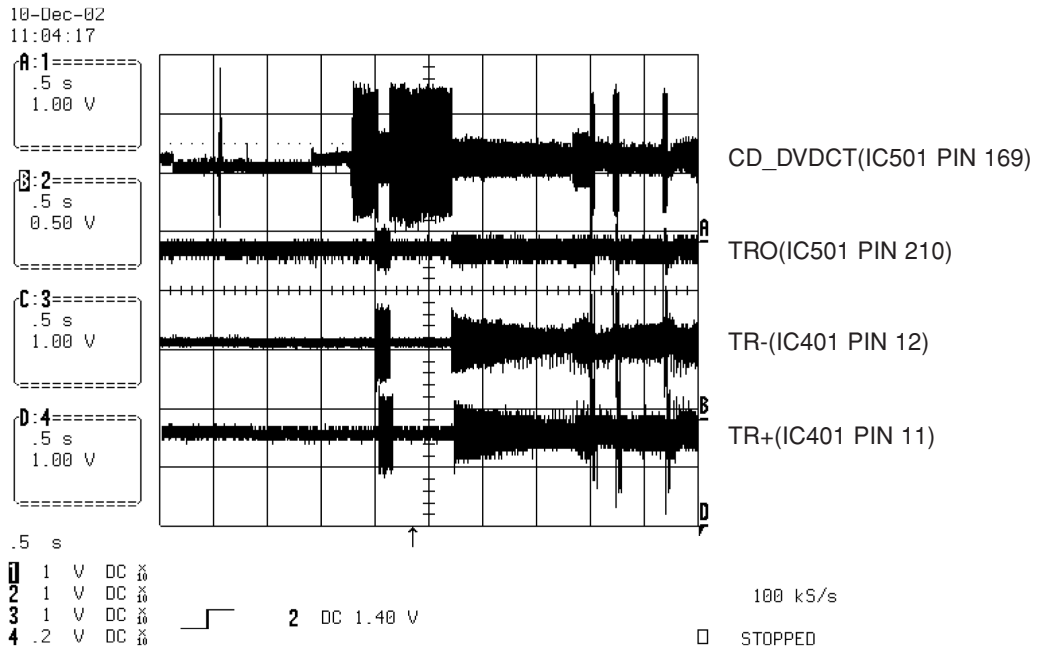

FIG 10-2(CD)

## 11. ES6698FD VIDEO OUTPUT WAVEFORMS

### 1) Full colorbar signal(COMPOSIT)

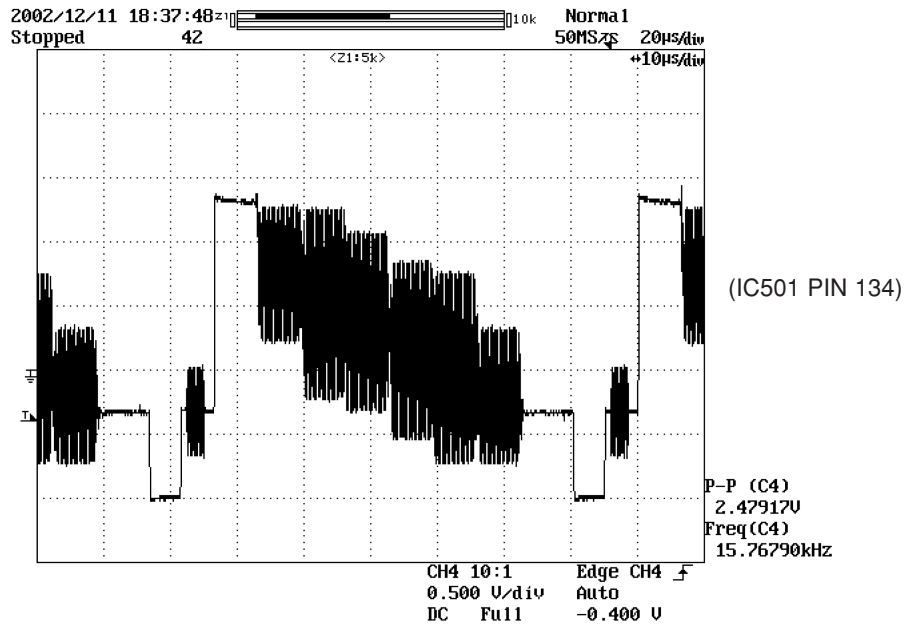

FIG 11-1

2) Y

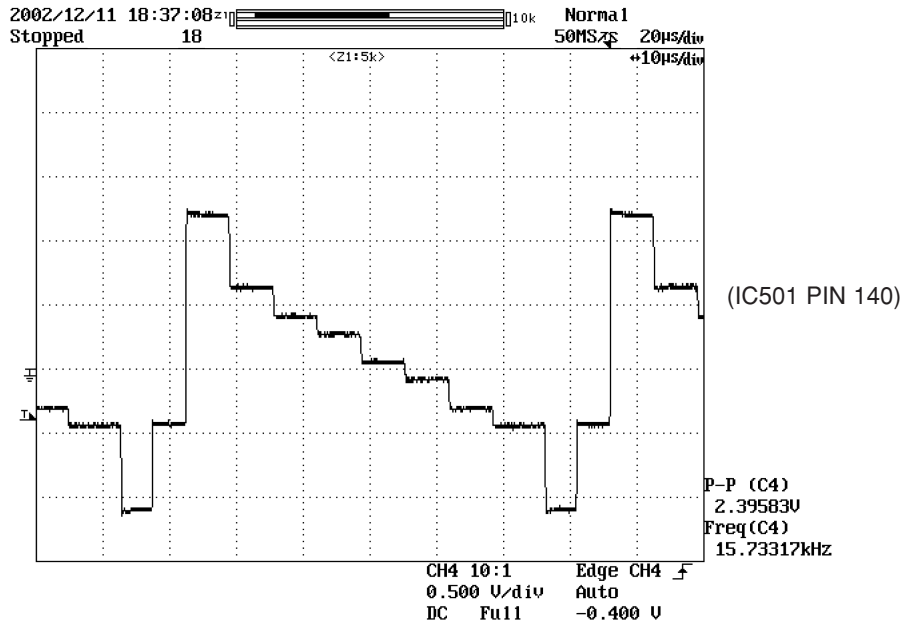

FIG 11-2

## 12. AUDIO OUTPUT FROM PWM IC

1) Audio L/R

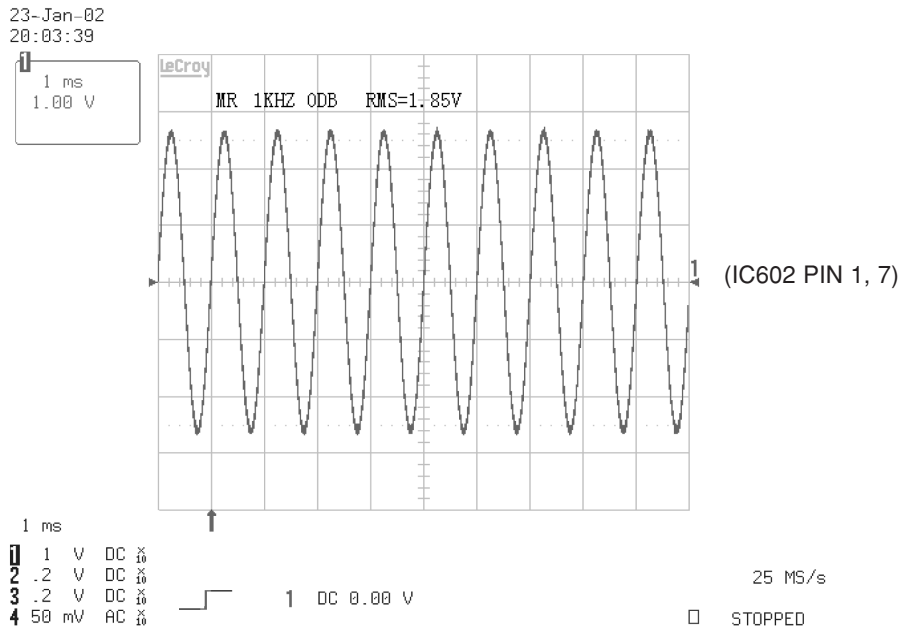

FIG 12-1

## 2) Audio related Signal

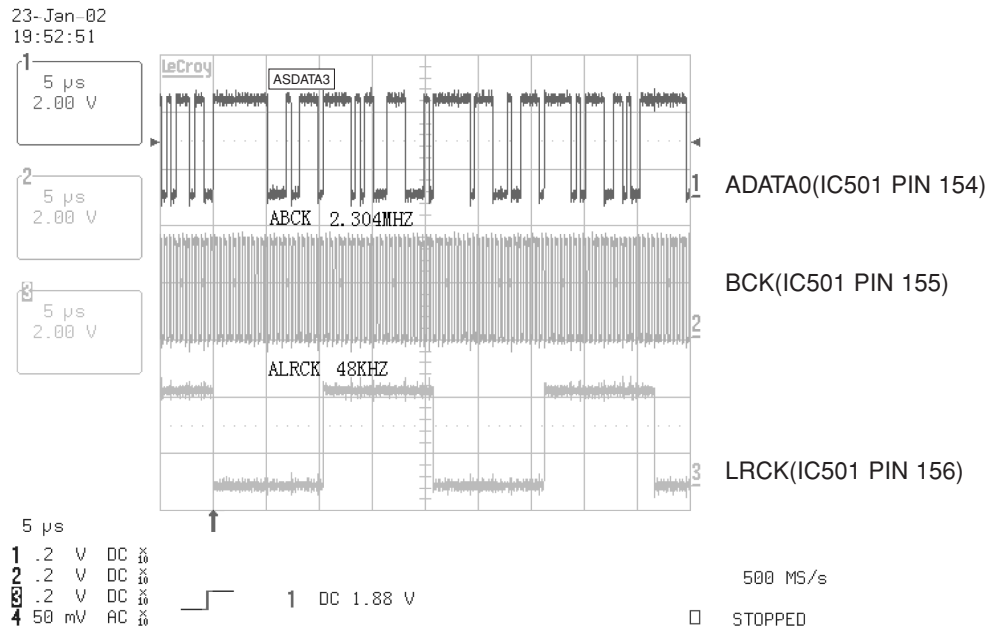
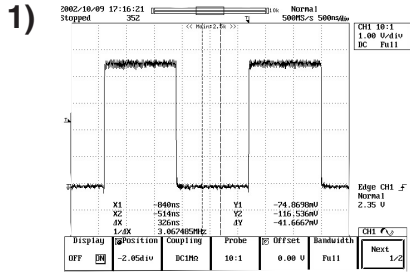
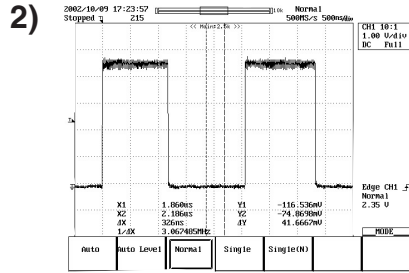

FIG 12-2

# 13. DVD & AMP WAVEFORMS



• R620 → TP611  
or  
R621 TP612



• R618 → TP609  
or  
R619 TP610

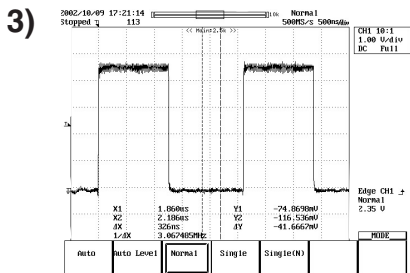

• R612 → TP603  
or  
R613 TP604

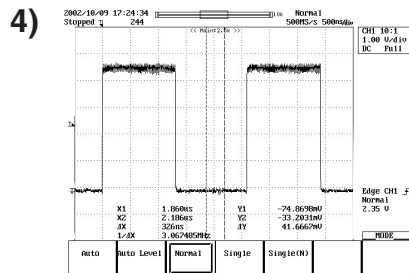

• R610 → TP601  
or  
R611 TP602

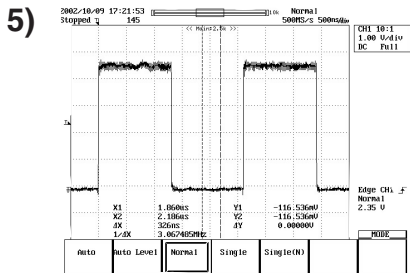

• R614 → TP605  
or  
R615 TP606

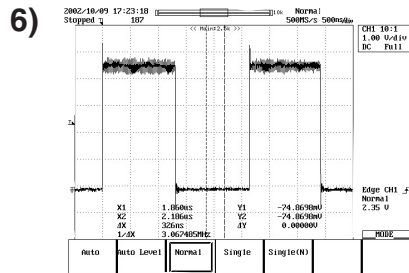

• R616 → TP607  
or  
R617 TP608

# AMP CIRCUIT DIAGRAMS

## 1. AMP CIRCUIT DIAGRAM

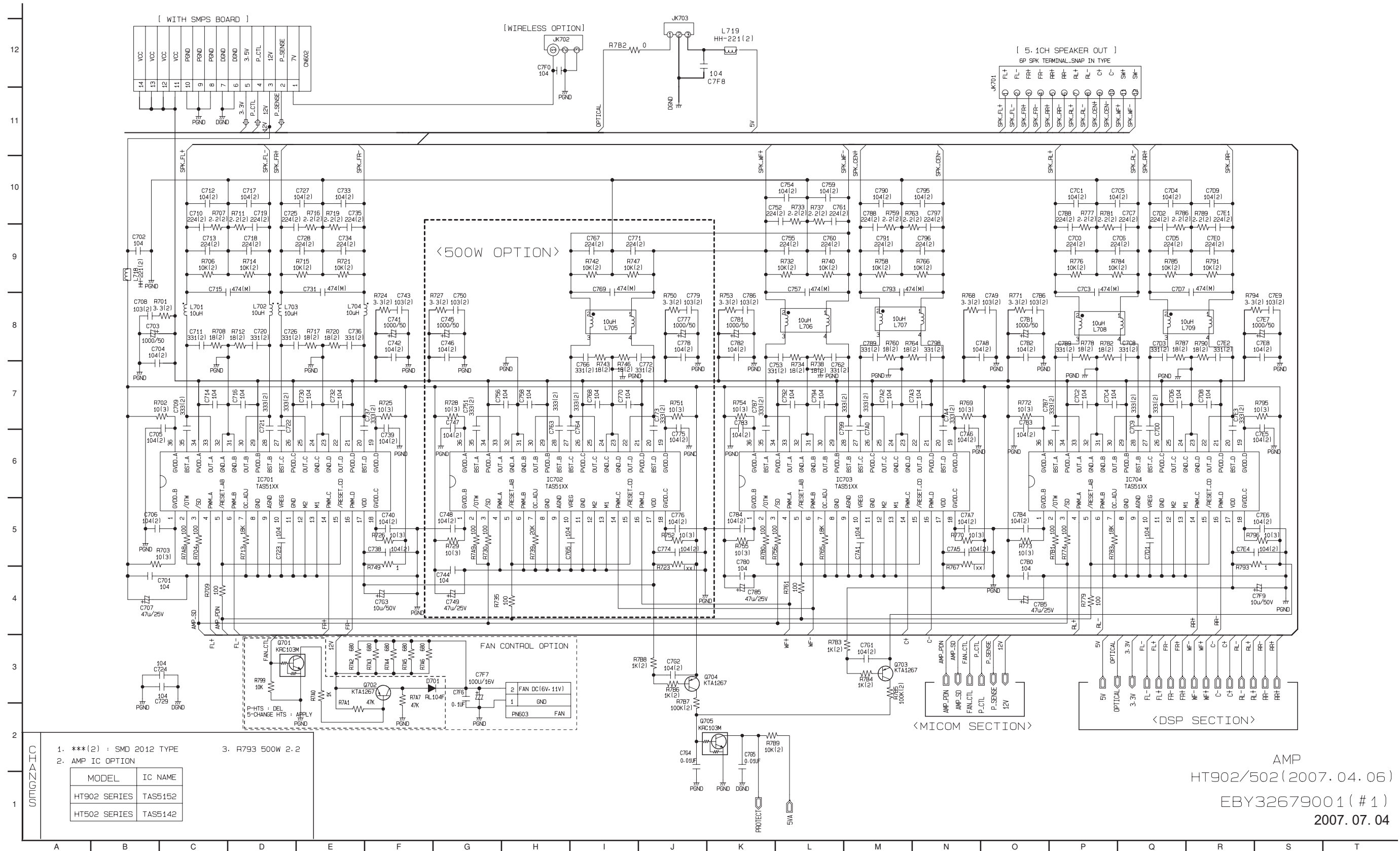

AMP  
 HT902/502 (2007. 04. 06)  
 EB532679001 (# 1)  
 2007. 07. 04



# 2. DSP CIRCUIT DIAGRAM

<< DSP SECTION >>

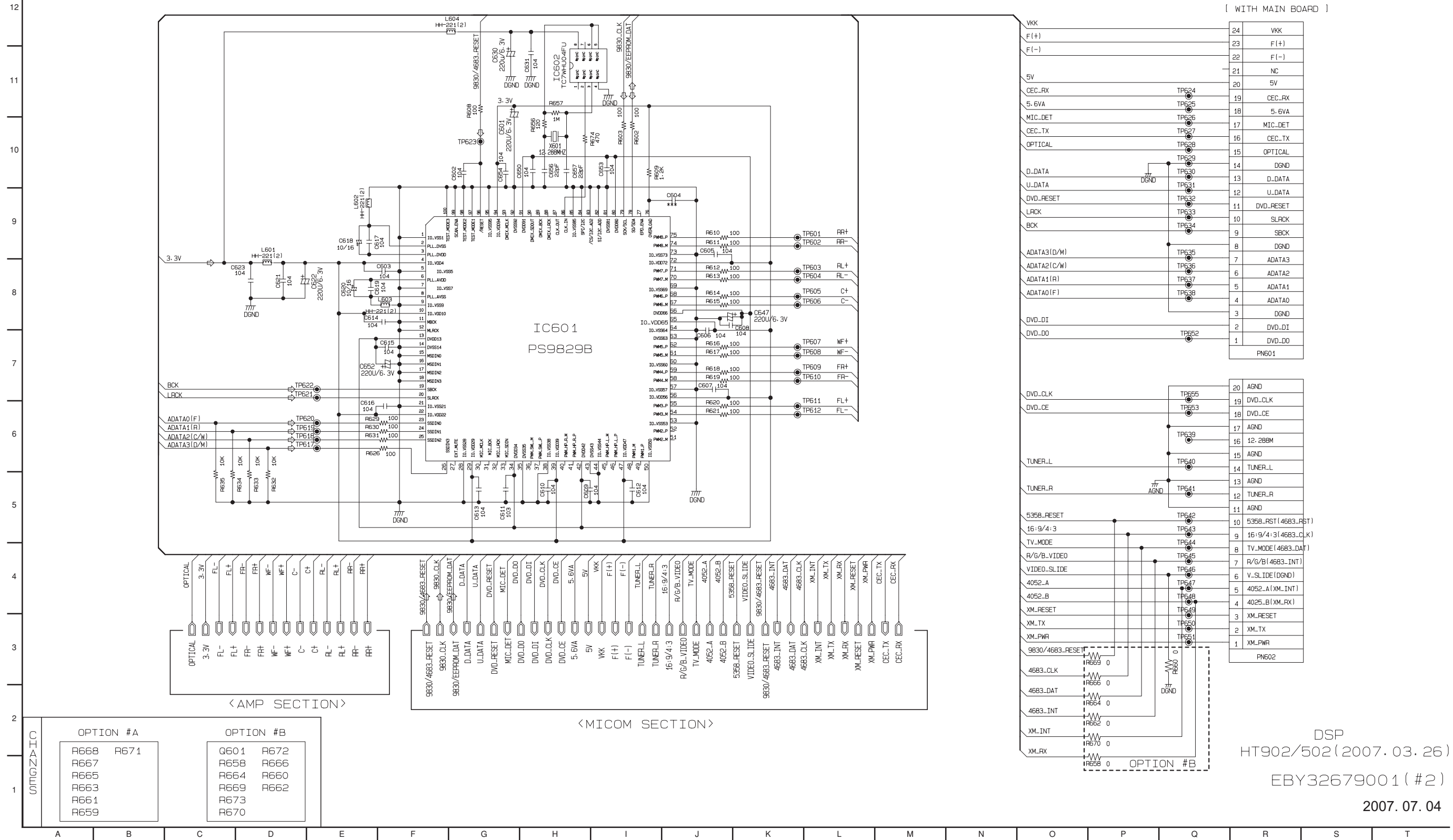

[ WITH MAIN BOARD ]

VKK	24	VKK
F(+)	23	F(+)
F(-)	22	F(-)
5V	21	NC
CEC_RX	20	5V
5.6VA	19	CEC_RX
MIC_DET	18	5.6VA
CEC_TX	17	MIC_DET
OPTICAL	16	CEC_TX
D_DATA	15	OPTICAL
U_DATA	14	DGND
DVD_RESET	13	D_DATA
LCK	12	U_DATA
BCK	11	DVD_RESET
ADATA3(D/M)	10	LCK
ADATA2(C/W)	9	BCK
ADATA1(R)	8	DGND
ADATA0(F)	7	ADATA3
DVD_DI	6	ADATA2
DVD_DO	5	ADATA1
	4	ADATA0
	3	DGND
	2	DVD_DI
	1	DVD_DO

PN601

DVD_CLK	20	AGND
DVD_CE	19	DVD_CLK
	18	DVD_CE
	17	AGND
TUNER_L	16	12.288M
TUNER_R	15	AGND
	14	TUNER_L
	13	AGND
	12	TUNER_R
	11	AGND
5358_RESET	10	5358_RST(4683_RST)
16:9/4:3	9	16:9/4:3(4683_CLK)
TV_MODE	8	TV_MODE(4683_DAT)
R/G/B_VIDEO	7	R/G/B(4683_INT)
VIDEO_SLIDE	6	V_SLIDE(DGND)
4052_A	5	4052_A(XM_INT)
4052_B	4	4052_B(XM_RX)
XM_RESET	3	XM_RESET
XM_TX	2	XM_TX
XM_RX	1	XM_RX

PN602

DSP  
HT902/502(2007.03.26)

EBY32679001(#2)

2007.07.04

OPTION #A		OPTION #B	
R668	R671	G601	R672
R667		R658	R666
R665		R664	R660
R663		R669	R662
R661		R673	
R659		R670	

### 3. MICOM CIRCUIT DIAGRAM

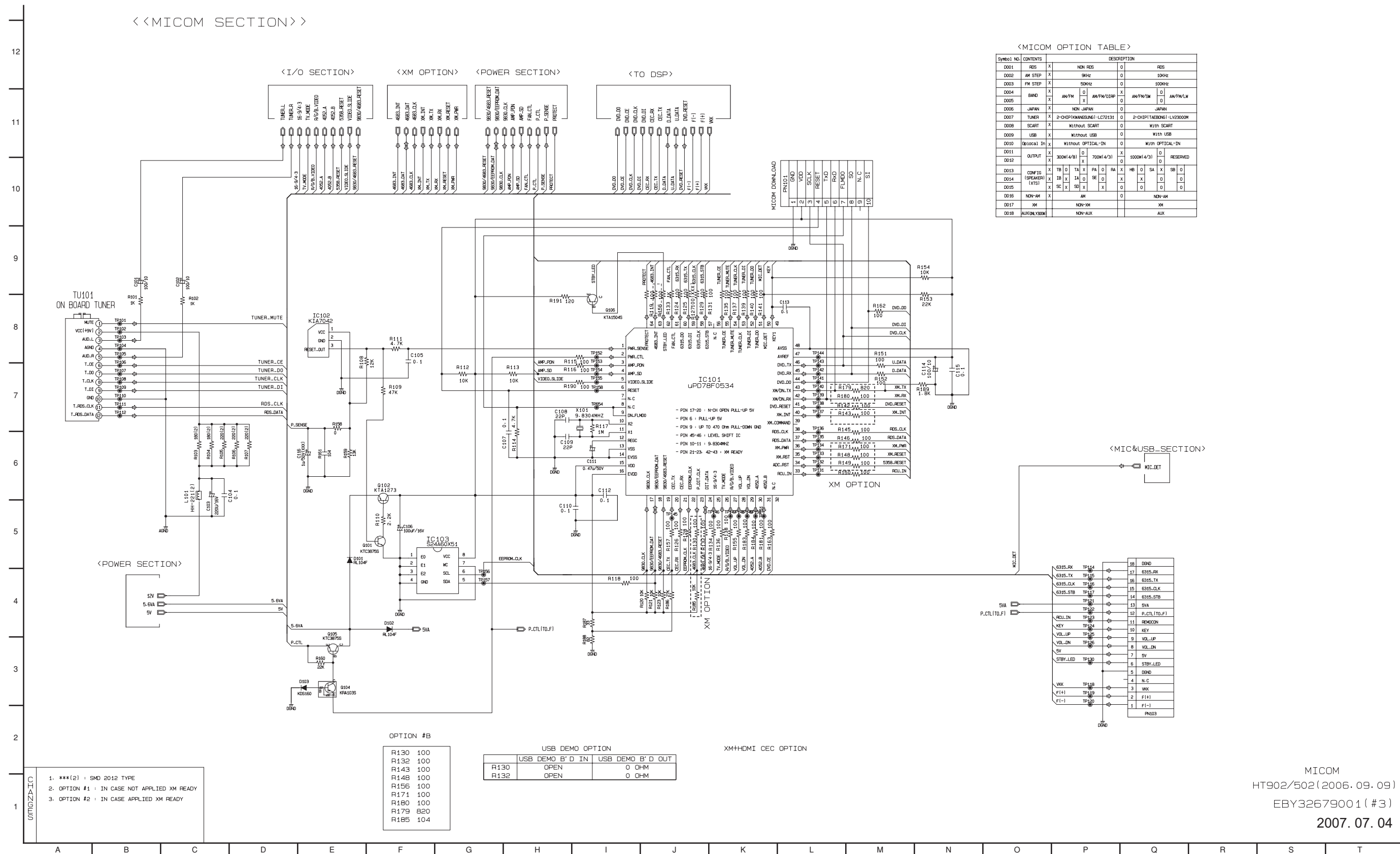

# PRINTED CIRCUIT BOARD DIAGRAMS

## 1. AMP P.C. BOARD (TOP VIEW)

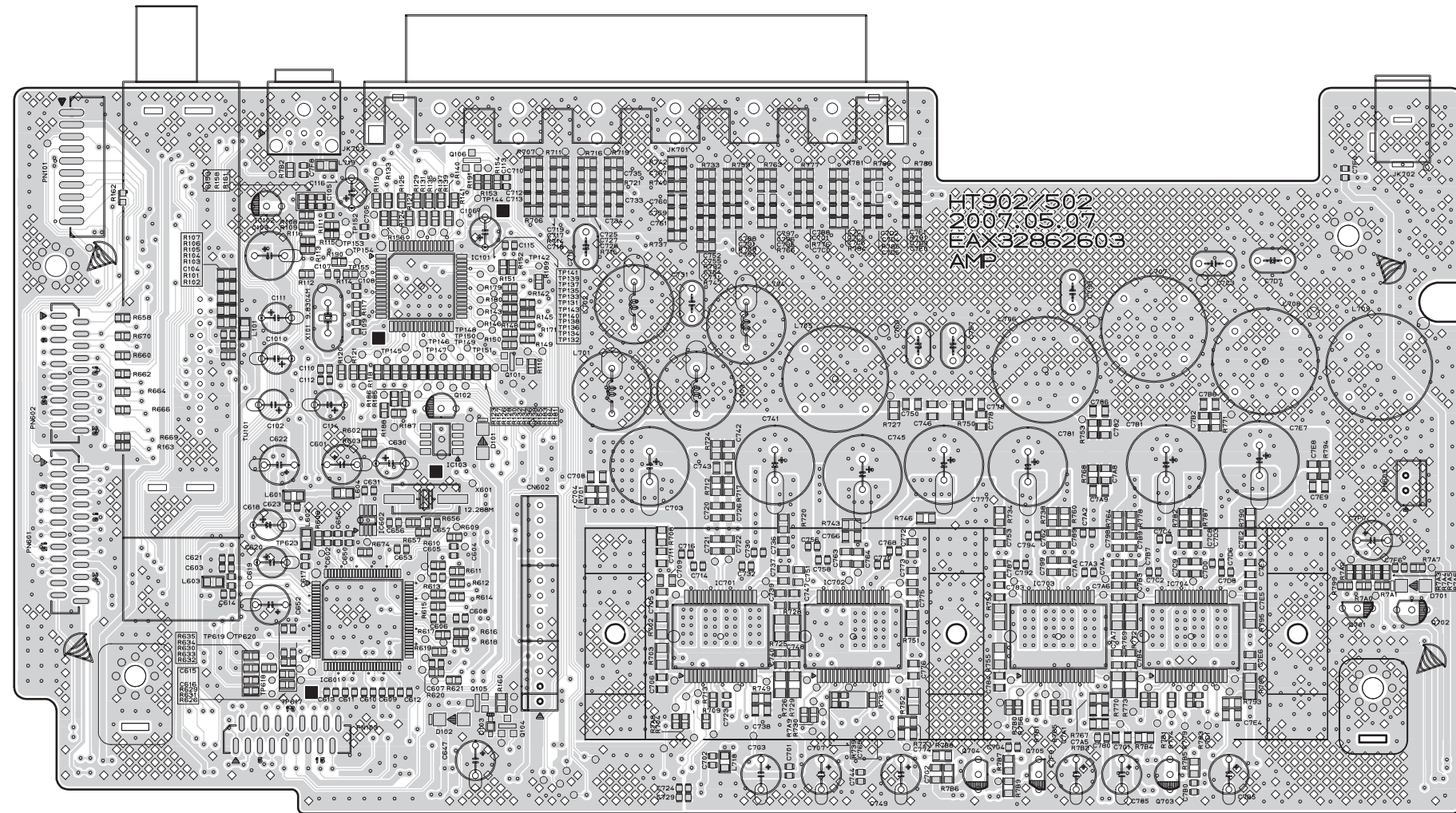



# AMP P.C. BOARD (BOTTOM VIEW)

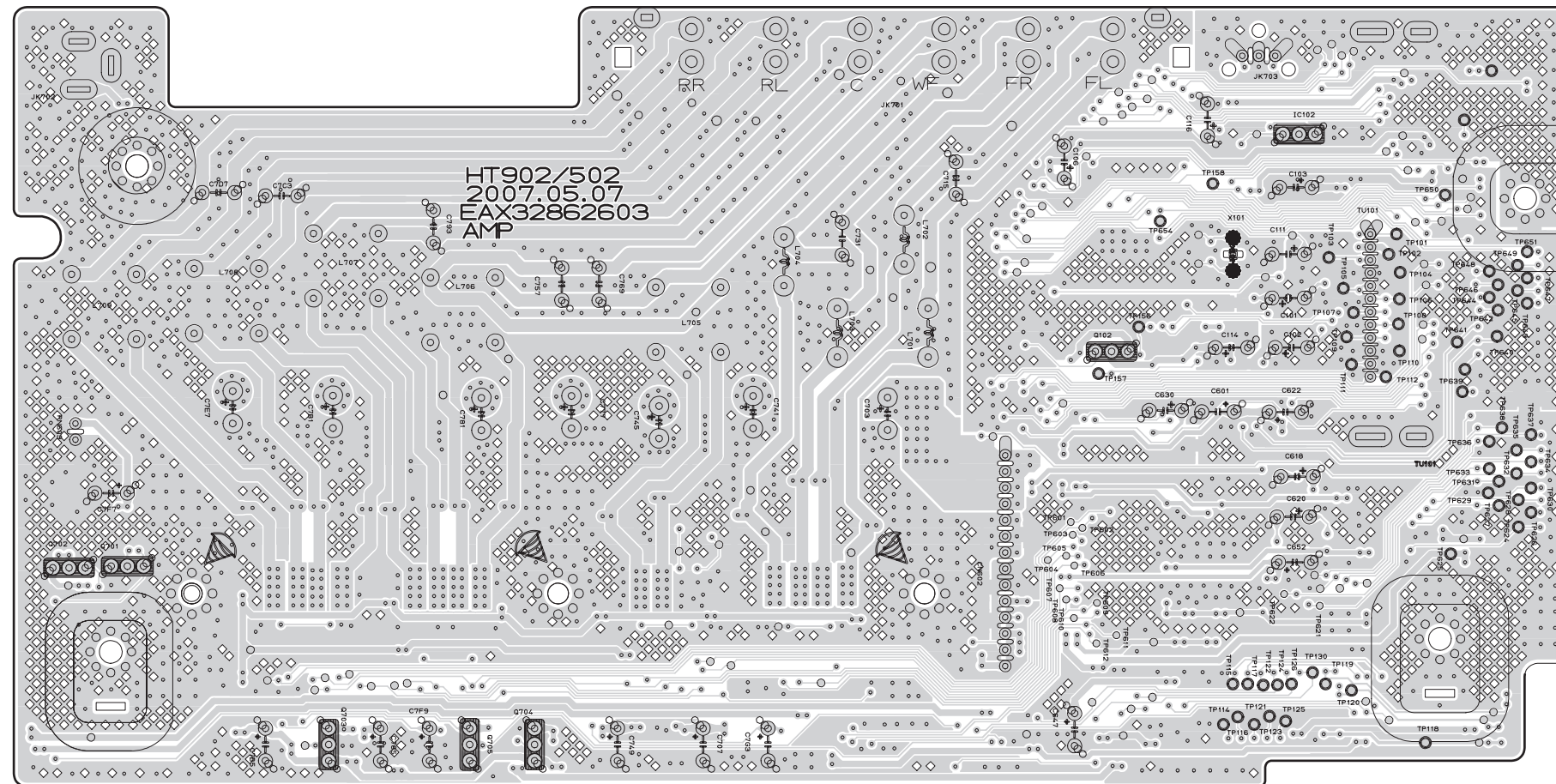

**MEMO**

Ruled lines for writing on the left page.

**MEMO**

Ruled lines for writing on the right page.

# SECTION 4. EXPLODED VIEWS

## • CABINET AND MAIN FRAME SECTION

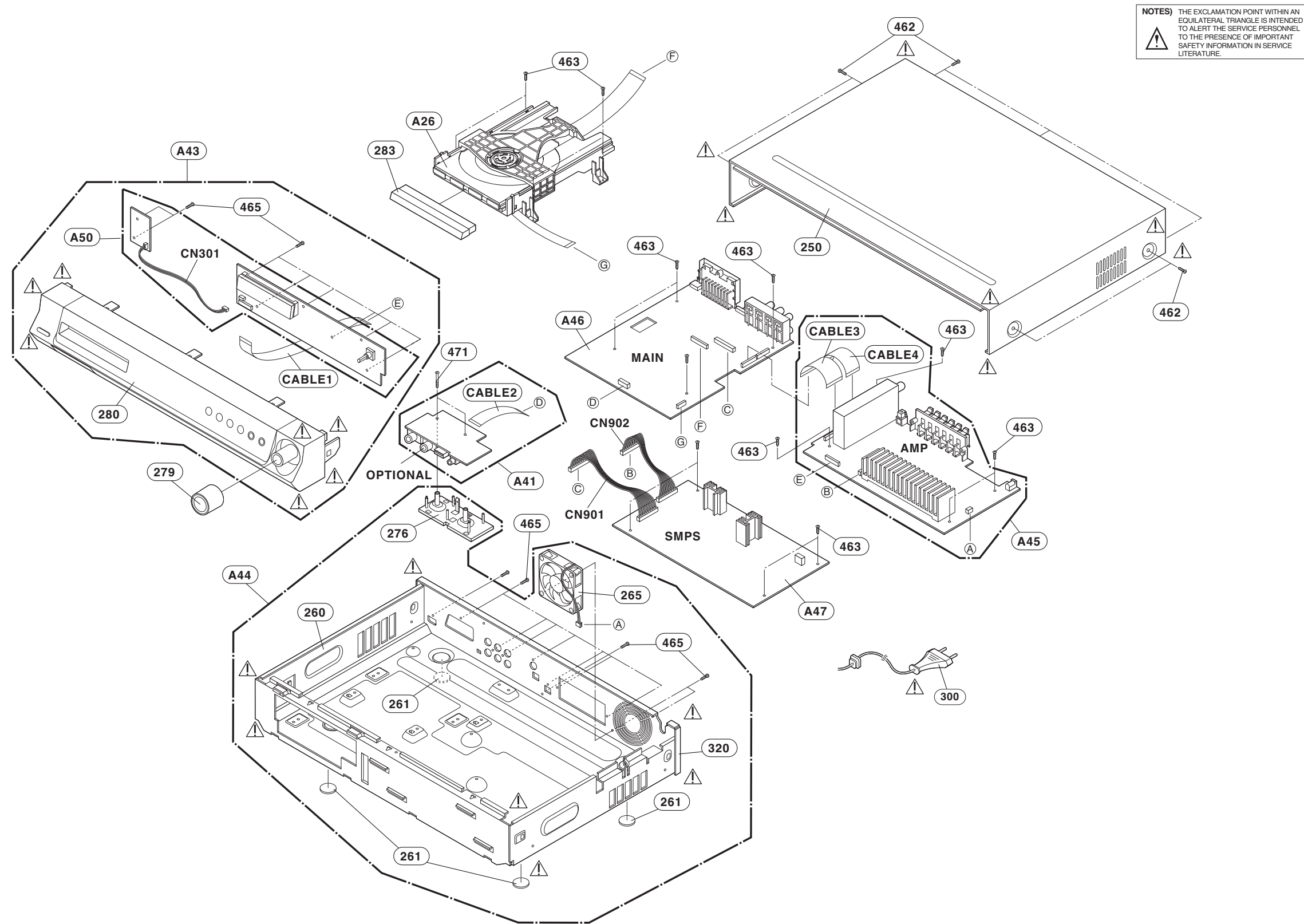

• DECK MECHANISM EXPLODED VIEW(DP-12A)

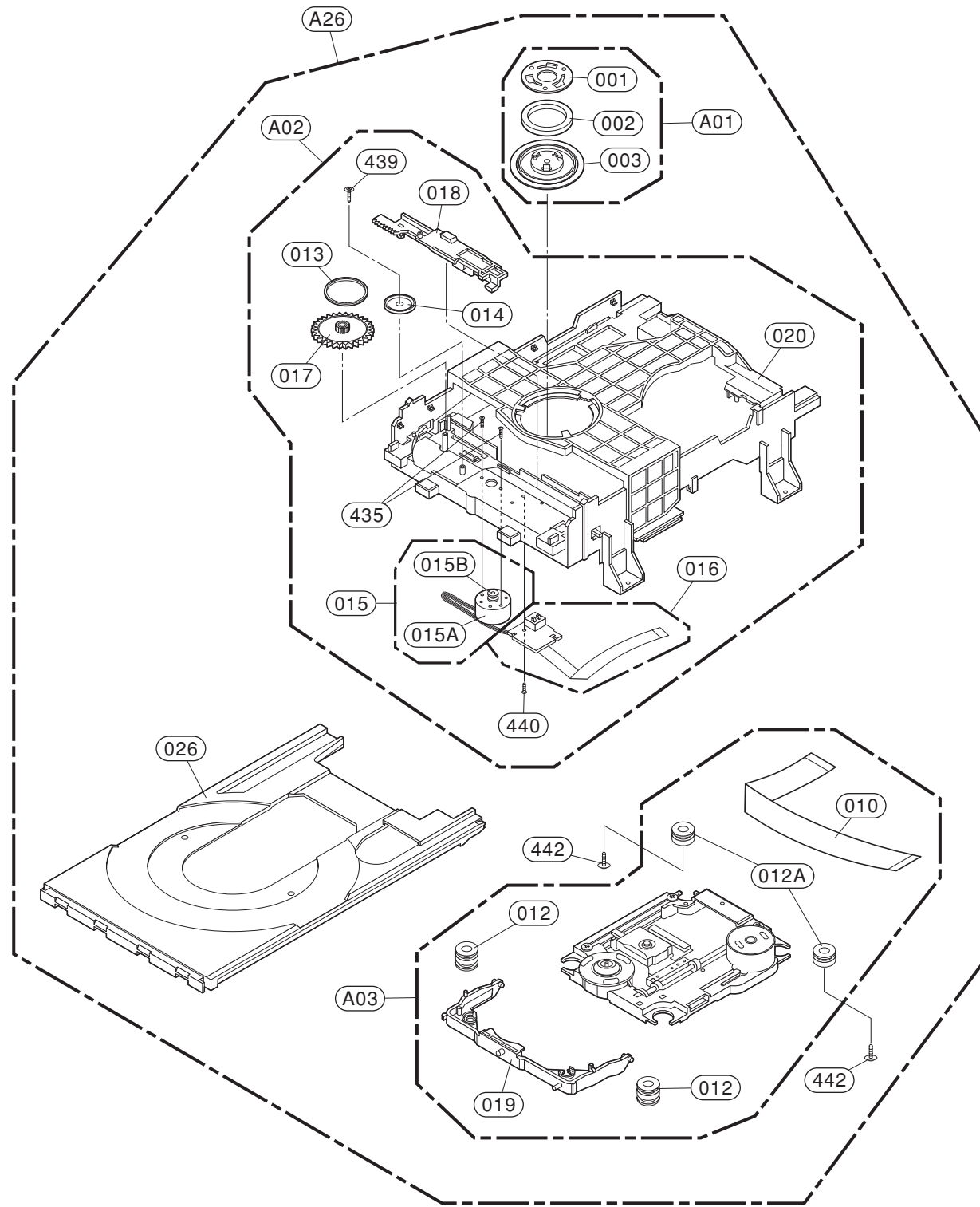

• PACKING ACCESSORY SECTION

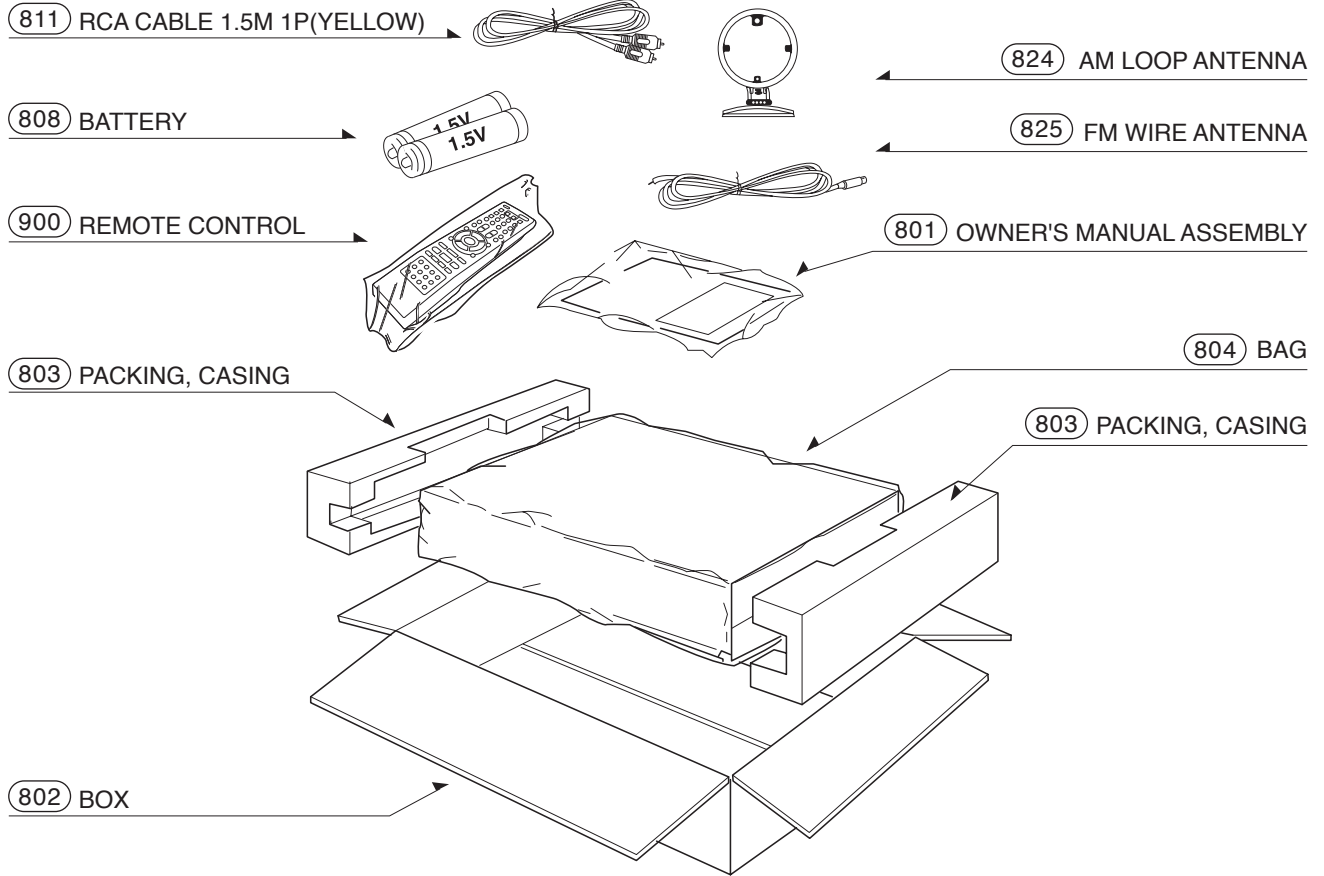





# SECTION 5. SPEAKER SECTION

## 1. SH52PH

### • CENTER SPEAKER(SH52PH-C)

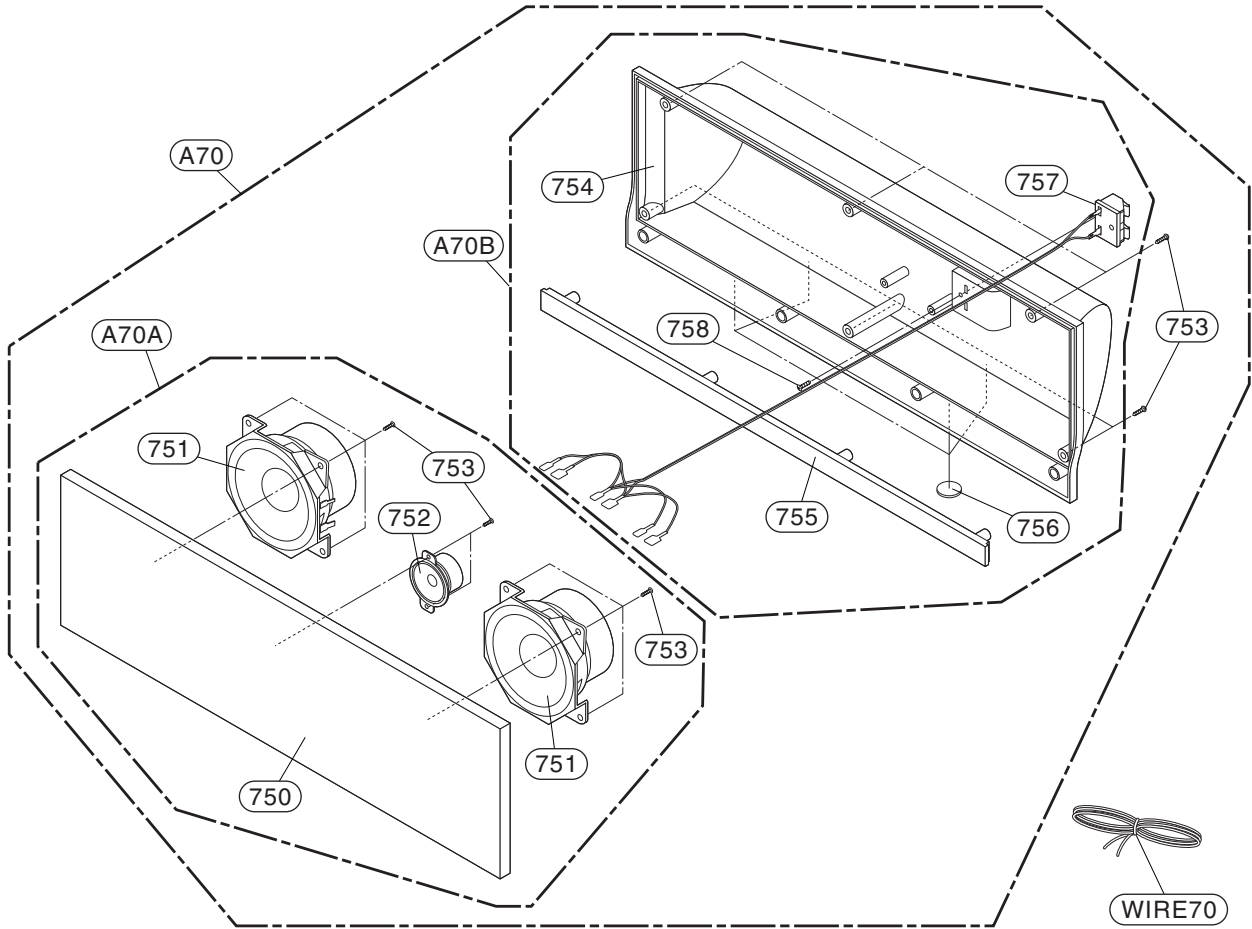

• FRONT SPEAKER(SH52PH-F)

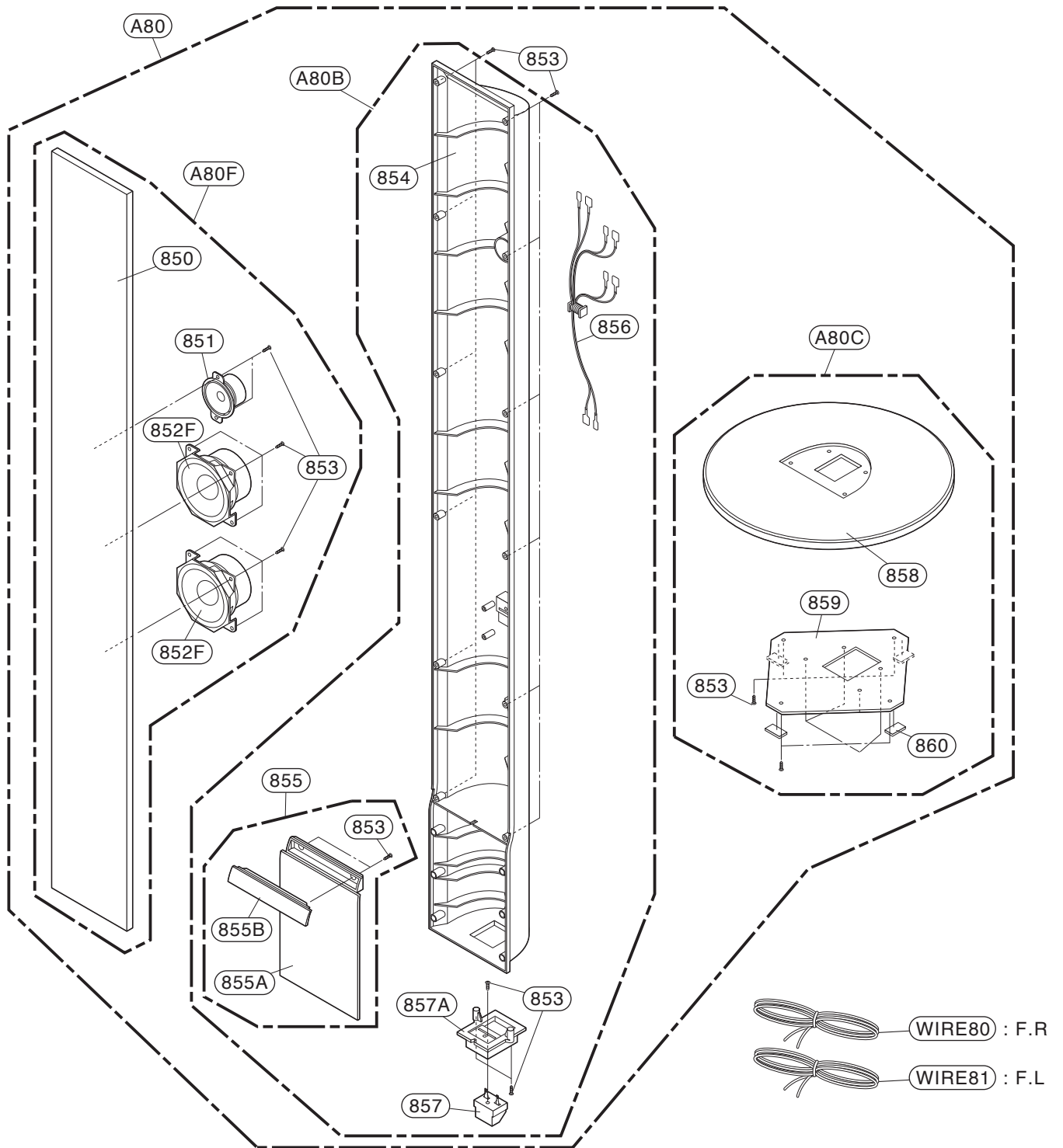

• REAR SPEAKER(SH52PH-S)

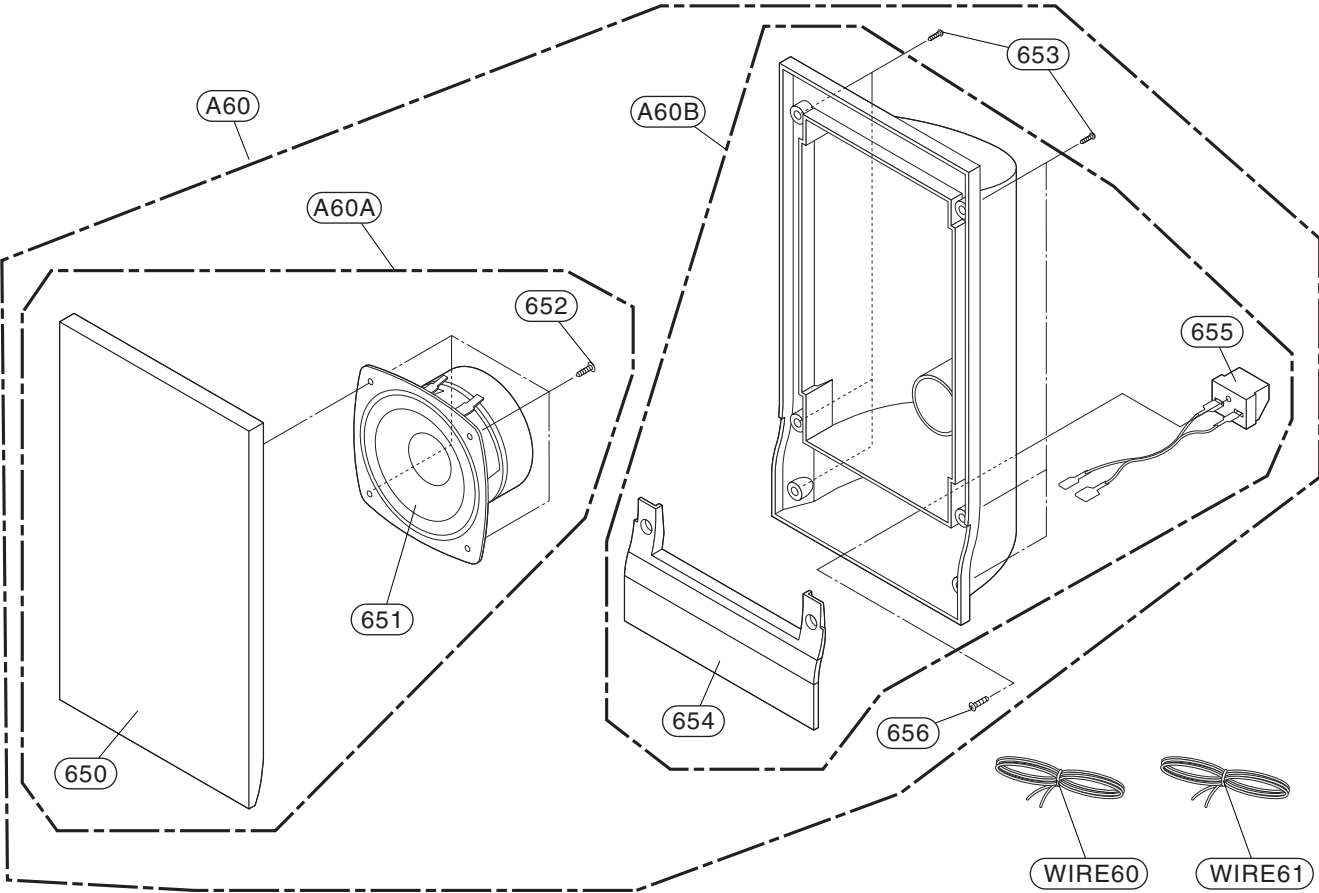

• PASSIVE SUBWOOFER(SH52PH-W)

