

SERVICE MANUAL

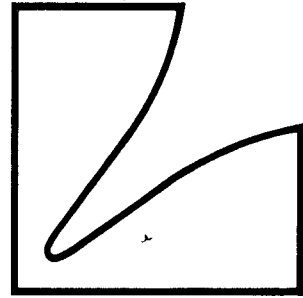

Ultimate Fidelity Stereo Control Center

CL-360

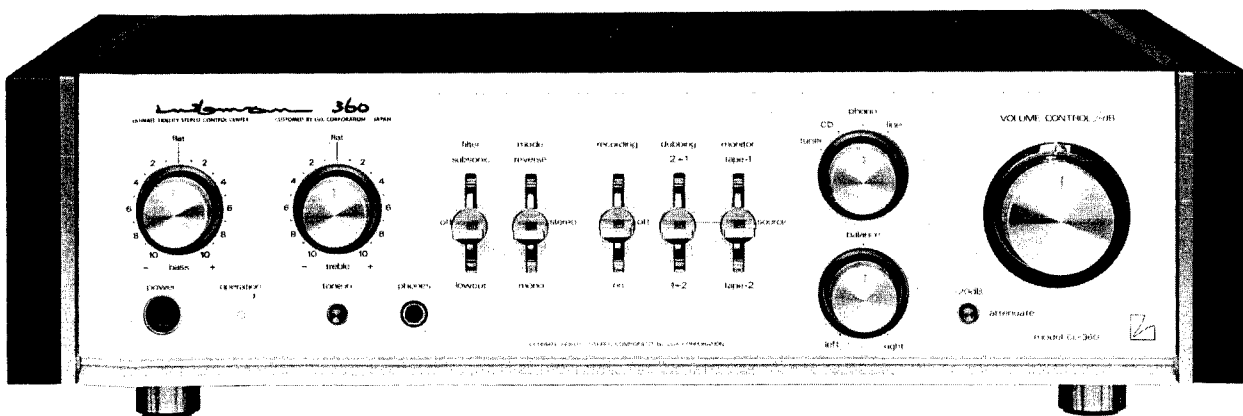

Contents

Specifications	3
Parts Locations and Disassembly Instructions	4 to 8
Block Diagram	9
Parts List by Specific Countries	10
Parts Layout on P.C. Boards and Wiring Diagram.	11 to 16
Electrical Parts List	17 to 20
Schematic Diagram	21 to 22
Exploded View (Cabinet)	23 to 24
Cabinet Assembly Parts List	25
Packing Method View.	26
Packing Assembly Parts List	27
Semiconductor Lead Identifications	28

Specifications

Input Sensitivity (1 kHz):

TUNER	170mV ±10%
CD	170mV ±10%
PHONO	1.7mV ±10%
LINE	170mV ±10%
MONITOR-1	170mV ±10%
MONITOR-2	170mV ±10%

Input Impedance (1 kHz):

TUNER	100K ohm ±20%
CD	100K ohm ±20%
PHONO	47K ohm ±20%
LINE	100K ohm ±20%
MONITOR-1	100K ohm ±20%
MONITOR-2	100K ohm ±20%

Frequency Response:

TUNER	10 ~ 100 kHz ±1 dB
CD	10 ~ 100 kHz ±1 dB
PHONO	100 Hz ±0.3 dB 10 kHz ±0.3 dB
(RIAA)	20 ~ 20 kHz ±0.5 dB
LINE	10 ~ 100 kHz ±1 dB
MONITOR-1	10 ~ 100 kHz ±1 dB
MONITOR-2	10 ~ 100 kHz ±1 dB

Total Harmonic Distortion:

CD Preout 20V (20 kHz)	0.5%
CD Preout 2V (1 kHz)	0.1%

Signal to Noise Ratio (PRE-OUT 2V):

TUNER	-84.5 dB
CD	-84.5 dB
PHONO	-60 dB
LINE	-84.5 dB
MONITOR-1	-84.5 dB
MONITOR-2	-84.5 dB

Residual Noise:

VOLUME MINIMUM	-86 dB
VOLUME MINIMUM (IHF A-weighted)	-100 dB

Cross Talk:

TUNER	-65 dB
CD	-65 dB
PHONO	-60 dB
LINE	-65 dB
MONITOR-1	-65 dB
MONITOR-2	-65 dB

Power Supply	100V, 50/60 Hz (For JA model only) 220V, 50 Hz (For FK model only)
--------------	---

Headphone Output (8 ohm, 1 kHz)	200mW
---------------------------------	-------

Semiconductors	4 IC's, 18 Transistors, 29 Diodes, 3 Zener Diodes
----------------	---

Dimensions	493(W) x 142(H) x 402(D) mm
------------	-----------------------------

Weight	11.5 kg
--------	---------

NOTE: Due to continuing product improvement, specifications and design and subject to change without notice.

Parts Locations and Disassembly Instructions

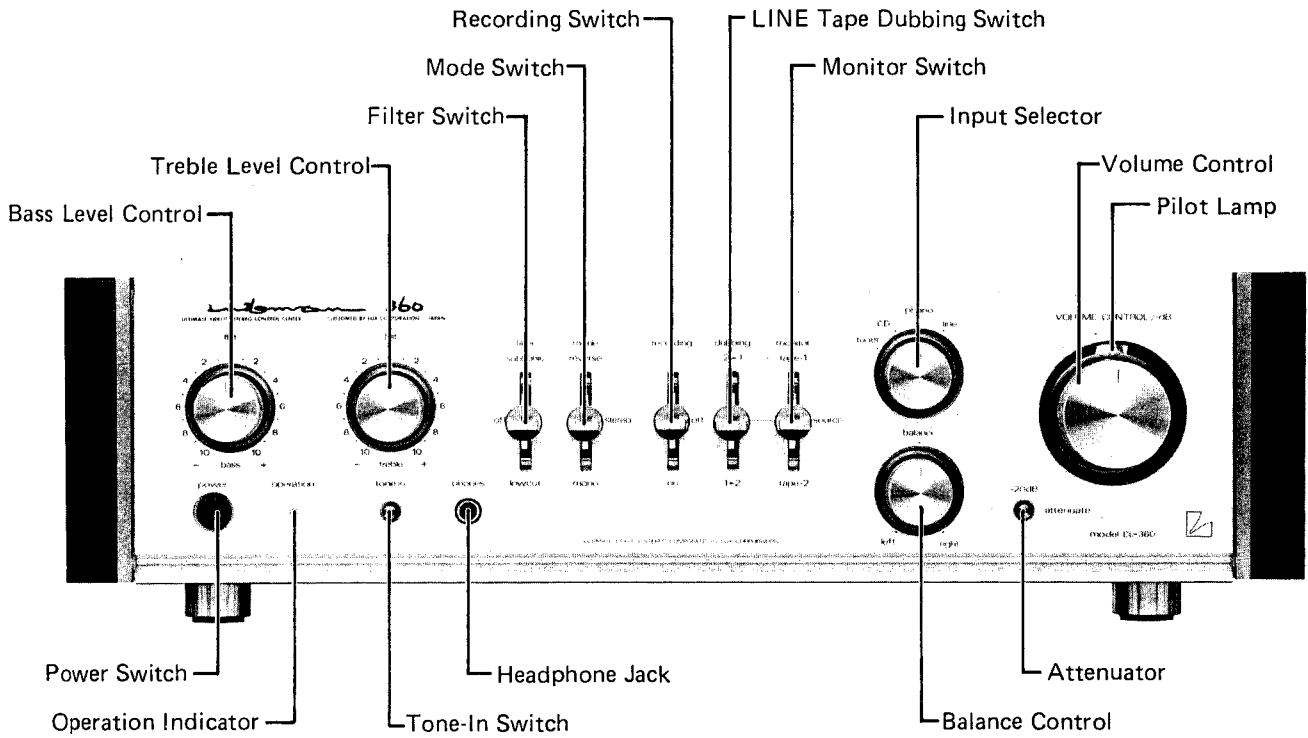

Figure 1

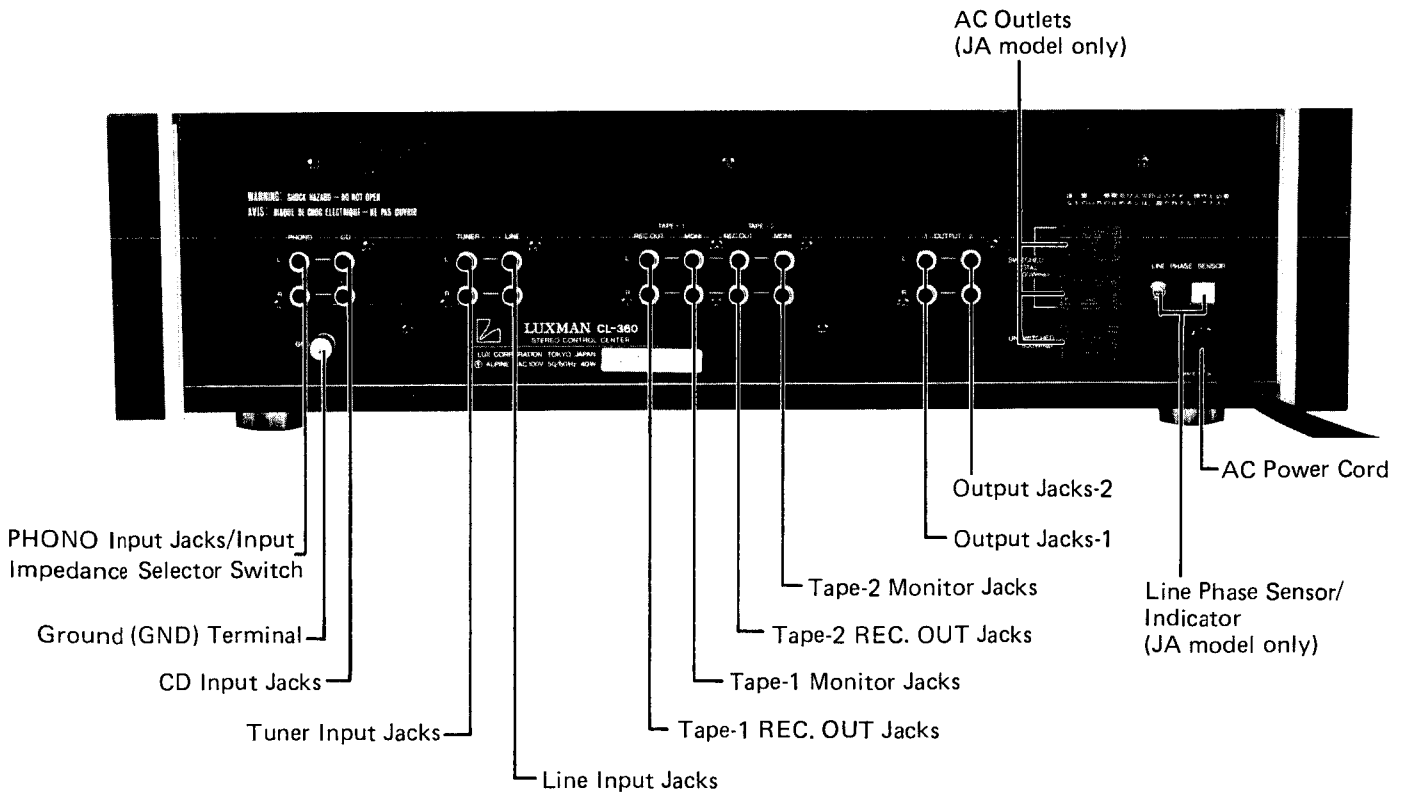

Figure 2

1. Removal of Top Cover

- (1) Remove three screws marked "○" as shown in Figure 4.
- (2) Pull out the top cover in the arrow direction as shown in Figure 3.

2. Removal of Bottom Cover

- (1) Remove four screws marked "△" and four Brackets as shown in Figure 5.

3. Removal of Front Panel

- (1) Remove knob TC (bass, treble, phono, balance), volume control knob, by the hexagon socket screw keys ($\phi 4$) and remove knob lever (filter, mode recording, dubbing, monitor) by the hexagon socket screw keys ($\phi 2.6$) as shown in Figure 3.
- (2) Remove six screws marked "□" as shown in Figures 6 and 7.

4. Removal of Wood Cab. (L), (R)

- (1) After removal of top cover, remove eight screws marked "☆" as shown in Figures 3, 5 and 6.

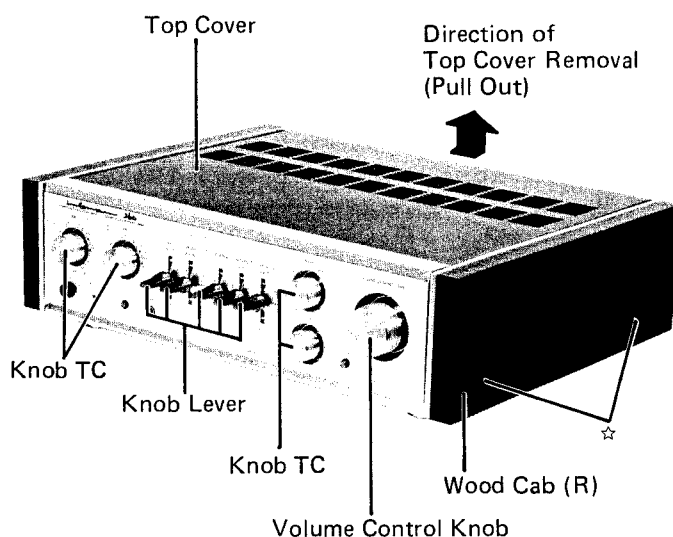

Figure 3

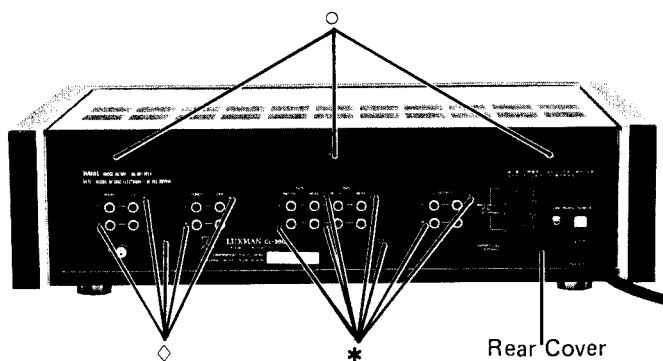

Figure 4

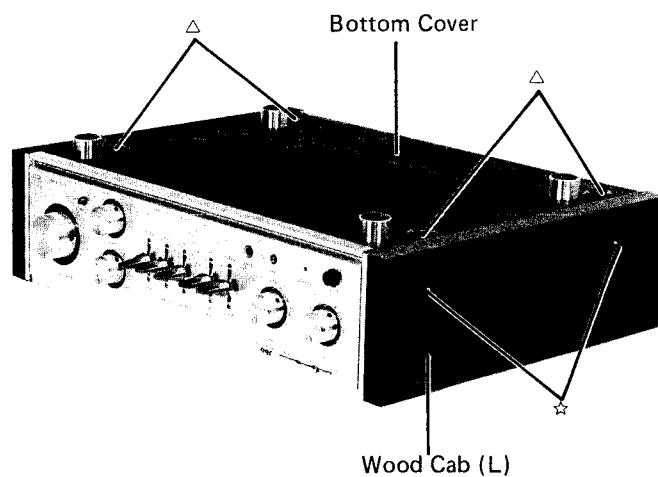

Figure 5

5. Removal of Front Chassis

- (1) After removal of wood cab (L), (R), remove four screws marked "※" as shown in Figure 8.
- (2) Front chassis with T.C. BASS P.C. Board, T.C. Switch P.C. Board, LED P.C. Board, Headphone Jack P.C. Board, Lever Switch P.C. Board, Function P.C. Board, Balance P.C. Board, and Volume P.C. Board can be removed completely.

6. Removal of T.C. BASS P.C. Board

- (1) Remove nut (a), washer (a) and washer T.L (a) as shown in Figure 8.
- (2) Disconnect all wires from the T.C. BASS P.C. Board.

7. Removal of T.C. Switch P.C. Board

- (1) Remove nut (b), washer (b), washer T.L (b), and one screw marked "●" as shown in Figure 8.
- (2) Disconnect all wires from the T.C. Switch P.C. Board.

8. Removal of LED P.C. Board

- (1) Remove one rivet push marked "▲" as shown in Figure 9.
- (2) Disconnect one connector from the LED P.C. Board.

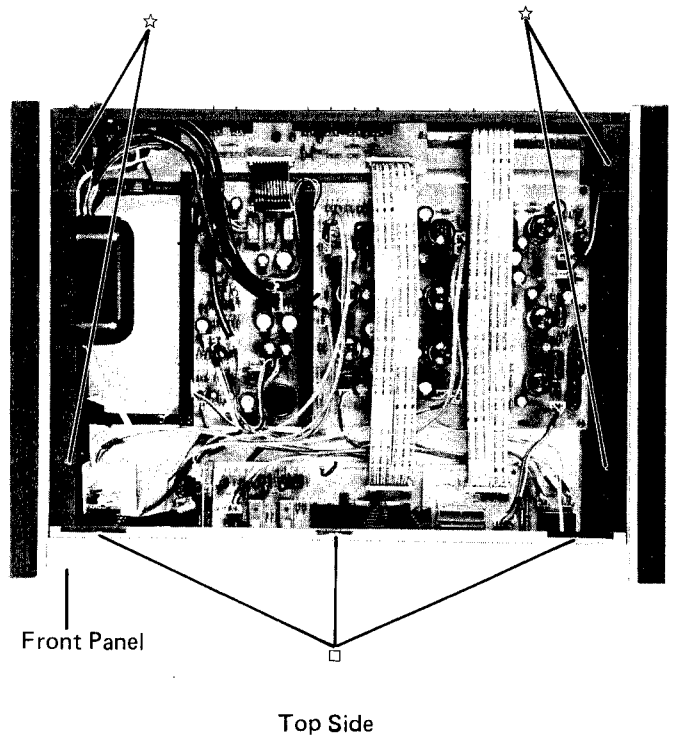

Figure 6

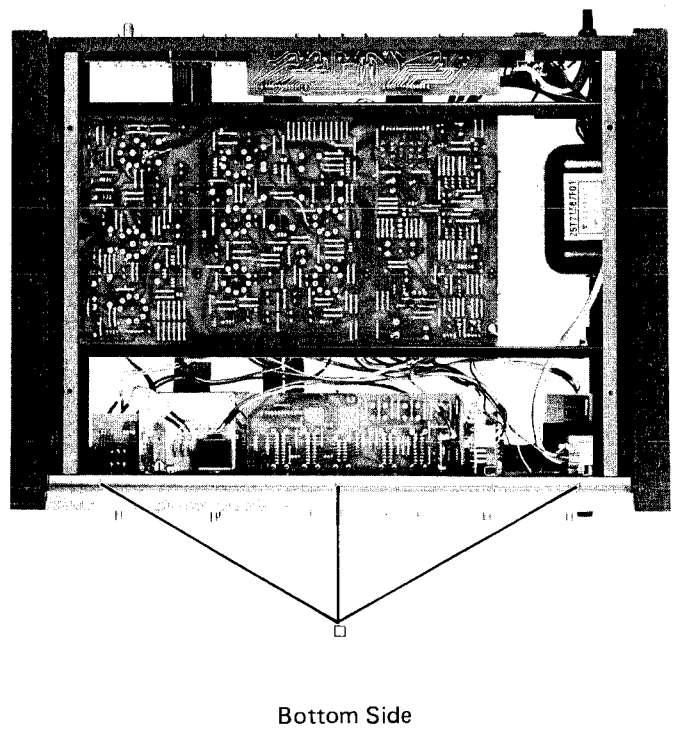

Figure 7

9. Removal of Headphone Jack P.C. Board

- (1) Remove nut (f), and washer (f) as shown in Figure 8.
- (2) Disconnect one connector from the Headphone Jack P.C. Board.

10. Removal of Lever Switch P.C. Board

- (1) Remove five escutcheon lever switches and five screws marked "■" as shown in Figure 8.
- (2) Disconnect all wires from the Lever Switch P.C. Board.

11. Removal of Function P.C. Board

- (1) Remove nut (c), washer (c) and washer T.L (c) as shown in Figure 8.
- (2) Disconnect all wires from the Function P.C. Board.

12. Removal of Balance P.C. Board

- (1) Remove nut (e), washer (e), washer T.L (e), and one screw marked "★" as shown in Figure 8.
- (2) Disconnect all wires from the Balance P.C. Board.

13. Removal of Volume P.C. Board

- (1) Remove nut (d), washer (d) and washer T.L (d) as shown in Figure 8.
- (2) Disconnect all wires from the Volume P.C. Board.

14. Removal of Input P.C. Board

- (1) Remove five screws marked "◇" as shown in Figure 4.
- (2) Disconnect all wires from the Input P.C. Board.

15. Removal of Output P.C. Board

- (1) Remove seven screws marked "★" as shown in Figure 4.
- (2) Disconnect all wires from the Output P.C. Board.

16. Removal of Main P.C. Board

- (1) Remove nine screws marked "#" as shown in Figure 10.
- (2) Disconnect all wires from the Main P.C. Board.

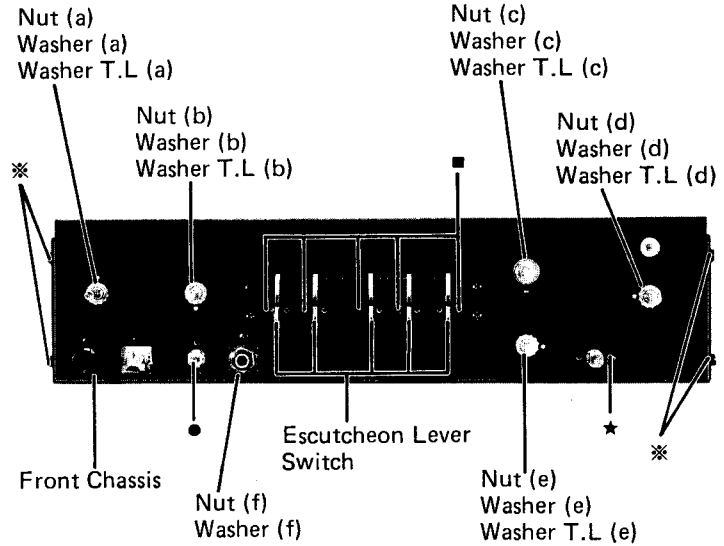

Figure 8

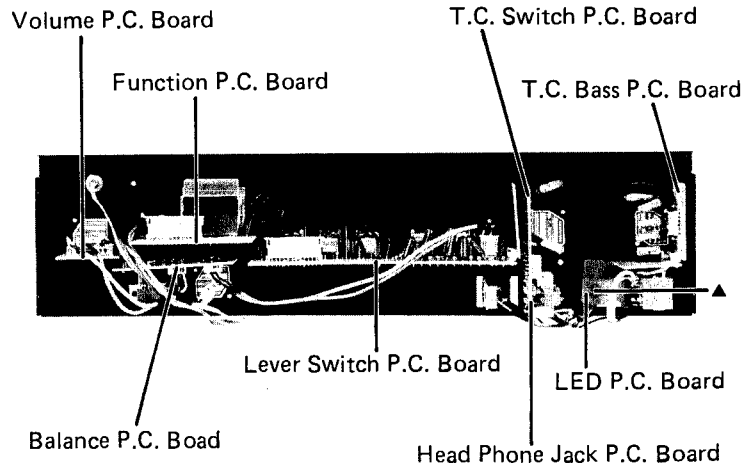

Figure 9

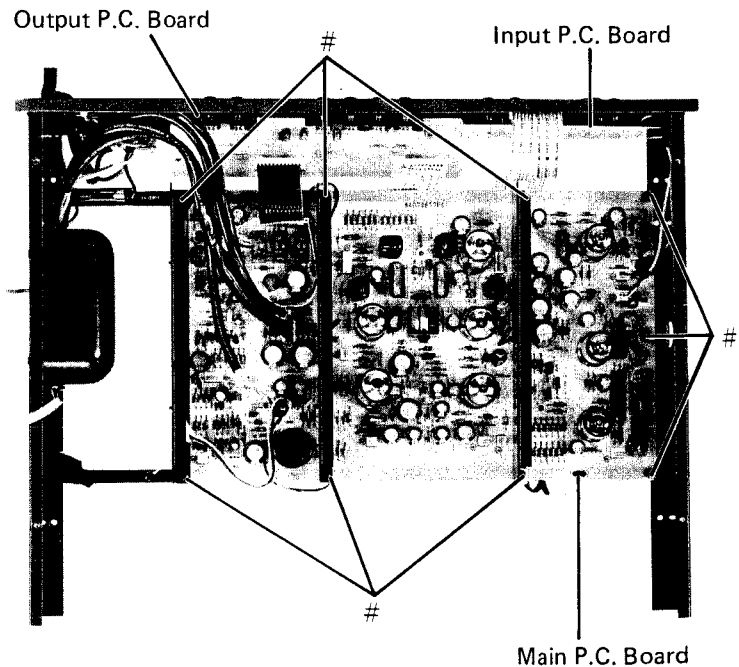

Figure 10

分解方法

1. 上面カバーの外し方

- (1) 3本のネジ“○”を外します。(図4参照)
- (2) 上面カバーを矢印の方向に引っ張り出して外します。(図3参照)

2. 底面カバーの外し方

- (1) 4本のネジ“△”と4個のブラケットを外しますと底面カバーは外れます。(図5参照)

3. 前面パネルの外し方

- (1) TCつまみ(バス, トレブル, フォノ, バランス), ボリューム・コントロールつまみは、六角穴付止めネジ(φ4)をゆるめて外し、レバーつまみ(フィルター, モード, レコーディング, ダビング, モニター)は、六角穴付止めネジ(φ2.6)をゆるめて外します。
- (2) 6本のネジ“□”印を外しますと前面パネルは外れます。(図6, 7参照)

4. 木目キャビネット(L), (R)の外し方

- (1) 上面カバーを外した後、8本のネジ“☆”印を外しますと木目キャビネット(L), (R)は外れます。(図3, 5, 6参照)

5. 前面シャーシの外し方

- (1) 木目キャビネット(L), (R)を外した後、4本のネジ“※”印を外します。(図8参照)
- (2) T.C.バス基板, T.C.スイッチ基板, LED基板, ヘッドホンジャック基板, レバースイッチ基板, ファンクション基板, バランス基板, ボリューム基板と共に前面シャーシを外すことができます。

6. T.C.バス基板の外し方

- (1) ナット(a), ワッシャー(a), ワッシャーT.L(a)を外します。(図8参照)
- (2) T.C.バス基板から全部のワイヤを離しますと、T.C.バス基板は外れます。

7. T.C.スイッチ基板の外し方

- (1) ナット(b), ワッシャー(b), ワッシャーT.L(b)とネジ“●”印1本を外します。(図8参照)
- (2) T.C.スイッチ基板から全部のワイヤを離しますとT.C.スイッチ基板は外れます。

8. LED基板の外し方

- (1) 1本のプッシュ“▲”印を外します。(図9参照)
- (2) LED基板から1個のコネクターを離しますとLED基板は外れます。

9. ヘッドホンジャック基板の外し方

- (1) ナット(f), ワッシャー(f)を外します。(図8参照)
- (2) ヘッドホンジャック基板から1個のコネクターを離しますとヘッドホンジャック基板は外れます。

10. レバースイッチ基板の外し方

- (1) 5個のエスカレーションレバースイッチと5本のネジ“■”印を外します。(図8参照)
- (2) レバースイッチ基板から全部のワイヤを離しますとレバースイッチ基板は外れます。

11. ファンクション基板の外し方

- (1) ナット(c), ワッシャーT.L(c)を外します。(図8参照)
- (2) ファンクション基板から全部のワイヤを離しますとファンクション基板は外れます。

12. バランス基板の外し方

- (1) ナット(e), ワッシャー(e), ワッシャーT.Lと1本のネジ“★”印を外します。(図8参照)
- (2) バランス基板から全部のワイヤを離しますとバランス基板は外れます。

13. ボリューム基板の外し方

- (1) ナット(d), ワッシャー(d), ワッシャーT.L(d)を外します。(図8参照)
- (2) ボリューム基板から全部のワイヤを離しますとボリューム基板は外れます。

14. 入力基板の外し方

- (1) 5本のネジ“◇”を外します。(図4参照)
- (2) 入力基板から全部のワイヤを離しますと入力基板は外れます。

15. 出力基板の外し方

- (1) 7本のネジ“*”印を外します。(図4参照)
- (2) 出力基板から全部のワイヤを外しますと出力基板は外れます。

16. メイン基板の外し方

- (1) 9本のネジ“#”印を外します。(図10参照)
- (2) メイン基板から全部のワイヤを離しますとメイン基板は外れます。

Block Diagram

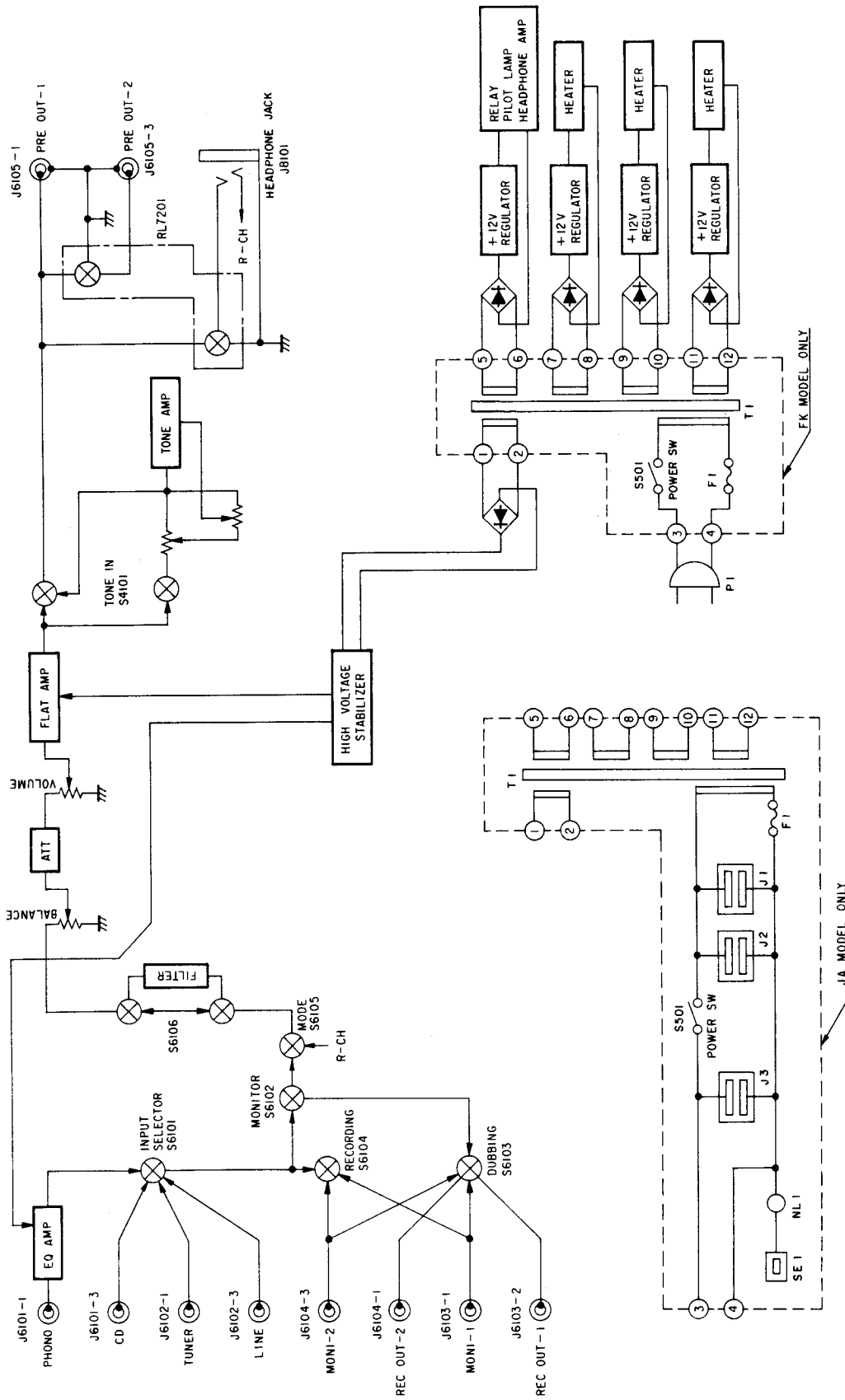

Parts List by Specific Countries

Symbol No.	Description	Power Source		
		FK ■	JA ●	A3040 ▲
		220V	100V	100V
		General Foreign	Japan	Japan
F1	Fuse	65T42077U16	65T55050F11	65D55050F11
J1	Outlet, AC	Not Used	09T64235F01	09T64235F01
J2	Outlet, AC	Not Used	09T64235F01	09T64235F01
J3	Outlet, AC	Not Ued	09T64235F01	09T64235F01
NL1	Lamp, Neon	Not Used	65T61618F01	65T61618F01
P1	Plug, Cord	28T43812P04	28T62216F03	28T62216F03
SE1	Terminal, Sensor	Not Used	29A58768F01	29A58768F01
T1	Trans, Power	25T71387F02	25T71387F01	25T71387F01
23	Rivet, Push	05B41635J03	05B41635J04	05B41635J04
27	Cover, Rear	15D71117F02	15D71117F01	15D71117F04
29	Housing, Sensor	Not Used	15B58781F01	15B58781F01
39	Holder, Fuse	Not Used	09T51828F01	09T51828F01
40	Label, Fuse	Not Used	54B62266F20	54B62266F20
62	Assembly, Front Panel	01V71600F37	01V71600F37	Not Used
62	Panel Front	Not Used	Not Used	64D71125F02
79	Holder, Fuse	09T51410F01	Not Used	Not Used
106-1	Owners, Manual	68P73333F60	68P70001F29	68P70001F29

Parts Layout on P.C. Boards and Wiring Diagram (1/2)

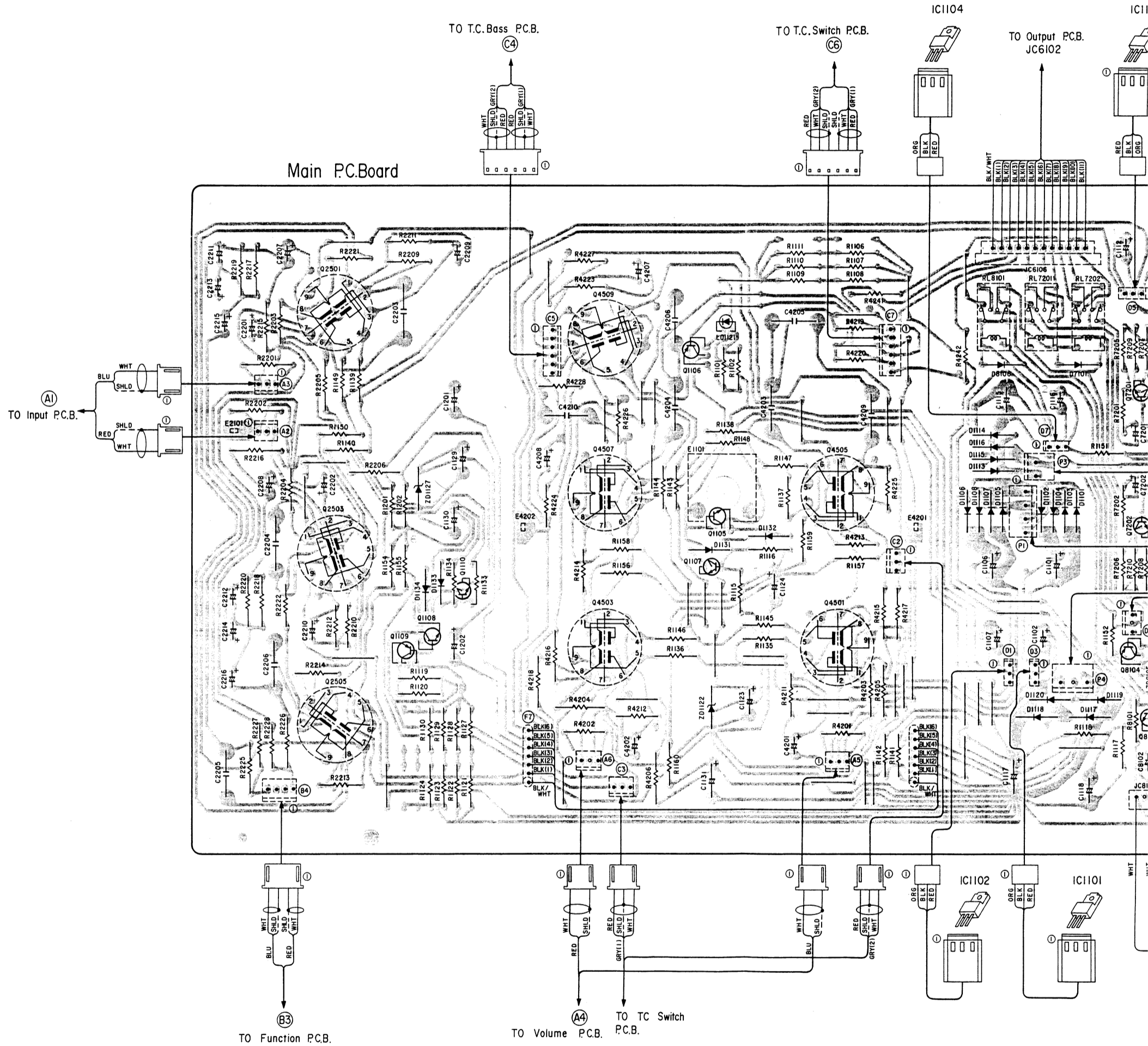

Parts Layout on P.C. Boards and Wiring Diagram (2/2)

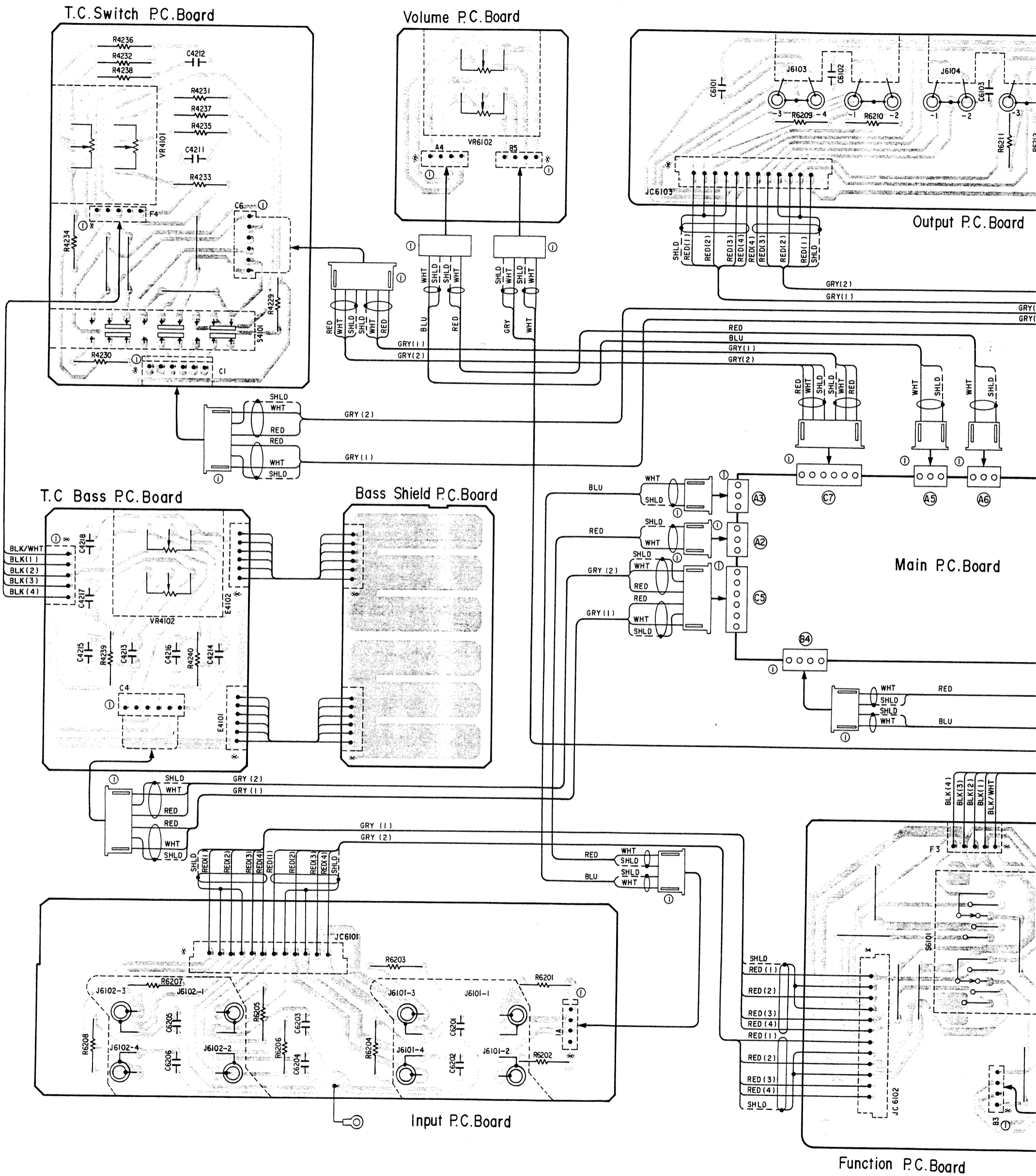

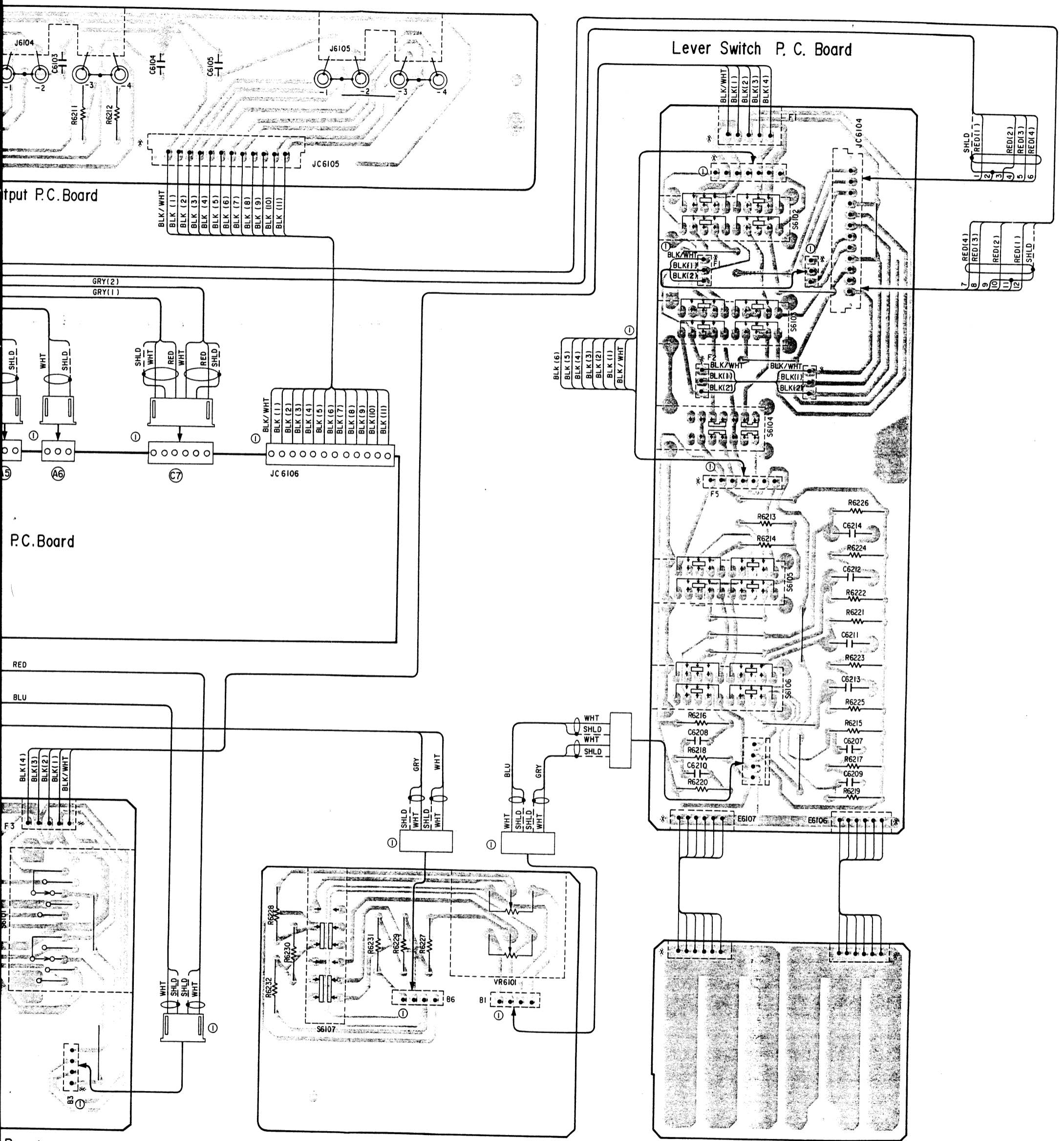

- BLU Blue
- GRN Green
- BLK Black
- GRY Gray
- WHT White
- RED Red
- BRN Brown
- ORG Orange
- YEL Yellow
- VIO Violet
- GRN/WHT Green/White
- GRY/WHT Gray/White
- GRY/YEL Gray/Yellow
- GRN/YEL Green/Yellow

Electrical Parts List

Resistors: Carbon resistors under 1/4 watts are not mentioned in the parts list, please confirm them by schematic diagram.
 uF = microfarads, pF = picofarads

Symbol No.	Part No.	Description
Main P.C. Board		
Transistors		
Q1105	48T71447F01	2SC2752
Q1106	48T71482F01	2SA1156
Q1107	48T71447F01	2SC2752
Q1108	48T71447F01	2SC2752
Q1109	48T71482F01	2SA1156
Q1110	48T71447F01	2SC2752
Q7201	48S43525F05	2SC1815
Q7202	48S43525F05	2SC1815
Q7203	48T51118F03	2SA1015
Q7204	48T51118F03	2SA1015
Q7205	48T51120F01	2SC2235
Q7206	48T51120F01	2SC2235
Q7207	48T51119F01	2SA965
Q7208	48T51119F01	2SA965
Q8101	48S43525F05	2SC1815
Q8102	48S43525F05	2SC1815
Q8103	48T51118F03	2SA1015
Q8104	48T51118F03	2SA1015
Diodes		
D1101	48S40477U01	1N4003
D1102	48S40477U01	1N4003
D1103	48S40477U01	1N4003
D1104	48S40477U01	1N4003
D1105	48S40477U01	1N4003
D1106	48S40477U01	1N4003
D1107	48S40477U01	1N4003
D1108	48S40477U01	1N4003
D1109	48S40477U01	1N4003
D1110	48S40477U01	1N4003
D1111	48S40477U01	1N4003
D1112	48S40477U01	1N4003
D1113	48S40477U01	1N4003
D1114	48S40477U01	1N4003
D1115	48S40477U01	1N4003

Symbol No.	Part No.	Description
D1116	48S40477U01	1N4003
D1117	48S40477U07	1N4007
D1118	48S40477U07	1N4007
D1119	48S40477U07	1N4007
D1120	48S40477U07	1N4007
D1131	48T51582F01	MA150
D1132	48T51582F01	MA150
D1133	48T51582F01	MA150
D1134	48T51582F01	MA150
D7101	48S40477U01	1N4003
D8102	48T51582F01	MA150
D8103	48T51582F01	MA150
D8104	48T51582F01	MA150
D8106	48S40477U01	1N4003
LD1121	48T52953F01	LED, BR3432S (RED)
LD1126	48T52953F01	LED, BR3432S (RED)
VD7201	48T51087F01	Varistor, KB-265
VD7202	48T51087F01	Varistor, KB-265
ZD1122	48T52741F74	Zener HZ36-2L
ZD1127	48T52741F74	Zener HZ36-2L
ZD8105	48T52741F02	Zener HZ6A-2L
Relays		
RL7201	80T00048L02	RZ (12V, 1.2A)
RL7202	80T00048L02	RZ (12V, 1.2A)
RL8101	80T00048L02	RZ (12V, 1.2A)
Capacitors		
C1101	23T00136L47	Electrolytic 2200 uF/25V
C1102	23T00132L02	Electrolytic 220 uF/16V
C1106	23T00136L47	Electrolytic 2200 uF/25V
C1107	23T00132L02	Electrolytic 220 uF/16V
C1111	23T00136L47	Electrolytic 2200 uF/25V
C1112	23T00132L02	Electrolytic 220 uF/16V
C1115	23T00136L47	Electrolytic 2200 uF/25V
C1116	23T00132L02	Electrolytic 220 uF/16V
C1117	23T00145L01	Electrolytic 100 uF/450V
C1118	23T00143L02	Electrolytic 22 uF/350V

Symbol No.	Part No.	Description	
C1123	23T00143L02	Electrolytic	22 μ F/350V
C1124	23T00143L02	Electrolytic	22 μ F/350V
C1129	23T00143L02	Electrolytic	22 μ F/350V
C1130	23T00143L02	Electrolytic	22 μ F/350V
C1131	23T00144L01	Electrolytic	100 μ F/350V
C1201	23T00137L38	Electrolytic	33 μ F/350V
C1202	23T00137L38	Electrolytic	33 μ F/350V
C2201	08T00125L03	Polyethylene	47 pF
C2202	08T00125L03	Polyethylene	47 pF
C2203	08T00016L38	Polyester	0.22 μ F
C2204	08T00016L38	Polyester	0.22 μ F
C2205	08T00019L10	UA	2.2 μ F
C2206	08T00019L10	UA	2.2 μ F
C2207	23T00132L04	Electrolytic	470 μ F/16V
C2208	23T00132L04	Electrolytic	470 μ F/16V
C2209	23T00132L12	Electrolytic	100 μ F/25V
C2210	23T00132L12	Electrolytic	100 μ F/25V
C2211	08T61630F72	Polyethylene	47 pF
C2212	08T61630F72	Polyethylene	47 pF
C2213	08T61630F75	Polyethylene	1200 pF
C2214	08T61630F75	Polyethylene	1200 pF
C2215	08T61630F76	Polyethylene	3900 pF
C2216	08T61630F76	Polyethylene	3900 pF
C4201	23T00132L27	Electrolytic	100 μ F/50V
C4202	23T00132L27	Electrolytic	100 μ F/50V
C4203	08T00019L10	UA	2.2 μ F
C4204	08T00019L10	UA	2.2 μ F
C4205	08T00124L02	GU	2.2 μ F
C4206	08T00124L02	GU	2.2 μ F
C4207	23T00132L27	Electrolytic	100 μ F/50V
C4208	23T00132L27	Electrolytic	100 μ F/50V
C4209	08T00019L06	UA	1 μ F
C4210	08T00019L06	UA	1 μ F
C7201	23T00133L27	Electrolytic	1 μ F/50V
C7202	23T00133L27	Electrolytic	1 μ F/50V
C7203	08T61630F26	Polyethylene	220 pF
C7204	08T61630F26	Polyethylene	220 pF
C7205	23T00136L33	Electrolytic	1000 μ F/16V
C7206	23T00136L33	Electrolytic	1000 μ F/16V
C7207	08T68632F13	Polyester	0.01 μ F
C7208	08T68632F13	Polyester	0.01 μ F
C8101	23T00138L20	Electrolytic	47 μ F/16V
C8102	23T00138L20	Electrolytic	47 μ F/16V
C8103	23T00138L21	Electrolytic	100 μ F/16V

Symbol No.	Part No.	Description	
Resistors			
All resistors are Carbon Film, 1/2W, \pm 5% unless otherwise noted.			
R1135	06T00131L59		1.5 ohm
R1136	06T00131L59		1.5 ohm
R1137	06T00131L59		1.5 ohm
R1138	06T00131L59		1.5 ohm
R1139	06T00131L59		1.5 ohm
R1140	06T00131L59		1.5 ohm
R1141	06T00131L59		1.5 ohm
R1142	06T00131L59		1.5 ohm
R1143	06T00131L59		1.5 ohm
R1144	06T00131L61		1.8 ohm
R1145	06T00131L61		1.8 ohm
R1146	06T00131L61		1.8 ohm
R1147	06T00131L61		1.8 ohm
R1148	06T00131L61		1.8 ohm
R1149	06T00131L61		1.8 ohm
R1150	06T00131L61		1.8 ohm
R1151	06T00130L01		2.2 ohm
R1152	06T00130L01		2.2 ohm
R1153	06T00130L01		2.2 ohm
R2201	06T00148L06		47K ohm
R2202	06T00148L06		47K ohm
R2205	06T00148L29		430K ohm
R2206	06T00148L29		430K ohm
R2215	06T00147L65		1K ohm
R2216	06T00147L65		1K ohm
R2217	06T00148L12		82K ohm
R2218	06T00148L12		82K ohm
R2219	06T00148L24		270K ohm
R2220	06T00148L24		270K ohm
R2225	06T00147L41		100 ohm
R2226	06T00147L41		100 ohm
R4203	06T00147L79		3.9K ohm
R4204	06T00147L79		3.9K ohm
R4205	06T00148L26		330K ohm
R4206	06T00148L26		330K ohm
R4215	06T00148L02		33K ohm
R4216	06T00148L02		33K ohm
R4217	06T00148L16		120K ohm
R4218	06T00148L16		120K ohm
R4241	06T00147L41		100 ohm
R4242	06T00147L41		100 ohm

Symbol No.	Part No.	Description
T.C. Switch P.C. Board		
Switch		
S4101	40T71392F01	SUF106S12.5 (TONE IN)
Capacitors		
C4211	08T61630F34	Polyethylene 470 pF
C4212	08T61630F34	Polyethylene 470 pF
Resistor		
VR4101	18T71393F01	Variable 250K ohm (TREBLE)
T.C. Bass P.C. Board		
Capacitors		
C4213	08T61630F18	Polyethylene 100 pF
C4214	08T61630F18	Polyethylene 100 pF
C4215	08T61630F18	Polyethylene 100 pF
C4216	08T61630F18	Polyethylene 100 pF
C4217	08T61630F62	Polyethylene 6800 pF
C4218	08T61630F62	Polyethylene 6800 pF
Resistor		
VR4102	18T71393F01	Variable 250K ohm (BASS)
Balance P.C. Board		
Switch		
S6107	40T71391F01	SUF104N18 (ATT)

Symbol No.	Part No.	Description
Resistor		
VR6101	18T66550F01	Variable 250KMN (BALANCE CONT)
Output P.C. Board		
Jacks		
J6103	09T50231F05	Plate Phono T5754-CA
J6104	09T50231F05	Plate Phono T5754-CA
J6105	09T50231F05	Plate Phono T5754-CA
Capacitors		
C6101	08T00015L32	Polypropylene 0.39 uF
C6102	08T00015L32	Polypropylene 0.39 uF
C6103	08T00015L32	Polypropylene 0.39 uF
C6104	08T00015L32	Polypropylene 0.39 uF
C6105	08T00015L32	Polypropylene 0.39 uF
Lever Switch P.C. Board		
Switches		
S6102	40T71389F03	SLLR543N (MONITOR)
S6103	40T71389F03	SLLR543N (DUBBING)
S6104	40T71390F02	SLLR542N (RECORDING)
S6105	40T71389F04	SLLR543S (MODE)
S6106	40T71389F04	SLLR543S (FILTER)
Capacitors		
C6207	08T68632F24	Polyester 0.082 uF
C6208	08T68632F24	Polyester 0.082 uF
C6209	08T68632F23	Polyester 0.068 uF
C6210	08T68632F23	Polyester 0.068 uF
C6211	08T64568F31	Mylar 0.33 uF
C6212	08T64568F31	Mylar 0.33 uF
C6213	08T64568F29	Mylar 0.22 uF
C6214	08T64568F29	Mylar 0.22 uF

Symbol No.	Part No.	Description
Input P.C. Board		
Jacks		
J6101	09T71397F01	Plate T5757-CA
J6102	09T71397F01	Plate T5757-CA
Capacitors		
C6201	08T00015L32	Polypropylene 0.039 uF
C6202	08T00015L32	Polypropylene 0.039 uF
C6203	08T00015L32	Polypropylene 0.39 uF
C6204	08T00015L32	Polypropylene 0.39 uF
C6205	08T00015L32	Polypropylene 0.39 uF
C6206	08T00015L32	Polypropylene 0.39 uF
Resistors		
R6201	08T00147L65	1K ohm 1/2W
R6201	08T00147L65	1K ohm 1/2W
Head Phone Jack P.C. Board		
Jacks		
J8101	09T71938F01	Head Phone Jack
Fuse P.C. Board (For FK Model Only)		
Fuse/Capacitors		
F1	65T42077U16	Fuse, Semko (1A-150mV)
C0101	08T57437F09	Ceramic 0.01 uF
C0102	08T57437F09	Ceramic 0.01 uF

Symbol No.	Part No.	Description
Miscellaneous		
▲	C101	08T57437F09 Capacitor, Ceramic 0.01μF
▲	C102	08T57437F09 Capacitor, Ceramic 0.01μF
▲	F1	65T55050F11 Fuse, NF60NR (2A-125V)
▲	IC1101	51T60588F01 IC, NJM7812
▲	IC1102	51T60588F01 IC, NJM7812
	IC1103	51T60588F01 IC, NJM7812
	IC1104	51T60588F01 IC, NJM7812
▲	J1	09T64235F01 Outlet, AC
▲	J2	09T64235F01 Outlet, AC
▲	J3	09T64235F01 Outlet, AC
	LD8101	48T60487F02 LED, SLR-54GG3 (GRN)
▲	NL1	65T61618F01 Lamp, Neon
▲	P1	28T62216F03 Plug, AC Cord
▲	P1	28T43812P04 Plug, Cord
■	PL1	65T66485F02 Lamp, Pilot (14V-80mA)
	Q2501	65T00075L01 Tube, 12AX7
	Q2503	65T00075L01 Tube, 12AX7
	Q2505	65T00075L01 Tube, 12AX7
	Q4501	65T00076L01 Tube, 12AU7
	or	65T71388F02 Tube, 6189
	Q4503	65T00076L01 Tube, 12AU7
	or	65T71388F02 Tube, 6189
	Q4505	65T00076L01 Tube, 12AU7
	or	65T71388F02 Tube, 6189
	Q4507	65T00076L01 Tube, 12AU7
	or	65T71388F02 Tube, 6189
	Q4509	65T00076L01 Tube, 12AU7
	or	65T71388F02 Tube, 6189
	S501	40T57580F02 Switch, Push
	S6101	40T66527F01 Switch SRJ1024S
▲	SE1	29A58768F01 Terminal, Sensor
▲	T1	25T71387F01 Trans, Power
▲	T1	25T71387F02 Trans, Power
■	VR6102	18T71395F01 Volume, K272A 250KA

Note: ● : For Japan model only (JA)
 ■ : For General Foreign model only (FK)
 ▲ : For A3040 model only
 Others: Common

Schematic Diagram

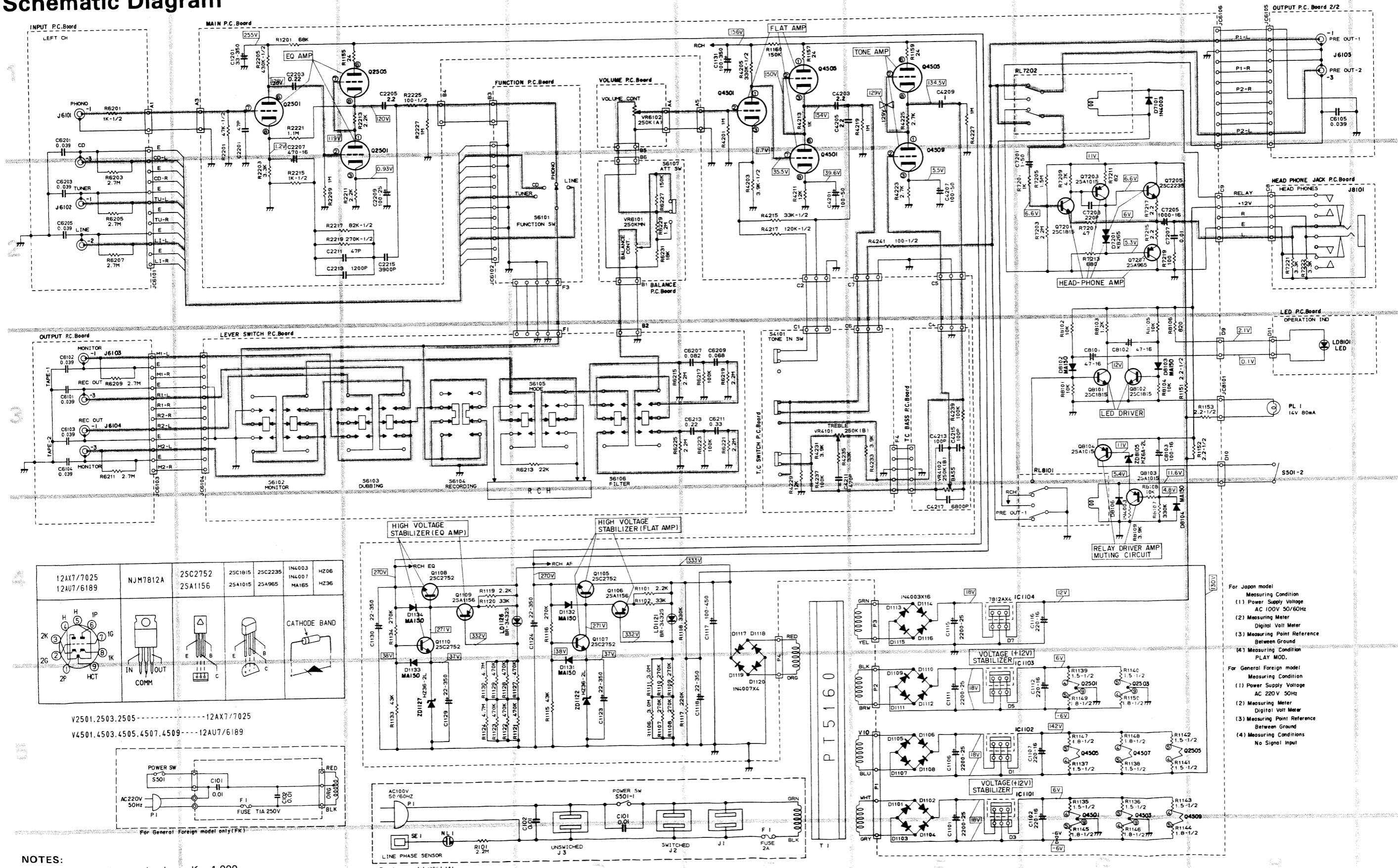

12AX7/7025 12AU7/6189	NJM7812A	25C2752 25A1156	25C1615 25A1015	25C2235 25A965	1N4003 1N4007 1A165	HZ06 HZ36

V2501, 2503, 2505 ----- 12AX7/7025
 V4501, 4503, 4505, 4507, 4509 ----- 12AU7/6189

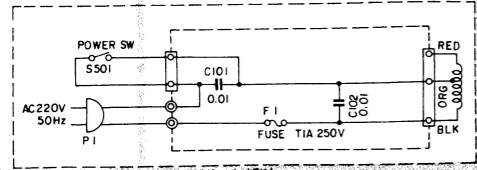

For General Foreign model only (FK)

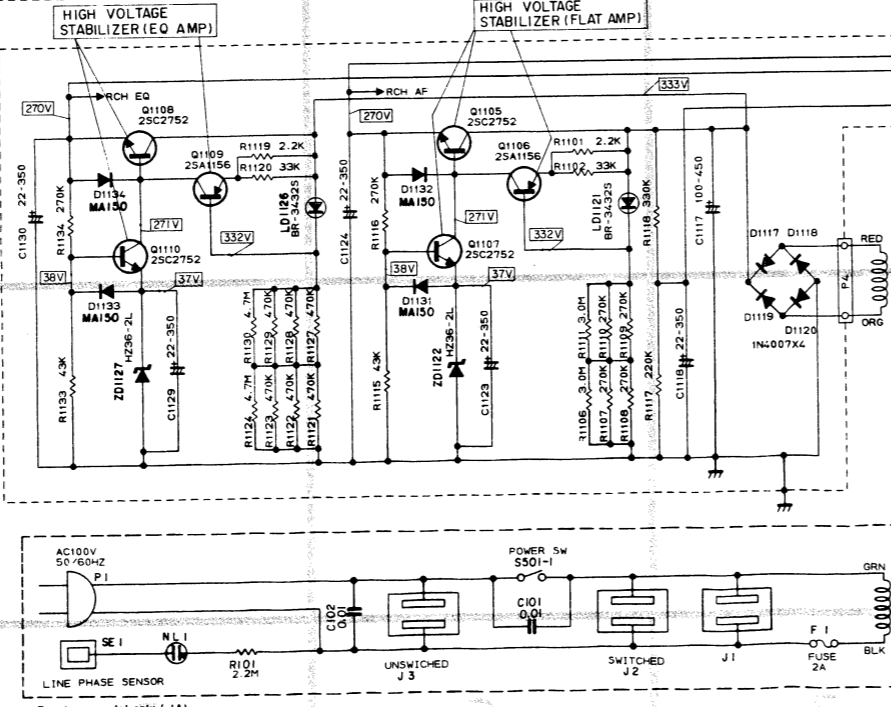

For Japan model only (JA)

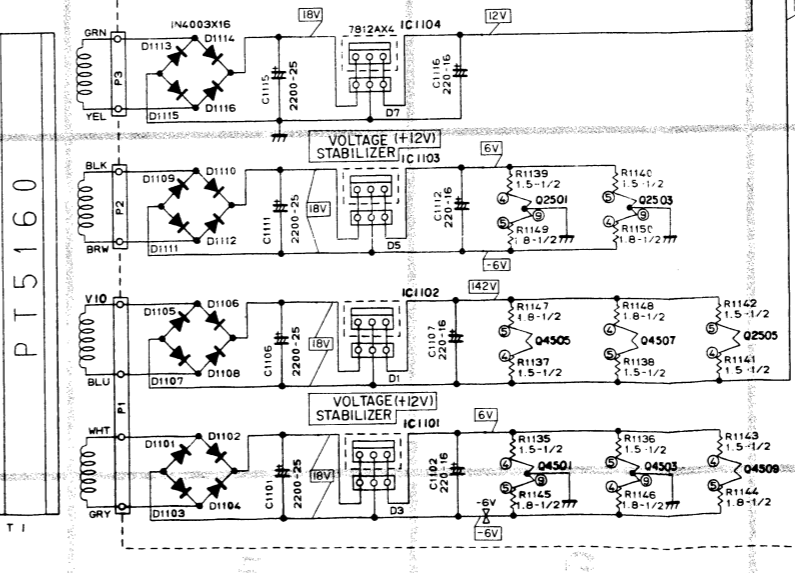

- For Japan model
 Measuring Condition
 (1) Power Supply Voltage
 AC 100V 50/60Hz
 (2) Measuring Meter
 Digital Volt Meter
 (3) Measuring Point Reference
 Between Ground
 (4) Measuring Condition
 PLAY MOD.
- For General Foreign model
 Measuring Condition
 (1) Power Supply Voltage
 AC 220V 50Hz
 (2) Measuring Meter
 Digital Volt Meter
 (3) Measuring Point Reference
 Between Ground
 (4) Measuring Conditions
 No Signal Input

- NOTES:
 1. All resistance values are in ohms. K = 1,000
 2. All capacitance values are in microfarads. P = 1,000,000

Exploded View (Cabinet)

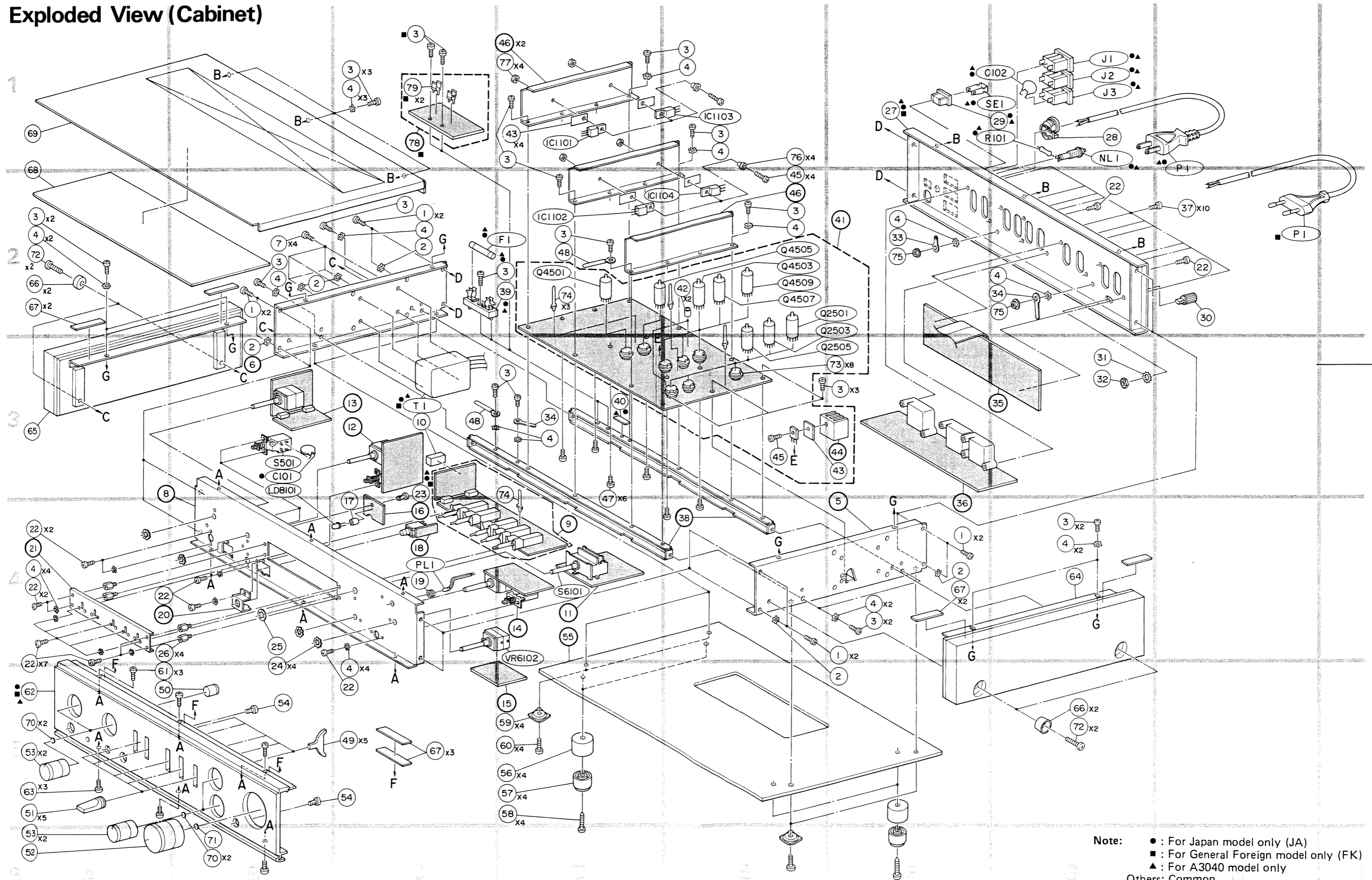

Note: ● : For Japan model only (JA)
 ■ : For General Foreign model only (FK)
 ▲ : For A3040 model only
 Others: Common

Cabinet Assembly Parts List

Symbol No.	Index	Part No.	Description
1		03S40012G95	Screw, Tapping (M4 x 8)
2		04S40072G15	Washer T.L (M4.3)
3		03S40012G93	Screw, Tapping (M3 x 8)
4		04S40072G20	Washer T.L (M3)
7	2-B	03S40036U01	Screw, Pan (M4 x 8)
10	3-C	75S62361F02	Cushion, Rubber
17	3-C	43A41837U03	Spacer, Switch
19	4-C	43A62016F02	Bushing
22		03S44205G38	Screw, Bind (M3 x 6)
23		05B41635J04	Rivet, Push
23	3-C	05B41635J03	Rivet, Push
24	4-B	04S40072G25	Washer, T.L (M8.4)
25	4-B	04S40072G13	Washer, T.L (M9)
26	4-A	47B64899F22	Shaft US1042
27	1-F	15D71117F01	Cover, Rear
27	1-F	15D71117F02	Cover, Rear
27	1-F	15D71117F04	Cover, Rear (A3040)
28	1-G	43B41625J05	Stopper, Cord
29	1-G	15B58781F01	Housing, Sensor
30	2-H	09A61713F02	Terminal, GND
31	3-G	04S40072G06	Washer T.L (M6.4)
32	3-G	02S40000G46	Nut, Hex (M6)
33	2-F	29A64217F01	Lug
34		29A737272	Lug Wrap Around
37	2-H	03S40012G99	Screw, Tapping (M3 x 10)
39	2-D	09T51828F01	Holder, Fuse
40	3-D	54B62266F20	Label, Fuse (2A-250V)
42	2-E	43A41837U03	Spacer, Switch
43		14S56709F01	Insulator, Transistor
45		03C40121T13	Screw, W/D Washer (M3 x 10)
47	3-D	03S71031F04	Screw, Bind (M3 x 8)
48		29C41045P05	Lug, Wrap
49	5-C	13A71130F01	Escutcheon, Lever Switch
50	5-A	36A66492F01	Knob, Push
51	5-A	36A71123F01	Knob, Lever
52	6-A	36B66495F02	Knob, Volume
53	5-A	36A66496F01	Knob, TC
54		36A71131F01	Knob, Push Switch
56	5-D	36A66422F01	Cap, Trannleg
57	5-D	75A64637F01	Pad, Trannleg

Symbol No.	Index	Part No.	Description
58	5-D	03S40013G08	Screw, Round (M3.1 x 25)
59	5-D	07A65912F01	Bracket, UR1125B
60	5-D	03S63857F09	Screw, Tapping (M4 x 20)
61	4-A	03S63857F27	Screw, Tapping (M3 x 8)
62		01V71600F37	Assembly, Front Panel
62	5-A	64D71125F02	Front Panel (A3040)
63	5-A	03S40012G55	Screw, Tapping (M3 x 8)
64	4-G	16D71119F01	Wood, Cab "R"
65	3-A	16D71120F01	Wood, Cab "L"
66		04A71209F01	Washer, Wood Cab
67		14S53018F42	Insulator
68	1-A	75S72374F21	Cushion, Rubber
69	1-A	15C71129F01	Cover, Top
70		43A63758F03	Spacer, Shaft
71	6-B	43A63758F04	Spacer, Shaft
72		03S72235F02	Screw, Bind (M5 x 35)
73	3-F	09T64527F02	Socket, Tube 9 Pin
74	2-D	29C41045P06	Lug, Wrap Board-In
75		02B47353F02	Nut, Hex (M3)
76	1-E	43T45472F01	Bushing
77	1-D	02S40000G35	Nut, Hex (M3)
79	1-C	09T51410F01	Holder, Fuse

Note: ● : For Japan model only (JA)
 ■ : For General Foreign model only (FK)
 ▲ : For A3040 model only
 Others: Common

Packing Method View

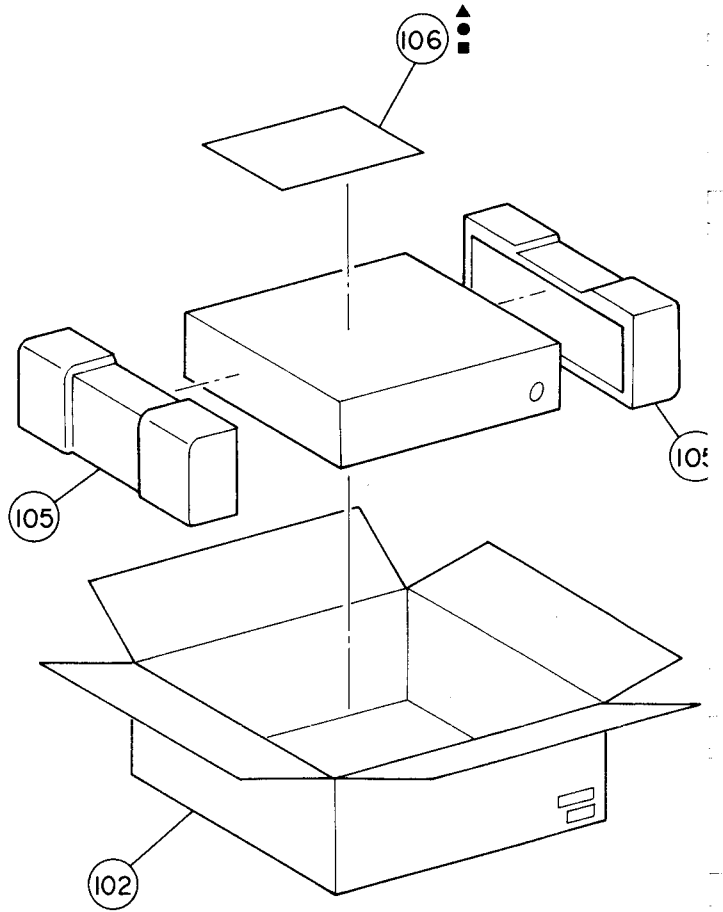
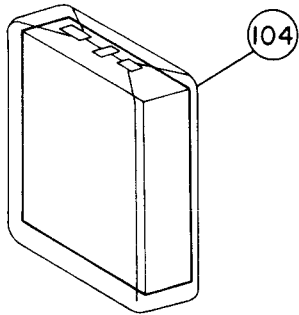
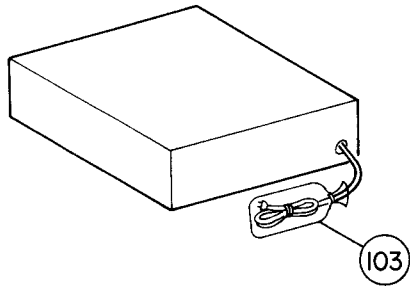
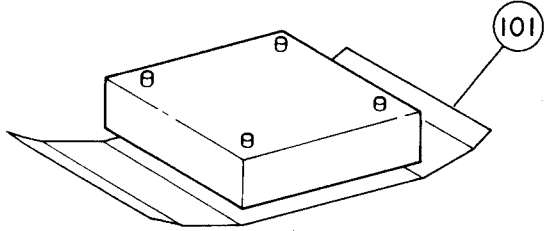

Packing Assembly Parts List

Symbol No.	Part No.	Description
101	56A52079F05	Spacer, Packing
102	56S71101F05	Carton, Packing (Individual)
103	56B40230G08	Sack, Polyethylene
104	56B63425F03	Sack, Polyethylene
105	56D71126F01	Tray, Packing
▲ 106-1	68P70001F29	Owners, Manual
■ 106-1	68P73333F60	Owners, Manual
106-2	28T58909F01	Plug, Audio Cable
106-3	01R60802F01	Assy., Silicon Cloth

Symbol No.	Part No.	Description
------------	----------	-------------

Note: ● : For Japan model only (JA)
 ■ : For General Foreign model only (FK)
 ▲ : For A3040 model only
 Others: Common

Semi-Conductor Lead Identifications

NJM7812: IC1101, 1102, 1103, 1104

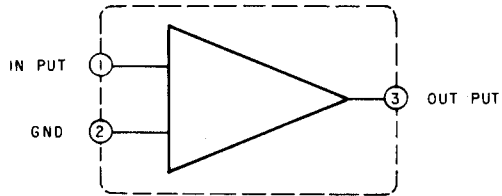
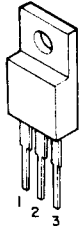

2SC2752: Q1105, 1107, 1108, 1110
2SA1156: Q1106, 1109

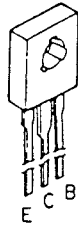

2SC1815: Q7201, 7202, 8101, 8102
2SA1015: Q7203, 7204, 8103, 8104



2SC2235: Q7205, 7206
2SA965: Q7207, 7208

