

SERVICE MANUAL



STEREO CASSETTE DECK

K-240



Contents

Level Diagram	1
Adjustment Location	2
Adjustment Procedures	3,4
Exploded View Parts List	5
Exploded View (Mechanism) Parts List	6
Packing Material Parts List	8
Master PCB Parts List	10-14
Control PCB Parts List	15,16
FL Meter PCB Parts List	17
Key Board Switch Parts List	18
Rotary Switch PCB Parts List	18
Head Phone PCB Parts List	18
Music Sign PCB Parts List	18
Memory Switch PCB Parts List	19
Indicator PCB Parts List	19
Power Supply PCB Parts List	19
Reed Switch PCB Parts List	19
Schematic Diagram(A)	20
Schematic Diagram(B)	21
IC Handling Guide	22
Destination's Parts List	23
Specifications	23

Level Diagram

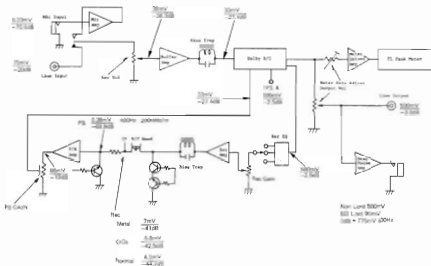



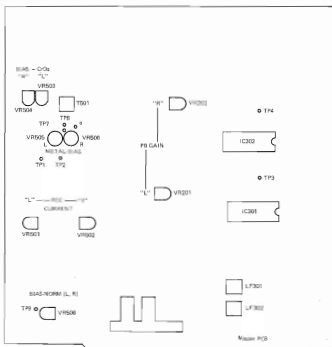



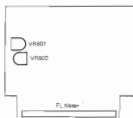







Adjustment Location



- VR201: 22KB P/B Gain Adj. (L-ch)
 VR202: 22KB P/B Gain Adj. (R-ch)
 VR501: 47KB REC Level Adj. (L-ch)
 VR502: 47KB REC Level Adj. (R-ch)
 VR503: 100KB Bias Adj. CrOz (L-ch)
 VR504: 100KB Bias Adj. CrOz (R-ch)
 VR505: 100KB Bias Adj. Metal, (L-ch)
 VR506: 100KB Bias Adj. Metal, (R-ch)
 VR508: 2.2KB Bias Adj. Normal, (L/R-ch)
 VR801: 4.7KB Meter Adj. (L-ch)
 VR802: 4.7KB Meter Adj. (R-ch)
 T501: Bias OSC Frequency Adj.



Adjustment Procedures

Step	Description	Mode	Adjusting Point	Test Point	Component	Remarks
1	Tape Transportation Check	Play				Make sure that there are no loose pins tape guide of erase and RT heads, by using "Shave tool". Condition that RT head is placed without any tilt against the "96-300" gage.
2	Torque Check	Play, FF & Rew				Take up Torque : 15-40 g-cm Back Tension Torque : 1-4 g-cm FF & Rew Torque : 10-10g-cm
3	Tape Speed and New Flutter Check	Playback		Line Out		Test Tape : RTT-111 (3000) Speed : 3000RPM ± 1.5% New Flutter : No more than 0.05% (JIS W.R.M.S.) For the best speed adjustment, refer to test REE-2000 at the beginning of user's manual.
4	Head Azimuth Adjustment	Playback	See [Fig-1]	Line Out		Test Tape : RTT-100 (6000), 20000Hz 175.4 μV/cm
5	Playback Dolby Level Adjustment	Playback Tape Select (Normal) Dolby NR : off	VR201 Lev VR202 Lev	FR1,cb FR1,cb		Test Tape : RTT-150 (4000R, 100000Hz) Line Out : 550mV
6	FE Meter Adjustment	Playback	Volume Lev Volume Lev	Meter Display		Test Tape : RTT-150 Meter Display : 0 dB
7	Playback Frequency Response Check	Playback Tape Select (Normal) Dolby NR : off	Step 1-5	Line Out		Test Tape : RTT-150 RTT-210C
8	Head ODC Frequency Response Check	Playback Tape Select (Normal) Dolby NR : off	TS01	FR2 - TR (2000)		Test Tape : RTT-114 or RTT-210C
9		Record Tape Select (Normal) Dolby NR : off				Test : Reel FR1,cb (4500) 20000 Hz

Step	Description	Note	Adjusting Point	Test Point	Connection	Remarks
9		Record Tape Select:Normal Bulby M	VR503 Lch VR506 Rch	TP1-ORB TP2-ORB		Input - New TP Output: 200uV
		Record Tape Select:Cr02 Bulby M	VR503 Lch VR506 Rch			Input - New TP Output: 400uV
		Record Tape Select:Normal Bulby M	VR508 L/Both			Input - New TP Output: 200uV
10	Input Level Adjustment	Record Tape Select:Normal Bulby M	Res Level SW	Line Out		Input - New Line Out: 500uV
11		Record/Play Tape Select:Normal Bulby M	Check	Line Out		Input - New Line Out: 500uV
		Record/Play Tape Select:Cr02 Bulby M	VR503 Lch VR507 Rch			
		Record/Play Tape Select:Normal Bulby M	Check			
12	Record/Playback Frequency Response Check	Record/Play Tape Select:Normal Bulby M	Step B-11	Line Out		Record Tape AC:111 Input - 4.2mV
		Record/Play Tape Select:Cr02 Bulby M				Record Tape AC:112 Input - 200uV - 1300uV
		Record/Play Tape Select:Normal Bulby M				Record Tape AC:219 Input - 200uV - 1000uV
13	Record/Playback Frequency Response Check (Bulby)	Record/Play Tape Select:Normal Bulby M				Record Tape AC:111, AC:112 Input - 200uV - 1300uV

Exploded View

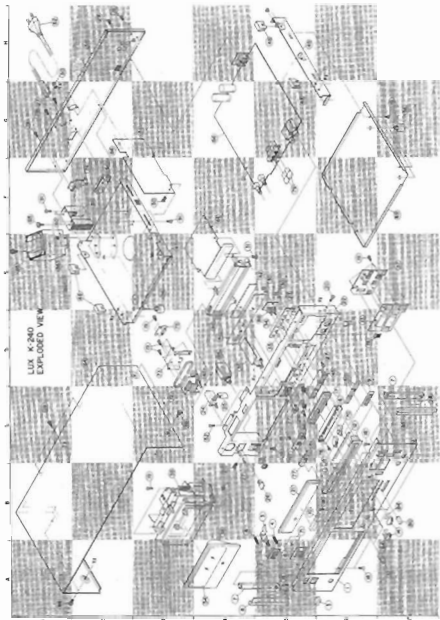

Explode View Parts List

Index	Symbol No.	Stock No.	Description	Index	Symbol No.	Stock No.	Description
A6	1	64D61139F01	Panel, Front	F4	44	01V61900F37	Ass'y, FL Meter PCB
A5	2	07A45558F04	Frame, Eject	D6	45	43A61328F01	Bush, Lamp
B5	3	45A50461F01	Lever, Eject	D4	46	01V61900F34	Ass'y, Head Phone PCB
B4,B5	4	41A45559F01	Spring, Eject	E3	47	27D58921F02	Chassis, Bottom
A6	5	36A44340F05	Knob, Eject	E2,G5	48	07A61143F01	Spacer, Side
A5	6	61A56641F01	Crystal, Indicator	H5	49	27C58922F01	Chassis, Side
A4,D7	7	07A57175F01	Bracket, Side Panel	D6	50	61A61141F01	Lens, Indicator
A4	8	07B56624F01	Frame, Side Panel	G3	51	01V61900F32	Ass'y, Control PCB
D6	9	07A51138F01	Frame, Push Knob	C4	52	03S44205G16	Screw T-Tite M3X6
B5	10	75B44632G04	Pad, Cushion	A4	54	01C57187F01	Crystal Door
B6	11	13C61140F01	Escutcheon, Volume	E1	55	25T60094F01	Trans Power
C6	12	43A57191F01	Spacer, Escutcheon	E3,G7	56	75A60070F01	Ass'y, Pad Rubber
D6	13	01V61900F44	Ass'y, Knob Logic	F2	57	07T56351F02	HeatSink
D6	14	36B57177F01	Knob Control	H2	59	15C58925F03	Cover, Rear
C6	15	43B57179F01	Spacer, Knob Control B	F1	60	29A41814F01	Lug
C6	16	07B57169F01	Bracket, Slide Volume	F2	61	09T60095F01	Socket AG
C6	17	18T52629F01	Volume, Slide 20K	H2	62	30T60805F01	Card Set (Jemco) (SREX, BKAK)
AS,A6	18	03S40012G26	Screw, M3X6			30T60804F01	Card Set (UL/CSA), UQ
C1,B3	19	03S40012G03	Screw, M3X6			30T60973F01	Card Set (BS) AG
A4	20	03S40012G08	Screw, M4X6	D2	64	19D61137F01	Cover, Top
B5	21	61B57222F01	Crystal, Meter	E1,F1	65	03S40036U16	Screw, M4X6
E6	22	27D61136F01	Chassis, Front	G4	66	01V61900F31	Ass'y, Master PCB
E5	23	01V61900F40	Ass'y, Indicator PCB	C5	67	01V61900F50	Ass'y, Music Scan
C4	24	40T45561F02	Switch, Power	C5	68	03S40018G02	Screw TPG M3X8
C4	25	43T53138F01	Bush, Cap TP150-301	F7	69	15C58942F01	Cover, Bottom
B5	26	36A56639F02	Knob, Push [17]	C6	70	43B57178F01	Spacer, Knob Control (A)
B4,C5	27	03S40011G17	Screw, M3X6	B5	71	43A56628F01	Spacer, Power
AS,C7	28	14S53018F52	Insulator 50X12	C3	72	42A57223F01	Belt, Counter
CS,G1	29	03S40012G41	Screw M3X8	D3	73	07B57155F01	Bracket, Counter
ES,F3	30	05B41635J02	Rivet, Push	F2	74	09T57205F01	Plate, Phone
E4	31	05B41635J03	Rivet, Push	D3	75	01V61900F38	Ass'y, Reed SW
A7	32	36B51053F02	Knob, Rotary	D6	76	07A51144F01	Frame Push SW
D5	33	43A41728U15	Bush, Lamp	B5	77	36B51142F02	Knobs, Music Scan
D5	34	43A41728U14	Bush, Lamp	C5	78	03C49014G12	Screw, M2.5X4
D4	35	01V61900F35	Ass'y, Rotary SW PCB	F5	79	36A57176F01	Knob, Push (A)
D5	36	43A41728U11	Bush, Lamp	B7	80	36A57180F01	Knob Push (B)
E7	37	01V61900F45	Ass'y, Key Board SW	C5	81	36B61142F01	Knobs, Music Scan
B4	38	64B57188F01	Plate, Door	A7	84	75A57370F01	Pad, Cushion
B3	39	01U61000F16	CAS Deck FL7ED30	C7	85	07B56624F02	Frame Panel Side
D4	40	07C57182F01	Frame, Meter	G2	86	09T50261F01	Jack, Cont
D4	41	61A57154F03	Filter, Meter (A)	A1,C3	88	03S40036U07	Screw, M4X12
E5	42	61A57184F01	Filter, Meter (B)	D5	89	01V61900F39	Ass'y, Memory SW
D4	43	72T57221F01	Tape Counter	F1,F3	91	03S40011G17	Screw, M3X6

Exploded View (Mechanism)

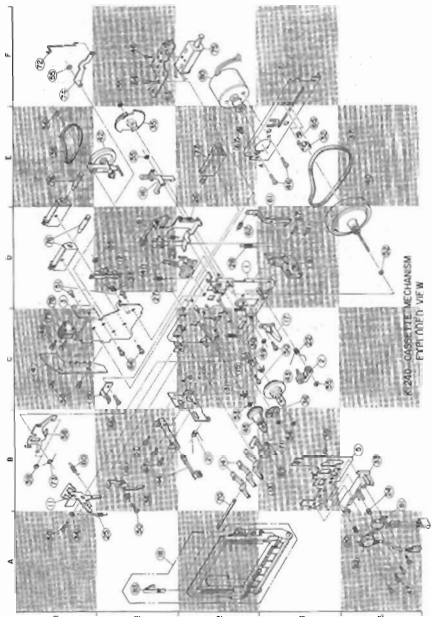

©210-CASSETTE MECHANISM
EXPLODED VIEW

DWG. 7

Explode View (Mechanism) Parts List

Index	Symbol No.	Stock No.	Description	Index	Symbol No.	Stock No.	Description
D3	1	FO11-169	Ass'y, Chassis	E2	42	FP470-11	Ass'y, Clutch
C4	2	FO14-053	Ass'y, Pinch Roller	C4	43	F123-025	Ass'y, Take Up Reel
D1	3	F214-019	Bracket, Solenoid Reserve	B2	44	FP472-11	Ass'y, Clutch
C1	4	FP13D-11	Connector, Panel	B3	45	F105-019	Ass'y, Reel
B5	5	FO12-068	Plate, Head Reserve Stock	B2,E4	46	FG114-15	Screw, W/Washer
D2	6	FC11P-13	Base, Assist	A5	47	FG137-15	Screw, F-Lock
F4	7	FR347-12	Bracket, Motor	C1	48	FG143-30	Screw, Pan
C3	8	FR349-17	Bracket, Dumpster	C4	49	FJ141-12	Washer, Oil Shield
D4	9	FR350-15	Bracket, Door	A1,A2	50	KG194-12	Screw, Pan
B2	10	FR352-11	Lever, Safety	D1	51	KG194-46	Screw, Tap Title
B1	11	FC32U-11	Arm, Eject Lock	D5	52	FJ111-14	Washer, Poly
D2	12	FR355-15	Arm, Ff Solenoid	B3	53	FJ111-19	Washer, Poly
B4	13	FD26K-12	Arm, Cassette	B4	54	FJ123-14	Washer, Poly
B3	14	FD26L-11	Arm, Record	C4,D2	55	FJ123-21	Washer, Lock
C3	15	FR358-14	Reference, Guide	E1	56	FJ123-19	Washer, Lock
E2	16	FD11L-12	Arm, Play Solenoid	B2	57	UG11D-11	Screw, Tap Title
C4	17	FR360-12	Guide, Cassette	B1	58	FC15G-14	Joint, Brake
A2	18	FO27-062	Frame, Door Ass'y	B1	59	FF11C-14	Rubber, Brake
C1	19	FK551-13	Spring, Cassette	B1	60	FK18M-11	Spring, Arm Eject
A5	20	FK572-12	Spring, Azimuth	E4	61	FD11K-14	CR, Lock Panel
B3	21	FK568-11	Spring, Door	D3	62	FK11A-12	CR, Spring Lock Panel
C4	22	FK569-14	Spring, Pinch Roller	F2	68	FC11N-12	Bracket, Solenoid
D2	23	FK11N-11	Spring, Bkt Solenoid	F2	64	FG182-11	Screw, Tap Tilt
B5	24	FK572-11	Spring, Azimuth	E4	65	FK11F-16	Spring, Srest
A2	25	FK573-11	Spring, Arm Lock	C2	66	FG143-17	Screw, pan
E3	26	FK574-13	Spring, Base Assist	B2,D4	67	KG189-11	Screw, pan
D2	27	FK575-11	Spring, Play Idler	B4	69	FD26M-12	Arm (M)
D3	28	FK19K-11	Spring, Play Solenoid Arm	B3	70	FL25F-11	Shaft (A)
D4	29	FK577-13	Spring, Head Base	B4	71	KG111-19	Ring (E)
C3	30	FK578-13	Spring, Head Base Hold	F1	72	FK11Y-14	Brake, Rod
C3	31	FK579-14	Spring, Back Tension	B1	73	FK12A-12	Spring, Brake
E4	32	FM281-12	Spacer, Flywheel	F1	74	FD12W-12	Arm, Brake
B5	33	FM283-14	Spacer, Head	F3	75	PKA16103	Solenoid
A1,B2	34	FM295-11	Spacer	D1,E1	76	PKA16106	Solenoid
E2	35	FN153-11	Gear, Play	E3	77	PKA16101	Solenoid
C4	36	FM154-14	Gear, Idler	D1	78	FE173-11	Slide SW
E5	37	FP462-11	Belt, Main	C1	79	FE173-11	Slide SW
E1	38	FP463-11	Belt, Sub	F3	80	F064-093	Ass'y, Motor
B4	39	FP464-11	Pad, Cushion	B5	81	F029-156	Head R/P
E5	40	FP465-12	Ass'y Flywheel	A5	82	F030-052	Head, Erase
D2	41	FP469-12	Ass'y, Idler	A2	83	FC32M-12	Holder, SP

Packing Material Parts List

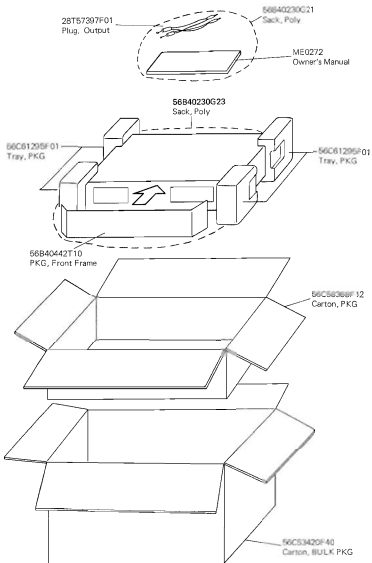

Master PCB Parts List

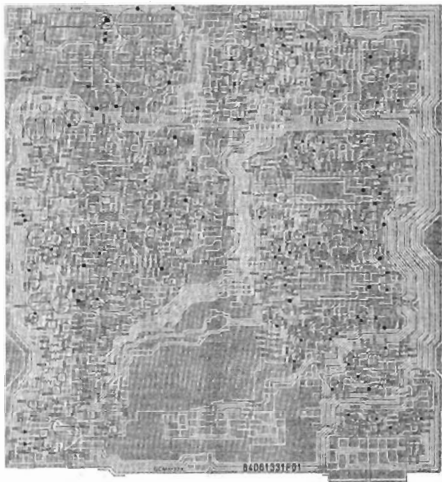

Master Board Parts List

Symbol No.	Stock No.	Description	Symbol No.	Stock No.	Description
(Jack)			Q302	48S43525F05	2SC1815-Y, GR
J201	09T57396F01	Plate, Phone4P(JAL)	Q303	48S43525F05	2SC1815-Y, GR
J203	09T60076F01	MIC	Q405	48T57305F01	2SD1302-S, T
J204	09T60076F01	MIC	Q406	48T57305F01	2SD1302-S, T
(Coil OSC)			Q407	48T43015U01	2SC2120-Y
T501	24T60049F01	Coil OSC	Q408	48T43015U01	2SC2120-Y
(Coil)			Q501	48S43525F05	2SC1815-Y, GR
L301	24T47741F01	36mH	Q502	48S43525F05	2SC1815-Y, GR
L302	24T47741F01	36mH	Q503	48S43525F05	2SC1315-Y, GR
LS01	24S41448F99	4700UH	Q504	48S43525F05	2SC1815-Y, GR
LS02	24S41448F99	4700UH	Q505	48S43525F05	2SC1815-Y, GR
LS03	24T44499P01	27mH	Q506	48S43525F05	2SC1815-Y, GR
LS04	24T44499P01	27mH	Q509	48T57305F01	2SD1302-S, T
(Switch)			Q510	48T57305F01	2SD1302-S, T
S301	40T61330F01	Push SUL 2Key	Q511	48S43394P01	2SC1890 E, F
S302	40T61330F01	Push SUL 2Key	Q512	48S48894P01	2SC1890 E, F
(Variable, Resistor)			Q513	48S40832F03	2SC1318NC-R
VR201	18T52946F15	22KB	Q514	48S40832F03	2SC1318NC-R
VR202	18T52946F15	22KB	Q515	48T43015U01	2SC2120-Y
VR401	18T60151F01	5K-A	Q516	48T61307F01	DTC114
VR501	18T52946F17	47KB	Q517	48T61307F01	DTC114
VR502	18T52946F17	47KB	Q616	48S43525F05	2SC1815-Y, GR
VR503	18T52946F19	100KB	Q901	48T40081T03	2SA733(P)
VR504	18T52946F19	100KB	Q902	48S43525F05	2SC1815-Y, GR
VR505	18B44064J07	100K-1/2	Q903	48T42941U01	2SA9215
VR506	18B44064J07	100K-1/2	Q904	48S43525F05	2SC1815-Y, GR
VR507	18T50150F01	1K-B	Q905	48S43525F05	2SC1815-Y, GR
VR508	18T52946F09	2.2KB	Q906	48S43525F05	2SC1815-Y, GR
(Diode, Bridge)			Q907	48T40081T03	2SA733(P)
BD101	48T50629F01	WL-02	Q908	48T61307F01	DTC114
(Filter)			Q909	48T40081T03	2SA733(P)
LF301	91T61312F01	MPX(38K)	Q910	48S43525F05	2SC1815-Y, GR
LF302	91T61312F01	MPX(38K)	Q911	48S43525F05	2SC1815-Y, GR
(Fuse)			Q912	48T40081T01	2SA733(P)
F101	65T42077U16	Semko T-1A	Q913	48T40081T03	2SA733(P)
F102	65T42077U16	Semko T-1A	Q914	48T40081T03	2SA733(P)
(Holder, Fuse)			Q915	48T40081T03	2SA733(P)
F101	09T45548F01	Holder, Fuse	(Diode)		
F102	09T45548F01	Holder, Fuse	D101	48T61129F01	GP10-4003-R5
(IC)			D501	48T58583F01	SS1767PA7
IC301	51T52160F01	HA12038-01	D502	48T58583F01	SS1767PA7
IC302	51T52160F01	HA12033-01	D504	48T58583F01	SS1767PA7
IC501	51S43471U02	UPC4558C	D505	48T53583F01	SS1767A
(Transistor)			D902	48T53583F01	SS1767PA7-A
Q201	48S43394P01	2SC1890 E, F	D903	48T58583F01	SS1767PA7
Q202	48S43394P01	2SC1890 E, F	D904	48T53429F01	15S81
Q203	48S43394P01	2SC1890 E, F	D905	48T58583F01	SS1767PA7
Q204	48S43394P01	2SC1890 E, F	D906	48T58583F01	SS1767PA7
Q205	48S43525F05	13C1315-Y, GR	D907	48T58582F01	SS1767PA7
Q206	48S43525F05	2SC1815-Y, GR	D908	48T58583F01	SS1767PA7
Q207	48S47706F04	2SC1843 E	D909	48T58583F01	SS1767PA7
Q208	48S47706F04	2SC1843 E	D910	48T58583F01	SS1767PA7
Q209	48S47706F04	2SC1843 E	D911	48T58583F01	SS1767PA7
Q210	48S47706F04	2SC1343 E	D912	48T58583301	SS1767PA7
Q213	48S43525F05	2SC1815-Y, GR	(Diode, Zener)		
Q214	48S43525F05	2SC1815-Y, GR	ZD101	48T40150U80	HZ20-2
Q215	48S47706F04	2SC1843 E	ZD102	48T40150U66	HZ12B-33
Q251	48S47706F04	2SC1843 E	ZD105	48T40150U71	HZ15-2
Q252	48S47706F04	2SC1843 E			
Q301	48S43525F05	2SC1815-Y, GR			

Symbol No.	Stock No.	Description	Symbol No.	Stock No.	Description
ZD301	48T40150Z68	HZ12C-2	C327	08S40656F13	0.01uF My
ZD302	48T40150U68	HZ12C-2	C328	08S40656F13	0.01uF My
ZD303	48T40150U32	HZ9B-2	C329	23S40657F16	4.7uF 25V E1
ZD501	48T40150U76	HZ18-1	C330	23S40657F16	4.7uF 25V E1
(Capacitor)			C331	08S40656F16	0.018uF My
C101	23S40657F28	1uF 50V E1	C332	08S40656F16	0.018uF My
C102	23S41198U67	1000uF 50V E1	C333	23T42478F21	0.33uF 50V E1
C103	25S41198U57	470uF 25V E1	C334	23T42478F21	0.33uF 50V E1
C104	23S41198U42	220uF 250V E1	C335	23T42478F21	0.33uF 50V E1
C105	23S41198U72	220uF 25V E1	C336	23T42478F21	0.33uF 50V E1
C106	23C41198U56	470uF 16V E1	C337	08S40656F15	0.015uF My
C107	23S40657F14	100uF 16V E1	C338	08S40656F15	0.015uF My
C201	08T55260F45	470pF Ce	C339	23S40657F28	1uF 50V E1
C202	08T55260F45	470pF Ce	C340	23S40657F28	1uF 50V E1
C203	23T42478F09	4.7uF 25V E1	C341	23S40657F28	1uF 50V E1
C204	23S43478F09	4.7uF 25V E1	C342	23S40657F28	1uF 50V E1
C205	08T55260F45	470pF Ce	C343	23S40657F10	10uF 16V E1
C206	08T55260F45	470pF Ce	C344	23S40657F10	10uF 16V E1
C207	08T55260F29	47pF Ce	C345	08T55260F27	39pF Ce
C208	08T55260F29	47pF Ce	C346	08T55260F27	39pF Ce
C209	23S40657F14	100uF 16V E1	C347	08S40656F10	5600pF My
C210	23S40657F14	100uF 16V E1	C348	08S40656F10	5600pF My
C211	08S40656F07	3300pF My	C349	08T55260F49	1000pF Ce
C212	08S40656F07	3300pF My	C350	08T55260F49	1000pF Ce
C213	23S40657F10	10uF 16V E1	C351	08S40656F07	3300pF My
C214	23S40657F10	10uF 16V E1	C352	08S40656F07	3300pF My
C217	08T55260F49	1000pF Ce	C353	08S40657F10	10uF 16V E1
C218	08T55260F49	1000pF Ce	C354	08S40657F10	10uF 16V E1
C221	23S40657F16	4.7uF 25V E1	C355	08S40657F08	3900pF My
C222	23S40657F10	10uF 16V E1	C356	08S40657F08	3900pF My
C223	08S40656F14	0.012uF My	C357	08S40657F24	0.082uF My
C226	08S40656F14	0.012uF My	C358	08S40657F24	0.082uF My
C228	23S40657F21	100uF 25V E1	C359	23S40657F16	4.7uF 25V E1
C251	08T55260F49	1000pF Ce	C360	23S40657F16	4.7uF 25V E1
C252	08T55260F49	1000pF Ce	C361	23T42478F19	0.15uF 50V E1
C253	23S40657F16	4.7uF 25V E1	C362	23T42478F19	0.15uF 50V E1
C254	23S40657F16	4.7uF 25V E1	C363	23S40657F27	0.47uF 50V E1
C255	23S40657F10	10uF 16V E1	C364	23S40657F27	0.47uF 50V E1
C256	23S40657F10	10uF 16V E1	C365	23S40657F09	220uF 10V E1
C301	23S40657F20	47uF 25V E1	C366	23S40657F09	220uF 10V E1
C303	23S40657F16	4.7uF 25V E1	C369	08S40656F04	1800pF My
C304	23S40657F16	4.7uF 25V E1	C370	08S40656F04	1800pF My
C305	23S40657F10	10uF 16V E1	C371	23S40657F10	10uF 16V E1
C306	23S40657F10	10uF 16V E1	C372	23S40657F10	10uF 16V E1
C309	23S40657F52	220uF 16V E1	C413	23S40657F29	2.2uF 50V E1
C310	23S40657F52	220uF 16V E1	C414	23S40657F29	2.2uF 50V E1
C311	23S40657F12	33uF 16V E1	C415	08T55260F33	68pF Ce
C313	23S40657F24	22uF 35V E1	C416	08T55260F33	68pF Ce
C314	23S40657F24	22uF 35V E1	C417	23S40657F09	220uF 10V E1
C317	23S40657F28	1uF 50V E1	C418	23S40657F09	220uF 10V E1
C318	23S40657F28	1uF 50V E1	C503	08S44503P06	0.0027uF My
C319	23S40657F28	1uF 50V E1	C504	08S44503P06	0.0027uF My
C320	23S40657F28	1uF 50V E1	C505	08T55260F41	220pF Ce
C321	23S40657F14	100uF 16V E1	C506	08T55260F41	220pF Ce
C322	23S40657F14	100uF 16V E1	C507	08T55260F49	1000pF Ce
C323	08S40656F15	0.015uF My	C508	08T55260F49	1000pF Ce
C324	08S40656F15	0.015uF My	C509	08T55260F44	390pF Ce
C325	23S40657F10	10uF 16V E1	C510	08T55260F44	390pF Ce
C326	23S40657F10	10uF 16V E1	C511	08S40656F02	1200pF My

Symbol No.	Stock No.	Description	Symbol No.	Stock No.	Description	
C512	08540656F02	1200pF	R222	06555065F97	22K 1/6W Rd	
C513	23T42478F09	4.7uF 25V	R223	06555065F69	1.5K 1/6W Rd	
C514	23542478F09	4.7uF 25V	R224	06555065F69	1.5K 1/6W Rd	
C515	23540657F14	100uF 16V	R225	06555066F02	33K 1/6W Rd	
C516	23541198U42	220uF 25V	E1	R226	06555066F02	33K 1/6W Rd
C517	23542478F09	4.7uF 25V	E1	R227	06555066F37	910K 1/6W Rd
C518	23T42478F09	4.7uF 25V	E1	R228	06555066F02	910K 1/6W Rd
C521	08540656F13	0.01uF	My	R229	06555065F81	4.7K 1/6W Rd
C522	08540656F13	0.01uF	My	R230	06555065F81	4.7K 1/6W Rd
C523	08540656F25	0.1uF	My	R235	06555065F83	5.6K 1/6W Rd
C524	08540656F25	0.1uF	My	R236	06555065F83	5.6K 1/6W Rd
C525	23T42478F09	4.7uF 25V	E1	R239	06555065F97	22K 1/6W Rd
C526	23T42478F09	4.7uF 25V	E1	R240	06555065F97	22K 1/6W Rd
C527	08T55260F43	330pF	Ce	R241	06555065F99	27K 1/6W Rd
C528	08T55260F43	330pF	Ce	R243	06555065F65	1K 1/6W Rd
C529	08T55260F35	82pF	Ce	R244	06555065F65	1K 1/6W Rd
C530	08T55260F35	82pF	Ce	R251	06555065F91	12K 1/6W Rd
C531	08T55260F49	1000pF	Ce	R252	06555065F91	12K 1/6W Rd
C532	08T55260F49	1000pF	Ce	R253	06555065F57	470 1/6W Rd
C533	08T55260F43	330pF	Ce	R254	06555065F57	470 1/6W Rd
C534	08T55260F43	330pF	Ce	R255	06555065F89	10K 1/6W Rd
C535	08T55260F49	1000pF	Ce	R256	06555065F89	10K 1/6W Rd
C536	08T55260F49	1000pF	Ce	R257	06555066F30	470K 1/6W Rd
C538	08T52448F21	2200pF	Pp	R258	06555066F30	470K 1/6W Rd
C539	08540656F11	6800pF	My	R259	06555066F38	1M 1/6W Rd
C540	08540656F07	3300pF	My	R260	06555066F38	1M 1/6W Rd
C541	08540656F07	3300pF	My	R261	06555065F89	10K 1/6W Rd
C542	08540656F13	0.01uF	My	R262	06555065F89	10K 1/6W Rd
C543	23540657F20	47uF 25V	E1	R263	06555066F14	100K 1/6W Rd
C555	08T55260F43	330pF	Ce	R264	06555066F14	100K 1/6W Rd
C556	08T55260F43	330pF	Ce	R301	06555065F81	4.7K 1/6W Rd
C901	23540657F28	1uF 50V	E1	R302	06555066F06	47K 1/6W Rd
C902	08T55260F61	0.01uF	Ce	R303	06555065F41	100 1/6W Rd
C903	23540657F16	4.7uF 25V	E1	R304	06555065F41	100 1/6W Rd
C904	23540657F21	100uF 25V	E1	R305	06555066F14	100K 1/6W Rd
C905	23540657F16	4.7uF 25V	E1	R306	06555066F14	100K 1/6W Rd
C906	23540657F10	10uF 16V	E1	R307	06555066F24	270K 1/6W Rd
C907	23540657F16	4.7uF 25V	E1	R308	06555066F24	270K 1/6W Rd
C909	23540657F28	1uF 50V	E1	R309	06555066F06	47K 1/6W Rd
(Resistor)						
R101	06T55177F69	1.5K 1W	Rm	R310	06555066F06	47K 1/6W Rd
R102	06T55177F53	330 1W	Rm	R311	06555065F74	2.4K 1/6W Rd
R203	06555065F41	100 1/6W	Rd	R312	06555065F74	2.4K 1/6W Rd
R204	06555065F41	100 1/6W	Rd	R313	06555065F71	1.8K 1/6W Rd
R205	06555065F89	10K 1/6W	Rd	R314	06555065F71	1.8K 1/6W Rd
R206	06555065F89	10K 1/6W	Rd	R319	05T55179F47	180 2W Rm
R207	06555065F81	4.7K 1/6W	Rd	R320	08T55179F47	180 2W Rm
R208	06555065F81	4.7K 1/6W	Rd	R321	06555065F81	4.7K 1/6W Rd
R209	06555065F89	10K 1/6W	Rd	R322	06555065F83	5.6K 1/6W Rd
R210	06555065F89	10K 1/6W	Rd	R323	06555065F73	2.2K 1/6W Rd
R211	06555065F89	10K 1/6W	Rd	R324	06555065F87	8.2K 1/6W Rd
R212	06555065F89	10K 1/6W	Rd	R325	06555066F02	33K 1/6W Rd
R213	06555066F14	100K 1/6W	Rd	R326	06555066F02	33K 1/6W Rd
R214	06555066F14	100K 1/6W	Rd	R327	06555065F97	22K 1/6W Rd
R215	06555065F53	330 1/6W	Rd	R328	06555065F97	22K 1/6W Rd
R216	06555065F53	330 1/6W	Rd	R329	06555066F08	56K 1/6W Rd
R219	06555066F22	220K 1/6W	Rd	R330	06555066F08	56K 1/6W Rd
R220	06555066F22	220K 1/6W	Rd	R331	06555066F08	56K 1/6W Rd
R221	06555065F97	22K 1/6W	Rd	R332	06555066F08	56K 1/6W Rd
				R333	06555065F82	5.1K 1/6W Rd

Symbol No.	Stock No.	Description			Symbol No.	Stock No.	Description		
R334	06S55065F82	5.1K	1/6W	Rd	R439	06S55065F89	10K	1/6W	Rd
R335	06S55065F93	15K	1/6W	Rd	R440	06S55065F89	10K	1/6W	Rd
R336	06S55065F93	15K	1/6W	Rd	R443	06S55065F65	1K	1/6W	Rd
R337	06S55065F47	180	1/6W	Rd	R444	06S55065F65	1K	1/6W	Rd
R338	06S55065F47	180	1/6W	Rd	R501	06S55066F08	56K	1/6W	Rd
R339	06S55066F06	47K	1/6W	Rd	R502	06S55066F08	56K	1/6W	Rd
R340	06S55066F06	47K	1/6W	Rd	R503	06S55066F01	30K	1/6W	Rd
R341	06S55065F84	6.2K	1/6W	Rd	R504	06S55066F01	30K	1/6W	Rd
R342	06S55065F84	6.2K	1/6W	Rd	R505	06S55066F16	120K	1/6W	Rd
R343	06S55066F12	82K	1/6W	Rd	R506	06S55066F16	120K	1/6W	Rd
R344	06S55066F12	82K	1/6W	Rd	R507	06S55066F04	39K	1/6W	Rd
R345	06S55065F41	100	1/6W	Rd	R508	06S55066F04	39K	1/6W	Rd
R346	06S55065F41	100	1/6W	Rd	R509	06S55066F07	51K	1/6W	Rd
R347	06S55066F38	1M	1/6W	Rd	R510	06S55066F07	51K	1/6W	Rd
R348	06S55066F38	1M	1/6W	Rd	R511	06S55065F95	18K	1/6W	Rd
R349	06S55065F82	5.1K	1/6W	Rd	R512	06S55065F95	18K	1/6W	Rd
R350	06S55065F82	5.1K	1/6W	Rd	R513	06S55065F89	10K	1/6W	Rd
R351	06S55065F89	10K	1/6W	Rd	R514	06S55065F89	10K	1/6W	Rd
R352	06S55065F89	10K	1/6W	Rd	R515	06S55066F10	18K	1/6W	Rd
R353	06S55066F10	68K	1/6W	Rd	R516	06S55066F10	18K	1/6W	Rd
R354	06S55066F10	68K	1/6W	Rd	R517	06S55066F10	68K	1/6W	Rd
R355	06S55065F81	4.7K	1/6W	Rd	R518	06S55066F10	68K	1/6W	Rd
R356	06S55065F81	4.7K	1/6W	Rd	R519	06S55066F10	68K	1/6W	Rd
R357	06S55065F50	240	1/6W	Rd	R520	06S55066F10	18K	1/6W	Rd
R358	06S55065F50	240	1/6W	Rd	R521	06S55066F06	47K	1/6W	Rd
R359	06S55066F08	56K	1/6W	Rd	R522	06S55066F06	47K	1/6W	Rd
R360	06S55066F08	56K	1/6W	Rd	R523	06S55066F08	56K	1/6W	Rd
R361	06S55065F49	220	1/6W	Rd	R524	06S55066F08	56K	1/6W	Rd
R362	06S55065F49	220	1/6W	Rd	R525	06S55065F75	2.7K	1/6W	Rd
R363	06S55065F87	8.2K	1/6W	Rd	R526	06S55065F75	2.7K	1/6W	Rd
R364	06S55065F87	8.2K	1/6W	Rd	R527	06S55065F89	10K	1/6W	Rd
R865	06S55065F84	6.2K	1/6W	Rd	R528	06S55065F89	10K	1/6W	Rd
R366	06S55065F84	6.2K	1/6W	Rd	R531	06S55065F44	130	1/6W	Rd
R367	06S55066F12	82K	1/6W	Rd	R532	06S55065F44	130	1/6W	Rd
R368	06S55066F12	82K	1/6W	Rd	R533	06S55065F89	10K	1/6W	Rd
R369	06S55065F65	1K	1/6W	Rd	R534	06S55065F89	10K	1/6W	Rd
R370	06S55065F65	1K	1/6W	Rd	R537	06S55065F41	100K	1/6W	Rd
R371	06S55065F77	3.3K	1/6W	Rd	R538	06S55065F41	100K	1/6W	Rd
R372	06S55065F77	3.3K	1/6W	Rd	R539	06S55066F02	33K	1/6W	Rd
R373	06S55065F87	8.2K	1/6W	Rd	R540	06S55066F02	33K	1/6W	Rd
R374	06S55065F87	8.2K	1/6W	Rd	R541	06S55066F20	180K	1/6W	Rd
R375	06S55065F82	5.1K	1/6W	Rd	R542	06S55066F20	180K	1/6W	Rd
R376	06S55065F82	5.1K	1/6W	Rd	R543	06S55065F89	10K	1/6W	Rd
R377	06S55065F87	8.2K	1/6W	Rd	R544	06S55065F89	10K	1/6W	Rd
R378	06S55065F87	8.2K	1/6W	Rd	R545	06S55066F38	1M	1/6W	Rd
R379	06S55065F83	5.6K	1/6W	Rd	R546	06S55066F38	1M	1/6W	Rd
R380	06S55065F83	5.6K	1/6W	Rd	R547	06S55065F89	10K	1/6W	Rd
R425	06S55065F59	560	1/6W	Rd	R548	06S55065F89	10K	1/6W	Rd
R426	06S55065F59	560	1/6W	Rd	R549	06S55065F89	10K	1/6W	Rd
R427	06S55065F81	4.7K	1/6W	Rd	R550	06S55065F89	10K	1/6W	Rd
R428	06S55065F81	4.7K	1/6W	Rd	R552	06S55065F01	2.2	1/6W	Rd
R429	06S55065F55	390	1/6W	Rd	R553	06T55175F17	10	1/2W	Rm
R430	06S55065F55	390	1/6W	Rd	R554	06T55175F17	10	1/2W	Rm
R431	06S55066F12	82K	1/6W	Rd	R555	06S55065F97	22K	1/6W	Rd
R432	06S55066F12	82K	1/6W	Rd	R556	06S55065F97	22K	1/6W	Rd
R435	06T55175F53	330	1W	Rm	R557	06S55065F57	470	1/6W	Rd
R436	06T55175F53	330	1W	Rm	R558	06S55065F57	470	1/6W	Rd
R437	06T55275F29	33K	1/2W	Rm					
R438	06T55275F29	33K	1/2W	Rm					

Symbol No.	Stock No.	Description			Symbol No.	Stock No.	Description		
R559	06S55065F77	3.3K	1/6W	Rd	R917	06S55065F87	8.2K	1/6W	Rd
R560	06S55065F97	22K	1/6W	Rd	R918	06S55065F73	2.2K	1/6W	Rd
R561	06S55065F81	4.7K	1/6W	Rd	R919	06S55065F97	22K	1/6W	Rd
R630	06S55065F97	22K	1/6W	Rd	R920	06S55066F02	33K	1/6W	Rd
R631	06S55065F75	2.7K	1/6W	Rd	R921	06S55065F97	22K	1/6W	Rd
R632	06S55065F89	10K	1/6W	Rd	R923	06S55065F97	22K	1/6W	Rd
R901	06S55065F89	10K	1/6W	Rd	R924	06S55065F97	22K	1/6W	Rd
R902	06S55065F89	10K	1/6W	Rd	R925	06S55065F93	15K	1/6W	Rd
R903	06S55065F97	22K	1/6W	Rd	R926	06S55066F02	33K	1/6W	Rd
R904	06S55065F97	22K	1/6W	Rd	R927	06S55066F02	33K	1/6W	Rd
R905	06S55065F97	22K	1/6W	Rd	R928	06S55065F89	10K	1/6W	Rd
R906	06S55065F89	10K	1/6W	Rd	R929	06S55065F89	10K	1/6W	Rd
R907	06S55065F89	10K	1/6W	Rd	R930	06S55065F89	10K	1/6W	Rd
R908	06S55065F89	10K	1/6W	Rd	R931	06S55065F89	10K	1/6W	Rd
R909	06S55065F81	4.7K	1/6W	Rd	R932	06S55065F89	10K	1/6W	Rd
R910	06S55065F97	22K	1/6W	Rd	R933	06S55065F89	10K	1/6W	Rd
R911	06S55065F97	22K	1/6W	Rd	R934	06S55065F89	10K	1/6W	Rd
R912	06S55066F06	47K	1/6W	Rd	R935	06S55065F89	10K	1/6W	Rd
R913	06S55065F89	10K	1/6W	Rd	R936	06S55065F89	10K	1/6W	Rd
R914	06S55065F89	10K	1/6W	Rd	R937	06S55065F89	10K	1/6W	Rd

Control PCB Parts List

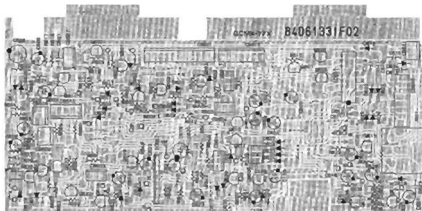

Symbol No.	Stock No.	Description			Symbol No.	Stock No.	Description		
(IC)									
IC601	51S471110F01	BA843							
IC602	51T52852F01	MS1143L							
(Transistor)									
Q103	48T47144F03	2SD400-F							
Q601	48T43015U01	2SC120-Y							
Q602	48T43915U01	2SC120-Y							
Q603	48T43015U01	2SC120-Y							
Q604	48T43915U01	2SC120-Y							
Q605	48S43525F05	2SC1815-Y, GR							
Q606	48S43525F05	2SC1815-Y, GR							
Q607	48S43525F05	2SC1815-Y, GR							
Q608	48S43525F05	2SC1815-Y, GR							
Q609	48S4325F05	2SC1815-Y, GR							
Q610	48S43525F05	2SC1815-Y, GR							
Q611	48S43525F05	2SC1815-Y, GR							
(Diode)									
D601	48T61129F01	GP10-4003-R5							
D602	48T61129F05	GP10-4003-R5							
D603	48T61129F01	GP10-4003-R5							

Symbol No.	Stock No.	Description
D604	48T61129F01	GP10-4003-R5
D605	48T58583F01	SS176PA7
D606	48T58583F01	SS176TPA7
D607	48T58583F01	SS176TPA7
D608	48T58583F01	SS176PA7
D609	48T58583F01	SS176PA7
D610	48T58583F01	SS176PA7
D611	48T58583F01	SS176PA7
D614	48T58583F01	SS176TAP-7
D615	48T58583F01	SS176TAP-7
D616	48T58583F01	SS176TAP-7
D617	48T57425F01	GE 1M 60FM
D618	48T58583F01	SS176PA7
D619	48T58583F01	SS176PA7
D920	48T58583F01	SS176PA7
D621	48T58583F01	SS176PA7
D622	48T58583F01	SS176PA7
D623	48T58583F01	SS176PA7
D624	48T58583F01	SS176PA7
D625	48T58583F01	SS176PA7
D626	48T58583F01	SS176PA7
D627	48T58583F01	SS176TAP-7
D628	58T58583F01	SS176PA7
D629	48T58583F01	SS176PA7
D634	48T57425F01	GE 1M 60FM
D635	48T58583F01	SS176TAP-7
D637	48T58583F01	SS176TAP-7
(Diode, Zener)		
ZD103	48T40150U32	HZ5B-2
(Capacitor)		
C108	23S40657F10	10uF 16V E1
C109	23S40657F10	10uF 16V E1
C601	23S40657F27	0.47uF 50V E1
C602	23S40657F10	10uF 16V E1
C603	23S40657F09	220uF 10V E1
C604	23S40657F09	220uF 10V E1
C605	23S40657F14	100uF 10V E1
C606	23S40657F10	10uF 16V E1
C607	08T55269F61	0.01uF Ce
C608	23S40657F09	220uF 10V E1
C609	08T55260F61	0.01uF E1
C610	23S40657F14	100uF 16V E1
C611	08T55206F61	0.01uF Ce
C612	08T55260F61	0.01uF Ce
C613	08T55260F61	0.01uF Ce
C614	08T55260F61	0.01uF Ce
C615	08T55260F61	0.01uF Ce
C616	08T55260F61	0.01uF Ce
C617	23S40657F13	47uF 16V E1
C618	23S40657F28	1uF 50V E1
C619	23S40657F14	100uF 16V E1
C620	08T55260F49	1000pF Ce
C621	23S40657F30	3.3uF 50V E1
C622	23T42478F18	0.1uF 50V E1
C623	23S40657F29	2.2uF 50V E1
C624	23S40657F29	2.2uF 50V E1
C625	23S40657F18	22uF 25V E1
C626	23S40657F10	10uF 16V E1
C627	08T55260F61	0.01uF Ce

Symbol No.	Stock No.	Description
C629	23S40657F10	10uF 16V E1
(Resistor)		
R103	05S55065F63	820 1/6W Rd
R601	05S55065F73	2.2K 1/6W Rd
R602	05S55065F59	560 1/6W Rd
R603	05S55065F59	560 1/6W Rd
R604	05S55065F53	330 1/6W Rd
R605	05S55065F53	330 1/6W Rd
R656	05S55065F59	560 1/6W Rd
R607	05S55065F89	10K 1/6W Rd
R608	05S55065F53	330 1/6W Rd
R609	05S55066F06	47K 1/6W Rd
R610	05S55065F06	47K 1/6W Rd
R611	05S57258F97	22K 1/6W Rd
R612	05S55065F73	2.2K 1/6W Rd
R615	05S55065F85	6.8K 1/6W Rd
R616	05S55065F91	12K 1/6W Rd
R617	05S55065F93	15K 1/6W Rd
R618	05S55065F89	10K 1.6W Rd
R619	05S55065F77	3.3K 1.6W Rd
R620	05S55065F93	15K 1/6W Rd
R621	05S55065F81	4.7K 1/6W Rd
R622	05S55066F06	47K 1/6W Rd
R623	05S55066F04	39K 1/6W Rd
R624	05S55066F02	33K 1/6W Rd
R625	05S55065F41	100 1/6W Rd
R626	05S55065F53	330 1/6W Rd
R627	05S55065F77	3.3K 1/6W Rd
R628	05S55066F06	47K 1/6W Rd
R629	05S55066F02	33K 1/6W Rd
R633	05S55065F77	3.3K 1/6W Rd
R634	05S55065F77	3.3K 1/6W Rd
R635	05S55065F89	10K 1/6W Rd
R636	05S55065F77	3.3K 1/6W Rd
R637	05S55065F77	3.3K 1/6W Rd
R638	05S55065F69	1.5K 1/6W Rd
R639	05S55065F69	1.5K 1/6W Rd
R640	05S55066F02	33K 1/6W Rd
R641	05S55066F02	33K 1/6W Rd
R642	05S55066F36	820K 1/6W Rd
R643	05S55066F31	510K 1/6W Rd
R645	05S55066F06	47K 1/6W Rd
R646	05S55065F69	1.5K 1/6W Rd
R647	05S55065F59	560 1/6W Rd
R648	05S55065F73	2.2K 1/6W Rd
R650	05S55065F97	22K 1/6W Rd
R651	05S55065F97	22K 1/6W Rd
R654	05S55065F89	10K 1/6W Rd
R655	05S55066F14	100K 1/6W Rd
R656	05S55065F89	10K 1/6W Rd
R657	05S55066F06	47K 1/6W Rd
R658	05S55065F97	22K 1/6W Rd
R659	05S55065F93	15K 1/6W Rd
R660	05S55066F06	47K 1/6W Rd
R661	05S55065F97	22K 1/6W Rd
R662	05S55065F97	22K 1/6W Rd
R663	05S55066F06	47K 1/6W Rd
R664	05S55065F97	22K 1/6W Rd
R665	05S55066F97	47K 1/6W Rd

FL Meter PCB Parts List

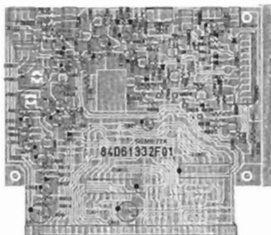

Symbol No.	Stock No.	Description
(Variable, Resistor)		
VR801	18T52946F17	47K
VR802	18T52946F17	47K
(FL Meter)		
E801	65T52950101	FIP 120W7YS
(IC)		
IC801	51T42626F01	HA12019
IC802	51T42626F01	HA12019
(Transistor)		
Q801	48S43525F05	2SC1815-Y, GR
Q802	48S43525F05	2SC1815-Y,GR
(Diode)		
D801	48T43982F01	GE OA95
D802	48T43982F01	GE OA95
(Diode, Zener)		
ZD801	48T40150U32	HZ 6B-2
(Capacitor)		
C801	23S40657F10	10uF 16V E1
C802	23S40657F10	10uF 16V E1
C803	23S40657F17	10uF 25V E1
C804	23S40657F17	10uF 25V E1
C805	23S40657F17	10uF 25V E1
C806	23S40657F17	10uF 25V E1
C807	23T42478F21	0.33uF 50V E1
C808	23T42478F21	0.33uF 50V E1

Symbol No.	Stock No.	Description
C809	23S40657F21	100uF 25V E1
C810	23S40657F21	100uF 25V E1
C816	23S40657F26	47uF 35V E1
(Resistor)		
R801	06S55065F89	10K 1/6W Rd
R802	06S55065F89	10K 1/6W Rd
R803	06S55066F29	430K 1/6W Rd
R804	06S55066F29	430K 1/6W Rd
R805	06S55065F71	1.8K 1/6W Rd
R806	06S55065F71	1.8K 1/6W Rd
R807	06S55066F18	150W 1/6W Rd
R808	06S55066F18	150W 1/6W Rd
R809	06S40151T50	3.3M 1/4W Rd
R810	06S40151T50	3.3K 1/4W Rd
R811	06S55065F85	6.8K 1/6W Rd
R812	06S55065F85	6.8K 1/6W Rd
R813	06S55065F49	220 1/6W Rd
R814	06S55065F49	220 1/6W Rd
R815	06S55179F47	180 2W Rd
R816	06S55065F41	100 1/6W Rd
R817	06S55065F41	100 1/6W Rd
R818	06S55065F41	100 1/6W Rd
R819	06T55175F51	270 1/2W Rm

Key Board Switch Parts List



Symbol No.	Stock No.	Description
(Switch)		
S601	40T44505F01	SW, KHG
S602	40T44505F01	SW, KHG
S603	40T44505F01	SW, KHG
S604	40T44505F01	SW, KHG
S605	40T44505F01	SW, KHG
S606	40T44505F01	SW, KHG
S607	40T44505F01	SW, KHG

Rotary Switch PCB Parts List



Symbol No.	Stock No.	Description
(Switch)		
S616	40T57206F01	SRZ-S 6-4
(Diode)		
D638	48T44813F01	MA165TA-AX
D639	48T44813F01	MA165TA-AX
D640	48T44813F01	MA165TA-AX

Head Phone PCB Parts List



Symbol No.	Stock No.	Description
(Jack)		
J401	09T60076F02	Head Phone

Music Scan PCB Parts List



Symbol No.	Stock No.	Description
(Switch)		
S609	40T44505F01	SW, KHG
S610	40T44505F01	SW, KHG

Memory Switch PCB Parts List



Symbol No.	Stock No.	Description
(Switch)		
	40T57208F01	SW, Push SPH12-A
(Diode)		
D641	48T44813F01	MA165TA

Indicator PCB Parts List



Symbol No.	Stock No.	Description
(Lamp)		
PL617	65B43447J03	Lamp Pilot
PL618	65B43447J03	Lamp Pilot
PL619	65B43447J03	Lamp Pilot

Power Supply PCB Parts List



Symbol No.	Stock No.	Description
(Transistor)		
Q101	48T56031F01	2SD1266-P, Q
Q102	48T56031F01	2SD1266-P, Q
Q104	48S43525F05	2SC815-Y, GR
Q105	48S43525F05	2SC815-Y, GR

Reed Switch PCB Parts List



Symbol No.	Stock No.	Description
(Switch)		
	40T47104F01	SW, Reed

Remarks

Capacitor;	EL Electrolytic, Capacitor
	Ce Ceramic, Capacitor
	My Mylar, Capacitor
	Mi Mica, Capacitor
	Pe Polyethelen, Capacitor
	Po Polystyrene, Capacitor
	Pp Polypropylene, Capacitor
	LR Low Leak, Capacitor
	PB Bi-Polar, Capacitor
Resistor;	Rd Carbon, Resistor
	Rm Metal Film, Resistor
	Rc Cement, Resistor

Schematic Diagram(A)

LUX K-240
AMP CIRCUIT

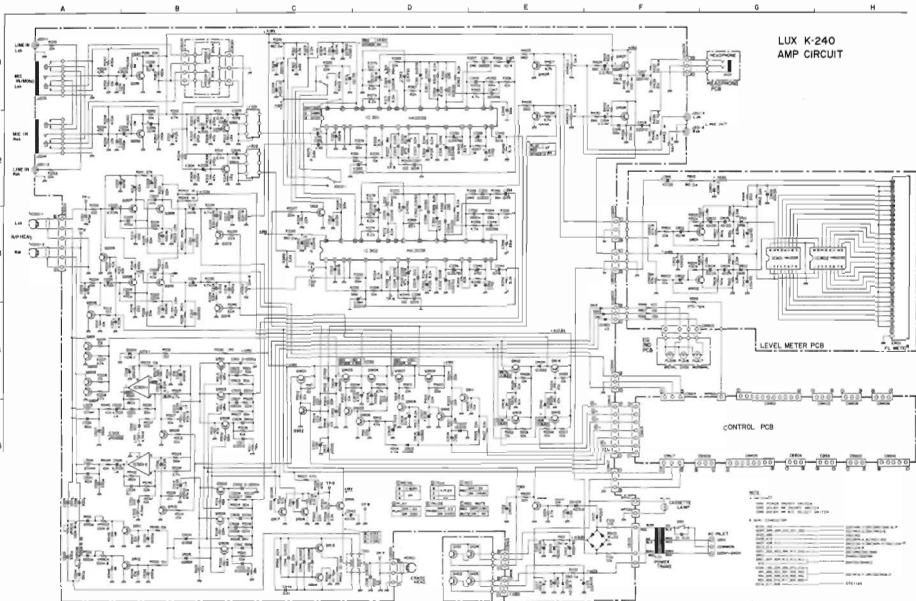

Schematic Diagram(B)

LUX K-240 CONTROL CIRCUIT

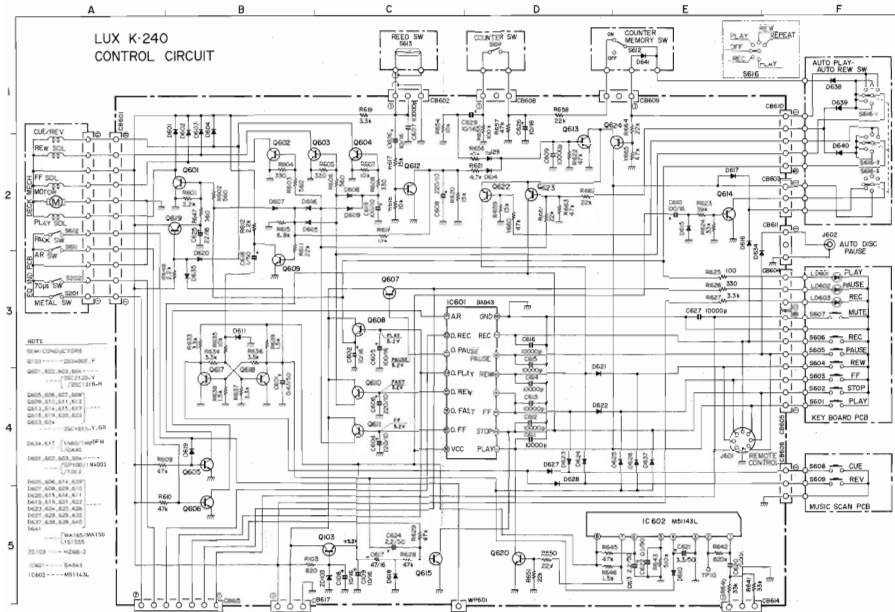

IC Handling Guide

HA12019 IC801, 802 (Stock No. 51T4262F01)

Fluorescent Tube Driver for Bar Graph Display

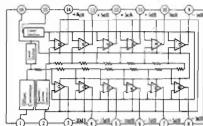

HA12038-01 IC301, IC302 (Stock No. 51T52160F01)

Dolby Band-C Type Noise Reduction System

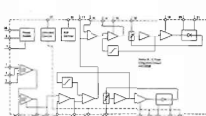

BA843 IC601 (Stock No. 51S47110F01)

Key Control

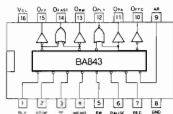

μPC4558 IC501 (Stock No. 51S43471U02)



(Top View)

M511435 IC602 (Stock No. 61T52852F01)

Music Sensor

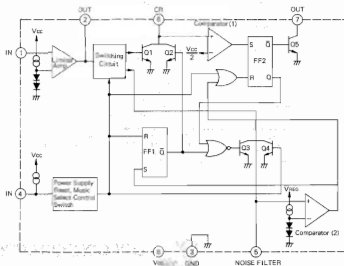

Destination's Parts List

Symbol No.	Description	Power Source		
		AG (240V) England & Oceania	A.K., S.K., B.K., E.K (220V) Europe	UO (120V) Canada
P5, 62	AC Cord, Set Label	30T60073F01 54A51730F01	30T60805F01 54A51740F01	30T60804F01 54A50257F03

Specifications

Heads:	2
Record head	Hexalum
Play back head	Hexalum
Erase head	Double Gap Ferrite
Wow & Flutter: (PPM)	0.04%
Signal-to-Noise Ratio: (COP weighted)	
Metal-Tape, without NR	66dB
Metal-Tape, with Dolby-B-NR	67dB
Metal-Tape, with Dolby-C-NR	71dB
CrO ₂ Tape, without NR	68dB
CrO ₂ Tape, with Dolby-B-NR	67dB
CrO ₂ Tape, with Dolby-C-NR	71dB
Nor./Tape, without NR	57dB
Nor./Tape, with Dolby-B-NR	65dB
Nor./Tape, with Dolby-C-NR	70dB
Frequency Response:	
Metal Tape:	20Hz~20,000Hz (20Hz~18,000Hz±3dB)
CrO ₂ Tape:	20Hz~18,000Hz (20Hz~16,000Hz±3dB)
Nor. Tape:	20Hz~17,000Hz (20Hz~15,000Hz±3dB)
The 3rd Harmonic Distortion: (Normal tape, 1kHz, 0dB)	0.7%
Input Sensitivity:	line in: 80mV microphone: 300µV
Output Level:	line out: 500mV headphone: 1mW (8 ohms load)
Power Consumption:	20W
Dimensions:	453(W) x 270(D) x 111(H) mm (17.8" x 10.6" x 4.3")
Weight:	Net: 5.0 kgs (11.0 lbs) Gross: 6.0 kgs (13.2 lbs)

Specifications and appearance design subject to change without notice.

- NOISE REDUCTION CIRCUIT MADE UNDER LICENCE FROM DOLBY LABORATORIES. THE WORD "DOLBY" AND THE DOUBLE-D SYMBOL ARE THE TRADE MARKS OF DOLBY LABORATORIES.
- dbx is the trade marks of dbx Incorporated.



LUX CORPORATION, JAPAN

1-1, 1-CHOME, SHINJUKU-NISHIMACHI, TOKYO-KU, SHI. 162
PHONE: 03-324-0008 CABLE: LUXCORP TOKYO JAPAN TELEX: 530710 J100, E. J.