

**SOLID STATE INTEGRATED AMPLIFIER**

**L-309**

**SERVICE MANUAL**

IDLE ADJUST & ZERO D.C. OFFSET

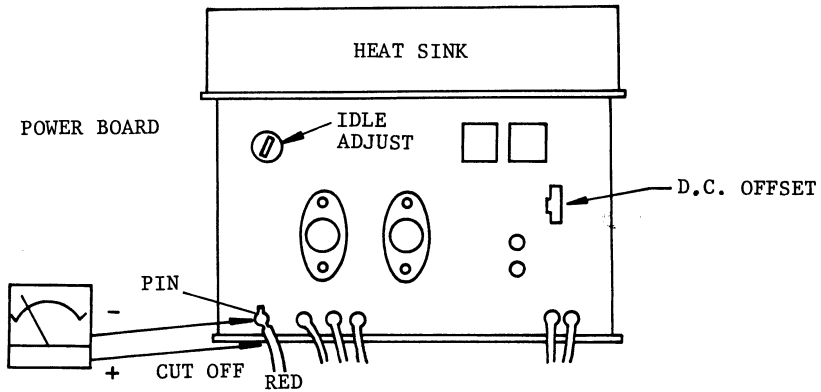

IDLE CURRENT L-309 50mA  
L-308 50mA

P.B. LOCATION

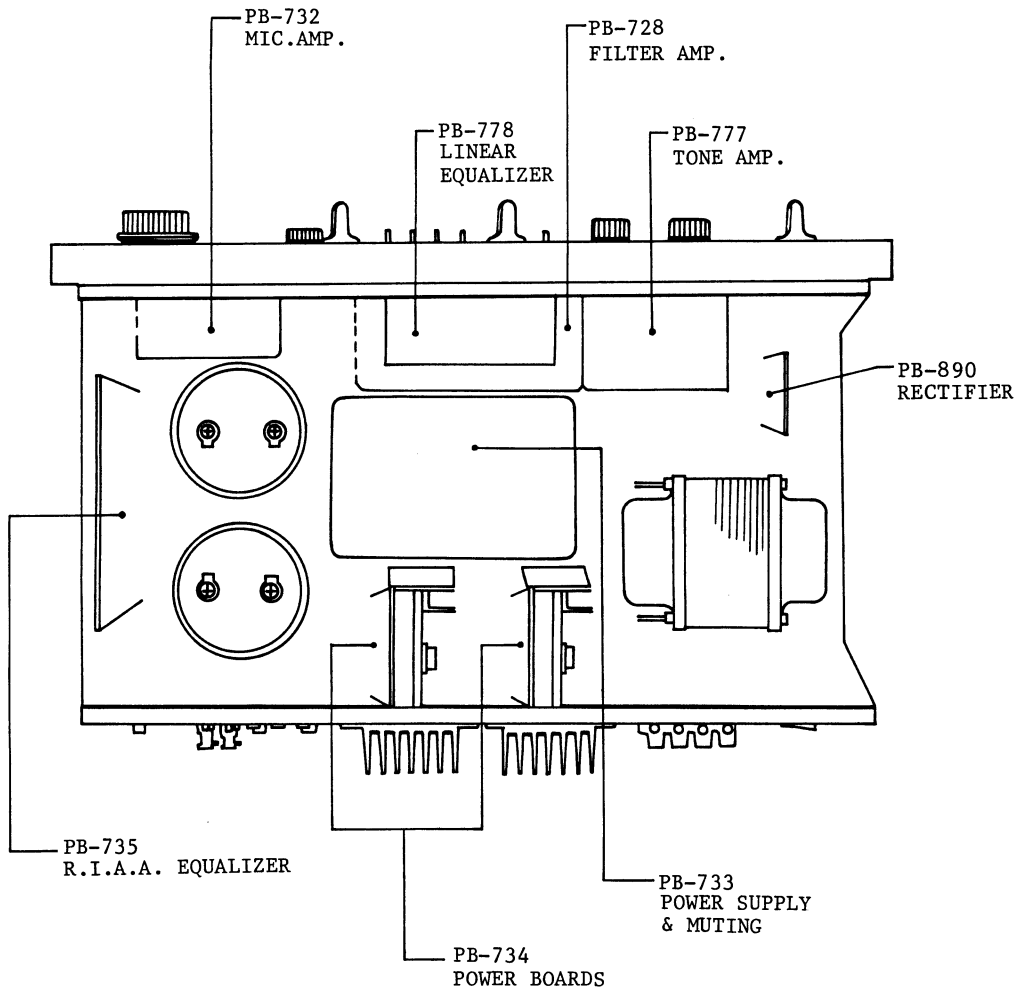

PB-735

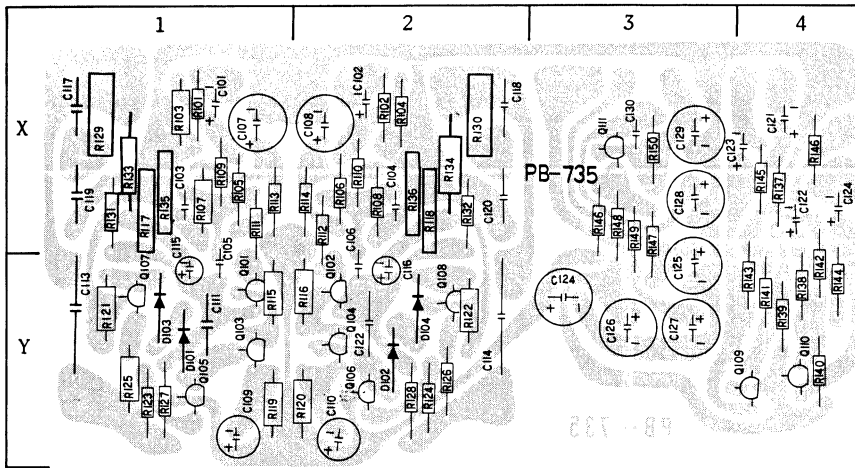

PB-732

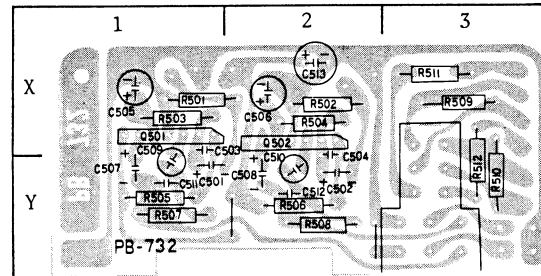

PB-733

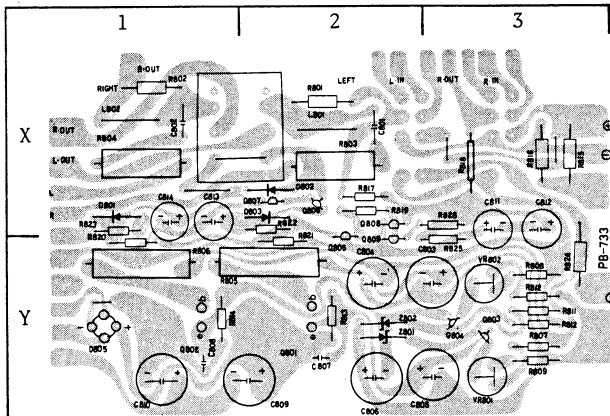

PB-777

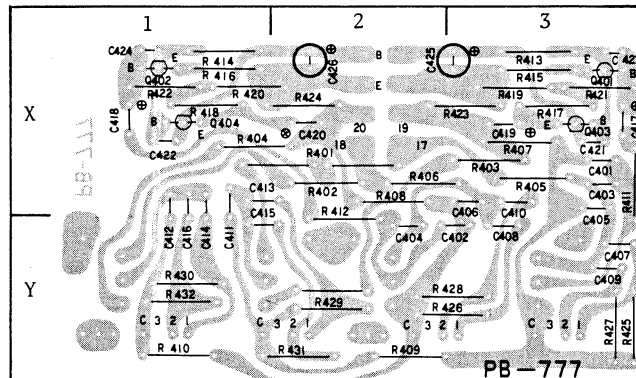

PB-778

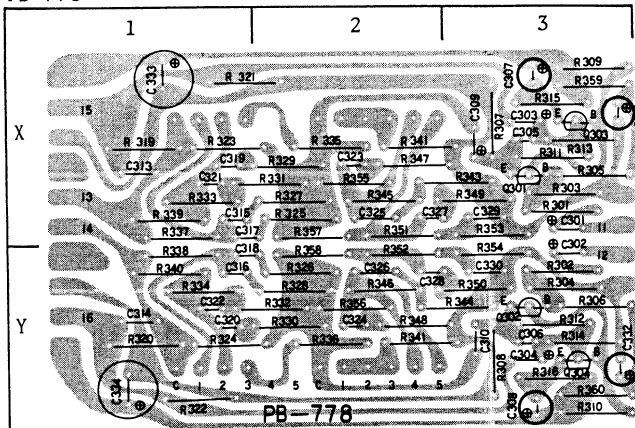

PB-728

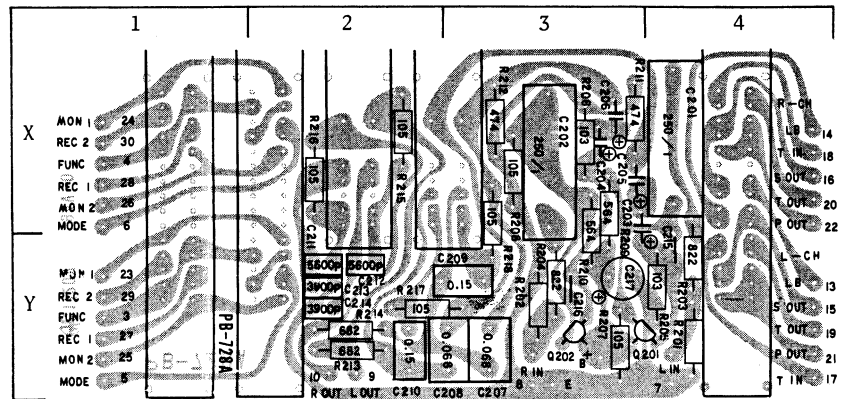

PB-734

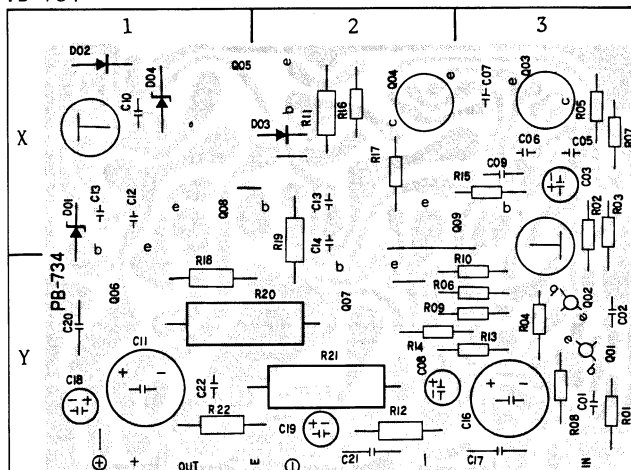

MODEL: L-309 REPLACEMENT PARTS

PB-735

R101	120K	1X	R118	33K	2X	R135	1.2K	1X
102	120K	2X	119	2.2K	1Y	136	1.2K	2X
103	1M	1X	120	2.2K	2Y	137	8.2K	4X
104	1M	2X	121	33K	1Y	138	8.2K	4Y
105	560K	1X	122	33K	2Y	139	1M	4Y
106	560K	2X	123	330	1Y	140	1M	4Y
107	12K	1X	124	330	2Y	141	1M	4Y
108	12K	2X	125	330	1Y	142	1M	4Y
109	3.9K	1X	126	330	2Y	143	10K	4Y
110	3.9K	2X	127	560K	1Y	144	10K	4Y
111	180	1X	128	560K	2Y	145	470K	4X
112	180	2X	129	39K	1X	146	470K	4X
113	100K	1X	130	39K	2X	147	330	3Y
114	100K	2X	131	1K	1X	148	4.7K	3X
115	47K	1Y	132	1K	2X	149	820	3X
116	47K	2Y	133	2.2M	1X	150	10K	3X
117	33K	1X	134	2.2M	2X			

C101	2.2uF	10V	1X	C116	33uF	10V	2Y
102	2.2uF	10V	2X	117	6200pF		1X
103	47pF		1X	118	6200pF		2X
104	47pF		2X	119	1800pF		1X
105	100pF		1Y	120	1800pF		2X
106	100pF		2Y	121	1uF	35V	4X
107	220uF	10V	1X	122	1uF	35V	4X
108	220uF	10V	2X	123	0.22uF	35V	4X
109	47uF	10V	1Y	124	0.22uF	35V	4X
110	47uF	10V	2Y	125	47uF	50V	3Y
111	270pF		1Y	126	47uF	50V	3Y
112	270pF		2Y	127	47uF	50V	3Y
113	1uF	250V	1Y	128	47uF	50V	3X
114	1uF	250V	2Y	129	47uF	50V	3X
115	33uF	10V	1Y	130	150pF		3X

Q101	2SC1222(2SC1345)	1Y	Q106	2SC1222(2SC1345)	2Y	Q111	2SC853	3X
102	2SC1222(2SC1345)	2Y	107	2SA640	1Y	D101	SV-03	1Y
103	2SA640	1Y	108	2SA640	2Y	102	SV-03	2Y
104	2SA640	2Y	109	2SC1222(2SC1345)	4Y	103	KB-165	1Y
105	2SC1222(2SC1345)	1Y	110	2SC1222(2SC1345)	4Y	104	KB-165	2Y

PB-732

SYMBOL NO. (RESISTORS;  $\pm 5\%$  1/4W)

R501	100K	X1	R505	820K	Y1	R509	8.2K	X3
502	100K	X2	506	820K	Y2	510	8.2K	Y3
503	150K	X1	507	68K	Y1	511	39K	X3
504	150K	X2	508	68K	Y2	512	39K	Y3

SYMBOL NO. (CAPACITORS)

C501	2.2uF	10V	tantalum	Y1	C508	2.2uF	35V	tantalum	Y2
502	2.2uF	10V	"	Y2	509	22uF	10V	electrolytic	Y1
503	47pF	50V	$\pm 10\%$ ceramic	X1	510	22uF	10V	"	Y2
504	47pF	50V	"	Y2	511	22pF	50V	$\pm 10\%$ ceramic	Y1
505	47uF	10V	electrolytic	X1	512	22pF	50V	"	Y2
506	47uF	10V	"	X2	513	10uF	50V	electrolytic	X2
507	2.2uF	35V	tantalum	Y1					

SYMBOL NO. (IC's)

Q501	TA7122AP	Mic. amp	X1	Q502	TA7122AP	Mic. amp	X2
------	----------	----------	----	------	----------	----------	----

PB-733

SYMBOL NO. (RESISTORS;  $\pm 5\%$  1/4W unless noted otherwise)

R801	10	1/2W		X2	R810	27K		Y3	R819	1K		X2
802	10	1/2W		X1	811	15K		Y3	820	8.2K		Y1
803	4.7	2W		X2	812	15K		Y3	821	1K		Y2
804	4.7	2W		X1	813	10K		Y2	822	180K		X2
805	150	3W wire wound		Y2	814	10K		Y1	823	2.2		X1
806	150	3W wire wound		Y1	815	15K 1/2W		X3	824	100 1/2W		Y3
807	18K			Y3	816	15K 1/2W		X3	825	3.3K		Y3
808	18K			Y3	817	8.2K		X2				
809	27K			Y3	818	8.2K		X3				

SYMBOL NO. (CAPACITORS)

C801	0.1uF	50V	$\pm 10\%$	mylar	X2	C808	0.047uF	50V	$\pm 10\%$	mylar	Y1
802	0.1uF	50V	"	"	X1	809	100uF	100V		electrolytic	Y2
803	100uF	63V		electrolytic	Y3	810	100uF	100V		"	Y1
804	100uF	63V		"	Y2	811	330uF	10V		"	X3
805	47uF	100V		"	Y3	812	330uF	10V		"	X3
806	47uF	100V		"	Y2	813	100uF	10V		"	X1
807	0.047uF	50V	$\pm 10\%$	mylar	Y2	814	22uF	50V		"	X1

SYMBOL NO. (TRANSISTORS)

Q801	2SD382 (L)	power supply		Y2	Q806	2SC1345 (E)	protection circuit		X2
802	2SB537 (L)	"		Y1	807	2SC853 (L)	"		X2
803	2SC1345 (E)	"		Y3	808	2SC945 (P)	"		X2
804	2SA640 (F)	"		Y3	809	2SC1345 (E)	"		Y2
805	2SA640 (F)	protection circuit		Y2					

SYMBOL NO. (DIODES)

D801	IN4003	rectifier		X1	D805	W 04	rectifier	Y1	Y1
802	1K 188FM-1	protection		X2	Z801	WZ-290	voltage stabilizer		Y2
803	IN4003	protection		X2	Z802	WZ-290	voltage stabilizer		Y2

SYMBOL No. (VARIABLE RESISTORS)

VR801	4.7K-B	for power supply		Y3	VR802	4.7K-B	for power supply		Y3
-------	--------	------------------	--	----	-------	--------	------------------	--	----

PB-777

SYMBOL NO. (RESISTORS;  $\pm 5\%$  1/4W)

R401	1.5K			X2	R412	3.3K			Y2	R423	220K			X3
402	1.5K			X2	413	47K			X3	424	220K			X2
403	1.5K			X3	414	47K			X1	425	1M			Y3
404	1.5K			X1	415	1K			X3	426	1M			Y3
405	18K			X3	416	1K			X1	427	1M			Y3
406	18K			X2	417	5.6K			X3	428	1M			Y3
407	18K			X3	418	5.6K			X1	429	1M			Y2
408	18K			X2	419	390			X3	430	1M			Y1
409	3.3K			Y2	420	390			X1	431	1M			Y2
410	3.3K			Y1	421	150K			X3	432	1M			Y1
411	3.3K			X3	422	150K			X1					

SYMBOL NO. (CAPACITORS)

C401	1000pF	50V	$\pm 10\%$	mylar	X3	C414	3900pF	50V	$\pm 10\%$	mylar	X1
402	1000pF	50V	"	"	Y3	415	1200pF	50V	"	"	Y1
403	1000pF	50V	"	"	X3	416	1200pF	50V	"	"	X1
404	1000pF	50V	"	"	Y2	417	4.7uF	10V		tantalum	X3
405	0.015uF	50V	"	"	X3	418	4.7uF	10V		"	X1
406	0.015uF	50V	"	"	X3	419	1uF	35V		tantalum	X3
407	0.047uF	50V	"	"	Y3	420	1uF	35V		"	X2
408	0.047uF	50V	"	"	Y3	421	33pF	50V	$\pm 10\%$	ceramic	X3
409	0.015uF	50V	"	"	Y3	422	33pF	50V	"	"	X1
410	0.015uF	50V	"	"	X3	423	4.7pF	50V	$\pm 1\%$	"	X3
411	1200pF	50V	"	"	X1	424	4.7pF	50V	"	"	X2
412	1200pF	50V	"	"	X1	425	22uF	50V		electrolytic	X3
413	3900pF	50V	"	"	X1	426	22uF	50V		"	X2

SYMBOL NO. (TRANSISTORS)

Q401	2SC1345 (E,F)	tone amp		X3	Q403	2SC1345 (E,F)	tone amp		X3
402	2SC1345 (E,F)	tone amp		X1	404	2SC1345 (E,F)	tone amp		X1

## PB-778

SYMBOL NO. (RESISTORS;  $\pm 5\%$  1/4W)

R301	4.7K	X3	R323	68K	X1	R343	5.6K	X3
302	4.7K	Y3	324	68K	Y1	344	5.6K	Y3
303	470K	X3	325	56K	X2	345	1.5K	X2
304	470K	Y3	326	56K	Y2	346	1.5K	Y2
305	560K	X3	327	120K	X2	347	27K	X2
306	560K	Y3	328	120K	Y2	348	27K	Y2
307	47K	X3	329	100K	X2	349	18K	X3
308	47K	Y3	330	100K	Y2	350	18K	Y3
309	150K	X3	331	120K	X2	351	4.7K	X2
310	150K	Y3	332	120K	Y2	352	4.7K	Y2
311	100K	X3	333	82K	X1	353	3.9K	X3
312	100K	Y3	334	82K	Y1	354	3.9K	Y3
313	6.8K	X3	335	100K	X2	355	1M	X2
314	6.8K	Y3	336	100K	Y2	356	1M	Y2
315	390	X3	337	1M	X1	357	1M	X2
316	390	Y3	338	1M	Y1	358	1M	Y2
319	820K	X1	339	1M	X1	359	1.5M	X3
320	820K	Y1	340	1M	Y1	360	1.5M	Y3
321	330K	X1	341	3.9K	X2			
322	330K	Y1	342	3.9K	Y2			

SYMBOL NO. (CAPACITORS)

C301	4.7uF	10V	tantalum	X3	C319	1000pF	50V	$\pm 10\%$	mylar	X1
302	4.7uF	10V	"	Y3	320	1000pF	50V	"	"	Y1
303	2.2uF	35V	"	X3	321	5600pF	50V	"	"	X1
304	2.2uF	35V	"	Y3	322	5600pF	50V	$\pm 10\%$	"	Y1
305	33pF	50V	$\pm 10\%$	ceramic	X3	323	8200pF	50V	"	X2
306	33pF	50V	"	"	Y3	324	8200pF	50V	"	Y2
307	47uF	10V	electrolytic	X3	325	0.068uF	50V	"	"	X2
308	47uF	10V	"	Y3	326	0.068uF	50V	"	"	Y2
309	10uF	10V	tantalum	X3	327	3300pF	50V	"	"	X2
310	10uF	10V	"	Y3	328	3300pF	50V	"	"	Y2
313	0.047uF	50V	$\pm 10\%$	mylar	X1	329	0.068uF	50V	"	X3
314	0.047uF	50V	"	Y1	330	0.068uF	50V	"	"	Y3
315	330pF	50V	"	ceramic	X1	331	1uF	25V	electrolytic	X3
316	330pF	50V	"	"	Y1	332	1uF	25V	"	Y3
317	2700pF	50V	"	mylar	X1	333	10uF	50V	"	X1
318	2700pF	50V	"	"	Y1	334	10uF	50V	"	Y1

SYMBOL NO. (TRANSISTORS)

Q301	2SC1345 (E,F)	linear equalizer	X3	Q303	2SA640 (F)	linear equalizer	X3
302	2SC1345 (E,F)	linear equalizer	Y3	304	2SA640 (F)	linear equalizer	Y3

## PB-728

SYMBOL NO. (RESISTORS;  $\pm 5\%$  1/4W)

R201	220K	Y4	R207	1M	Y3	R213	6.8K	Y2
202	220K	Y3	208	1M	X3	214	6.8K	Y2
203	8.2K	Y4	209	560K	X3	215	1M	X2
204	8.2K	Y3	210	560K	X3	216	1M	X2
205	10K	Y4	211	470K	X3	217	1M	Y2
206	10K	X3	212	470K	X3	218	1M	X3

SYMBOL NO. (CAPACITORS)

C201	1uF	250V	$\pm 0.5\%$	mylar	X4	C210	0.15uF	50V	$\pm 10\%$	mylar	Y2
202		250V	"	"	X3	211	5600pF	50V	"	"	Y2
203	2.2uF	25V	"	tantalum	X3	212	5600pF	50V	"	"	Y2
204	2.2uF	25V	"	"	X3	213	3900pF	50V	$\pm 10\%$	"	Y2
205	2.2uF	25V	"	"	X3	214	3900pF	50V	"	"	Y2
206	2.2uF	25V	"	"	X3	215	100pF	50V	"	ceramic	Y4
207	0.068uF	50V	$\pm 10\%$	mylar	Y3	216	100pF	50V	"	"	Y3
208	0.068uF	50V	"	"	Y3	217	2.2uF	50V	"	electrolytic	Y3
209	0.15uF	50V	"	"	Y3						

SYMBOL NO. (TRANSISTORS)

Q201	2SC1345 (E,F)	filter amp	Y3	Q202	2SC1345 (E,F)	filter amp	Y3
------	---------------	------------	----	------	---------------	------------	----





MISCELLANEOUS

PB-723	printed circuit board	for R.I.A.A. equalizer
724	"	power amp
728A	"	filter amplifier
729	"	for fuse
732	"	microphone amp
733	"	power supply & protection
777	"	tone amplifier
778	"	Linear Equalizer
890	"	rectifier
P-1945	power transformer	

BLOCK DIAGRAM FOR MODEL L-309

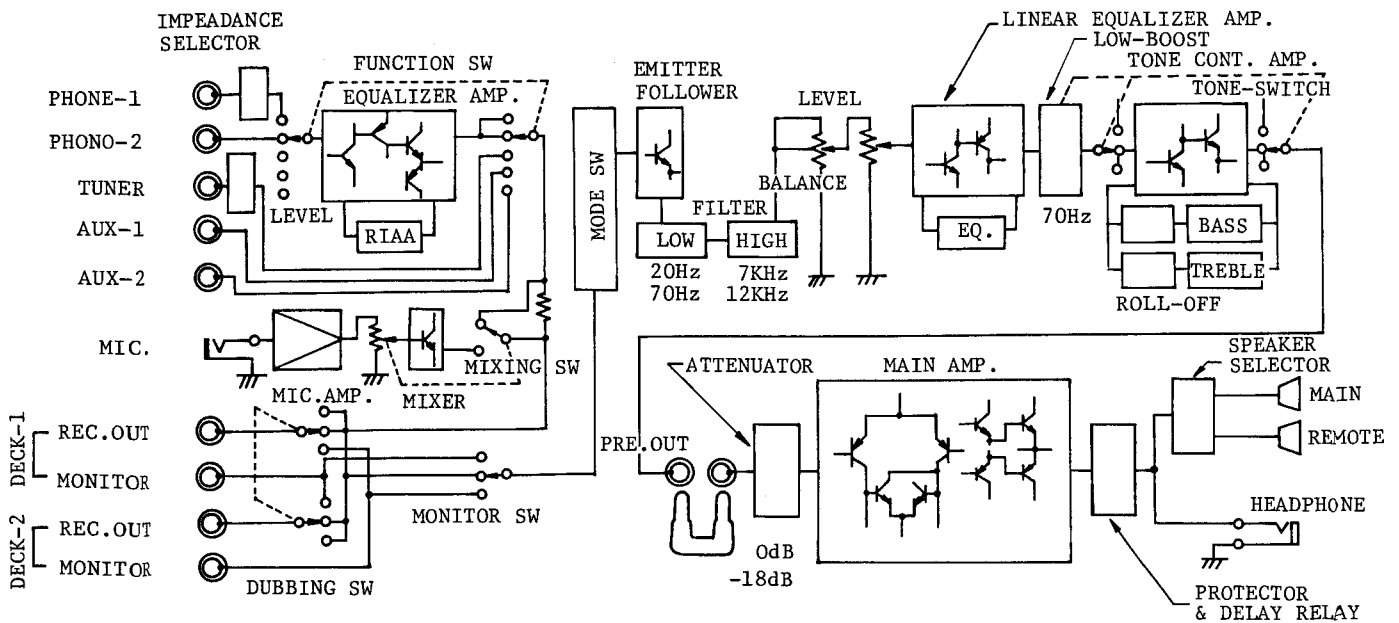

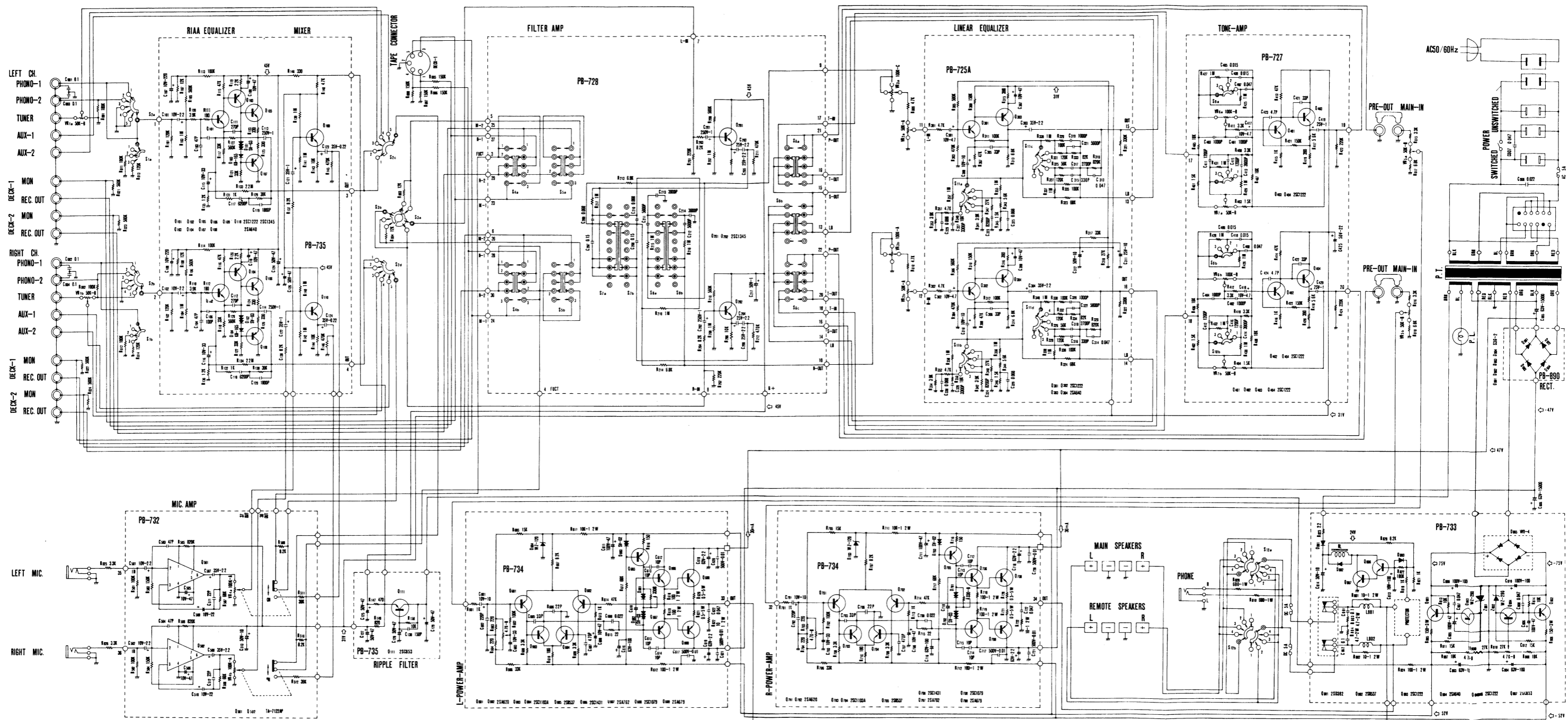

**NOTES**

- S1a, S1b ..... INPUT IMPEDANCE (PHONO-1) (1.90K $\Omega$ , 2.65K $\Omega$ , 3.50K $\Omega$ )
- S2a, S2b, S2c, S2d ..... FUNCTION (1. PHONO-1, 2. PHONO-2, 3. TUNER, 4. AUX-1, 5. AUX-2)
- S3a, S3b ..... MODE (1. L, 2. R, 3. MONO L+R, 4. STEREO, 5. STEREO-REVERSE)
- S4a, S4b ..... DUBBING (1. 210, 2. SOURCE, 3. 1 TO 2)

- S5a, S5b ..... MONITOR (1. DECK-2/4CH, 2. SOURCE, 3. DECK-1)
- S6a, S6b, S6c ..... DEFEAT (1. DEFEAT, 2. NORMAL, 3. TONE + LOW BOOST)
- S7a, S7b ..... LOW CUT (1. 20Hz, 2. NORMAL, 3. 70Hz)
- S8a, S8b ..... HIGH CUT (1. 12KHz, 2. NORMAL, 3. 7KHz)

- S9a, S9b ..... BASS (1. 150Hz, 2. 300Hz, 3. 600Hz)
- S10a, S10b ..... TREBLE (1. 1.5KHz, 2. 3KHz, 3. 6KHz)
- S11a, S11b, S11c, S11d ..... LINEAR EQUALIZER (1. 2. UP TILT, 3. FLAT, 4. 5. DOWN TILT)
- S12a, S12b ..... SPEAKERS (1. OFF, 2. REMOTE, 3. MAIN, 4. MAIN & REMOTE)

- VR1a, VR1b ..... TUNER LEVEL
- VR2a, VR2b ..... VOLUME CONTROL
- VR3a, VR3b ..... BALANCE CONTROL
- VR4a, VR4b ..... MIC LEVEL (PULL ON)

- VR5a, VR5b ..... ATTENUATOR
- VR6a, VR6b ..... BASS CONTROL
- VR7a, VR7b ..... TREBLE CONTROL

1. Unless otherwise specified, all resistors are in ohm 1/4 watt, all capacitors are in micro Farad ( $\mu$ F).
2. Transistors, IC and diodes may be replaced with any types having comparable ratings.
3. There might be slight changes in the actual set.