

<BTL-NF, GND>

Main-Amp P.C.Board (L)

Volume board

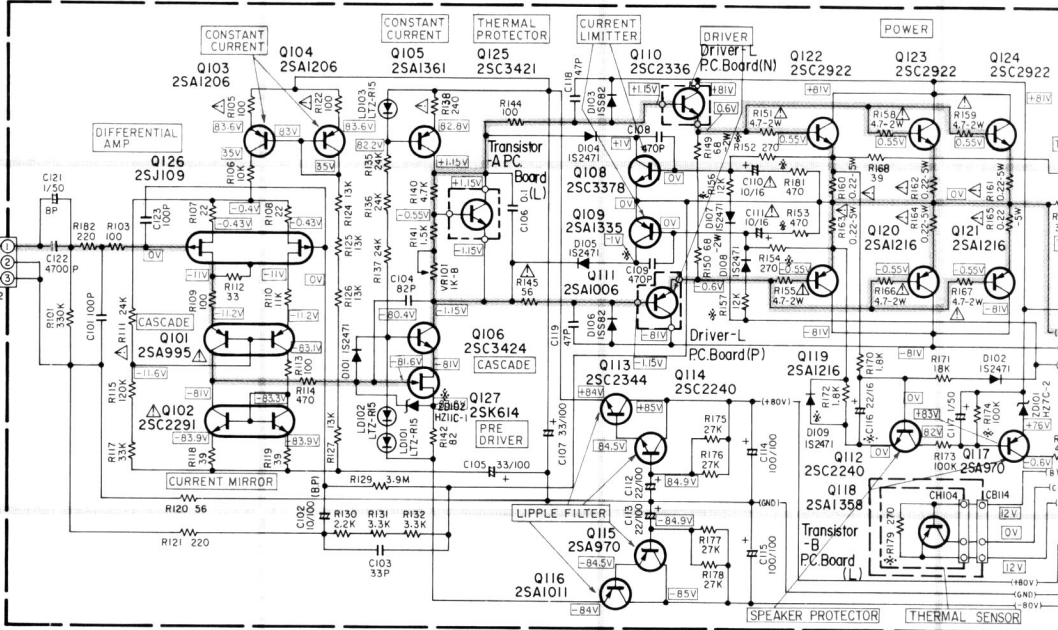

Main-Amp P.C.Board (R)

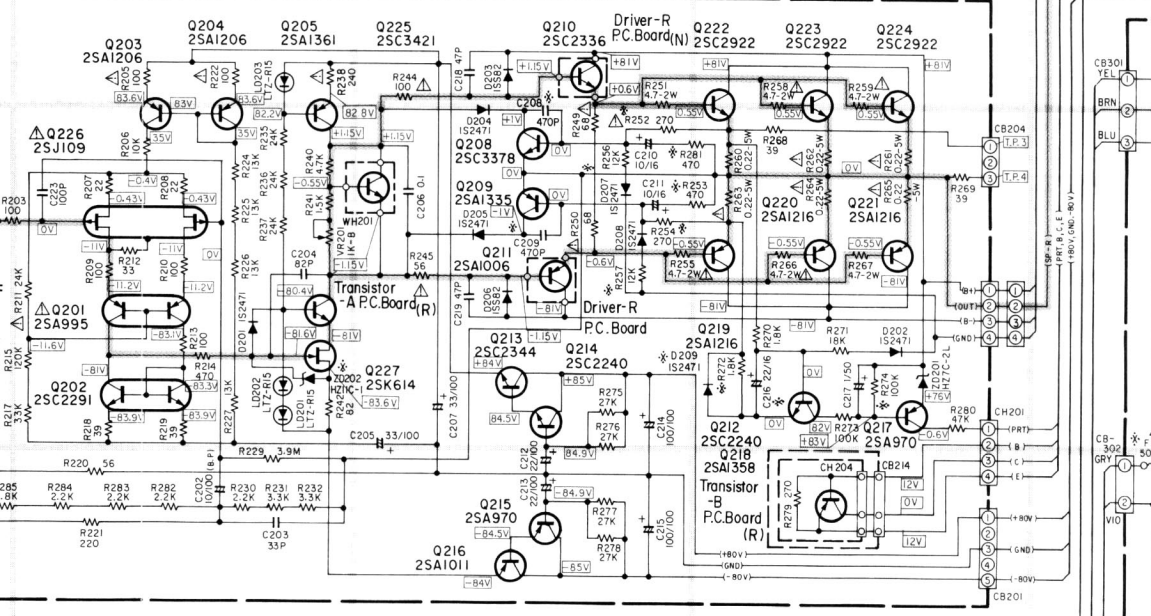

Display Switch P.C.Board

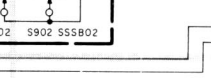

Display P.C.Board



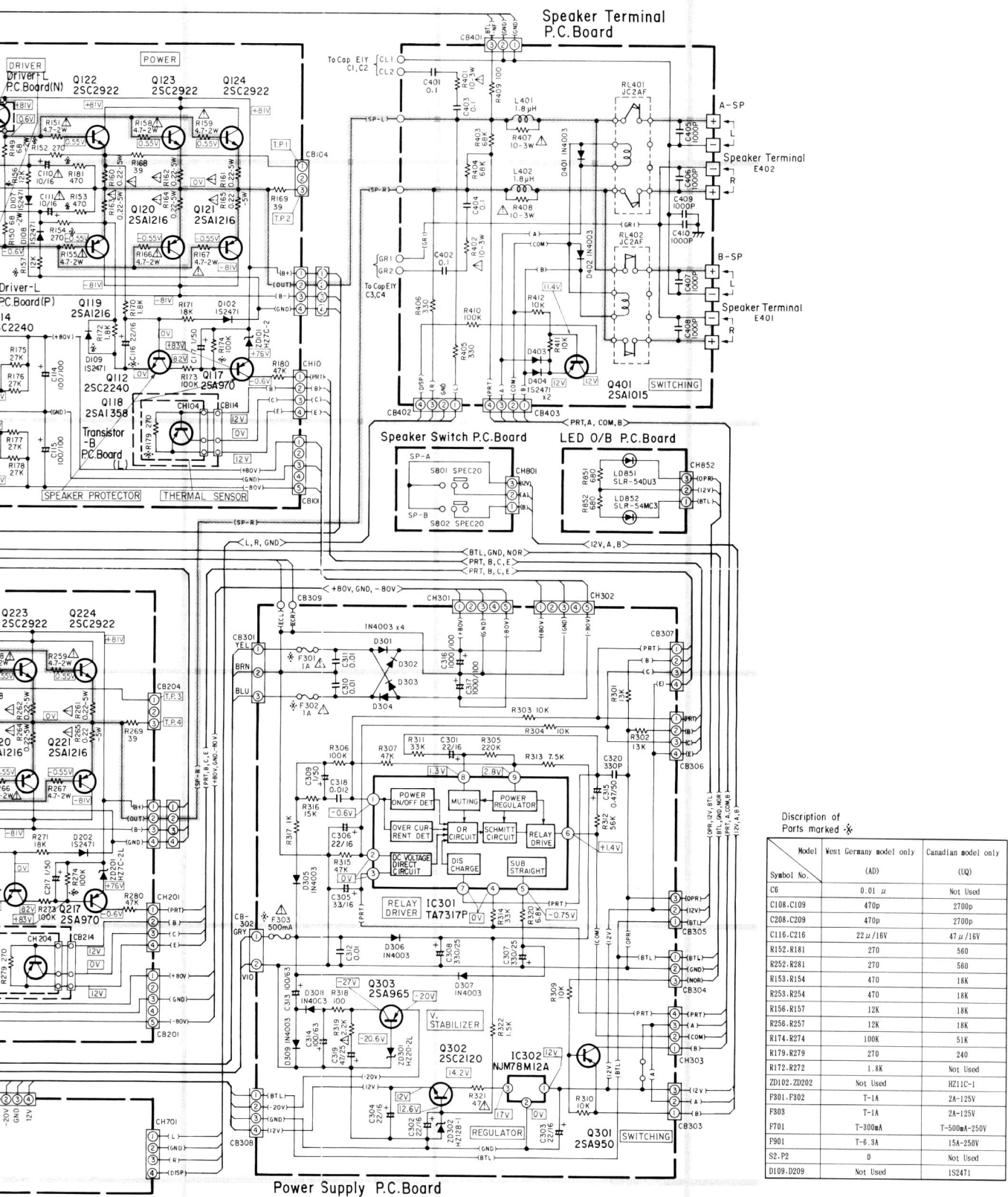

Discription of Parts marked *

Symbol No.	West Germany model only (AD)	Canadian model only (1Q)
C6	0.01 μ	Not Used
C108, C109	470p	2700p
C208, C209	470p	2700p
C116, C216	22 μ /16V	47 μ /16V
R152, R181	270	560
R252, R281	270	560
R153, R154	470	18K
R253, R254	470	18K
R156, R157	12K	18K
R256, R257	12K	18K
R174, R274	100K	51K
R179, R279	270	240
R172, R272	1.8K	Not Used
ZD102, ZD202	Not Used	HZ11C-1
F301, F302	T-1A	2A-125V
F303	T-1A	2A-125V
F701	T-300A	T-500mA-250V
F901	T-6.3A	15A-250V
S2, P2	0	Not Used
D109, D209	Not Used	1S2471

Schematic Diagram (2/2)

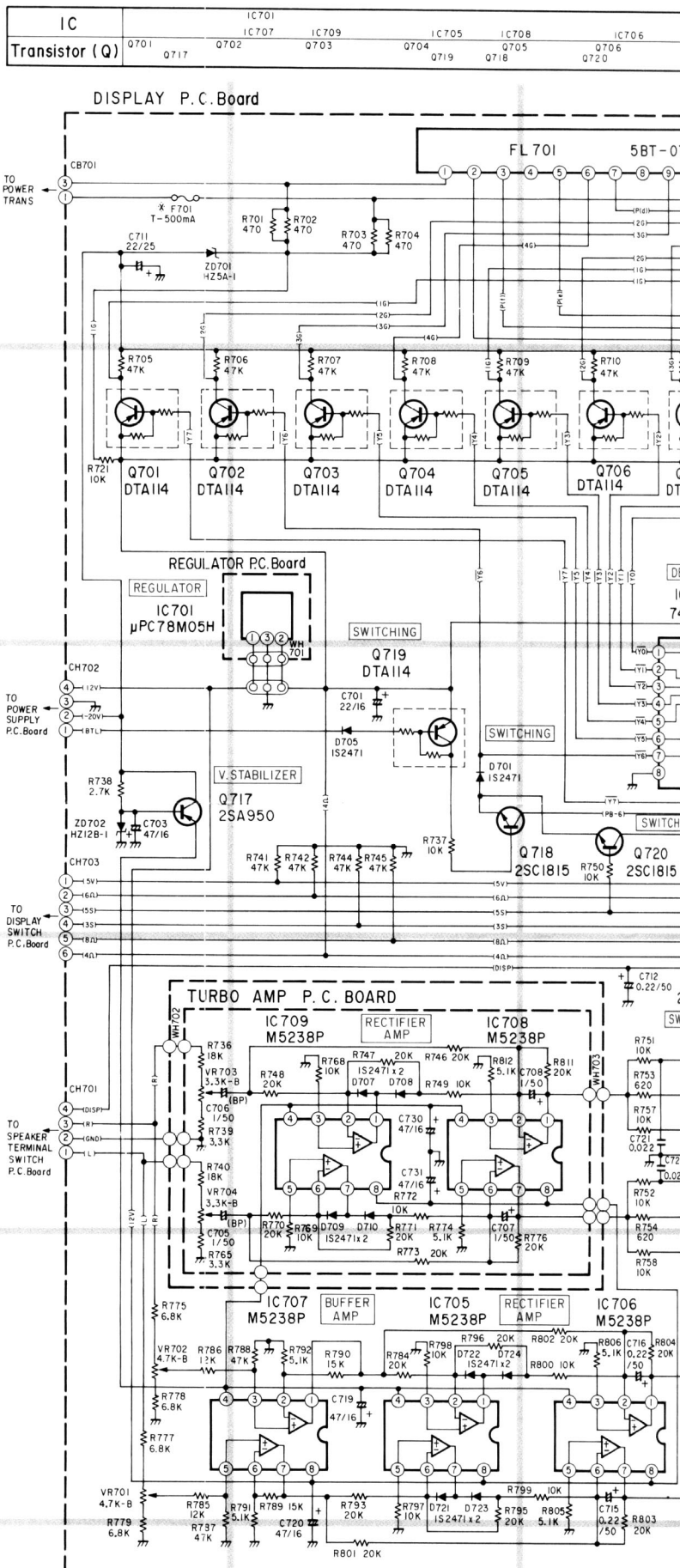

M-03

0713 0714 0715 0716

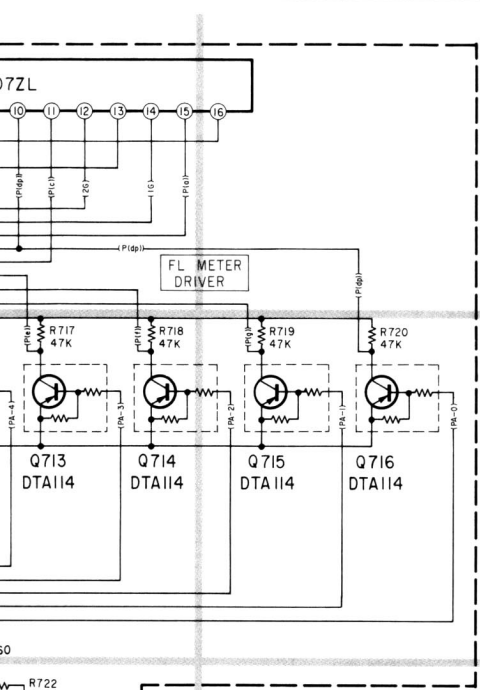

	F	C	R
Q701	(-5V)	(-22V)	(5V)
Q702	(-5V)	(-22V)	(5V)
Q703	(-5V)	(-22V)	(5V)
Q704	(-5V)	(-22V)	(5V)
Q705	(-5V)	(-22V)	(5V)
Q706	(-5V)	(-22V)	(5V)
Q707	(-5V)	(-22V)	(5V)
Q708	(-5V)	(-22V)	(5V)
Q709	(-5V)	(-22V)	(5V)
Q710	(-5V)	(-22V)	(5V)
Q711	(-5V)	(-22V)	(5V)
Q712	(-5V)	(-22V)	(5V)
Q713	(-5V)	(-22V)	(5V)
Q714	(-5V)	(-22V)	(5V)
Q715	(-5V)	(-22V)	(5V)
Q716	(-5V)	(-22V)	(5V)
Q717	-12V	(-22V)	-12.6V
Q718	0	(5V)	0
Q719	5V	0V	5V
Q720	0	(5V)	0
Q721	4.4V	4.4V	5V
Q722	0	5V(0)	0(5V)

1	2	3	4
5V	0	12V	-

1	(5V)
2	(5V)
3	(5V)
4	(5V)
5	(5V)
6	(5V)
7	5V
8	GND
9	(5V)
10	
11	
12	(5V)
13	(5V)
14	(5V)
15	(5V)
16	5V

IC705	0V	0V	0V	-12V	0V	0V	0V	12V
IC706	0V	0V	0V	-12V	0V	0V	0V	12V
IC707	0V	0V	0V	-12V	0V	0V	0V	12V
IC708	0V	0V	0V	-12V	0V	0V	0V	12V
IC709	0V	0V	0V	-12V	0V	0V	0V	12V

Non signal

1	(5V)	33	GND
2	(5V)	34	
3	(5V)	35	
4	(5V)	36	
5	(5V)	37	
6	(5V)	38	
7	(5V)	39	
8	(5V)	40	
9	(5V)	41	
10	(5V)	42	4.6V
11	(5V)	43	5V
12	(5V)	44	
13	(5V)	45	
14	(5V)	46	
15	(5V)	47	
16	5V	48	
17	0V/5V	49	
18	0V/5V	50	
19	0V/5V	51	0V
20	0V/5V	52	0V
21	0V/5V	53	0V
22	0V	54	5V
23	5V	55	
24	5V	56	
25	0V	57	
26	0V	58	
27	5V	59	
28	4.8V	60	
29	0V	61	
30	1/2V	62	5V
31	1/2V	63	5V
32	0V	64	5V

1	2	3
GND	4.8V	5V

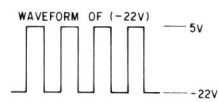
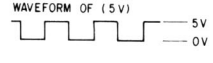

- Measuring Condition
1. Power Supply Voltage
240/220/120V
 2. Measuring Meter
Multi Meter
 3. Measuring Point Reference
Between GND
 4. Measuring Condition
No signal input

At 34 to 41 change 0 to 5V depend on signal.
NOTE: Voltages of (17)~(21) are specified according to setting SW position
Voltages of (23)~(24) are measured with LED ON
They are 0V with LED OFF

CAUTION:

The Δ mark, the symbol No. in a box in the schematic diagram and the shaded area in the parts list designate components which have special characteristics important for safety and should be replaced only with types identical to those in the original circuit or specified in the parts list.

NOTES:

1. All resistance values are in ohms, K = 1,000
2. All capacitance values are in microfarads. P = $\frac{1}{1,000,000}$