

SERVICE MANUAL

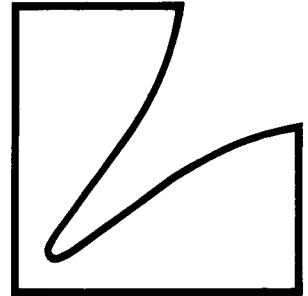

Stereo Power Amplifier

M-03

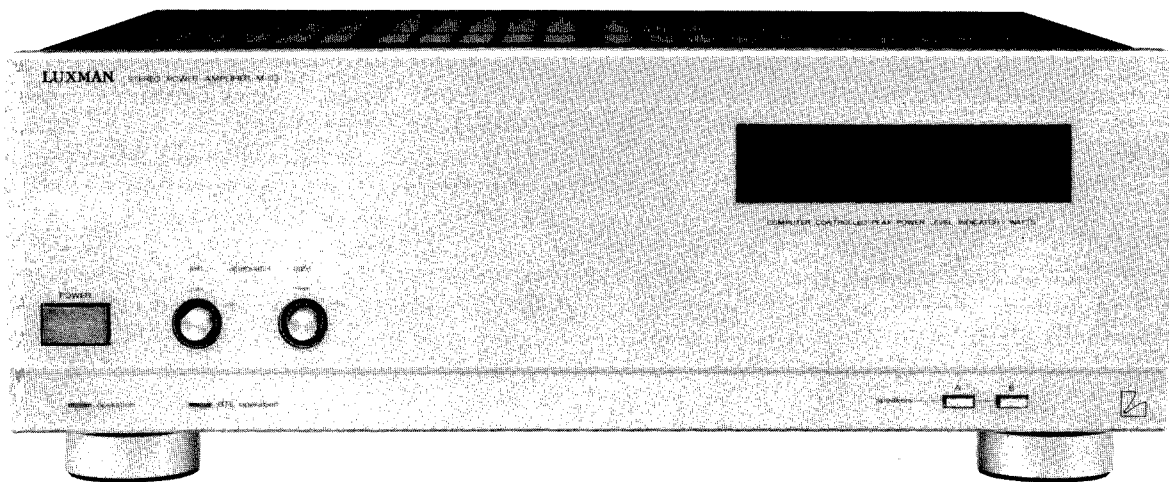

Contents

Specifications	2
Parts Locations and Disassembly Instructions	3 to 4
Adjustment Procedures	5
Adjustment Locations	6 to 8
Block Diagram	8
Parts Layout on P. C. Boards and Wiring Diagram (1/2) (For UQ model only)	9 to 12
Parts Layout on P. C. Boards and Wiring Diagram (2/2) (For AD model only)	13 to 16
Schematic Diagram (1/2)	17 to 18
Schematic Diagram (2/2)	19 to 20
Electrical Parts List	21 to 26
Packing Assembly Parts List	27
Packing Method View	27
Cabinet Assembly Parts List	28
Exploded View (Cabinet)	29 to 30
Semi-Conductor Lead Identifications	31 to 35

Specifications

Power Output	200W (8 ohm, 0.03% T.H.D. at 20Hz~20kHz)
Max Power Output	250W (at 1% T.H.D. 4 ohm, 1kHz)
Input Sensitivity (1kHz)	1V ± 20%
Input Impedance (1kHz)	45K ohm ± 20%
Frequency Response	20Hz~20kHz ± 0.3 dB 5Hz~100kHz - 0.5 dB ± 0.2 dB
S/N Ratio (Input Terminal Shorted)	110dB
T.H.D. (at 200W Output, 8 ohm 20Hz~20kHz)	0.03%
Residual Noise	120 μ V
Cross Talk	1kHz 70dB 10kHz 55dB
Power Supply	AC240/220/120V, 50/60Hz (AD Model Only) AC120V, 60Hz (UQ Model Only)
Power Consumption	120V, 10A (UQ Model Only)
Semiconductors	11 IC's, 74 Transistors, 4FETs, 47 Diodes, 6 Zener Diodes (UQ Model Only) 11 IC's, 74 Transistors, 4FETs, 49 Diodes, 8 Zener Diodes (AD Model Only)
Dimensions	438 (W) × 166 (H) × 420 (D) mm
Weight	23.6kg

BTL SECTION

T.H.D. (at 450W, 8 ohm, 20Hz~20kHz)	0.1%
Max Power Output	450W (at 1% T.H.D. 8 ohm, 1kHz)
Input Sensitivity (1kHz)	0.75V ± 20%
S/N Ratio (Input Terminal Shorted)	96.5dB

NOTE : Due to continuing product improvement, specifications and design are subject to change without notice.

Parts Locations and Disassembly Instructions

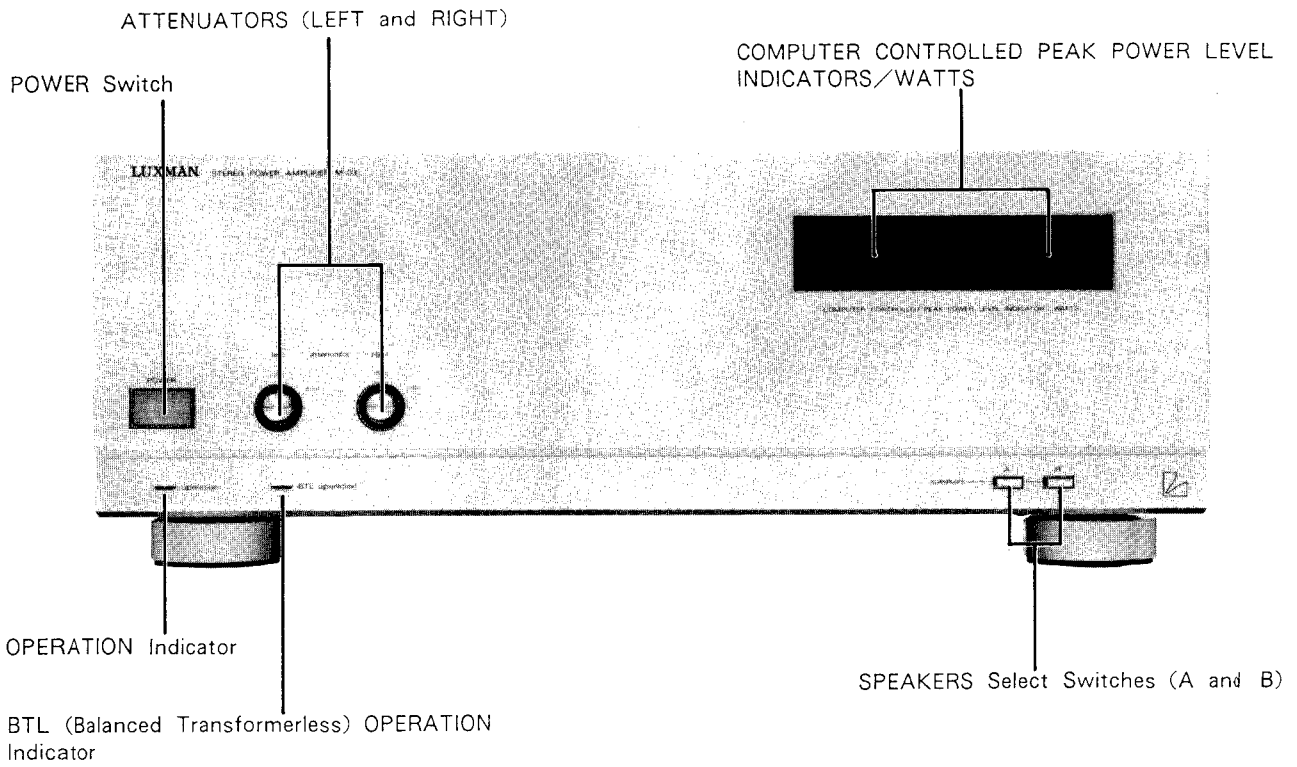

Figure 1

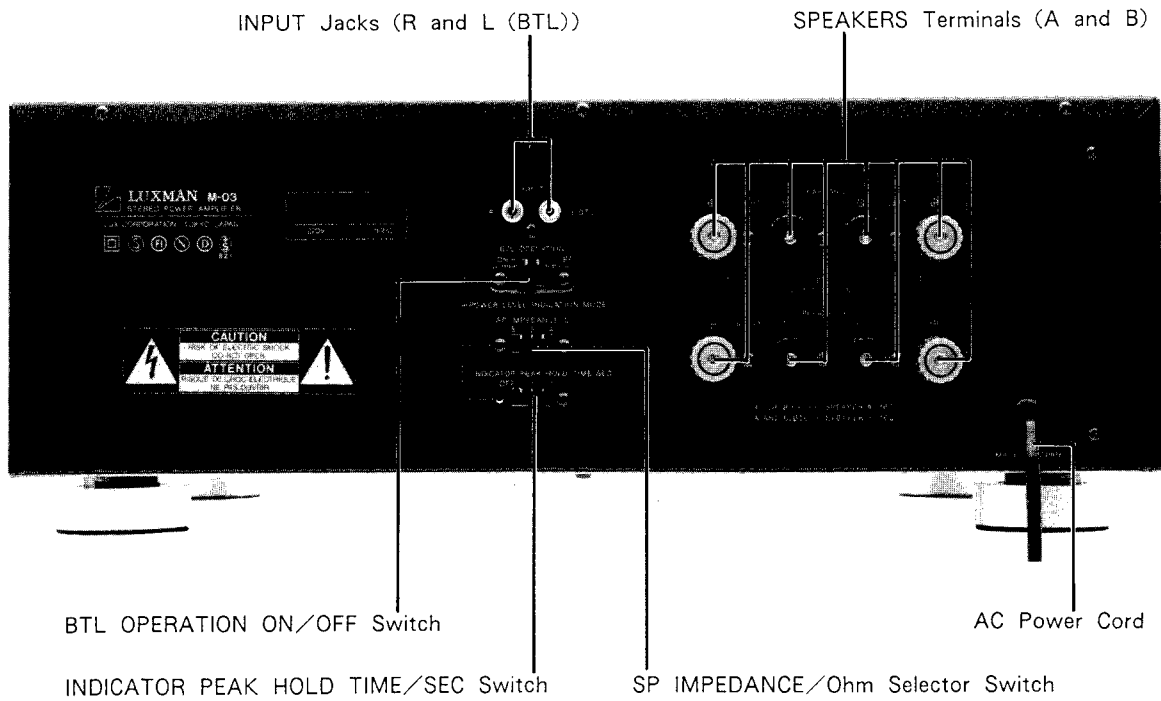

Figure 2

1. Removal of Heatsink (R)

- (1) After removal of Bottom cover, remove four screws marked "O" as shown in Figure 3.
- (2) Disconnect all wires from the Main-Amp P. C. Board (R).
- (3) Heatsink (R) with Main-Amp P. C. Board (R) can be removed completely.

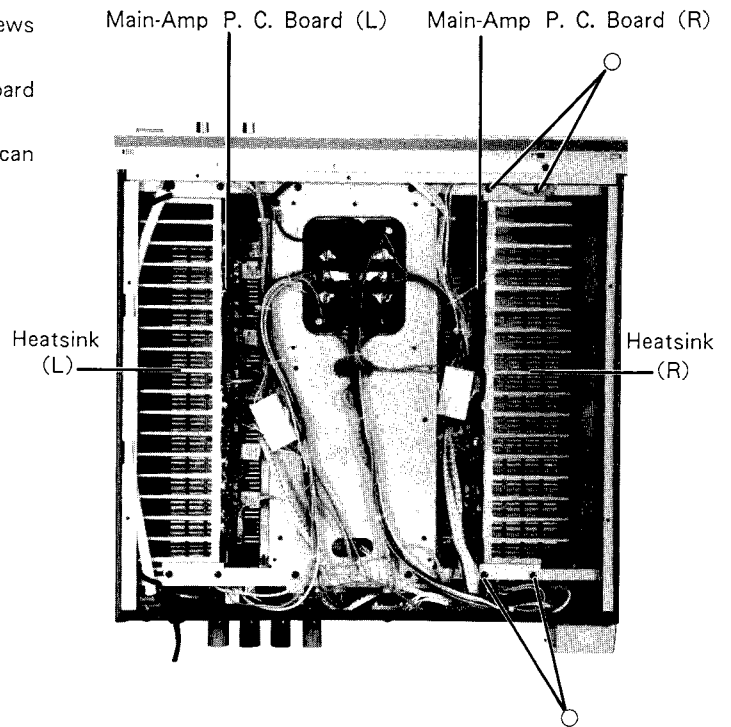

Figure 3

2. Removal of Main-Amp P. C. Board (R)

- (1) After removal of Heatsink (R) remove twenty two screws marked "x" as shown in Figure 4.

Note : Take care of handling each transistors when removing the Main P. C. Board.

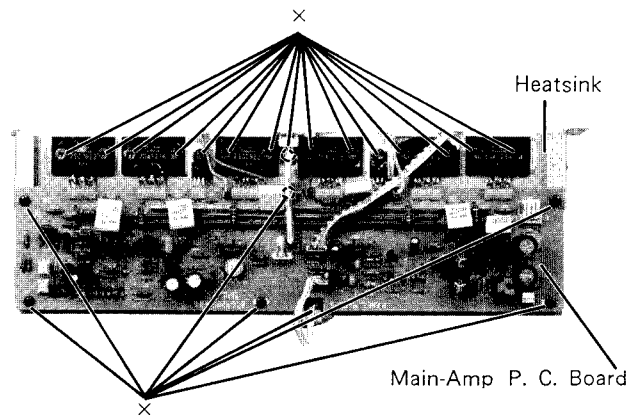

Figure 4

3. Removal of Main-Amp P. C. Board (L)

- (1) Remove in the same way above-mentioned.

Adjustment Procedures

1. Connections

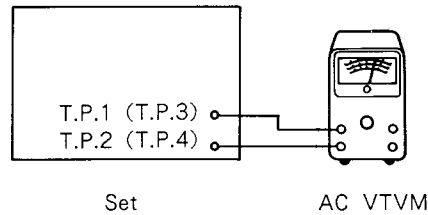

Figure 5

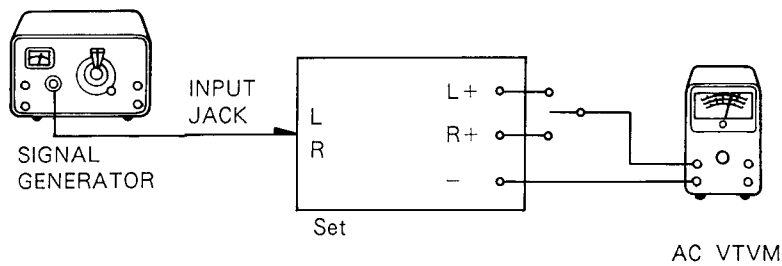

Figure 6

2. Control Settings

Attenuator (Left)	Minimum
	(fully counter clockwise turned)
Attenuator (Right)	Minimum
	(fully counter clockwise turned)
Speaker Selector Switch	Speaker A
Speaker Impedance Selector Switch	8 ohm
Peak Hold Time Selector Switch	3
Power Switch	ON

- ① Set the oscillator output to obtain 2.82V at Left (Right) channel Speaker output. Adjust VR701 (VR702) to obtain 1 ± 0.1 at Left (Right) Power Level Indicator.
- ② Set the oscillator output to obtain 40V at Left (Right) channel Speaker output. Adjust VR703 (VR704) to obtain 200 ± 0.2 at Left (Right) Power Level Indicator.

3. Adjustment Procedures

(1) Idling Adjustment (Fig. 5)

Adjust VR101 (VR201) to obtain 3.5 ± 0.5 mV between T.P.1 (T.P.3) and T.P.2 (T.P.4).

(2) Power Level Indicators Adjustment (Fig. 6)

Note: Apply signal to the set one channel at a time for adjustment.

Attenuator Setting

For Left channel Adjustment

(Left Attenuator) Maximum
(fully clockwise turned)

For Right channel Adjustment

(Right Attenuator) Maximum
(fully clockwise turned)

Adjustment Locations

- UQ model only

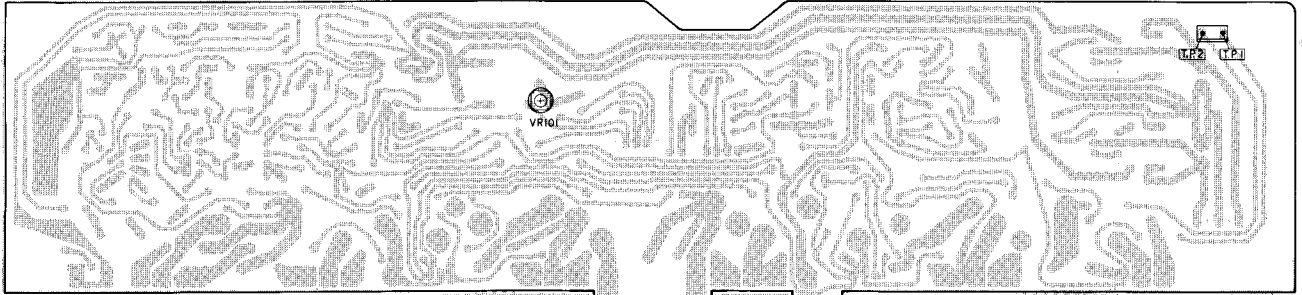

Main-Amp P. C. Board (L)

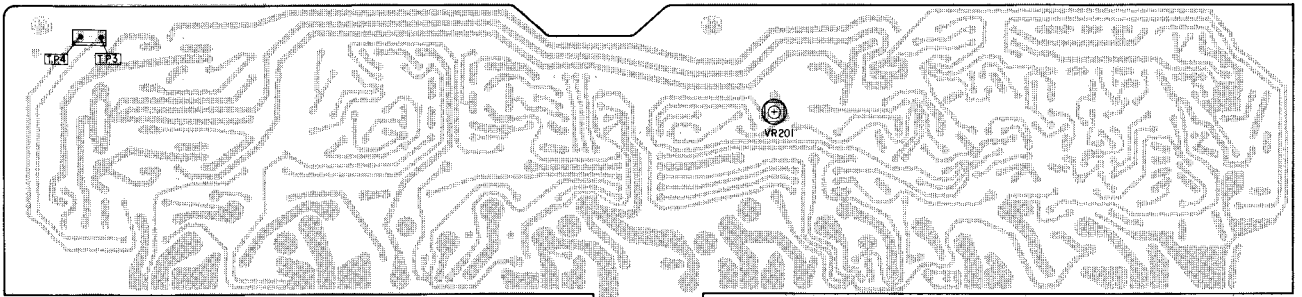

Main-Amp P. C. Board (R)

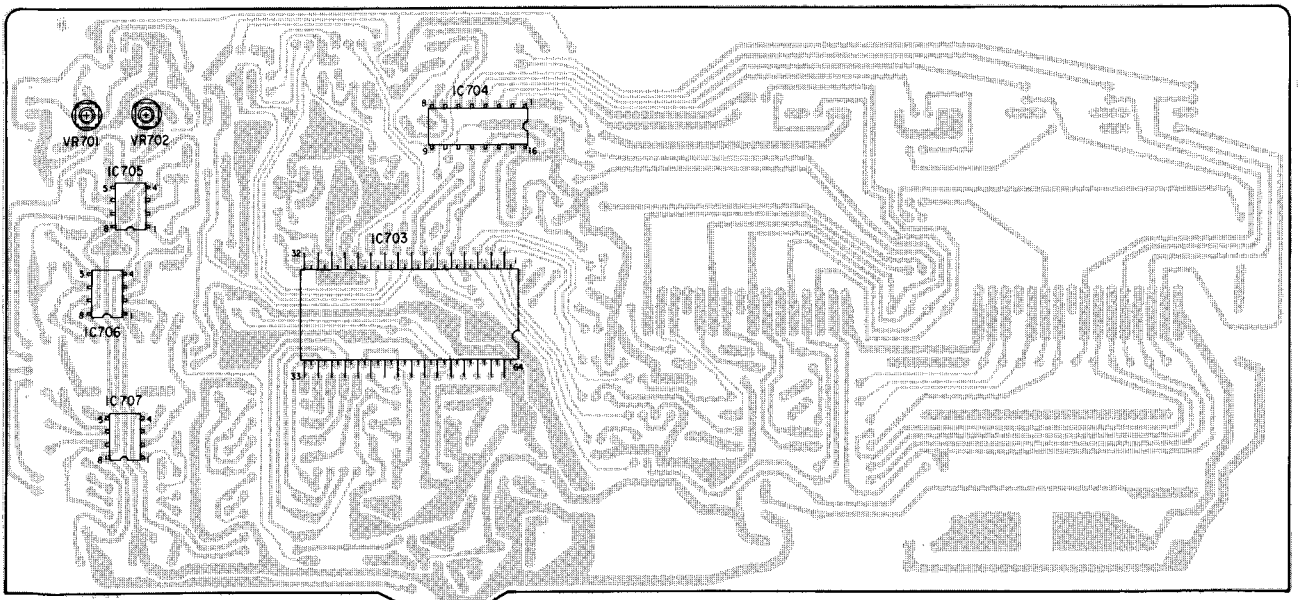

Display P. C. Board

● AD model only

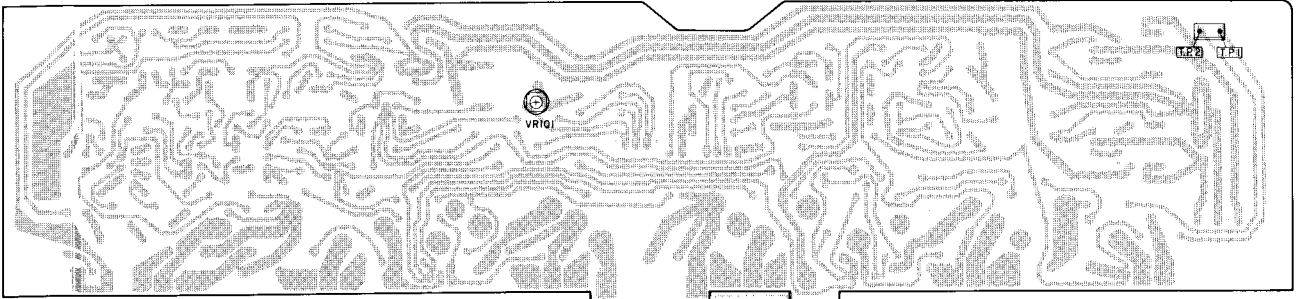

Main-Amp P. C. Board (L)

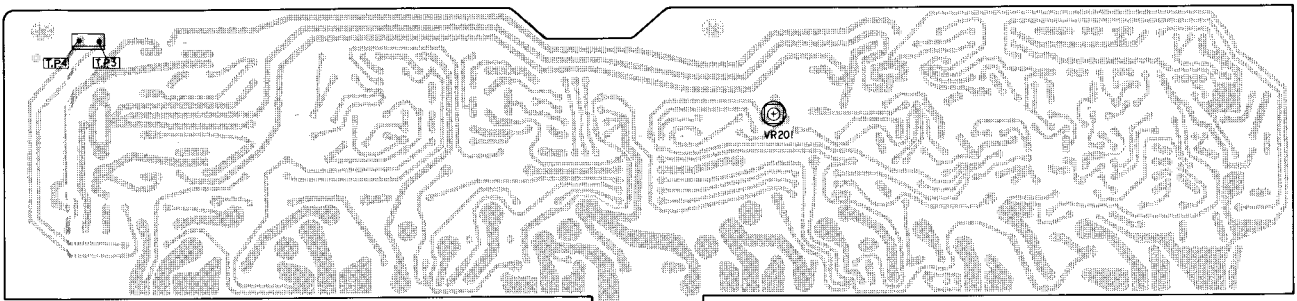

Main-Amp P. C. Board (R)

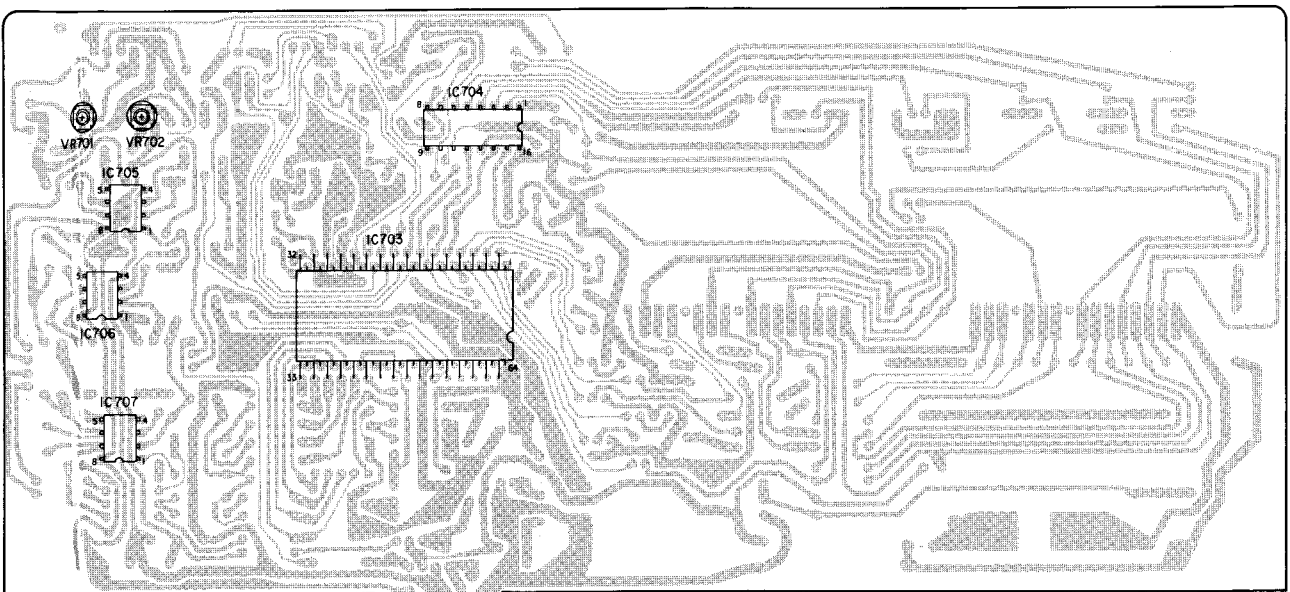

Display P. C. Board

● Common

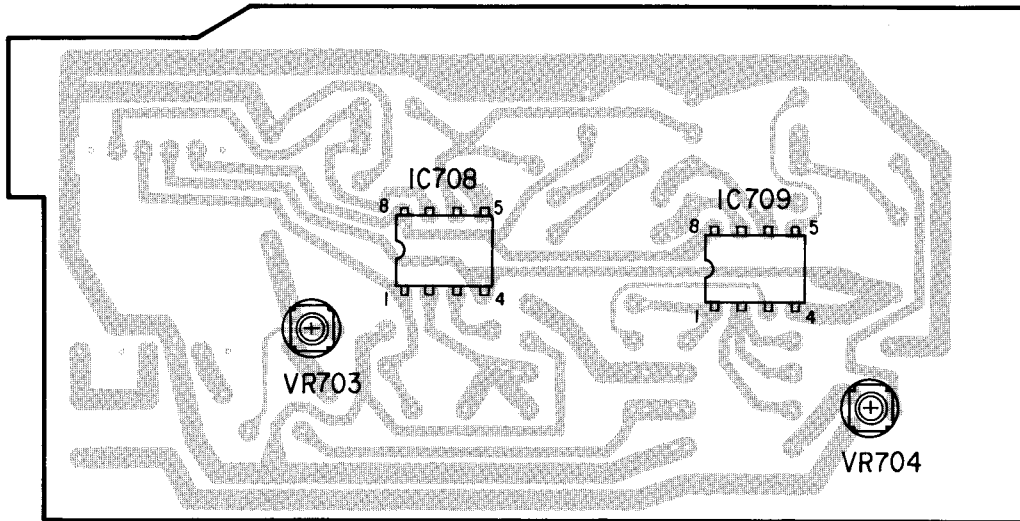

Turbo Amp P. C. Board

Block Diagram

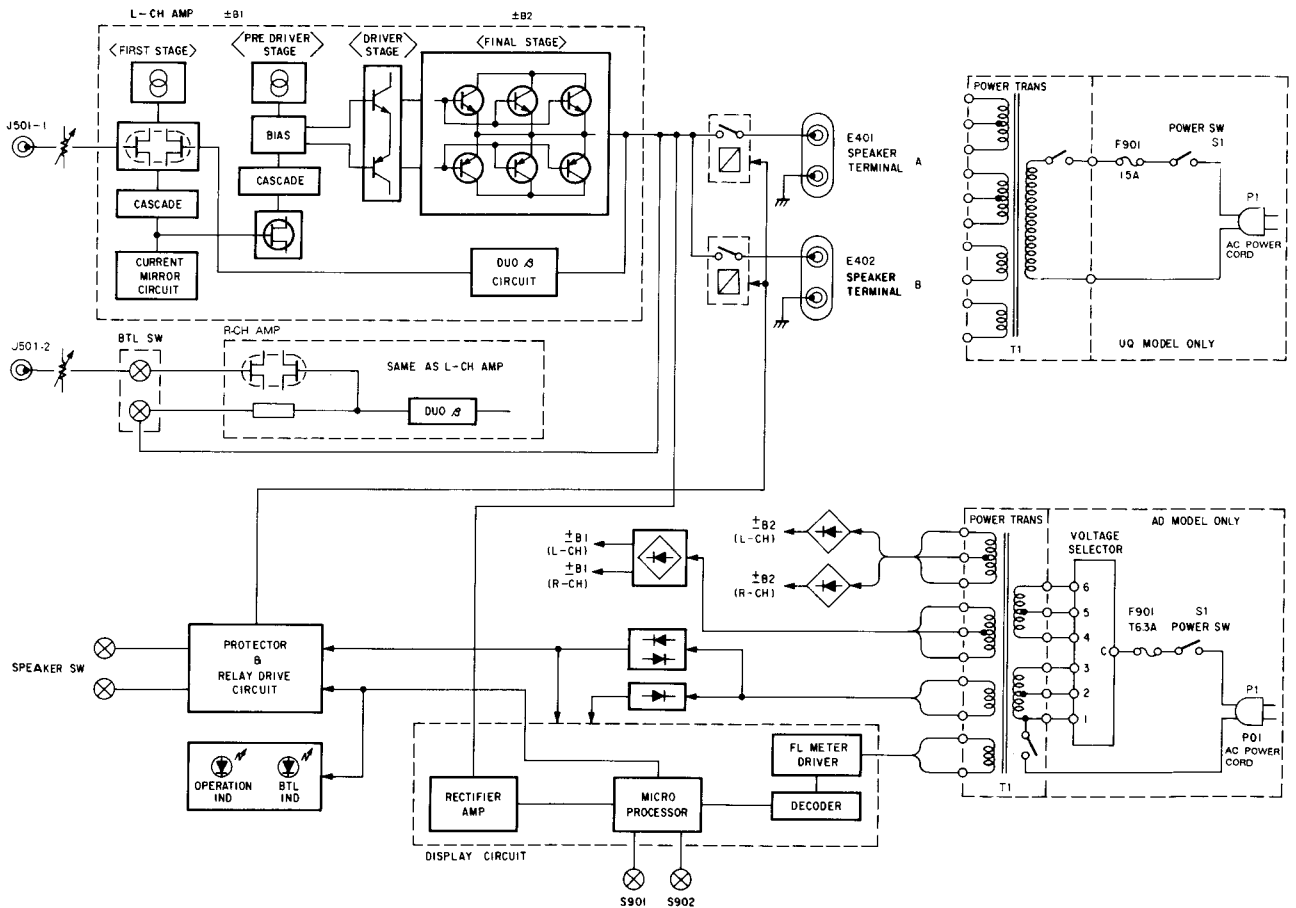

Parts Layout on P.C. Boards and Wiring Diagram (1/2)

● UQ model only

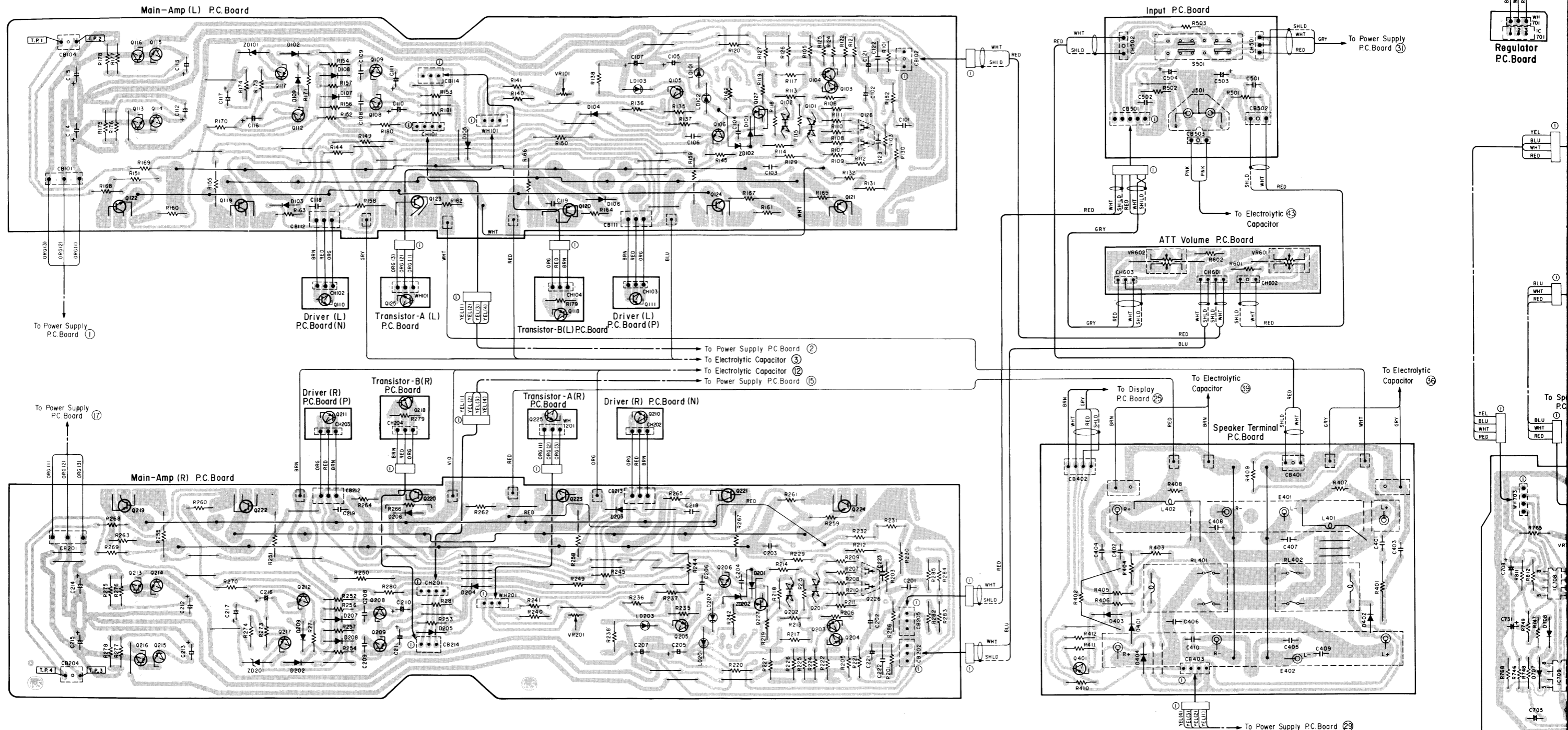

- BLU Blue
- GRN Green
- BLK Black
- GRY Gray
- WHT White
- RED Red
- BRN Brown
- ORG Orange
- YEL Yellow
- PNK Pink
- VIO Violet
- GRN/WHT Green/White
- GRY/WHT Gray/White
- GRY/YEL Gray/Yellow
- GRN/YEL Green/Yellow
- SHLD Shield

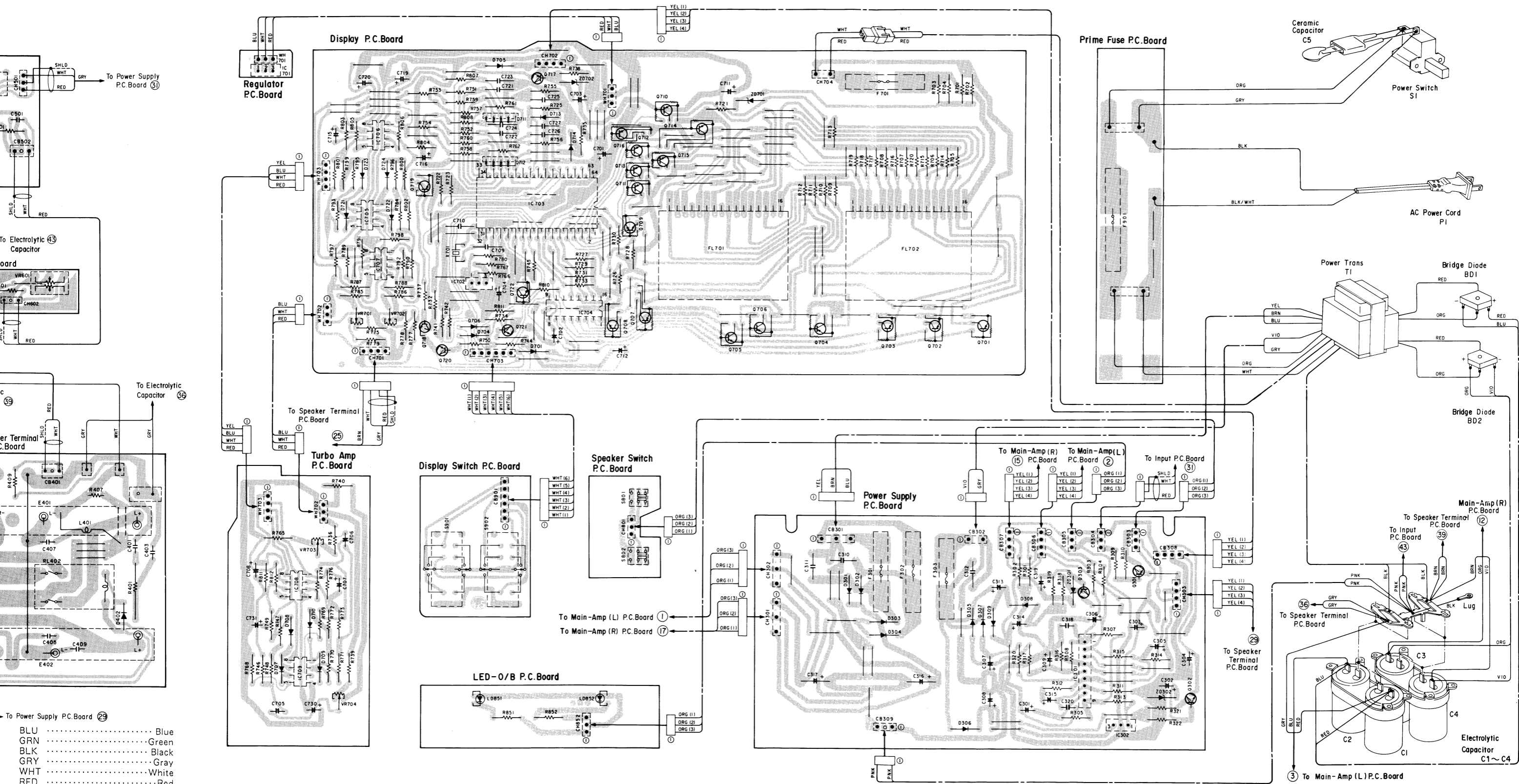

- BLU Blue
- GRN Green
- BLK Black
- GRY Gray
- WHT White
- RED Red
- BRN Brown
- ORG Orange
- YEL Yellow
- PNK Pink
- VIO Violet
- GRN/WHT Green/White
- GRY/WHT Gray/White
- GRY/YEL Gray/Yellow
- GRN/YEL Green/Yellow
- SHLD Shield

Parts Layout on P.C. Boards and Wiring Diagram (2/2)

● AD model only

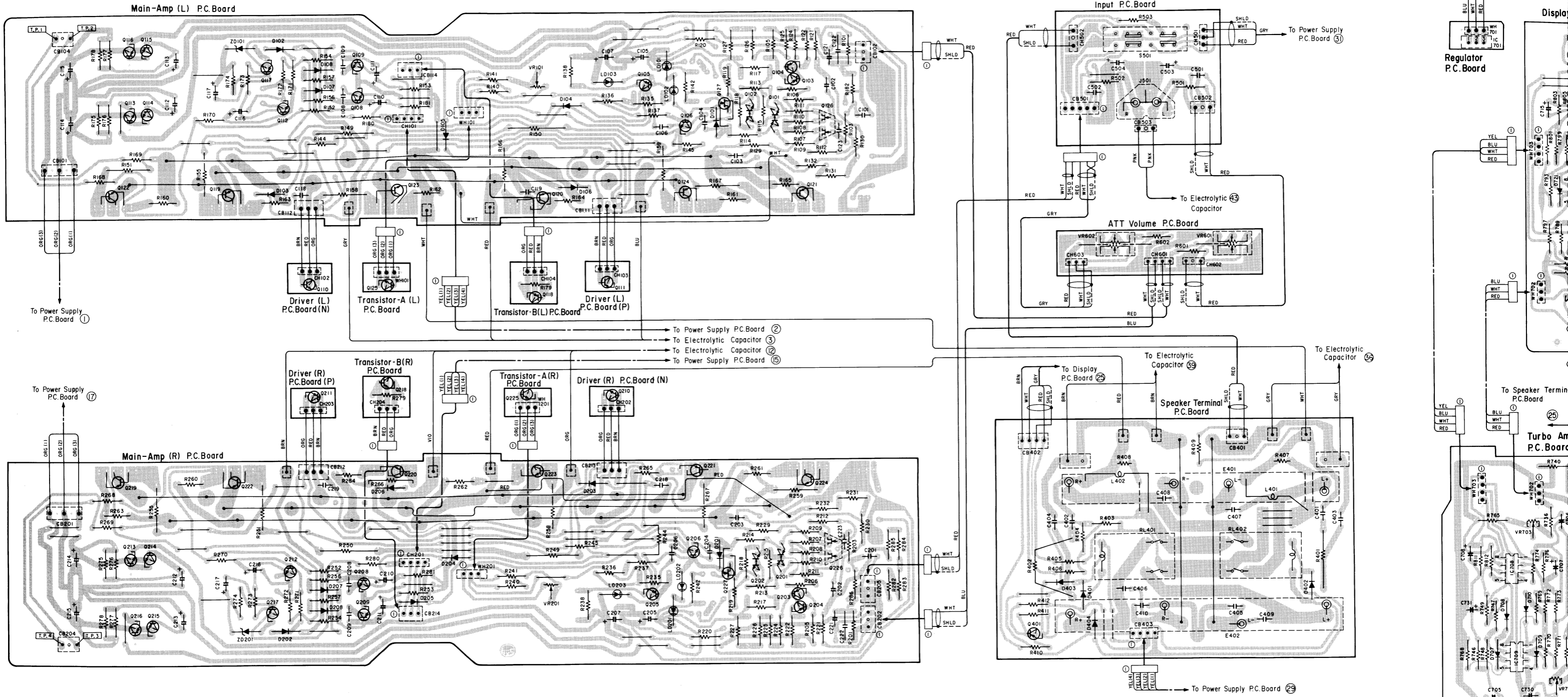

- BLU Blue
- GRN Green
- BLK Black
- GRY Gray
- WHT White
- RED Red
- BRN Brown
- ORG Orange
- YEL Yellow
- PNK Pink
- VIO Violet
- GRN/WHT Green/White
- GRY/WHT Gray/White
- GRY/YEL Gray/Yellow
- GRN/YEL Green/Yellow
- SHLD Shield

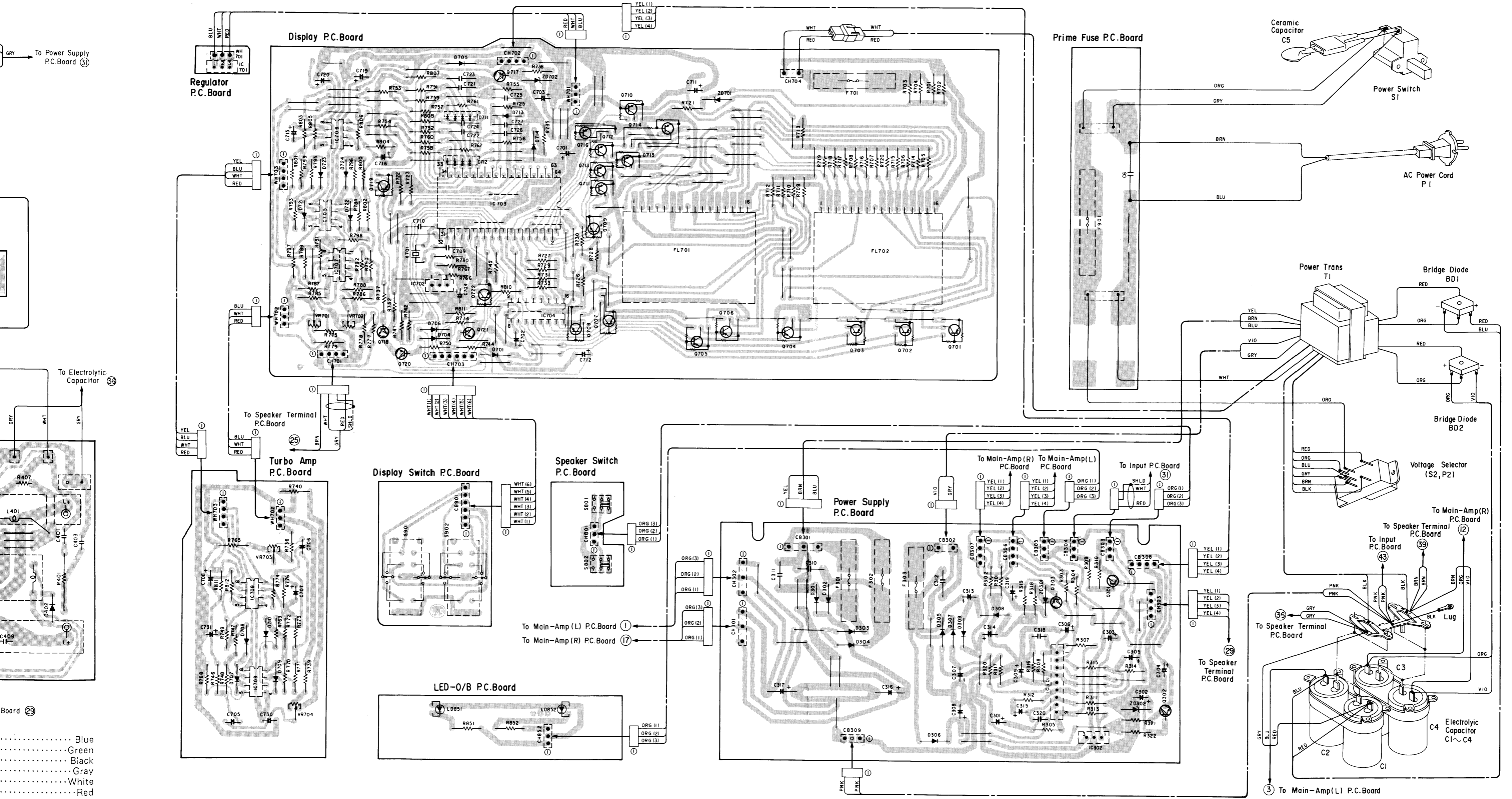

- Blue
- Green
- Black
- Gray
- White
- Red
- Brown
- Orange
- Yellow
- Pink
- Violet
- Green/White
- Gray/White
- Gray/Yellow
- Green/Yellow
- Shield

Diagram (1/2)

box in the schematic diagram and the shaded area in the which have special characteristics important for safety types identical to those in the original circuit or

ms. K = 1,000
microfarads. P = 1,000,000

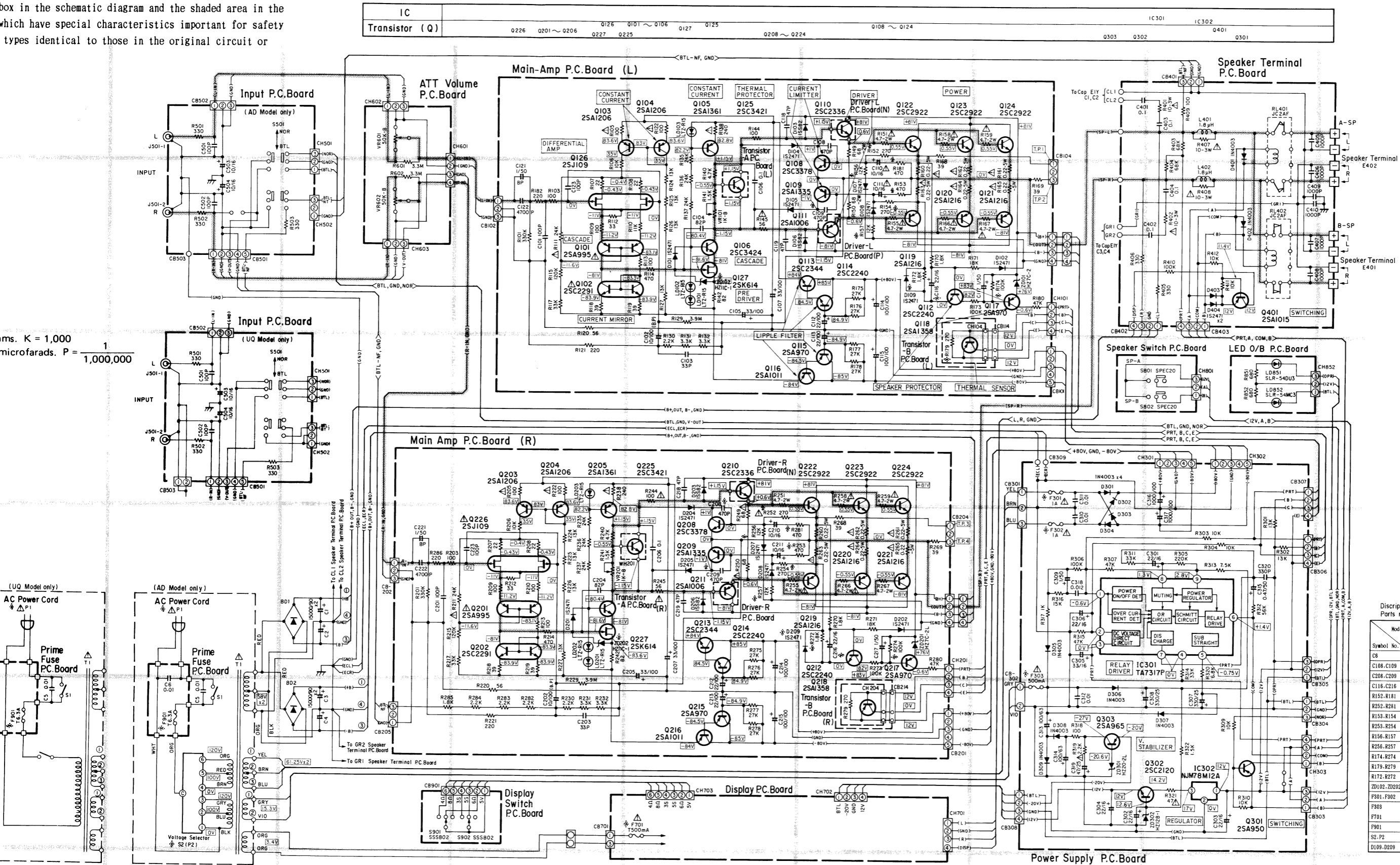

IC												
Transistor (Q)	Q226	Q201 ~ Q206	Q126	Q101 ~ Q106	Q127	Q125	Q208 ~ Q224	Q108 ~ Q124	IC301	IC302	Q401	Q301

Discription of Parts marked *

Symbol No.	Model	West Germany model only (AD)	Canadian model only (UQ)
C8		0.01 μ	Not Used
C108, C109		470p	2700p
C208, C209		470p	2700p
C116, C216		22 μ / 16V	47 μ / 16V
R152, R181		270	560
R252, R281		270	560
R153, R154		470	18K
R253, R254		470	18K
R156, R157		12K	18K
R256, R257		12K	18K
R174, R274		100K	51K
R179, R279		270	240
R172, R272		1.8K	Not Used
ZD102, ZD202		Not Used	RZ11C-1
F901, F902		T-1A	2A-125V
F903		T-1A	2A-125V
F701		T-300mA	T-500mA-250V
F901		T-6, 3A	15A-250V
S2, P2		0	Not Used
D109, D209		Not Used	1S24T1

M-03

Schematic Diagram (2/2)

IC	IC701		IC709		IC705		IC708		IC706		IC704		IC702		IC703							
Transistor (Q)	Q701	Q717	Q702	Q703	Q704	Q719	Q705	Q718	Q706	Q720	Q707	Q721	Q708	Q722	Q709	Q710	Q711	Q712	Q713	Q714	Q715	Q716

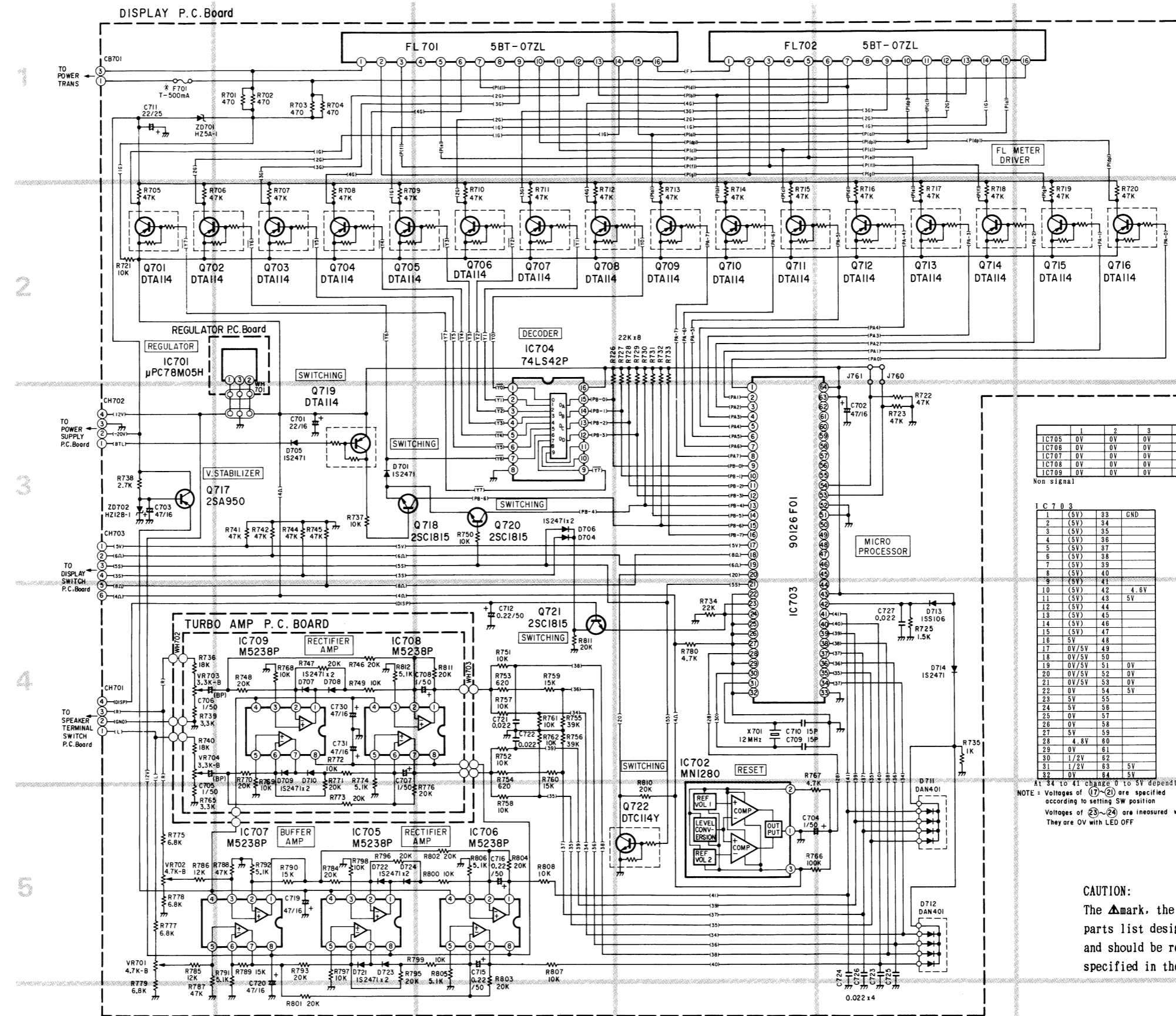

	E	C	B
Q701	(-5V)	(-22V)	(5V)
Q702	(-5V)	(-22V)	(5V)
Q703	(-5V)	(-22V)	(5V)
Q704	(-5V)	(-22V)	(5V)
Q705	(-5V)	(-22V)	(5V)
Q706	(-5V)	(-22V)	(5V)
Q707	(-5V)	(-22V)	(5V)
Q708	(-5V)	(-22V)	(5V)
Q709	(-5V)	(-22V)	(5V)
Q710	(-5V)	(-22V)	(5V)
Q711	(-5V)	(-22V)	(5V)
Q712	(-5V)	(-22V)	(5V)
Q713	(-5V)	(-22V)	(5V)
Q714	(-5V)	(-22V)	(5V)
Q715	(-5V)	(-22V)	(5V)
Q716	(-5V)	(-22V)	(5V)
Q717	(-12V)	(-22V)	(-12.0V)
Q718	0	(5V)	0
Q719	5V	0V	5V
Q720	0	(5V)	0
Q721	4.4V	4.4V	5V
Q722	0	5V(0)	0(5V)

IC701	1	2	3	4
5V	0	12V	-	-

IC704	1	2	3	4	5	6	7	8	9	10	11	12	13	14	15	16
2	3	4	5	6	7	8	9	10	11	12	13	14	15	16	17	18

IC705	1	2	3	4	5	6	7	8
IC705	0V	0V	0V	-12V	0V	0V	0V	12V
IC708	0V	0V	0V	-12V	0V	0V	0V	12V
IC707	0V	0V	0V	-12V	0V	0V	0V	12V
IC708	0V	0V	0V	-12V	0V	0V	0V	12V
IC709	0V	0V	0V	-12V	0V	0V	0V	12V

IC703	1	2	3	4	5	6	7	8
1	2	3	4	5	6	7	8	9

IC702	1	2	3
GND	4.8V	5V	-

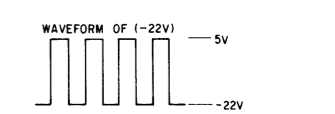
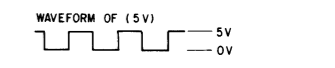

IC703	1	2	3	4	5	6	7	8
1	(5V)	34	GND					
2	(5V)	34						
3	(5V)	35						
4	(5V)	36						
5	(5V)	37						
6	(5V)	38						
7	(5V)	39						
8	(5V)	40						
9	(5V)	41						
10	(5V)	42	4.8V					
11	(5V)	43	5V					
12	(5V)	44						
13	(5V)	45						
14	(5V)	46						
15	(5V)	47						
16	5V	48						
17	0V/5V	49						
18	0V/5V	50						
19	0V/5V	51	0V					
20	0V/5V	52	0V					
21	0V/5V	53	0V					
22	0V	54	5V					
23	5V	55						
24	5V	56						
25	0V	57						
26	0V	58						
27	5V	59						
28	4.8V	60						
29	0V	61						
30	1/2V	62						
31	1/2V	63	5V					
32	0V	64	5V					

- Measuring Condition
- Power Supply Voltage 240/220/120V
 - Measuring Meter Multi Meter
 - Measuring Point Reference Between GND
 - Measuring Condition No signal input

At 34 to 41 change 0 to 5V depending on signal.
 NOTE: Voltages of (17)-(21) are specified according to setting SW position
 Voltages of (23)-(24) are measured with LED ON
 They are 0V with LED OFF

CAUTION:
 The Δ mark, the symbol No. in a box in the schematic diagram parts list designate components which have special characteristics and should be replaced only with types identical to those specified in the parts list.

- NOTES:**
- All resistance values are in ohms, K = 1000
 - All capacitance values are in microfarads

M-03

IC	IC701		IC709		IC705		IC708		IC706		IC704		IC702		IC703					
Transistor (Q)	Q701	Q717	Q702	Q703	Q704	Q719	Q718	Q705	Q706	Q707	Q721	Q708	Q709	Q710	Q711	Q712	Q713	Q714	Q715	Q716

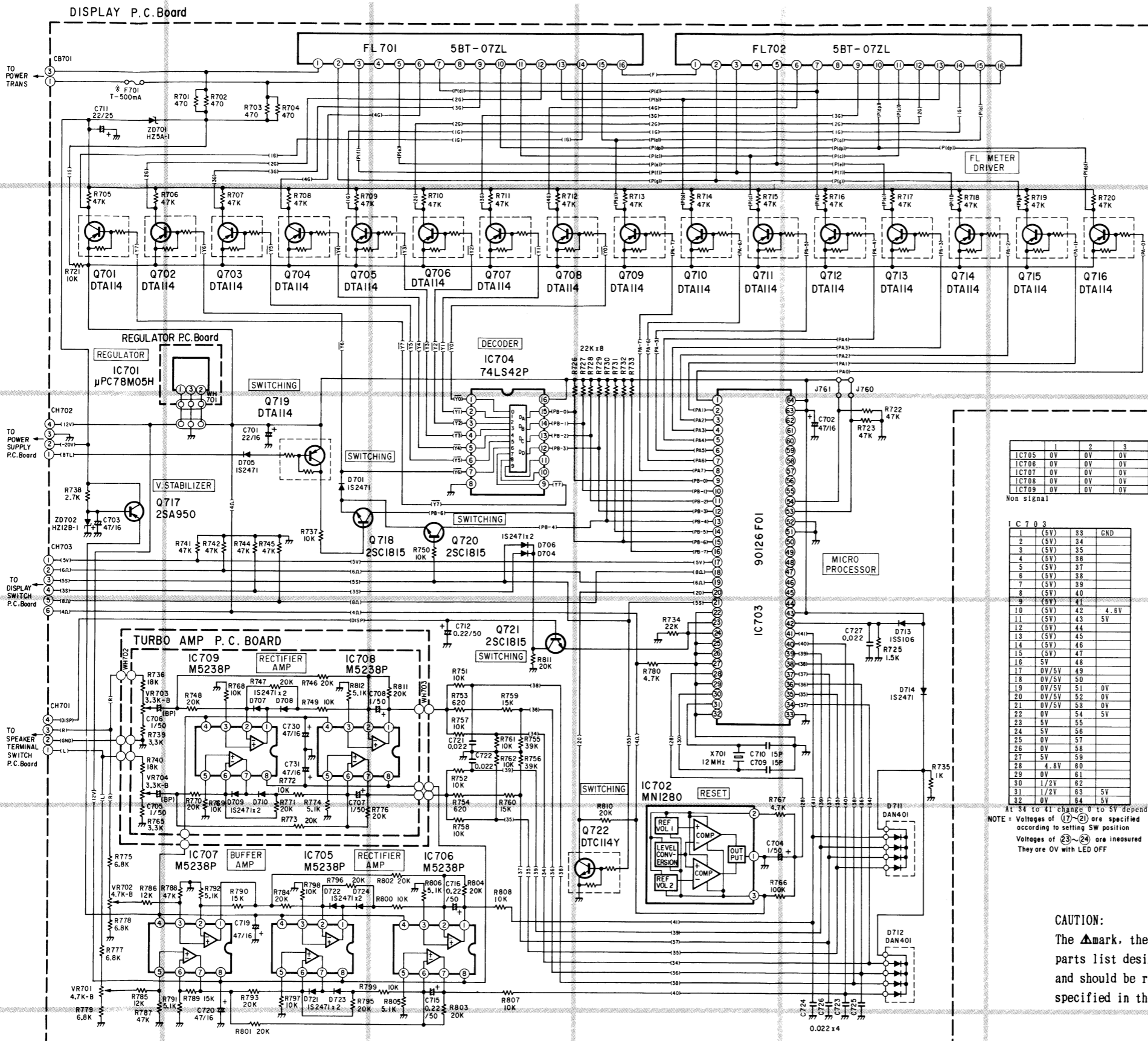

Q	F	C	B
Q701	(-5V)	(-22V)	(5V)
Q702	(-5V)	(-22V)	(5V)
Q703	(-5V)	(-22V)	(5V)
Q704	(-5V)	(-22V)	(5V)
Q705	(-5V)	(-22V)	(5V)
Q706	(-5V)	(-22V)	(5V)
Q707	(-5V)	(-22V)	(5V)
Q708	(-5V)	(-22V)	(5V)
Q709	(-5V)	(-22V)	(5V)
Q710	(-5V)	(-22V)	(5V)
Q711	(-5V)	(-22V)	(5V)
Q712	(-5V)	(-22V)	(5V)
Q713	(-5V)	(-22V)	(5V)
Q714	(-5V)	(-22V)	(5V)
Q715	(-5V)	(-22V)	(5V)
Q716	(-5V)	(-22V)	(5V)
Q717	-12V	(-22V)	-12.6V
Q718	0	(5V)	0
Q719	5V	0V	5V
Q720	0	(5V)	0
Q721	4.4V	4.4V	5V
Q722	0	5V(0)	0(5V)

IC 701			
1	2	3	4
5V	0	12V	-

IC 704	
1	2
1 (5V)	
2 (5V)	
3 (5V)	
4 (5V)	
5 (5V)	
6 (5V)	
7 5V	
8 GND	
9 (5V)	
10 (5V)	
11 (5V)	
12 (5V)	
13 (5V)	
14 (5V)	
15 (5V)	
16 5V	

IC705	1	2	3	4	5	6	7	8
IC705	0V	0V	0V	-12V	0V	0V	0V	12V
IC706	0V	0V	0V	-12V	0V	0V	0V	12V
IC707	0V	0V	0V	-12V	0V	0V	0V	12V
IC708	0V	0V	0V	-12V	0V	0V	0V	12V
IC709	0V	0V	0V	-12V	0V	0V	0V	12V

Non signal

IC 703		
1	2	3
1 (5V)	38	GND
2 (5V)	34	
3 (5V)	35	
4 (5V)	36	
5 (5V)	37	
6 (5V)	38	
7 (5V)	39	
8 (5V)	40	
9 (5V)	41	
10 (5V)	42	4.6V
11 (5V)	43	5V
12 (5V)	44	
13 (5V)	45	
14 (5V)	46	
15 (5V)	47	
16 5V	48	
17 0V/5V	49	
18 0V/5V	50	
19 0V/5V	51	0V
20 0V/5V	52	0V
21 0V/5V	53	0V
22 0V	54	5V
23 5V	55	
24 5V	56	
25 0V	57	
26 0V	58	
27 5V	59	
28 4.8V	60	
29 0V	61	
30 1/2V	62	
31 1/2V	63	5V
32 0V	64	5V

At 34 to 41 change 0 to 5V depending on signal.
NOTE: Voltages of (17)-(21) are specified according to setting SW position
Voltages of (23)-(24) are measured with LED ON
They are 0V with LED OFF

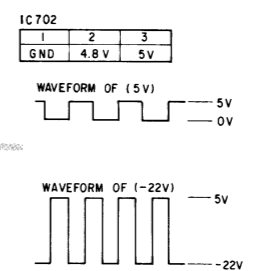

- Measuring Condition
- Power Supply Voltage 240 / 220 / 120V
 - Measuring Meter Multi Meter
 - Measuring Point Reference Between GND
 - Measuring Condition No signal input

CAUTION:
The Δ mark, the symbol No. in a box in the schematic diagram and the shaded area in the parts list designate components which have special characteristics important for safety and should be replaced only with types identical to those in the original circuit or specified in the parts list.

- NOTES:**
- All resistance values are in ohms. K = 1,000
 - All capacitance values are in microfarads. P = $\frac{1}{1,000,000}$

Electrical Parts List

Resistor : Carbon resistors under 1/4 watts are not mentioned in the parts list, please confirm them by schematic diagram.
 uF = microfarads, pF = picofarads

Abbreviations					Symbol No.	Part No.	Description		
RES. = Resistor	CAP. = Capacitor				Capacitors C101 08T81196F34 MICA., 100pF C102 23T81031F05 ELY., (B.P.) 10 μ F/100V C103 08T81196F19 MICA., 33pF C104 08T81196F32 MICA., 82pF C105 23T00136L99 ELY., 33 μ F/100V C106 08S40656F25 MYL., 0.1 μ F C107 23T00138L78 ELY., 33 μ F/100V ● C108 08T52448F05 PP., 470pF ▲ C108 08S40656F06 MYL., 2700pF ● C109 08T52448F05 PP., 470pF ▲ C109 08S40656F06 MYL., 2700pF C110 23T00138L17 ELY., 10 μ F/16V C111 23T00138L17 ELY., 10 μ F/16V C112 23T00138L77 ELY., 22 μ F/100V C113 23T00138L77 ELY., 22 μ F/100V C114 23T00161L06 ELY., 100 μ F/100V C115 23T00161L06 ELY., 100 μ F/100V ● C116 23T00138L18 ELY., 22 μ F/16V ▲ C116 23T00138L20 ELY., 47 μ F/16V C117 23T00138L45 ELY., 1 μ F/50V C118 08T81196F25 MICA., 47pF C119 08T81196F25 MICA., 47pF C121 23T71210F23 ELY., (BP) 1 μ F/50V C122 08T93192F65 PF, 4700pF C123 08T61642F27 MICA., 100pF				
C.F. = Carbon Film	ELY. = Electrolytic								
M.F. = Metal Film	CER. = Ceramic								
M.O. = Metal Oxide Film	MYL. = Mylar								
M.P. = Metal Plate	TAN. = Tantalum								
TR. = Transistor	POLY. = Polystyrol								
TRANS. = Transformer	PP. = Polypropylene								
CP. = Chip	PLT. = Polyethylene								
Symbol No.	Part No.	Description							
Main Amp P. C. Board (L)									
Transistors									
Q101	48T72597F01	2SA995							
Q102	48T72598F01	2SC2291							
Q103	48T72888F01	2SA1208							
Q104	48T72888F01	2SA1208							
Q105	48T71448F01	2SA1361							
Q106	48T71449F01	2SC3424							
Q108	48T80986F01	2SC3378							
Q109	48T81444F01	2SA1335							
Q112	48T53301F01	2SC2240							
Q113	48T64240F02	2SC2344							
Q114	48T53301F01	2SC2240							
Q115	48T52545F01	2SA970							
Q116	48T47145F01	2SA1011							
Q117	48T52545F01	2SA970							
Q126	48T71752F01	FET, 2SJ109							
Q127	48T80991F01	FET, 2SK614							
Diodes/LEDs									
D101	48T68764F01	1S2471							
D102	48T68764F01	1S2471							
D103	48T73079F02	ISS82							
D104	48T68764F01	1S2471							
D105	48T68764F01	1S2471							
D106	48T73079F02	ISS82							
D107	48T68764F01	1S2471							
D108	48T68764F01	1S2471							
▲ D109	48T68764F01	1S2471							
ZD101	48T52741F17	Zener, HZ7C-2L							
▲ ZD102	48T40150U58	Zener, HZ11C-1							
LD101	48T60971F01	LED, LTZ-R15							
LD102	48T60971F01	LED, LTZ-R15							
LD103	48T60971F01	LED, LTZ-R15							
Resistors (All resistors are Metal Film 2W \pm 5% unless otherwise noted.)									
R149	06T73186F37	M.O., 68 ohm 2W							
R150	06T73186F37	M.O., 68 ohm 2W							
R151	06T92261F33	4.7 ohm							
R155	06T92261F33	4.7 ohm							
R158	06T92261F33	4.7 ohm							
R159	06T92261F33	4.7 ohm							
R160	06T63106F02	MPC 0.22 ohm 5W							
R161	06T63106F02	MPC 0.22 ohm 5W							
R162	06T63106F02	MPC 0.22 ohm 5W							
R163	06T63106F02	MPC 0.22 ohm 5W							
R164	06T63106F02	MPC 0.22 ohm 5W							
R165	06T63106F02	MPC 0.22 ohm 5W							
R166	06T92261F33	4.7 ohm							
R167	06T92261F33	4.7 ohm							
VR101	18C41732G07	Variable, V 1k ohm B							

Notes: ● : For West German model only (AD), ▲ : For Canadian model only (UQ), Others : Common.

Symbol No.	Part No.	Description		
Main Amp P. C. Board (R)				
Transistors				
Q201	48T72597F01	2SA995		
Q202	48T72598F01	2SC2291		
Q203	48T72888F01	2SA1208		
Q204	48T72888F01	2SA1208		
Q205	48T71448F01	2SA1361		
Q206	48T71449F01	2SC3424		
Q208	48T80986F01	2SC3378		
Q209	48T81444F01	2SA1335		
Q212	48T53301F01	2SC2240		
Q213	48T64240F02	2SC2344		
Q214	48T53301F01	2SC2240		
Q215	48T52545F01	2SA970		
Q216	48T47145F01	2SA1011		
Q217	48T52545F01	2SA970		
Q226	48T71752F01	FET, 2SJ109		
Q227	48T80991F01	FET, 2SK614		
Diodes/LEDs				
D201	48T68764F01	1S2471		
D202	48T68764F01	1S2471		
D203	48T73079F02	ISS82		
D204	48T68764F01	1S2471		
D205	48T68764F01	1S2471		
D206	48T73079F02	ISS82		
D207	48T68764F01	1S2471		
D208	48T68764F01	1S2471		
▲ D209	48T68764F01	1S2471		
ZD201	48T52741F17	Zener, HZ7C-2L		
▲ ZD202	48T40150U58	Zener, HZ11C-1		
LD201	48T60971F01	LED, LTZ-R15		
LD202	48T60971F01	LED, LTZ-R15		
LD203	48T60971F01	LED, LTZ-R15		
Capacitors				
C201	08T81196F34	MICA., 100pF		
C202	23T81031F05	ELY., (B.P.) 10 μ F/100V		
C203	08T81196F19	MICA., 33pF		
C204	08T81196F32	MICA., 82pF		
C205	23T00138L78	ELY., 33 μ F/100V		
C206	08S40656F25	MYL., 0.1 μ F		
C207	23T00138L78	ELY., 33 μ F/100V		
● C208	08T52448F05	PP., 470pF		
▲ C208	08S40656F06	MYL., 2700pF		
● C209	08T52448F05	PP., 470pF		

Symbol No.	Part No.	Description		
▲ C209	08S40656F06	MYL., 2700pF		
C210	23T00138L17	ELY., 10 μ F/16V		
C211	23T00138L17	ELY., 10 μ F/16V		
C212	23T00138L77	ELY., 22 μ F/100V		
C213	23T00138L77	ELY., 22 μ F/100V		
C214	23T00161L06	ELY., 100 μ F/100V		
C215	23T00161L06	ELY., 100 μ F/100V		
● C216	23T00138L18	ELY., 22 μ F/16V		
▲ C216	23T00138L20	ELY., 47 μ F/16V		
C217	23T00138L45	ELY., 1 μ F/50V		
C218	08T81196F25	MICA., 47pF		
C219	08T81196F25	MICA., 47pF		
C221	23T71210F23	ELY., (B.P.) 1 μ F/50V		
C222	08T93192F65	PF 4700pF		
C223	08T61642F27	MICA., 100pF		
Resistors (All resistors are Metal Film 2W \pm 5% unless otherwise noted.)				
R249	06T73186F37	M.O., 68 ohm		
R250	06T73186F37	M.O., 68 ohm		
R251	06T92261F33	4.7 ohm		
R255	06T92261F33	4.7 ohm		
R258	06T92261F33	4.7 ohm		
R259	06T92261F33	4.7 ohm		
R260	06T63106F02	MPC 0.22 ohm 5W		
R261	06T63106F02	MPC 0.22 ohm 5W		
R262	06T63106F02	MPC 0.22 ohm 5W		
R263	06T63106F02	MPC 0.22 ohm 5W		
R264	06T63106F02	MPC 0.22 ohm 5W		
R265	06T63106F02	MPC 0.22 ohm 5W		
R266	06T92261F33	4.7 ohm		
R267	06T92261F33	4.7 ohm		
VR201	18C41732G07	Variable, 1k ohm B		
Power Supply P. C. Board				
IC's				
IC301	51T67437F01	TA7317P		
IC302	51T72375F01	NJM78M12A		
Transistors				
Q301	48T43526F02	2SA950		
Q302	48T45274F02	2SC2120		
Q303	48T51119F01	2SA965		

Notes: ● : For West German model only (AD), ▲ : For Canadian model only (UQ), Others: Common.

Symbol No.	Part No.	Description			Symbol No.	Part No.	Description		
Diodes					Diodes				
D301	48S40477U01	IN4003			D401	48S40477U01	IN4003		
D302	48S40477U01	IN4003			D402	48S40477U01	IN4003		
D303	48S40477U01	IN4003			D403	48T68764F01	1S2471		
D304	48S40477U01	IN4003			D404	48T68764F01	1S2471		
D305	48S40477U01	IN4003							
D306	48S40477U01	IN4003			Coils				
D307	48S40477U01	IN4003			L401	24T67517F02	Choke 1.8 μ H		
D308	48S40477U01	IN4003			L402	24T67517F02	Choke 1.8 μ H		
D309	48S40477U01	IN4003							
ZD301	48T52741F56	Zener, HZ20-2L			Relays				
ZD302	48T52739F73	Zener, HZ12B-1			RL401	80T92285F01	JC2AF-DC12V		
					RL402	80T92285F01	JC2AF-DC12V		
Capacitors					Terminals				
C301	23T00138L18	ELY., 22 μ F/16V			E401	09T81008F01	Speaker (4P)		
C302	23T00138L18	ELY., 22 μ F/16V			E402	09T81008F01	Speaker (4P)		
C303	23T00138L18	ELY., 22 μ F/16V			Capacitors				
C304	23T00138L18	ELY., 22 μ F/16V			C401	08S40656F25	MYL., 0.1 μ F		
C305	23T00138L19	ELY., 33 μ F/16V			C402	08S40656F25	MYL., 0.1 μ F		
C306	23T00138L18	ELY., 22 μ F/16V			C403	08S40656F25	MYL., 0.1 μ F		
C307	23T00138L31	ELY., 100 μ F/25V			C404	08S40656F25	MYL., 0.1 μ F		
C308	23T00138L33	ELY., 330 μ F/25V			C405	08T52448F13	PP., 1000pF		
C309	23S40657F28	ELY., 1 μ F/50V			C406	08T52448F13	PP., 1000pF		
C310	21T68834F01	CER., 0.01 μ F			C407	08T52448F13	PP., 1000pF		
C311	21T68834F01	CER., 0.01 μ F			C408	08T52448F13	PP., 1000pF		
C312	21T68834F01	CER., 0.01 μ F			C409	08T52448F13	PP., 1000pF		
C313	23S41198U38	ELY., 100 μ F/63V			C410	08T52448F13	PP., 1000pF		
C314	23S41198U38	ELY., 100 μ F/63V			Resistors				
C315	23S40657F27	ELY., 0.47 μ F/50V			R401	06T92265F01	M.F., 10 ohm 3W		
C316	23T81246F01	ELY., 1000 μ F/100V			R402	06T92265F01	M.F., 10 ohm 3W		
C317	23T81246F01	ELY., 1000 μ F/100V			R407	06T83854F02	M.O., 10 ohm 3W		
C318	08S40656F14	MYL., 0.012 μ F			R408	06T83854F02	M.O., 10 ohm 3W		
C319	23S40657F20	ELY., 47 μ F/25V							
C320	08T52448F01	PP., 330pF							
Speaker Terminal P. C. Board					Resistors				
Transistors									
Q401	48T51118F01	2SA1015							

Symbol No.	Part No.	Description			Symbol No.	Part No.	Description		
Input P. C. Board									
Switch/Jack									
S501 J501	40T92287F01 09T92606F01	Switch, Slide Input Jack			Q711 Q712 Q713 Q714 Q715	48T62962F02 48T62962F02 48T62962F02 48T62962F02 48T62962F02	DTA114 DTA114 DTA114 DTA114 DTA114		
Capacitors									
C501 C502 C503 C504	08T61642F27 08T61642F27 23S57007F09 23S57007F09	MICA., 100pF MICA., 100pF ELY., 10 μ F/16V ELY., 10 μ F/16V			Q716 Q717 Q718 Q719 Q720	48T62962F02 48T43526F02 48T81101F01 48T62962F06 48T81101F01	DTA114 2SA950 2SC1815 DTA114Y 2SC1815		
ATT Volume P. C. Board									
Volumes									
VR601 VR602	18T92289F01 18T92289F01	Rotary K162A0 (ATTENUATOR LEFT) Rotary K162A0 (ATTENUATOR RIGHT)			Q721 Q722	48T81101F01 48T62963F02	2SC1815 DTC114Y		
Display P. C. Board									
IC's									
IC702 IC703 IC704 IC705 IC706 IC707	51T72309F01 51T90126F01 51T53321F01 51T80136F01 51T80136F01 51T80136F01	MN1280 90126F01 M74LS42P M5238P M5238P M5238P			Diodes				
					D701 D704 D705 D706 D711	48T68764F01 48T68764F01 48T68764F01 48T68764F01 51T62554F02	1S2471 1S2471 1S2471 1S2471 Array DAN-401		
					D712 D713 D714 D721 D722	51T62554F02 48T56286F01 48T68764F01 48T68764F01 48T68764F01	Array DAN-401 1SS106 1S2471 1S2471 1S2471		
					D723 D724 ZD701 ZD702	48T68764F01 48T68764F01 48T52739F25 48T52739F73	1S2471 1S2471 Zener, HZ5A-1 Zener, HZ12B-1		
					Crystal				
					X701	48T92292F01	12MHz		
					Capacitors				
					C701 C702 C703 C704 C709	23S57007F11 23S57007F15 23S57007F15 23S57007F05 08S44505P17	ELY., 22 μ F/16V ELY., 47 μ F/16V ELY., 47 μ F/16V ELY., 1 μ F/50V CER., 15pF		
					C710 C711 C712 C715 C716	08S44505P17 23S41198U15 23S57007F02 23S57007F02 23S57007F02	CER., 15pF ELY., 22 μ F/25V ELY., 0.22 μ F/50V ELY., 0.22 μ F/50V ELY., 0.22 μ F/50V		
Transistors									
Q701 Q702 Q703 Q704 Q705	48T62962F02 48T62962F02 48T62962F02 48T62962F02 48T62962F02	DTA114 DTA114 DTA114 DTA114 DTA114							
Q706 Q707 Q708 Q709 Q710	48T62962F02 48T62962F02 48T62962F02 48T62962F02 48T62962F02	DTA114 DTA114 DTA114 DTA114 DTA114							

Symbol No.	Part No.	Description			Symbol No.	Part No.	Description		
C719	23S57007F15	ELY., 47 μ F/16V			LED O/B P. C. Board				
C720	23S57007F15	ELY., 47 μ F/16V			LED's				
C721	08S44505P63	CER., 0.022 μ F			LD851	48T60488F01	SLR-54DU3 (ORG)		
C722	08S44505P63	CER., 0.022 μ F			LD852	48T68847F01	SLR-54MC3 (GRN)		
C723	08S44505P63	CER., 0.022 μ F			Miscellaneous				
C724	08S44505P63	CER., 0.022 μ F			BD1	48T64237F01	Bridge Diode S15VB40		
C725	08S44505P63	CER., 0.022 μ F			BD2	48T64237F01	Bridge Diode S15VB40		
C726	08S44505P63	CER., 0.022 μ F			C1	23T92290F01	CAP., ELY., 15000 μ F/90V		
C727	08S44505P63	CER., 0.022 μ F			C2	23T92290F01	CAP., ELY., 15000 μ F/90V		
Resistors					C3	23T92290F01	CAP., ELY., 15000 μ F/90V		
VR701	18T42748F11	Variable, 4.7k ohm B			C4	23T92290F01	CAP., ELY., 15000 μ F/90V		
VR702	18T42748F11	Variable, 4.7k ohm B			C5	08T57437F11	CAP., CER., 0.01 μ F		
Turbo Amp P. C. Board					● C6	08T57437F11	CAP., CER., 0.01 μ F		
IC's					● F301	65T42077U16	Fuse, Semko T-1A		
IC708	51T80136F01	M5238P			▲ F301	65T66926F16	Fuse, 51NM (2A-125V)		
IC709	51T80136F01	M5238P			● F302	65T42077U16	Fuse, Semko T-1A		
Diodes					▲ F302	65T66926F16	Fuse, 51NM (2A-125V)		
D707	48T68764F01	1S2471			● F303	65T42077U16	Fuse, Semko T-1A		
D708	48T68764F01	1S2471			▲ F303	65T66926F16	Fuse, 51NM (2A-125V)		
D709	48T68764F01	1S2471			● F701	65T42077U13	Fuse, Semko T300mA		
D710	48T68764F01	1S2471			▲ F701	65T66926F04	Fuse, 51NM (500mA-250V)		
Capacitors					● F901	65T42077U24	Fuse, Semko T6.3A		
C705	23T42477F16	ELY., (B.P.) 1 μ F/50V			▲ F901	65T94672F16	Fuse, (15A-250V)		
C706	23T42477F16	ELY., (B.P.) 1 μ F/50V			FL701	65T93203F01	FL, Display		
C707	23S57007F05	ELY., 1 μ F/50V			FL702	65T93203F01	FL, Display		
C708	23S57007F05	ELY., 1 μ F/50V			IC701	51T72310F01	IC, μ PC78M05H		
C730	23S57007F15	ELY., 47 μ F/16V			● P1	28T65151F03	AC Power Cord		
C731	23S57007F15	ELY., 47 μ F/16V			▲ P1	28T66838F01	AC Power Cord		
Volumes					● P2	09T51830F01	Plug, Switch		
VR703	18T42748F10	Solid 3.3k ohm			Q110	48T62642F01	TR., 2SC2336		
VR704	18T42748F10	Solid 3.3k ohm			Q111	48T62641F01	TR., 2SA1006		
					● Q118	48T69177F01	TR., 2SA1358		
					▲ Q118	48T69177F02	TR., 2SA1358		
					Q119	48T81856F02	TR., 2SA1216		
					Q120	48T81856F02	TR., 2SA1216		

Notes : ● : For West German model only (AD), ▲ : For Canadian model only (UQ), Others : Common.

Symbol No.	Part No.	Description			Symbol No.	Part No.	Description		
Q121	48T81856F02	TR., 2SA1216							
Q122	48T81857F02	TR., 2SC2922							
Q123	48T81857F02	TR., 2SC2922							
Q124	48T81857F02	TR., 2SC2922							
Q125	48T69176F02	TR., 2SC3421							
Q210	48T62642F01	TR., 2SC2336							
Q211	48T62641F01	TR., 2SA1006							
Q218	48T69177F02	TR., 2SA1358							
Q219	48T81856F02	TR., 2SA1216							
Q220	48T81856F02	TR., 2SA1216							
Q221	48T81856F02	TR., 2SA1216							
Q222	48T81857F02	TR., 2SC2922							
Q223	48T81857F02	TR., 2SC2922							
Q224	48T81857F02	TR., 2SC2922							
Q225	48T69176F02	TR., 2SC3421							
S1	40T80736F01	Switch, Push (Power)							
● S2	09T51831F01	Socket, Switch							
S801	40T92288F01	Switch, Push (SPEAKER A)							
S802	40T92288F01	Switch, Push (SPEAKER B)							
S901	40T92286F01	Switch, Slide (SP IMPEDANCE)							
S902	40T92286F01	Switch, Slide (INDICATOR PEAK HOLD TIME)							
● T1	25T92291F01	Trans. Power							
▲ T1	25T92605F01	Trans. Power							

Notes : ● : For West German model only (AD), ▲ : For Canadian model only (UQ), Others : Common.

Packing Assembly Parts List

Symbol No.	Part No.	Description			Symbol No.	Part No.	Description		
101	68P83710F08	Owners Manual							
102	56S83833F16	Carton, Packing							
103	56B63425F04	Sack, Polyethylene							
104	56D90622F01	Tray, Packing							
105	56B40230G08	Sack, Polyethylene							

Packing Method View

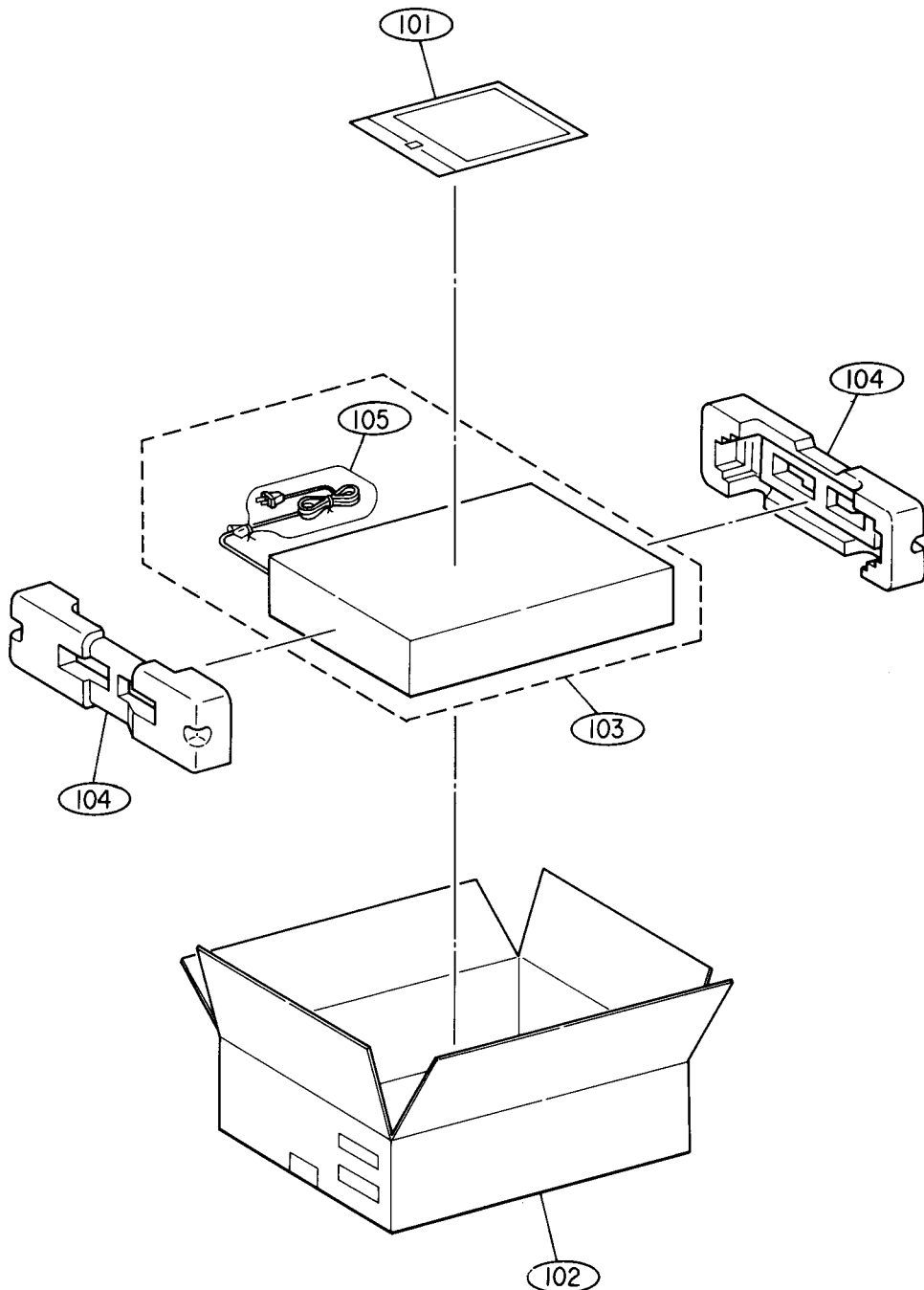

Cabinet Assembly Parts List

NOTE : The parts without part numbers are not supplied.

Symbol No.	Index	Part No.	Description	Symbol No.	Index	Part No.	Description
1	4-A	01V91600F82	Assy., Front Panel	56		03S43997P83	Screw, Bind (M2.6 × 4)
2	1-C	15D80717F02	Cover, Top	57	2-H	03S43997P67	Screw, Round (M2.6 × 6)
7	4-C	36A61435F01	Knob, Volume	61		07A80846F01	Bracket, Power Bus "A"
8	5-C	36A90623F01	Knob, Push Speaker	65		47C64899F48	Shaft, P.C.Board (L=7)
9	4-B	36B70885F08	Knob, Push Power	68		43T94356F01	Spacer
10		03S40012G93	Screw, Tapping (M3 × 8)	69		43T45472F01	Bushing, YC40B
11	1-F	14S53018F42	Insulator	70		03C40121T28	Screw, W/Washer (M3 × 7.5)
12	6-C	75B80720F03	Trannleg	▲ 79	2-F	09T51960F01	Holder, Fuse
13	6-C	75A80719F01	Pad, Trannleg	▲ 80		14A96127F01	Insulator, Terminal
14	6-C	03S63857F10	Screw, Tapping (M4 × 12)	▲ 81	3-G	54B62266F13	Label, Fuse (2A - 125V)
16		03S40036U01	Screw, W/Washer (M4 × 8)	▲ 82	5-C	54B62266F44	Label, Fuse (250V - 500mA)
17		75S62361F60	Cushion Rubber	▲ 83	2-F	54B62266F58	Label, Fuse (250V - 15A)
18	1-D	03S81717F01	Screw, Round (M3 × 6)				
20		03S44205G02	Screw, Pan (M3 × 6)				
22		14S53018F68	Insulator				
23		29C41045P05	Lug, Wrap 54mm				
24	3-H	47A90966F01	Shaft, P.C.Board (L=6)				
29		03S63857F07	Screw, Tapping (M4 × 16)				
31		43A74626F01	Bushing, Wire				
32		43T92024F02	KGLS-6RT				
33	3-D	01T92306F01	Assy., CWV Lug				
34	3-C	07A92296F01	Bracket Cap				
37		09T51410F01	Holder, Fuse				
39	5-C	14S53017F64	Insulator, Cover				
40		03S43997P76	Screw, Bind (M3 × 6)				
41		43T53136F01	Bush, Cap				
43	4-E	05B41635J02	Rivet Push				
44	4-B	14S53017F67	Insulator, Cover				
● 51	2-H	15D90617F01	Cover, Rear				
▲ 51	2-H	15D90617F02	Cover, Rear				
● 52	1-G	43B41625J02	Support, Cord				
▲ 52	1-G	43B41625J05	Support, Cord				
53	1-F	47C64899F47	Shaft, P.C.Board (L=10.5)				
54	2-H	43A61764F01	Spacer				
55	2-H	04A53398F02	Washer, Nylon (M3)				

Notes : ● : For West German model only (AD), ▲ : For Canadian model only (UQ), Others : Common.

Semi-Conductor Lead Identifications

TA7317P : IC301

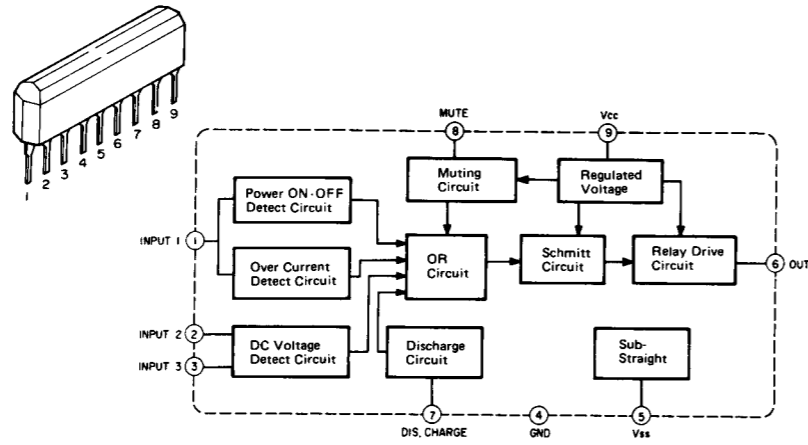

NJM78M12A : IC302

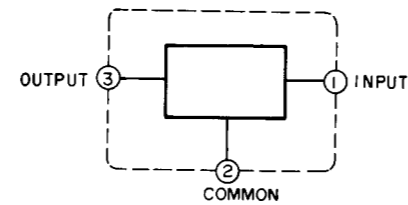
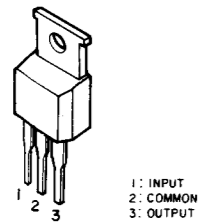

μ PC78M05H : IC701

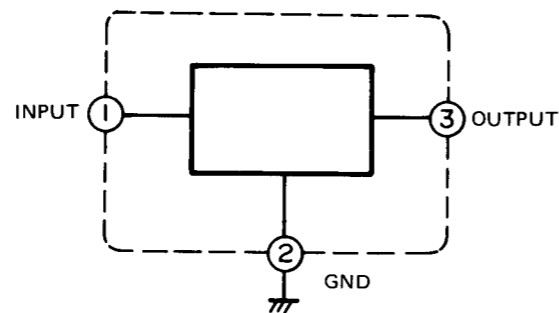
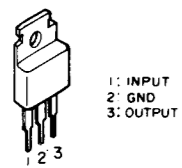

MN1280 : IC702

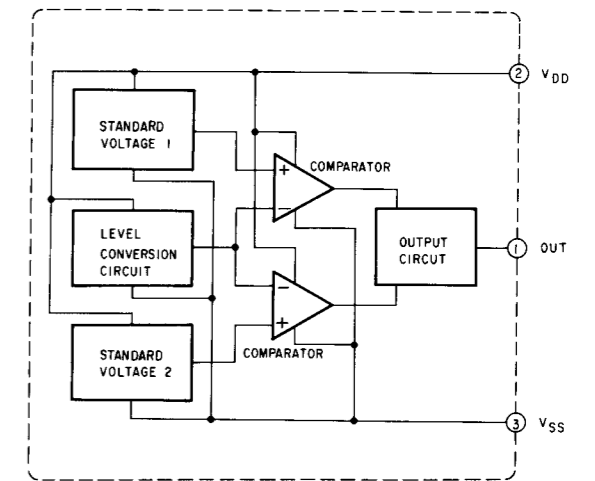
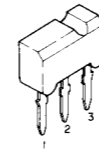

90126F01 : IC703

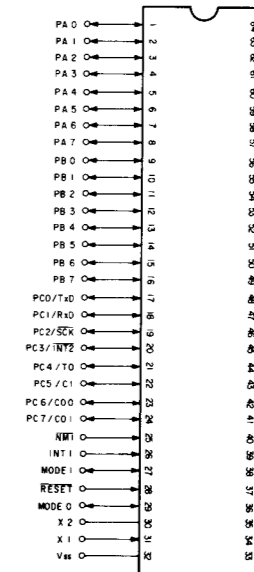
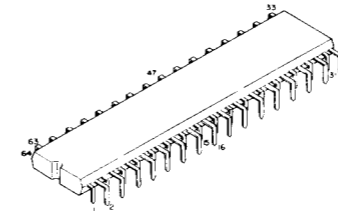

M74LS42P : IC704

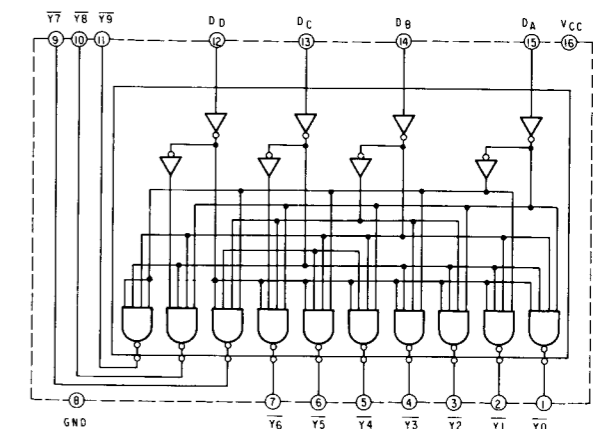
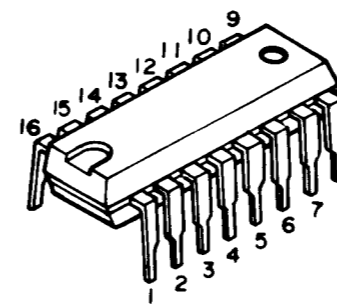

M5238P : IC705, 706, 707, 708, 709

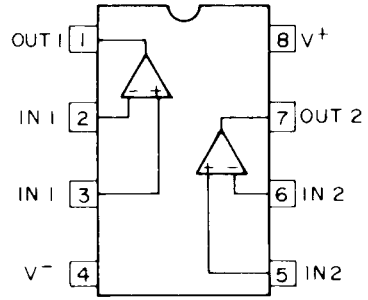
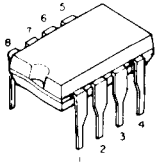

2SA995 : Q101, 201

2SC2291 : Q102, 202

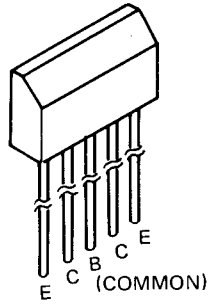

2SA1028 : Q103, 104, 203, 204

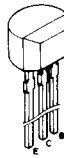

2SA1361 : Q105, 205

2SC3424 : Q106, 206

2SA1358 : Q118, 218

2SC3421 : Q125, 225

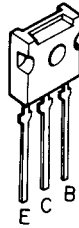

2SC3378 : Q108, 208
2SA1335 : Q109, 209

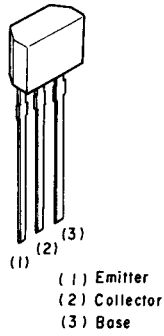

2SC2336 : Q110, 210
2SA1006 : Q111, 211
2SC2344 : Q113, 213
2SA1011 : Q116, 216

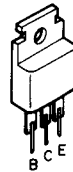

2SC2240 : Q112, 114, 212, 214
2SA970 : Q115, 117, 215, 217
2SA950 : Q301, 717
2SC2120 : Q302
2SA1015 : Q401
2SC1815 : Q718, 720, 721

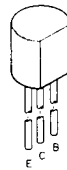

2SA1216 : Q119, 120, 121, 219, 220, 221
2SC2922 : Q122, 123, 124, 222, 223, 224

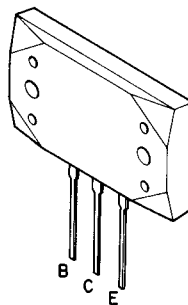

2SJ109 : Q126, 226

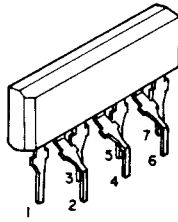

- 1. Drain 1
- 2. Gate 1
- 3. Source 1
- 4. Sub-straight
- 5. Source 2
- 6. Gate 2
- 7. Drain 2

2SK614 : Q127, 227

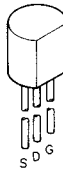

2SA965 : Q303



DTA114 : Q701, 702, 703, 704, 705, 706, 707, 708, 709, 710
 : Q711, 712, 713, 714, 715, 716
 DTA114Y : Q719

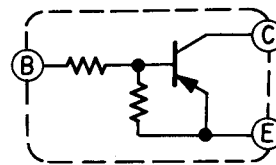
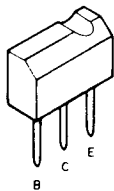

DTC114 : Q722

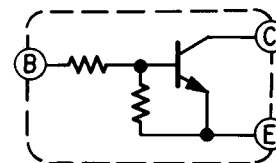
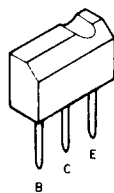



LUX CORPORATION, JAPAN

1-8, 1-Chome, Nishigotanda, Shinagawa-ku, Tokyo 141 Japan
Phone: 03-493-4381 Facsimile: 03-494-8426