

CIRCUIT DIAGRAM

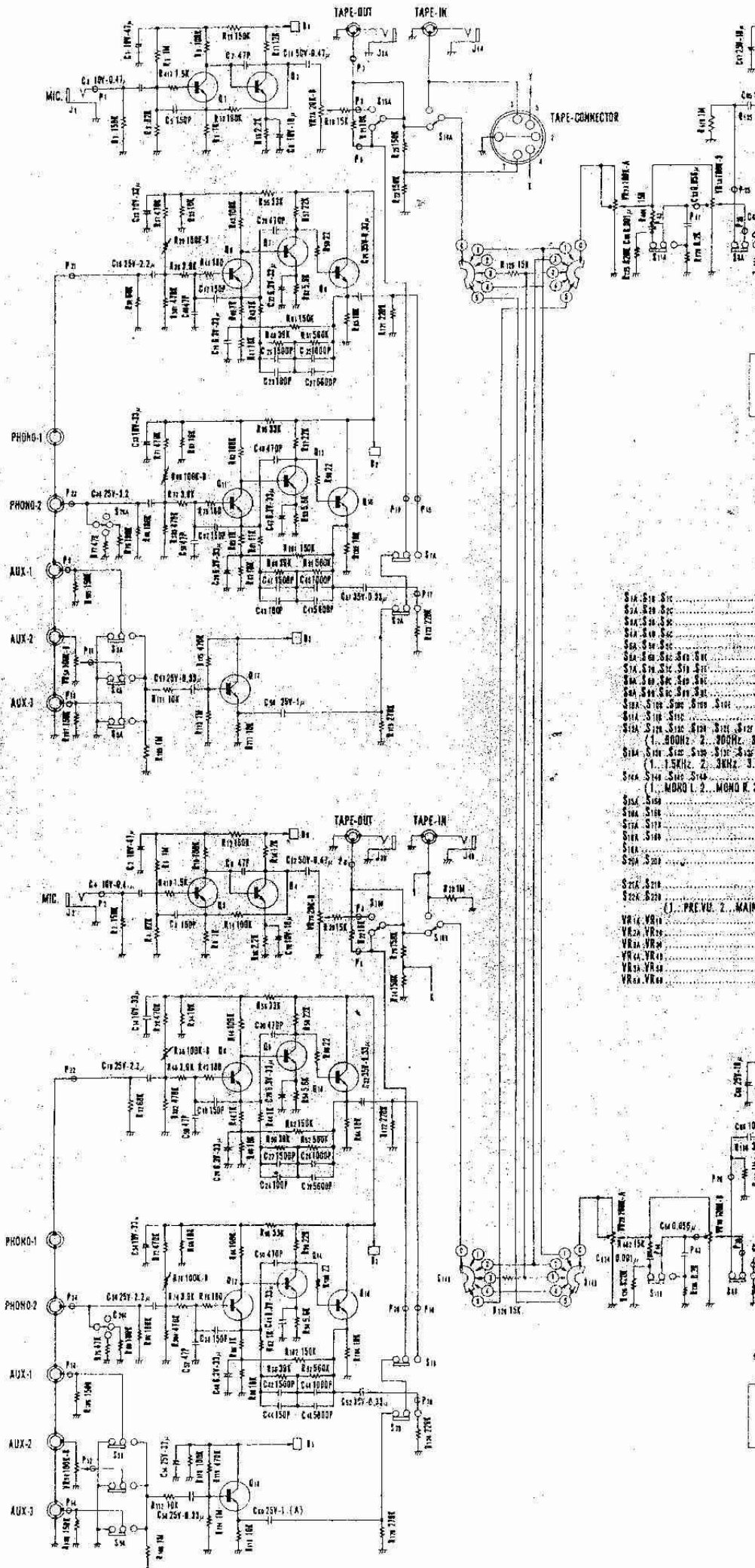

- 51A. 51B. 51C.
- 52A. 52B. 52C.
- 53A. 53B. 53C.
- 54A. 54B. 54C.
- 55A. 55B. 55C.
- 56A. 56B. 56C.
- 57A. 57B. 57C.
- 58A. 58B. 58C.
- 59A. 59B. 59C.
- 60A. 60B. 60C.
- 61A. 61B. 61C.
- 62A. 62B. 62C.
- 63A. 63B. 63C.
- 64A. 64B. 64C.
- 65A. 65B. 65C.
- 66A. 66B. 66C.
- 67A. 67B. 67C.
- 68A. 68B. 68C.
- 69A. 69B. 69C.
- 70A. 70B. 70C.
- 71A. 71B. 71C.
- 72A. 72B. 72C.
- 73A. 73B. 73C.
- 74A. 74B. 74C.
- 75A. 75B. 75C.
- 76A. 76B. 76C.
- 77A. 77B. 77C.
- 78A. 78B. 78C.
- 79A. 79B. 79C.
- 80A. 80B. 80C.

(1) PREVIOUS MAIN-1

VR14. VR15
VR24. VR25
VR34. VR35
VR44. VR45
VR54. VR55
VR64. VR65

SD202

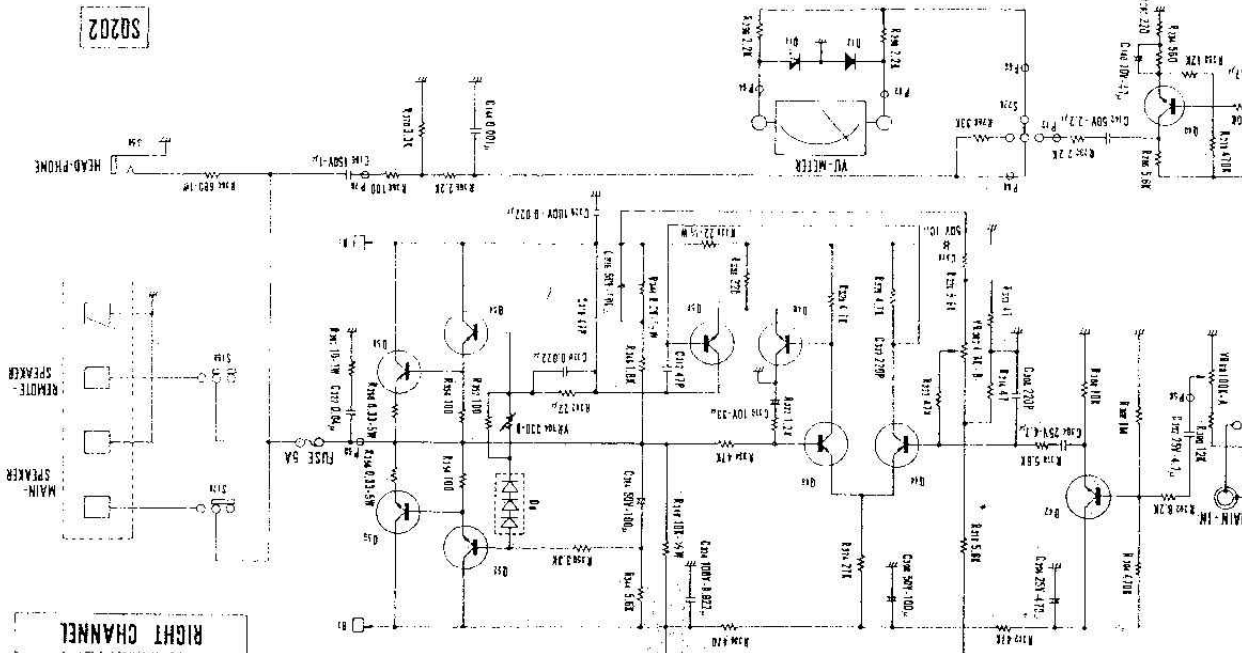

RIGHT CHANNEL

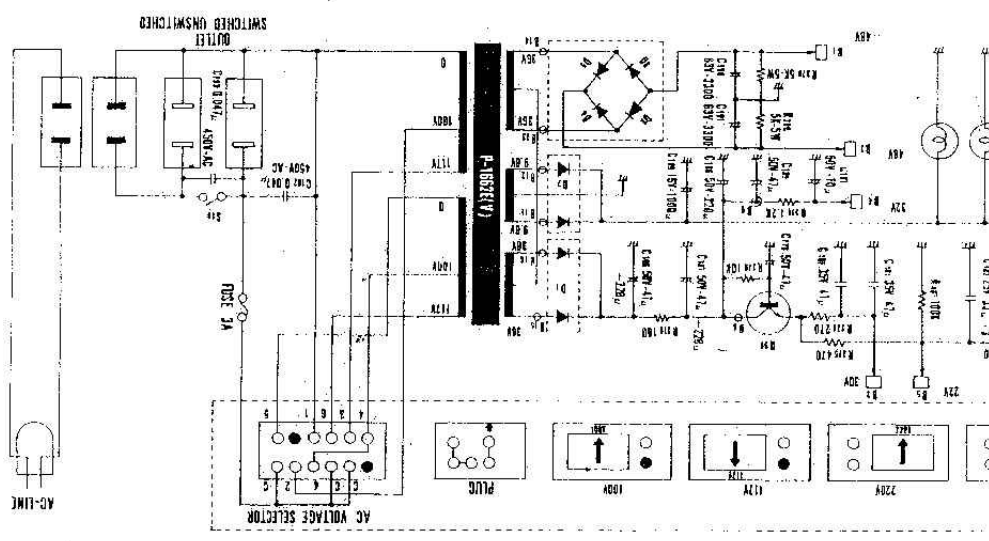

LEFT CHANNEL

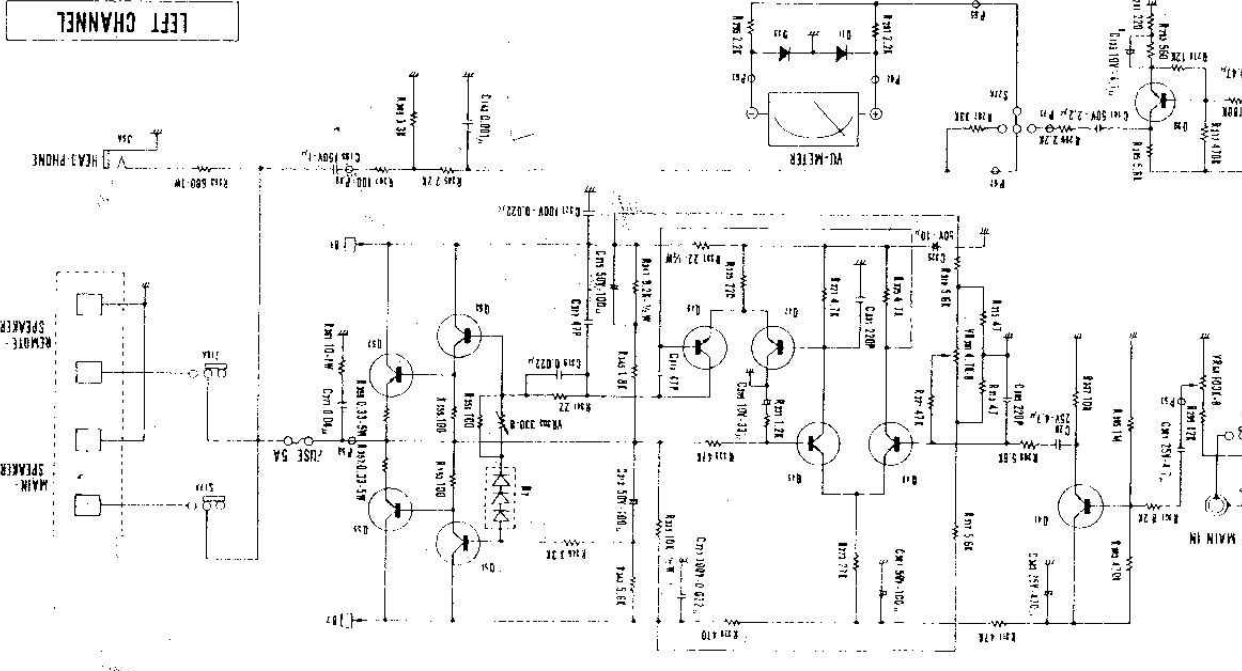

CIRCUIT DIAGRAM

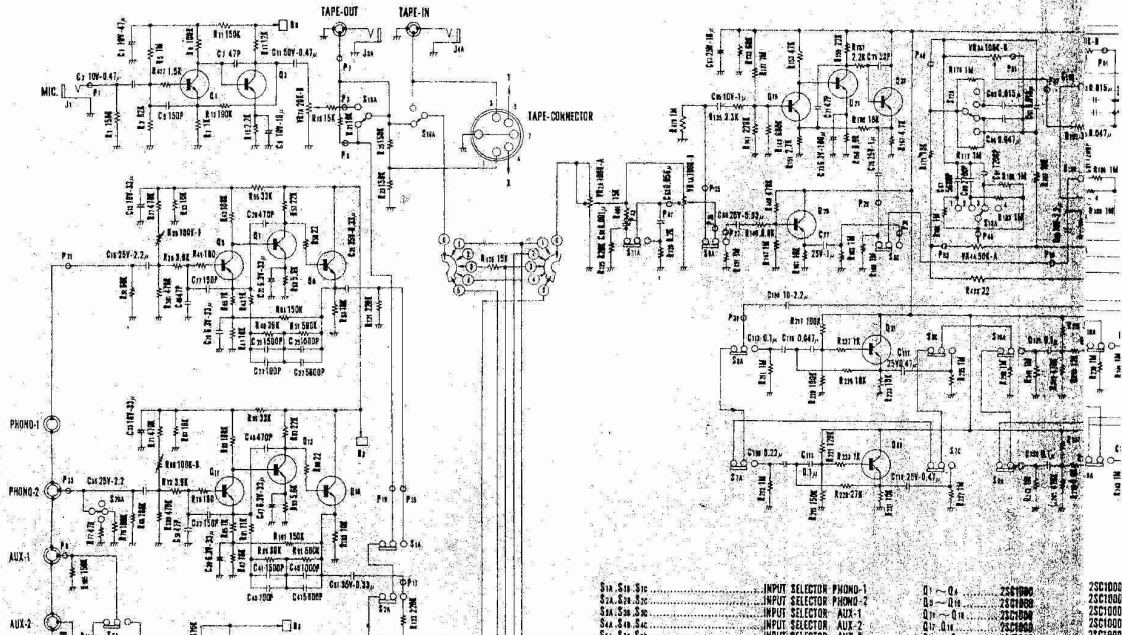

S1a, S1b, S1c	INPUT SELECTOR PHONO-1	Q1 - Q4	25C1000
S2a, S2b, S2c	INPUT SELECTOR PHONO-2	Q5 - Q8	25C1000
S3a, S3b, S3c	INPUT SELECTOR AUX-1	Q9 - Q12	25C1000
S4a, S4b, S4c	INPUT SELECTOR AUX-2	Q13 - Q16	25C1000
S5a, S5b, S5c	INPUT SELECTOR TAPE	Q17 - Q20	25C1000

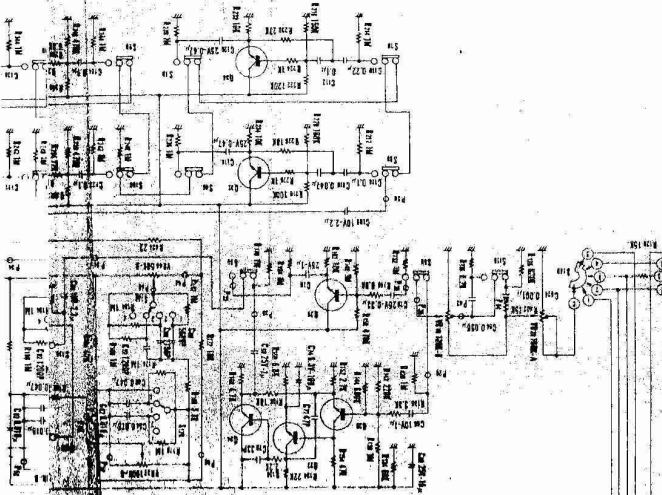
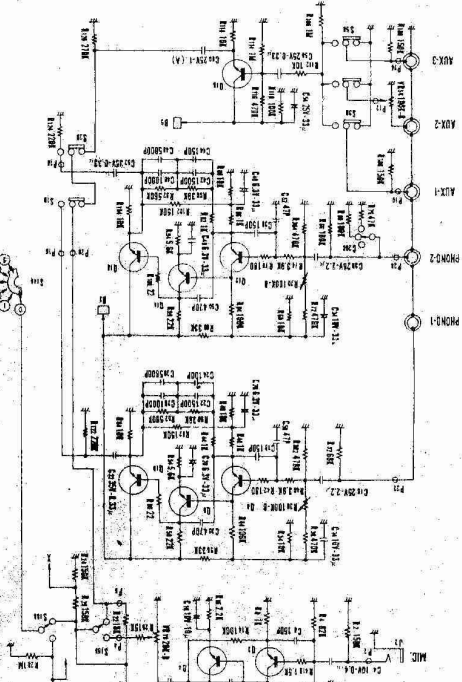

SPK. 5-175 (1) 100K 2, 50R 3 (2)
PRE-GUT MAIN-IN CONNECT SW
METER SELECTOR
Scan 8029
(1) PRE-VOL 2, MAIN-1+4dB, 3, MAIN-0dB
VOLUME CONTROL
BALANCE CONTROL
PASS CONTROL
TREBLE CONTROL
AUX-1 LEVEL SET
MAIN-AMP LEVEL FEEL
VR1A VR1B
VR1C VR1D
VR2A VR2B
VR2C VR2D
VR3A VR3B
VR3C VR3D

SV-03
SV-04
DS-30
DS-31

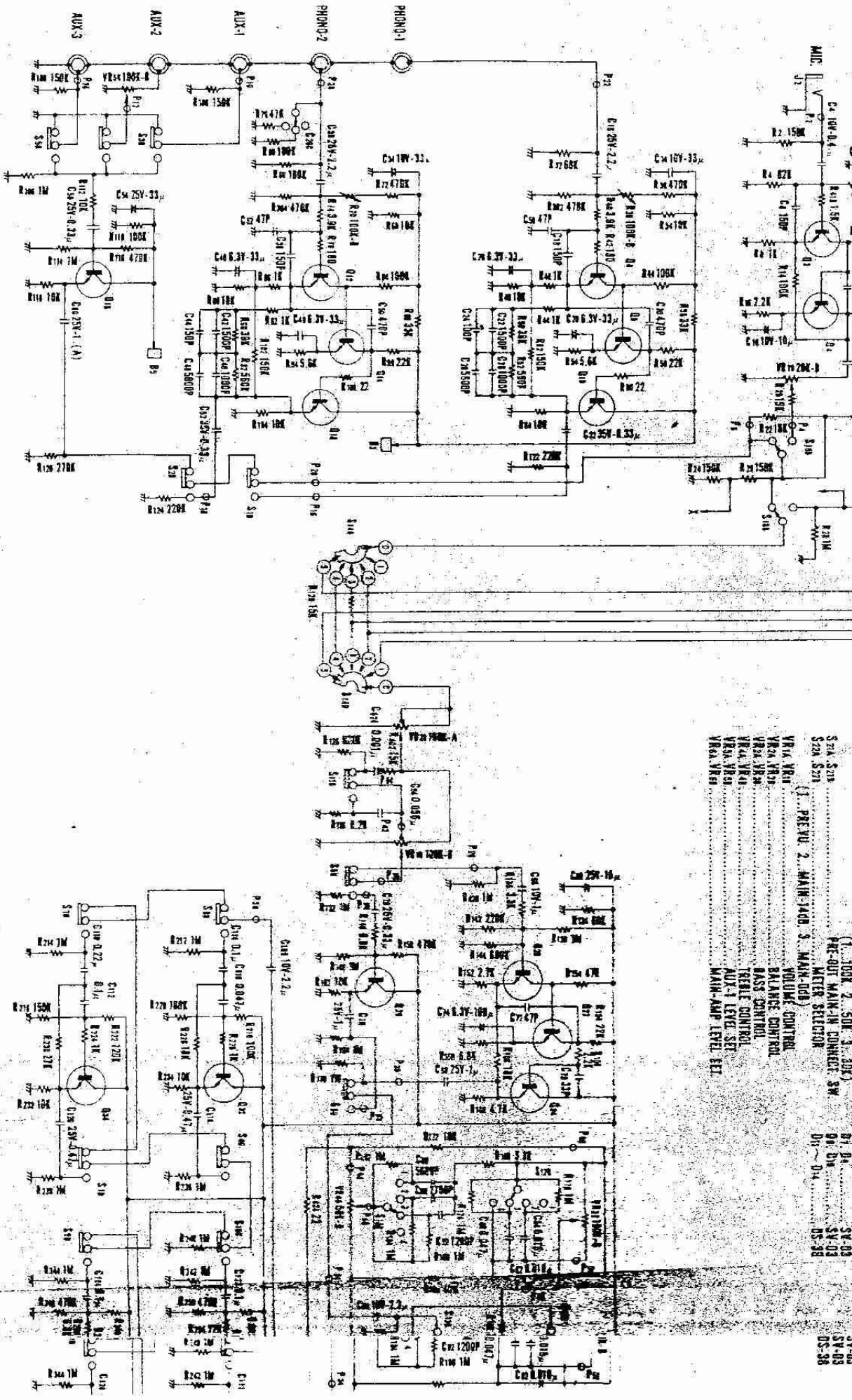

S2A, S1B
 S2A, S2B
 (1) PRE-VD. 2, MAIN-1A-D, 3, MAIN-10-D
 6X4 VBI-1
 6X4 VBI-2
 6X4 VBI-3
 6X4 VBI-4
 6X4 VBI-5
 6X4 VBI-6
 6X4 VBI-7
 VOLUME CONTROL
 BALANCE CONTROL
 BASS CONTROL
 TREBLE CONTROL
 AUX-1 LEVEL SET
 MAIN-AMP LEVEL SET

S2A-D
 S2B-D
 S2C-D
 S2D-D
 S2E-D
 S2F-D
 S2G-D
 S2H-D
 S2I-D
 S2J-D
 S2K-D
 S2L-D
 S2M-D
 S2N-D
 S2O-D
 S2P-D
 S2Q-D
 S2R-D
 S2S-D
 S2T-D
 S2U-D
 S2V-D
 S2W-D
 S2X-D
 S2Y-D
 S2Z-D

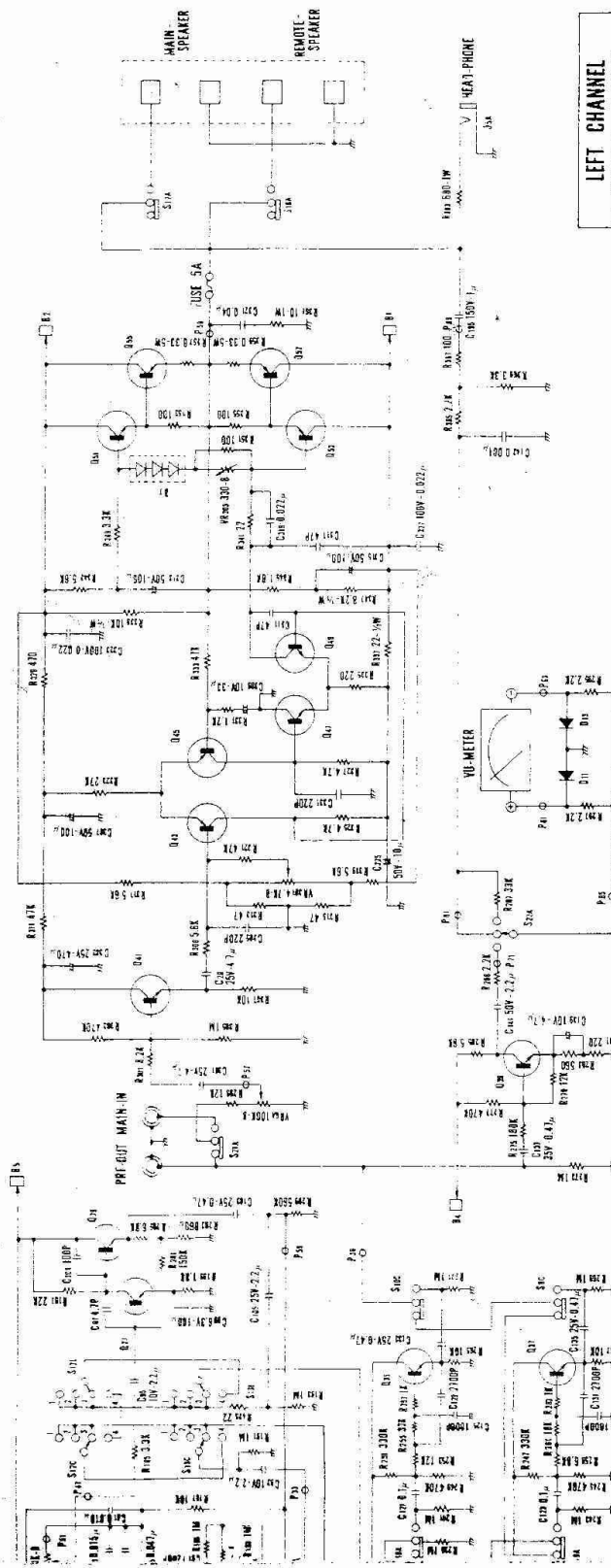

LEFT CHANNEL

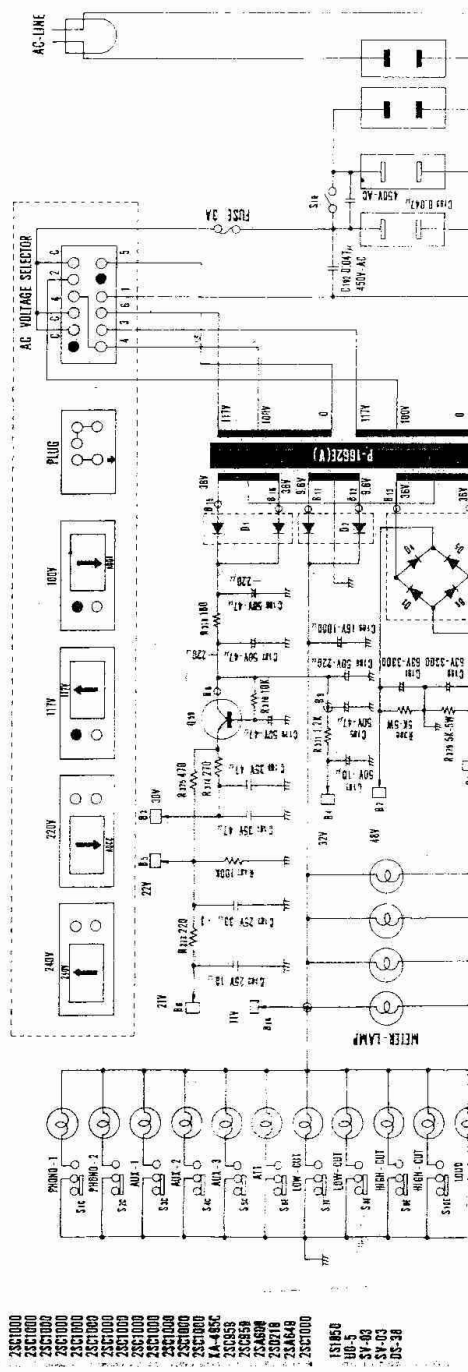

- 0000382
- 0000383
- 0000384
- 0000385
- 0000386
- 0000387
- 0000388
- 0000389
- 0000390
- 0000391
- 0000392
- 0000393
- 0000394
- 0000395
- 0000396
- 0000397
- 0000398
- 0000399
- 0000400
- 0000401
- 0000402
- 0000403
- 0000404
- 0000405
- 0000406
- 0000407
- 0000408
- 0000409
- 0000410
- 0000411
- 0000412
- 0000413
- 0000414
- 0000415
- 0000416
- 0000417
- 0000418
- 0000419
- 0000420
- 0000421
- 0000422
- 0000423
- 0000424
- 0000425
- 0000426
- 0000427
- 0000428
- 0000429
- 0000430
- 0000431
- 0000432
- 0000433
- 0000434
- 0000435
- 0000436
- 0000437
- 0000438
- 0000439
- 0000440
- 0000441
- 0000442
- 0000443
- 0000444
- 0000445
- 0000446
- 0000447
- 0000448
- 0000449
- 0000450
- 0000451
- 0000452
- 0000453
- 0000454
- 0000455
- 0000456
- 0000457
- 0000458
- 0000459
- 0000460
- 0000461
- 0000462
- 0000463
- 0000464
- 0000465
- 0000466
- 0000467
- 0000468
- 0000469
- 0000470
- 0000471
- 0000472
- 0000473
- 0000474
- 0000475
- 0000476
- 0000477
- 0000478
- 0000479
- 0000480
- 0000481
- 0000482
- 0000483
- 0000484
- 0000485
- 0000486
- 0000487
- 0000488
- 0000489
- 0000490
- 0000491
- 0000492
- 0000493
- 0000494
- 0000495
- 0000496
- 0000497
- 0000498
- 0000499
- 0000500

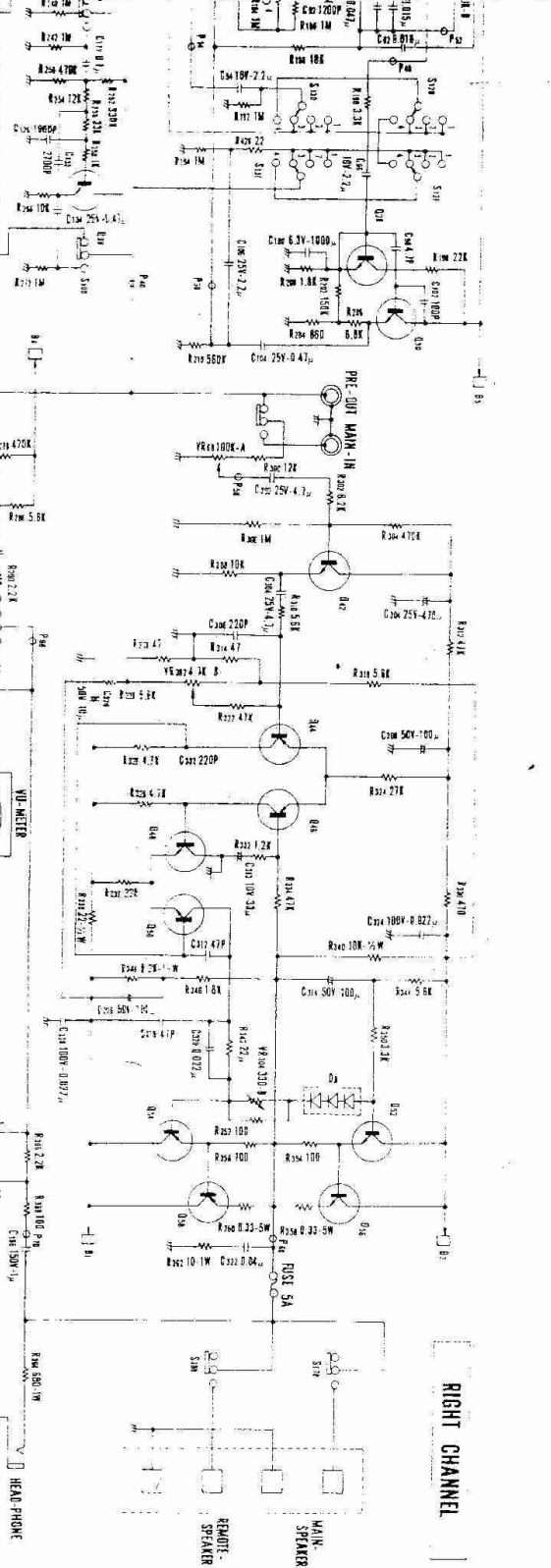
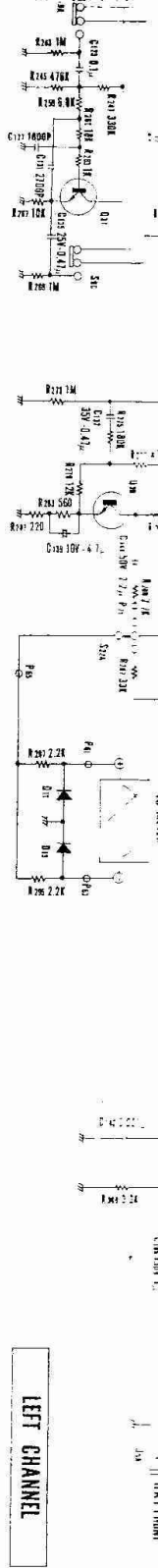
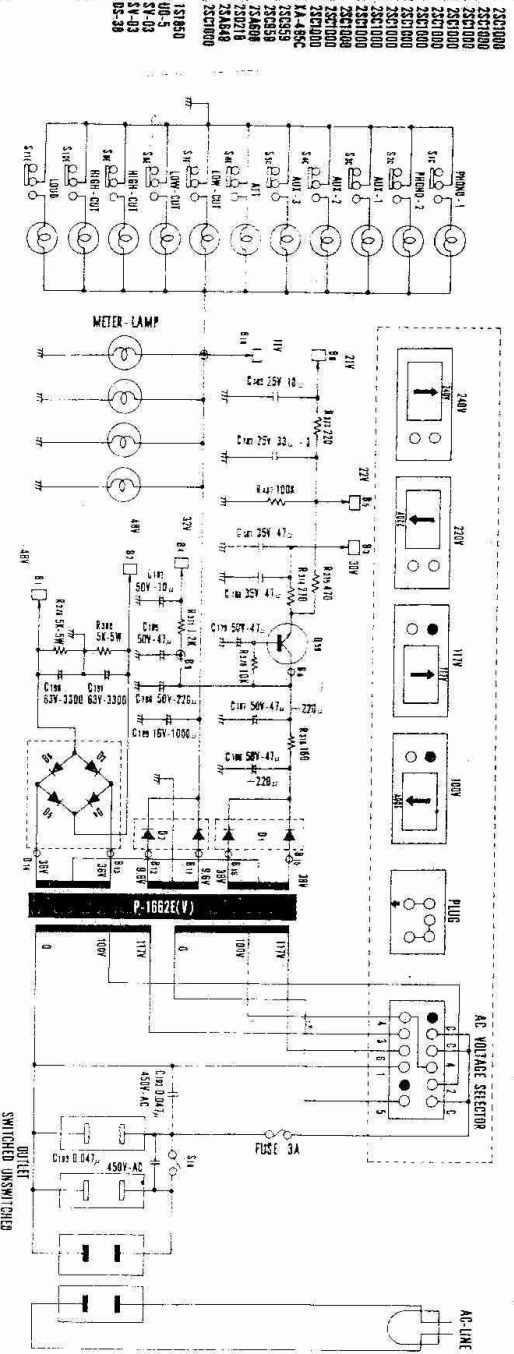

2S2CT1000
2S2CT1002
2S2CT1004
2S2CT1006
2S2CT1008
2S2CT1010
2S2CT1012
2S2CT1014
2S2CT1016
2S2CT1018
2S2CT1020
2S2CT1022
2S2CT1024
2S2CT1026
2S2CT1028
2S2CT1030
2S2CT1032
2S2CT1034
2S2CT1036
2S2CT1038
2S2CT1040
2S2CT1042
2S2CT1044
2S2CT1046
2S2CT1048
2S2CT1050
2S2CT1052
2S2CT1054
2S2CT1056
2S2CT1058
2S2CT1060
2S2CT1062
2S2CT1064
2S2CT1066
2S2CT1068
2S2CT1070
2S2CT1072
2S2CT1074
2S2CT1076
2S2CT1078
2S2CT1080
2S2CT1082
2S2CT1084
2S2CT1086
2S2CT1088
2S2CT1090
2S2CT1092
2S2CT1094
2S2CT1096
2S2CT1098
2S2CT1100
2S2CT1102
2S2CT1104
2S2CT1106
2S2CT1108
2S2CT1110
2S2CT1112
2S2CT1114
2S2CT1116
2S2CT1118
2S2CT1120
2S2CT1122
2S2CT1124
2S2CT1126
2S2CT1128
2S2CT1130
2S2CT1132
2S2CT1134
2S2CT1136
2S2CT1138
2S2CT1140
2S2CT1142
2S2CT1144
2S2CT1146
2S2CT1148
2S2CT1150
2S2CT1152
2S2CT1154
2S2CT1156
2S2CT1158
2S2CT1160
2S2CT1162
2S2CT1164
2S2CT1166
2S2CT1168
2S2CT1170
2S2CT1172
2S2CT1174
2S2CT1176
2S2CT1178
2S2CT1180
2S2CT1182
2S2CT1184
2S2CT1186
2S2CT1188
2S2CT1190
2S2CT1192
2S2CT1194
2S2CT1196
2S2CT1198
2S2CT1200

151050
151055
151060
151065
151070
151075
151080
151085
151090
151095
151100
151105
151110
151115
151120

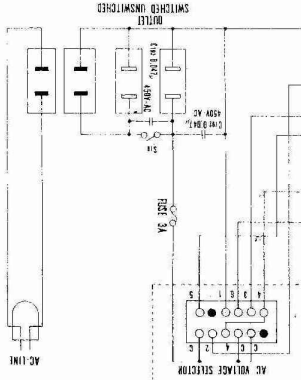
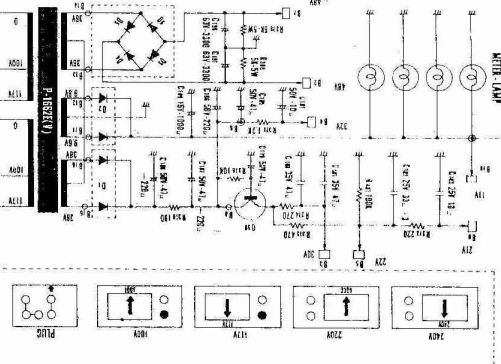
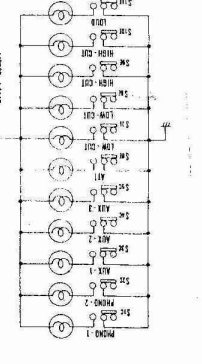

RIGHT CHANNEL

