

41



**SERVICE
MANUAL**

2220B



marantz

model 2220B

Stereophonic Receiver

TABLE OF CONTENTS

SECTION	PAGE
Introduction	1
Service Notes	1
AM Tuner	1
FM Tuner	1
Phono and Pre-amplifier	3
Main Amplifier	4
Audio Trouble Analysis	4
Test Equipment Required for Servicing	5
AM Alignment Procedure	5
FM Alignment Procedure	6
Stereo Separation Alignment	6
Muting Threshold Adjustment	6
Power Amplifier Adjustment	6
Power Supply Adjustment	6
Service Information for European Model	28

LIST OF ILLUSTRATIONS

FIGURE	PAGE
1. Dial Stringing	4
2. Front Panel Adjustment and Component Locations	7
3. Main Chassis Component Locations (Top View)	7
4. Rear Panel Adjustment and Component Locations	8
5. Main Chassis Component Locations (Bottom View)	8
6. FM Front End and AM Tuner Assembly P100 Component Locations	9
7. FM IF Amplifier, Detector, Muting Control and Meter Amplifier Unit Assembly P200 Component Locations	9
8. MPX Stereo Decoding Amplifier Assembly P300 Component Locations	10
9. Phono Amplifier Assembly P400 Component Locations	10
10. Power Amplifier Assembly P700 Component Locations	11
11. Power Supply Assembly P800 Component Locations	11
12. Dial Lamp Assembly PZ01 Component Locations	12
13. Tone Amplifier Assembly P500 Component Locations	12
14. Filter Assembly PH01 Component Locations	13
15. Main Remote Assembly PT01 Component Locations	13
16. Exploded Mechanical Diagram	14
17. Schematic Diagram	16
18. Rear Panel Adjustments and Facilities Locations for European Model	29
19. Main Chassis Component Locations (Bottom View) for European Model	29
20. Voltage Conversion Chart	30
21. Schematic Diagram for European Model	31

INTRODUCTION

This service manual was prepared for use by Authorized Warranty Stations and contains service information for Marantz Model 2220B Stereophonic Receiver.

Servicing information and voltage data included in this manual are intended for use by the knowledgeable and experienced technician only. All instruction should be read carefully. No attempt should be made to proceed without a good understanding of the operation in the receiver.

The part lists furnish information by which replacement part may be ordered from the Marantz Company. A simple description is included for parts which can be usually be obtained through local suppliers.

1. SERVICE NOTES

As can be seen from the circuit diagram, the chassis of Model 2220B consists of the following units. Each unit mounted on a printed circuit board is described within the square enclosed by a bold dotted line on the circuit diagram.

- | | |
|---|------------------------|
| 1. FM Front End & AM Tuner | mounted on P.W.B. P100 |
| 2. FM IF Amplifier, Detector, Muting Control | mounted on P.W.B. P200 |
| 3. MPX Stereo Decoding Amplifier | mounted on P.W.B. P300 |
| 4. Phono Amplifier | mounted on P.W.B. P400 |
| 5. Tone Amplifier | mounted on P.W.B. PE01 |
| 6. TAPE Montor, Mono, Low and High Filter Switch Unit | mounted on P.W.B. PH01 |
| 7. Loudness, Muting, Main and Remote Switch Unit | mounted on P.W.B. PT01 |
| 8. Power Amplifier | mounted on P.W.B. P700 |
| 9. Power Supply | mounted on P.W.B. P800 |
| 10. Dial Lamp Unit | mounted on P.W.B. PZ01 |

2. AM TUNER

All components except ferrite bar antenna are mounted on a printed circuit board P100.

The AM signals induced in a ferrite bar antenna are applied to the RF amplifier section of the AM tuner IC H104 through a capacitor of C129 and amplified to the level required for overcoming the conversion noises, thus giving good S/N performance. The tuned circuits inserted in both out and input circuit of the RF amplifier assure very high image and spurious rejection performance. Thus amplified and selected AM signals are then applied to the converter section through a coupling capacitor C132. While the local oscillator voltage is injected through a capacitor C131, both AM signals and oscillating voltage are mixed and converted into 455KHz intermediate frequency. The resulting IF signal is applied to the first IF transformer L110 consisting of one ceramic filter and two tuned circuits.

The output of L110 is led to the IF amplifier/detector section of H104. The detected audio signal is obtained from PIN 11 of H104 and amplified to a required level (about 470 mV for 400Hz 30% mod.) by the amplifier H105 and fed to the function switch.

2.1 Suggestions for AM Tuner Trouble Shooting

Check for broken AM bar antenna, next connect an oscilloscope to the pin 11 of H104 or J112 and check for audio signals with the tuning meter deflected. If detected audio signal is obtained at pin 11 of H104, no failure may exist in the AM tuner IC H104 and its associated circuit. If no audio signal is obtained at pin 11 of H104, check all voltage distribution in the AM circuits by using a DC VTVM.

3. FM TUNER

The FM Tuner section of Model 2220B is divided into three functional blocks: FM front end, IF amplifier & Detector, Muting control and MPX stereo decoding circuit.

FM signals induced on a FM antenna are led to FM antenna coil L101 through a balun coil. These signals are then applied to the FET RF amplifier which in turn applies its output to the next Transistor Mixer H102 through the double tuned high selective circuits. The Mixer convert its input signal into 10.7MHz intermediate frequency and amplifies it at the same time. The H103 is a local oscillator and its output is injected into the base of Mixer transistor, the injection voltage is about 50mV. The 10.7MHz front end IF output is led to the next IF amplifier unit through a coaxial cable.

The IF amplifier unit consists of five stages of IF amplifiers. Two pieces of ceramic filters are used to obtain high selectivity a pair of symmetrical diode limiter is also employed for the best limiting characteristics, improved capture ratio and good AM suppression.

A part of IF amplifier H202 is rectified by the diodes H211 and H212 and its DC output is fed back to the gate of FET RF amplifier to decrease the gain of it with increased input signal strength.

3-1. Muting and Auto-Stereo Switching Circuits

The muting circuit consisting of all solid-state electrical switching has been incorporated in the Model 2220B.

The DC voltage obtained by rectifying the sub IF output signal from the H206 is applied to the base of H207 and turns on it, if the sub IF output is greater than predetermined level (muting threshold level).

When the H207 turns on, the muting switch transistor H208 is turned on, thus decreasing the emitter collector resistance to near zero ohm and allowing emitter current path to the Final IF amplifier H205.

When the input signal is lower than the predetermined level, the DC output obtained is small and can not turn on the H207 thus the H207 keeps its turn off state and this makes the switch transistor keep H208 turn off, then no emitter current is supplied to the H205 and signals below the threshold level are muted out.

The muting threshold level can be varied by adjusting the trimming resistor R253.

The DC voltage obtained is also used to make the Auto-Stereo switching transistor H209 turn on and off.

3-2. MPX Stereo Decoding Circuit

The stereo composite signal from the FM detector undergoes a phase compensation by R303 and C304, is applied to the input terminal pin 2 of the MPX stereo decoding IC H301 on a PLL (Phase Locked Loop) basis, and decoded into the left and right stereo signals, which become available at pins 4 and 5 respectively. These decoded left and right stereo audio signals are introduced through a low pass filter composed of L301 to L304 and C309 to C318 for elimination of undesirable residual switching signal and through a de-emphasis network consisting of R314, R315, C319 and C320, into the npn-pnp direct coupled audio amplifier, where the signals are amplified to a required level for the output from J307 and J308. From these terminal the audio signals are led to the TAPE OUTPUT jacks through the function switch. Figure 1 presents an internal block diagram showing the functions of the PLL basis MPX stereo decoding IC HA1156. The input stereo composite signal, amplified by the audio amplifier, is delivered to the phase detectors PD-1 and PD-2. A part of the stereo composite signal is also applied to the stereo decoder section. The VCO (Voltage Control Oscillator) produces a free run oscillation in the neighborhood of 76KHz with the time constant determined by a capacitor C303 and resistors R304 and R305 set on the outside of pin 14. The VCO output has its frequency divided into 19KHz through the two stages of the frequency divider (DIV-1 & DIV-2), and is reverted to the phase detector PD-1, which contains two input terminals designed to produce an output in proportion to the product of the two input signals. The signal applied to one of the inputs of PD-1 is the 19KHz square wave formed through frequency division of the 76KHz VCO output signal by the two stages of the frequency divider

DIV-1 and DIV-2, and the 19KHz pilot signal included in the stereo composite signal as a reference signal is applied to the other input. Therefore, the output of PD-1 which has passed through the low pass filter LPF-1 provides DC output voltage in proportion to the phase variance between the two inputs. This DC output voltage is amplified by the DC amplifier, and supplied to the 76KHz VCO as a control voltage. This means that the output frequency and phase of the VCO have been phase-locked to the input pilot signal. The 38KHz sub-carrier reproduced by PLL as stated above is delivered through the stereo switch to the stereo decoder section as a switching signal, thus driving the decoder section. One of the inputs of PD-2 is given the 19KHz resulting from the frequency division completed by DIV-1 and DIV-3, whereas the other input gets the 19KHz output contained in the composite signal, and the output is provided with a DC output in proportion to the amplitude of the pilot signal. This DC output is furnished through LPF-2 to the trigger amplifier which drives the stereo indicator lamp and stereo switch. Therefore, insufficient supply of the pilot signal results in failure to light the stereo indicator and to turn on the stereo switch located in the path of the 38KHz switching signal, thereby avoiding a wrong stereo operation. H303 attached on the outside of pin 8 is a switching transistor for automatic monaural-stereo switchover. When the intensity of an incoming signal from an FM station is weaker than a predetermined level, this H303 is turned on and pin 8 is grounded, thereby developing a condition for monaural reception. For a forced monaural operation, switch the MODE switch to "NONO," an H303 comes into an "On" condition with the positive bias voltage applied to the base, and pin 8 is grounded, thereby establishing monaural operation. The transistor H302 connected externally to pin 14 is intended to stop the 76KHz oscillation of the VCO which interferes an AM signal during the reception of an AM station. When the function switch is set to "AM" position, a positive bias is charged on the base of H302, H302 is turned on, and pin 14 is grounded. Thus, the oscillation of the VCO is stopped, ending the interference with AM reception.

3.3 Suggestion for Trouble Shooting of FM Tuner

3.3.1 Symptom: No FM Reception

First turn ON the power switch and try to tune FM stations. Rotate the fly-wheel tuning knob slowly and observe the FM tuning meter. If the tuning meter deflects at several frequencies received, the tuner circuits preceding the discriminator circuit may have no failure. When no reading is obtained in the meter, check FM local oscillator circuit, using a RF VTVM. The normal local oscillator voltage is one or two volts (rms) at the tuning capacitor, depending on the tuning capacitor position. If the local oscillator voltage is normal, next check all voltage distributions in the FM Front End and IF amplifier unit and compare them with those shown in the circuit diagram. When the tuning meter deflects but no sound is obtained, check audio circuits, using a high sensitive oscilloscope.

3.3.2 Symptom: No Stereo Separation

First check the "MONO" switch is in normal out position. Connect a FM RF signal generator output modulated by a stereo modulator to the rear FM antenna terminals, and check the stereo beacon is turned on or not. If not turned on, check for 19KHz VCO output signal (R312 Test Point), using an oscilloscope and a frequency counter.

4. PHONO AND PRE-AMPLIFIER

Signals from the tuner and AUX jacks are applied to the selector switch. Signals from the PHONO jacks are applied to the phono-amplifier consisting of transistor H401, H403 and H405. The gain of the amplifier is 40 dB. The amplified and equalized phono-signals are, then, fed to other section of the selector switch which, in turn, applies output signals from the tuner, phono-amplifier and AUX jacks to the TAPE 1 MONITOR switch and TAPE OUT 1 jacks. The TAPE 1 MONITOR switch applies the signals to the balance and volume controls.

The controlled signals are fed to the pre-amplifier consisting of HE01, HE03 and HE05,

HE07. Frequency response of the amplifier can be varied by BASS, MID and TREBLE controls. The controlled output are then led to the main amplifier through high and low pass filter pushswitches.

5. MAIN AMPLIFIER

Transistor H701 and H703 are a differential amplifier coupled to the transistor H707. Transistor H707 drives the inverter transistors H721 and H723 which, in turn, drive the power stage consisting of H001 and H002. Transistors H709 and H721 are current limiters and operate as power protecting circuits.

Excessive currents flowing into the power stage are detected by the resistors R749 and R747 and the resultant variations are applied to the transistors H709 and H711 and make them turned on. This decreases the current flowing into the H721 and H723. In this way the currents flowing in the power stage (H001 and H002) are restricted within a safe value.

6. AUDIO TROUBLE ANALYSIS

- | | |
|--|--|
| <ol style="list-style-type: none"> 1. Excessive line consumption 2. No line consumption or zero bias 3. High hum and noise level 4. Parastic oscillation 5. Improper clipping | <ol style="list-style-type: none"> a. Check for shorted rectifiers H801, H802. b. Check for shorted transistors H001, H002, Check L005 for short. a. Check line cord, fuse, shorted H005, H006, H725. b. Check for open rectifiers H801, H802 or open L005. a. Check filter capacitors C002, C004. a. Check for defective capacitors, C707, C708, C715, C716. a. Check for proper adjustment of R711, R712. |
|--|--|

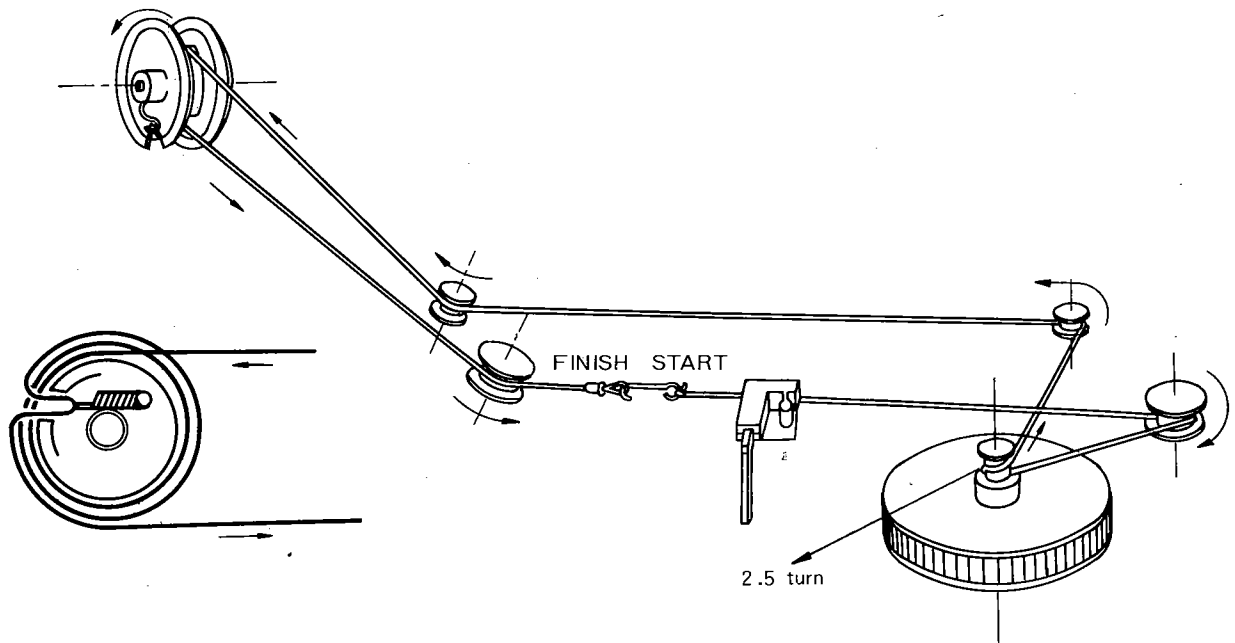

Figure 1. Dial Stringing

7. TEST EQUIPMENT REQUIRED FOR SERVICING

Table 1 lists the test equipment required for servicing the Model 2220B Receiver.

Item	Manufacturer and Model No.	Use
AM Signal Generator		Signal source for AM alignment
Test Loop		Use with AM Signal generator
FM Signal Generator	Less than 0.3% distortion	Signal source for FM alignment
Stereo Modulator	Less than 0.3% distortion	Stereo Separation alignment and trouble shooting
Audio Oscillator	Weston Model CVO-100P, less than 0.02% residual distortion is required.	Sinewave and squarewave signal source.
Frequency Counter		MPX Oscillator adjustment (VCO)
Oscilloscope	High sensitivity with DC horizontal and vertical amplifiers.	Waveform analysis and Trouble Shooting, and ASO alignment.
VTVM	With AC, DC, RF range	Voltage measurements.
Circuit Tester		Trouble Shooting
AC Wattmeter	Simpson, Model 390	Monitors primary power to Amplifier.
AC Ammeter	Commercial Grade (1-10A)	Monitors amplifier output under short circuit condition.
Line Voltmeter	Commercial Grade (0-150VAC)	Monitors potential of primary power to amplifier.
Variable Autotransformer (0-140VAC, 10 amps.)	Powerstat, Model 116B	Adjusts level of primary power to amplifier.
Shorting Plug	Use phono plug with 600 ohm across center pin and shell.	Shorts amplifier input to eliminate noise pickup.
Output Load (8 ohms, 0.5%, 100W)	Commercial Grade	Provides 8-ohm load for amplifier output termination.
Output Load (4 ohms, 0.5%, 100W)	Commercial Grade	Provides 4-ohm load for amplifier output termination.

8. AM ALIGNMENT PROCEDURE

AM IF Alignment

1. Connect a sweep generator to the J106 and an alignment scope to the resistor R120 (out side).
2. Rotate each core of IF transformers L110 and L111 for the maximum height and flat top symmetrical response.

AM Frequency Range and Tracking Alignment

1. Set AM signal generator to 515 KHz. Turn the tuning capacitor fully closed (place the tuning pointer at the low end) and adjust the oscillator coil L109 for maximum audio output.
2. Set the signal generator to 1650 KHz. Place the tuning pointer in the high frequency end and adjust the oscillator trimmer on the oscillator tuning capacitor for maximum audio output.
3. Repeat step 1 and 2 until no further adjustment is necessary.
4. Set the generator to 600 KHz, tune the receiver to the same frequency and adjust a slug core of AM ferrite rod antenna and RF coil L108 for maximum output.
5. Set the generator to 1400 KHz and tune the receiver to the same frequency and adjust both trimming capacitor of antenna and RF tuned circuit for maximum output.

6. Repeat procedures 4 and 5 until no further adjustment is necessary.

Note: During tracking alignment reduce the signal generator output as necessary to avoid AGC action.

9. FM ALIGNMENT PROCEDURE

1. Connect a FM signal generator to the FM antenna terminals and an oscilloscope and an audio distortion analyzer to the tape output jack on the rear panel.
2. Set the FM SG to 87 MHz and provide about 3 to $5\mu\text{V}$. Place the tuning pointer at the low frequency end by rotating the tuning knob and adjust the core of oscillator coil L104 to obtain maximum audio output.
3. Set the FM SG to 109 MHz and provide about 3 to $5\mu\text{V}$. Rotate the tuning knob and place the tuning pointer at the high frequency end and adjust the trimming capacitor C118 for maximum output.
4. Repeat steps 2 and 3 until no further adjustment is necessary.
5. Set the FM SG to 90 MHz and tune the receiver to the same frequency. Decrease signal generator output until the audio output level decreases with the decreasing generator output. Adjust the ANTENNA coil L101, RF coil L102 and L103 and IF transformer L105 for minimum audio distortion.
6. Set the FM SG to 106 MHz and tune the receiver to the same frequency. Decrease the signal generator output until the audio output level decreases with the decreasing generator output. Adjust the trimming capacitors of ANTENNA and RF tuning circuits for minimum distortion.
7. Repeat steps 5 and 6 until no further adjustment is necessary.
8. Connect a DC VTVM with 1 V range selected to the resistor R237 (inside) and adjust the secondary core (black) of discriminator transformer L201 so that no voltage reading is obtained on the VTVM at no signal. Next set the FM SG to 98 MHz and increase the output level 1 $\text{K}\mu\text{V}$, then tune the receiver to the same frequency so that no deflection is obtained on the VTVM. Adjust primary core (pink) of L201 for minimum distortion.

10. STEREO SEPARATION ALIGNMENT

1. Set the FM SG to provide 1 $\text{K}\mu\text{V}$ at 98 MHz. Tune the receiver to the same frequency so that the center tuning meter pointer indicates its center. Then turn off the modulation of the FM SG, connect a frequency counter to test point R312 (point C) and adjust R 304 so that the frequency counter may precisely read 19 KHz.
2. Modulate the FM SG with stereo composite signal consisting of only L or R channel (of course a pilot signal must be included).
3. Adjust the trimming resistor R 303 for maximum and same separation in both channels.

11. MUTING THRESHOLD ADJUSTMENT

1. Set the FM SG output to provide $12.5\mu\text{V}$ (IHF) at 98 MHz and tune receiver to the same frequency. Adjust the trimming resistor R 253 for the threshold level of $12.5\mu\text{V}$. (During this adjustment turn the MUTING pushswitch "on".)

12. POWER AMPLIFIER ADJUSTMENT

Connect a VTVM between J712(+) and J718(-) and adjust the trimming resistor R733 until the VTVM reads 20 mV DC. And next, connect a VTVM between J723 and J722 (GROUND) and adjust the trimming resistor R711 until the VTVM reads 0 mV DC. Do over again. For the other channel, connect the VTVM between J713(+) and J719(-) and adjust the R734 for the same reading, and connect the VTVM between J724 and J722 and adjust the R712 for the same reading. Do over again.

13. POWER SUPPLY ADJUSTMENT

Connect a VTVM between J812(+) and J811(-) and adjust R808 until the VTVM reads 35.0 V under no signal condition.

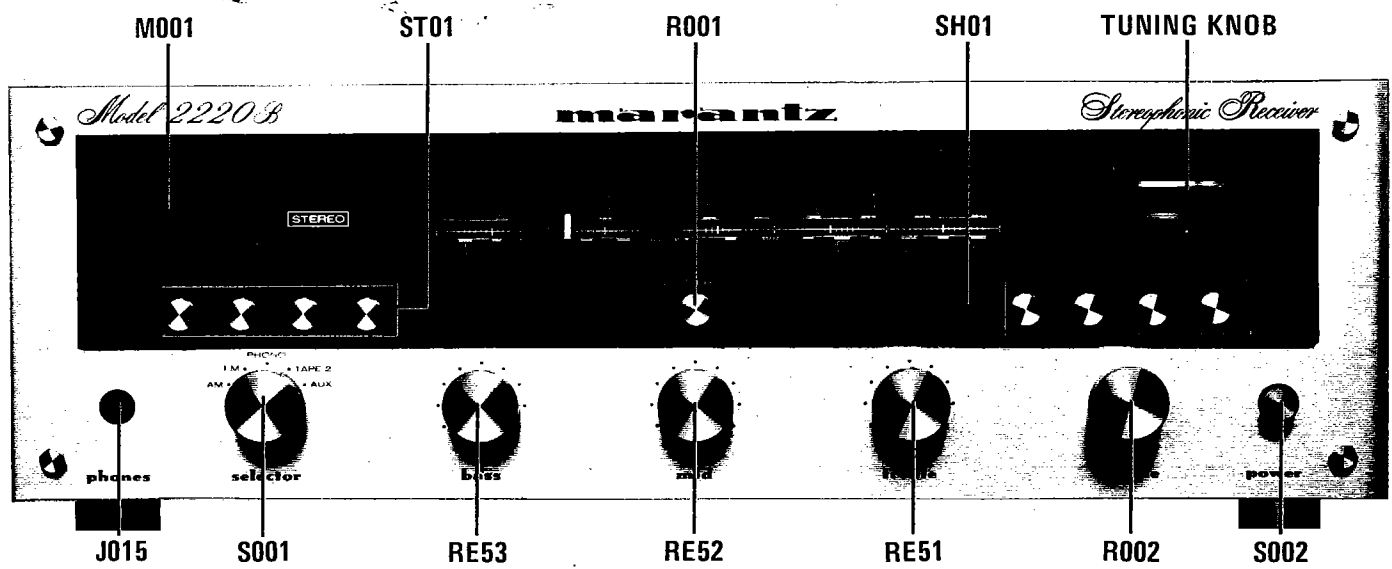

Figure 2. Front Panel Adjustments and Component Locations

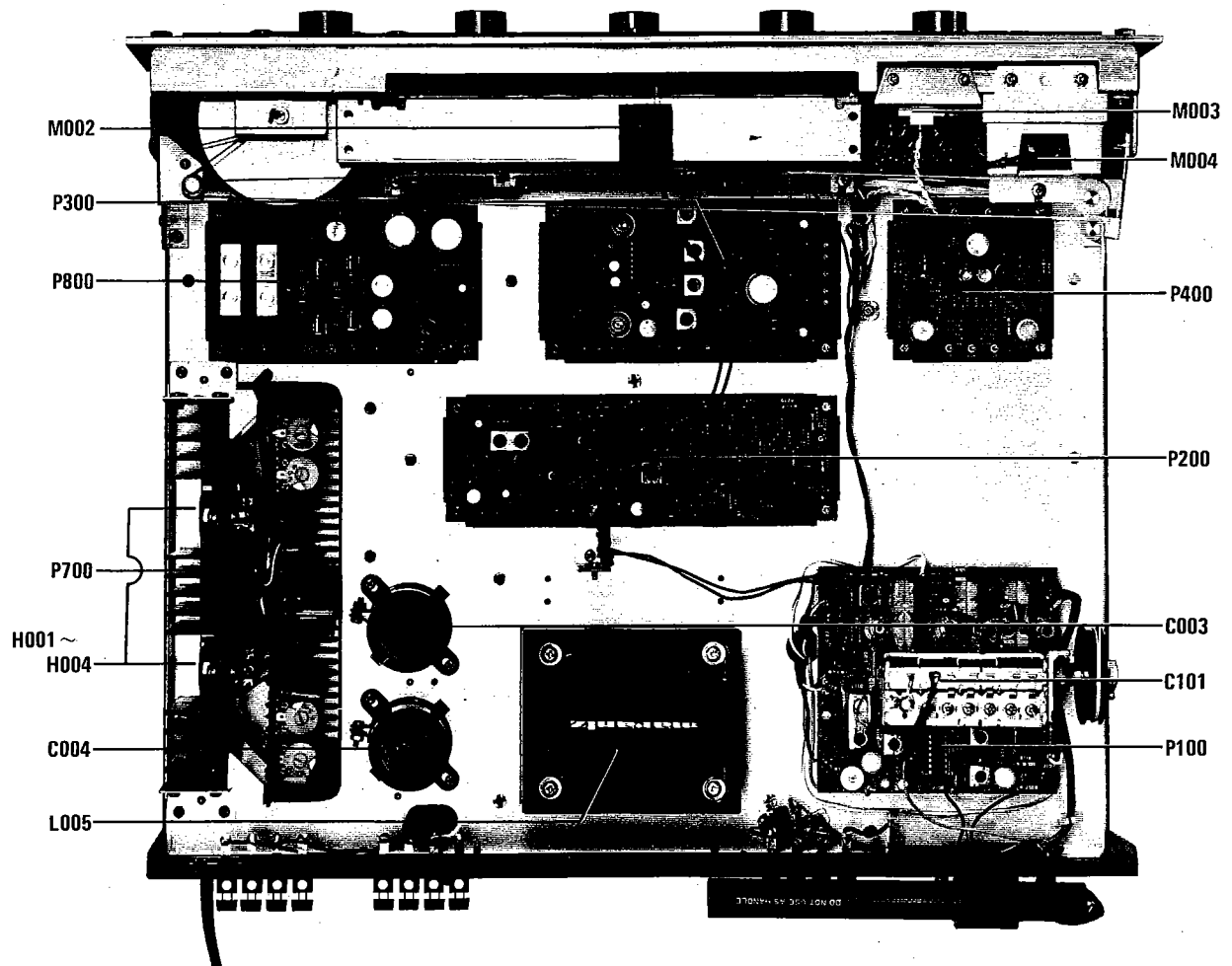

Figure 3. Main Chassis Component Locations (Top View)

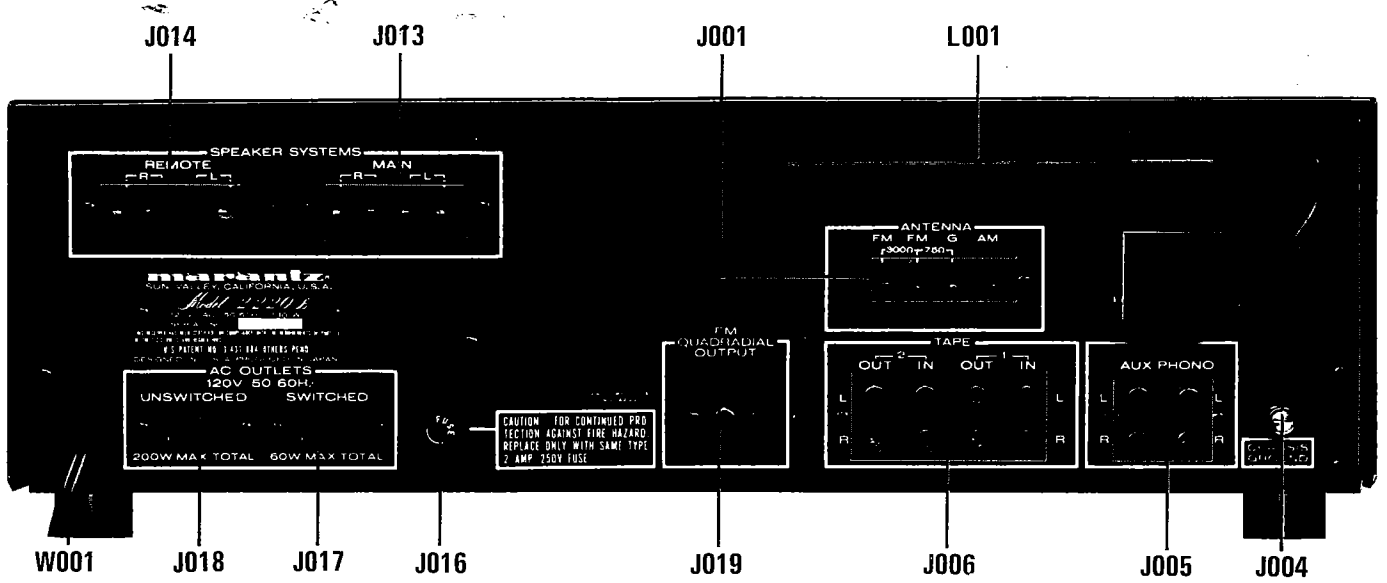

Figure 4. Rear Panel Adjustment and Component Locations

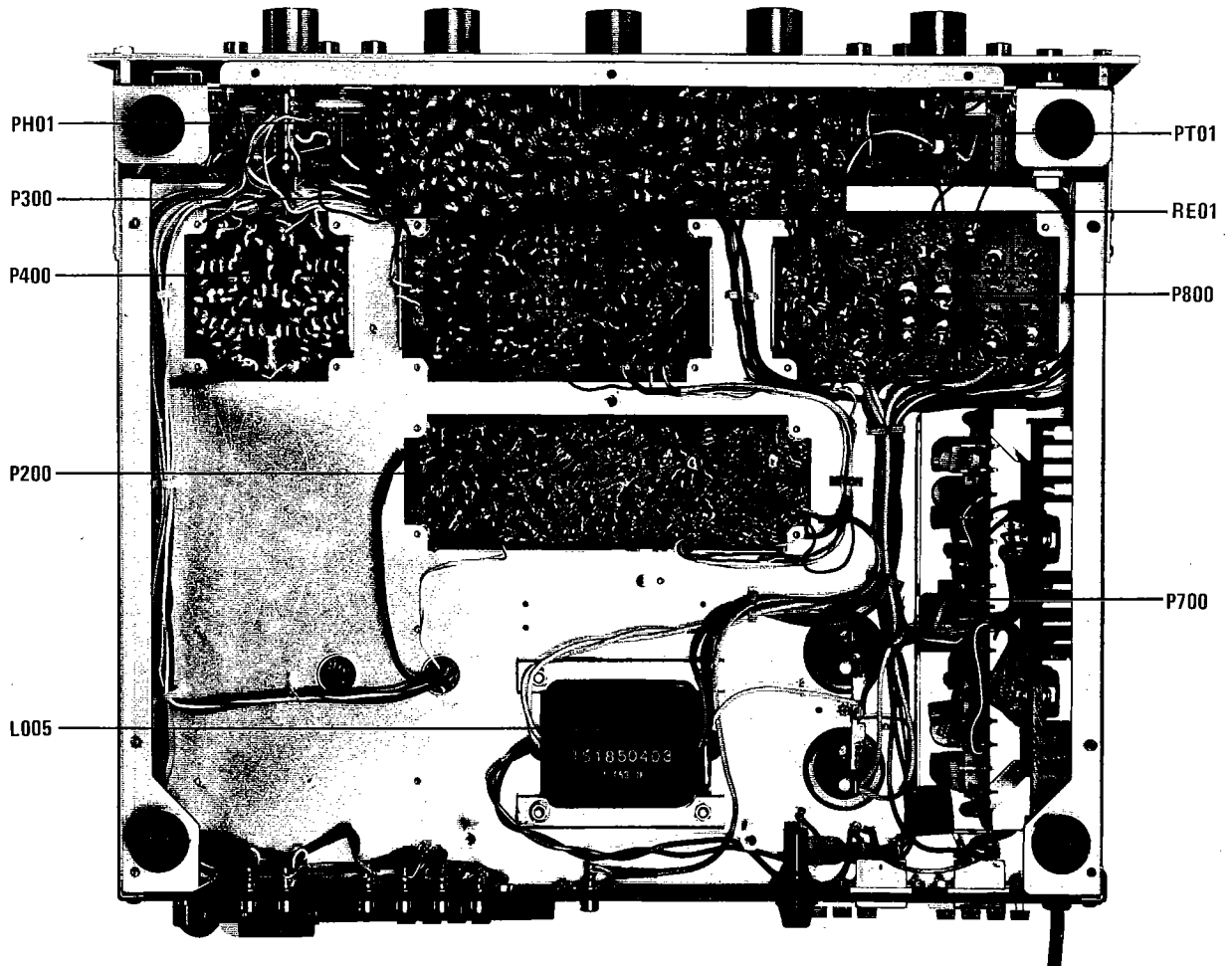

Figure 5. Main Chassis Component Locations (Bottom View)

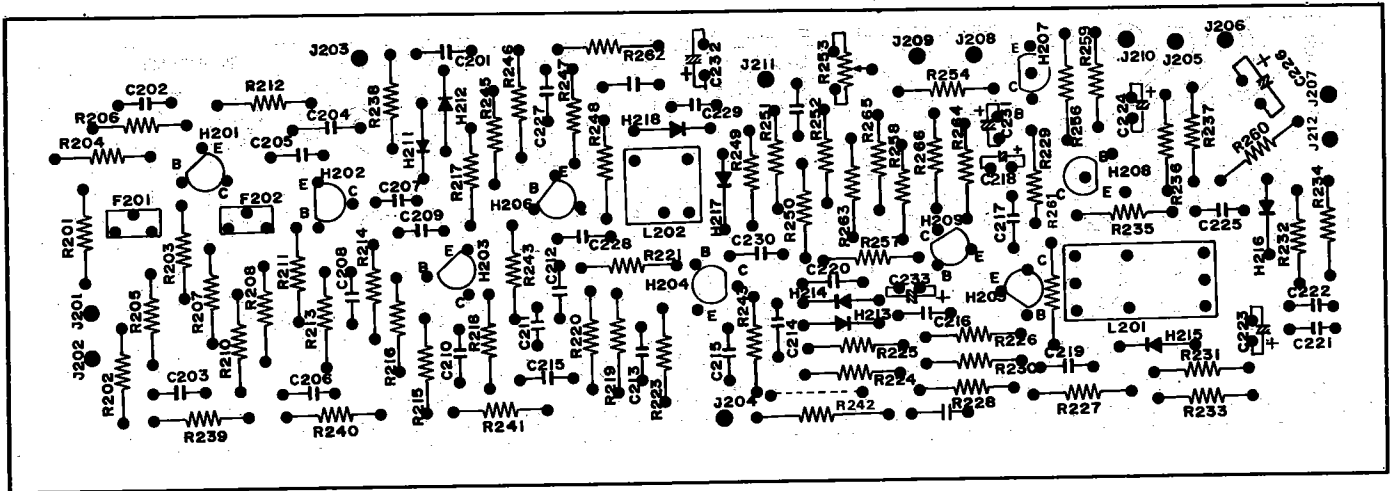

Figure 6. FM Front End and AM Tuner Assembly P100 Component Locations

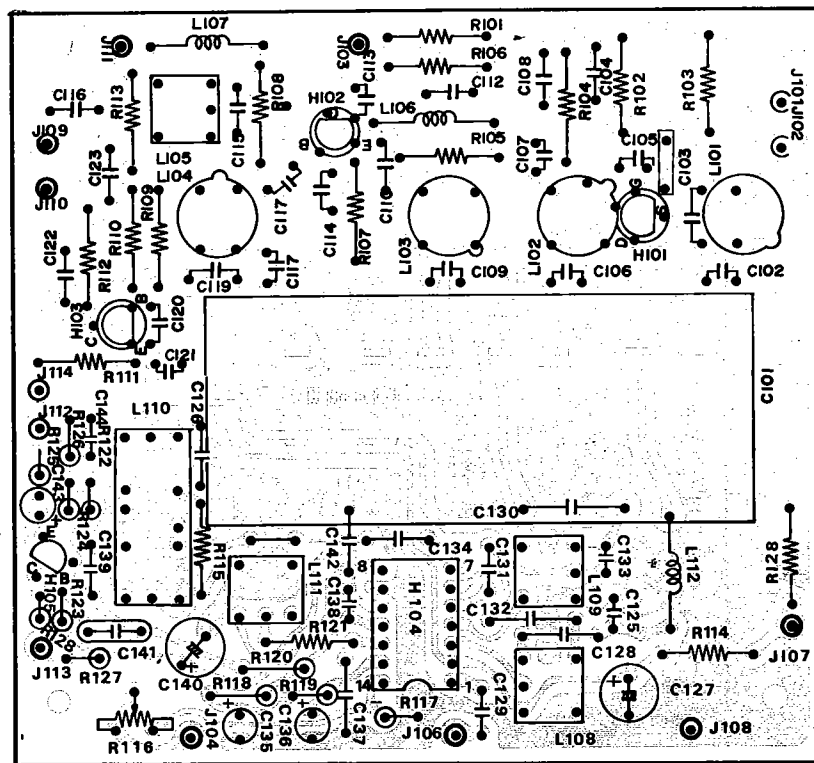

Figure 7. FM IF Amplifier, Detector, Muting Control and Meter Amplifier Unit Assembly P200 Component Locations

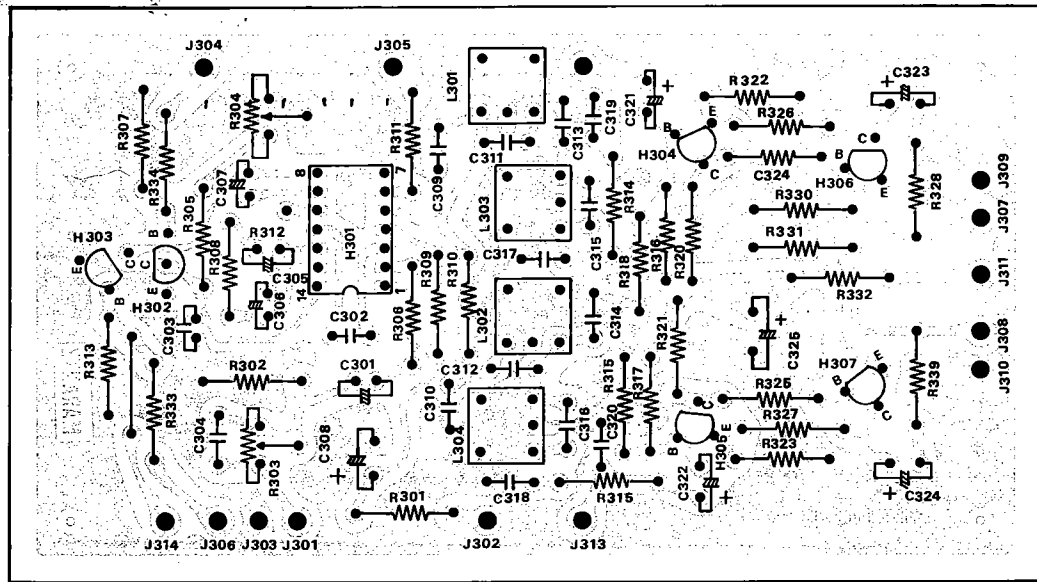

Figure 8. MPX Stereo Decoding Amplifier Assembly P300 Component Locations

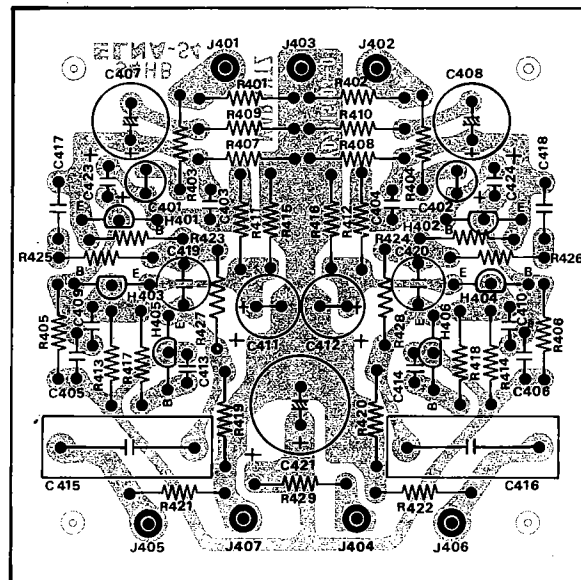

Figure 9. Phono Amplifier Assembly P400 Component Locations

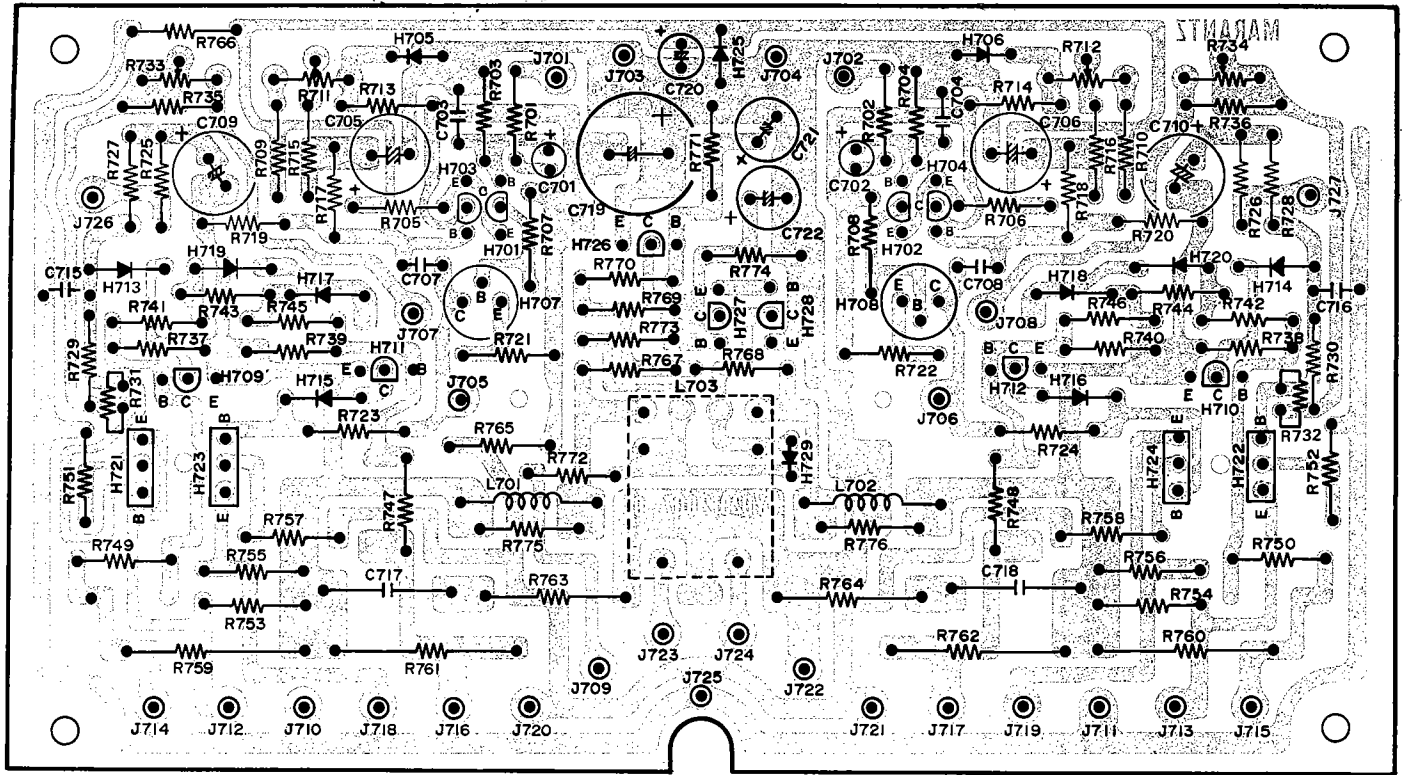

Figure 10. Power Amplifier Assembly P700 Component Locations

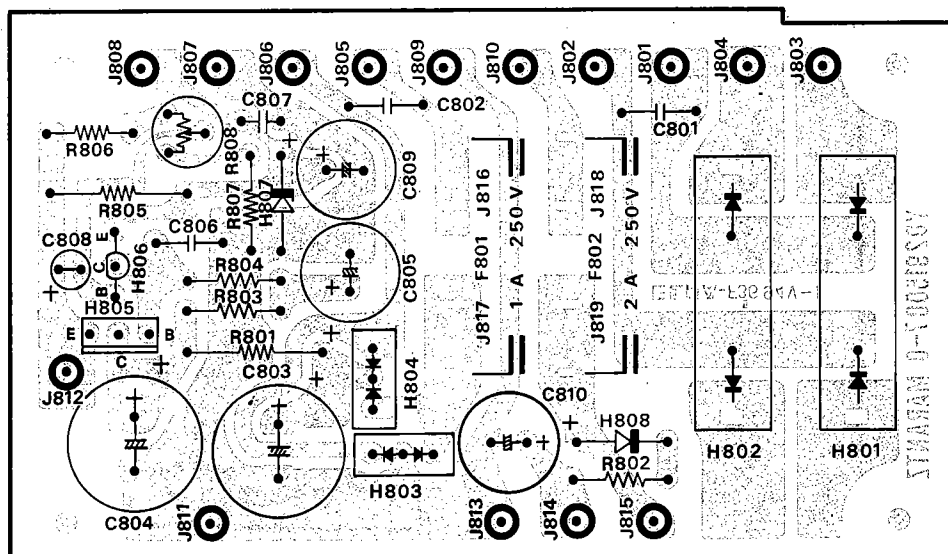

Figure 11. Power Supply Assembly P800 Component Locations

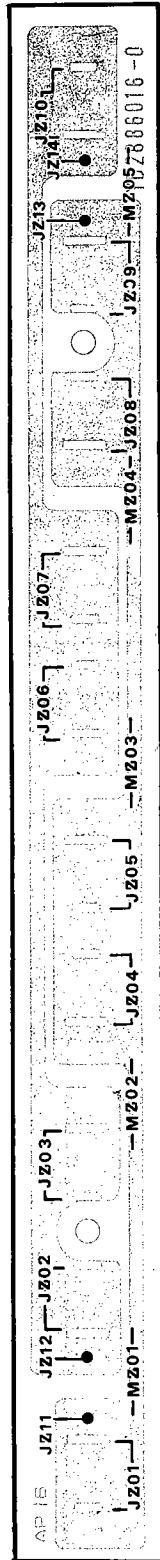

Figure 12. Dial Lamp Assembly PZ01 Component Locations

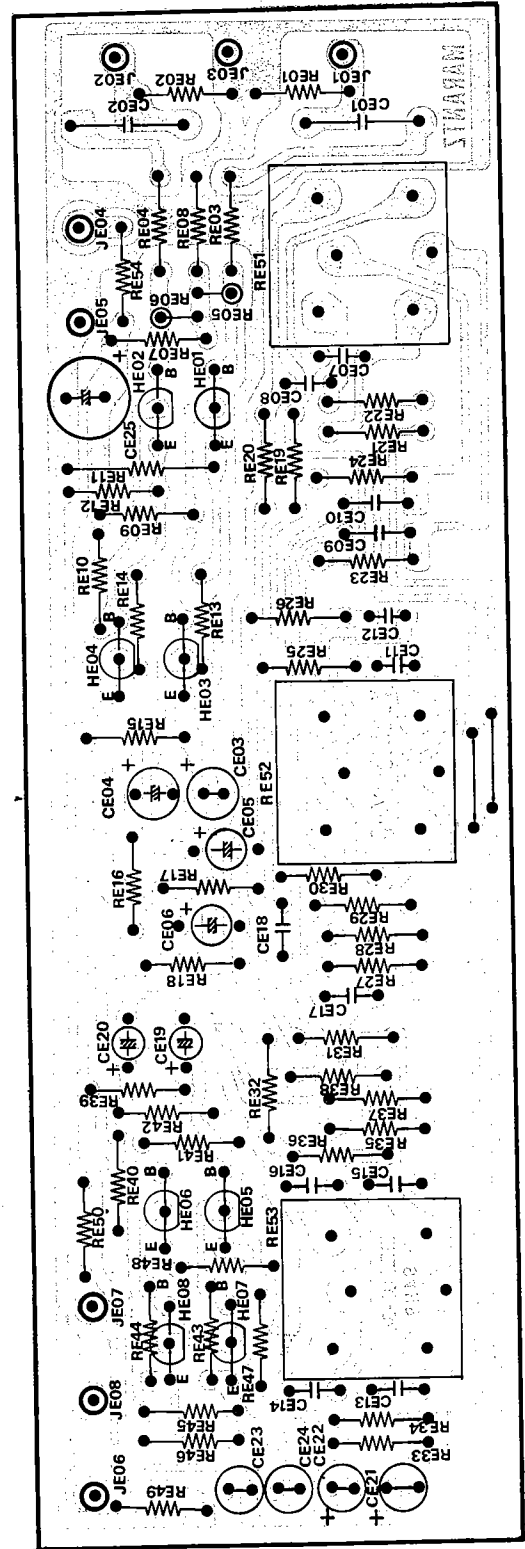

Figure 13. Tone Amplifier Assembly P500 Component Locations

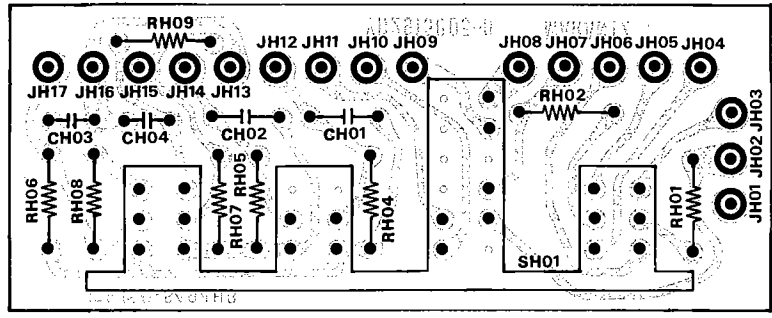

Figure 14. Filter Assembly PH01 Component Locations

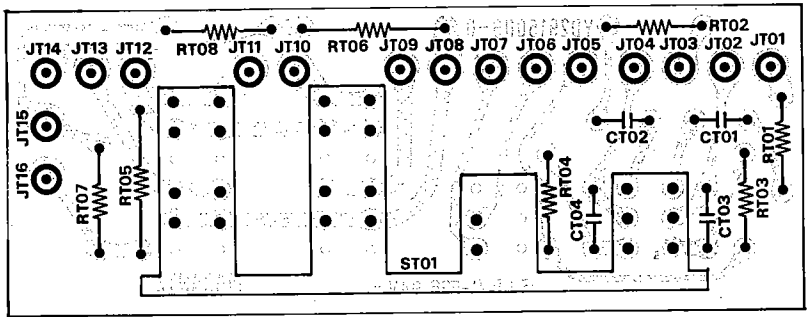

Figure 15. Main Remote Assembly PT01 Component Locations

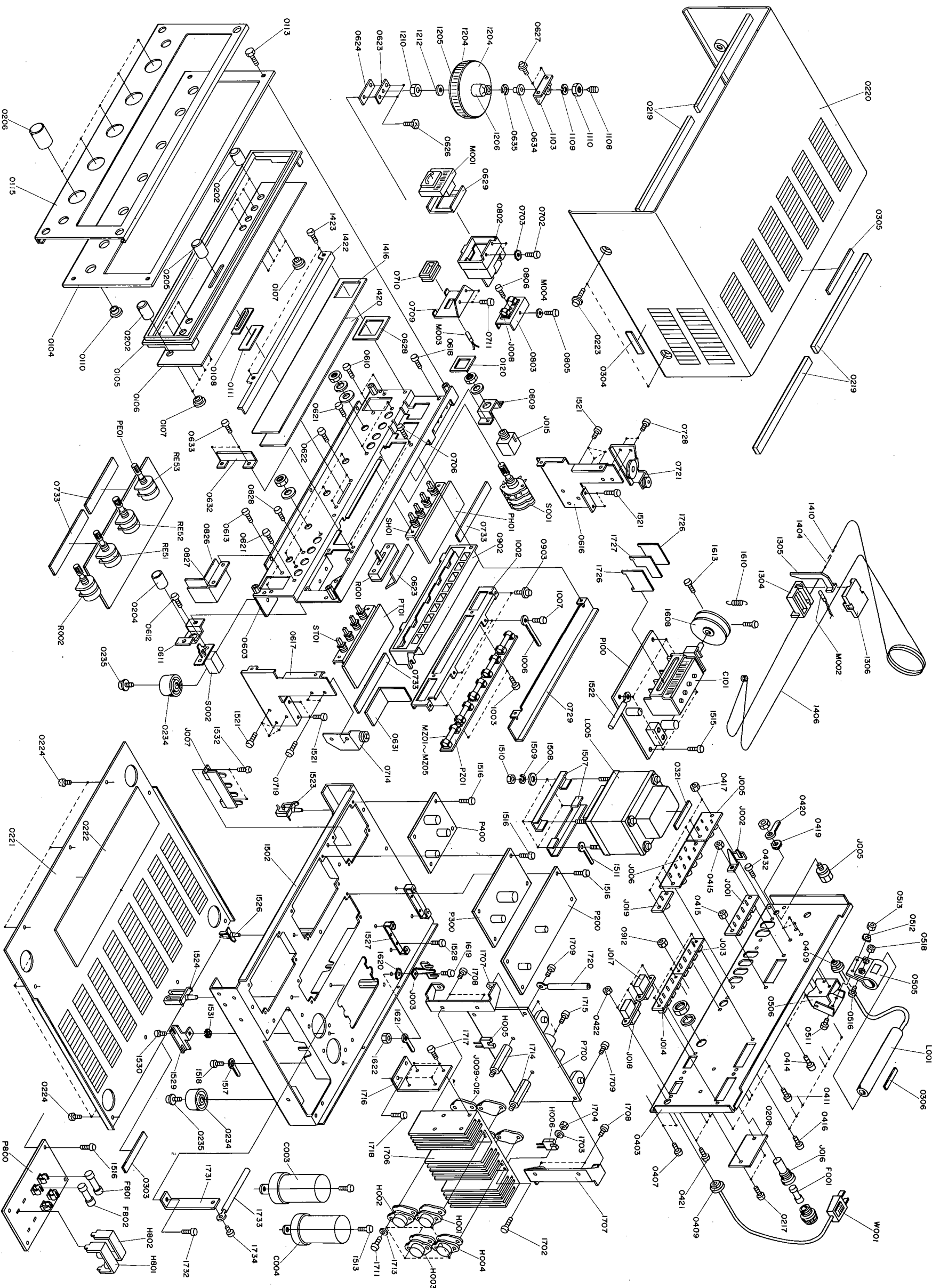

Figure 16. Exploded Mechanical Diagram

Parts List

U: For U.S.A.
E: For Europe

U: For U.S.A.
E: For Europe

REF. DESIG.	U	E	PART NO.	DESCRIPTION
A	1	1	291506340	Front Panel Assembly
0104	1	1	291506301	Escutcheon
0105	1	1	285340101	Frame
0106	1	1	291515801	Window
0107	8	8	288625901	Bush
0108	1	1	285425901	Bush
0110	1	1	281835905	Bush
0111	1	1	291510701	Sheet
0115	1	1	291505301	Cover
B	1	1	285327340	Fly Wheel Assembly
1204	2	2	257706302	Escutcheon
1205	1	1	257727301	Fly Wheel
1206	1	1	285311201	Shaft
1210	1	1	53110603E	Hexagon Nut
1212	1	1	54020601E	Flat Washer
C	1	1	291510340	Pointer Assembly
1304	1	1	291510301	Pointer
1305	1	1	281810302	Pointer
1306	1	1	291510302	Pointer
M002	1	1	IN1008030	Lamp
D	1	1	120200640	Hook Assembly
1404	1	1	120225801	Hook
1406	1	1	72080802A	String
E	1	1	281915941	Drum Assembly
1608	1	1	281915901	Drum
1610	1	1	71101569M	Spring
1613	2	2	51060419A	Set Screw
P100	1	1	YD2888003	P100 FM TUNER
			ZZ2915103	P W Board, FM-AM Front End Board
			ZZ2915803	P W Board Assembly
R101	1	1	RT0522314	Resistor 22KΩ ±5% ¼W
R102	1	1	RT0510414	Resistor 100KΩ ±5% ¼W
R103	1	1	RT0510514	Resistor 1MΩ ±5% ¼W
R104	1	1	RT0522114	Resistor 220Ω ±5% ¼W
R105	1	1	RT0547214	Resistor 4.7KΩ ±5% ¼W
R106	1	1	RT0522314	Resistor 22KΩ ±5% ¼W
R107	1	1	RT0510214	Resistor 1KΩ ±5% ¼W
R108	1	1	RT0510214	Resistor 1KΩ ±5% ¼W
R109	1	1	RT0522314	Resistor 22KΩ ±5% ¼W
R110	1	1	RT0522314	Resistor 22KΩ ±5% ¼W
R111	1	1	RT0512214	Resistor 1.2KΩ ±5% ¼W
R112	1	1	RT0510114	Resistor 100Ω ±5% ¼W
R113	1	1	RT0510114	Resistor 100Ω ±5% ¼W
R114	1	1	RT0533114	Resistor 330Ω ±5% ¼W
R115	1	1	RT0566214	Resistor 5.6KΩ ±5% ¼W
R116	1	1	RA0103020	Trimming Res. ±10KΩ
R117	1	1	RT0566214	Resistor 5.6KΩ ±5% ¼W
R118	1	1	RT0510314	Resistor 10KΩ ±5% ¼W
R119	1	1	RT0510314	Resistor 10KΩ ±5% ¼W
R120	1	1	RT0510214	Resistor 1KΩ ±5% ¼W
R121	1	1	RT0530114	Resistor 300Ω ±5% ¼W
R122	1	1	RT0527314	Resistor 27KΩ ±5% ¼W
R123	1	1	RT0510414	Resistor 100KΩ ±5% ¼W
R124	1	1	RT0515214	Resistor 1.5KΩ ±5% ¼W
R125	1	1	RT0510114	Resistor 100Ω ±5% ¼W
R126	1	1	RT0510114	Resistor 100Ω ±5% ¼W
R127	1	1	RT0510114	Resistor 100Ω ±5% ¼W
R128	1	1	RC1027214	Resistor 3KΩ ±5% ¼W
R129	1	1	RC1027214	Resistor 2.7KΩ ±10% ¼W
R130	1	1	RT0530414	Resistor 300KΩ ±5% ¼W
C101	1	1	CA4330002	Variable Cap AM FM VC

REF. DESIG.	U	E	PART NO.	DESCRIPTION
C102	1	1	DD1205001	Ceramic Cap 5PF ±10%
C103	1	1	DK1710201	Ceramic Cap 0.001μF ±20%
C104	1	1	DK1710301	Ceramic Cap 0.01μF ±20%
C105	1	1	DD1001001	Ceramic Cap 1PF ±0.25PF
C106	1	1	DD1615001	Ceramic Cap 15PF ±10%
C107	1	1	DK1710201	Ceramic Cap 0.001μF ±20%
C108	1	1	DK1710301	Ceramic Cap 0.001μF ±20%
C109	1	1	DD1615001	Ceramic Cap 15PF ±10%
C110	1	1	DD1207001	Ceramic Cap 7PF ±1PF
C111	1	1	DD1103001	Ceramic Cap 3PF ±0.5PF
C112	1	1	DD1530101	Ceramic Cap 300PF ±5%
C113	1	1	DD1615001	Ceramic Cap 15PF ±10%
C114	1	1	DK1710201	Ceramic Cap 0.001μF ±20%
C115	1	1	DK1710301	Ceramic Cap 0.01μF ±20%
C116	1	1	DK1710301	Ceramic Cap 0.01μF ±20%
C117	1	1	DD1620004	Ceramic Cap 20PF ±10%
C118	1	1	CT1100008	Trimming Cap 1.5PF-10PF
C119	1	1	DD1210006	Ceramic Cap 10PF ±1PF
C120	1	1	DD1615003	Ceramic Cap 15PF ±10%
C121	1	1	DD1615003	Ceramic Cap 15PF ±10%
C122	1	1	DK1710301	Ceramic Cap 0.01μF ±20%
C123	1	1	DK1710301	Ceramic Cap 0.01μF ±20%
C126	1	1	DK1840302	Ceramic Cap 0.04μF ±20%
C127	1	1	EA4760259	Electroly Cap 47μF 25V
C128	1	1	DF1747301	Film Cap 0.04μF ±20%
C129	1	1	DK1710301	Ceramic Cap 0.01μF ±20%
C130	1	1	DF6539101	Film Cap 390PF ±5%
C131	1	1	DK1710301	Ceramic Cap 0.01μF ±20%
C132	1	1	DF1710301	Film Cap 0.01μF ±20%
C133	1	1	DD1620001	Ceramic Cap 20PF ±10%
C134	1	1	DK1710301	Ceramic Cap 0.01μF ±20%
C135	1	1	EA3350259	Electroly Cap 3.3μF 25V
C136	1	1	EA1050509	Electroly Cap 1μF 50V
C137	1	1	DK1710201	Ceramic Cap 0.001PF ±20%
C138	1	1	DF1710301	Film Cap 0.01μF ±20%
C139	1	1	DK1720301	Ceramic Cap 0.02μF ±20%
C140	1	1	EA1070169	Electroly Cap 100μF 16V
C141	1	1	EA1040356	Electroly Cap 0.1μF 35V
C142	1	1	DK1840302	Ceramic Cap 0.04μF ±20%
C143	1	1	EA1050509	Electroly Cap 1μF 50V
C144	1	1	DK1720301	Ceramic Cap 0.02μF ±20%
H101	1	1	HF200191A	FET 2SK 19(Y)
H102	1	1	HT310471B	Transistor 2SC 1047 (B)
H103	1	1	HT308291B	Transistor 2SC829 (B)
H104	1	1	HC1000301	IC HA 1151
H105	1	1	HT306441C	Transistor 2SC 644 T
L101	1	1	LA1202801	ANT Coil FM ANT
L102	1	1	LA1202802	RF Coil FM RF
L103	1	1	LA1202803	FM RF FM RF
L104	1	1	LO1202801	OSC Coil FM OSC
L105	1	1	LI1015801	FM IFT FM IFT
L106	1	1	LC1751001	Choke Coil 0.75μH
L107	1	1	LC1332002	Choke Coil 3.3μF
L108	1	1	LA1001308	AM RF AM RF
L109	1	1	LO1001314	AM OSC AM OSC
L110	1	1	LI1028301	AM IFT AM IFT
L111	1	1	LI1001316	AM IFT AM IFT
L112	1	1	LC1332002	Choke Coil 3.3μF
L110	1	1	LI1028302	AM IFT AM IFT
J101	1	1	YP1000113	Plug
J114	1	1		

REF. DESIG.	U	E	PART NO.	DESCRIPTION
1726	2	2	282110901	Shield
1727	1	1	288810901	Shield
P200	1	1	YD2915001	P200 IF BOARD
R201	1	1	RT0515114	Resistor 150Ω ±5% ¼W
R202	1	1	RT0547114	Resistor 470Ω ±5% ¼W
R203	1	1	RT0575014	Resistor 75Ω ±5% ¼W
R204	1	1	RT0515214	Resistor 1.5KΩ ±5% ¼W
R205	1	1	RT0533214	Resistor 3.3KΩ ±5% ¼W
R206	1	1	RT0582114	Resistor 820Ω ±5% ¼W
R207	1	1	RT0510214	Resistor 1KΩ ±5% ¼W
R208	1	1	RT0515214	Resistor 1.5KΩ ±5% ¼W
R210	1	1	RT0533214	Resistor 3.3KΩ ±5% ¼W
R211	1	1	RT0575014	Resistor 75Ω ±5% ¼W
R212	1	1	RT0582114	Resistor 820Ω ±5% ¼W
R213	1	1	RT0510214	Resistor 1KΩ ±5% ¼W
R214	1	1	RT0562114	Resistor 5.6KΩ ±5% ¼W
R215	1	1	RT0515314	Resistor 15KΩ ±5% ¼W
R216	1	1	RT0510214	Resistor 1KΩ ±5% ¼W
R217	1	1	RT0510214	Resistor 1KΩ ±5% ¼W
R218	1	1	RT0510214	Resistor 1KΩ ±5% ¼W
R219	1	1	RT0510214	Resistor 1KΩ ±5% ¼W
R220	1	1	RT0515314	Resistor 15KΩ ±5% ¼W
R221	1	1	RT0515114	Resistor 150Ω ±5% ¼W
R222	1	1	RT0510214	Resistor 1KΩ ±5% ¼W
R223	1	1	RT0510214	Resistor 1KΩ ±5% ¼W
R224	1	1	RT0515114	Resistor 150Ω ±5% ¼W
R225	1	1	RT0582114	Resistor 820Ω ±5% ¼W
R226	1	1	RT0515114	Resistor 150Ω ±5% ¼W
R227	1	1	RT0533214	Resistor 3.3KΩ ±5% ¼W
R228	1	1	RT0515314	Resistor 15KΩ ±5% ¼W
R229	1	1	RT0510214	Resistor 1KΩ ±5% ¼W
R230	1	1	RT0522114	Resistor 220Ω ±5% ¼W
R231	1	1	RT0582114	Resistor 820Ω ±5% ¼W
R232	1	1	RT0512214	Resistor 1.2KΩ ±5% ¼W
R233	1	1	RT0568214	Resistor 6.8KΩ ±5% ¼W
R234	1	1	RT0568214	Resistor 6.8KΩ ±5% ¼W
R235	1	1	RT0510114	Resistor 100Ω ±5% ¼W
R236	1	1	RT0510214	Resistor 1KΩ ±5% ¼W
R237	1	1	RT0510214	Resistor 1KΩ ±5% ¼W
R238	1	1	RT0533314	Resistor 33KΩ ±5% ¼W
R239	1	1	RT0551014	Resistor 51Ω ±5% ¼W
R240	1	1	RT0551014	Resistor 51Ω ±5% ¼W
R241	1	1	RT0551014	Resistor 51Ω ±5% ¼W
R242	1	1	RT0551014	Resistor 51Ω ±5% ¼W
R243	1	1	RT0510214	Resistor 1KΩ ±5% ¼W
R244	1	1	RT0566214	Resistor 5.6KΩ ±5% ¼W
R245	1	1	RT0566214	Resistor 5.6KΩ ±5% ¼W
R246	1	1	RT0515314	Resistor 15KΩ ±5% ¼W
R247	1	1	RT0510214	Resistor 1KΩ ±5% ¼W
R248	1	1	RT0522114	Resistor 220Ω ±5% ¼W
R249	1	1	RT0522314	Resistor 22KΩ ±5% ¼W
R250	1	1	RT0510214	Resistor 1KΩ ±5% ¼W
R251	1	1	RT0533314	Resistor 33KΩ ±5% ¼W
R252	1	1	RT0522314	Resistor 22KΩ ±5% ¼W
R253	1	1	RA0104018	Trimming Res. 100KΩ
R254	1	1	RT0518314	Resistor 18KΩ ±5% ¼W
R255	1	1	RT0510014	Resistor 10Ω ±5% ¼W
R256	1	1	RT0533214	Resistor 3.3KΩ ±5% ¼W
R257	1	1	RT0547314	Resistor 47KΩ ±5% ¼W
R258	1	1	RT0527314	Resistor 27KΩ ±5% ¼W

REF. DESIG.	U	E	PART NO.	DESCRIPTION
R259	1	1	RT0510114	Resistor 100Ω ±5% ¼W
R260	1	1	RT0539214	Resistor 3.9KΩ ±5% ¼W
R261	1	1	RT0547314	Resistor 47KΩ ±5% ¼W
R262	1	1	RT0510114	Resistor 100Ω ±5% ¼W
R263	1	1	RT0510114	Resistor 100Ω ±5% ¼W
R264	1	1	RT0510114	Resistor 100Ω ±5% ¼W
R265	1	1	RT0510414	Resistor 100KΩ ±5% ¼W
R266	1	1	RT0510414	Resistor 100KΩ ±5% ¼W
C201	1	1	DK1710301	Ceramic Cap 0.01μF ±20%
C202	1	1	DK1710301	Ceramic Cap 0.01μF ±20%
C203	1	1	DK1840301	Ceramic Cap 0.04μF ±20%
C204	1	1	DK1710301	Ceramic Cap 0.01μF ±20%
C205	1	1	DK1710301	Ceramic Cap 0.01μF ±20%
C206	1	1	DK1840301	Ceramic Cap 0.04μF ±20%
C207	1	1	DD1620101	Ceramic Cap 20

U: For U.S.A.
E: For Europe

REF. DESIG.	U	E	PART NO.	DESCRIPTION
L202	1	1	LI1015602	I FT
L203	1	1	LC1154004	Choke Coil 150μH
J201	11	11	YP1000113	Plug
1626	1	1	62030039W	Lug
P300	1	1	VD2915002	P300 MPX BOARD
	1	1	ZZ2915002	P W Board Assembly
	1	1	ZZ2915802	P W Board Assembly
R301	1	1	RT0522114	Resistor
R302	1	1	RT0563114	Resistor
R303	1	1	RA0103025	Trimming Res. 10KΩ
R304	1	1	RA0502020	Trimming Res. 5KΩ
R305	1	1	RT0516314	Resistor
R306	1	1	RT0510214	Resistor
R307	1	1	RT0522414	Resistor
R308	1	1	RT0510214	Resistor
R309	1	1	RT0539214	Resistor
R310	1	1	RT0539214	Resistor
R311	1	1	RT0510014	Resistor
R312	1	1	RT0510214	Resistor
R313	1	1	RT0522414	Resistor
R314	1	1	RT0530314	Resistor
R315	1	1	RT0530314	Resistor
R316	1	1	RT0515514	Resistor
R317	1	1	RT0515514	Resistor
R318	1	1	RT0510414	Resistor
R319	1	1	RT0510414	Resistor
R320	1	1	RT0522314	Resistor
R321	1	1	RT0522314	Resistor
R322	1	1	RT0568114	Resistor
R323	1	1	RT0568114	Resistor
R324	1	1	RT0510114	Resistor
R325	1	1	RT0510114	Resistor
R326	1	1	RT0582214	Resistor
R327	1	1	RT0582214	Resistor
R328	1	1	RT0568114	Resistor
R329	1	1	RT0568114	Resistor
R330	1	1	RT0522414	Resistor
R331	1	1	RT0522414	Resistor
R332	1	1	RT0515214	Resistor
R333	1	1	RT0522414	Resistor
R334	1	1	RT0522414	Resistor
R335	1	1	RT0522414	Resistor
R336	1	1	RT0522414	Resistor
C319	1	1	DF1522205	Film Cap
C320	1	1	DF1522205	Film Cap
C301	1	1	EA1060169	Electroly Cap
C302	1	1	DF1747301	Film Cap
C303	1	1	DF5547101	Film Cap
C304	1	1	DF1622205	Film Cap
C305	1	1	EO4740501	Electroly Cap
C306	1	1	EO2240501	Electroly Cap
C307	1	1	EO2240501	Electroly Cap
C308	1	1	EA2270169	Electroly Cap
C309	1	1	DF1615205	Film Cap
C310	1	1	DF1615205	Film Cap
C311	1	1	DD1536101	Ceramic Cap
C312	1	1	DD1536101	Ceramic Cap

REF. DESIG.	U	E	PART NO.	DESCRIPTION
C313	1	1	DF1633205	Film Cap
C314	1	1	DF1633205	Film Cap
C315	1	1	DF1515205	Film Cap
C316	1	1	DF1515205	Film Cap
C317	1	1	DF1622205	Film Cap
C318	1	1	DF1622205	Film Cap
C319	1	1	DF1533205	Film Cap
C320	1	1	DF1533205	Film Cap
C321	1	1	EV2240351	Electroly Cap
C322	1	1	EV2240351	Electroly Cap
C323	1	1	EV1050352	Electroly Cap
C324	1	1	EV1050352	Electroly Cap
C325	1	1	EA3370359	Electroly Cap
H301	1	1	HC1000401	IC
H302	1	1	HT3037210	Transistor
H303	1	1	HT3037210	Transistor
H304	1	1	HT313272A	Transistor
H305	1	1	HT313272A	Transistor
H306	1	1	HT104942A	Transistor
H307	1	1	HT104942A	Transistor
L301	1	1	LS1001304	MPX Coil
L302	1	1	LS1001304	MPX Coil
L303	1	1	LS1001305	MPX Coil
L304	1	1	LS1001305	MPX Coil
J301	11	11	YP1000113	Plug
J311	11	11	YP1000113	Plug
P400	1	1	VD2915003	P400 EQL AMP BOARD
	1	1	ZZ2915003	P W Board Assembly
R401	1	1	RT0582314	Resistor
R402	1	1	RT0582314	Resistor
R403	1	1	RT0547114	Resistor
R404	1	1	RT0547114	Resistor
R405	1	1	RN0539414	Resistor
R406	1	1	RN0539414	Resistor
R407	1	1	RT0522314	Resistor
R408	1	1	RT0522314	Resistor
R409	1	1	RT0582114	Resistor
R410	1	1	RT0582114	Resistor
R411	1	1	RN0510414	Resistor
R412	1	1	RN0510414	Resistor
R413	1	1	RT0533314	Resistor
R414	1	1	RT0533314	Resistor
R415	1	1	RT0566214	Resistor
R416	1	1	RT0566214	Resistor
R417	1	1	RT0518214	Resistor
R418	1	1	RT0518214	Resistor
R419	1	1	RT0547214	Resistor
R420	1	1	RT0547214	Resistor
R421	1	1	RT0522414	Resistor
R422	1	1	RT0522414	Resistor
R423	1	1	RT0566314	Resistor
R424	1	1	RT0566314	Resistor
R425	1	1	RT0533214	Resistor
R426	1	1	RT0533214	Resistor
R427	1	1	RN0582414	Resistor
R428	1	1	RN0582414	Resistor
R429	1	1	RT0510114	Resistor

U: For U.S.A.
E: For Europe

REF. DESIG.	U	E	PART NO.	DESCRIPTION
C401	1	1	EV2250256	Electroly Cap
C402	1	1	EV2250256	Electroly Cap
C403	1	1	DD1520101	Ceramic Cap
C404	1	1	DD1520101	Ceramic Cap
C405	1	1	DD1610101	Ceramic Cap
C406	1	1	DD1610101	Ceramic Cap
C407	1	1	EE2260251	Electroly Cap
C408	1	1	EE2260251	Electroly Cap
C409	1	1	DD1615001	Ceramic Cap
C410	1	1	DD1615001	Ceramic Cap
C411	1	1	EA4760169	Electroly Cap
C412	1	1	EA4760169	Electroly Cap
C413	1	1	DD1610101	Ceramic Cap
C414	1	1	DD1610101	Ceramic Cap
C415	1	1	DD1747401	Film Cap
C416	1	1	DF1747401	Film Cap
C417	1	1	DF5412201	Film Cap
C418	1	1	DF5412201	Film Cap
C419	1	1	DF5547201	Film Cap
C420	1	1	DF5547201	Film Cap
C421	1	1	EA10700509	Electroly Cap
C423	1	1	DD1650001	Ceramic Cap
C424	1	1	DD1650001	Ceramic Cap
H401	1	1	HT313281T	Transistor
H402	1	1	HT313281T	Transistor
H403	1	1	HT313282A	Transistor
H404	1	1	HT313282A	Transistor
H405	1	1	HT313281T	Transistor
H406	1	1	HT313281T	Transistor
J401	7	7	YP1000113	Plug
J407	7	7	YP1000113	Plug
1702	2	2	51440314A	P H M Screw
1703	2	2	54020301A	Flat Washer
1704	2	2	53110303A	Hexagon Nut
1709	4	4	51100306S	B H M Screw
1720	1	1	121000501	Clamper
H005	1	1	HV0000508	Diode
H006	1	1	HV0000508	Diode
1714	2	2	281810104	Support
1715	2	2	51100306S	B H M Screw
P700	1	1	VD2912007	P700 MAIN BOARD
	1	1	ZZ2915107	P W Board Assembly
R701	1	1	RT0520214	Resistor
R702	1	1	RT0520214	Resistor
R703	1	1	RT0533314	Resistor
R704	1	1	RT0533314	Resistor
R705	1	1	RT0568214	Resistor
R706	1	1	RT0568214	Resistor
R707	1	1	RT0510214	Resistor
R708	1	1	RT0510214	Resistor
R709	1	1	RT0568314	Resistor
R710	1	1	RT0568314	Resistor
R711	1	1	RA0502017	Trimming Res.
R712	1	1	RA0502017	Trimming Res.
R713	1	1	RT0547214	Resistor
R714	1	1	RT0547214	Resistor
R715	1	1	RT0522414	Resistor
R716	1	1	RT0522414	Resistor

REF. DESIG.	U	E	PART NO.	DESCRIPTION
R717	1	1	RT0527214	Resistor
R718	1	1	RT0527214	Resistor
R719	1	1	RT0533314	Resistor
R720	1	1	RT0533314	Resistor
R721	1	1	GF0533014	Resistor
R722	1	1	GF0533014	Resistor
R723	1	1	GF0522114	Resistor
R724	1	1	GF0522114	Resistor
R725	1	1	RT0547214	Resistor
R726	1	1	RT0547214	Resistor
R727	1	1	RT0547214	Resistor
R728	1	1	RT0547214	Resistor
R729	1	1	RT05822014	Resistor
R730	1	1	RT05822014	Resistor
R731	1	1	HH0000303	Thermister
R732	1	1	HH0000303	Thermister
R733	1	1	RA0301002	Trimming Res.
R734	1	1	RA0301002	Trimming Res.
R735	1	1	RT0568114	Resistor
R736	1	1	RT0568114	Resistor
R737	1	1	GF0510114	Resistor
R738	1	1	GF0510114	Resistor
R739	1	1	GF0513114	Resistor
R740	1	1	GF0513114	Resistor
R741	1	1	GF0522214	Resistor
R742	1	1	GF0522214	Resistor
R743	1	1	GF0582114	Resistor
R744	1	1	GF0582114	Resistor
R745	1	1	GF0522214	Resistor
R746	1	1	GF0522214	Resistor
R747	1	1	GF0510114	Resistor
R748	1	1	GF0510114	Resistor
R749	1	1	GF0510114	Resistor
R750	1	1	GF0510114	Resistor
R751	1	1	GF0510014	Resistor
R752	1	1	GF0510014	Resistor
R753	1	1	GF0522112	Resistor
R754	1	1	GF0522112	Resistor
R755	1	1	GF0522112	Resistor
R756	1	1	GF0522112	Resistor
R757	1	1	GF0510014	Resistor
R758	1	1	GF0510014	Resistor
R759	1	1	GF0510014	Resistor
R760	1	1	GF0510014	Resistor
R761	1	1	GW1047202	Resistor
R762	1	1	GW1047202	Resistor
R763	1	1	GJ0510002	Resistor
R764	1	1	GJ0510002	Resistor
R765	1	1	GF0522014	Resistor
R766	1	1	GF0522014	Resistor
R767	1	1	RC1056212	Resistor
R768	1	1	RC1056212	Resistor
R769	1	1	RT0518314	Resistor
R770	1	1	RT0512314	Resistor
R771	1	1	RT0568214	Resistor</

U: For U.S.A.
E: For Europe

REF. DESIG.	U	E	PART NO.	DESCRIPTION
C703	1	1	DD1620101	Ceramic Cap 200PF 50V
C704	1	1	DD1620101	Ceramic Cap 200PF 50V
C705	1	1	EE4760162	Electroly Cap 47μF 16V±20%
C706	1	1	EE4760162	Electroly Cap 47μF 16V±20%
C707	1	1	DD1003050	Ceramic Cap 3PF 500V
C708	1	1	DD1003050	Ceramic Cap 3PF 500V
C709	1	1	EA4760509	Electroly Cap 47μF 500V ^{+100%} _{-10%}
C710	1	1	EA4760509	Electroly Cap 47μF 500V ^{+100%} _{-10%}
C715	1	1	DK1610150	Ceramic Cap 100PF
C716	1	1	DK1610150	Ceramic Cap 100PF
C717	1	1	DF1710452	Film Cap 0.1μF 200V
C718	1	1	DF1710452	Film Cap 0.1μF 200V
C719	1	1	EA2270509	Electroly Cap 220μF 50V ^{+100%} _{-10%}
C720	1	1	EA1060359	Electroly Cap 10μF 35V ^{+100%} _{-10%}
C721	1	1	EA4760169	Electroly Cap 47μF 16V ^{+100%} _{-10%}
C722	1	1	EA2270109	Electroly Cap 220μF 10V ^{+100%} _{-10%}
J701	~			
J727	27	27	YP1000113	Plug
H701	1	1	HT107631B	Transistor 2SA763
H702	1	1	HT107631B	Transistor 2SA763
H703	1	1	HT107631B	Transistor 2SA763
H704	1	1	HT107631B	Transistor 2SA763
H705	1	1	HV0000312	Diode MV-13
H706	1	1	HV0000312	Diode MV-13
H707	1	1	HT315092B	Transistor 2SC 1509 Q.R
H708	1	1	HT315092B	Transistor 2SC 1509 Q.R
H709	1	1	HT309451Q	Transistor 2SC 945 Q
H710	1	1	HT309451Q	Transistor 2SC 945 Q
H711	1	1	HT107331Q	Transistor 2SA 733 Q
H712	1	1	HT107331Q	Transistor 2SA 733 Q
H713	1	1	HD2000221	Diode 1S2472 (GY)
H714	1	1	HD2000221	Diode 1S2472 (GY)
H715	1	1	HD2000221	Diode 1S2472 (GY)
H716	1	1	HD2000221	Diode 1S2472 (GY)
H717	1	1	HD2000221	Diode 1S2472 (GY)
H718	1	1	HD2000221	Diode 1S2472 (GY)
H719	1	1	HD2000221	Diode 1S2472 (GY)
H720	1	1	HD2000221	Diode 1S2472 (GY)
H721	1	1	HT315091P	Transistor 2SC1509 (P.Q)
H722	1	1	HT315091P	Transistor 2SC1509 (P.Q)
H723	1	1	HT107771P	Transistor 2SA 777 (P.Q)
H724	1	1	HT107771P	Transistor 2SA 777 (P.Q)
H725	1	1	HD3003009	Diode WZ-177
H726	1	1	HT309452A	Transistor 2SC945 Q.R
H727	1	1	HT309452A	Transistor 2SC945 Q.R
H728	1	1	HT313182C	Transistor 2SC1318 R.S
H729	1	1	HD2000321	Diode 1S2471
L701	1	1	LC2272001	Coil 2.7μH
L702	1	1	LC2272001	Coil 2.7μH
L703	1	1	LY2024005	Relay
1706	1	1	291526701	Heat Sink
1707	2	2	291516007	Bracket
1708	4	4	51380306P	R H Tap Screw
1711	8	8	51100312E	B H M Screw B 3 x 12
1713	8	8	54040302N	Spring Washer Power Tr.
1716	2	2	282016007	Bracket
1717	8	8	51380306P	R H Tap Screw
H001	1	1	HT401881M	Transistor 2SD188M.L
H002	1	1	HT106271M	Transistor 2SA627M.L
H003	1	1	HT106271M	Transistor 2SA627M.L

REF. DESIG.	U	E	PART NO.	DESCRIPTION
H004	1	1	HT401881M	Transistor 2SD188M.L
J009	1	1	YJ0500019	Socket TR
J010	1	1	YJ0500019	Socket TR
J011	1	1	YJ0500019	Socket TR
J012	1	1	YJ0500019	Socket TR
P800	1	1	YD2915007	P800 POWER BOARD
			ZZ2915007	P.W.Board, Power Supply Board
				P.W. Board Assembly
R801	1	1	GJ0522002	Resistor 22Ω ±5% 2W
R802	1	1	GF0510014	Resistor 10Ω ±5% ¼W
R803	1	1	RT0515214	Resistor 1.5KΩ ±5% ¼W
R804	1	1	RT0515214	Resistor 1.5KΩ ±5% ¼W
R805	1	1	GJ0533102	Resistor 330Ω ±5% 2W
R806	1	1	RT0536314	Resistor 36KΩ ±5% ¼W
R807	1	1	RT0527314	Resistor 27KΩ ±5% ¼W
R808	1	1	RA0502013	Trimming Res 5KΩ B
C801	1	1	DK1810351	Ceramic Cap 0.01μF ^{+100%} _{-0%} 500V
C802	1	1	DK1810351	Ceramic Cap 0.01μF ^{+100%} _{-0%} 500V
C803	1	1	EA4770631	Electroly Cap 470μF 63V
C804	1	1	EA4770509	Electroly Cap 470μF 50V
C805	1	1	EA1070509	Electroly Cap 100μF 50V
C806	1	1	DF1747305	Film Cap 0.047μF ±20% 50V
C807	1	1	DK1840302	Ceramic Cap 0.04μF ^{+100%} _{-0%} 50V
C808	1	1	EA3350509	Electroly Cap 3.3μF 50V
C809	1	1	EA4770169	Electroly Cap 470μF 16V
C810	1	1	EA1080109	Electroly Cap 1000μF 10V
H801	1	1	HD2001508	Diode SS-3R
H802	1	1	HD2001408	Diode SS-3
H803	1	1	HD2001203	Diode DS-131 B
H804	1	1	HD2001103	Diode DS-132 B
H805	1	1	HT403302A	Transistor 2SD330 D or E
H806	1	1	HT309452A	Transistor 2SC945 Q or R
H807	1	1	HD3002109	Diode BZ-140 14V
H808	1	1	HD2000413	Diode S1B01-02
J801	~			
J815	15	15	YP1000113	Plug
J816	1	1	YJ0800021	Socket
J817	1	1	YJ0800021	Socket
J818	1	1	YJ0800021	Socket
J819	1	1	YJ0800021	Socket
0403	1		291516021	Bracket
0404	1		291516022	Bracket
0406	1	1	291516024	Bracket
0409	2	1	145525901	Bush
0411	4	4	51100306S	B H M Screw B 3 x 6
0412	4	4	53110303E	Hexagon Nut
0414	2	2	51100306S	B H M Screw B 3 x 6
0415	2	2	53110303E	Hexagon Nut
0416	6	6	51100306S	B H M Screw B 3 x 6
0417	6	6	53110303E	Hexagon Nut
0419	1	1	54050400R	T L Washer OR Chassis Ground
0421	4	4	51100308S	B H M Screw AC Outlet B 3 x 8
0422	4	4	53110303E	Hexagon Nut AC Outlet
0424	1		284906702	Cap
0426	1		282125901	Bush
0427	2		53110303A	Hexagon Nut
0428	2		54050300R	T L Washer
0429	2		51060316A	P H M Screw P 3 x 16

REF. DESIG.	U	E	PART NO.	DESCRIPTION
0430		2	55060305S	T R Rivet
0432	3	3	51100306S	B H M Screw B 3 x 6
R003	1		RC1022512	Resistor 2.2MΩ ±10% ½W
1517	1	1	62030039W	Lug
J001	1	1	YT0304009	Terminal Ant
J004	1	1	YT0101003	Terminal Ground
J013	1	1	YT0304006	Terminal SPK
J014	1	1	YT0304006	Terminal SPK
J016	1		YJ0800012	Socket Fuse Holder
F001	1		FS1020006	Fuse 2A
F002	1		FS2025091	Fuse 2.5A
W001	1		YC0240010	AC Cord
0423	4	4	54050300R	T. L Washer
J017	1	1	YJ0400048	Jack AC Outlet
J018	1	1	YJ0400048	Jack AC Outlet
J019	1	1	YT0201009	Terminal Quad Out
0505	1	1	281927103	Holder
0506	1	1	257816052	Bracket K
0511	2	2	51100310S	B H M Screw x 2 B 3 x 10
0512	2	2	54050300R	T L Washer OR x 2
0513	2	2	53110303E	Hexagon Nut x 2
0516	2	2	51100310S	B H M Screw x 2 B 3 x 10
0518	2	2	53110303E	Hexagon Nut x 2
L001	1	1	LF1120036	Ant Coil
L002	1	1	LC1332002	Choke Coil
C001	1	1	DK1710301	Ceramic Cap 0.01μF ±20% 50V
0420	1	1	62041760W	Lug Chassis Ground
J005	1	1	YT0204008	Terminal 4P Pin-Jack
C002	1	1	DK1710301	Ceramic Cap 0.01μF ±20% 50V
1621	1	1	62030039W	Lug
J006	1	1	YT0208006	Terminal 8P Pin-Jack
0603	1	1	291516050	Bracket K
0610	2	2	51100306A	B H M Screw x 2 B 3 x 6
0613	2	2	51100306A	B H M Screw x 2 B 3 x 6
0616	1	1	281816003	Bracket
0617	1	1	281816004	Bracket
0618	4	4	51100406A	B H M Screw x 4 B 4 x 6
0621	4	4	51100306A	B H M Screw x 4 B 3 x 6
0622	2	2	51100306A	B H M Screw x 2 B 3 x 6
0828	2	2	51100305A	B H M Screw x 2 B 3 x 5
0624	1	1	257710602	Bearing
0625	1	1	141511801	Spacer
0626	2	2	51040306A	F H M Screw x 2 F 3 x 6
0627	2	2	51470306A	B H M Screw x 2
0628	1	1	287105302	Cover
0623	1	1	291512002	Insulator
0631	1	1	281912005	Insulator
0632	1	1	285326901	Protector
0633	2	2	51570305B	P H Tapt Screw x 2 P 3 x 5 ST
0702	2	2	51570306B	P H Tapt Screw P 3 x 6 ST
0703	2	2	54050300R	T L Washer OR

REF. DESIG.	U	E	PART NO.	DESCRIPTION
0706	2	2	51042608A	F H M Screw F 2.6 x 8
0711	2	2	51570305B	P H Tapt Screw P 3 x 5 ST
0729	1	1	287105102	Guide
0733	4	4	288612002	Insulator
0609	1	1	291516006	Bracket
J015	1	1	YJ0100098	Jack Headphone
0611	1	1	291516005	Bracket Power SW
G001	1		BF1040003	Printed Comp
C005		1	DF1722380	Film Cap 0.0022μF 1000V
0612	2	2	51060306A	P H M Screw Power Sw. P 3 x 6
S002	1	1	SP0201015	Power Switch
M001	1	1	IM1104208	Meter AM/FM
0629	1	1	288610701	Sheet
0709	1	1	291516004	Bracket
0710	1	1	291225901	Bush
M003	1	1	IN1008009	Lamp Stereo Ind.
0802	1	1	285427401	Reflector
0803	1	1	285427101	Holder
0805	1	1	51480306A	B H M Screw F
0806	1	1	51570305B	P H Tapt Screw P 3 x 5 ST
M004	1	1	IN1008036	Lamp Meter
J008	1	1	YJ0800019	Socket Lamp Socket
0826	1	1	291510903	Shield
0827	1	1	291512003	Insulator
1002	1	1	287127101	Holder
1003	2	2	51570305B	P H Tapt Screw P 3 x 5 ST
1006	1	1	287100501	Clamper
1007	2	2	51100306A	B H M Screw B 3 x 6
0902	1	1	287127401	Reflector
0903	2	2	51480306A	B H M Screw F
PZ01	1	1	YD2886016	PZ01 DIAL LAMP BOARD
	1	1	ZZ2915116	P.W. Board, Dial Lamp Board P.W. Board Assembly
MZ01	1	1	IN1008036	Lamp
MZ02	1	1	IN1008036	Lamp
MZ03	1	1	IN1008036	Lamp
MZ04	1	1	IN1008036	Lamp
MZ05	1	1	IN1008036	Lamp
JZ01	1	1	YJ0800017	Socket
JZ02	1	1	YJ0800017	Socket
JZ03	1	1	YJ0800017	Socket
JZ04	1	1	YJ0800017	Socket
JZ05	1	1	YJ0800017	Socket
JZ06	1	1	YJ0800017	Socket
JZ07	1	1	YJ0800017	Socket
JZ08	1	1	YJ0800017	Socket
JZ09	1	1	YJ0800017	Socket
JZ10	1	1	YJ0800017	Socket
JZ11				
~	4	4	YP1000113	Plug
JZ14				

U: For U.S.A.
E: For Europe

REF. DESIG.	U	E	PART NO.	DESCRIPTION
1103	1	1	285310650	Bearing K
1108	1	1	51640410D	Set Screw C P
1109	1	1	54040402N	Spring Washer
1110	1	1	53110403E	Hexagon Nut
PE01 TONE AMP BOARD				
PE01	1	1	YD2915004	P.W. Board, Pre-Tone Amp. Board
	1	1	ZZ2915004	P.W. Board Assembly
RE01	1	1	RT0547414	Resistor 470K Ω \pm 5% $\frac{1}{4}$ W
RE02	1	1	RT0547414	Resistor 470K Ω \pm 5% $\frac{1}{4}$ W
RE03	1	1	RT0539114	Resistor 390 Ω \pm 5% $\frac{1}{4}$ W
RE04	1	1	RT0539114	Resistor 390 Ω \pm 5% $\frac{1}{4}$ W
RE05	1	1	RN0510514	Resistor 1M Ω \pm 5% $\frac{1}{4}$ W
RE06	1	1	RN0510514	Resistor 1M Ω \pm 5% $\frac{1}{4}$ W
RE07	1	1	RN0510414	Resistor 100K Ω \pm 5% $\frac{1}{4}$ W
RE08	1	1	RT0510314	Resistor 10K Ω \pm 5% $\frac{1}{4}$ W
RE09	1	1	RT0527314	Resistor 27K Ω \pm 5% $\frac{1}{4}$ W
RE10	1	1	RT0527314	Resistor 27K Ω \pm 5% $\frac{1}{4}$ W
RE11	1	1	RT0510214	Resistor 1K Ω \pm 5% $\frac{1}{4}$ W
RE12	1	1	RT0510214	Resistor 1K Ω \pm 5% $\frac{1}{4}$ W
RE13	1	1	RT0551214	Resistor 5.1K Ω \pm 5% $\frac{1}{4}$ W
RE14	1	1	RT0551214	Resistor 5.1K Ω \pm 5% $\frac{1}{4}$ W
RE15	1	1	RT0510214	Resistor 1K Ω \pm 5% $\frac{1}{4}$ W
RE16	1	1	RT0510214	Resistor 1K Ω \pm 5% $\frac{1}{4}$ W
RE17	1	1	RT0547414	Resistor 470K Ω \pm 5% $\frac{1}{4}$ W
RE18	1	1	RT0547414	Resistor 470K Ω \pm 5% $\frac{1}{4}$ W
RE19	1	1	RT0556214	Resistor 5.6K Ω \pm 5% $\frac{1}{4}$ W
RE20	1	1	RT0556214	Resistor 5.6K Ω \pm 5% $\frac{1}{4}$ W
RE21	1	1	RT0512314	Resistor 12K Ω \pm 5% $\frac{1}{4}$ W
RE22	1	1	RT0512314	Resistor 12K Ω \pm 5% $\frac{1}{4}$ W
RE23	1	1	RT0515414	Resistor 150K Ω \pm 5% $\frac{1}{4}$ W
RE24	1	1	RT0515414	Resistor 150K Ω \pm 5% $\frac{1}{4}$ W
RE25	1	1	RT0556214	Resistor 5.6K Ω \pm 5% $\frac{1}{4}$ W
RE26	1	1	RT0556214	Resistor 5.6K Ω \pm 5% $\frac{1}{4}$ W
RE27	1	1	RT0556214	Resistor 5.6K Ω \pm 5% $\frac{1}{4}$ W
RE28	1	1	RT0556214	Resistor 5.6K Ω \pm 5% $\frac{1}{4}$ W
RE29	1	1	RT0527314	Resistor 27K Ω \pm 5% $\frac{1}{4}$ W
RE30	1	1	RT0527314	Resistor 27K Ω \pm 5% $\frac{1}{4}$ W
RE31	1	1	RT0512314	Resistor 12K Ω \pm 5% $\frac{1}{4}$ W
RE32	1	1	RT0512314	Resistor 12K Ω \pm 5% $\frac{1}{4}$ W
RE33	1	1	RT0515314	Resistor 15K Ω \pm 5% $\frac{1}{4}$ W
RE34	1	1	RT0515314	Resistor 15K Ω \pm 5% $\frac{1}{4}$ W
RE35	1	1	RT0547414	Resistor 470K Ω \pm 5% $\frac{1}{4}$ W
RE36	1	1	RT0547414	Resistor 470K Ω \pm 5% $\frac{1}{4}$ W
RE37	1	1	RT0527314	Resistor 27K Ω \pm 5% $\frac{1}{4}$ W
RE38	1	1	RT0527314	Resistor 27K Ω \pm 5% $\frac{1}{4}$ W
RE39	1	1	RT0522514	Resistor 2.2M Ω \pm 5% $\frac{1}{4}$ W
RE40	1	1	RT0522514	Resistor 2.2M Ω \pm 5% $\frac{1}{4}$ W
RE41	1	1	RT0568314	Resistor 68K Ω \pm 5% $\frac{1}{4}$ W
RE42	1	1	RT0568314	Resistor 68K Ω \pm 5% $\frac{1}{4}$ W
RE43	1	1	RT0547314	Resistor 47K Ω \pm 5% $\frac{1}{4}$ W
RE44	1	1	RT0547314	Resistor 47K Ω \pm 5% $\frac{1}{4}$ W
RE45	1	1	RT0510314	Resistor 10K Ω \pm 5% $\frac{1}{4}$ W
RE46	1	1	RT0510314	Resistor 10K Ω \pm 5% $\frac{1}{4}$ W
RE47	1	1	RT0522114	Resistor 220 Ω \pm 5% $\frac{1}{4}$ W
RE48	1	1	RT0522114	Resistor 220 Ω \pm 5% $\frac{1}{4}$ W
RE49	1	1	RT0547414	Resistor 470K Ω \pm 5% $\frac{1}{4}$ W
RE50	1	1	RT0547414	Resistor 470K Ω \pm 5% $\frac{1}{4}$ W
RE51	1	1	RM0104005	Variable Resist 100K Ω (B) High
RE52	1	1	RM0104005	Variable Resist 100K Ω Mid
RE53	1	1	RM0104005	Variable Resist 100K Ω Low
RE54	1	1	RT0582114	Resistor 820 Ω \pm 5% $\frac{1}{4}$ W
CE01	1	1	DF1722405	Film Cap 0.22 μ F 50V \pm 20%

REF. DESIG.	U	E	PART NO.	DESCRIPTION
CE02	1	1	DF1722405	Film Cap 0.22 μ F 50V \pm 20%
CE03	1	1	EA1060359	Electroly Cap 10 μ F 35V \pm 10%
CE04	1	1	EA1060359	Electroly Cap 10 μ F 35V \pm 10%
CE05	1	1	EE4750251	Electroly Cap 4.7 μ F 25V \pm 20%
CE06	1	1	EE4750251	Electroly Cap 4.7 μ F 25V \pm 20%
CE07	1	1	DD1610101	Ceramic Cap 100PF 50V \pm 10%
CE08	1	1	DD1610101	Ceramic Cap 100PF 50V \pm 10%
CE09	1	1	DF1622205	Film Cap 2200PF 50V \pm 10%
CE10	1	1	DF1622205	Film Cap 2200PF 50V \pm 10%
CE11	1	1	DF1668205	Film Cap 6800PF 50V \pm 10%
CE12	1	1	DF1668205	Film Cap 6800PF 50V \pm 10%
CE13	1	1	DF1622305	Film Cap 0.022 μ F 50V \pm 10%
CE14	1	1	DF1622305	Film Cap 0.022 μ F 50V \pm 10%
CE15	1	1	DF1622305	Film Cap 0.022 μ F 50V \pm 10%
CE16	1	1	DF1622305	Film Cap 0.022 μ F 50V \pm 10%
CE17	1	1	DF1610305	Film Cap 0.01 μ F 50V \pm 10%
CE18	1	1	DF1610305	Film Cap 0.01 μ F 50V \pm 10%
CE19	1	1	EE1050501	Electroly Cap 1 μ F 50V \pm 20%
CE20	1	1	EE1050501	Electroly Cap 1 μ F 50V \pm 20%
CE21	1	1	EE3350501	Electroly Cap 33 μ F 50V \pm 20%
CE22	1	1	EE3350501	Electroly Cap 33 μ F 50V \pm 20%
CE23	1	1	EQ1050501	Electroly Cap 1 μ F 50V \pm 30%
CE24	1	1	EQ1050501	Electroly Cap 1 μ F 50V \pm 30%
CE25	1	1	EA2270359	Electroly Cap 220 μ F 35V \pm 10%
HE01	1	1	HT313283A	Transistor 2SC1328 S.T.U.
HE02	1	1	HT313283A	Transistor 2SC1328 S.T.U.
HE03	1	1	HT107632A	Transistor 2SA763 4.5
HE04	1	1	HT107632A	Transistor 2SA763 4.5
HE05	1	1	HT313283A	Transistor 2SC1328 S.T.U.
HE06	1	1	HT313283A	Transistor 2SC1328 S.T.U.
HE07	1	1	HT107632A	Transistor 2SA763 4.5
HE08	1	1	HT107632A	Transistor 2SA763 4.5
JE01	~	8	YP1000113	Plug
JE08	~	8		
PH02 FILTER BOARD				
PH01	1	1	YD2915005	P.W. Board, Filter Board
	1	1	ZZ2915005	P.W. Assembly
RH01	1	1	RT0510214	Resistor 1K Ω \pm 5% $\frac{1}{4}$ W
RH02	1	1	RT0510214	Resistor 1K Ω \pm 5% $\frac{1}{4}$ W
RH04	1	1	RT0510514	Resistor 1M Ω \pm 5% $\frac{1}{4}$ W
RH05	1	1	RT0510514	Resistor 1M Ω \pm 5% $\frac{1}{4}$ W
RH06	1	1	RT0547214	Resistor 4.7K Ω \pm 5% $\frac{1}{4}$ W
RH07	1	1	RT0547214	Resistor 4.7K Ω \pm 5% $\frac{1}{4}$ W
RH08	1	1	RT0522514	Resistor 2.2M Ω \pm 5% $\frac{1}{4}$ W
RH09	1	1	RT0522514	Resistor 2.2M Ω \pm 5% $\frac{1}{4}$ W
CH01	1	1	DF1633305	Film Cap 0.033 μ F 50V \pm 10%
CH02	1	1	DF1633305	Film Cap 0.033 μ F 50V \pm 10%
CH03	1	1	DF1668205	Film Cap 0.0068 μ F 50V \pm 10%
CH04	1	1	DF1668205	Film Cap 0.0068 μ F 50V \pm 10%
SH01	1	1	SP0404013	Push Switch
JH01	~	17	YP1000113	Plug
JH17	~	17		
PT01 MAIN REMOTE BOARD				
PT01	1	1	YD2915006	P.W. Board, Selector-SW Board
	1	1	ZZ2915006	P.W. Board Assembly
RT01	1	1	RT0568314	Resistor 68K Ω \pm 5% $\frac{1}{4}$ W

REF. DESIG.	U	E	PART NO.	DESCRIPTION		
RT02	1	1	RT0568314	Resistor	68KΩ	±5% ¼W
RT03	1	1	RT0515314	Resistor	15KΩ	±5% ¼W
RT04	1	1	RT0515314	Resistor	15KΩ	±5% ¼W
RT05	1	1	GJ0533102	Resistor	330Ω	±5% 2W
RT06	1	1	GJ0533102	Resistor	330Ω	±5% 2W
RT07	1	1	GU0515112	Resistor	150Ω	±5% ¼W
RT08	1	1	GU0515112	Resistor	150Ω	±5% ¼W
CT01	1	1	DD1612101	Ceramic Cap	120PF	50V±10%
CT02	1	1	DD1612101	Ceramic Cap	120PF	50V±10%
CT03	1	1	DF1627305	Film Cap	0.027μF	50V±10%
CT04	1	1	DF1627305	Film Cap	0.027μF	50V±10%
ST01	1	1	SP0404011	Push Switch		
JT01						
~	16	16	YP1000113	Plug		
JT16						
R002	1	1	RM0254022	Variable Resist	Volume	
S001	1	1	SR0905008	Rotary SW	Selector	
R004	1	1	GF0533012	Resistor		
R001	1	1	RS0504002	Resistor Balance (33Ω		±5% ¼W)
1416	1	1	291530201	Dial		
1418	1	1	291530203	Dial		
1420	1	1	285310701	Sheet		
1733	1	1	138200503	Clamper		
1734	1	1	51100305A	B H M Screw		B 3 x 5
1731	1	1	257710402	Retainer		
1632		1	291516011	Bracket		
1633		1	51062606E	P H M Screw		P 2.6 x 6
J025		1	YJ0800009	Socket		
J024		1	YL0106004	Terminal		
1534		1	290812002	Insulator		
1522	1	1	121000501	Clamper		
1624	1	1	121000501	Clamper		
J003	1	1	YL0102003	Terminal		
L004	1	1	LB3007526	Balun Coil		
0234	4	4	275905701	Leg		
0235	4	4	51490410S	B H M Screw FS		
0321	1	1	288686101	Label	Marantz	
0323	1	1	951022101	Label	Fuse Caution	
0327		1	951061102	Label	2A 250V	
0407	6	6	51100306S	B H M Screw		B 3 x 6
1502	1	1	291510550	Chassis K		
1507	2	2	291516008	Bracket		
1508	4	4	54020401A	Flat Washer P		
1509	4	4	54040402A	Spring Washer		
1510	4	4	53110403A	Hexagon Nut		
1511	2	2	287100501	Clamper		
1513	4	4	51570306S	P H Tapt Screw		P 3 x 6 ST
1515	4	4	51100306S	B H M Screw		B 3 x 6
1516	16	16	51570306S	P H Tapt Screw		P 3 x 6 ST
1518	1	1	51570306B	P H Tapt Screw		P 3 x 6 ST
1519	1	1	138200503	Clamper		
1520	4	4	54050300R	T L Washer OR		
1521	10	10	51570305B	P H Tapt Screw		P 3 x 5 ST
1523	2	2	288600503	Clamper		

REF. DESIG.	U	E	PART NO.	DESCRIPTION		
1524	4	4	288600502	Clamper		
1525	2	2	288600505	Clamper		
1526	2	2	288600506	Clamper		
1527	2	2	285116006	Bracket		
1528	4	4	51570306B	P H Tapt Screw		P 3 x 6 ST
1529	1	1	291516009	Bracket		
1530	1	1	51570306B	P H Tapt Screw		P 3 x 6 ST
1531	1	1	54050300R	T L Washer OR		
1532	2	2	51570306B	P H Tapt Screw		P 3 x 6 ST
1535		2	51570312B	P H Tapt Screw		P 3x12 ST
1619	1	1	51570306B	P H Tapt Screw		P 3 x 6 ST
1620	1	1	54050300R	T L Washer OR		
1623	1	1	51570306B	P H Tapt Screw		P 3 x 6 ST
1718	4	4	51570306B	P H Tapt Screw x 4		P 3 x 6 ST
1732	1	1	51570306B	P H Tapt Screw		P 3 x 6 ST
1627	1	1	51570306B	P H Tapt Screw		P 3 x 6 ST
1630	1	1	51570306B	P H Tapt Screw		P 3 x 6 ST
J007	1	1	YL0105002	Terminal		
C003	1	1	EC6880352	Electroly Cap	6800μF	35V
C004	1	1	EC6880352	Electroly Cap	6800μF	35V
L005	1		TS1850403	Power Transf		
L005		1	TS1850404	Power Transf		
0714	1	1	291526250	Pulley K		
0719	2	2	51100306A	B H M Screw		B 3 x 6
0721	1	1	291526251	Pulley K		
0728	2	2	51100306A	B H M Screw		B 3 x 6
F801	1		FS1010008	Fuse		1A
F802	1		FS1020006	Fuse		2A
F801		1	FS1010090	Fuse		1A
F802		1	FS1020090	Fuse		2A
F003		1	FS1020090	Fuse		2A
0219	4	4	257711807	Spacer		
0220	1	1	281825701	Lid		
0221	1	1	281825702	Lid		
0222	1	1	291512001	Insulator		
0223	4	4	51480406S	B H M Screw F		
0224	10	10	51100406S	B H M Screw		B 4 x 6
1512	1	1	209512004	Insulator		
0303	1	1	257886101	Label		UL Caution
0304	1	1	257886102	Label		Do not remove
0305	1	1	257886103	Label		See marking
0306	1	1	250626506	Indicator		Do not use as
0313	1		951091102	Label		UL Factory
0113	4	4	52017039J	H Head Bolt		
0120	1	1	289610701	Sheet		
0125	1	1	289205502	Collar		
0202	8	8	288615403	Knob		Push SW
0204	1	1	290415404	Knob		Power SW
0205	1	1	285015401	Knob		Slide Vol.
0206	5	5	281815403	Knob		Single, Large
0208	1		291526501	Indicator		Name Plate
0210		1	291526503	Indicator		Name Plate
0217	2	2	51100306S	B H M Screw		B 3 x 6
0316	1		951110102	Label		UL
0634	1	1	285011202	Shaft		
0635	1	1	54040402N	Spring Washer		
1410	1	1	56382540G	Eyelet		
1422	1	1	291526901	Protector		
1423	2	2	51570305B	P H Tapt Screw		P 3 x 5 ST
1922	4		952281501	Serial No Card		
1924		4	952301511	Serial No Card		

TECHNICAL SPECIFICATIONS

AUDIO CIRCUITS:

Rated Power Output (Continuous Average per Channel, All Channels Driven).

Power Output	20 Watts 4 Ohms
	20 Watts 8 Ohms
	10 Watts 16 Ohms
Power Band	20 Hz to 20 KHz
THD	0.5%
High-level hum and noise (ref. 20 Watts at 8 ohms)	-77 dB
Phono hum and noise	1.5 μ V equivalent input
Dynamic range (phono input to tape recording output)	96 dB
I.M. Distortion (SMPTE), at rated power	0.9%
Distortion decreases as output is lowered	
Total Harmonic Distortion, at rated power	0.5% Maximum
Distortion decreases as output is lowered	
Power Bandwidth (IHF) for 0.5% THD	10 Hz to 50,000 Hz
Damping Factor (ref. 8 ohms)	Greater than 20
Frequency Response	
Through phono	2.0 dB
Input Sensitivity (for 15 Watts at 8 ohms)	
High-level	180 mV
Phono (1,000 Hz)	1.8 mV
Input Impedance	
High-level	100,000 ohms
Phono	47,000 ohms
Channel Separation 20 Hz to 10,000 Hz	30 dB Minimum

FM SECTIONS:

IHF Usable Sensitivity	2.5 μ V
Selectivity	50 dB
Noise Quieting	-70 dB at 1,000 μ V
Total Harmonic Distortion, 400 Hz, 100% Mod	0.3% Maximum
Frequency Response (ref. 75 μ sec. de-emphasis)	\pm 1 dB 50 Hz to 15 KHz
Stereo Separation	1,000 Hz 40 dB
Sub Carrier (38 KHz) Suppression	60 dB

GENERAL:

Power Requirements	220V ~ 50/60 Hz
At rated output, both channels operating	140 Watts
Idling Power (Volume Control at zero)	30 Watts
Dimensions	
Panel Width	17-3/8 Inches
Panel Height	5-3/8 Inches
Depth	14 Inches
Weight	
Unit alone	26.4 lbs
Packed for shipment	33 lbs

*These specifications and exterior designs may be changed for improvement without advance notice.

SERVICE INFORMATION FOR EUROPEAN MODEL

The information contained here in includes the rear panel and main chassis component locations, schematic diagram, voltage conversion and FTZ regulation.

For the circuit description, alignment method and repairing hints, refer to the original service manual.

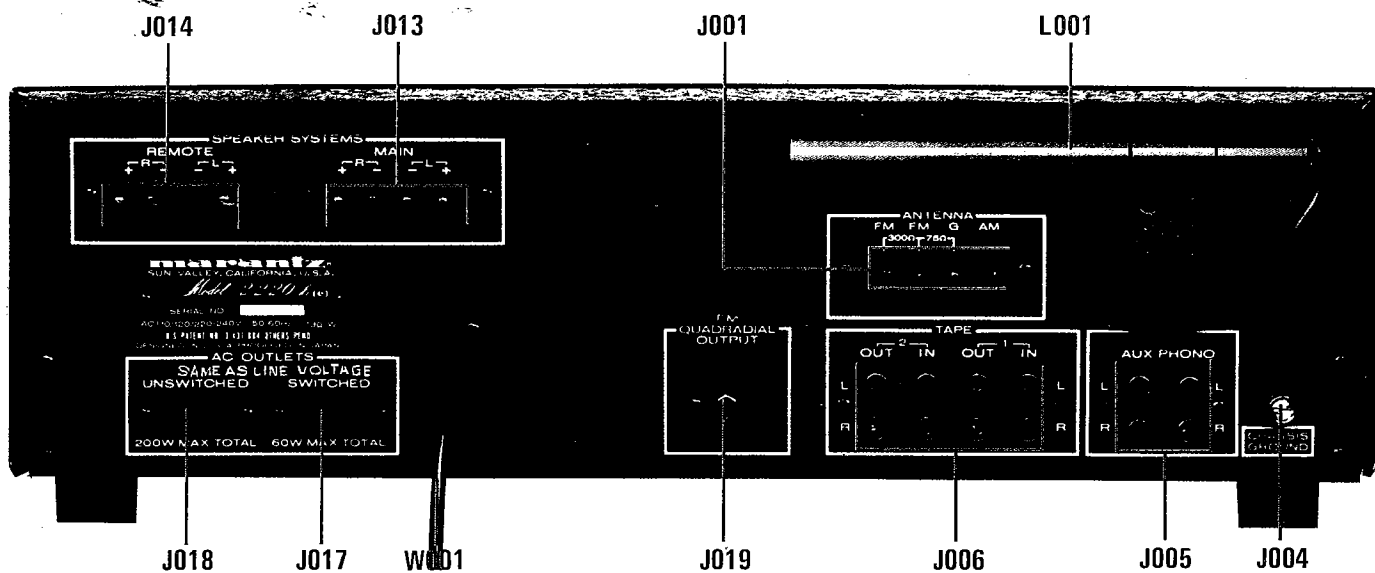

Figure 18. Rear Panel Adjustments and Facilities Locations for European Model

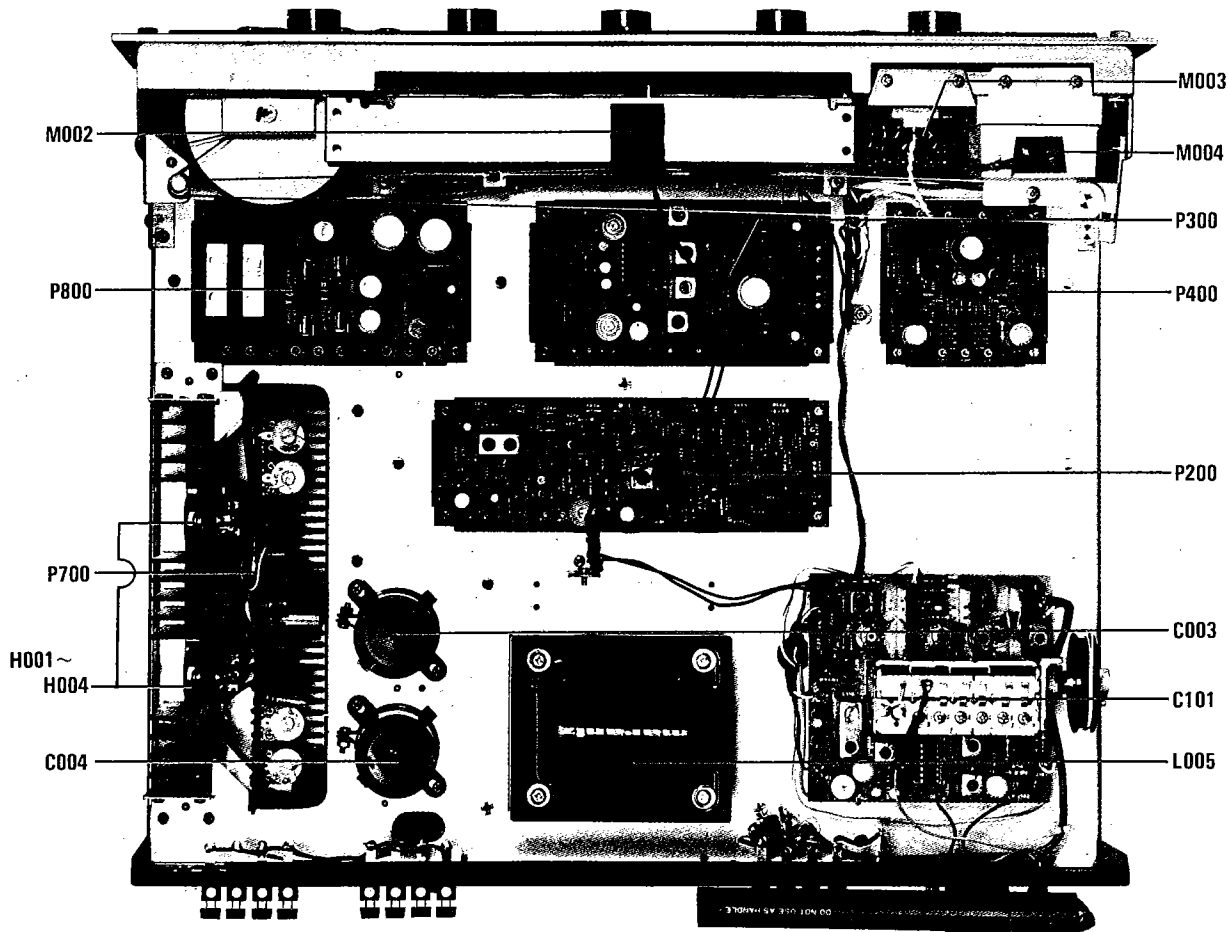

Figure 19. Main Chassis Component Locations (Bottom View) for European Model

VOLTAGE CONVERSION

This model is equipped with a universal power transformer to permit operation at 110, 120, 220 and 240V AC 50 to 60Hz.

To convert the unit to the required voltage perform the following steps:

1. Remove the cover.

2. Change the jumper wires as illustrated below for the required AC voltage.

CAUTION: DISCONNECT POWER SUPPLY CORD FROM AC OUTLET BEFORE CONVERTING TO THE REQUIRED VOLTAGE.

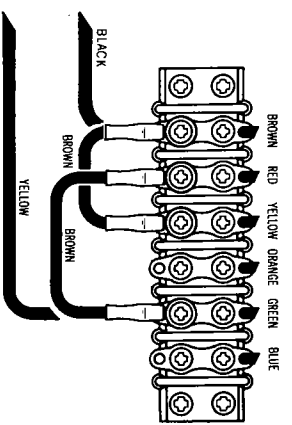

For 110V Operation

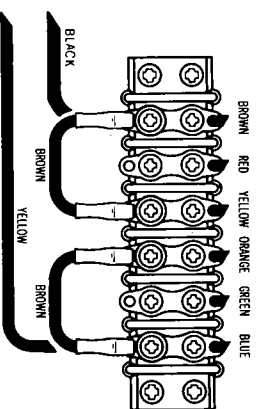

For 120V Operation

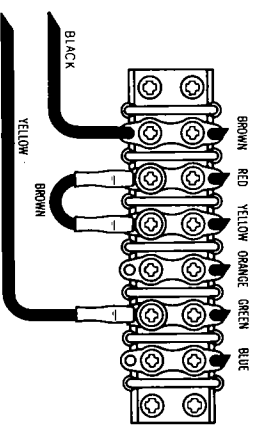

For 220V Operation

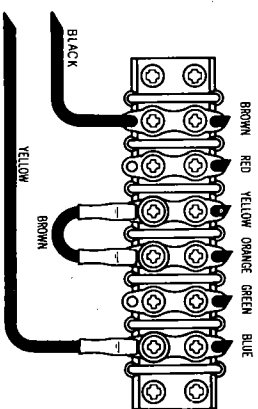

For 240V Operation

Figure 20. Voltage Conversion Chart

Instruction for the use in the range other than specified in FTZ codes

Achtung für die Leute, die in dem Gebiet wohnen, wo die FTZ-Bestimmungen vorherrschend sind.

Bitte das Gerät auch für Frequenzen ausserhalb des in den FTZ-Bestimmungen angegebenen Bereiches empfängbereit sein, bitten wir, den Bereich durch Nachstellen des Kernes in der Induktivitätsspule (in der Abbildung mit "FTZ" gekennzeichnet) so zu korrigieren, dass er den Bestimmungen entspricht.

