

service
manual

20

marantz

model twenty three

Stereophonic Tuner

TABLE OF CONTENTS

	PAGE
Introduction	1
Service Notes	1
AM Tuner	1
FM Tuner	2
FM and AM Tuner Alignment	4
Pre Amplifier	7
Main Output Amplifier	7
Suggestions for Trouble Shooting of Audio Section	-
Protector Relay Circuit	-
Regulated Power Supply	-
Center Tuning Meter Amplifier	9
Test Equipments for Servicing	10
Part List	18

LIST OF ILLUSTRATIONS

FIGURE	PAGE
1 Main Chassis Component Locations Top View	12
2 Main Chassis Component Locations Bottom View	12
3 Rear Terminal Component Locations	13
4 Dial Stringing Diagram	13
5 FM Front End Assembly P100 Component Locations	14
6 AM Front End Assembly P200 Component Locations	14
7 Tone and Pre Amplifier Assembly P400 Component Locations	15
8 AM-FM IF and FM-MPX Demodulator Assembly P500 Component Locations	15
9 Main Amplifier Assembly P600 Component Locations	16
10 DC Amplifier and FM Audio Amplifier Assembly P700 Component Locations	16
11 Speaker Protector Circuit Assembly P980 Component Locations	16
12 Schematic Diagram	17

INTRODUCTION

This service manual was prepared for use by Authorized Warranty Stations and contains service data for the Marantz Model 23 Stereophonic Tuner.

Servicing information and voltage data included in this manual are intended for use by knowledgeable and experienced technicians only. All instructions should be read carefully. No attempt should be made to proceed without a good understanding of the operation of the Tuner. A brief functional description and associated block diagram, furnished in the Operating Instruction Manual for the Model 23 Tuner, provides functional data about the Receiver as an aid in this understanding.

The parts list furnishes information by which replacement parts may be ordered from the Marantz Company. A description is included for parts which can usually be obtained through local suppliers.

1. SERVICE NOTES

As can be seen from the circuit diagram the chassis of the Model 23 consists of the following units. Each unit mounted on a printed circuit board is described within the square enclosed by a bold dotted line on the circuit diagram.

1. FM Front End Unit mounted on PC board, P100
2. AM Front End Unit mounted on PC board, P200
3. AM IF Amplifier, FM IF Amplifier,
FM MPX Stereo Demodulator, and
FM Sub-IF Amplifier mounted on PC board, P500
4. FM Audio Amplifier, and FM Cen-
ter Tuning Meter Amplifier mounted on PC board, P700
5. Pre Amplifier mounted on PC board, P400
6. Main Output Amplifier, and Reg-
ulated Power Supply Unit mounted on PC board, P600
7. Protector Relay Driving Unit mounted on PC board, P980

2. AM TUNER

2.1 Circuit Description

The AM tuner consists of two units, a front end unit mounted on PC board P200 and an IF amplifier unit mounted on a part of PC board P500.

The front end consists of an RF amplifier and a converter. AM signals induced in a ferrite bar antenna are applied to the base of RF amplifier transistor H201 through coupling capacitor C201 and amplified to the level high enough to overcome the converter noise. The tuning circuits placed in the input and the output circuits of the RF amplifier provide very high image ratio and sufficient spurious rejection. Thus amplified and selected signal is applied to the base of converter transistor H202 through coupling capacitor C206. The converter forms a collector-emitter self-oscillation circuit and the local oscillation signal appears at

the emitter of H202. Both the signals are then mixed at the base-emitter junction and converted into 455KHz intermediate frequency. The IF signal obtained from the collector of H202 is applied to the first IF transformer L203.

Diode H203, reverse-biased by resistors R208 and R209, eliminates signal overload distortion without sacrificing any receiving sensitivity.

The IF signal output is led to the IF amplifier consisting of two stages (H510 and H511) through wiring pins J206 and J504, and amplified to high level. The amplified IF output is applied to diode H520 to detect audio signal. Then the detected audio signal is led to output pin J515 through filtering network. The DC component of the detected IF signal is used for AGC control which affects the emitter currents of H510 and RF amplifier transistor H201. A part of IF signal output is also applied to diode H521 through capacitor C562 and rectified into DC current for energizing signal strength meter M001.

2.2 Suggestions for Trouble Shooting of AM Tuner

Symptom: No AM Reception

First try to tune in to stations by rotating the flywheel tuning knob slowly and observe the AM signal strength meter whether it deflects or not. If the signal strength meter gives a deflection at several frequencies received, no failure exists in the stages at least preceding IF transformer L511. Next connect an oscilloscope to tuner output pin J515 and check audio signal. If the signal strength meter does not deflect, check the local oscillator circuit. Normal oscillation voltage at the hot end of the oscillator capacitor is 2 to 3 volts, varying with the tuning capacitor position. When measuring oscillation voltage use an RF VTVM, no circuit tester gives correct indication. If the local oscillation voltage is normal, check all voltage distributions in the tuner circuit by using a circuit tester and compare the measured values with those written in the schematic diagram.

3. FM TUNER

3.1 Circuit Description

The FM tuner section consists of three printed circuit boards, FM front end unit, IF amplifier/MPX stereo decoding unit, and DC meter amplifier/FM audio amplifier unit.

FM signals induced by an FM antenna are led to FM antenna coil L101 through an attenuator switch and a BALUN coil. These signals are then applied to an FET RF amplifier, the amplified output is applied to FET mixer H102 through a double-tuned circuit and converted into 10.7 MHz IF signals. H103 is a local oscillator transistor. The AGC voltage, obtained by rectifying a part of the first IF transformer, is applied to the gate of FET H101 through the network consisting of R110, R111 and R101. The converted IF signals are led to input pin J501 of the IF amplifier unit consisting of three ICs (H501, H502 and H503) and two ceramic filters

having sharp cut off characteristic. The selected and fully amplified IF signal is then applied to FM discriminator transformer L507 and demodulated into audible signal. The demodulated signal is then applied to the base of composite signal amplifier transistor H504 to obtain enough output power necessary to drive the stereo decoding circuit packaged in IC H505. The amplified output is applied to input pin 3 of the IC. Thus R and L channel stereophonic audio signals obtained are led to the R and L channel FM audio amplifiers respectively mounted on a half of PC board P700.

An FM audio amplifier consists of NPN and PNP transistors H705 and H707. The emitter to H705 is coupled to its counterpart in the other channel by separation control resistor R024. The FM audio amplifier amplifies low level FM audio signals to comparable level to those of AM and cancels out undesirable crosstalk in R and L channel signals. The output of the FM audio amplifier is led to the mode switch.

The DC current caused at point E in the FM discriminator circuit is used as a direct current source for driving the FM center tuning meter M002. First the direct current is led to the base of differential amplifier transistor H701 through R514 and antenna tuning switch S004. The amplified differential DC output obtained across the emitters of H703 and H704 drives the center tuning meter. R704 is the trimming resistor for null adjustment of the meter.

Stereo decoding IC H505 is also equipped with an audio muting circuit and an automatic stereo-monophonic switching circuit. Activating signals required for these circuits are obtained from the FM sub-IF amplifier unit consisting of two transistors H506 and H507. The amplifier unit obtains its input signal from the second FM IF amplifier stage through small coupling capacitor C511 and amplifies it. The amplified output is then applied to diode H517 and H518 and rectified into direct current. A part of the DC current is supplied to signal strength meter M001 through resistor R539 and rotary switch S001-2. The other part is applied to the DC amplifier consisting of H508 and H509, and its output is then fed to the muting control pin of IC H505 through muting switch S002 and resistor R518. R004 is a variable resistor for muting level control. Stereo-monophonic automatic switching signal is also obtained from the rectifier circuit and applied to pin 4 of IC H505 through resistors R565, R021, diodes H516 and H515.

The model 23 is equipped with a multipath antenna tuning system for the best FM reception. A simplified principle of the tuning is given as follows. Multipath propagation of an FM signal causes amplitude and phase distortion which deteriorates not only tonal quality but channel separation. The multipath antenna tuning system is employed for the purpose of finding out the optimum antenna direction to reduce the multipath distortion.

A 10.7MHz FM IF signal is applied to the sub-IF amplifier and the amplified output is then rectified by diodes H517 and H518 as explained above. The rectified output is not a precise direct current but includes many amplitude modulated components caused by multipath propagation.

These amplitude modulated components are separated from DC component by C552 and rectified into DC by diode H519 and led to the antenna tuning (FM center tuning) meter amplifier through antenna tuning switch S004. The greater the deflection of the antenna tuning meter, the greater the distortion of signal.

3.2 Suggestions for Trouble Shooting of FM Tuner

3.2.1 Symptom: No FM Reception

First turn on the power switch and try to tune in to FM stations. Rotate the flywheel tuning knob slowly and observe the signal strength meter and the FM center tuning meter. If the FM center tuning meter deflects at several frequencies, the tuner circuits preceding the discriminator circuit may have no failure. When the signal strength meter deflects but no deflection is obtained in the FM center tuning meter, there must be some defects between the final FM IF amplifier H503 and the discriminator circuit. When no reading is obtained in both meters, check the local oscillator circuit by using an RF VTVM. Normal local oscillation voltage is about, 1 to 2 volts at the hot end of the tank circuit. If the oscillation voltage is normal, check all the voltage distributions and compare them with those shown in the schematic diagram. When both meters deflect but no FM station is obtained check the following points by using a high sensitivity oscilloscope; collector of composite amplifier transistor H504, multiplex stereo output pin J507 or J508 and FM audio output terminal J711 or J713.

3.2.2 Symptom: No Stereo Separation

First check the mode switch is in FM stereo position. Connect an FM RF signal modulated by a stereo signal to the FM antenna terminals and check the stereo beacon lamp is turned on or not. When the lamp is not turned on, connect an oscilloscope to the test point F and observe 38KHz stereo sub-carrier is correctly generated or not.

4. FM AND AM TUNER ALIGNMENT

The following alignment requires many precision measuring equipments shown in P-10. No alignment should be performed in the field unless the service man has these equipments and enough knowledge in solid state amplifier components, since all the units are factory aligned and not become misaligned by themselves.

4.1 AM Front End

Local Oscillator and Tracking Alignment

- 1) Set an AM signal generator to 600KHz, 400Hz 30% modulation. Tune the receiver to the same frequency and adjust oscillator coil L202 until the dial pointer coincides with the 600KHz marking on the

dial.

- 2) Set the AM signal generator to 1400KHz. Tune the receiver to the same frequency and adjust the trimming capacitor mounted on the tuning capacitor until the dial pointer coincides with the 1400KHz marking on the dial.
- 3) Repeat procedure 1 and 2 until no further adjustment is necessary between the low end and the high end.
- 4) Set the generator to 600KHz. Tune the receiver to the same frequency and adjust antenna coil L001 in a plastic case and RF coil L201 for maximum output.
- 5) Set the generator to 1400KHz. Tune the receiver to the same frequency and adjust each antenna trimming capacitor and RF trimming capacitor mounted on the tuning capacitor for maximum output.
- 6) Repeat procedure 4 and 5 until no further improvement is obtained.

4.2 AM IF Amplifier

For aligning the AM IF amplifier, a sweep generator with marker generator combined is necessary.

- 1) Connect a sweep generator across pin J205 and common ground, connect an oscilloscope to test pin J527.
- 2) Turn each primary and secondary core of IF transformers L203, L501 and L511 for maximum and symmetrical response.

4.3 FM Front End

4.3.1 Local Oscillator Adjustment

- 1) Measuring instruments connection
Connect an FM signal generator to the FM antenna terminals. Connect a VTVM or an oscilloscope to the output jack.
- 2) Set the FM signal generator to 90MHz, 400Hz 100% modulation. Tune the receiver to the same frequency and adjust oscillator coil L104 until the dial pointer coincides with the 90MHz marking on the dial.
- 3) Set the FM signal generator to 106MHz. Tune the receiver to the same frequency and adjust trimming capacitor C119 until the dial pointer coincides with the 106MHz marking on the dial.
- 4) Repeat procedure 2 and 3 until no further adjustment is necessary between the low end and the high end.

4.3.2 FM Tracking Alignment

- 1) Set an FM signal generator to provide about 5uV at 90MHz. Tune

the receiver to the same frequency and turn each core of L101, L102 and L103 for maximum output.

- 2) Set the FM signal generator to 106MHz. Tune the receiver to the same frequency and adjust trimming capacitors C104, C110 and C112 for maximum output.
- 3) Repeat procedure 1 and 2 until no further improvement is obtained.

4.4 FM IF Amplifier

To align the IF amplifier, connect an FM signal generator to the FM antenna terminals and set the generator to 98MHz, 400Hz 100% modulation with its output level about 5uV. Tune the receiver to this frequency and turn each core of IF transformers, L105 and L519 for maximum output. To align the discriminator transformer L507, increase the FM signal output level to about 2KuV and connect a distortion meter to the output jack.

- 1) First, tune the receiver off station to only the interstation noise is heard, then turn the secondary core of L507 so that the pointer of center tuning meter indicates its center.
- 2) Tune the receiver to a 98MHz FM signal again with the center tuning meter in its null position, then turn the primary core of discriminator transformer L507 so that minimum distortion is obtained.

4.5 FM Stereo Demodulator

A stereo multiplex and RF FM signal generator is required to make the separation adjustment on this circuit.

Perform the following adjustments in sequence.

- 1) Set an FM signal generator to 97MHz, 2KuV output level. Tune the receiver to the same frequency, be sure the pointer of center tuning meter is at the center position, and the mode switch is in its FM stereo position.
- 2) Connect an oscilloscope probe to pin J526 and turn each core of L514, L512 and L513 for maximum stereo carrier wave on the CRT.
- 3) Turn the core of L514 again to obtain equal stereo separation in both of R and L channels.
- 4) Adjust trimming resistor R024 for maximum and equal stereo separation in both channels.

Note: In early units no trimming resistor is provided.

4.6 FM Sub-IF Amplifier Alignment

To align the sub-IF amplifier, tune the receiver to an FM signal and turn each core of L508 and L509 so that the signal strength meter reads maximum deflection.

5. PRE AMPLIFIER

A signal selected by the mode switch is led to the pre amplifier via volume control potentiometer R007. The pre amplifier makes use of two transistors H401 and H403 in a connection similar to the FM audio amplifier except utilization of a bootstrap configuration for high input impedance and elimination of separation control resistor. The amplified signal is then led to the main output amplifier.

6. MAIN OUTPUT AMPLIFIER

A signal from the pre-amplifier is applied to the base of H601 through coupling capacitor C601. High input impedance is provided by a bootstrap configuration utilized with H601. The output signal from H601 is led to the base of driver transistor H603 providing the voltage amplification necessary to drive the output stage consisting of H605 and H607 which are operated in a complimentary-symmetry configuration. The combined operation of PNP transistor H605 and NPN transistor H607 provides single ended push pull output across loading resistor R636. This output is applied to output terminal J003 through R009.

Potentiometer R638 placed across the inputs of R and L channels is for balance setting. Usually it is set at its mechanical center and seldom needed realignment.

To maintain overall stability and linearity, negative feed back is utilized throughout the amplifier. This feedback is also necessary to reduce distortion to be well under the specified limits. R620, C621 and R609 condition the feedback signal for application to the emitter of H601.

7. SUGGESTIONS FOR TROUBLE SHOOTING OF AUDIO SECTION

7.1 Symptom: No Output for Both Channels

Check for defective power supply circuit and protector relay circuit.

7.2 Symptom: No Output or Distorted Signal for One Channel

1) Check for shorted or open transistors H401, H403, H601, H603, H607 and H605 or their counterparts in the channel being concerned.

2) Check all the voltage distributions and compare them with those shown in the schematic diagram.

Note: Connecting an audio signal generator to the TAPE OUT jack and checking input and output of each stage will be helpful to find out a bug in the audio section. For example, if the signal at the base of H601 is all right but no signal or distorted signal is obtained at the collector of H601, there must be a bug around H601.

8. PROTECTOR RELAY CIRCUIT

8.1 Circuit Description

The protector relay circuit mounted on PC board P980, prevents the system from developing any loud "POP" sound. The relay driving circuit makes use of two transistors H982 and H983. The circuit is designed so as to short circuit the output jacks and the tape out jacks for the first several seconds after the power switch is turned on by the time constant of capacitor C982 and resistor R984.

8.2 Suggestions for Trouble Shooting of the Protector Relay Circuit

8.2.1 Symptom: No Output Signal at All Times

- 1) Check for shorted capacitors, C982 and C983.
- 2) Check for open transistors, H982 and H983.
- 3) Check for open resistors, R984 and R986.
- 4) Check for open diodes, H003 and H004.
- 5) Check for open relay, L005.

8.2.2 Symptom: "POP" Noise Appearance

- 1) Check for open or low value capacitor, C982.
- 2) Check for shorted transistors, H982 and H983.
- 3) Check for shorted resistor, R984.
- 4) Check for defective relay, L005.

9. REGULATED POWER SUPPLY

9.1 Circuit Description

The regulated power supply unit consisting of transistor H617 and zener diode H611 mounted on a part of PC board P600 supplies its regulated DC current to each unit of main output amplifier, FM audio amplifier, and pre-amplifier. The base of transistor H617 is well fixed at 30V by zener diode H611 and H617 regulates its output voltage at about 29V. Regulator transistor H617 also works as a ripple filter in conjunction with C618. Any short-circuit of the 29V DC output line may damage transistor H617. Be extremely careful not to make a short-circuit.

9.2 Suggestions for Trouble Shooting of Regulated Power Supply

9.2.1 Symptom: No Output

Check for

- 1) Open transistor H617.
- 2) Shorted capacitors C009, C616, C617, C618 and C619.
- 3) Open power transformer L004.
- 4) Open resistor R635.

9.2.2 Symptom: Excessive Output Voltage

Check for

- 1) Shorted transistor H617.

- 2) Open zener diode H611.
- 3) Shorted resistor R634.

9.2.3 Symptom: Inadequate Output Voltage, Excessive Ripple

Check for

- 1) Open or low value capacitors C009, and C619.
- 2) Defective diodes H613, H614, H615 and H616.

10. CENTER TUNING METER AMPLIFIER

A differential amplifier consisting of four transistors H701, H702, H703 and H704 is used to drive center tuning meter M002. The input current to the differential amplifier is obtained from the FM discriminator through resistor R514 and antenna tuning switch S004. The null adjustment of this meter amplifier is achieved by adjusting potentiometer R704 with the mode switch placed in the AM position.

11. TEST EQUIPMENTS FOR SERVICING

Item	Manufacturer and Model No.	Use
AM Signal Generator		Signal Source for AM Alignment
Test Loop		Used with AM Signal Generator
FM Signal Generator	Less than 0.3% distortion	Signal source for FM Alignment
Audio Oscillator	Less than 0.02% residual distortion is required	Sine wave source for modulating AM or FM Signal Generator, or trouble shooting
Stereo Modulator	Less than 0.3% distortion	Modulating FM Signal Generator for Separation Alignment and trouble shooting
Oscilloscope	High Sensitivity	Wave form analysis and trouble shooting
VTVM	With RF probe	Trouble shooting
Circuit Tester		Trouble shooting
Sweep Generator	For 455KHz and 10.7MHz IF alignment	AM and FM IF alignment
Line Voltmeter	0 - 150V AC	Line voltage monitor
Variable Auto Transformer	0 - 140V, 10 A	Line voltage adjuster

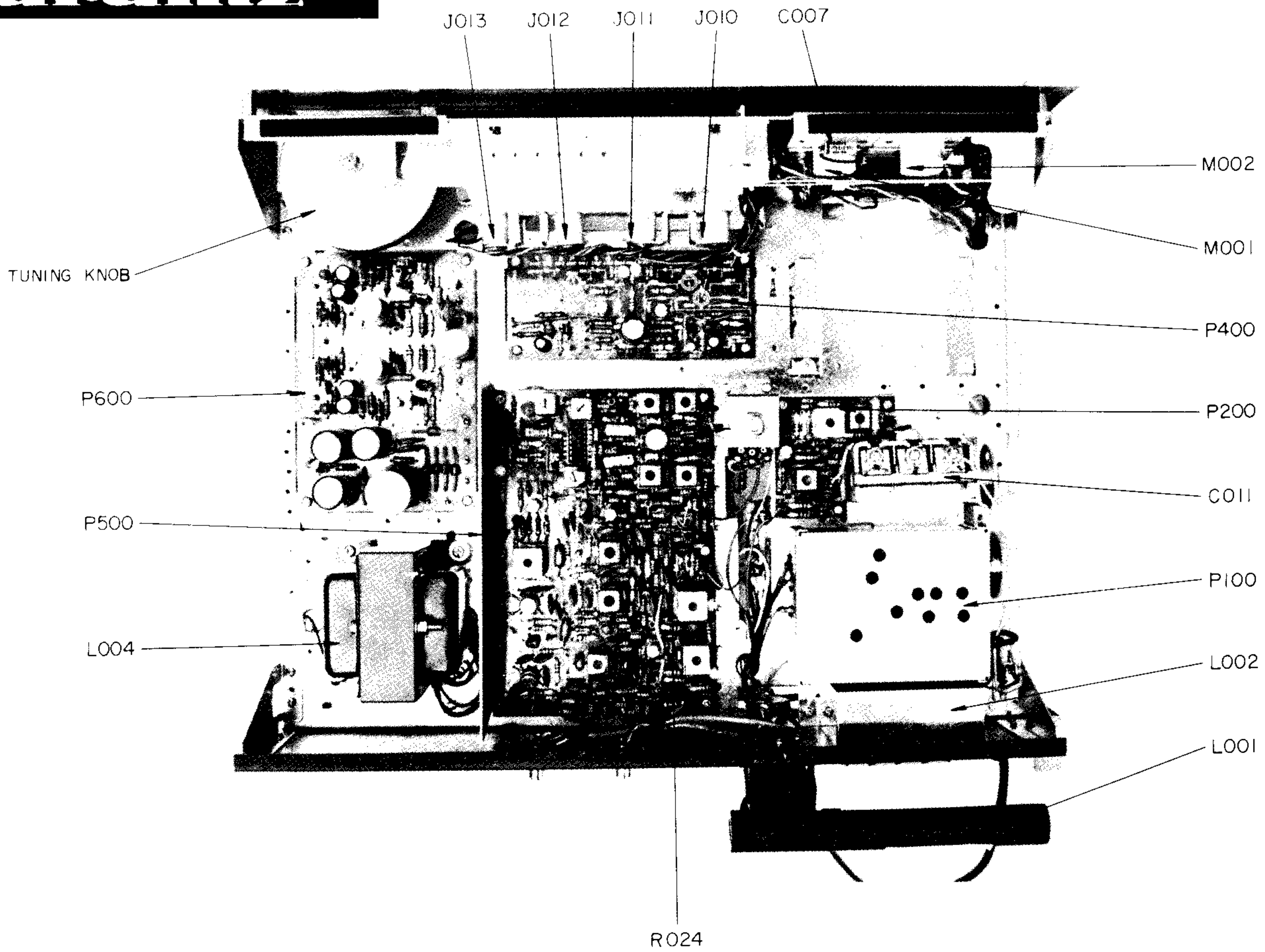

Figure 1 Main Chassis Component Locations Top View

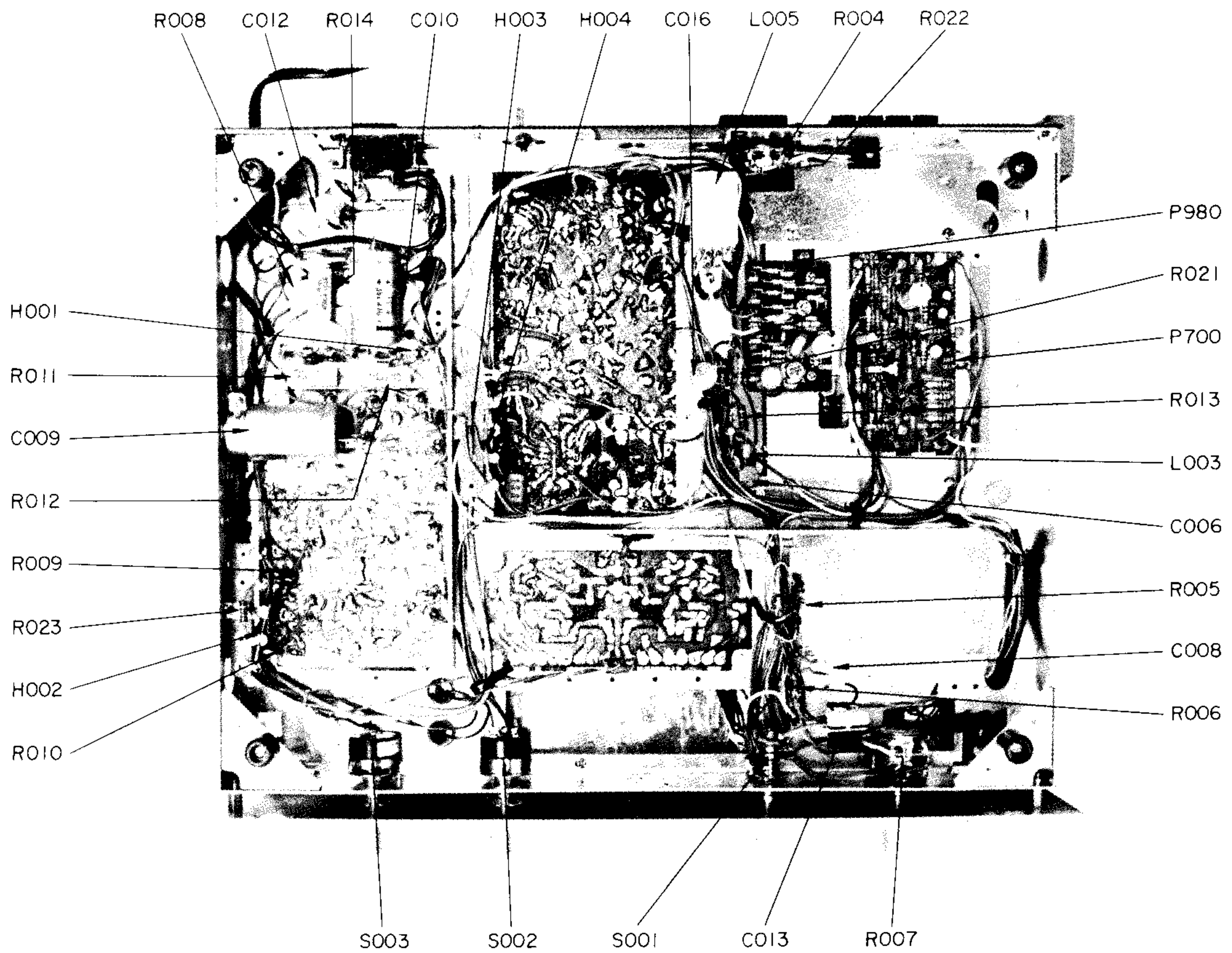

Figure 2 Main Chassis Component Locations Bottom View

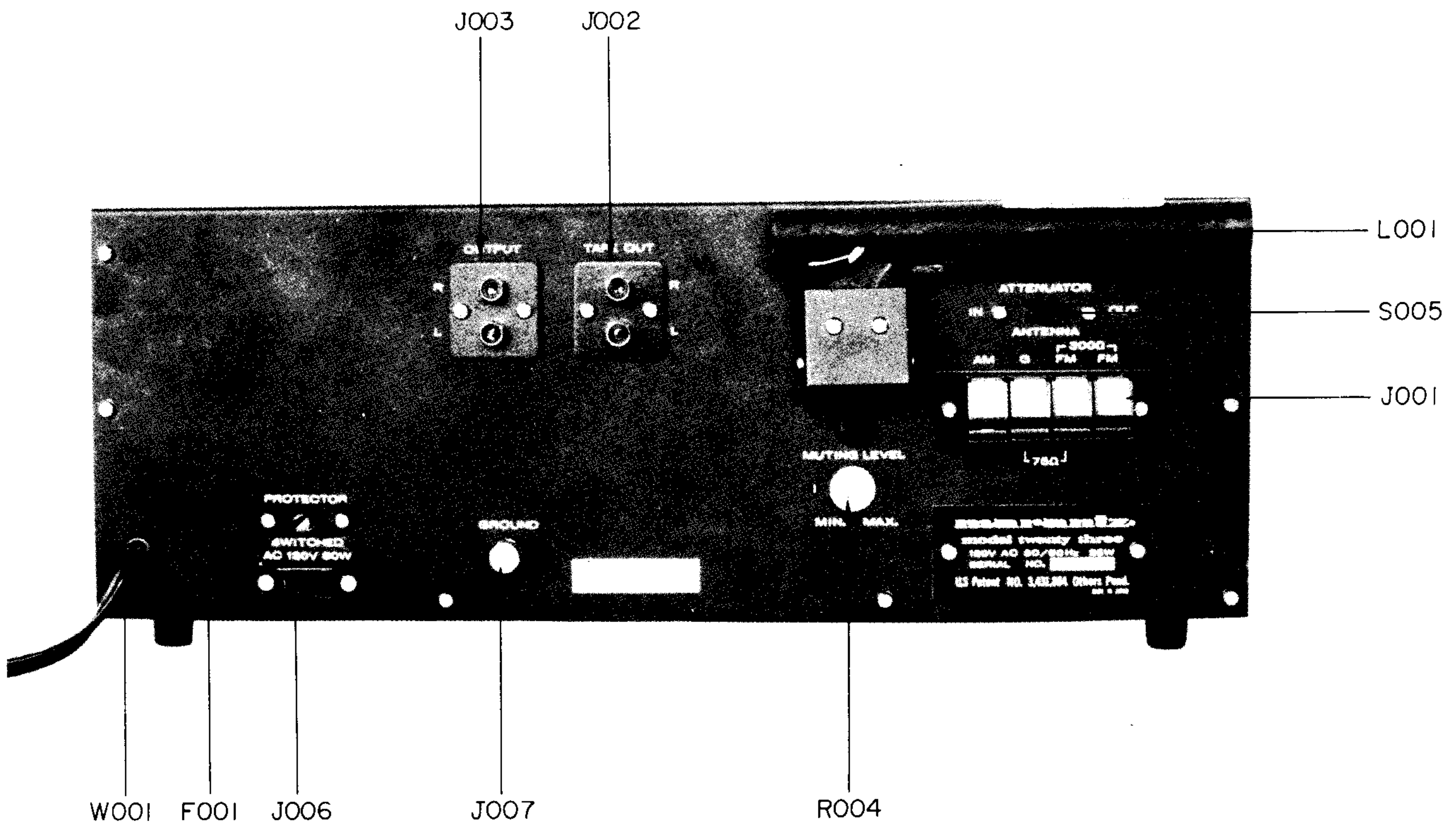

Figure 3 Rear Terminal Component Locations

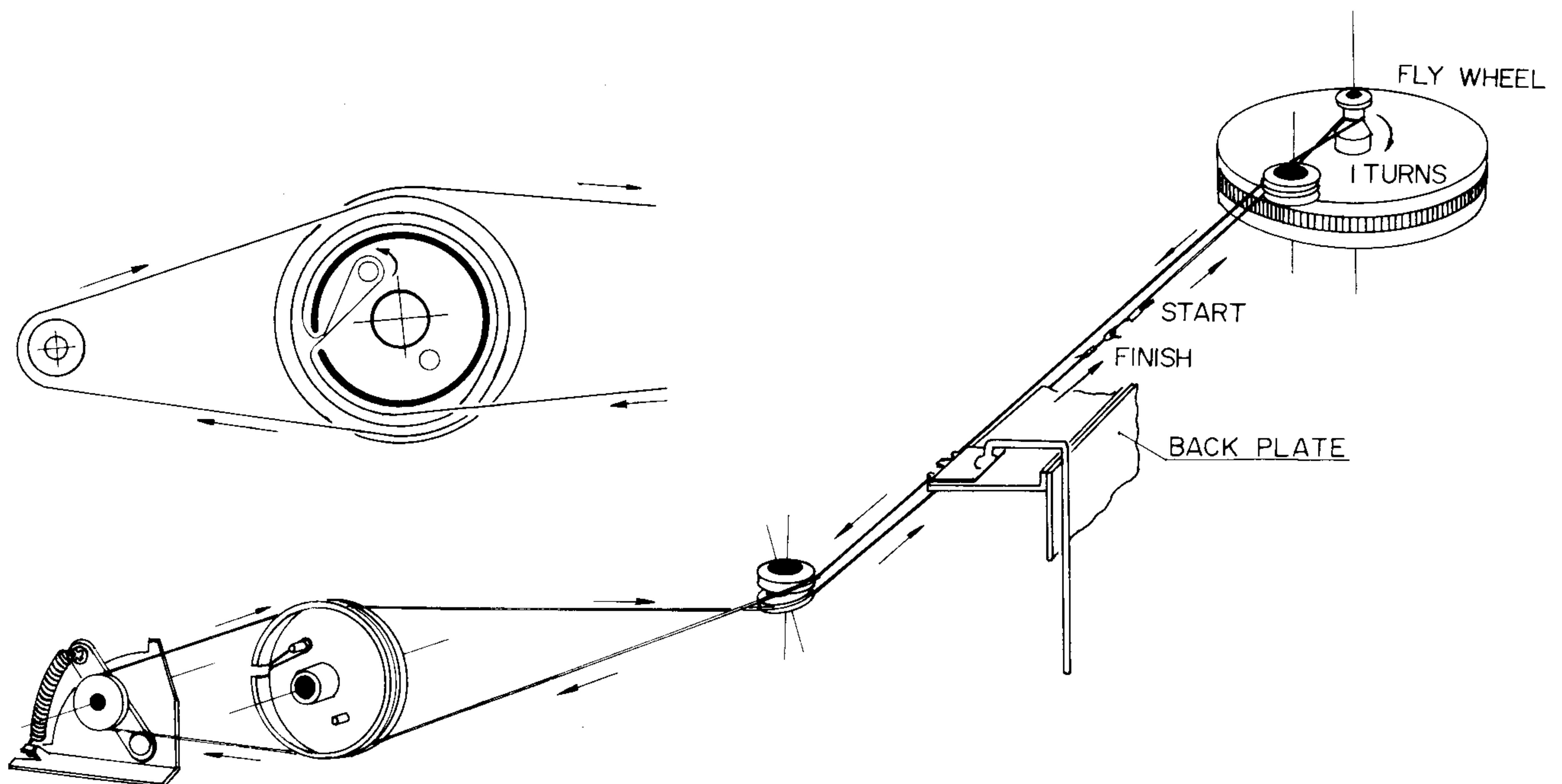

Figure 4 Dial Stringing Diagram

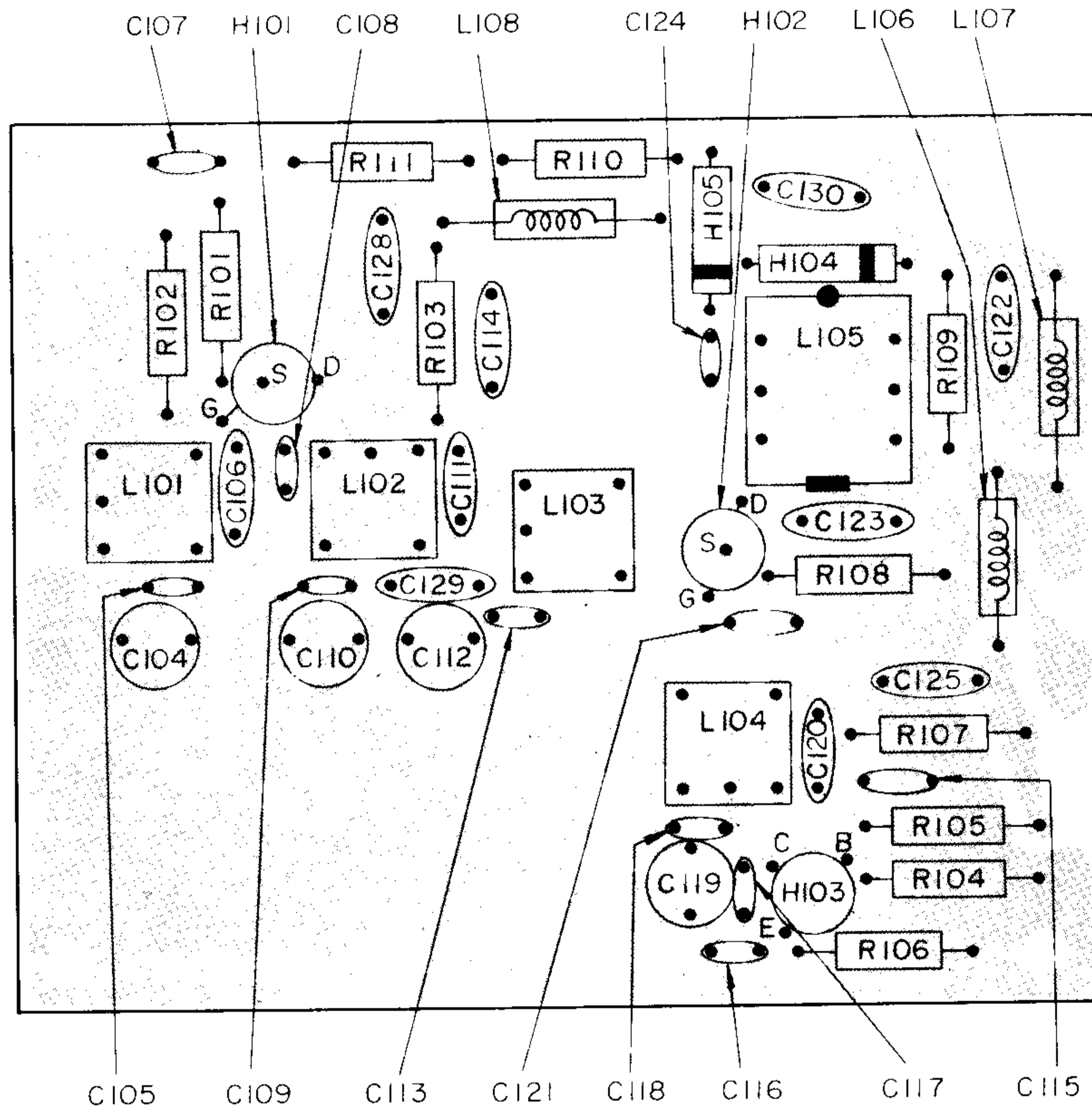

Figure 5 FM Front End Assembly P100 Component Locations

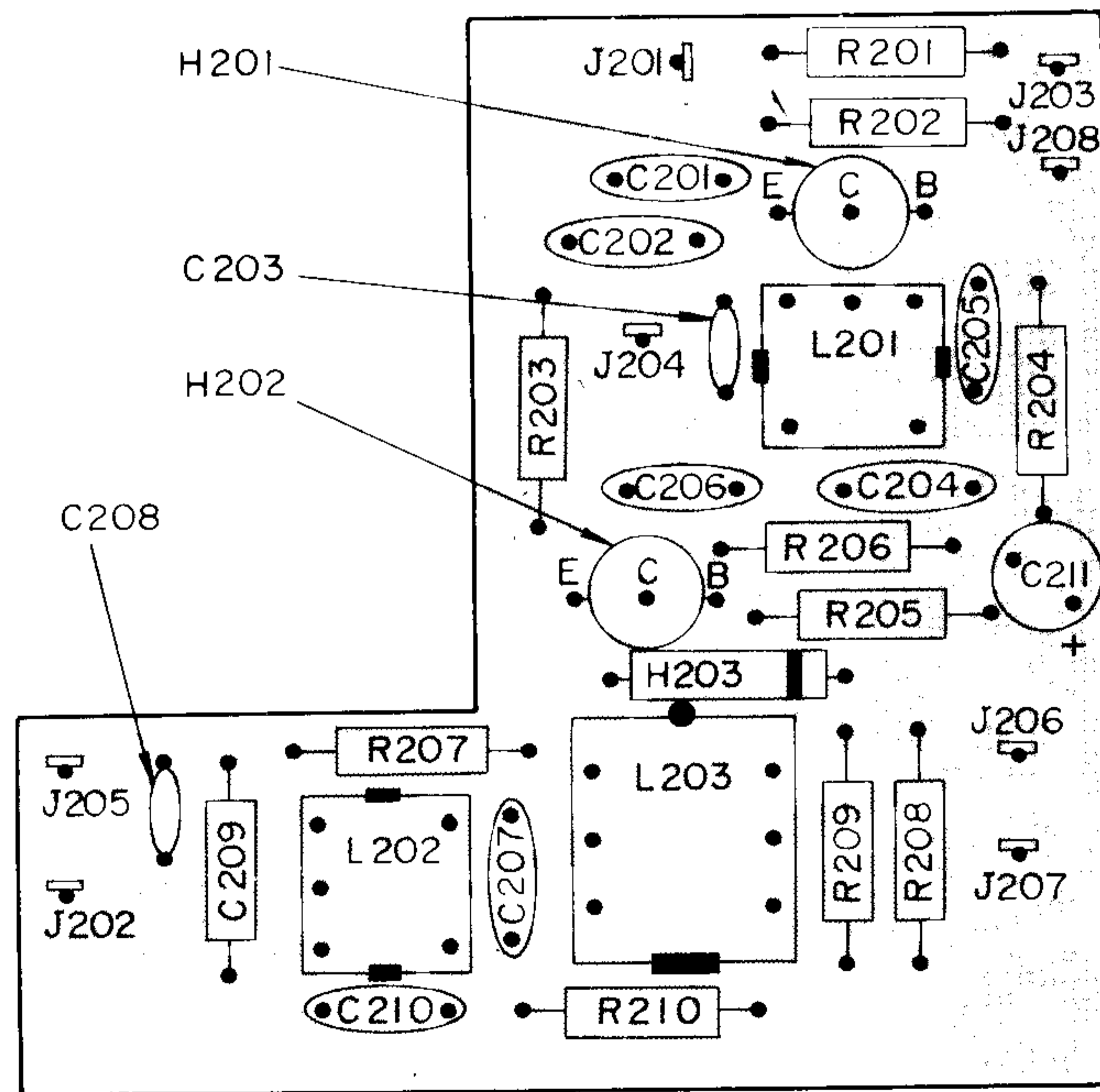

Figure 6 AM Front End Assembly P200 Component Locations

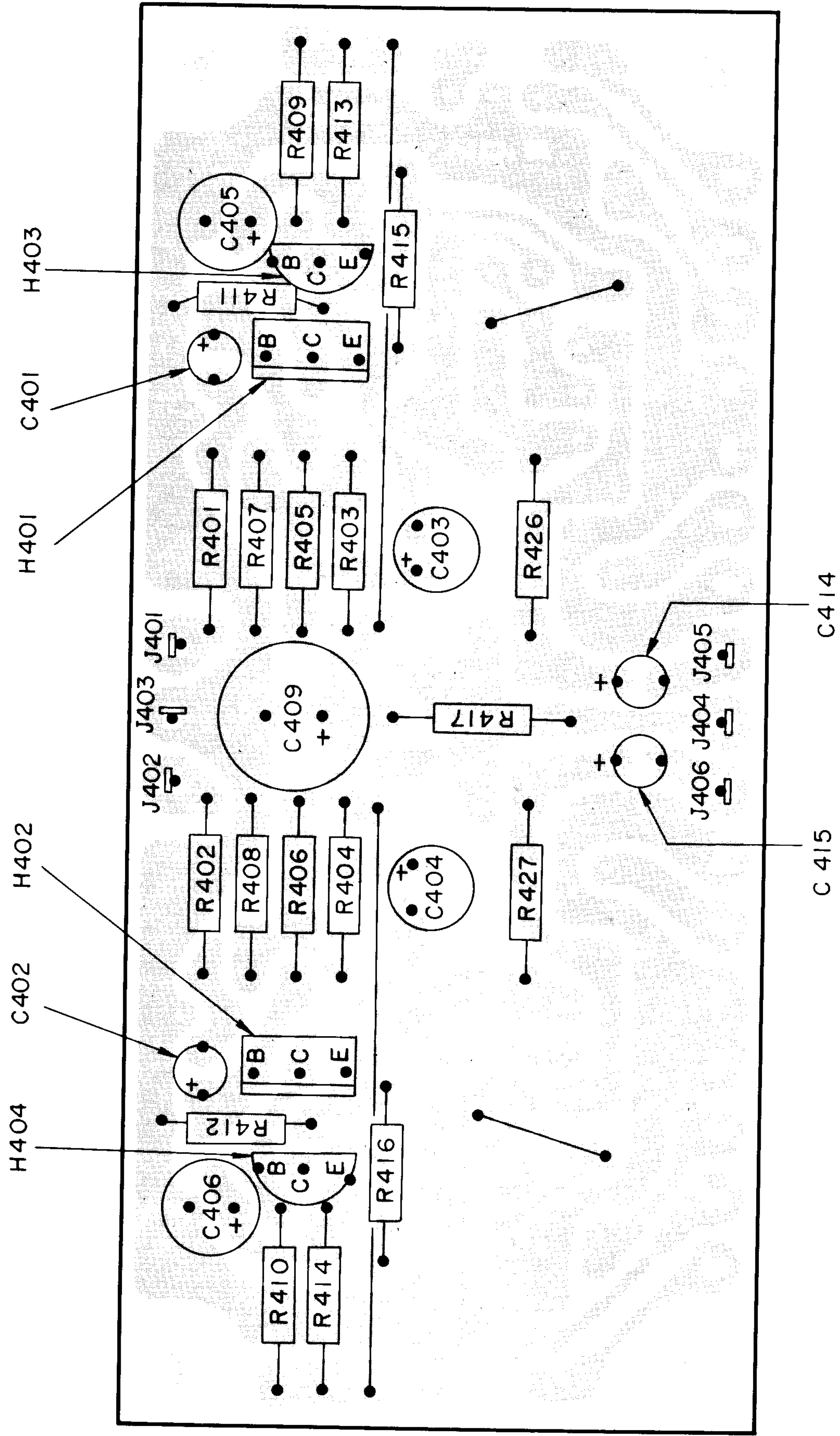

Figure 7 Tone and Pre Amplifier Assembly P400 Component Locations

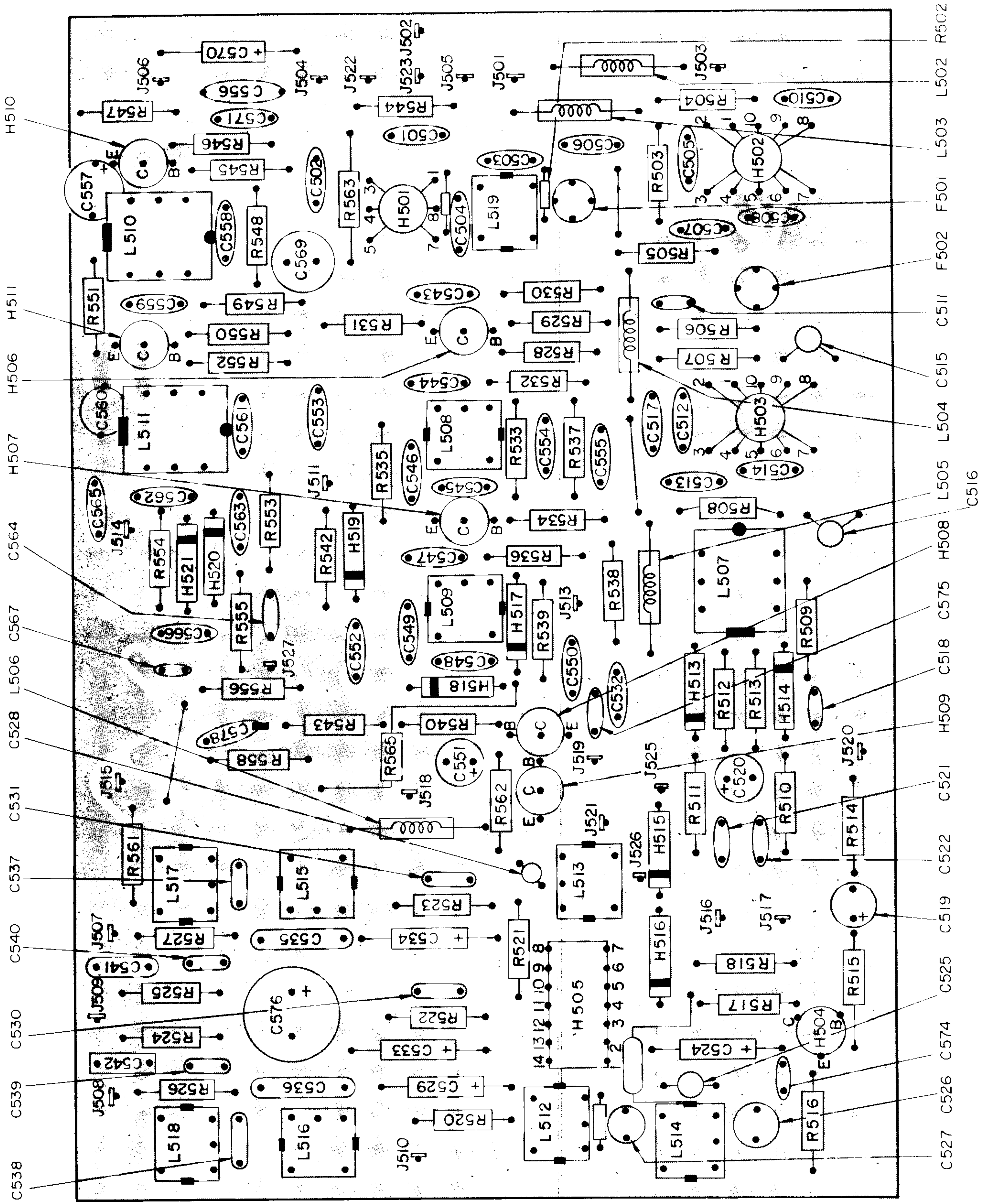

Figure 8 AM-FM IF and FM-MPX Demodulator Assembly P500 Component Locations

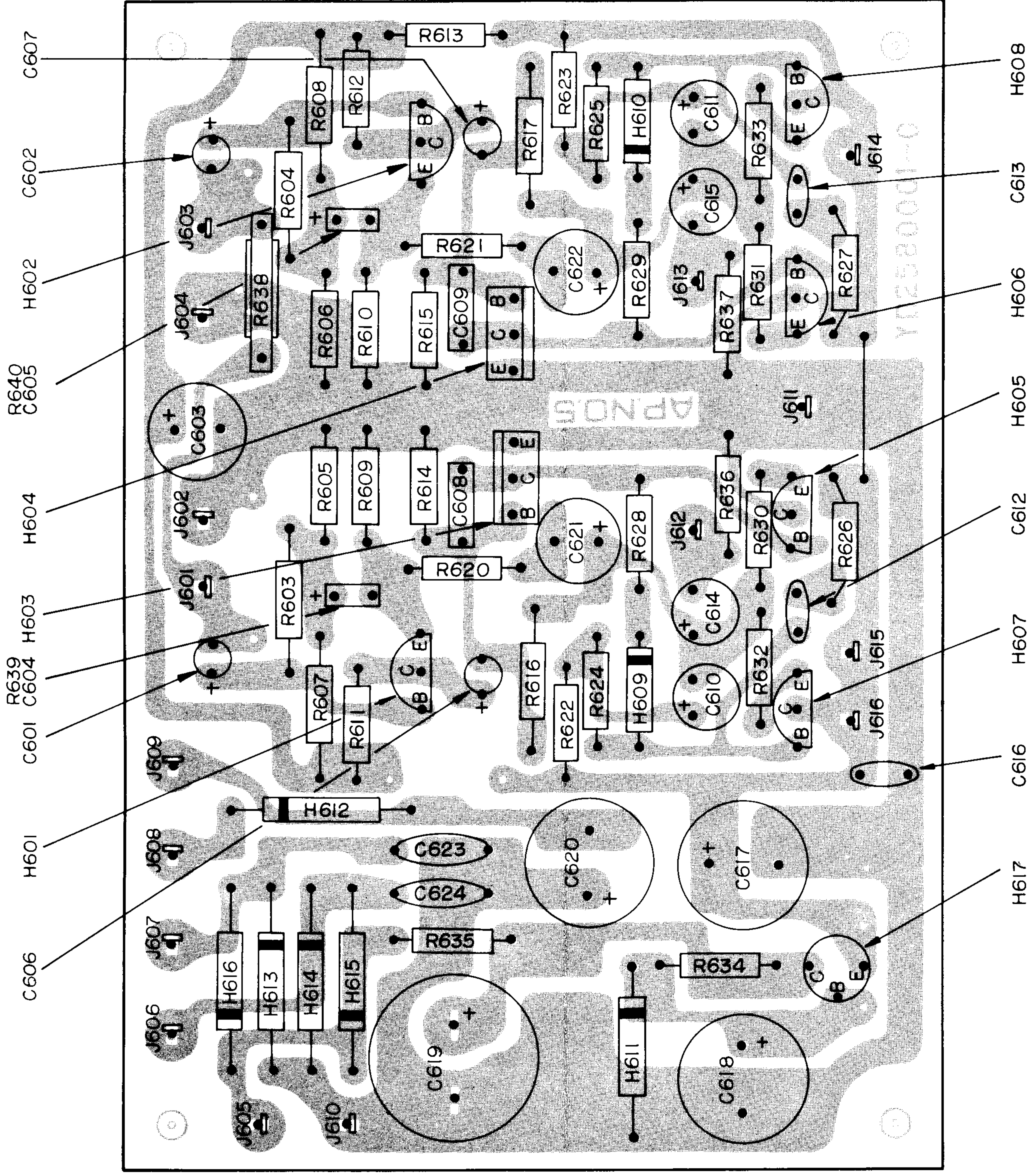

Figure 9 Main Amplifier Assembly P600 Component Locations

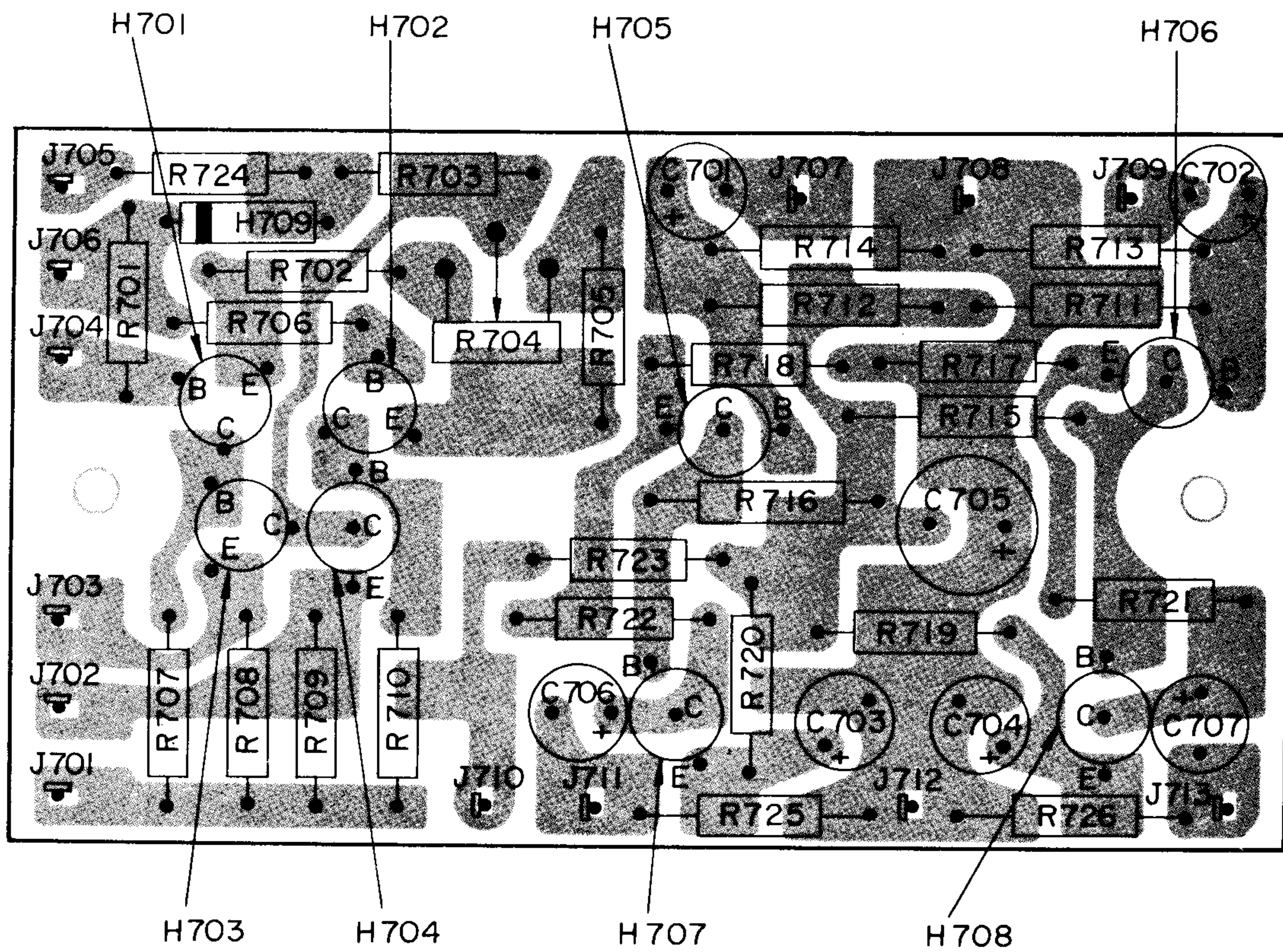

Figure 10 DC Amplifier and FM Audio Amplifier Assembly P700 Component Locations

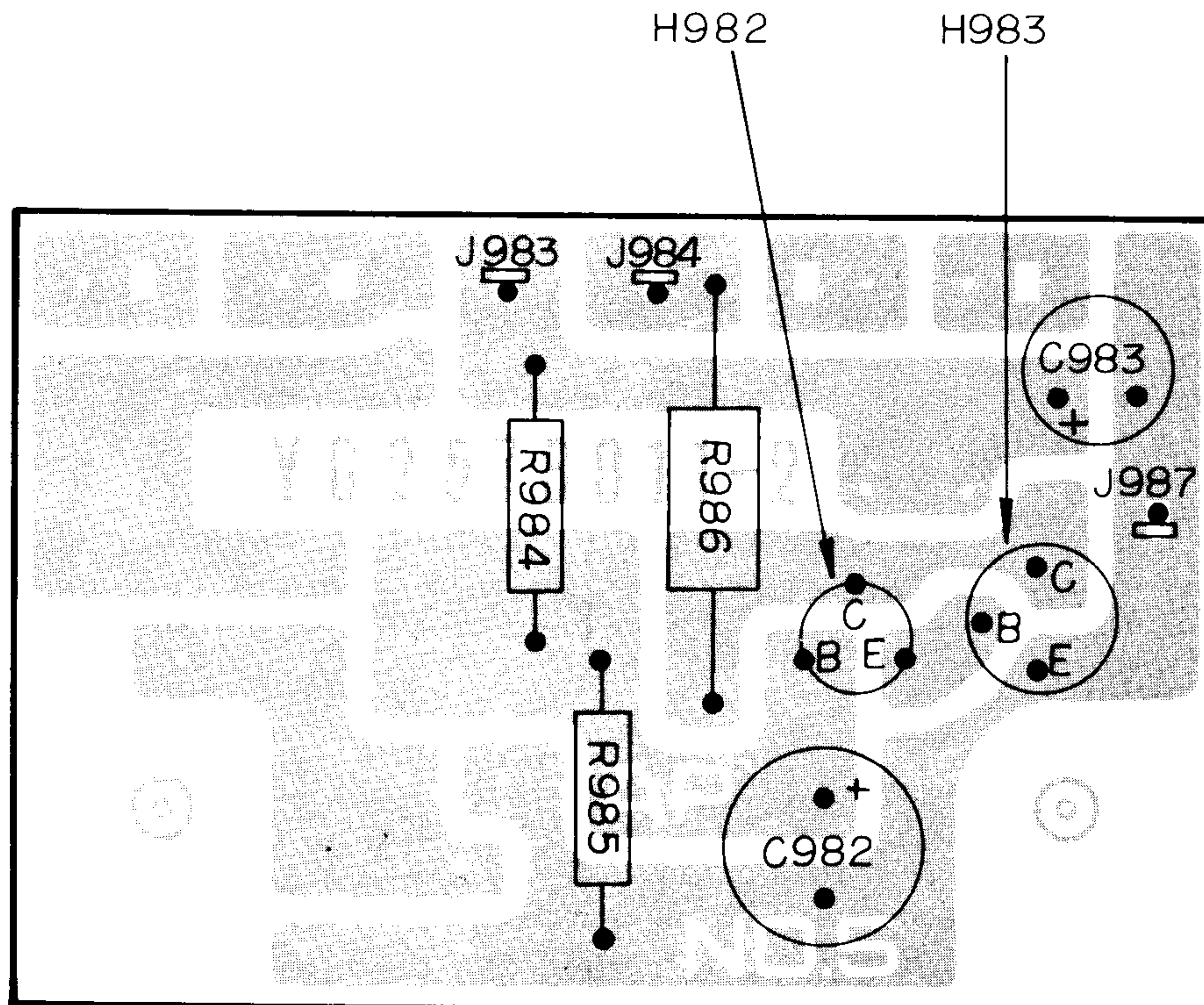

Figure 11 Speaker Protector Circuit Assembly P980 Component Locations

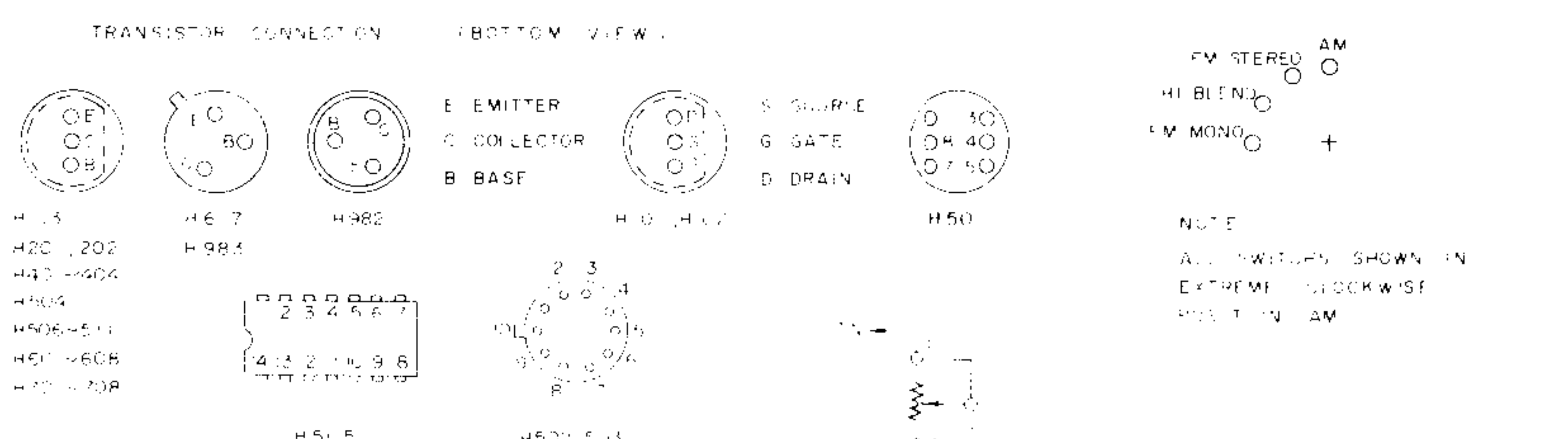
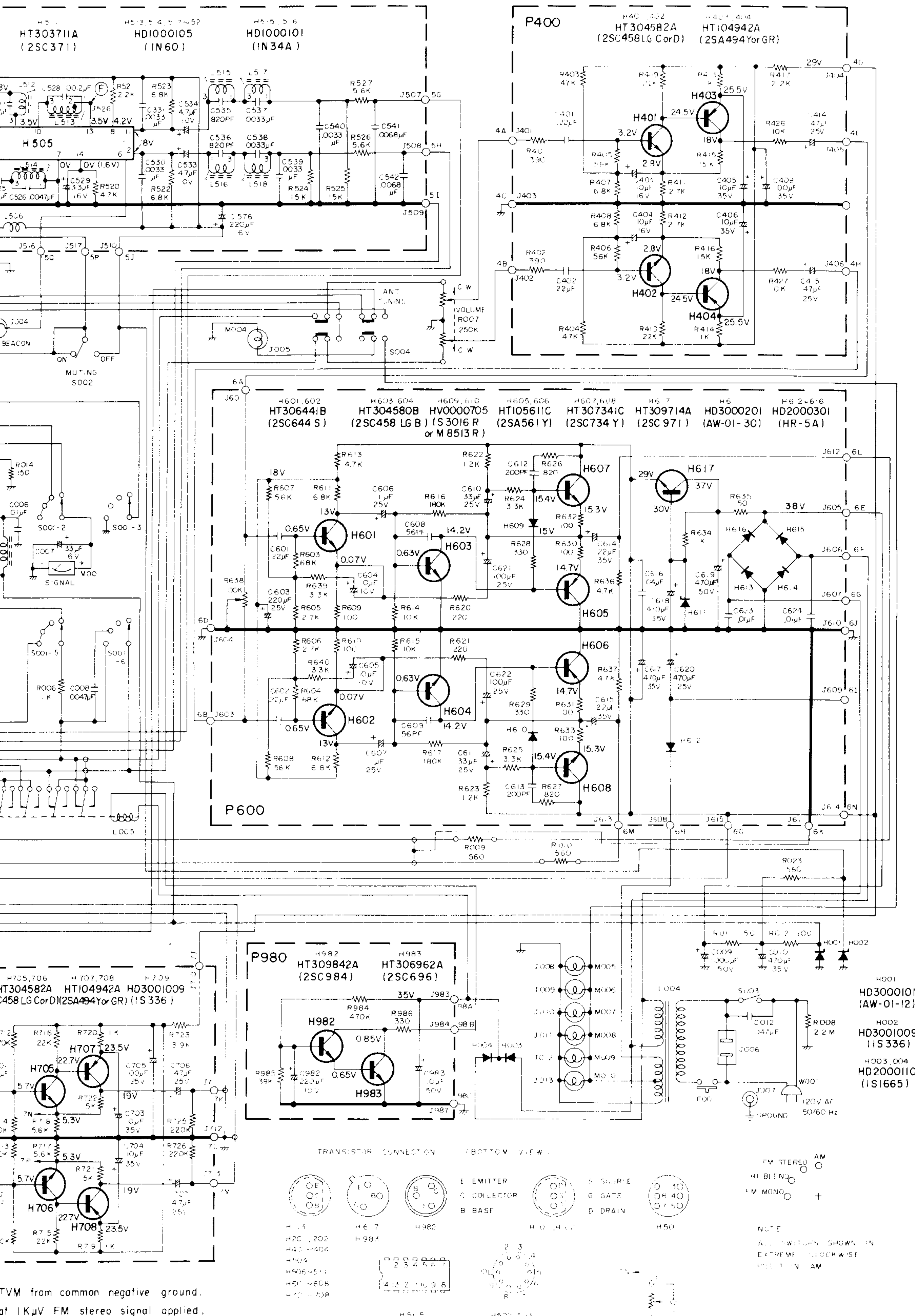
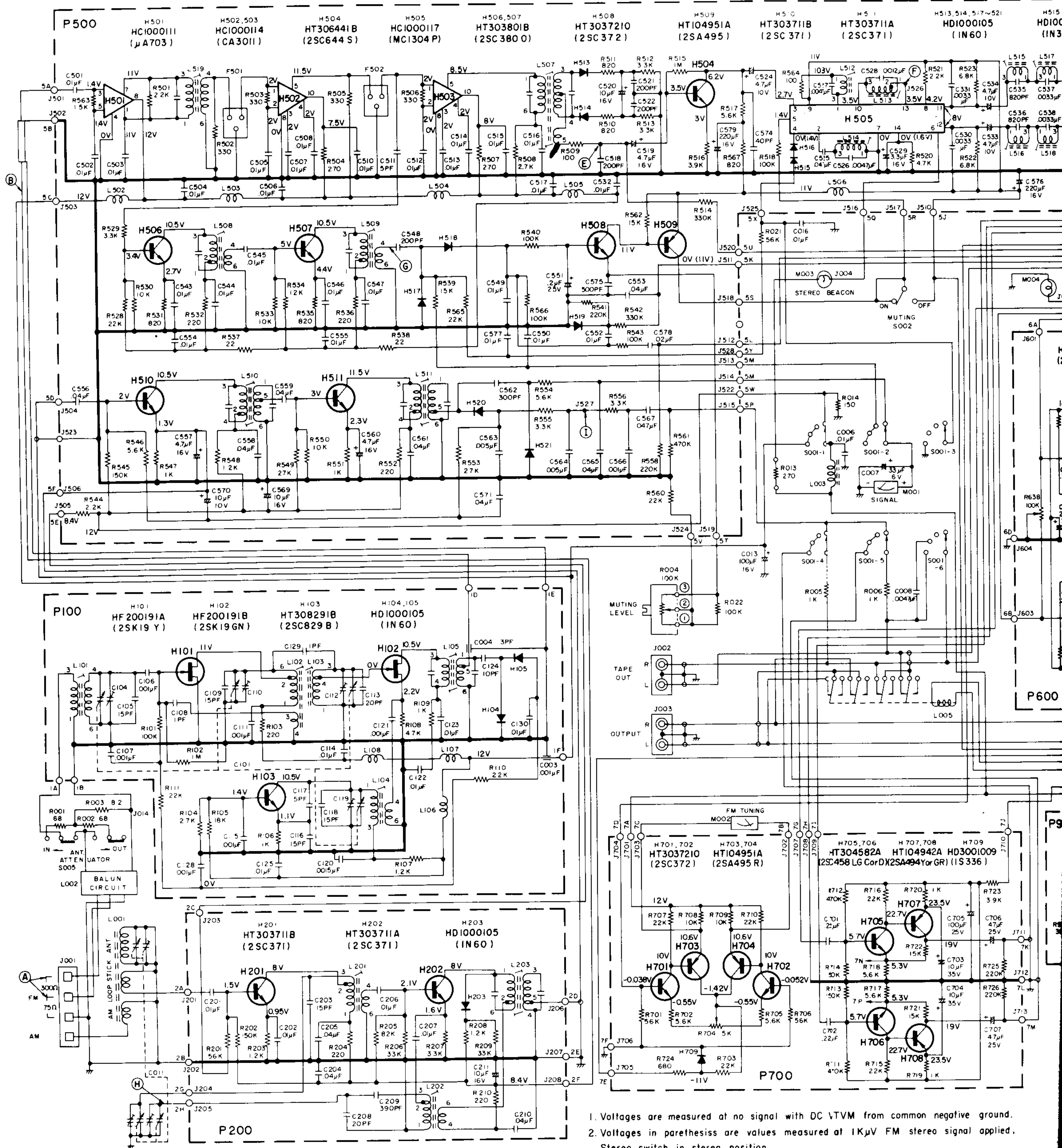

Figure 12 Schematic Diagram



1. Voltages are measured at no signal with DC VTVM from common negative ground.
 2. Voltages in parentheses are values measured at 1KμV FM stereo signal applied.
 Stereo switch in stereo position.

PARTS LIST

REF DESIG.	MARANTZ PART NO.	DESCRIPTION	REF DESIG.	MARANTZ PART NO.	DESCRIPTION
A001	258006301-3	Escutcheon	B049	258005101-0	Pointer Guide
A002	258025701-3	Lid	B050	254811201-0	Pointer Shaft
A003	258026501-0	Indicator	B053	257810650-0	Flywheel Bearing K
A004	257810301-2	Pointer	B054	257810401-0	Flywheel Retainer
A005	258016001-2	Bracket	B055	257710601-0	Flywheel Bearing
A008	257706302-2	Escutcheon	B057	258005301-0	Lamp Cover
A009	257727301-0	Fly Wheel	B059	257811202-2	Flywheel Shaft
A010	257706303-2	Escutcheon	B061	53228059E-0	Muting Level Nut
A012	257806701-0	Volume Knob Cap	B062	54012159I-0	Muting Level Washer
A013	257806701-0	Mode Knob Cap	B064	257810104-0	Escutcheon Support
A014	257806701-0	Muting Knob Cap	B065	257810104-0	Escutcheon Support
A015	257806701-0	Power Knob Cap	B066	257810104-0	Escutcheon Support
A501	258040101-2	Frame	B067	257810104-0	Escutcheon Support
A502	258030201-0	Dial	B081	257810950-0	FM Tuner Shield K
A503	258010701-3	Sheet	B082	257810901-0	FM Tuner Shield
A505	258010703-0	Dial Sheet	B083	257810102-0	FM Tuner Support
A506	257815401-0	Volume Knob	B084	257810102-0	FM Tuner Support
A507	257815401-0	Mode Knob	B085	257810102-0	FM Tuner Support
A508	257815401-0	Muting Knob	B086	257810102-0	FM Tuner Support
A509	257815401-0	Power Knob	B088	257810902-0	FM Tuner Shield Lid
A518	257815401-0	Antenna Tuning Knob	B092	258010902-0	ATTENUATOR Shield
B001	258025702-2	Lid	B094	258016052-0	Tuner Block Bracket K
B003	258010550-3	Chassis K	B095	257816004-2	Tuner Block Bracket
B004	258010501-3	Chassis K -	B096	257811201-0	Tuner Block Shaft
B005	257816001-2	Bracket	B097	257710101-0	Tuner Block Support
B006	257816001-2	Bracket	B098	257710101-0	Tuner Block Support
B007	257816002-0	Bracket	B100	257816010-0	Left Bracket
B008	257816002-0	Bracket	B101	257816011-0	Right Bracket
B009	257816002-0	Bracket	B102	257816013-2	Meter Bracket
B010	257816002-0	Bracket	B110	120225801-0	Tuning Dial Hook
B013	258016050-3	Front Bracket	B111	71101239M-0	Tuning Dial Spring
B014	258016002-2	Front Bracket	B112	258016006-0	MPX Stereo Lamp Bracket
B015	257810101-0	Front Bracket Support	B121	257716017-0	Circuit Breaker Bracket
B016	257810101-0	Front Bracket Support	B123	258026701-0	Heat-Sink
B017	257810101-0	Front Bracket Support	B124	257905502-0	ANT Tuning Switch Collar
B018	257810101-0	Front Bracket Support	B125	257905502-0	ANT Tuning Switch Collar
B020	257816052-2	AM Antenna Bracket K	B127	257816015-2	Relay Bracket
B021	257816005-2	AM Antenna Bracket	B128	257916002-0	Relay P.C. Board Bracket
B023	257816006-2	AM Antenna Bracket	B129	272216003-0	VR Bracket
B024	55020304I-0	AM Antenna SH Rivet	B131	124705850-0	Gear K
B025	55020304I-0	AM Antenna SH Rivet	B132	124705801-0	Gear
B026	258010901-0	Shield	B133	124705802-0	Gear
B027	258016003-0	P.C. Board Bracket	B134	121811202-0	Gear Shaft
B028	258016003-0	P.C. Board Bracket	B135	71101559M-0	Gear Spring
B031	258016051-2	Pulley Bracket K	B136	124705850-0	Gear K
B032	258016004-2	Pulley Bracket	B137	124705801-0	Gear
B033	257711202-0	Pulley Shaft	B138	124705802-0	Gear
B034	257711202-0	Pulley Shaft	B139	121811202-0	Gear
B041	257816054-0	Spring Pulley Bracket K	B140	71101559M-0	Gear Spring
B042	257816008-0	Spring Pulley Bracket	B141	138200503-0	Lead Line Clamper
B043	259716004-0	Spring Pulley Bracket	B142	138200503-0	Lead Line Clamper
B044	259711201-0	Spring Pulley Shaft	B143	138200503-0	Lead Line Clamper
B045	133611201-0	Spring Pulley Shaft	B144	138200503-0	Lead Line Clamper
B048	258005150-0	Pointer Guide K	B145	138200503-0	Lead Line Clamper
			B146	138200503-0	Lead Line Clamper
			B147	138200503-0	Lead Line Clamper

REF DESIG.	MARANTZ PART NO.	DESCRIPTION
B148	138200503-0	Lead Line Clamper
B149	138200503-0	Lead Line Clamper
B150	138200503-0	Lead Line Clamper
B501	250605701-0	Leg
B502	250605701-0	Leg
B503	250605701-0	Leg
B504	250605701-0	Leg
B507	257726201-0	Pulley
B508	257726201-0	Pulley
B509	257726201-0	Pulley
B510	257726201-0	Pulley
B511	257726201-0	Pulley
B514	257710602-0	Flywheel Bearing
B515	141511801-0	Flywheel Spacer
B518	145525901-0	AC Cord Bush
B519	145525901-0	ANT Cord Bush
B522	72081604A-0	String
B526	149325902-0	Meter Lamp Bush
B527	149325902-2	Meter Lamp Bush
B528	149325902-2	ANT Tuning Lamp Bush
B529	149325902-2	MPX Lamp Bush
B531	257911801-0	Meter Side Spacer
B532	257911801-0	MPX Lamp Cover Side Spacer
B533	257911803-0	Lid Spacer
B534	257911803-0	Lid Spacer
B535	257911803-0	Lid Spacer
B543	258015901-0	Drum
B545	258005302-0	Scratch Protection Cover
B547	257805303-0	ANT Tuning Lamp Cover
B551	136612002-0	Variable Capacitor Insulator
B552	257805601-0	Meter Buffer
B553	257805601-0	Meter Buffer
B555	258011805-0	Heat Sink Spacer
B556	268611801-0	Heat Sink Spacer
D001	51570306B-0	Chassis K + Bracket P. Tapt Screw
D002	51570306B-0	Chassis K + Bracket P. Tapt Screw
D003	51570306B-0	Chassis K + Bracket P. Tapt Screw
D004	51570306B-0	Chassis K + Bracket P. Tapt Screw
D005	51570306B-0	IF P.C. Board P. Tapt Screw
D006	51570306B-0	IF P.C. Board P. Tapt Screw
D007	51570306B-0	IF P.C. Board P. Tapt Screw
D008	51570306B-0	IF P.C. Board P. Tapt Screw
D009	51570306B-0	IF P.C. Board P. Tapt Screw
D010	51570306B-0	IF P.C. Board P. Tapt Screw
D011	51570306B-0	Supply P.C. Board P. Tapt Screw
D012	51570306B-0	Supply P.C. Board P. Tapt Screw
D013	51570306B-0	Supply P.C. Board P. Tapt Screw
D014	51570306B-0	Supply P.C. Board P. Tapt Screw
D015	51570306B-0	Tone P.C. Board P. Tapt Screw
D016	51570306B-0	Tone P.C. Board P. Tapt Screw
D017	51570306B-0	Tone P.C. Board P. Tapt Screw
D018	51570306B-0	Tone P.C. Board P. Tapt Screw
D023	51570306B-0	AM RF P.C. Board P. Tapt Screw
D024	51570306B-0	AM RF P.C. Board P. Tapt Screw
D025	51570306B-0	AM RF P.C. Board P. Tapt Screw
D026	51570306B-0	FM RF P.C. Board P. Tapt Screw
D027	51570306B-0	FM RF P.C. Board P. Tapt Screw
D028	51570306B-0	FM RF P.C. Board P. Tapt Screw

REF DESIG.	MARANTZ PART NO.	DESCRIPTION
D029	51570306B-0	FM RF P.C. Board P. Tapt Screw
D034	51570306B-0	Chassis + VR Bracket P. Tapt Screw
D035	51570306B-0	Chassis + VR Bracket P. Tapt Screw
D041	51570306B-0	Terminal P. Tapt Screw
D042	51570306B-0	Terminal P. Tapt Screw
D043	51570306B-0	Terminal P. Tapt Screw
D044	51570306B-0	Terminal P. Tapt Screw
D045	51570306B-0	Terminal P. Tapt Screw
D046	51570306B-0	Terminal P. Tapt Screw
D047	51570306B-0	Terminal P. Tapt Screw
D048	51570306B-0	Terminal P. Tapt Screw
D049	51570306B-0	Terminal P. Tapt Screw
D050	51570306B-0	Terminal P. Tapt Screw
D056	51570306B-0	Bracket + Chassis K P. Tapt Screw
D057	51570306B-0	Bracket + Chassis K P. Tapt Screw
D058	51570306B-0	Bracket + Chassis K P. Tapt Screw
D059	51570306B-0	Bracket + Chassis K P. Tapt Screw
D060	51570306B-0	Front Bracket K + Chassis K P. Tapt Screw
D061	51570306B-0	Front Bracket K + Chassis K P. Tapt Screw
D062	51570306B-0	Front Bracket K + Chassis K P. Tapt Screw
D063	51570306B-0	Front Bracket K + Chassis K P. Tapt Screw
D064	51570306B-0	Attenuator Shield P. Tapt Screw
D065	51570306B-0	Attenuator Shield P. Tapt Screw
D066	51570306B-0	Lead Clamper P. Tapt Screw
D067	51570306B-0	Lead Clamper P. Tapt Screw
D068	51570306B-0	Lead Clamper P. Tapt Screw
D069	51570306B-0	Lead Clamper P. Tapt Screw
D070	51570306B-0	Lead Clamper P. Tapt Screw
D071	51570306B-0	Lead Clamper P. Tapt Screw
D072	51570306B-0	Lead Calmper P. Tapt Screw
D073	51570306B-0	Lead Clamper P. Tapt Screw
D081	51570306B-0	Indicator P. Tapt Screw
D082	51570306B-0	Indicator P. Tapt Screw
D084	51570306B-0	4P Push Terminal P. Tapt Screw
D085	51570306B-0	4P Push Terminal P. Tapt Screw
D086	51570306B-0	2P Terminal P. Tapt Screw
D087	51570306B-0	2P Terminal P. Tapt Screw
D088	51570306B-0	2P Terminal P. Tapt Screw
D089	51570306B-0	2P Terminal P. Tapt Screw
D109	53112603E-0	Relay Hexagon Nut
D110	51570306B-0	Relay P. Tapt Screw
D112	51570306B-0	Relay P.C. Board P. Tapt Screw
D113	51570306B-0	Relay P.C. Board P. Tapt Screw
D121	51060304H-9	Cover + Front Bracket P.H.M. Screw
D122	51060304H-9	Cover + Front Bracket P.H.M. Screw
D123	51060304H-9	Cover + Front Bracket P.H.M. Screw
D124	51060304H-9	Cover + Front Bracket P.H.M. Screw
D126	51060304E-0	Slide Switch P.H.M. Screw
D127	51060304E-0	Slide Switch P.H.M. Screw
D128	51060304E-9	Shield Lid + Shield K P.H.M. Screw
D129	51060304E-9	Shield Lid + Shield K P.H.M. Screw
D130	51060305E-9	AM ANT Bracket P.H.M. Screw
D131	51060305E-9	AM ANT Bracket P.H.M. Screw
D132	51060305E-9	AM ANT Bracket P.H.M. Screw
D133	51060305E-9	Circuit Breaker P.H.M. Screw
D134	51060305E-9	Circuit Breaker P.H.M. Screw
D136	51060305E-9	Back Bracket P.H.M. Screw
D137	51060305E-9	Back Bracket P.H.M. Screw
D138	51060305E-9	Back Bracket P.H.M. Screw

REF DESIG.	MARANTZ PART NO.	DESCRIPTION	REF DESIG.	MARANTZ PART NO.	DESCRIPTION
D139	51060305E-9	Back Bracket P.H.M. Screw	D234	54040302N-0	Heat-Sink Spring Washer
D140	51060305E-9	Back Bracket P.H.M. Screw	D235	53110303E-9	Heat-Sink Hexagon Nut
D141	51060305E-9	Back Bracket P.H.M. Screw	D241	51140305E-9	Bearing O.C.H.M. Screw
D142	51060305E-9	Back Bracket P.H.M. Screw	D242	51140305E-9	Bearing O.C.H.M. Screw
D143	51060305E-9	Back Bracket P.H.M. Screw	D243	51140305E-9	AM Variable Capacitor O.C.H.M. Screw
D144	51060305E-9	Back Bracket P.H.M. Screw	D244	51140305E-9	AM Variable Capacitor O.C.H.M. Screw
D145	51060305E-9	Back Bracket P.H.M. Screw	D245	51140305E-9	AM Variable Capacitor O.C.H.M. Screw
D147	51060305E-9	Bearing K P.H.M. Screw	D246	51140308E-9	Push Switch O.C.H.M. Screw
D148	51060305E-9	Bearing K P.H.M. Screw	D247	51140308E-9	Push Switch O.C.H.M. Screw
D150	51060305E-9	Pulley Bracket K P.H.M. Screw	D256	51650304D-0	Gear K Set Screw H.P.
D151	51060305E-9	Pulley Bracket K P.H.M. Screw	D257	51650304D-0	Gear K Set Screw H.P.
D152	51060305E-9	Pulley Bracket K P.H.M. Screw	D258	51650304D-0	Gear K Set Screw H.P.
D154	51060305E-9	Spring P.H.M. Screw	D259	51650304D-0	Gear K Set Screw H.P.
D161	51060308E-9	AM Antenna P.H.M. Screw	D261	51640412D-9	Flywheel Set Screw C.P.
D162	51060308E-9	AM Antenna P.H.M. Screw	D264	51042608E-0	AC Socket F.H.M. Screw
D164	51060306E-9	Front Bracket K + Chassis K P.H.M. Screw	D265	51042608E-0	AC Socket F.H.M. Screw
D165	51060306E-9	Front Bracket + Chassis K P.H.M. Screw	D271	51570305B-0	Capacitor P. Tapt Screw
D167	51060306E-9	Meter P.C. Board P.H.M. Screw	D272	51570305B-0	Capacitor P. Tapt Screw
D168	51060306E-9	Meter P.C. Board P.H.M. Screw	D273	54040302N-0	Capacitor Spring Washer
D170	51060306E-9	Shield Bracket K + Chassis K P.H.M. Screw	D274	54040302N-0	Capacitor Spring Washer
D171	51060306E-9	Shield Bracket K + Chassis K P.H.M. Screw	D281	64002400R-0	Pulley RG Ring E
D172	51060306E-9	Shield Bracket K + Chassis K P.H.M. Screw	D282	64002400R-0	Pulley RG Ring E
D173	51060306E-9	Shield Bracket K + Chassis K P.H.M. Screw	D283	64002400R-0	Pulley RG Ring E
D174	51060305E-9	Meter Bracket P.H.M. Screw	D284	64002400R-0	Pulley RG Ring E
D175	51060305E-9	Meter Bracket P.H.M. Screw	D286	64002400R-0	Drum RG Ring E
D176	51060305E-9	Meter Bracket P.H.M. Screw	D291	54020401S-0	Upper Lid Flat Washer S
D179	51060306E-9	Shield K + Bracket K P.H.M. Screw	D292	54020401S-0	Upper Lid Flat Washer S
D180	51060306E-9	Shield K + Bracket K P.H.M. Screw	D293	54020401S-0	Upper Lid Flat Washer S
D181	51060306E-9	Shield K + Bracket K P.H.M. Screw	D294	54020401S-0	Upper Lid Flat Washer S
D182	51060306E-9	Shield K + Bracket K P.H.M. Screw	D296	54020401E-0	Bottom Lid Flat Washer P
D184	51060304E-9	Variable Capacitor P.H.M. Screw	D297	54020401E-0	Bottom Lid Flat Washer P
D201	51100406S-9	Lid + Chassis K B.H.M. Screw	D298	54020401E-0	Bottom Lid Flat Washer P
D202	51100406S-9	Lid + Chassis K B.H.M. Screw	D299	54020401E-0	Bottom Lid Flat Washer P
D203	51100406S-9	Lid + Chassis K B.H.M. Screw	D300	54020401E-0	Leg Flat Washer P
D204	51100406S-9	Lid + Chassis K B.H.M. Screw	D301	54020401E-0	Leg Flat Washer P
D206	51570306B-0	Bottom Lid P. Tapt Screw	D302	54020401E-0	Leg Flat Washer P
D207	51570306B-0	Bottom Lid P. Tapt Screw	D303	54020401E-0	Leg Flat Washer P
D208	51570306B-0	Bottom Lid P. Tapt Screw	D304	54020401E-0	Power Transformer Flat Washer P
D209	51570306B-0	Bottom Lid P. Tapt Screw	D305	54020401E-0	Power Transformer Flat Washer P
D211	51060408E-9	Power Transformer P.H.M. Screw	D306	54020401E-0	Power Transformer Flat Washer P
D212	51060408E-9	Power Transformer P.H.M. Screw	D307	54020401E-0	Power Transformer Flat Washer P
D213	51060408E-9	Power Transformer P.H.M. Screw	D308	54020401E-0	Bracket + Chassis K Flat Washer P
D214	51060408E-9	Power Transformer P.H.M. Screw	D309	54020401E-0	Bracket + Chassis K Flat Washer P
D216	51060412E-9	Leg P.H.M. Screw	D310	54020601E-0	Flywheel Flat Washer P.
D217	51060412E-9	Leg P.H.M. Screw	D312	56382040G-0	Dial String Eyelet
D218	51060412E-9	Leg P.H.M. Screw	D313	57271240W-0	Shield K Lug Eyelet
D219	51060412E-0	Leg P.H.M. Screw	D314	62041760W-0	Ground Terminal Lug
D226	51122608E-0	Escutcheon T.H.M. Screw	D321	54040302N-0	Leg Spring Washer
D227	51122608E-0	Escutcheon T.H.M. Screw	D322	54040302N-0	Leg Spring Washer
D228	51122608E-0	Escutcheon T.H.M. Screw	D323	54040302N-0	Leg Spring Washer
D229	51122608E-0	Escutcheon T.H.M. Screw	D324	54040302N-0	Leg Spring Washer
D231	51570306B-0	Heat-Sink P. Tapt Screw	D325	54040402N-0	Transformer Spring Washer
D232	51570306B-0	Heat-Sink P. Tapt Screw	D326	54040402N-0	Transformer Spring Washer
D233	51060308E-9	Heat-Sink P.H.M. Screw	D327	54040402N-0	Transformer Spring Washer
			D328	54040402N-0	Transformer Spring Washer
			D329	54040402N-0	Support Spring Washer
			D330	54040402N-0	Support Spring Washer
			D331	54040402N-0	Support Spring Washer
			D332	54040402N-0	Support Spring Washer
			D337	54040402N-0	Flywheel Spring Washer

REF DESIG.	MARANTZ PART NO.	DESCRIPTION
D338	54040602N-0	Flywheel Spring Washer
D341	54040302N-0	AM Antenna Spring Washer
D342	54040302N-0	AM Antenna Spring Washer
D343	54040302N-0	AM Antenna Spring Washer
D344	54040302N-0	Guide K Spring Washer
D345	54040302N-0	Guide K Spring Washer
D346	54040302N-0	Shield K + Bracket K Spring Washer
D347	54040302N-0	Shield K + Bracket K Spring Washer
D348	54040302N-0	Shield K + Bracket K Spring Washer
D349	54040302N-0	Shield K + Bracket K Spring Washer
D354	54020301E-0	Flywheel Bracket + Chassis Flat Washer P.
D355	54020301E-0	Flywheel Bracket + Chassis Flat Washer P.
D361	53110403E-9	Transformer Hexagon Nut
D362	53110403E-9	Transformer Hexagon Nut
D363	53110403E-9	Transformer Hexagon Nut
D364	53110403E-9	Transformer Hexagon Nut
D365	53112603E-0	Terminal Hexagon Nut
D366	53112603E-0	Terminal Hexagon Nut
D367	53112603E-0	Capacitor Hexagon Nut
D368	53112603E-0	Capacitor Hexagon Nut
D369	53110403E-9	Flywheel Hexagon Nut
D371	53110603E-0	Flywheel Hexagon Nut
D372	53110303E-9	AM Antenna Hexagon Nut
D373	53110303E-9	AM Antenna Hexagon Nut
D374	53110303E-9	Lead Clamp Hexagon Nut
D375	53110303E-9	Lead Clamp Hexagon Nut
D376	53112603E-0	AC Socket Hexagon Nut
D377	53112603E-0	AC Socket Hexagon Nut
D379	51022606E-0	Terminal P.H.M. Screw
D380	51022606E-0	Terminal P.H.M. Screw
D381	51022606E-0	Capacitor P.H.M. Screw
D382	51022606E-0	Capacitor P.H.M. Screw
D386	54050400R-0	Ground Terminal T.L. Washer OR
D387	54050300R-0	AM ANT. T.L. Washer OR
D388	54050300R-0	AM ANT. T.L. Washer OR
D389	54052600R-0	AC Socket T.L. Washer OR
D390	54052600R-0	AC Socket T.L. Washer OR
D391	54050300R-0	Terminal + Chassis K T.L. Washer OR
D392	54050300R-0	Terminal + Chassis K T.L. Washer OR
D393	54050300R-0	Terminal + Chassis K T.L. Washer OR
P100	YD2578001-0	PC Board
R101	RC1010412-0	100K ohm ±10% 1/2W Solid
R102	RC1010512-0	1M ohm ±10% 1/2W Solid
R103	RC1022112-0	220 ohm ±10% 1/2W Solid
R104	RC1027212-0	2.7K ohm ±10% 1/2W Solid
R105	RC1018312-0	18K ohm ±10% 1/2W Solid
R106	RC1010212-0	1K ohm ±10% 1/2W Solid
R107	RC1012212-0	1.2K ohm ±10% 1/2W Solid
R108	RC1047212-0	4.7K ohm ±10% 1/2W Solid
R109	RC1010212-0	1K ohm ±10% 1/2W Solid
R110	RC1022312-0	22K ohm ±10% 1/2W Solid
R111	RC1022312-0	22K ohm ±10% 1/2W Carbon Film
C101	CA4000001-0	FM 4 Gang Variable with Trimmer

REF DESIG.	MARANTZ PART NO.	DESCRIPTION
C104	CT1100002-0	2.8PF - 12.8PF Trimmer
C105	DD1615001-0	15PF ±10% Ceramic
C106	DK1710201-0	0.001uF ±20% Ceramic
C107	CK1710201-0	0.001uF ±20% Ceramic
C108	DD1001001-0	1.0PF ±0.25PF Ceramic
C109	DD1615001-0	15PF ±10% Ceramic
C110	CT1100002-0	2.8PF - 12.8PF Trimmer
C111	DK1710201-0	0.001uF ±20% Ceramic
C112	CT1100002-0	2.8PF - 12.8PF Trimmer
C113	DD1620001-0	20PF ±10% Ceramic
C114	DK1710301-0	0.01uF ±20% Ceramic
C115	DK1710201-0	0.001uF ±20% Ceramic
C116	DD1615003-0	15PF ±10% Ceramic
C117	DD1105002-0	5PF ±0.5PF Ceramic
C118	DD1615004-0	15PF ±10% Ceramic
C119	CT1100002-0	2.8PF - 12.8PF Trimmer
C120	DK1615201-0	0.0015uF ±10% Ceramic
C121	DK1710301-0	0.001uF ±20% Ceramic
C122	DK1710301-0	0.01uF ±20% Ceramic
C123	DK1710301-0	0.01uF ±20% Ceramic
C124	DD1210001-0	10PF ±1PF Ceramic
C125	DK1710301-0	0.01uF ±20% Ceramic
C126	DC1103002-2	3PF ±0.5PF Feed Through
C127	DC1810201-0	0.001uF +100 -0% Feed Through
C128	DK1710201-0	0.001uF ±20% Ceramic
C129	DD1001001-0	1PF ±0.25PF Ceramic
C130	DK1710301-0	0.01uF ±20% Ceramic
L101	LA1004620-0	Antenna Coil
L102	LA1004616-0	RF Coil
L103	LA1004619-0	RF Coil
L104	LO1004604-0	OSC Coil
L105	LI1401619-0	IFT
L106	LC1302001-0	Choke Coil
L107	LC1302001-0	Choke Coil
L108	LC1302001-0	Choke Coil
T101	257810903-0	Shield
T102	257810904-0	Shield
T103	257810905-0	Shield
H101	HF200191A-0	2SK19Y Transistor
H102	HF200191B-0	2SK19GN Transistor
H103	HT308291B-0	2SC829B Transistor
H104	HD1000105-0	IN-60 Diode
H105	HD1000105-0	IN-60 Diode
P200	YD2578002-0	PC Board
R201	RT1056214-0	5.6K ohm ±10% 1/4W Carbon Film
R202	RT1015414-0	150K ohm ±10% 1/4W Carbon Film
R203	RT1012214-0	1.2K ohm ±10% 1/4W Carbon Film
R204	RT1022114-0	220 ohm ±10% 1/4W Carbon Film
R205	RT1082314-0	82K ohm ±10% 1/4W Carbon Film
R206	RT1033314-0	33K ohm ±10% 1/4W Carbon Film
R207	RT1033214-0	3.3K ohm ±10% 1/4W Carbon Film
R208	RT1012214-0	1.2K ohm ±10% 1/4W Carbon Film
R209	RT1033314-0	33Kohm ±10% 1/4W Carbon Film

REF DESIG.	MARANTZ PART NO.	DESCRIPTION
R210	RT1012214-0	1.2K ohm ±10% 1/4W Carbon Film
C201	DK1710301-0	0.01uF ±20% Ceramic
C202	DK1710301-0	0.01uF ±20% Ceramic
C203	DD1615001-0	15PF ±10% Ceramic
C204	DK1840301-0	0.04uF +100, -0% Ceramic
C205	DK1840301-0	0.04uF +100, -0% Ceramic
C206	DK1710301-0	0.01uF ±20% Ceramic
C207	DK1710301-0	0.01uF ±20% Ceramic
C208	DD1620001-0	20PF ±10% Ceramic
C209	DF6539150-0	390PF ±5% Poly
C210	DK1840301-0	0.04uF +100, -0% Ceramic
C211	EA1060162-0	10uF 16V Elect.
L201	LA1001014-0	RF Coil
L202	LO1001035-0	OSC Coil
L203	LI1401001-0	IFT
H201	HT303711B-0	Transistor
H202	HT303711A-0	Transistor
H203	HD1000105-0	Diode
J201	YP1000036-0	Plug
J202	YP1000036-0	Plug
J203	YP1000036-0	Plug
J204	YP1000036-0	Plug
J205	YP1000036-0	Plug
J206	YP1000036-0	Plug
J207	YP1000036-0	Plug
J208	YP1000036-0	Plug
P500	YD2578005-0	PC Board
R501	RT1022214-0	2.2K ohm ±10% 1/4W Carbon Film
R502	RT1033114-0	330 ohm ±10% 1/4W Carbon Film
R503	RT1033114-0	330 ohm ±10% 1/4W Carbon Film
R504	RT1027114-0	270 ohm ±10% 1/4W Carbon Film
R505	RT1033114-0	330 ohm ±10% 1/4W Carbon Film
R506	RT1033114-0	330 ohm ±10% 1/4W Carbon Film
R507	RT1027114-0	270 ohm ±10% 1/4W Carbon Film
R508	RT1027214-0	2.7K ohm ±10% 1/4W Carbon Film
R509	RT1010114-0	100 ohm ±10% 1/4W Carbon Film
R510	RT1082114-0	820 ohm ±10% 1/4W Carbon Film
R511	RT1082114-0	820 ohm ±10% 1/4W Carbon Film
R512	RT1033214-0	3.3K ohm ±10% 1/4W Carbon Film
R513	RT1033214-0	3.3K ohm ±10% 1/4W Carbon Film
R514	RT1033414-0	330K ohm ±10% 1/4W Carbon Film
R515	RN1010514-0	1M ohm ±10% 1/4W Carbon Film
R516	RT1039214-0	3.9K ohm ±10% 1/4W Carbon Film
R517	RT1056214-0	5.6K ohm ±10% 1/4W Carbon Film
R518	RT1010414-0	100K ohm ±10% 1/4W Carbon Film
R520	RT1047214-0	4.7K ohm ±10% 1/4W Carbon Film
R521	RT1022214-0	2.2K ohm ±10% 1/4W Carbon Film
R522	RT1068214-0	6.8K ohm ±10% 1/4W Carbon Film
R523	RT1068214-0	6.8K ohm ±10% 1/4W Carbon Film
R524	RT1015314	15K ohm ±10% 1/4W Carbon Film
R525	RT1015314-0	15K ohm ±10% 1/4W Carbon Film
R526	RT1056214-0	5.6K ohm ±10% 1/4W Carbon Film

REF DESIG.	MARANTZ PART NO.	DESCRIPTION
R527	RT1056214-0	5.6K ohm ±10% 1/4W Carbon Film
R528	RT1022314-0	22K ohm ±10% 1/4W Carbon Film
R529	RT1033214-0	3.3K ohm ±10% 1/4W Carbon Film
R530	RT1010314-0	10K ohm ±10% 1/4W Carbon Film
R531	RT1082114-0	820 ohm ±10% 1/4W Carbon Film
R532	RT1022114-0	220 ohm ±10% 1/4W Carbon Film
R533	RT1010314-0	10K ohm ±10% 1/4W Carbon Film
R534	RT1012314-0	12K ohm ±10% 1/4W Carbon Film
R535	RT1082114-0	820 ohm ±10% 1/4W Carbon Film
R536	RT1022114-0	220 ohm ±10% 1/4W Carbon Film
R537	RT1022014-0	22 ohm ±10% 1/4W Carbon Film
R538	RT1022014-0	22 ohm ±10% 1/4W Carbon Film
R539	RT1015314-0	15K ohm ±10% 1/4W Carbon Film
R540	RT1010414-0	100K ohm ±10% 1/4W Carbon Film
R541	RT1022414-0	220K ohm ±10% 1/4W Carbon Film
R542	RT1033414-0	330K ohm ±10% 1/4W Carbon Film
R543	RT1010414-0	100K ohm ±10% 1/4W Carbon Film
R544	RT1022214-0	2.2K ohm ±10% 1/4W Carbon Film
R545	RT1015414-0	150K ohm ±10% 1/4W Carbon Film
R546	RT1056214-0	5.6K ohm ±10% 1/4W Carbon Film
R547	RT1010214-0	1K ohm ±10% 1/4W Carbon Film
R548	RT1012214-0	1.2K ohm ±10% 1/4W Carbon Film
R549	RT1027314-0	27K ohm ±10% 1/4W Carbon Film
R550	RT1010314-0	10K ohm ±10% 1/4W Carbon Film
R551	RT1010214-0	1K ohm ±10% 1/4W Carbon Film
R552	RT1022114-0	220 ohm ±10% 1/4W Carbon Film
R553	RT1027314-0	27K ohm ±10% 1/4W Carbon Film
R554	RT1056214-0	5.6K ohm ±10% 1/4W Carbon Film
R555	RT1033214-0	3.3K ohm ±10% 1/4W Carbon Film
R556	RT1033214-0	3.3K ohm ±10% 1/4W Carbon Film
R558	RT1022414-0	220K ohm ±10% 1/4W Carbon Film
R560	RT1022314-0	22K ohm ±10% 1/4W Carbon Film
R561	RT1047414-0	470K ohm ±10% 1/4W Carbon Film
R562	RT1015314-0	15K ohm ±10% 1/4W Carbon Film
R563	RT1015214-0	1.5K ohm ±10% 1/4W Carbon Film
R564	RT1010114-0	100 ohm ±10% 1/4W Carbon Film
R565	RC1022312-0	22K ohm ±10% 1/2W Solid
R566	RT1010414-0	100K ohm ±10% 1/4W Carbon Film
R567	RT1082114-0	820 ohm ±10% 1/4W Carbon Film
R568	RC1010112-0	100 ohm ±10% 1/2W Solid
C501	DK1710301-0	0.01uF ±20% Ceramic
C502	DK1710301-0	0.01uF ±20% Ceramic
C503	DK1710301-0	0.01uF ±20% Ceramic
C504	DK1710301-0	0.01uF ±20% Ceramic
C505	DK1710301-0	0.01uF ±20% Ceramic
C506	DK1710301-0	0.01uF ±20% Ceramic
C507	DK1710301-0	0.01uF ±20% Ceramic
C508	DK1710301-0	0.01uF ±20% Ceramic
C510	DK1710301-0	0.01uF ±20% Ceramic
C511	DD1105001-0	5PF ±0.5PF Ceramic
C512	DK1710301-0	0.01uF ±20% Ceramic
C513	DK1710301-0	0.01uF ±20% Ceramic
C514	DK1710301-0	0.01uF ±20% Ceramic

REF DESIG.	MARANTZ PART NO.	DESCRIPTION
C515	DK1710301-0	0.01uF ±20% Ceramic
C516	DK1710301-0	0.01uF ±20% Ceramic
C517	DK1710301-0	0.01uF ±20% Ceramic
C518	DD1620101-0	200PF ±10% Ceramic
C519	EA4750162-0	4.7uF 16V Elect.
C520	EA1060162-0	10uF 16V Elect.
C521	DD1620101-0	200PF ±10% Ceramic
C522	DD1620101-0	200PF ±10% Ceramic
C523	DD1650101-0	500PF ±10% Ceramic
C524	ED4750102-0	4.7uF 10V Elect.
C525	DF1747301-0	0.047uF ±20% Mylar
C526	DF5547201-0	0.0047uF ±5% Mylar
C527	DF5547201-0	0.0047uF ±5% Mylar
C528	DF5412201-0	0.0012uF ±2% Mylar
C529	ED3350163-0	3.3uF 16V Elect.
C530	DF1633201-0	0.0033uF ±10% Mylar
C531	DF1633201-0	0.0033uF ±10% Mylar
C532	DK1710301-0	0.01uF ±20% Ceramic
C533	ED4750102-0	4.7uF 10V Elect.
C534	ED4750102-0	4.7uF 10V Elect.
C535	DF6582101-0	820PF ±5% Poly
C536	DF6582101-0	820PF ±5% Poly
C537	DF1633201-0	0.0033uF ±10% Mylar
C538	DF1633201-0	0.0033uF ±10% Mylar
C539	DF1633201-0	0.0033uF ±10% Mylar
C540	DF1633201-0	0.0033uF ±10% Mylar
C541	DF1668201-0	0.0068uF ±20% Mylar
C542	DF1668201-0	0.0068uF ±20% Mylar
C543	DK1710301-0	0.01uF ±20% Ceramic
C544	DK1710301-0	0.01uF ±20% Ceramic
C545	DK1710301-0	0.01uF ±20% Ceramic
C546	DK1710301-0	0.01uF ±20% Ceramic
C547	DK1710301-0	0.01uF ±20% Ceramic
C548	DD1620101-0	200PF ±10% Ceramic
C549	DK1710301-0	0.01uF ±20% Ceramic
C551	EM2240251-0	0.2uF 25V Elect.
C550	DK1710301-0	0.01uF ±20% Ceramic
C552	DK1710301-0	0.01uF ±20% Ceramic
C553	DK1840301-0	0.04uF +100, -0% Ceramic
C554	DK1710301-0	0.01uF ±20% Ceramic
C555	DK1710301-0	0.01uF ±20% Ceramic
C556	DK1840301-0	0.04uF +100, -0% Ceramic
C557	EA4750161-0	4.7uF 16V Elect.
C558	DK1840301-0	0.04uF +100, -0% Ceramic
C559	DK1840301-0	0.04uF +100, -0% Ceramic
C560	EA4750162-0	4.7uF 16V Elect.
C561	DK1840301-0	0.04uF +100, -0% Ceramic
C562	DD1530101-0	300PF ±5% Ceramic
C563	DK1750201-0	0.005uF ±20% Ceramic
C564	DK1750201-0	0.005uF ±20% Ceramic
C565	DK1840301-0	0.04uF +100, -0% Ceramic
C566	DK1710201-0	0.001uF ±20% Ceramic
C567	DF1747301-0	0.047uF ±20% Mylar
C569	EA1060162-0	10uF 16V Elect.
C570	ED1060102-0	10uF 10V Elect.
C571	DK1840301-0	0.04uF +100, -0% Ceramic

REF DESIG.	MARANTZ PART NO.	DESCRIPTION
C574	DD1540001-0	40PF ±5% Ceramic
C575	DD1650101-0	500PF ±10% Ceramic
C576	EA2270164-0	220uF 16V Elect.
C577	DK1710301-0	0.01uF ±20% Ceramic
C578	DK1820301-0	0.02uF +100, -0% Ceramic
C579	EA2270162-0	220uF 16V Elect.
L502	LC1223001-0	22uH Coil
L503	LC1223001-0	22uH Coil
L504	LC1223001-0	22uH Coil
L505	LC1223001-0	22uH Coil
L506	LC1223001-0	22uH Coil
L507	LI1401604-0	FM IFT (DET) IFT
L508	LI1015601-0	FM IFT (SUB) IFT
L509	LI1015602-0	FM IFT IFT
L510	LI1401004-0	AM IFT IFT
L511	LI1401005-0	AM IFT IFT
L512	LS1001001-0	19 KHz MPX Coil
L513	LS1001001-0	19 KHz MPX Coil
L514	LS1001001-0	38 KHz MPX Coil
L515	LS1001006-0	38 KHz Trap MPX Coil
L516	LS1001006-0	38 KHz Trap MPX Coil
L517	LS1001006-0	19 KHz Trap MPX Coil
L518	LS1001006-0	19 KHz Trap MPX Coil
L519	LI1001616-0	FM IFT IFT
F501	FF1107001-0	SFC 10.7 MA Ceramic
F502	DD1107001-0	SFC 10.7 MA Ceramic
H501	HC1000111-0	uA703 IC
H502	HC1000114-0	cA3011 IC
H503	HC1000114-0	cA3011 IC
H504	HT306441B-0	2SC644 S Transistor
H505	HC1000117-0	MC1304P IC
H506	HT303801B-0	2SC380 0 Transistor
H507	HT303801B-0	2SC380 0 Transistor
H508	HT3037210-0	2SC372 Transistor
H509	HT104951A-0	2SA495 Transistor
H510	HT303711B-0	2SC371 Transistor
H511	HT303711A-0	2SC371 Transistor
H513	HD1000105-0	IN-60 Diode
H514	HD1000105-0	IN-60 Diode
H515	HD1000101-0	IN34A Diode
H516	HD1000101-0	IN34A Diode
H517	HD1000105-0	IN-60 Diode
H518	HD1000105-0	IN-60 Diode
H519	HD1000105-0	IN-60 Diode
H520	HD1000105-0	IN-60 Diode
H521	HD1000105-0	IN-60 Diode
J501	YP1000036-0	Plug
J502	YP1000036-0	Plug
J503	YP1000036-0	Plug
J504	YP1000036-0	Plug
J505	YP1000036-0	Plug
J506	YP1000036-0	Plug

REF DESIG.	MARANTZ PART NO.	DESCRIPTION
J507	YP1000036-0	Plug
J508	YP1000036-0	Plug
J509	YP1000036-0	Plug
J510	YP1000036-0	Plug
J511	YP1000036-0	Plug
J512	YP1000036-0	Plug
J513	YP1000036-0	Plug
J514	YP1000036-0	Plug
J515	YP1000036-0	Plug
J516	YP1000036-0	Plug
J517	YP1000036-0	Plug
J518	YP1000036-0	Plug
J519	YP1000036-0	Plug
J520	YP1000036-0	Plug
J521	YP1000036-0	Plug
J522	YP1000036-0	Plug
J523	YP1000036-0	Plug
J525	YP1000001-0	Plug
J526	YP1000001-0	Plug
J527	YP1000001-0	Plug
J528	YP1000001-0	Plug
W501	YW2580002-2	Wire Materials
P700	YD2578004-0	PC Board
R701	RT1056314-0	56K ohm ±10% 1/4W Carbon Film
R702	RT1056214-0	5.6K ohm ±10% 1/4W Carbon Film
R703	RT1022314-0	22K ohm ±10% 1/4W Carbon Film
R704	RA0502006-0	5K ohm (B) Trimmer
R705	RT1056214-0	5.6K ohm ±10% 1/4W Carbon Film
R706	RT1056314-0	56K ohm ±10% 1/4W Carbon Film
R707	RT1022314-0	22K ohm ±10% 1/4W Carbon Film
R708	RT1010314-0	10K ohm ±10% 1/4W Carbon Film
R709	RT1010314-0	10K ohm ±10% 1/4W Carbon Film
R710	RT1022314-0	22K ohm ±10% 1/4W Carbon Film
R711	RN1047414-0	470K ohm ±10% 1/4W Carbon Film
R712	RN1047414-0	470K ohm ±10% 1/4W Carbon Film
R713	RN1015414-0	150K ohm ±10% 1/4W Carbon Film
R714	RN1015414-0	150K ohm ±10% 1/4W Carbon Film
R715	RN1022314-0	22K ohm ±10% 1/4W Carbon Film
R716	RN1022314-0	22K ohm ±10% 1/4W Carbon Film
R717	RT1056214-0	5.6K ohm ±10% 1/4W Carbon Film
R718	RT1056214-0	5.6K ohm ±10% 1/4W Carbon Film
R719	RT1010214-0	1K ohm ±10% 1/4W Carbon Film
R720	RT1010214-0	1K ohm ±10% 1/4W Carbon Film
R721	RT1015314-0	15K ohm ±10% 1/4W Carbon Film
R722	RT1015314-0	15K ohm ±10% 1/4W Carbon Film
R723	RT1039214-0	3.9K ohm ±10% 1/4W Carbon Film
R724	RT1068114-0	680 ohm ±10% 1/4W Carbon Film
R725	RT1022414-0	220K ohm ±10% 1/4W Carbon Film
R726	RT1022414-0	220K ohm ±10% 1/4W Carbon Film
C701	EV2240251-0	0.22uF ±20% 25V Elect.

REF DESIG.	MARANTZ PART NO.	DESCRIPTION
C702	EV2240251-0	0.22uF ±20% 25V Elect.
C703	EA1060351-0	10uF 35V Elect.
C704	EA1060351-0	10uF 35V Elect.
C705	EA1070252-0	100uF 25V Elect.
C706	EM4740251-0	0.47uF ±20% 25V Elect.
C707	EM4740251-0	0.47uF ±20% 25V Elect.
H701	HT3037210-0	2SC372 Transistor
H702	HT3037210-0	2SC372 Transistor
H703	HT104951A-0	2SA495 R Transistor
H704	HT104951A-0	2SA495 R Transistor
H705	HT304580Z-0	Transistor
H706	HT304580Z-0	Transistor
H707	HT104941C-0	2SA494 Y Transistor
H708	HT104941C-0	2SA494 Y Transistor
H709	HD3001009-0	IS336 Diode
J701	YP1000036-0	Plug
J702	YP1000036-0	Plug
J703	YP1000036-0	Plug
J704	YP1000036-0	Plug
J705	YP1000036-0	Plug
J706	YP1000036-0	Plug
J707	YP1000036-0	Plug
J708	YP1000036-0	Plug
J709	YP1000036-0	Plug
J710	YP1000036-0	Plug
J711	YP1000036-0	Plug
J712	YP1000036-0	Plug
J713	YP1000036-0	Plug
P400	YD2577004-0	Head Amp P.C. Board
R401	RT1039114-0	390 ohm ±10% 1/4W Carbon Film
R402	RT1039114-0	390 ohm ±10% 1/4W Carbon Film
R403	RN1047314-0	47K ohm ±10% 1/4W Carbon Film
R404	RN1047314-0	47K ohm ±10% 1/4W Carbon Film
R405	RN1056314-0	56K ohm ±10% 1/4W Carbon Film
R406	RN1056314-0	56K ohm ±10% 1/4W Carbon Film
R407	RT1068214-0	6.8K ohm ±10% 1/4W Carbon Film
R408	RT1068214-0	6.8K ohm ±10% 1/4W Carbon Film
R409	RT1022314-0	22K ohm ±10% 1/4W Carbon Film
R410	RN1022314-0	22K ohm ±10% 1/4W Carbon Film
R411	RT1027214-0	2.7K ohm ±10% 1/4W Carbon Film
R412	RT1027214-0	2.7K ohm ±10% 1/4W Carbon Film
R413	RT1010214-0	1K ohm ±10% 1/4W Carbon Film
R414	RT1010214-0	1K ohm ±10% 1/4W Carbon Film
R415	RN1015314-0	15K ohm ±10% 1/4W Carbon Film
R416	RN1015314-0	15K ohm ±10% 1/4W Carbon Film
R417	RT1022214-0	2.2K ohm ±10% 1/4W Carbon Film
R426	RT1010314-0	10K ohm ±10% 1/4W Carbon Film
R427	RT1010314-0	10K ohm ±10% 1/4W Carbon Film
C401	EV2240251-0	0.22uF 25V ±20% Elect.
C402	EV2240251-0	0.22uF 25V ±20% Elect.

REF DESIG.	MARANTZ PART NO.	DESCRIPTION
C403	EA1060162-0	10uF 16V Elect.
C404	EA1060162-0	10uF 16V Elect.
C405	EA1060351-0	10uF 35V Elect.
C406	EA1060351-0	10uF 35V Elect.
C409	EA1070351-0	100uF 35V Elect.
C414	EV4740251-0	0.47uF 25V +40, -20% Elect.
C415	EV4740251-0	0.47uF 25V +40, -20% Elect.
W401	YW2580003-0	Wire Materials
H401	HT304580Z-0	2SC458 LG (D) Transistor
H402	HT304580Z-0	2SC458 LG (D) Transistor
H403	HT104941C-0	2SA494 (Y) Transistor
H404	HT104941C-0	2SA494 (Y) Transistor
J401	YP1000036-0	Plug
J402	YP1000036-0	Plug
J403	YP1000036-0	Plug
J404	YP1000036-0	Plug
J405	YP1000036-0	Plug
J406	YP1000036-0	Plug
P600	YD2580001-0	P.C. Board
R603	RN1068314-0	68K ohm ±10% 1/4W Carbon Film
R604	RN1068314-0	68K ohm ±10% 1/4W Carbon Film
R605	RT1027214-0	2.7K ohm ±10% 1/4W Carbon Film
R606	RT1027214-0	2.7K ohm ±10% 1/4W Carbon Film
R607	RN1056314-0	56K ohm ±10% 1/4W Carbon Film
R608	RN1056314-0	56K ohm ±10% 1/4W Carbon Film
R609	GT0510112-0	100 ohm ±5% 1/2W Carbon Film
R610	GT0510112-0	100 ohm ±5% 1/2W Carbon Film
R611	RT1068214-0	6.8K ohm ±10% 1/4W Carbon Film
R612	RT1068214-0	6.8K ohm ±10% 1/4W Carbon Film
R613	RT1047214-0	4.7K ohm ±10% 1/4W Carbon Film
R614	RT1010314-0	10K ohm ±10% 1/4W Carbon Film
R615	RT1010314-0	10K ohm ±10% 1/4W Carbon Film
R616	RN1018414-0	180K ohm ±10% 1/4W Carbon Film
R617	RN1018414-0	180K ohm ±10% 1/4W Carbon Film
R620	GT0522112-0	220 ohm ±5% 1/2W Carbon Film
R621	GT0522112-0	220 ohm ±5% 1/2W Carbon Film
R622	RC1012212-0	1.2K ohm ±10% 1/2W Solid
R623	RC1012212-0	1.2K ohm ±10% 1/2W Solid
R624	RC1033212-0	3.3K ohm ±10% 1/2W Solid
R625	RC1033212-0	3.3K ohm ±10% 1/2W Solid
R626	RC1082112-0	820 ohm ±10% 1/2W Solid
R627	RC1082112-0	820 ohm ±10% 1/2W Solid
R628	RT1033114-0	330 ohm ±10% 1/4W Carbon Film
R629	RT1033114-0	330 ohm ±10% 1/4W Carbon Film
R630	RC1010112-0	100 ohm ±10% 1/2W Solid
R631	RC1010112-0	100 ohm ±10% 1/2W Solid
R632	RC1010112-0	100 ohm ±10% 1/2W Solid
R633	RC1010112-0	100 ohm ±10% 1/2W Solid
R634	RC1010212-0	1K ohm ±10% 1/2W Solid
R635	RC1050012-0	50 ohm ±10% 1/2W Solid
R636	RT1047214-0	4.7K ohm ±10% 1/4W Carbon Film
R637	RT1047214-0	4.7K ohm ±10% 1/4W Carbon Film
R638	RA0104007-0	100K ohm (B) Semi Fix
R639	RT1033214-0	3.3K ohm ±10% 1/4W Carbon Film

REF DESIG.	MARANTZ PART NO.	DESCRIPTION
R640	RT1033214-0	3.3K ohm ±10% 1/4W Carbon Film
C601	RV2240251-0	0.22uF 25V ±20% Elect.
C602	RV2240251-0	0.22uF 25V ±20% Elect.
C603	EA2270252-0	220uF 25V Elect.
C604	ED1060102-0	10uF 10V Elect.
C605	ED1060102-0	10uF 10V Elect.
C606	EA1050251-0	1uF 25V +40, -20% Elect.
C607	EA1050251-0	1uF 25V +40, -20% Elect.
C608	DF3656001-0	56PF ±10% Mica
C609	DF3656001-0	56PF ±10% Mica
C610	EA3360252-0	33uF 25V Electrolytic
C611	EA3360252-0	33uF 25V Electrolytic
C612	DD1620101-0	200PF ±10% Ceramic
C613	DD1620101-0	200PF ±10% Ceramic
C614	EA2260351-0	22uF 35V Electrolytic
C615	EA2260351-0	22uF 35V Electrolytic
C616	DK1840301-0	0.04uF +100, -0% Ceramic
C617	EA4770351-0	470uF 35V Electrolytic
C618	EA4770351-0	470uF 35V Electrolytic
C619	EC4770501-0	470uF 50V Electrolytic
C620	EA4770252-0	470uF 25V Electrolytic
C621	EA1070252-0	100uF 25V Electrolytic
C622	EA1070252-0	100uF 25V Electrolytic
C623	DK1810351-0	0.01uF 500V +100, -0% Ceramic
C624	DK1810351-0	0.01uF 500V +100, -0% Ceramic
H601	HT306441B-0	2SC644 (S) Transistor
H602	HT306441B-0	2SC644 (S) Transistor
H603	HT304580B-0	2SC458 LG (B) Transistor
H604	HT304580B-0	2SC458 LG (B) Transistor
H605	HT105611C-0	2SA561 Y Transistor
H606	HT105611C-0	2SA561 Y Transistor
H607	HT307341C-0	2SC734 Y Transistor
H608	HT307341C-0	2SC734 Y Transistor
H609	HV0000105-0	M8513 R Varistor
H610	HV0000105-0	M8513 R Varistor
H611	HD3000201-0	AW-01-30 Zener Diode
H612	HD2000301-0	AC Rect. HR-5A Diode
H613	HD2000301-0	AC Rect. HR-5A Diode
H614	HD2000301-0	AC Rect. HR-5A Diode
H615	HD2000301-0	AC Rect. HR-5A Diode
H616	HD2000301-0	AC Rect. HR-5A Diode
H617	HT309714A-0	2SC971 Transistor
J601	YP1000036-0	Plug
J602	YP1000036-0	Plug
J604	YP1000036-0	Plug
J605	YP1000036-0	Plug
J606	YP1000036-0	Plug
J607	YP1000036-0	Plug
J608	YP1000036-0	Plug
J609	YP1000036-0	Plug
J610	YP1000036-0	Plug
J611	YP1000036-0	Plug
J612	YP1000036-0	Plug
J613	YP1000036-0	Plug
J614	YP1000036-0	Plug
J615	YP1000036-0	Plug

REF DESIG.	MARANTZ PART NO.	DESCRIPTION
S001	SR0604006-0	For Function Rotary Switch
S002	SC0102007-0	For Muting Switch
S003	SC0101014-0	For AC Supply Switch
S004	SP0401007-2	For Ant. Tuning Push Switch
S005	SS0202017-0	For FM-Ant Attenuator Slide Switch
M001	IM1103603-0	For AM-FM Tuning DC Meter
M002	IM1103603-0	For FM Tuning DC Meter
M003	IN1012004-0	For MPX Lamp
M004	IN1008001-0	Lamp
M005	IN1008001-0	Lamp
M006	IN1008001-0	Lamp
M007	IN1006003-0	For Dial Illumination Lamp
M008	IN1006003-0	For Dial Illumination Lamp
M009	IN1006003-0	For Dial Illumination Lamp
M010	IN1006003-0	For Dial Illumination Lamp
H001	HD3000101-0	AW-01-12 (12V) Diode
H002	HD3001009-0	IS336 (11V) Diode
H003	HD2000110-0	IS1665 Diode
H004	HD2000110-0	IS1665 Diode
H005	HD2000110-0	IS1665 Diode
H006	HD2000110-0	IS1665 Diode
F001	FR1005001-0	0.5A Circuit Breaker
W001	YC0240001-0	For AC Supply AC Power Cord
W002	YW2580001-3	Wire Materials
R001	RC1068012-0	68 ohm ±10% 1/2W Solid
R002	RC1068012-0	68 ohm ±10% 1/2W Solid
R003	RC1008212-0	8.2 ohm ±10% 1/2W Solid
R004	RK0104003-0	100K ohm (B) Variable Resistor
R005	RT1010214-0	1K ohm ±10% 1/4W Carbon Film
R006	RT1010214-0	1K ohm ±10% 1/4W Carbon Film
R007	RM0254006-0	250K ohm (A) Variable Resistor
R008	RT1022501-0	2.2M ohm ±10% 1W Carbon Film
R009	RC1056112-0	560 ohm ±10% 1/2W Solid
R010	RC1056112-0	560 ohm ±10% 1/2W Solid
R011	GS1015105-0	150 ohm ±10% 5W Wire Wound
R012	GS1010103-0	100 ohm ±10% 3W Wire Wound
R013	RC1027112-0	270 ohm ±10% 1/2W Solid
R014	GS1015105-0	150 ohm ±10% 5W Wire Wound
R015	RT1010514-0	1M ohm ±10% 1/4W Carbon Film
R021	RT1056314-0	56K ohm ±10% 1/4W Carbon Film
L005	LY4024002-0	24V DC Relay
C016	RK1810402-0	0.1uF +100, -0% Ceramic
C003	DC1810201-0	0.001uF +100, -0% Feed Thru
C004	DC1103002-2	3PF ±0.5PF Feed Thru
C005	DD1105001-0	5PF ±0.5PF Ceramic
C006	DK1710301-0	0.01uF ±20% Ceramic
C007	ED3360061-0	33uF 6V Elect.
C008	DF5547201-0	0.0047uF ±5% Film
C009	EC1080501-0	1000uF 50V Elect.
C010	ED4770351-0	470uF 35V Elect.
C011	CA0330001-0	AM 3 Gang Variable

REF DESIG.	MARANTZ PART NO.	DESCRIPTION
C012	DO0747353-0	0.047uF (600V DC) Oil Paper
R022	RT1010414-0	100K ohm ±10% 1/4W Carbon Film
R023	RC1056112-0	560 ±10% 1/2W Solid
L001	LF1140036-0	AM Ant Coil
L002	LB3007525-0	Balun
L003	LC1223001-0	Choke Coil
L004	TS1660201-0	Power Transformer
J001	YT0304003-0	For FM-AM Ant 4P Terminal
J002	YT0202007-0	Terminal
J003	YT0202007-0	Terminal
J004	YJ0200007-0	Socket
J005	YJ0200007-0	Socket
J006	YJ0400032-0	Socket
J007	YT0101003-0	Terminal
J008	YJ0200007-0	Socket
J009	YJ0200007-0	Socket
J010	YJ0200047-0	Socket
J011	YJ0200048-0	Socket
J012	YJ0200049-0	Socket
J013	YJ0200050-0	Socket
J014	YL0105004-0	Terminal
J015	YL0107001-0	Terminal
J016	YL0105001-0	Terminal
J017	YL0107001-0	Terminal
J018	YL0105001-0	Terminal
J019	YL0107001-0	Terminal
J020	YL0108003-0	Terminal
J021	YL0105001-0	Terminal