

Service
Service
Service



TS5200
TS5201
DS5200

Service Manual

TABLE OF CONTENTS

	Page
Mechanical Instructions	1
Electrical diagrams	2
Mainboard component layout	3
Mechanical & Electrical Parts list	4
Mechanical Instructions - Docking station	5
Electrical diagrams - Docking station	6
Charge board component layout	7
Mechanical & Electrical Parts list - Docking station	8

MECHANICAL INSTRUCTIONS - TS5201

Set Disassembly

- 1. Remove battery lid
- 2. Remove battery
- 3. Remove 2 x screw (Torx screw 2x6)
see picture - arrows



- 6. Put a sharp knife between toppart and bottompart and use this as lever to separate the two parts. see picture

Overview snapholes

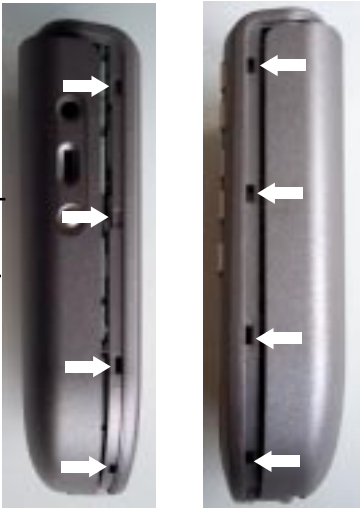

MECHANICAL INSTRUCTIONS - TS5201

Disassembly LCD & Buttons

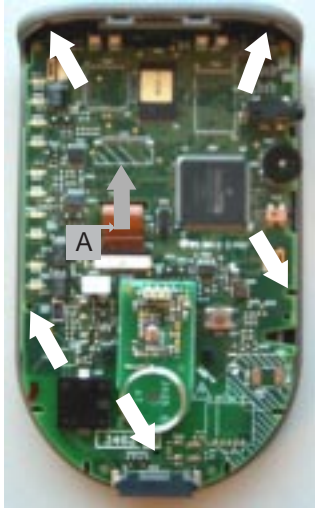

1. Remove 5 x screw (Torx screw 2x6). see picture - arrows
2. Remove the flex cable. see picture - arrow A
3. Remove the mainboard

4. Remove the Upper keymat assy (*item8)
5. Remove the LCD keymat assy (*item 9)
6. Remove LCD assy

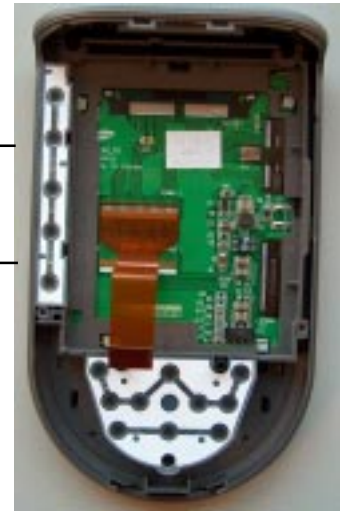

7. Remove the LCD out the distance piece (*item12)

* for items see overview disassembled parts

Overview disassembled parts TS5201

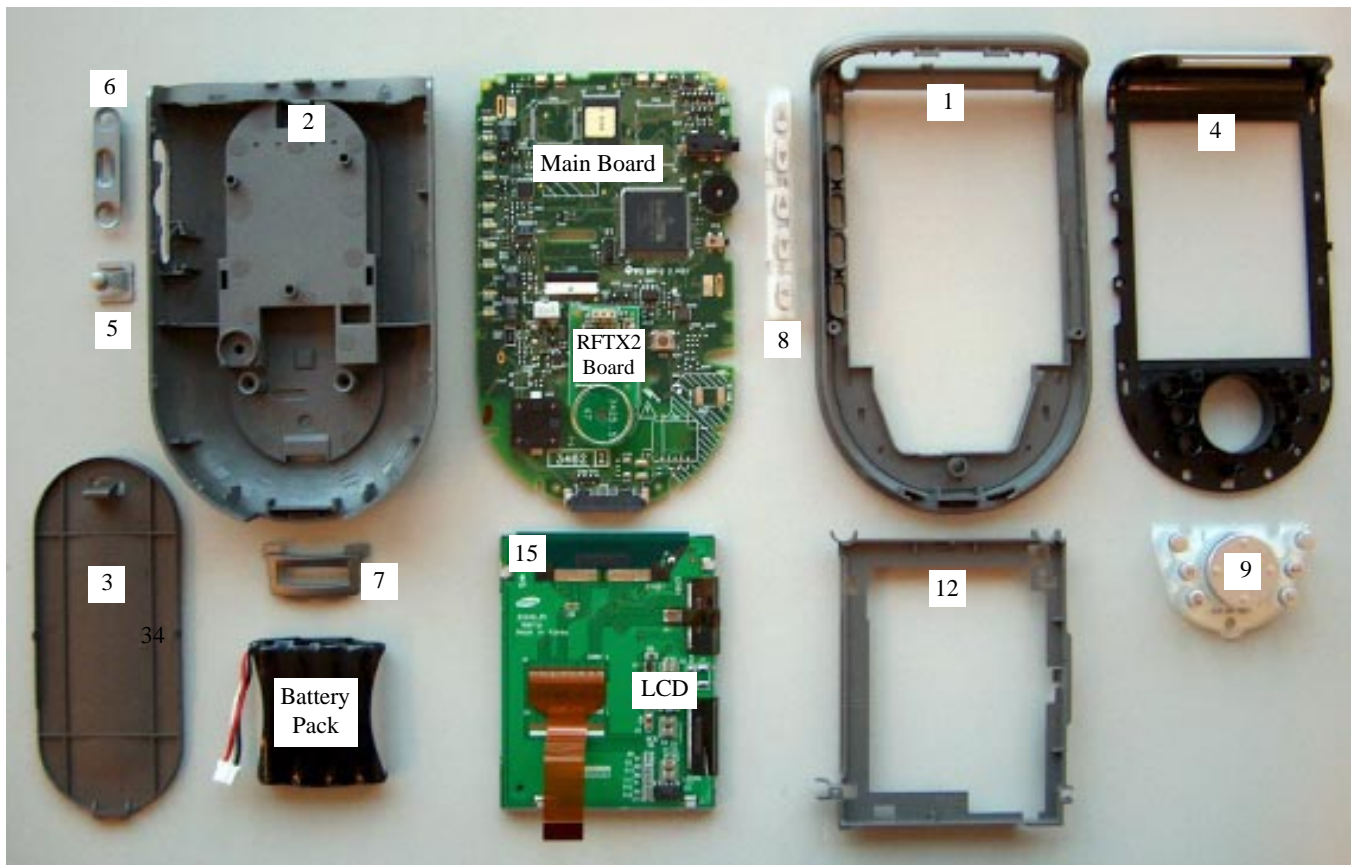

MECHANICAL INSTRUCTIONS - TS5201

Set Reassembly



1. Put LCD assy in distance piece (*item12)

2. Put Toppart assy (*item1) and IR-wind assy (*item4) together.
 3. Place Toppart assy (item1 & item4) upside down.
 4. Place LCD assy (*item15) in topart assy.

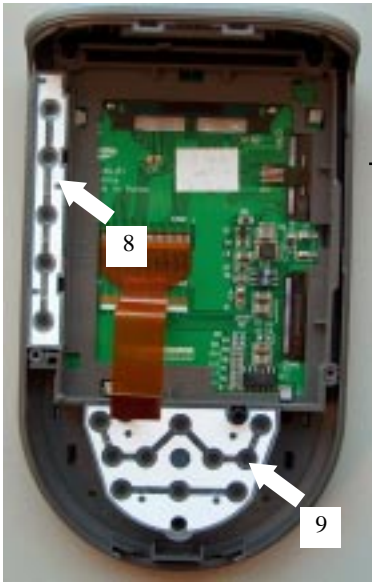
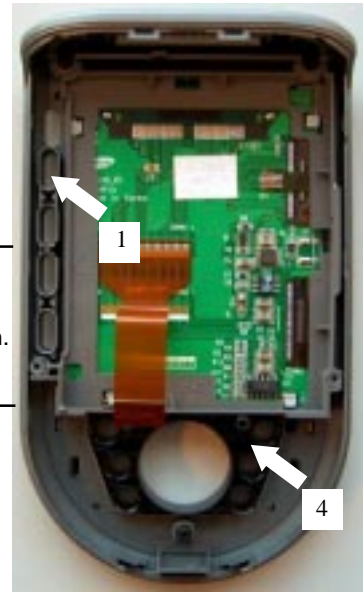

5. Place Upper keymat assy (*item8)
 6. Place LCD keymat assy (*item9)

7. Place mainboard.
 8. Connect the flex cable. see arrow A
 9. Place Doc. plug assy (*item7)
 10. Mount the 5 screws back. see arrows

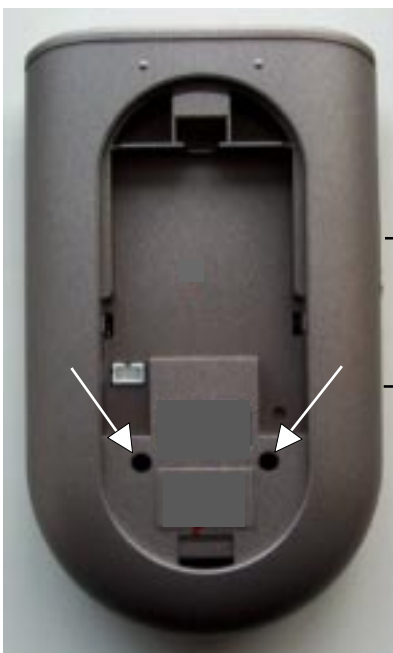
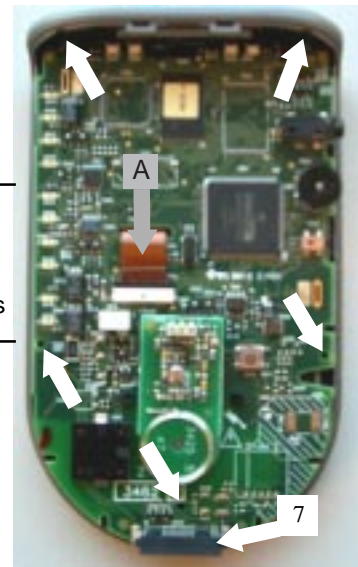

11. Place bottompart assy (*item2)
 12. Mount the two screws. see arrow
 13. Place battery pack. (*item34)
 14. Place batterylid assy. (*item3)

15. Place plug insert assy. (*item6)
 see picture - arrow

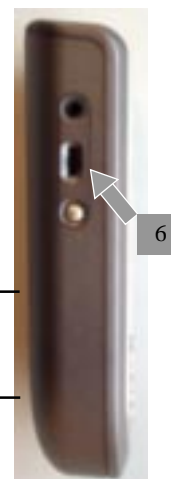

* for items see overview disassembled parts

Micro-Controller

1

- 1001 E3
- 1020 B2
- 2001 F2
- 2002 F3
- 2003 F3
- 2004 H2
- 2005 H3
- 2006 H3
- 2007 H4
- 2008 H4
- 2009 H4
- 2010 H5
- 2011 H5
- 2031 B3
- 3001 E3
- 3002 C10
- 3003 C10
- 3088 C9
- 3089 C11
- 3090 C11
- 3123 A2
- 5013 H2
- 7001 D7

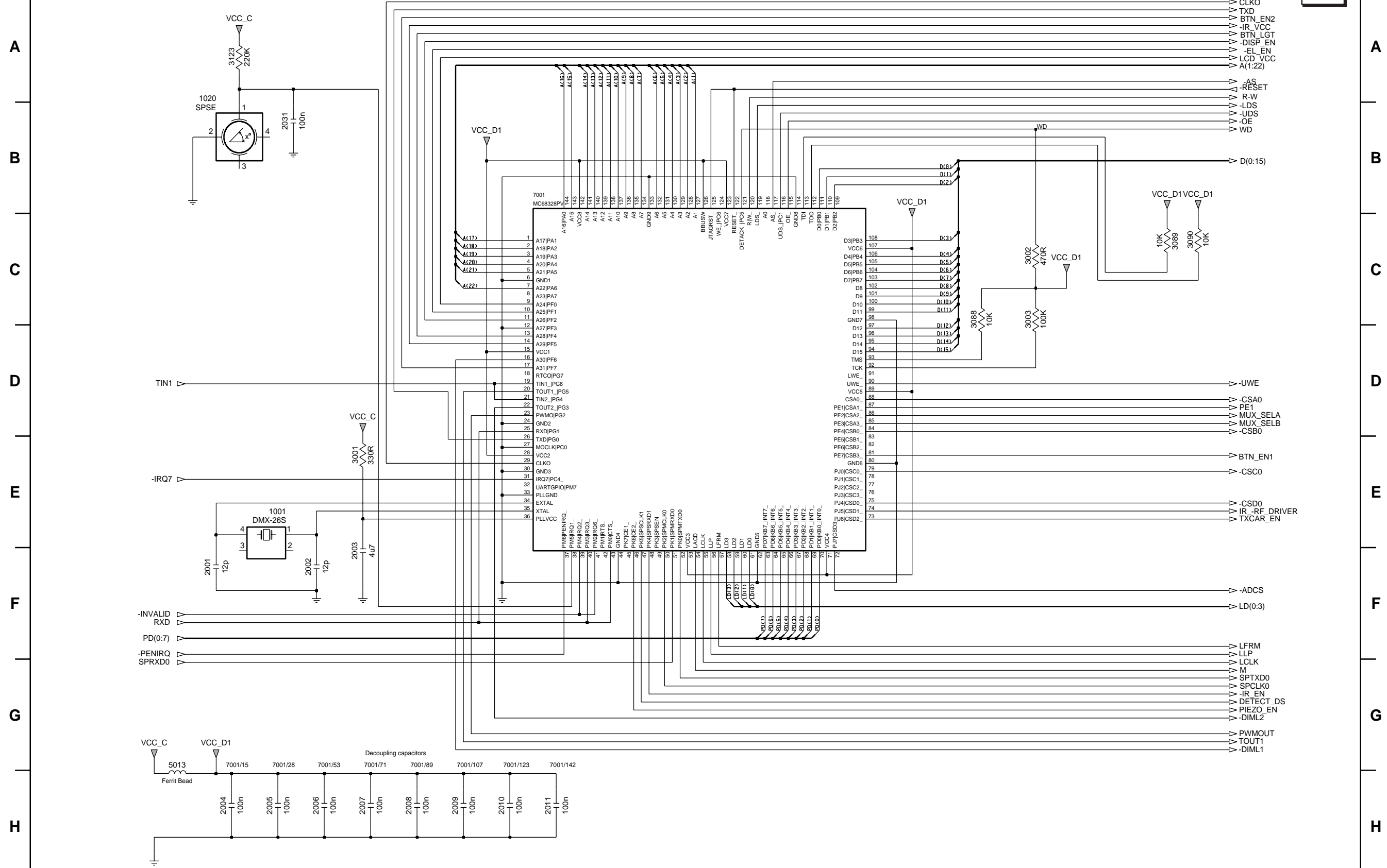

LCD CONTROLLER

2

- 1002 E11
- 2067 B9
- 2068 H2
- 2069 H3
- 2070 H3
- 2071 H3
- 2072 H4
- 2073 H4
- 2074 H4
- 2091 B10
- 2097 B10
- 2098 B10
- 3118 E2
- 3119 E2
- 3120 E2
- 3121 E2
- 3122 E1
- 5014 H2
- 5018 A8
- 7060 C5
- 7066 A9
- 7067-A E8

A
B
C
D
E
F
G
H

A
B
C
D
E
F
G
H

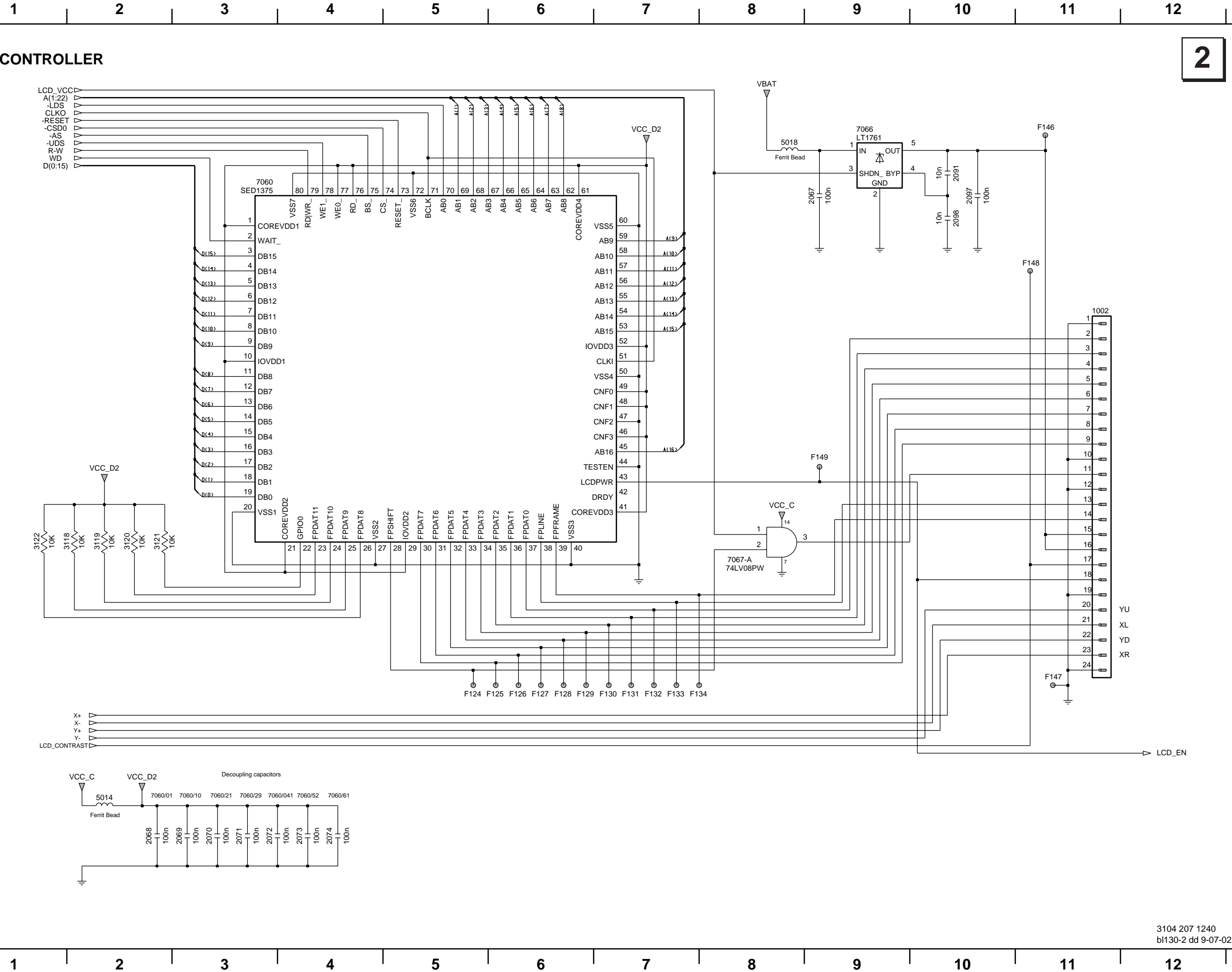

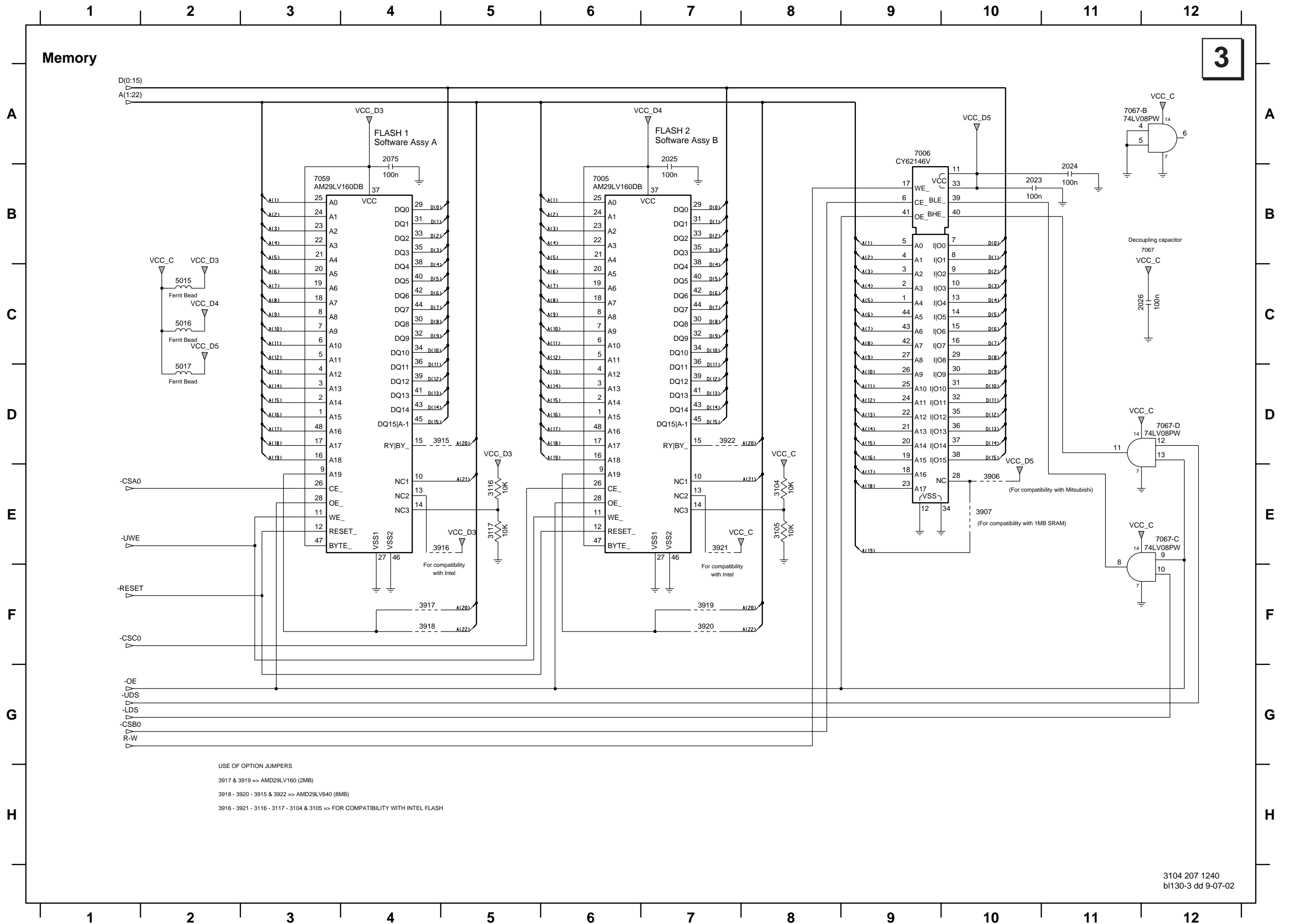

USE OF OPTION JUMPERS
 3917 & 3919 => AMD29LV160 (2MB)
 3918 - 3920 - 3915 & 3922 => AMD29LV640 (8MB)
 3916 - 3921 - 3116 - 3117 - 3104 & 3105 => FOR COMPATIBILITY WITH INTEL FLASH

- 2023 B10
- 2024 B11
- 2025 B7
- 2026 C12
- 2075 B4
- 3104 E8
- 3105 E8
- 3116 E5
- 3117 E5
- 3906 E10
- 3907 E10
- 3915 D5
- 3916 E5
- 3917 F4
- 3918 F4
- 3919 F7
- 3920 F7
- 3921 E7
- 3922 D7
- 5015 C2
- 5016 C2
- 5017 D2
- 7005 D7
- 7006 C9
- 7059 D4
- 7067-B A12
- 7067-C F12
- 7067-D D12

3

IR- & Piezo-Circuit

4

A
B
C
D
E
F
G
H

1 2 3 4 5 6 7 8 9 10 11 12

1003 G5
 1026 F12
 2027 C12
 2028 H2
 2029 H2
 2030 H3
 2050 B3
 2099 H3
 2100 H2
 2105 G9
 2116 E4
 2118 F12
 2119 F10
 2120 C10
 2121 C10
 3009 E4
 3011 D4
 3012 C10
 3013 C11
 3015 E9
 3017 G4
 3061 C3
 3073 G4
 3135 D9
 3201 F10
 3202 F10
 3203 G10
 3204 G9
 3901 C8
 3902 E10
 3904 E11
 3905 G9
 3908 D11
 6005 C10
 6006 C11
 6007 D10
 6008 D11
 6010 C4
 7007-A E4
 7007-B E6
 7007-C G3
 7007-D F8
 7009-A B7
 7009-B C7
 7011-A D3
 7011-B F5
 7011-C D5
 7011-D E5
 7011-E F5
 7011-F E3
 7012-A F6
 7012-B G7
 7013 D11
 7043 H4
 7064 D10
 7071-A D8
 7071-B G6
 7071-C E9
 7071-D D9
 7072 G10
 7075 F10

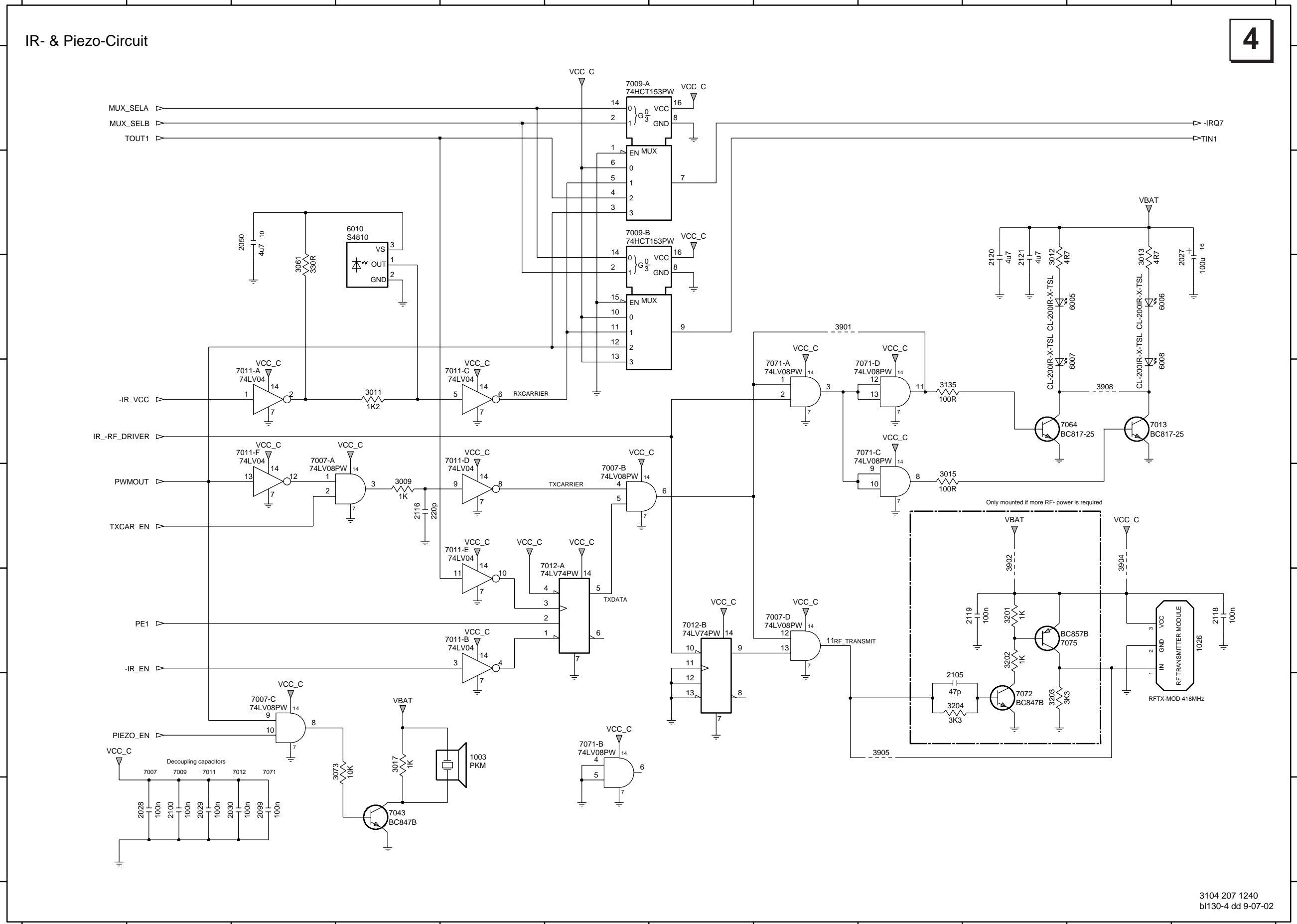

1 2 3 4 5 6 7 8 9 10 11 12

RS232 Interface

5

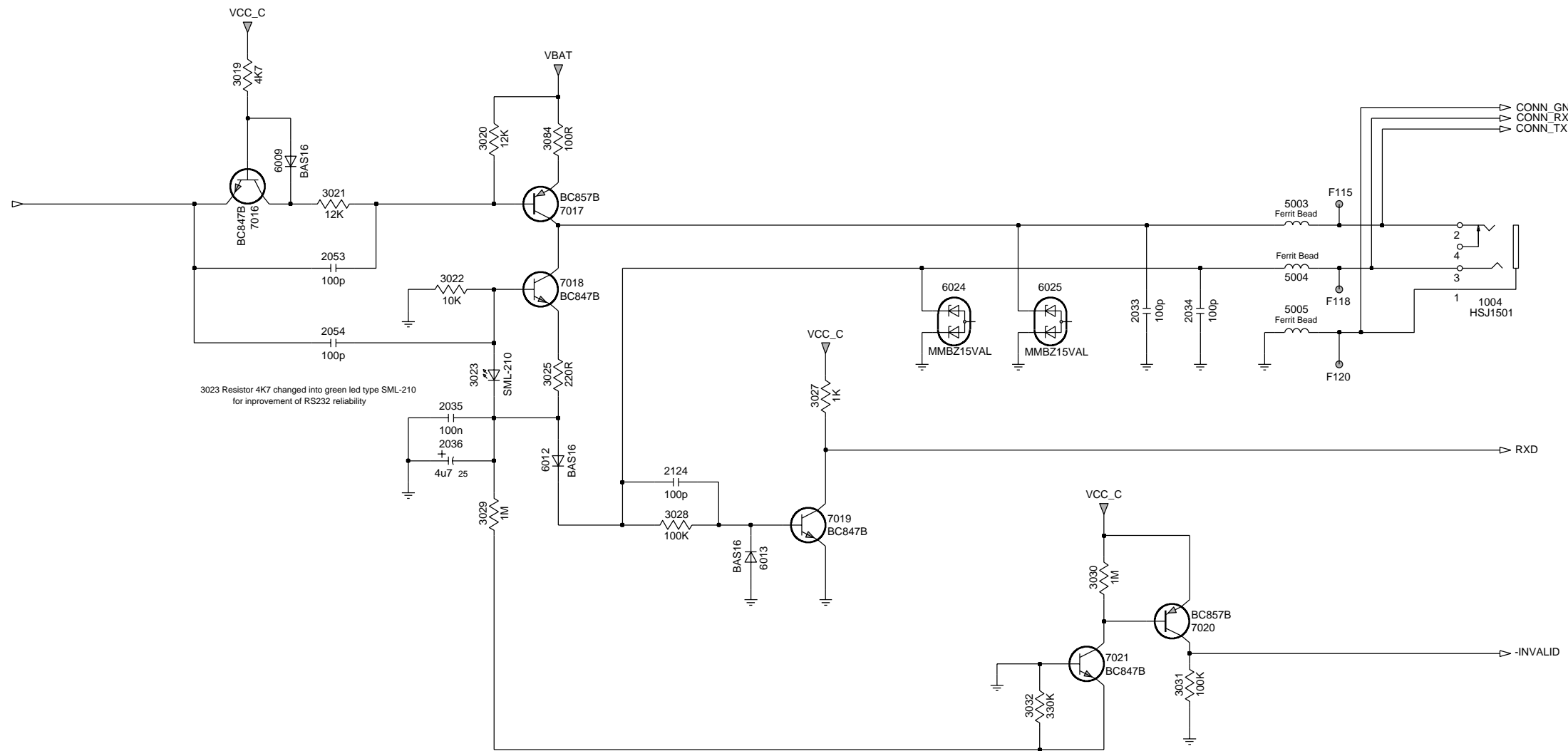

- 1004 C11
- 2033 C9
- 2034 C9
- 2035 D4
- 2036 D4
- 2053 C4
- 2054 D4
- 2124 E6
- 3019 B3
- 3020 B5
- 3021 C4
- 3022 C4
- 3023 D5
- 3025 D5
- 3027 D7
- 3028 E6
- 3029 E5
- 3030 E9
- 3031 F9
- 3032 F8
- 3084 B5
- 5003 C10
- 5004 C10
- 5005 D10
- 6009 B3
- 6012 D5
- 6013 E6
- 6024 D8
- 6025 D8
- 7016 C3
- 7017 C5
- 7018 C5
- 7019 E7
- 7020 F9
- 7021 F9

Keys + KeyBacklighting

6

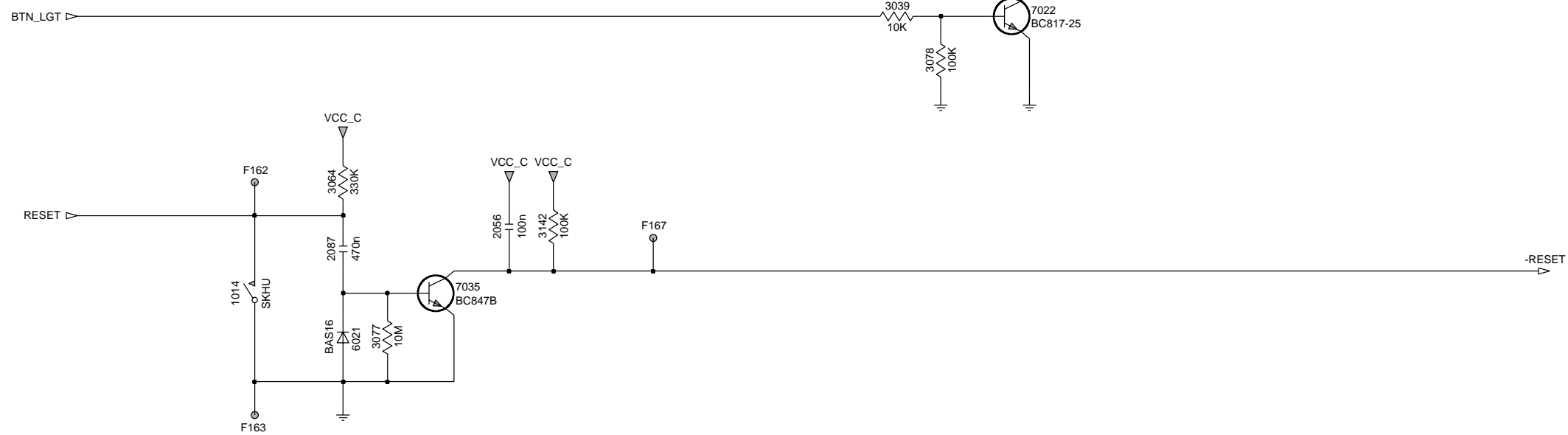
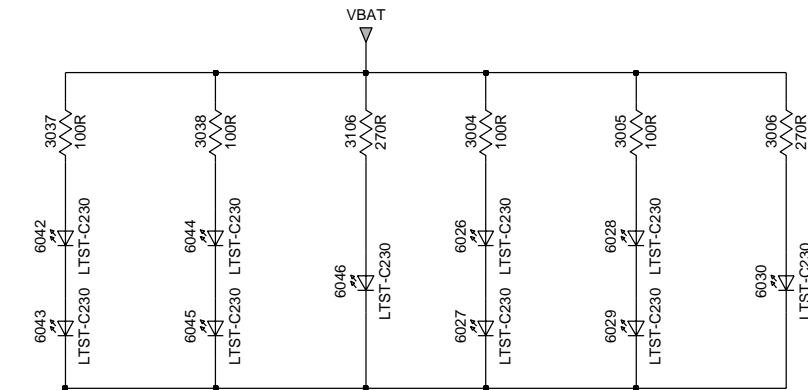
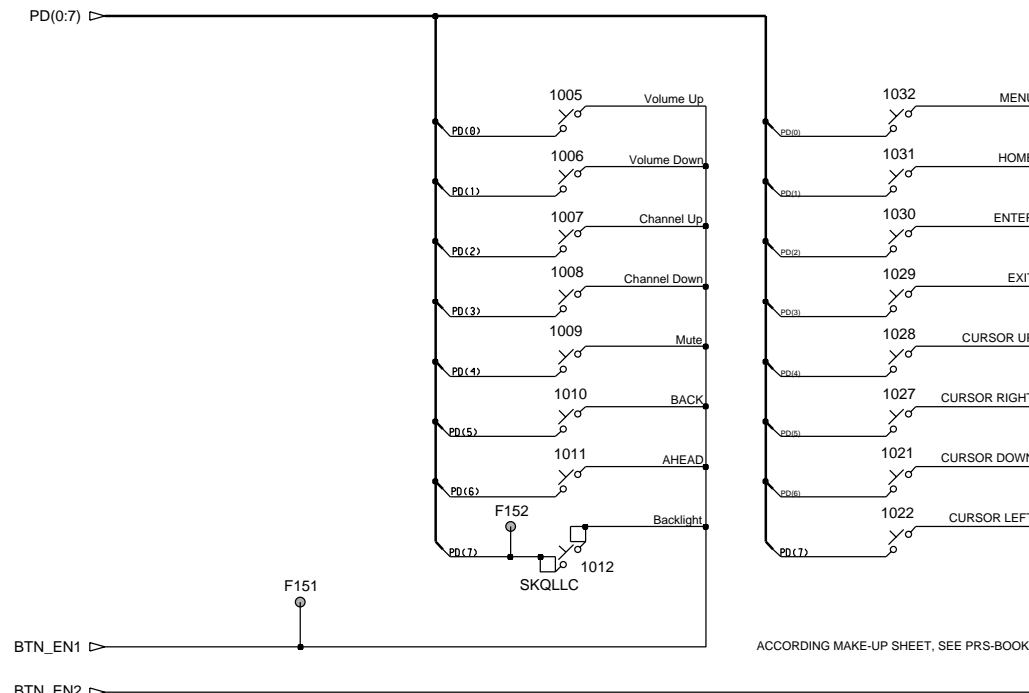

- 1005 A4
- 1006 B4
- 1007 B4
- 1008 B4
- 1009 B4
- 1010 C4
- 1011 C4
- 1012 C4
- 1014 G3
- 1021 C6
- 1022 C6
- 1027 C6
- 1028 B6
- 1029 B6
- 1030 B6
- 1031 B6
- 1032 A6
- 2056 F5
- 2087 F4
- 3004 C10
- 3005 C11
- 3006 C11
- 3037 C8
- 3038 C9
- 3039 E7
- 3064 F4
- 3077 G4
- 3078 E7
- 3106 C9
- 3142 F5
- 6021 G4
- 6026 D10
- 6027 D10
- 6028 D11
- 6029 D11
- 6030 D11
- 6042 D8
- 6043 D8
- 6044 D9
- 6045 D9
- 6046 D9
- 7022 E8
- 7035 G4

CCFL BACKLIGHT DRIVER

8

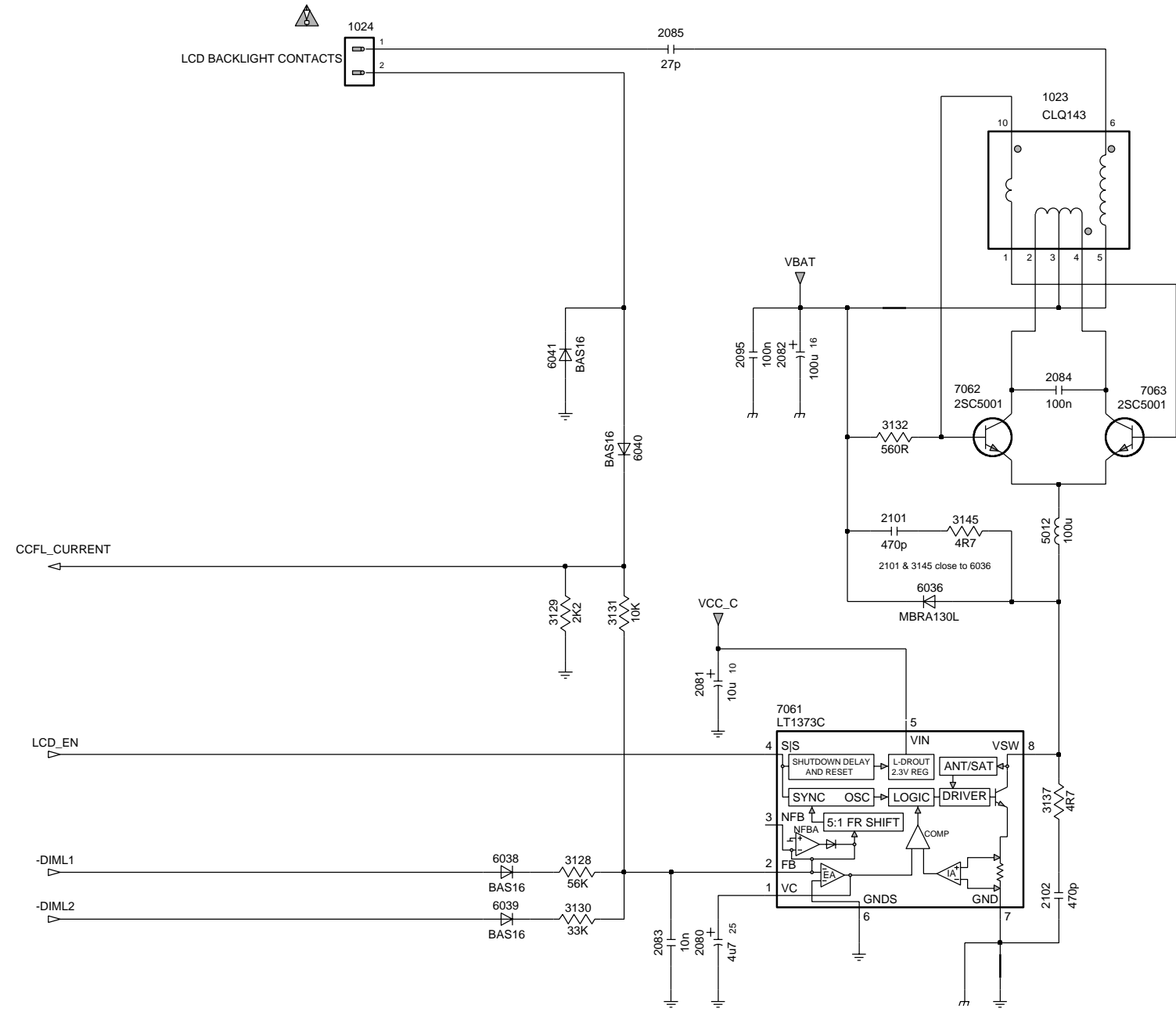

Plated through holes for grounding of LCD-frame

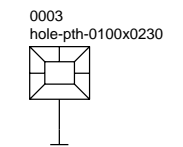
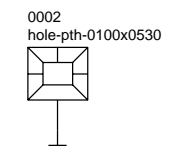
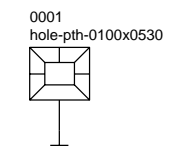

- 0001 F10
- 0002 F11
- 0003 G10
- 1023 B8
- 1024 A4
- 2080 G6
- 2081 E6
- 2082 C6
- 2083 G6
- 2084 C8
- 2085 A6
- 2095 C6
- 2101 D7
- 2102 F8
- 3128 F5
- 3129 E5
- 3130 F5
- 3131 E5
- 3132 D7
- 3137 F8
- 3145 D7
- 5012 D8
- 6036 E7
- 6038 F5
- 6039 F5
- 6040 D5
- 6041 C5
- 7061 F7
- 7062 D8
- 7063 D8

B&W LCD & 23V STEP UP

9

A
B
C
D
E
F
G
H

A
B
C
D
E
F
G
H

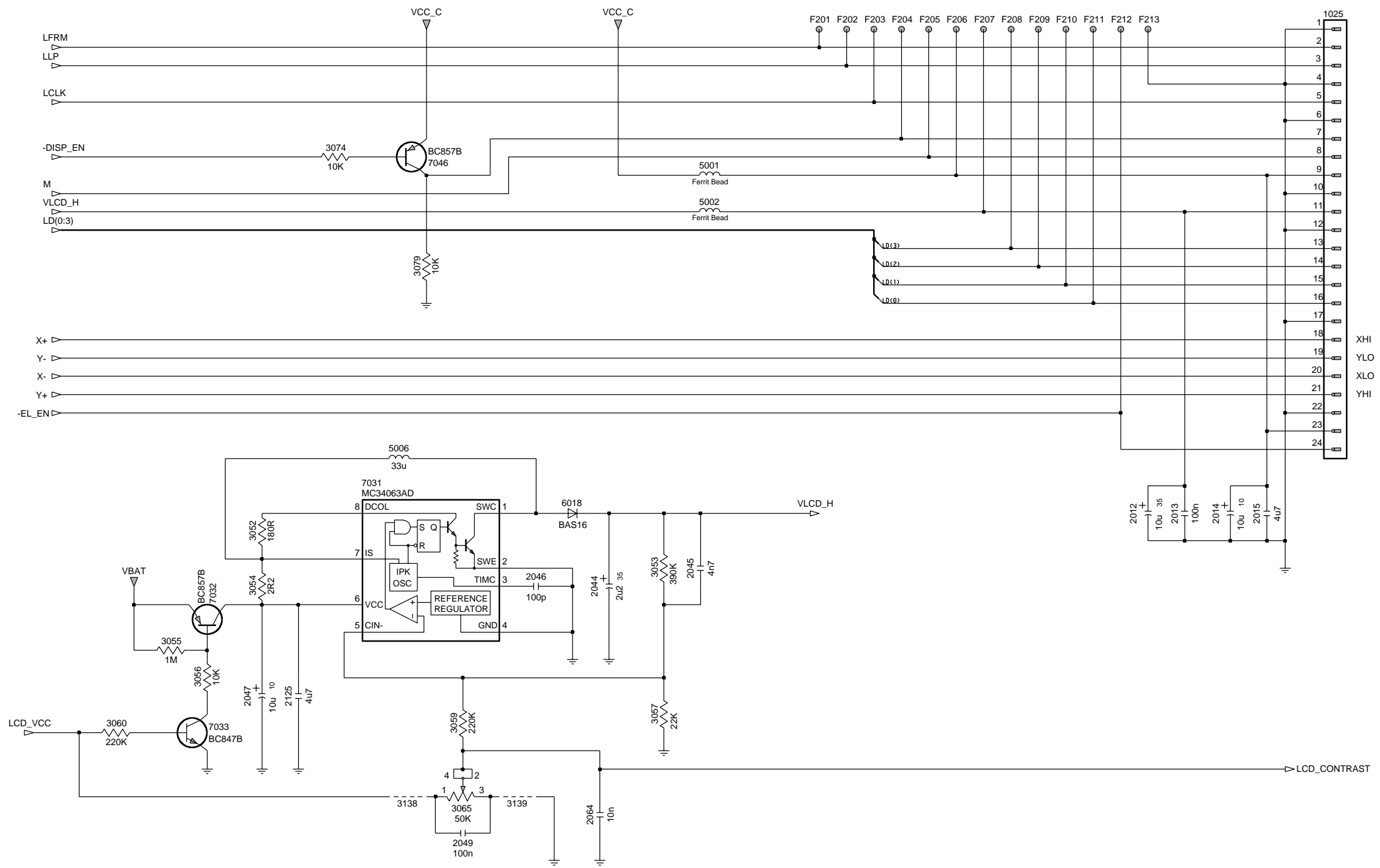

DOUBLE USE OF POTMETER :
 TS5200 : 3138, 3139 : JUMP
 TS9200 : 3138, 3139 : 18K

- 1025 C12
- 2012 E10
- 2013 E11
- 2014 E11
- 2044 E6
- 2045 E7
- 2046 E5
- 2047 F3
- 2049 G5
- 2064 G6
- 2125 F4
- 3052 E3
- 3053 E6
- 3054 E3
- 3055 F3
- 3056 F3
- 3057 F6
- 3059 F5
- 3060 G2
- 3065 G5
- 3074 B4
- 3079 C5
- 3138 G4
- 3139 G5
- 5001 B7
- 5002 B7
- 5006 D4
- 6018 E6
- 7031 E5
- 7032 F3
- 7033 G3
- 7046 B4
- F201 A8
- F202 A8
- F203 A8
- F204 A8
- F205 A9
- F206 A9
- F207 A9
- F208 A9
- F209 A9
- F210 A10
- F211 A10
- F212 A10
- F213 A10

1 2 3 4 5 6 7 8 9 10 11 12

1 2 3 4 5 6 7 8 9 10 11 12

TOUCHSCREEN DAC

10

- 2016 B5
- 2019 D7
- 2020 D7
- 2021 D6
- 3007 D7
- 3008 C7
- 3062 F6
- 3099 E5
- 3103 C7
- 3140 C7
- 3144 E4
- 3909 E5
- 5011 B5
- 6001 D9
- 6002 E9
- 7004 C4

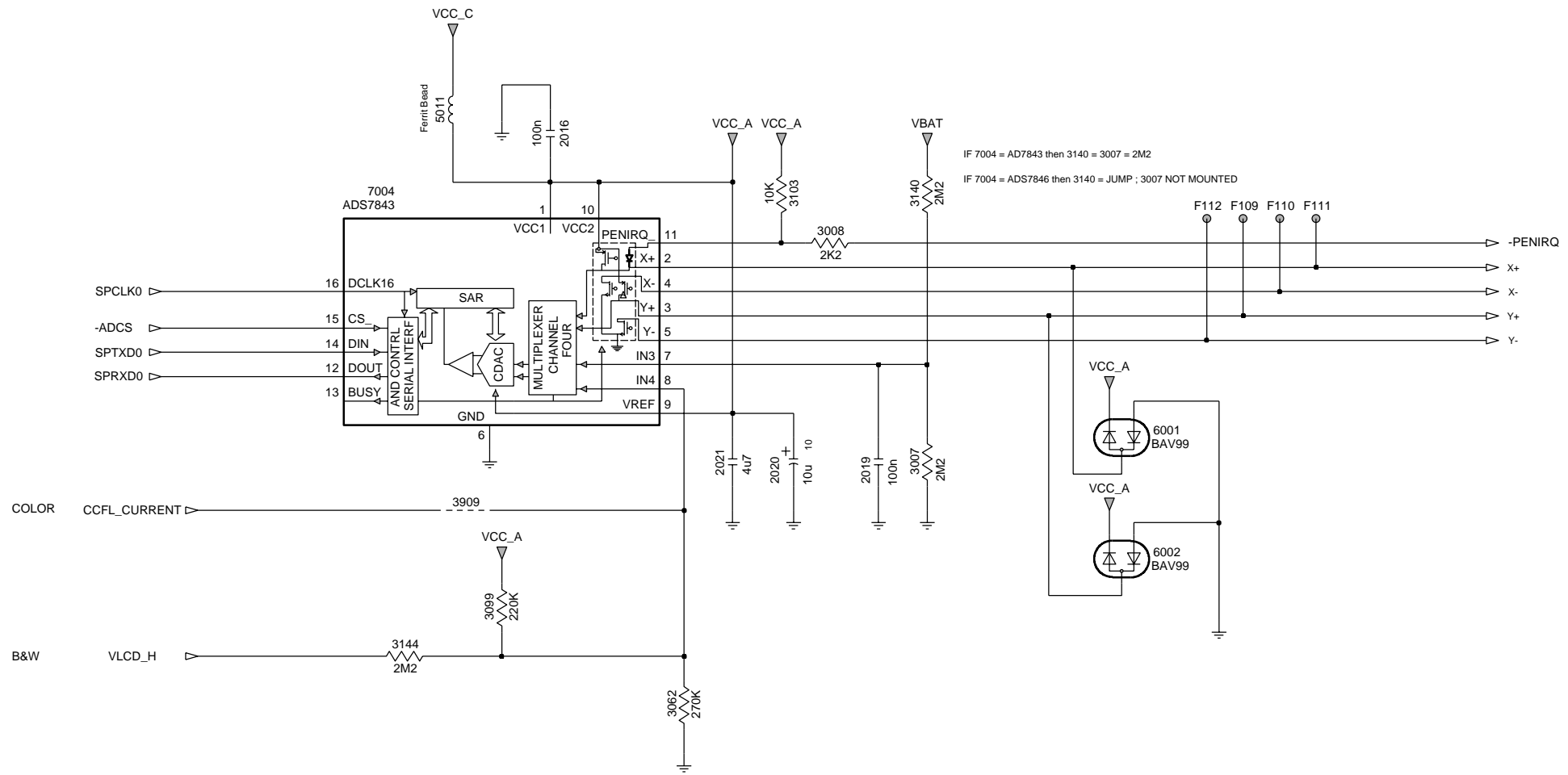

MECHANICAL & ELECTRICAL PARTS LIST

MECHANICAL PARTS

1	3104 207 78920	TOPPART ASSY
2	3104 207 78930	BOTTOMPART ASSY
3	3104 207 79580	BATTERYLID ASSY TS5201
3	3104 207 78940	BATTERYLID ASSY TS5200
4	3104 207 78970	IR-WIND.+BEZEL SUB ASSY
5	3104 207 78980	BACKLIGHT BUTT.ASSY
6	3104 207 78990	PLUG INSERT ASSY
7	3104 207 79000	DOC PLUG INS.ASSY
8	3104 207 79010	UPPER KEYMAT ASSY
9	3104 207 79020	LCD KEYMAT ASSY
12	3104 204 18410	DISTANCE PIECE
15	3104 200 51290	LCD

MISCELLANEOUS

3104 200 32670	IFU for /N1M /T1M
3104 200 32440	IFU for /UIS

ELECTRICAL PARTS

34	3104 200 51270	BATTERYPACK
	3104 207 14210	MAINBOARD TS5200(3104 207 12400) (RFTX2 board included)
	3104 207 14430	MAINBOARD TS5201(3104 207 13250) (RFTX2 board included)



3104 200 51200	ADAPTOR /N1M - EUROPE
3104 200 51210	ADAPTOR /T1M - UK
3104 200 51190	ADAPTOR /UIS - US



3104 200 50960 CABLE SET

Note: Only the parts mentioned in this list are normal service parts

For more information:

E-mail: erik.gybels@philips.com

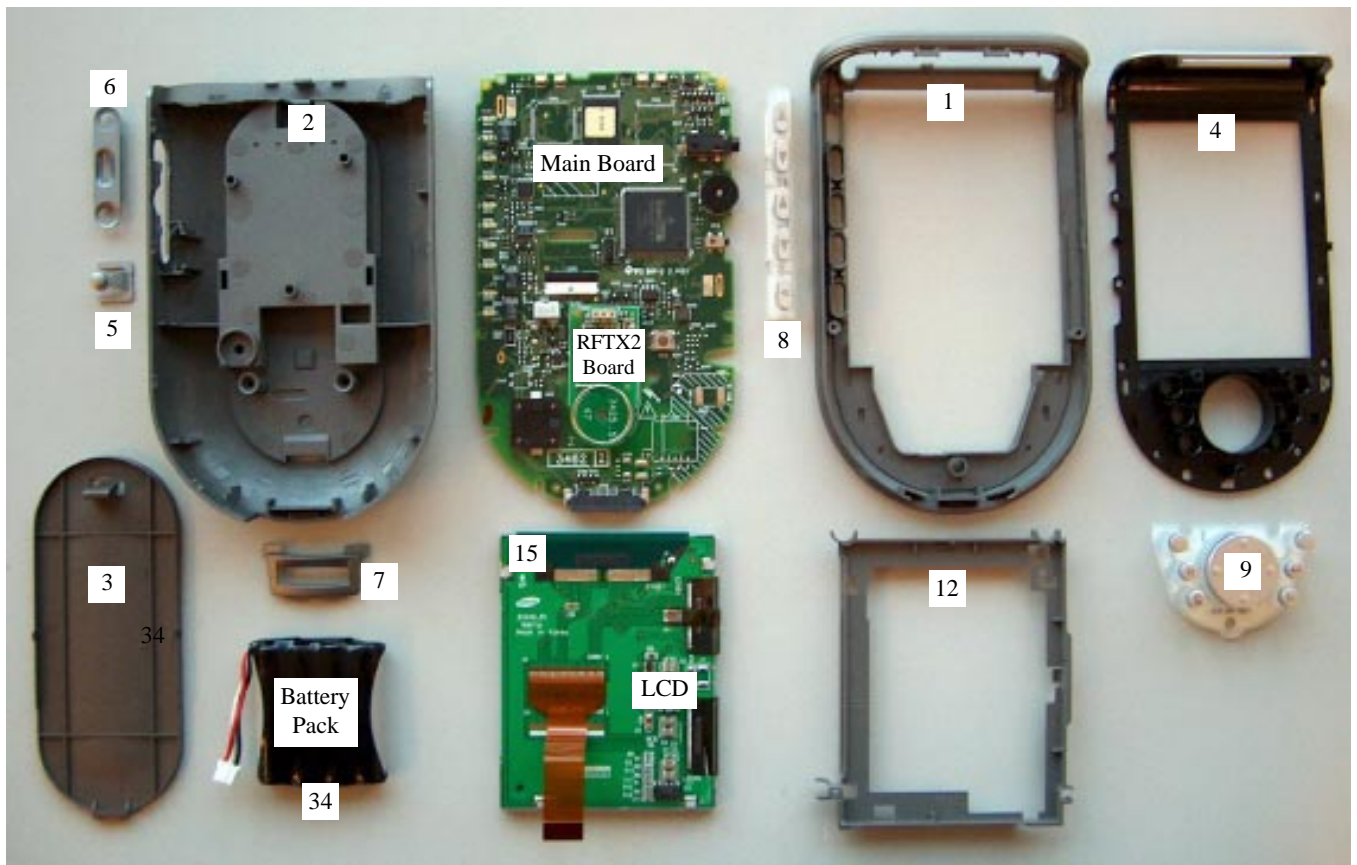

ELECTRICAL PARTS LIST - TS5201 - TS5200**MISCELLANEOUS**

1001	2422 543 00937	RES XTL SM 32K76
1003	2422 527 00547	BUZZER SM 16X16
1004	2422 026 05066	SOC PHONE 1P 3.5 ST
1012	2422 128 02646	SWI TACT SM 1P 1POS
1014	2422 128 02435	SWI TACT SM 50MA 12V
1018	2422 025 11072	CON BM V 3P M 2.00
1019	8204 161 43491	CON BM SM
1025	2422 025 16177	CON H 24P F 0.50 SM FFC 0.3
1026	2422 025 17892	CON BM V 3P

CAPACITORS

2001	2238 867 18129	CER1 0603 NP0 50V 12P PM1
2002	2238 867 18129	CER1 0603 NP0 50V 12P PM1
2003	2020 552 96305	CER2 0805 Y5V 10V 4U7 P8020
2004	2238 916 19849	CER2 0603 Y5V 25V 100N P8020
2005	2238 916 19849	CER2 0603 Y5V 25V 100N P8020
2006	2238 916 19849	CER2 0603 Y5V 25V 100N P8020
2007	2238 916 19849	CER2 0603 Y5V 25V 100N P8020
2008	2238 916 19849	CER2 0603 Y5V 25V 100N P8020
2009	2238 916 19849	CER2 0603 Y5V 25V 100N P8020
2010	2238 916 19849	CER2 0603 Y5V 25V 100N P8020
2011	2238 916 19849	CER2 0603 Y5V 25V 100N P8020
2012	2020 004 90299	TANCAP SM F93 35V 10U PM20
2013	2222 580 15649	CER2 0805 X7R 50V 100N PM10
2015	2020 552 96305	CER2 0805 Y5V 10V 4U7 P8020
2016	2238 916 19849	CER2 0603 Y5V 25V 100N P8020
2019	2238 916 19849	CER2 0603 Y5V 25V 100N P8020
2021	2020 552 96305	CER2 0805 Y5V 10V 4U7 P8020
2023	2238 916 19849	CER2 0603 Y5V 25V 100N P8020
2024	2238 916 19849	CER2 0603 Y5V 25V 100N P8020
2026	2238 916 19849	CER2 0603 Y5V 25V 100N P8020
2027	2022 009 00686	TANCAP SM 16V 100U PM20
2028	2238 916 19849	CER2 0603 Y5V 25V 100N P8020
2029	2238 916 19849	CER2 0603 Y5V 25V 100N P8020
2030	2238 916 19849	CER2 0603 Y5V 25V 100N P8020
2033	2238 586 15609	CER2 0603 X7R 50V 100P PM10
2034	2238 586 15609	CER2 0603 X7R 50V 100P PM10
2035	2238 916 19849	CER2 0603 Y5V 25V 100N P8020
2036	2020 004 90296	TANCAP SM 25V 4U7 PM20
2042	2238 246 19858	CER2 0603 Y5V 10V 470N P8020
2044	2020 004 90301	TANCAP SM 3 35V 2U2 PM20
2045	2238 586 15632	CER2 0603 X7R 50V 4N7 PM10
2047	2020 004 90283	TANCAP SM F93 10V 10U PM20
2049	2238 916 19849	CER2 0603 Y5V 25V 100N P8020
2050	2020 552 96305	CER2 0805 Y5V 10V 4U7 P8020
2053	2238 586 15609	CER2 0603 X7R 50V 100P PM10
2054	2238 586 15609	CER2 0603 X7R 50V 100P PM10
2056	2238 916 19849	CER2 0603 Y5V 25V 100N P8020
2075	2238 916 19849	CER2 0603 Y5V 25V 100N P8020
2079	2238 916 19849	CER2 0603 Y5V 25V 100N P8020
2086	2022 009 00686	TANCAP SM 16V 100U PM20
2087	2238 246 19858	CER2 0603 Y5V 10V 470N P8020
2093	2238 916 19849	CER2 0603 Y5V 25V 100N P8020
2099	2238 916 19849	CER2 0603 Y5V 25V 100N P8020
2100	2238 916 19849	CER2 0603 Y5V 25V 100N P8020
2105	2238 586 15609	CER2 0603 X7R 50V 100P PM10
2115	2238 586 15636	CER2 0603 X7R 50V 10N PM10

CAPACITORS

2116	2238 586 15614	CER2 0603 X7R 50V 220P PM10
2118	2020 552 96305	CER2 0805 Y5V 10V 4U7 P8020
2122	2020 552 96305	CER2 0805 Y5V 10V 4U7 P8020
2123	2020 552 96305	CER2 0805 Y5V 10V 4U7 P8020
2124	2238 586 15609	CER2 0603 X7R 50V 100P PM10

RESISTORS

3001	2322 702 60331	RST SM 0603 330R
3002	2322 702 60471	RST SM 0603 470R
3003	2322 702 60104	RST SM 0603 100K
3004	2322 730 61101	RST SM 0805 100R
3005	2322 730 61101	RST SM 0805 100R
3006	2322 730 61271	RST SM 0805 270R
3007	2322 702 60225	RST SM 0603 2M2
3008	2322 702 60222	RST SM 0603 2K2
3009	2322 702 60102	RST SM 0603 1K
3011	2322 702 60122	RST SM 0603 1K2
3012	2322 730 61478	RST SM 0805 4R7
3013	2322 730 61478	RST SM 0805 4R7
3015	2322 730 61101	RST SM 0805 100R
3017	2322 702 60102	RST SM 0603 1K
3019	2322 702 60472	RST SM 0603 4K7
3020	2322 702 60123	RST SM 0603 12K
3021	2322 702 60123	RST SM 0603 12K
3022	2322 702 60103	RST SM 0603 10K
3023	9322 117 97685	LED
3025	2322 702 60221	RST SM 0603 220R
3026	2322 702 60225	RST SM 0603 2M2
3027	2322 702 60102	RST SM 0603 1K
3028	2322 702 60104	RST SM 0603 100K
3029	2322 702 60105	RST SM 0603 1M
3030	2322 702 60105	RST SM 0603 1M
3031	2322 702 60104	RST SM 0603 100K
3032	2322 702 60334	RST SM 0603 330K
3037	2322 730 61101	RST SM 0805 100R
3038	2322 730 61101	RST SM 0805 100R
3039	2322 702 60103	RST SM 0603 10K
3042	2322 702 60222	RST SM 0603 2K2
3043	2322 702 60224	RST SM 0603 220K
3046	2322 702 60153	RST SM 0603 15K
3051	2322 762 60207	RST SM 0R2
3052	2322 730 61181	RST SM 0805 180R
3053	2322 734 63904	RST SM 0805 390K PM1
3054	2322 730 61228	RST SM 0805 2R2
3055	2322 702 60105	RST SM 0603 1M
3056	2322 702 60103	RST SM 0603 10K
3057	2322 734 62203	RST SM 0805 22K
3059	2322 702 60224	RST SM 0603 220K
3060	2322 702 60224	RST SM 0603 220K
3061	2322 702 60331	RST SM 0603 330R
3062	2322 702 60274	RST SM 0603 270K
3064	2322 702 60334	RST SM 0603 330K
3065	2120 357 90076	POTM CAR LIN 50K
3073	2322 702 60103	RST SM 0603 10K
3074	2322 702 60103	RST SM 0603 10K
3077	2322 702 60106	RST SM 0603 10M
3079	2322 702 60103	RST SM 0603 10K

ELECTRICAL PARTS LIST - TS5201 - TS5200

RESISTORS

3084	2322 730 61101	RST SM 0805 100R
3088	2322 702 60103	RST SM 0603 10K
3089	2322 702 60103	RST SM 0603 10K
3090	2322 702 60103	RST SM 0603 10K
3103	2322 702 60103	RST SM 0603 10K

3106	2322 730 61271	RST SM 0805 270R
3135	2322 730 61101	RST SM 0805 100R
3138	2322 702 96001	RST SM 0603 JUMP.
3139	2322 702 96001	RST SM 0603 JUMP.
3140	2322 702 60225	RST SM 0603 2M2

3144	2322 702 60225	RST SM 0603 2M2
3146	2322 702 96001	RST SM 0603 JUMP.
3201	2322 702 60103	RST SM 0603 10K
3202	2322 702 60332	RST SM 0603 3K3
3203	2322 702 60332	RST SM 0603 3K3

3204	2322 702 60103	RST SM 0603 10K
3902	2322 702 96001	RST SM 0603 JUMP.
3906	2322 702 96001	RST SM 0603 JUMP.
3917	2322 702 96001	RST SM 0603 JUMP.

FILTERS

5001	2422 549 41222	IND FXD 100MHZ 120R
5002	2422 549 41222	IND FXD 100MHZ 120R
5003	2422 549 41222	IND FXD 100MHZ 120R
5004	2422 549 41222	IND FXD 100MHZ 120R
5005	2422 549 41222	IND FXD 100MHZ 120R

5006	2422 535 95078	IND FXD 33U PM10
5011	2422 549 41222	IND FXD 100MHZ 120R
5013	2422 549 41222	IND FXD 100MHZ 120R
5015	2422 549 41222	IND FXD 100MHZ 120R
5017	2422 549 41222	IND FXD 100MHZ 120R

DIODES

6001	9332 153 70215	DIO SIG SM BAV99
6002	9332 153 70215	DIO SIG SM BAV99
6005	9322 172 08685	LED
6006	9322 172 08685	LED
6007	9322 172 08685	LED

6008	9322 172 08685	LED
6009	9334 606 20215	DIO SIG SM BAS16
6010	9322 105 11682	OPT SEN S4810
6012	9334 606 20215	DIO SIG SM BAS16
6017	9334 606 20215	DIO SIG SM BAS16

6018	9334 606 20215	DIO SIG SM BAS16
6021	9334 606 20215	DIO SIG SM BAS16
6024	9322 168 12685	DIO REG SM BZ15VAL
6025	9322 168 12685	DIO REG SM BZ15VAL
6026	9322 139 61685	LED

6027	9322 139 61685	LED
6028	9322 139 61685	LED
6029	9322 139 61685	LED
6030	9322 139 61685	LED
6042	9322 139 61685	LED

6043	9322 139 61685	LED
6044	9322 139 61685	LED
6045	9322 139 61685	LED
6046	9322 139 61685	LED

DIODES

6051	9322 168 12685	DIO REG SM MMBZ15VAL
6052	9322 168 12685	DIO REG SM MMBZ15VAL

TRANSISTORS & IC's

7001	8204 161 41661	MC68328PV-
7004	9322 170 84685	IC SM AD7843ARU
7006	9322 150 87668	IC SM CY62146VLL-
7007	9351 742 80118	IC SM 74LV08PW
7009	9351 895 40118	IC SM 74HCT153PW

7011	9351 742 10118	IC SM 74LV04PW
7012	9351 751 40118	IC SM 74LV74PW
7013	9336 286 30215	TRA SIG SM BC817-25
7016	9335 895 90215	TRA SIG SM BC847B
7017	9335 897 60215	TRA SIG SM BC857B

7018	9335 895 90215	TRA SIG SM BC847B
7019	9335 895 90215	TRA SIG SM BC847B
7020	9335 897 60215	TRA SIG SM BC857B
7021	9335 895 90215	TRA SIG SM BC847B
7022	9336 286 30215	TRA SIG SM BC817-25

7026	9335 897 60215	TRA SIG SM BC857B
7028	9322 138 60685	IC SM MN1382-R
7031	9322 033 40668	IC SM MC34063AD
7032	9335 897 60215	TRA SIG SM BC857B
7033	9335 895 90215	TRA SIG SM BC847B

7035	9335 895 90215	TRA SIG SM BC847B
7043	9335 895 90215	TRA SIG SM BC847B
7046	9335 897 60215	TRA SIG SM BC857B
7059	3104 208 55721	RC5201 SW ASSY
7064	9336 286 30215	TRA SIG SM BC817-25

7067	9351 742 80118	IC SM 74LV08PW
7071	9351 742 80118	IC SM 74LV08PW
7072	9335 895 90215	TRA SIG SM BC847B
7074	9322 171 42685	IC SM LT1761ES5-3.3
7075	9335 897 60215	TRA SIG SM BC857B

ELECTRICAL PARTS LIST - TS5201 - TS5200

RFTX2 BOARD ASSY:**3104 207 11300 - 434MHz used in TS5201****3104 207 11290 - 418MHz used in TS5200**

MISCELLANEOUS

1002	3104 201 23700	ANTENNA DIA 18MML
1003	8204 161 44261	3 PL.HE.FEM.SMD-FCI

CAPACITORS

2002	2238 861 18828	CER1 0805 NP0 50V 8P2
2002	2238 861 18109	50V 10P only in 418MHZ
2003	2238 861 18109	CER1 0805 NP0 50V 10P
2003	2238 861 18129	50V 12P only in 418MHZ
2004	2238 861 18129	CER1 0805 NP0 50V 12P
2004	2238 861 18159	50V 15P only in 418MHZ
2005	2238 861 18109	CER1 0805 NP0 50V 10P
2006	2238 861 18828	50V 8P2 only in 418MHZ
2007	2238 861 18229	CER1 0805 NP0 50V 22P
2007	2238 861 18279	50V 27P only in 418MHZ
2008	2238 861 18229	CER1 0805 NP0 50V 22P
2008	2238 861 18339	50V 33P only in 418MHZ
2009	2238 861 18339	CER1 0805 NP0 50V 33P
2010	2238 861 18339	CER1 0805 NP0 50V 33P
2011	2238 861 15471	CER1 0805 NP0 50V 470P
2012	2238 861 15471	CER1 0805 NP0 50V 470P
2013	2238 861 18129	50V 12P only in 434MHZ
2014	2238 861 18159	50V 15P only in 418MHZ
2015	2238 861 15471	CER1 0805 NP0 50V 470P
2016	2238 861 15471	CER1 0805 NP0 50V 470P

RESISTORS

3001	2322 730 61569	RST SM 0805 56R
3002	2322 730 61471	RST SM 0805 470R
3003	2322 730 61273	RST SM 0805 27K
3004	2322 730 61273	RST SM 0805 27K
3005	2322 730 61229	RST SM 0805 22R
3901	2322 730 91002	RST SM 0805 JUMP.
3902	2322 730 91002	RST SM 0805 JUMP.

FILTERS

5001	2422 535 94152	IND FXD SM 0805 27N
5003	2422 535 94151	IND FXD SM 0805 22N
5004	2422 535 94151	IND FXD SM 0805 22N
5005	2422 549 41993	IND FXD EMI 100MHZ
5006	2422 549 41993	IND FXD EMI 100MHZ
5010	2422 540 98562	RES 434MHZ only in 434MHZ
5010	2422 540 98545	RES 418MHZ only in 418MHZ
5011	2422 549 41993	IND FXD EMI 100MHZ

TRANSISTORS

7001	9337 502 50215	TRA SIG SM BFS17A
------	----------------	-------------------



DOCKING STATION
DS5200

MECHANICAL INSTRUCTIONS

Set Disassembly - Docking station



- 1. Remove the four rubber feet
- 2. Remove 4 x screw see picture - arrows

Overview snapholes



- 3. Put a sharp knife between toppart and bottompart and use this as lever to separate the two parts. For the correct position of the knife see snapholes in picture

Overview disassembled parts

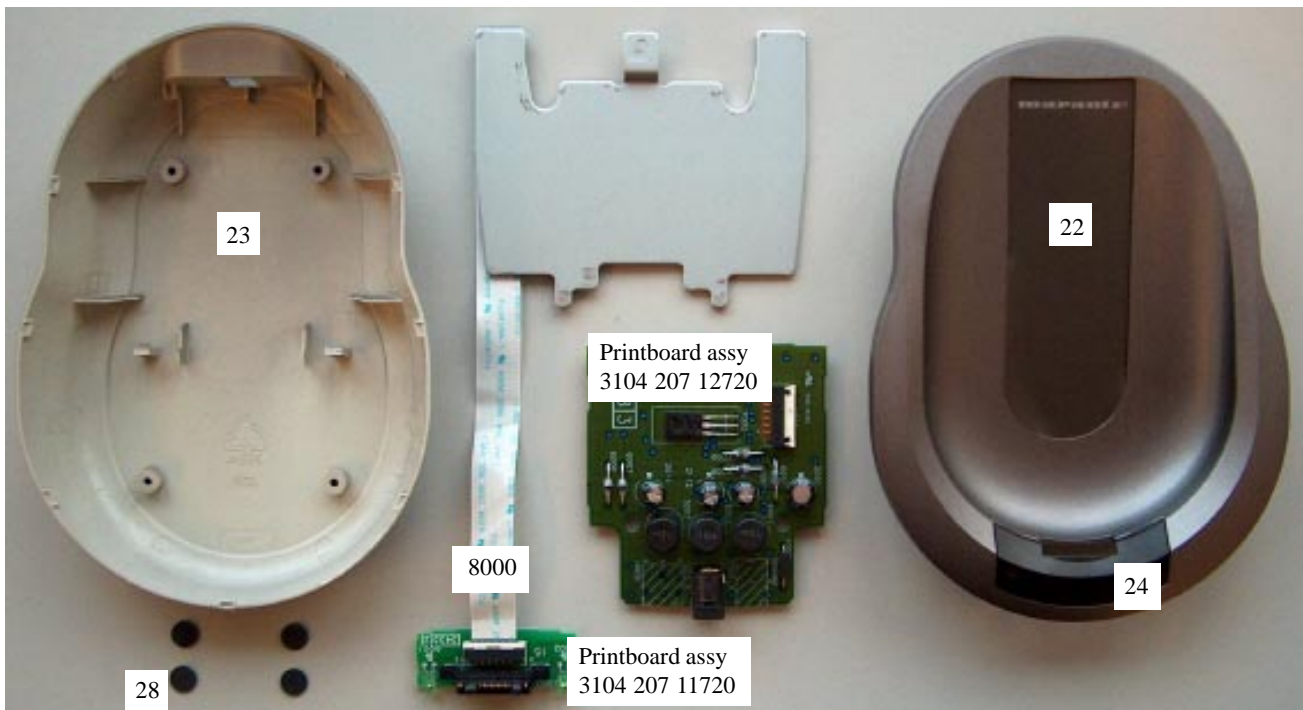

CHARGER DIAGRAM

1

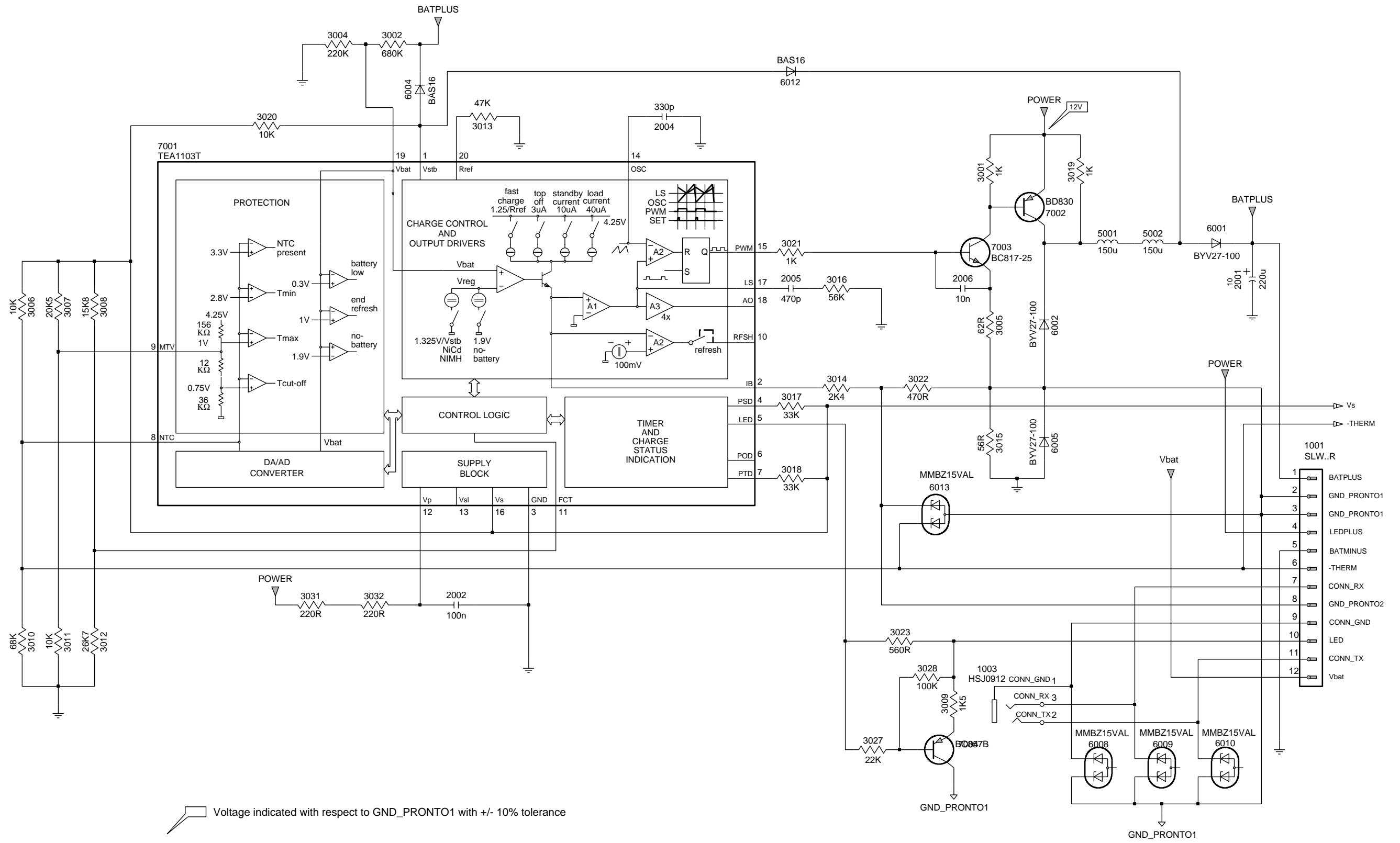

Voltage indicated with respect to GND_PRONTO1 with +/- 10% tolerance

CHARGE BOARD -Component Layout

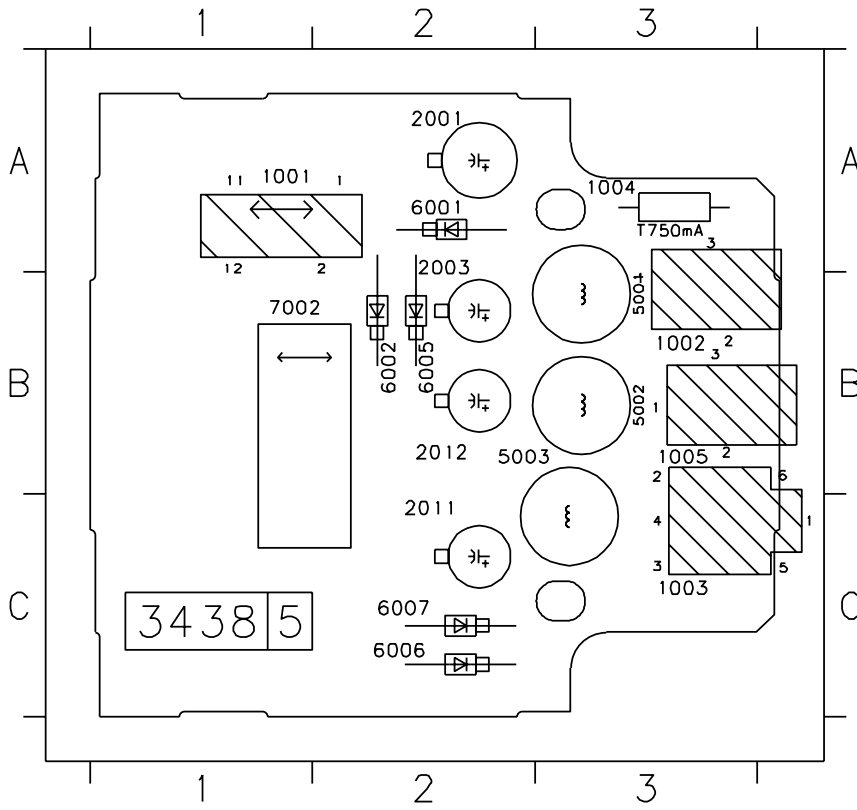

- 1001 A1
- 1002 A3
- 1003 C3
- 1004 B3
- 2001 A2
- 2003 B2
- 2011 C2
- 2012 B2
- 5001 A3
- 5002 B3
- 5003 B3
- 6001 A3
- 6002 B2
- 6005 B2
- 6006 C2
- 6007 C2
- 7002 B1

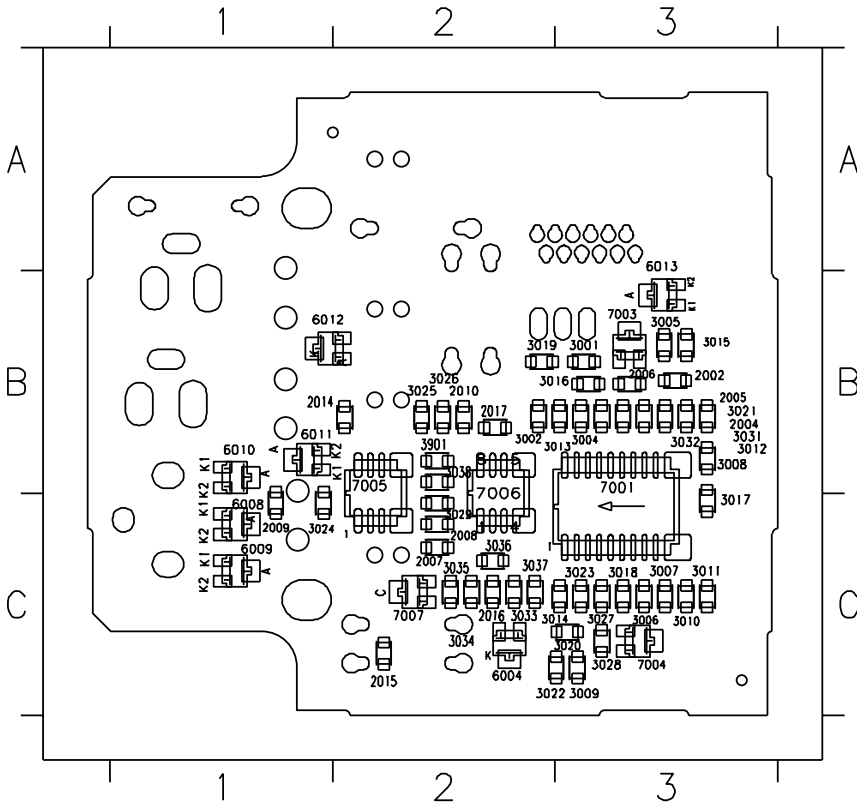

- 2002 B3
- 2004 B3
- 2005 B3
- 2006 B3
- 2007 C2
- 2008 C2
- 2009 B2
- 2010 B2
- 2014 B2
- 2015 C1
- 3001 B3
- 3002 B2
- 3004 B3
- 3005 B3
- 3006 C3
- 3007 C3
- 3008 B3
- 3009 C3
- 3010 C3
- 3011 C3
- 3012 B3
- 3013 B2
- 3014 C2
- 3015 B3
- 3016 B3
- 3017 C3
- 3018 C3
- 3019 B2
- 3020 C2
- 3021 B3
- 3022 C2
- 3023 C3
- 3024 B2
- 3025 B2
- 3026 B2
- 3027 C3
- 3028 C3
- 3029 C2
- 3031 B3
- 3032 B3
- 6004 C2
- 6008 C1
- 6009 C1
- 6010 B1
- 6011 B1
- 6012 B1
- 6013 B3
- 7001 C3
- 7003 B3
- 7004 C3
- 7005 B2

MECHANICAL & ELECTRICAL PARTS LIST - Docking Station DS5200

ELECTRICAL PARTS

1004	2422 086 11074	FUSE 750mA 125V UL
	3104 207 13730	DOCKING STATION



3104 207 13730 DOCKING STATION

Note: Only the parts mentioned in this list are normal service parts

For more information:

E-mail: erik.gybels@philips.com

Overview disassembled parts

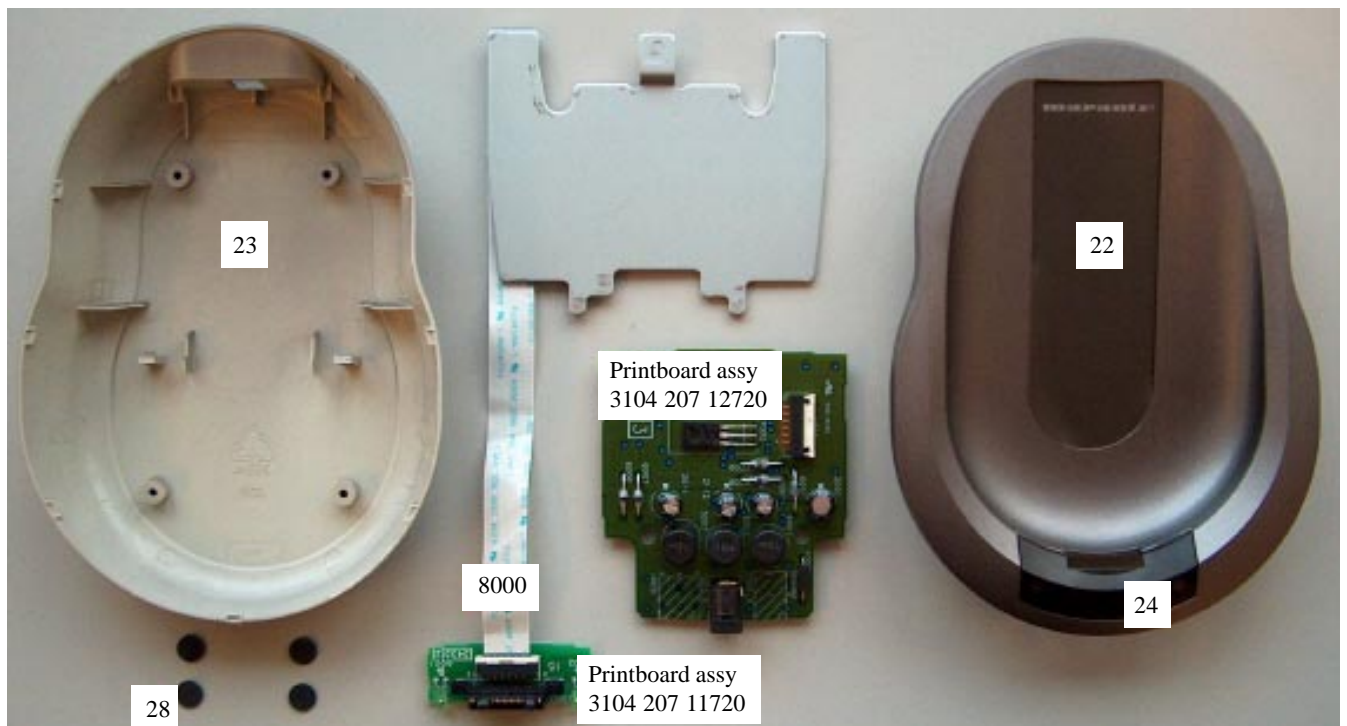

ELECTRICAL & MECHANICAL PARTS LIST- Docking Station DS5200**MECHANICAL PARTS**

22	3104 207 79210	TOPPART ASSY
23	3104 207 79220	BOTTOMPART ASSY
24	3104 204 18540	LENS
28	3139 224 20710	RUBBER FEET

PRINTBOARD ASSY 3104 207 12720**MISCELLANEOUS**

1001	2422 025 17146	CON BM H 12P
1004	2422 086 11074	FUSE 750mA 125V UL
1005	2422 026 03455	SOC POWER

CAPACITORS

2001	2020 024 90701	ELCAP 10V 220U
2002	2238 910 19849	CER2 0805 25V 100N
2003	2020 012 93777	ELCAP 25V S 100U
2004	2238 861 15471	CER1 0805 NP0 50V 470P
2005	2238 580 15618	CER2 0805 X7R 50V 470P
2006	2238 580 15636	CER2 0805 X7R 50V 10N
2014	2238 861 15471	CER1 0805 NP0 50V 470P

RESISTORS

3001	2322 730 61102	RST SM 0805 1K
3002	2322 730 61684	RST SM 0805 680K
3004	2322 730 61224	RST SM 0805 220K
3005	2322 730 61629	RST SM 0805 62R
3006	2322 730 61103	RST SM 0805 10K
3007	2322 734 62053	RST SM 0805 20K5
3008	2322 734 61583	RST SM 0805 15K8
3010	2322 730 61683	RST SM 0805 68K
3011	2322 734 61003	RST SM 0805 10K
3012	2322 734 62673	RST SM 0805 26K7
3013	2322 730 61473	RST SM 0805 47K
3014	2322 730 61182	RST SM 0805 1K8
3015	2322 730 61569	RST SM 0805 56R
3016	2322 730 61563	RST SM 0805 56K
3017	2322 730 61333	RST SM 0805 33K
3018	2322 730 61333	RST SM 0805 33K
3019	2322 730 61102	RST SM 0805 1K
3020	2322 730 61103	RST SM 0805 10K
3021	2322 730 61102	RST SM 0805 1K
3022	2322 730 61471	RST SM 0805 470R
3023	2322 730 61681	RST SM 0805 680R
3031	2322 730 61221	RST SM 0805 220R
3032	2322 730 61221	RST SM 0805 220R

FILTERS

5001	2422 535 94841	IND FXD 150U
.5002	2422 535 94841	IND FXD 150U

DIODES

6001	9335 435 00133	DIO REC BYV27-100
.6002	9335 435 00133	DIO REC BYV27-100
.6004	9334 606 20215	DIO SIG SM BAS16
.6005	9335 435 00133	DIO REC BYV27-100
.6008	9322 168 12685	DIO REG SM MMBZ15V

DIODES

6009	9322 168 12685	DIO REG SM MMBZ15V
6010	9322 168 12685	DIO REG SM MMBZ15V
6012	9334 606 20215	DIO SIG SM BAS16
6013	9322 168 12685	DIO REG SM MMBZ15V

TRANSISTORS & IC's

7001	9352 604 38118	IC SM TEA1103T/N2
7002	9332 480 40687	TRA POWER BD136
7003	9336 286 30215	TRA SIG SM BC817-25

PRINTBOARD ASSY 3104 207 11720**MISCELLANEOUS**

1001	2422 025 17146	CONN. BM 12P
1002	8204 161 43590	CONN. BM
8000	3104 200 51370	FLEX CABLE

DIODES

6001	9322 106 63675	LED GREEN
6002	9322 106 63675	LED GREEN