

Service Manual

SM-11S1 /F N/K1G/N1G/U1G/N1S

Stereo Power Amplifier

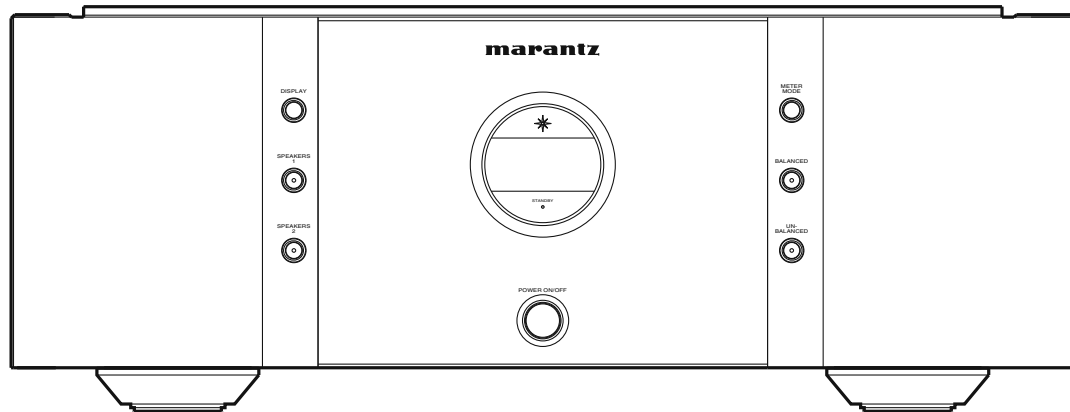

SM-11S1

TABLE OF CONTENTS

SECTION	PAGE
1. TECHNICAL SPECIFICATIONS	1
2. CAUTION	1
3. ALIGNMENTS	2
4. SERVICE MODE	7
5. UPDATE FIRMWARE	8
[A] SOFTWARE (fdtv307r01.exe) DOWNLOADS AND INSTALLS PROCEDURE	8
[B] WRITING AND UPDATE SOFTWARE	24
6. WIRING DIAGRAM	35
7. BLOCK DIAGRAM	37
8. SCHEMATIC DIAGRAM	39
9. PARTS LOCATION	47
10. EXPLODED VIEW AND PARTS LIST	61
11. MICROPROCESSOR AND IC DATA	65
12. ELECTRICAL PARTS LIST	71
13. ABOUT REPLACE THE MICROPROCESSOR WITH A NEW ONE	86

Please use this service manual with referring to the user guide (D.F.U.) without fail.
修理の際は、必ず取扱説明書を準備し操作方法を確認の上作業を行ってください。

marantz®

SM-11S1

MARANTZ DESIGN AND SERVICE

Using superior design and selected high grade components, **MARANTZ** company has created the ultimate in stereo sound. Only original **MARANTZ** parts can insure that your **MARANTZ** product will continue to perform to the specifications for which it is famous.

Parts for your **MARANTZ** equipment are generally available to our National Marantz Subsidiary or Agent.

ORDERING PARTS :

Parts can be ordered either by mail or by Fax.. In both cases, the correct part number has to be specified.

The following information must be supplied to eliminate delays in processing your order :

1. Complete address
2. Complete part numbers and quantities required
3. Description of parts
4. Model number for which part is required
5. Way of shipment
6. Signature : any order form or Fax. must be signed, otherwise such part order will be considered as null and void.

USA

MARANTZ AMERICA, INC
100 CORPORATE DRIVE
MAHWAH, NEW JERSEY 07430
USA

EUROPE / TRADING

MARANTZ EUROPE B.V.
P. O. BOX 8744, BUILDING SILVERPOINT
BEEMDSTRAAT 11, 5653 MA EINDHOVEN
THE NETHERLANDS
PHONE : +31 - 40 - 2507844
FAX : +31 - 40 - 2507860

CANADA

D&M CANADA INC.
5-505 APPLE CREEK BLVD.
MARKHAM, ONTARIO L3R 5B1
CANADA

JAPAN

D&M Holdings Inc.
D&M BUILDING, 2-1 NISSHIN-CHO,
KAWASAKI-KU, KAWASAKI-SHI,
KANAGAWA, 210-8569 JAPAN

株式会社 ディーアンドエムホールディングス
本社 〒210-8569
神奈川県川崎市川崎区日進町2-1 D&Mビル



KOREA

D&M SALES AND MARKETING KOREA LTD.
CHUNG JIN B/D., #1001,
53-5, WONHYORO 3 GA, YONGSAN-GU,
SEOUL, 140-719, KOREA
PHONE : +82 - 2 - 323 - 2155
FAX : +82 - 2 - 323 - 2154

CHINA

MARANTZ SHANGHAI TRADING LTD.
ROOM.506 SHANGHAI LIGHT INDUSTRY MANSION
1578 NANJING (WEST) ROAD SHANGHAI
CHINA
TEL : 021 - 6248 - 1064
FAX : 021 - 6248 - 3565

NOTE ON SAFETY :

Symbol  Fire or electrical shock hazard. Only original parts should be used to replaced any part marked with symbol  . Any other component substitution (other than original type), may increase risk of fire or electrical shock hazard.

安全上の注意 :

 がついている部品は、安全上重要な部品です。必ず指定されている部品番号のものを使用して下さい。

SHOCK, FIRE HAZARD SERVICE TEST :

CAUTION : After servicing this appliance and prior to returning to customer, measure the resistance between either primary AC cord connector pins (with unit NOT connected to AC mains and its Power switch ON), and the face or Front Panel of product and controls and chassis bottom.

Any resistance measurement less than 1 Megohms should cause unit to be repaired or corrected before AC power is applied, and verified before it is return to the user/customer.

Ref. UL Standard No. 60065.

In case of difficulties, do not hesitate to contact the Technical Department at above mentioned address.

1. TECHNICAL SPECIFICATIONS

Power output (20 Hz ~ 20 kHz simultaneous drive of both channels)
 110W + 110W (8Ω load)
 220W + 220W (4Ω load)
 Power output during BTL 420 W (8Ω load)
 Total harmonic distortion
 (20Hz ~ 20kHz simultaneous drive of both channels)
 0.02% (8Ω load)
 Output band width (8Ω load, 0.05%) 5Hz ~ 40kHz
 Frequency response (1W, 8Ω load) 5Hz ~ 120kHz
 Dumping factor (8Ω load, 20Hz ~ 20kHz) 110
 Input sensitivity/Input impedance
 2V / 22kΩ (BALANCED)
 2V / 22kΩ (UNBALANCED)
 S/N (IHF-A, 1W, 8Ω load)
 101dB (BALANCED)
 101dB (UNBALANCED)
 Voltage amplification
 17dB (GAIN SETTING: -6dB)
 23dB (GAIN SETTING: ±0dB)
 29dB (GAIN SETTING: +6dB)
 Power requirement
 [F] AC 100V 50/60Hz
 [N] AC 230V 50/60Hz
 [U] AC 120V 60Hz
 Power consumption
 EN60065, UL60065 380W
 J60065 [F] 300W
 Maximum outer dimensions
 Width 440mm (17-3/8 in)
 Height 168mm (6-5/8 in)
 Depth 429mm (16-15/16 in)
 Weight 26.6kg (56.6 lbs)
 Accessories
 Detachable AC power cable 1

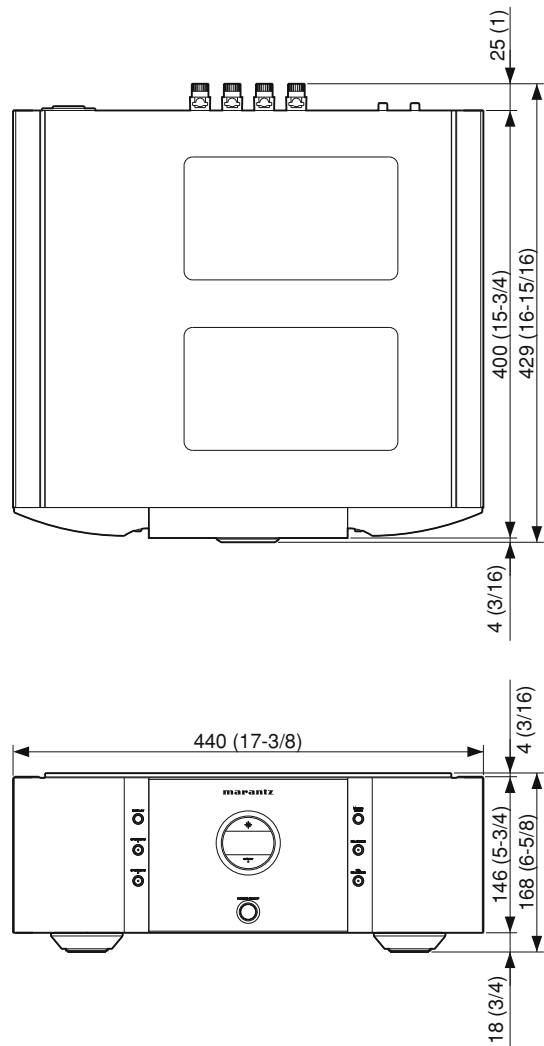

2. CAUTION

The layout of this amplifier is well concerned for sound quality.

1. When screws and washers are removed, those parts must be set to the same places.
2. When wires are removed, the wires must be installed in the same roots, same places.
3. Do not hold the side panel (001D) to move the unit when the unit is disassembled.

2. 注意

当機は音質を考慮したレイアウトになっています。

1. ネジやワッシャ類を取り外した場合、元の位置に取り付けてください。
2. ワイヤ類を取り外した場合の配線ルートは、元のルート通りに戻してください。
3. 当機を分解した状態で移動するときは、サイドパネル(001D)を持たないでください。

3. ALIGNMENTS

Set the power voltage to rated voltage for this adjustment.

調整時は必ず電源電圧を定格電圧に合わせてください。

1. DC Offset Voltage Adjustment

1. DCオフセット電圧調整

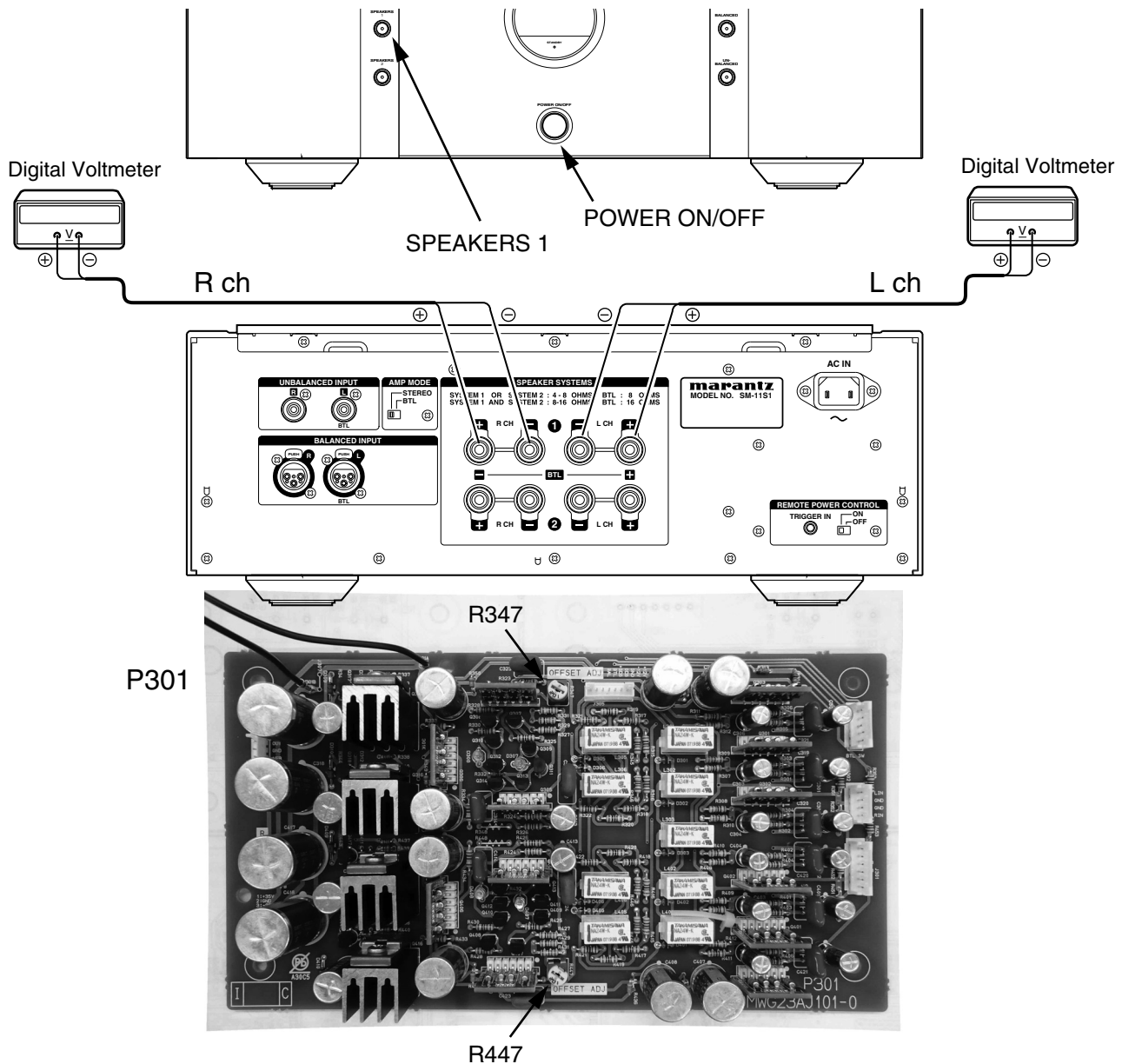

1. Before turning on the power, Insert Digital Voltage Meter between the SPEAKER SYSTEMS 1 (L CH) "+" and "-". Insert Digital Voltage Meter between the SPEAKER SYSTEMS 1 (R CH) "+" and "-".
2. Turn on the power. Then press the **SPEAKERS 1** Button. Adjustment is started immediately after a speaker relay turns on
3. First L CH is adjusted.
The variable resistor **R347** on P301 is turned with adjustment driver, and the Digital Voltage Meter is adjusted to "**0mV ±3mV**".
4. Then, R CH is adjusted.
The variable resistor **R447** on P301 is turned with adjustment driver, and the Digital Voltage Meter is adjusted to "**0mV ±3mV**".

1. 電源をONする前にリアパネルのSPEAKER SYSTEMS 1のL CH およびR CH それぞれの"+"端子と "-"端子間にデジタルポルトメーターを接続します。
2. 電源を投入し本体前面の**SPEAKERS 1** のボタンをONにします。
スピーカーリレーがONした直後から調整を開始します。
3. 最初にL CHを調整します。
P301基板の半固定抵抗**R347**を調整ドライバーで回し、L CHスピーカー出力端子に接続したデジタルポルトメーターの電圧が"**0mV ±3mV**"以内になるように調整します。
4. 続けて、R CHを調整します。P301 基板の半固定抵抗**R447**を調整ドライバーで回し、R CHスピーカー出力端子に接続したデジタルポルトメーターの電圧が "**0mV ±3mV**" 以内になるように調整します。
5. 調整後DCオフセット電圧は多少の変動はありますが、

- Although after-adjustment DC offset voltage has some change, Please check that the range of DC offset voltage between L ch (R ch) "+" and L ch (R ch) "-" terminal of SPEAKER SYSTEMS 1 is "0mV ±20mV".

SPEAKER SYSTEMS 1 の L CH および R CH それぞれの"+"端子と "-"端子間のDCオフセット電圧は "0mV ±20mV" の範囲であることを確認してください。

2. Idling Current Adjustment

After DC Offset Voltage Adjustment is completed, adjust the Idling Current with the variable resistor **R519** and **R619** on the PWB (P501/P601).

2. アイドリング電流調整

DCオフセット電圧調整終了後、P501/P601基板上の半固定抵抗 **R519**と**R619**でアイドル電流を調整します。

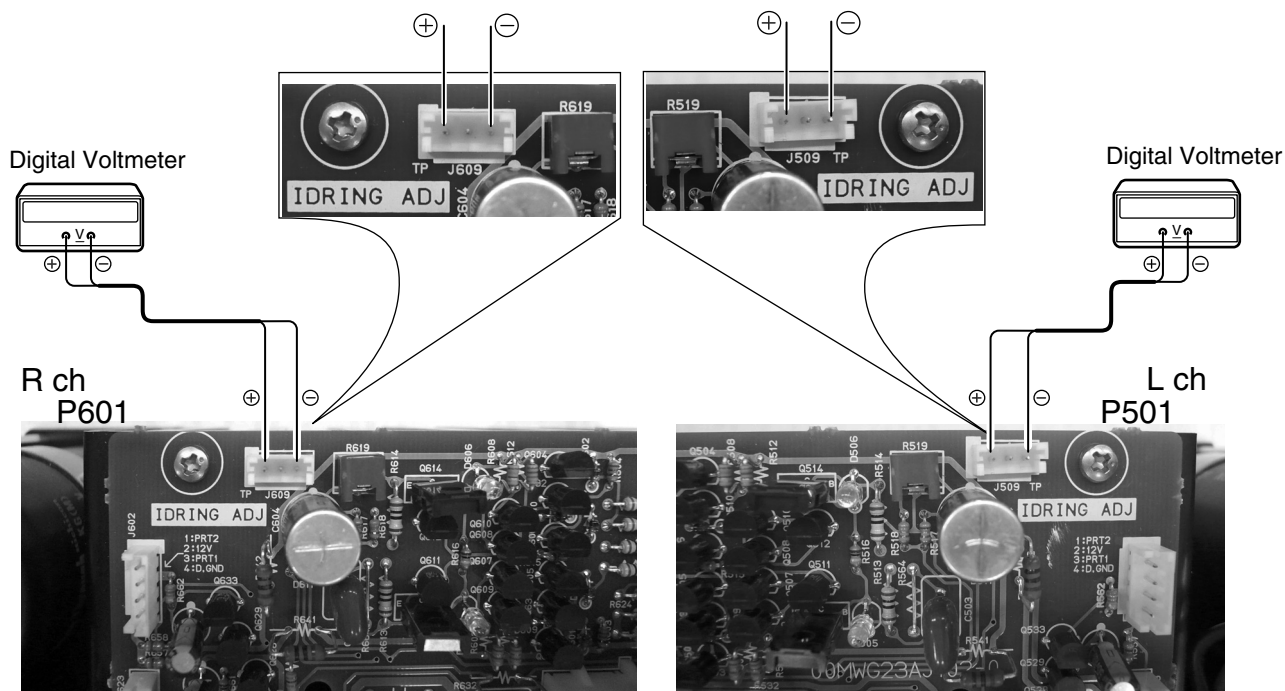

- Turn off the power.
- "+" of Connect Digital Voltage is connected to the **No. 1** pin and connected "-" to **No. 3** pin of **J509**.
- "+" of Connect Digital Voltage is connected to the **No. 1** pin and connected "-" to **No. 3** pin of **J609**.
- Before turning on the power, **R519** and **R619** have been counter clockwise turned with the adjustment driver.
- Turn on the power.
- With seeing the digital voltage meter turn the variable resistor clockwise slowly to adjust the idling current. Idling adjustment with **R519** (**R619**).
 - Turn **R519** (**R619**) clockwise to increase the idling current.
 - The adjustment value of idling current is **7mV(35mA)** each after turn on the power 3 minutes.
- Confirm the current value becomes about **10mV(50mA)** after turn on the power 10 minutes later. Adjustment is completed.
- The current value is stable with about 10mV (50mA) after turn on the power in about 30 minutes.
- Remove connection cable, attach the top cover.

- 電源をOFFします。
- P501基板の**J509**にデジタルボルトメーターを接続します。デジタルボルトメーターは**J509**の1番ピン（丸印側）を"+"、3番ピンを "-"に接続します。
- P601基板の**J609**にデジタルボルトメーターを接続します。デジタルボルトメーターは**J609**の1番ピン（丸印側）を"+"、3番ピンを "-"に接続します。
- 電源を投入する前に半固定抵抗**R519**と**R619**を、調整ドライバーで反時計方向に回しきってください。
- 電源をONします。
- P501基板の**J509**(**J609**)に接続したデジタルボルトメーターの電圧値を監視しながら、半固定抵抗**R519**(**R619**)をゆっくりと時計方向に回してください。
 - R519**と **R619**を時計方向に回すとアイドル電流が増加します。
 - アイドル電流の調整値は、電源投入から3分後にそれぞれ**7mV(35mA)**にします。
- 電源投入10分後に約**10mV(50mA)**の値になることを確認します。以上で調整は完了です。
- 電源投入後約30分で約10mV(50mA)で安定します。
- デジタルボルトメーターの接続を外し、トップカバーを取付けます。

3. PROCEDURE FOR POWER METER ADJUSTMENT

At the time of the adjustment, please make sure to adjust the power supply voltage to the rated voltage and frequency.

[A] STEREO MODE adjustment

1. Connect an 8-ohm ($\geq 100W$) dummy load to each of the L-ch and R-ch speaker terminals.
Set the AMP MODE SW on the rear panel to **STEREO**.
2. Connect an oscillator to the UN-BALANCED input terminal each of the L-ch and R-ch. Make sure that the frequency is 1kHz, keep the output down and then turn on the oscillator.
3. Hold down the **SPEAKERS 2** button and **UN-BALANCED** button at the same time when turning on the unit. (It switches to the Meter Adjustment Mode.)

```
L POWER R
0.00 0.00
```

4. Adjust the oscillator output to 1.89 V (rms).
5. Adjust the L-ch. The display will indicate the status as shown on the following figure (for one):

```
L POWER R
123 753
```

Press the **DISPLAY** button once, and the display indicates "L" on the left once the unit is switched to the adjustment mode.

```
L POWER
123 753
```

Check the display and adjust the L-ch output level until it indicates "100". The unit has two keys with a variability of plus and minus 50% at a maximum: one varies 5%, the other 1%, at every one push. At first, press the 5% key, adjust the level until the display indicates nearly 100, and then press the 1% key and set the level to 100.

	Down ▼	Up ▲
1%	SPEAKERS 1	BALANCED
5%	SPEAKERS 2	UN-BALANCED

When the value is below 100, turn UP (▲).
When the value is above 100, turn DOWN (▼).

```
L POWER
100 075
```

3. Power Meter 調整手順

調整時は必ず電源電圧を定格電圧・周波数に合わせてください。

[A] STEREO MODEの調整

1. Lch, Rchスピーカ端子にそれぞれ8Ω (100W以上)のダミーロードを接続してください。
Rear Panel のAMP MODE SWは**STEREO**にしてください。
2. Lch, RchのUN-BALANCED入力端子に発振器を接続します。発振器は1kHzで出力は絞っていることを確認して発振器の電源を入れます。
3. **SPEAKERS 2**ボタンと**UN-BALANCED**ボタンを押しながら電源を入れます。(メーター調整モードになります。)

4. 発振器の出力が1.89V (rms) になる様に発振器の出力を調整します。
5. Lchの調整を行います。この時表示は下図の様になります。(数値は一例です。)

DIAPLAYボタンを1回押します。調整モードに入ると上段左にLが表示されます。

ディスプレイのLch側の出力電力表示を見ながら表示が"100"になるように調整します。最大±50%の調整量を持ち、1回押す毎に1%表示を可変するキーと5%可変するキーがあります。始めは5%表示を可変するキーで100近傍まで調整をして、次に1%表示を可変するキーを用い100に合わせてください。

表示された数値が100より小さい時： Up (▲)
表示された数値が100より大きい時： Down (▼)

When the adjustment is completed, press the **DISPLAY** button once again.

6. Next, adjust the R-ch. The display will indicate the status as shown on the following figure (for one):



POWER R
100 0.75

It can be adjusted in the same way as the L-ch except that the display indicates "R".



POWER R
100 100

When the adjustment is completed, press the **DISPLAY** button once again as with the L-ch.

- This is the end of the STEREO MODE adjustment. After confirming the message shown on the following figure, turn off the power.



INITIAL
OK

[B] BTL MODE adjustment

1. Connect an 8-ohm ($\geq 100W$) dummy load to each of the L-ch and R-ch speaker terminals.
Set the AMP MODE SW to **BTL**.
2. Connect an oscillator to the UN-BALANCED input terminal of the L-ch. Make sure that the frequency is 1kHz, keep the output down and then turn on the oscillator.
3. Hold down the **SPEAKERS 2** button and **UN-BALANCED** button at the same time when turning on the unit. (It switches to the Meter Adjustment Mode.)
4. Adjust the oscillator output to 0.945 V (rms).
5. Adjust the BTL Mode. The display will indicate the status as shown on the following figure (for one):

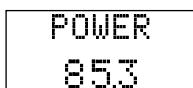

POWER
85.3

Press the **DISPLAY** button once, and the display indicates "-" on both the right and left once the unit is switched to the adjustment mode.



- POWER -
85.3

Check the display and adjust the L-ch output level until it indicates "100". The unit has two keys with a variability of plus and minus 50% at a maximum: one varies 5%, the other 1%, at every one push. At first, press the 5% key,

調整終了後もう一度**DISPLAY**ボタンを1回押します。

6. 次にRchの調整を行います。この時表示は下図のようになります。

調整方法はLchと同様ですが、表示はRch側となります。

調整終了後Lch同様にもう一度**DISPLAY**ボタンを1回押します。

- これでSTEREO MODEの調整は終わりです。下図のメッセージ確認後、電源を切ってください。

[B] BTL MODEの調整

1. **SPEAKERS 1**のLch, Rchの+スピーカ端子に8Ω(100W以上)のダミーロードを接続してください。
AMP MODE SWは**BTL**にしてください。
2. L-chの**UN-BALANCED**入力端子に発振器を接続します。発振器は1kHzで出力は絞っていることを確認して発振器の電源を入れます。
3. **SPEAKERS 2**ボタンと**UN-BALANCED**ボタンを押しながら電源を入れます。(メーター調整モードになります)
4. 発振器の出力が0.945V (rms)になる様に発振器の出力を調整します。
5. **BTL**モードの調整を行います。この時表示は下図のようになります。
(数値は一例です。)

DISPLAYボタンを1回押します。調整モードに入ると上段左右にマイナスが表示されます。

ディスプレイのLch側の出力電力表示を見ながら表示が"100"になるように調整します。最大±50%の調整量を持ち、1回押す毎に1%表示を可変するキーと5%可変するキーがあります。始めは5%表示を可変するキーで100近傍まで

adjust the level until the display indicates nearly 100,
and then press the 1% key and set the level to 100.

調整をして、次に1%表示を可変するキーを用い100に合わせてください。

	Down ▼	Up ▲
1%	SPEAKERS 1	BALANCED
5%	SPEAKERS 2	UN-BALANCED

When the value is below 1.00, BALANCED (▲).
When the value is above 1.00, SPEAKERS 1 (▼).

表示された数値が1.00より小さい時： BALANCED (▲)
表示された数値が1.00より大きい時： SPEAKERS 1 (▼)



When the adjustment is completed, press the
DISPLAY button once again.

調整終了後もう一度**DISPLAY**ボタンを1回押します。
下図のメッセージ確認後、電源を切ってください。

Confirm that the message as on the following figure is shown
on the display and then turn off the power.



This is the end of the BTL MODE adjustment.

これで BTL MODE の調整は終わりです。

4. SERVICE MODE

- To enter the Service Mode, press the **POWER ON/OFF** button with pressing the **DISPLAY** and **METER MODE** buttons to turn on the unit.
When into the Service Mode, the memory is cleared and the unit is initialized.
- The Model name and Version number are displayed on the Front LCD.
Whenever press the **DISPLAY** button, the display changes as follows.
Turn off power to quit service mode.

- 本体の**DISPLAY**ボタンと**METER MODE**ボタンを押しながら**POWER ON/OFF**ボタンを押します。
注意：サービスモードに入ると、全ての設定がクリアされ出荷状態になります。
- バージョンとモデル名が表示されます。
DISPLAYボタンを押すたびに下記の表示となります。
POWER ON/OFFボタンを押し、電源を切るとサービスモードが解除されます。

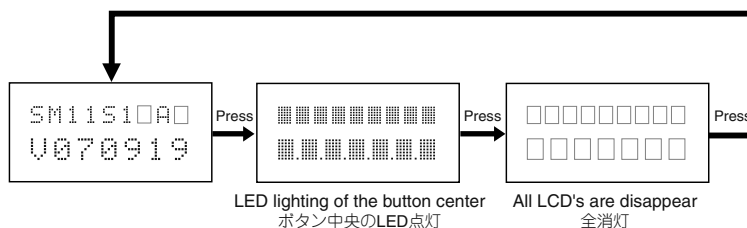

SERIAL NUMBER CHECK MODE

- To enter the serial number check mode, press the **POWER ON/OFF** button with pressing the **SPEAKERS 1** and **BALANCED** buttons to turn on the unit.
- The Serial number is displayed on the Front LCD.
Turn off power to quit serial number check mode.

シリアル番号の確認

- 本体の**SPEAKERS 1**ボタンと**BALANCED**ボタンを押しながら**POWER ON/OFF**ボタンを押します。これでシリアル番号の確認モードに入ります。
- シリアル番号が表示されます。
POWER ON/OFFボタンを押し、電源を切るとシリアル番号の確認モードが解除されます。

Initial settings 出荷状態内容

INPUT :	BALANCED
DISPLAY :	ON
SPEAKERS (1, 2) :	OFF
SIDE ILLUMINATION :	ON
GAIN :	0dB
METER MODE :	MODE 1

5. UPDATE FIRMWARE

[A] SOFTWARE (fdtv307r01.exe) DOWNLOADS AND INSTALLS PROCEDURE

[A-1] DOWNLOADS OF THE SOFTWARE

(Flash Development Toolkit: the rest is FDT)

Download the software for update/write-in of the microprocessor.

1. Launch the browser.
2. Type the "http://www.renesas.com/" into an address. And click the **Go** or press the **Enter** on keyboard of PC.

NOTE : This site is managed by RENESAS. The following explanation may differ from the actual composition. When different, please proceed along with the site composition of RENESAS.

3. Click the **GLOBAL SITE**.

5. UPDATE FIRMWARE

[A] SOFTWARE (fdtv307r01.exe) DOWNLOADS AND INSTALLS PROCEDURE

[A-1] DOWNLOADS OF THE SOFTWARE

(Flash Development Toolkit: 以下 FDT)

マイコンの書き込み用ソフトウェア(FDT)をダウンロードします。

1. ブラウザ(インターネットエクスプローラーなど)を立ち上げます。
2. ブラウザのアドレスに"http://www.renesas.com/"を入力し、**移動**、またはキーボードの**Enter**を押します。

注意 : このサイトはRENESASが管理しているため、以下の説明が実際のサイト構成と異なっている場合があります。その場合は実際のRENESASのサイト構成に沿って進めてください。

3. **GLOBAL SITE**をクリックします。

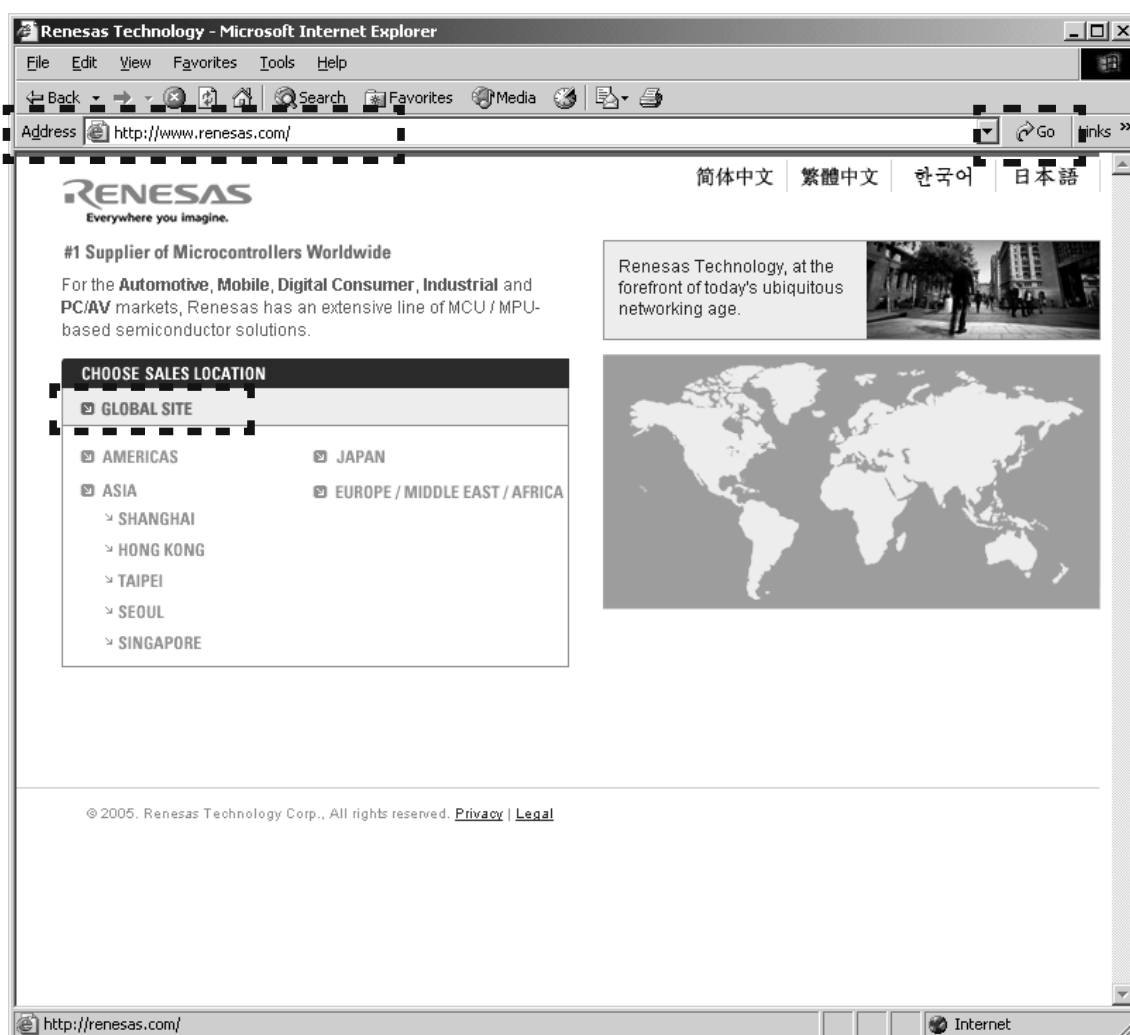

4. A login ID is necessary to download the FDT.
 If you have Login ID, please advance to step 15.
 If you do not have Login ID, Click the **MY RENESAS**.

4. FDTのダウンロードにはLogin IDが必要になります。
 既にLogin IDを持っている方は手順の15へ進んでください。
 Login IDを持っていない方は**MY RENESAS**をクリックします。



5. Click the **If you are a new user click here to register now.**

5. **If you are a new user click here to register now**をクリックします。

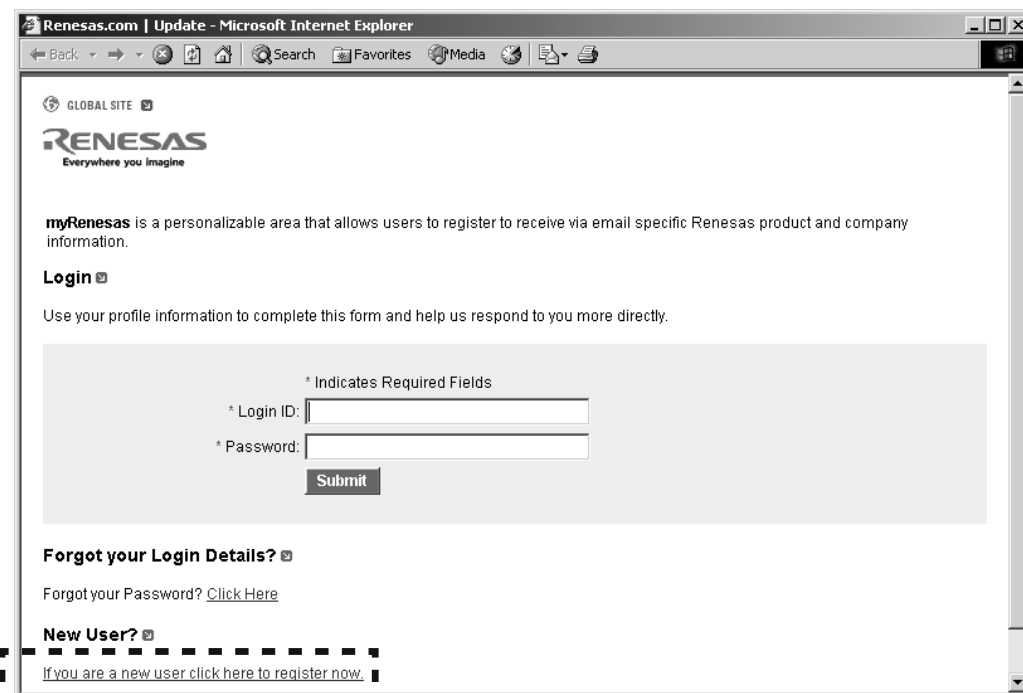

6. Choose **Non Secure** or **Secure** in Security Level at your network environment. Choose **English** or **another one** in Region and Language.
6. PCのネットワーク環境によりChoose Security Levelから**Non Secure**, または**Secure**を選んでください。Choose Region and Languageから日本語をクリックします。

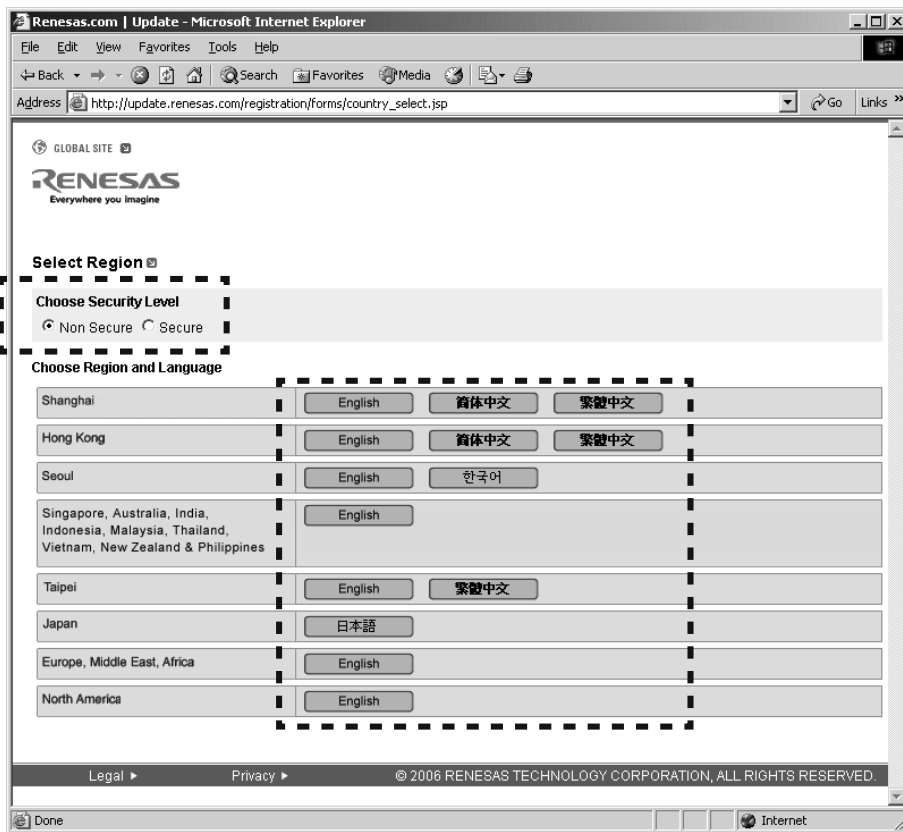

7. Input the each item.
- NOTE :** The items displayed by a language and region are different.
7. 各項目を記入します。
注意：下記説明は英語ですが、日本語を選んだ場合日本語で表示されます。

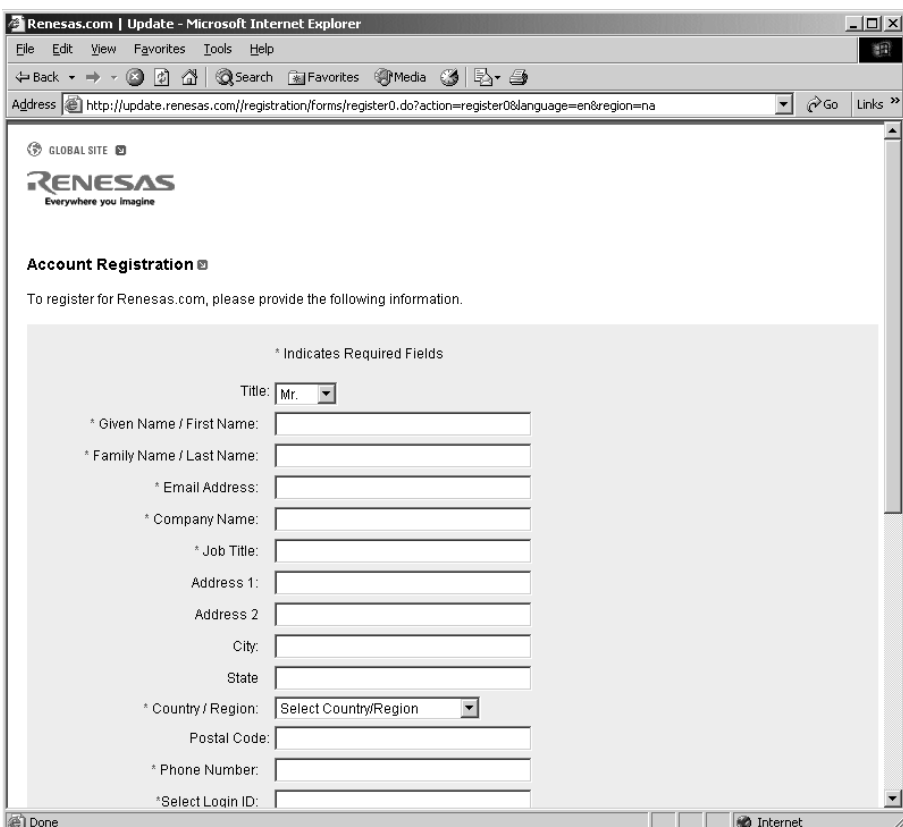

8. If you have inputted the necessary items, check the **I Agree**, and click the **Submit**.

8. 必須項目を入力したならば、**同意します**にチェックを入れ、**送信**をクリックします。

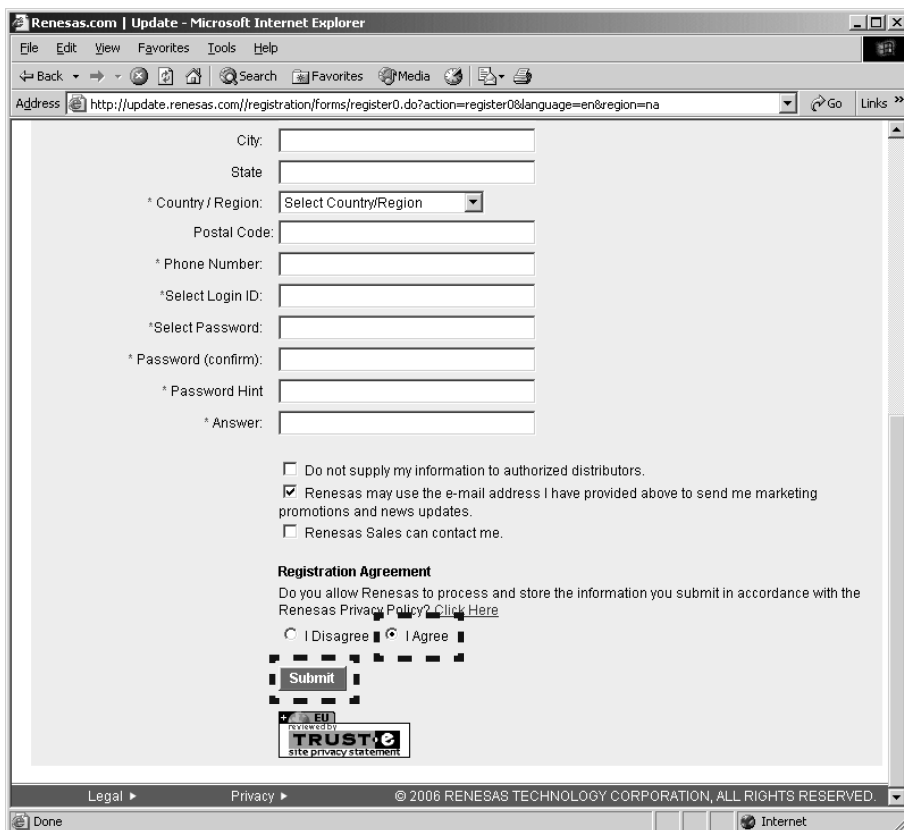

9. The input is needless in this page. Scroll down the page.

9. このページは入力しなくても結構です。ページをスクロールダウンします。

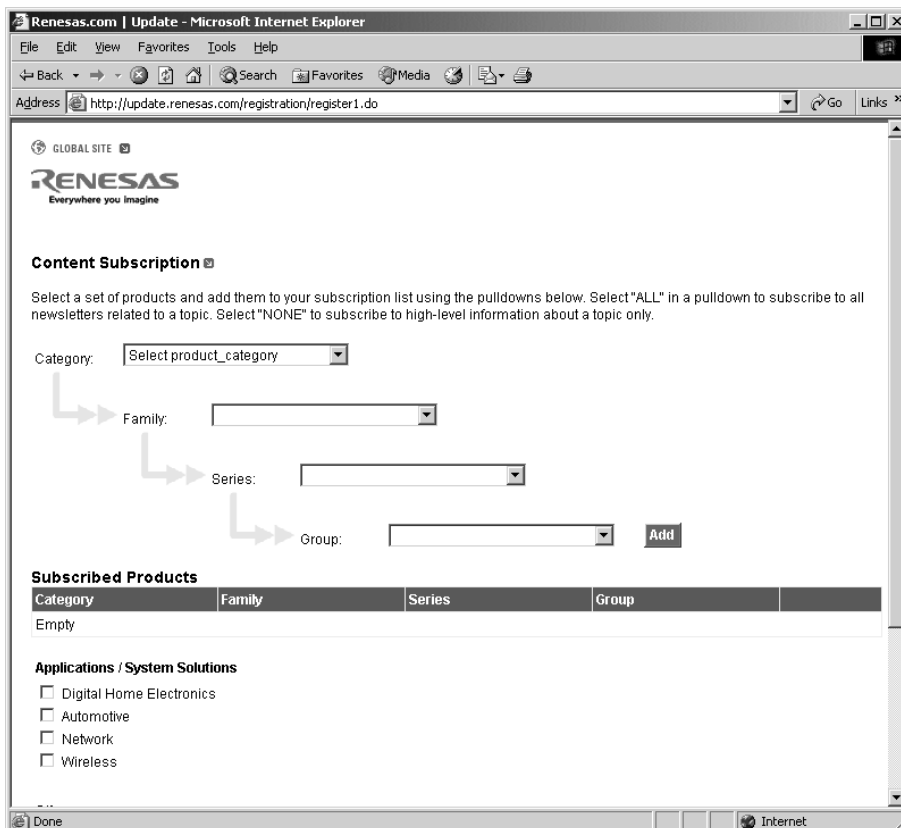

10. Click the **Submit**.

10. 送信をクリックします。

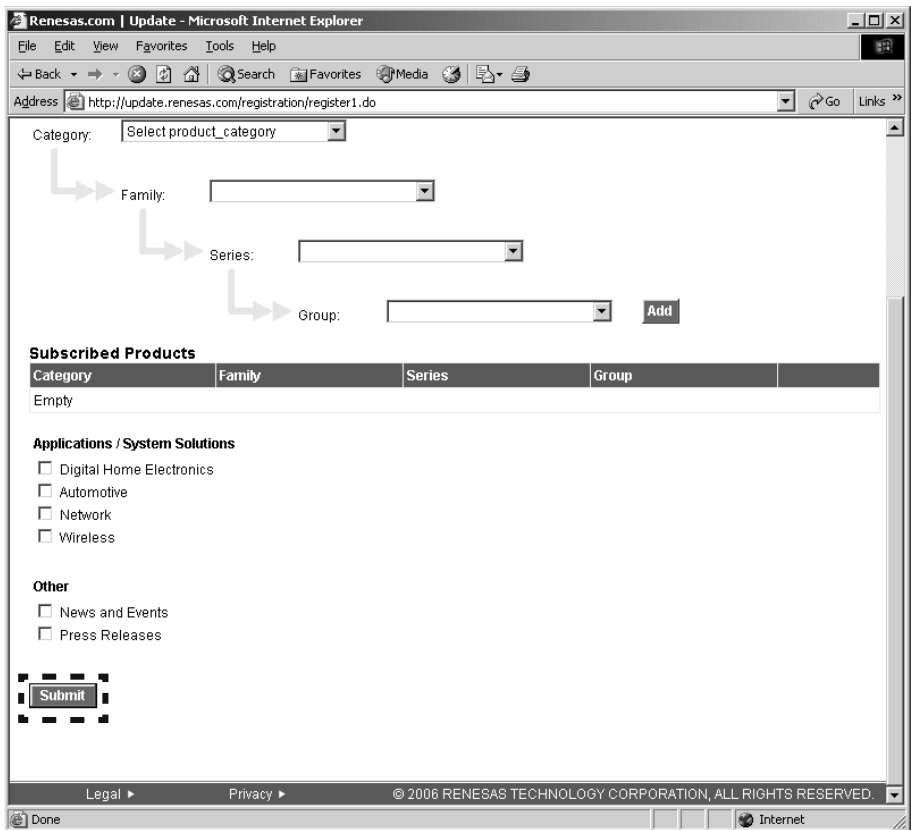

11. Immediately, an E-mail arrives from the RENESAS.
Click the link in the E-mail to go to the registration site,
and input the Login ID and Password.
And Click the **Submit**.

11. 直ちに、RENESASからE-mailが届きます。
E-mail内に有る登録サイトへのリンクをクリックします。
Login IDとPasswordを入力し**Submit**をクリックします。

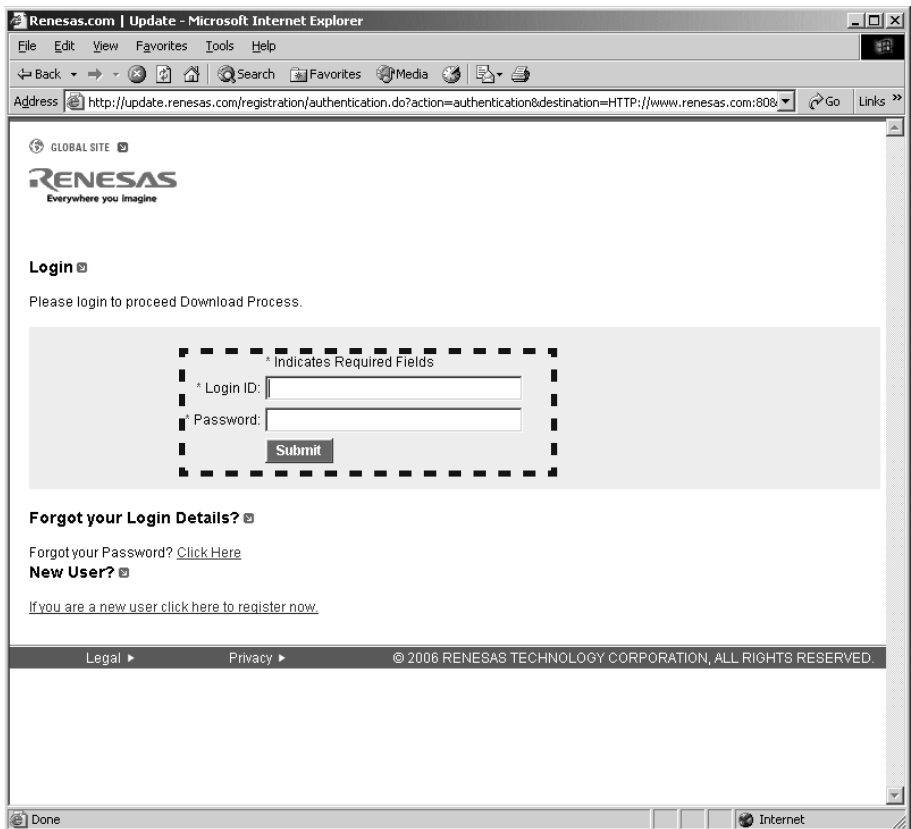

12. Registration is finished.
13. Open the RENESAS top page from registration page.
14. Click the **GLOBAL SITE**.

12. 登録が完了します。
13. 登録ページに有るリンクからRENEASASのトップページに移動します。
14. **GLOBAL SITE**をクリックします。

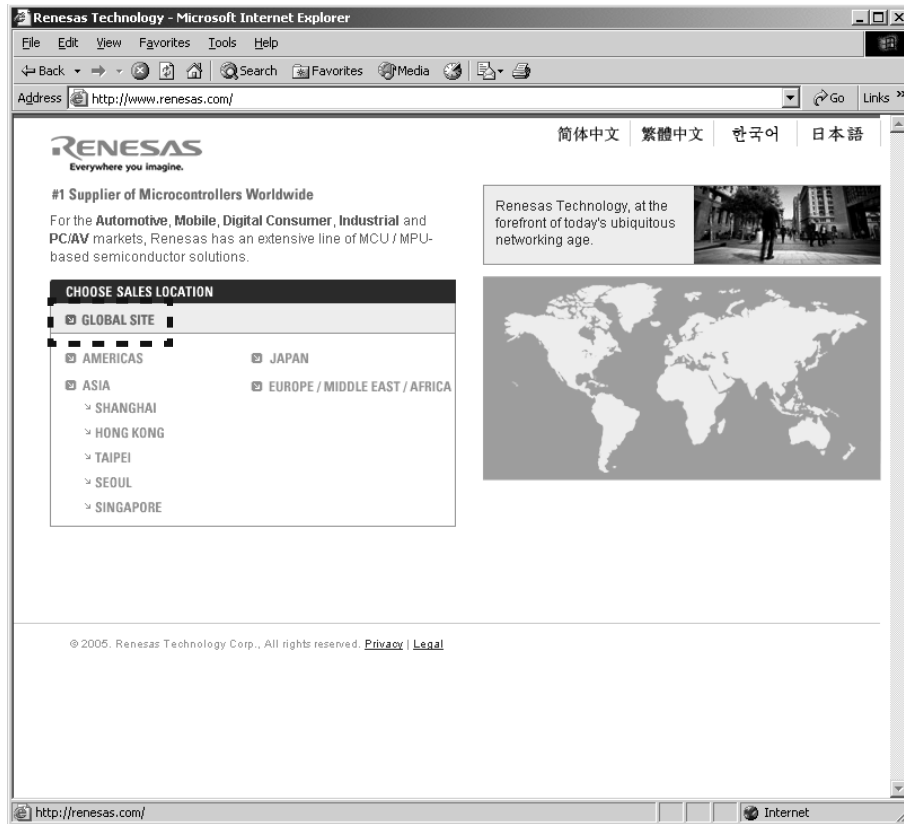

15. Click the **Downloads** in the DESIGN SUPPORT.

15. DESIGN SUPPORT内の**Downloads**をクリックします。



16. Scroll down the page, and type the "Flash Development toolkit" into the Keyword.
And click the **Start Search**.

16. ページをスクロールダウンし、Keywordに"Flash Development toolkit"を入力します。
Start Searchをクリックします。

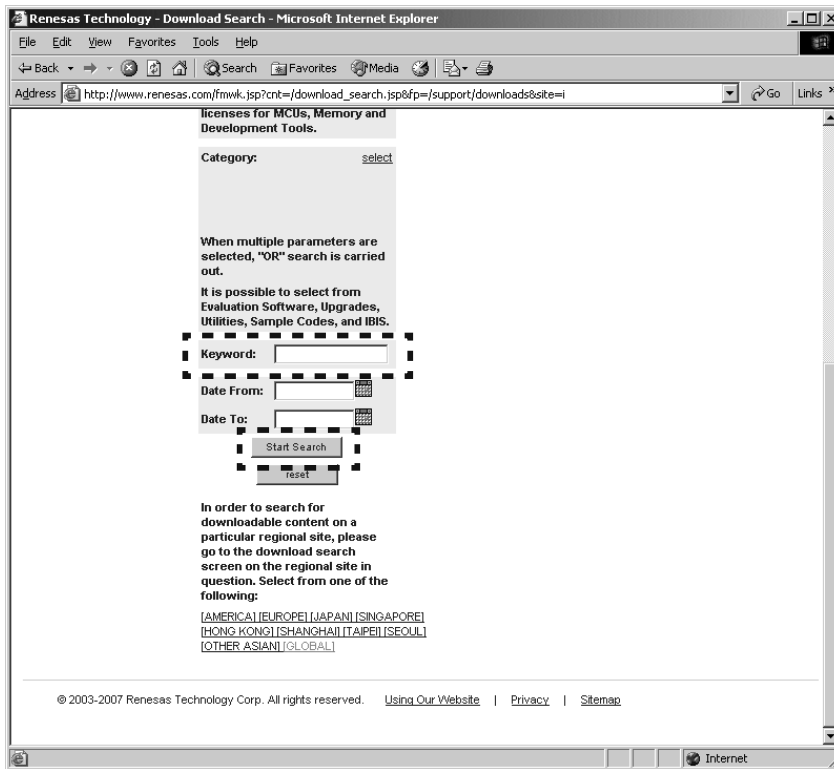

17. Click the **latest Flash Development Toolkit** in the table.
But DO NOT click the upgrade version because installation fails.
NOTE : The latest edition is FDT V3.07 Release 01 at present. (February, 2007) It is in FDT V3.07 Release 01 as follows and explains it.

17. 検索結果の中から**最新のFlash Development Toolkit**をクリックします。**アップグレード版はインストールに失敗するのでクリックしないでください。**
注意 : 現時点(2007年2月)での最新バージョンはV3.07 Release 01になります。以下FDT V3.07 Release 01で説明します。

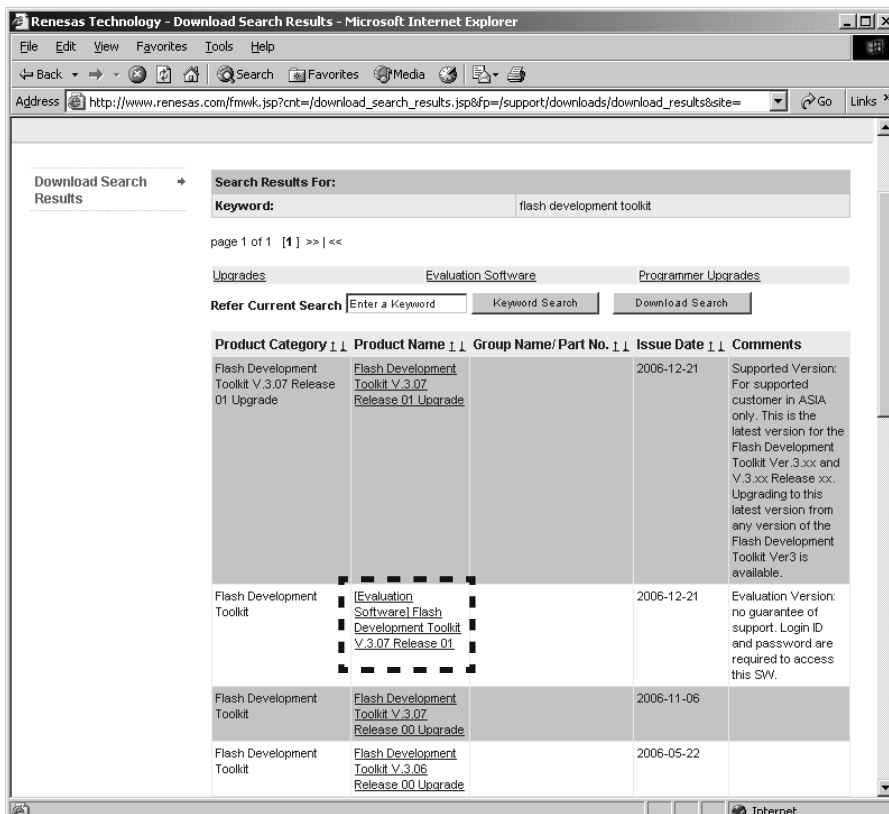

18. Input the Login ID and Password.
And click the **Submit**.

18. ダウンロードするためにLogin IDとPasswordを入力し
ます。
Submitをクリックします。

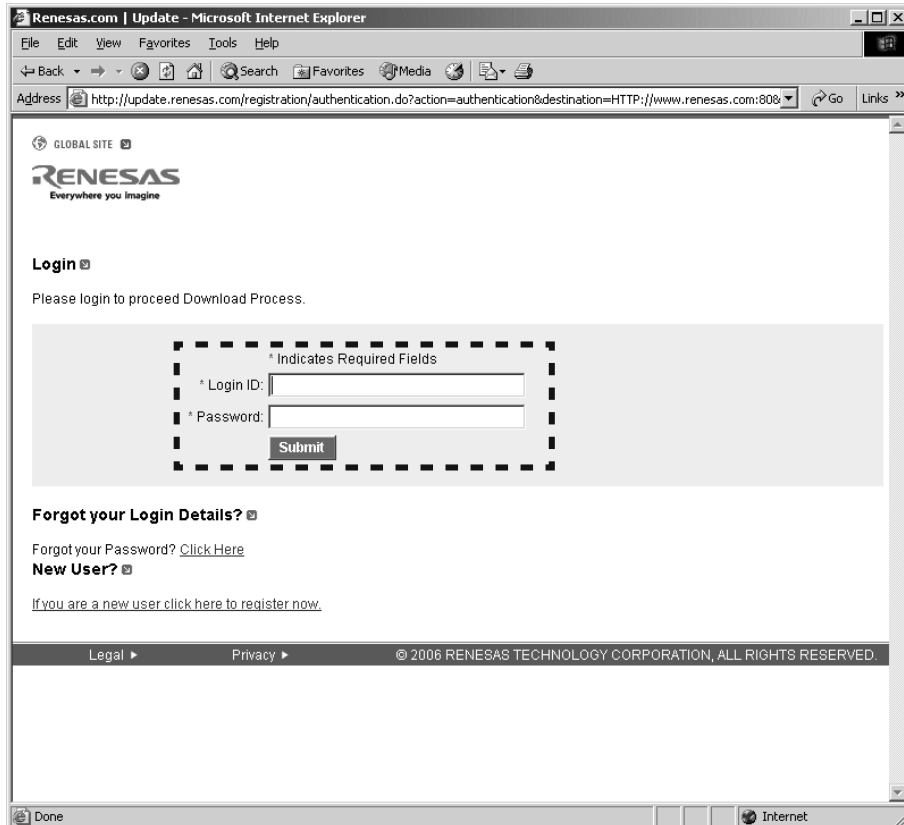

19. Scroll down the page.

19. ページをスクロールダウンします。

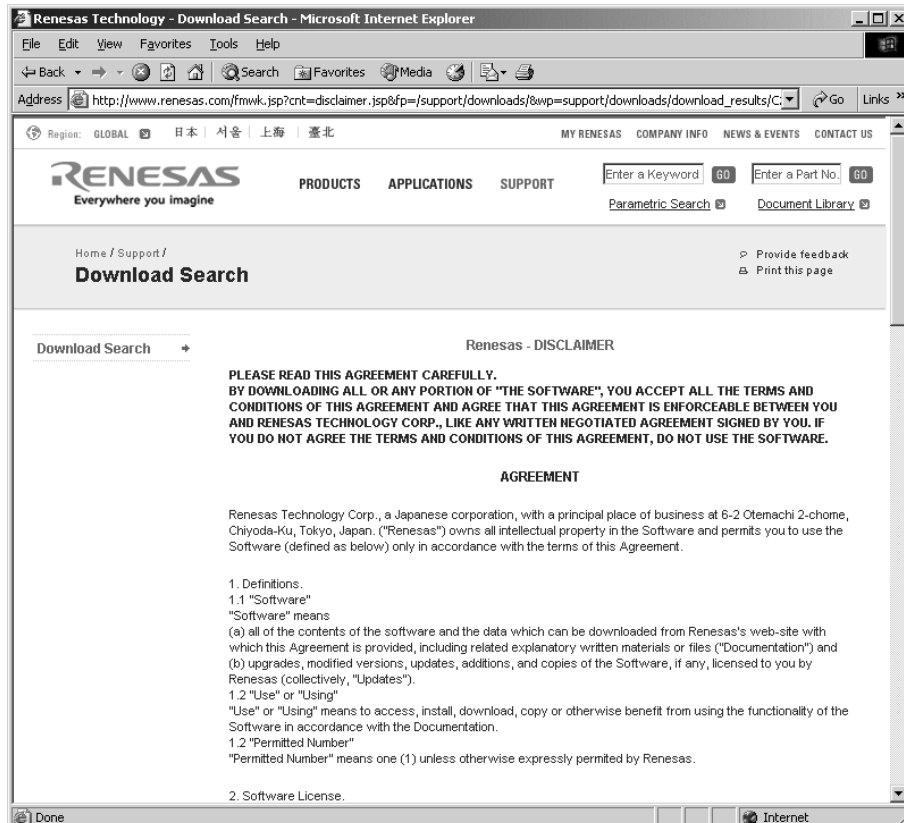

20. Check the **Agree**, and click the **Submit**.

20. **Agree**にチェックを入れ、**Submit**をクリックします。

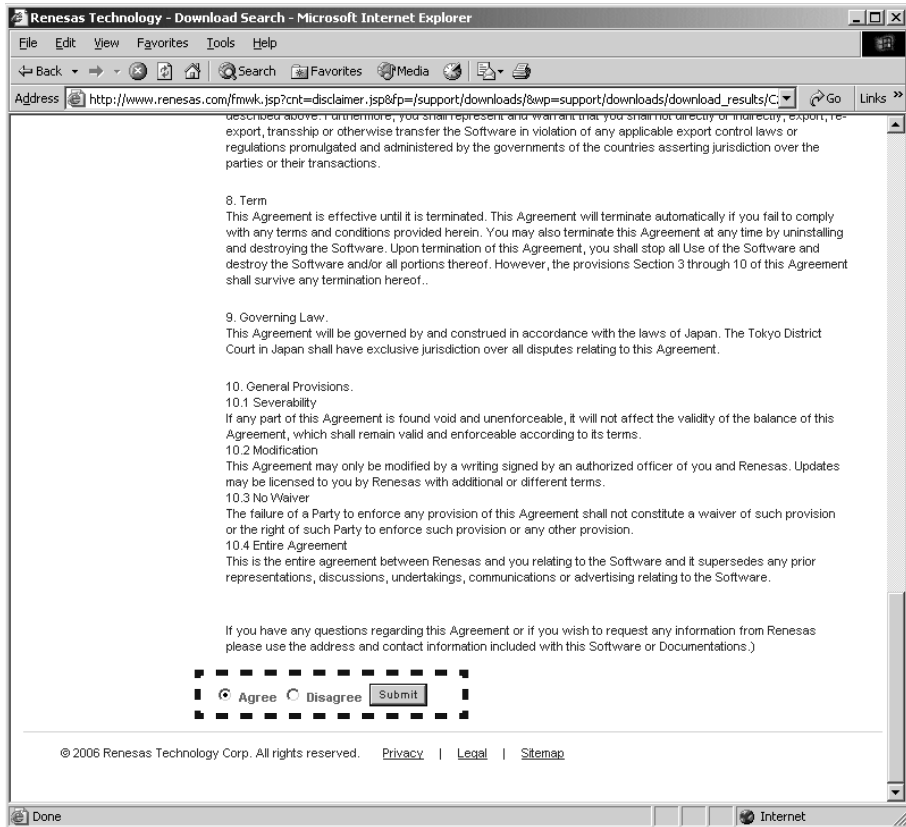

21. Scroll down the page.

21. ページをスクロールダウンします。

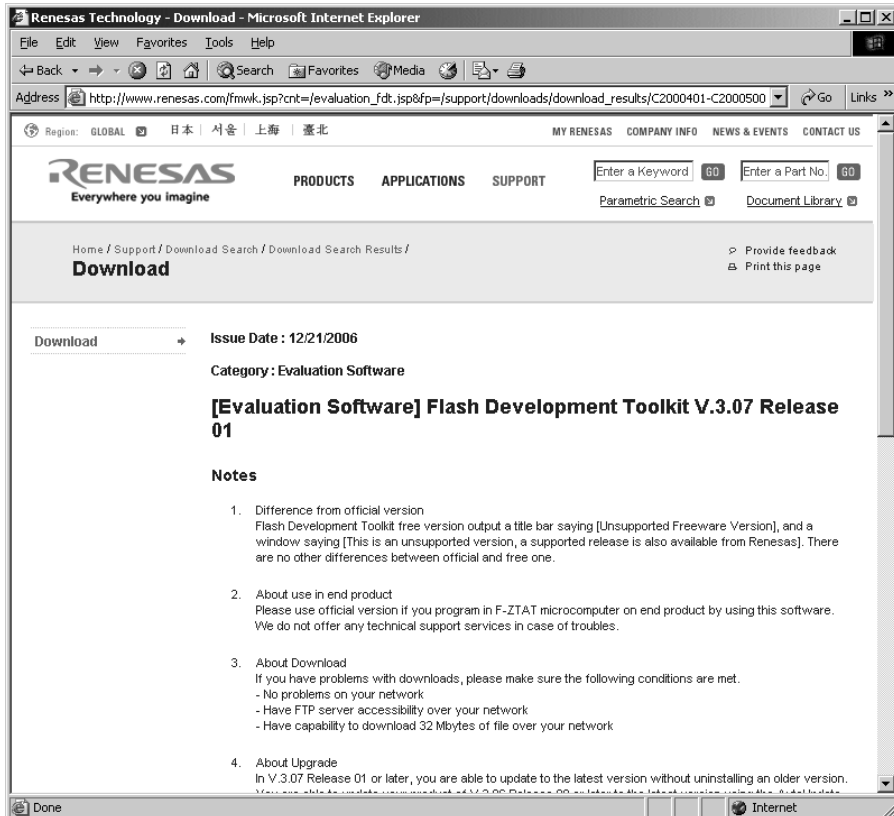

22. Click the **Download**.

22. **Download**をクリックします。

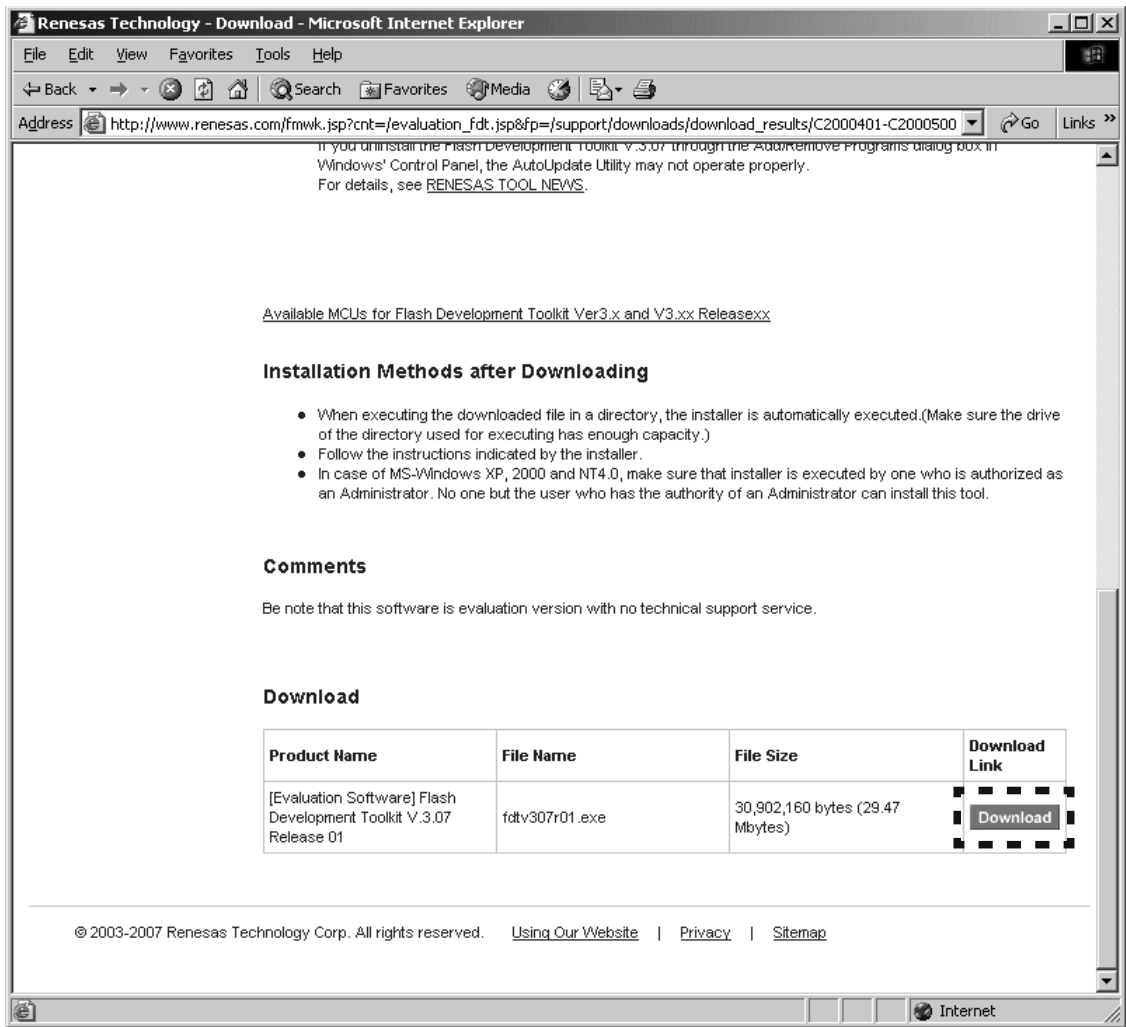

23. Click the **Save**.

23. **Save**をクリックします。

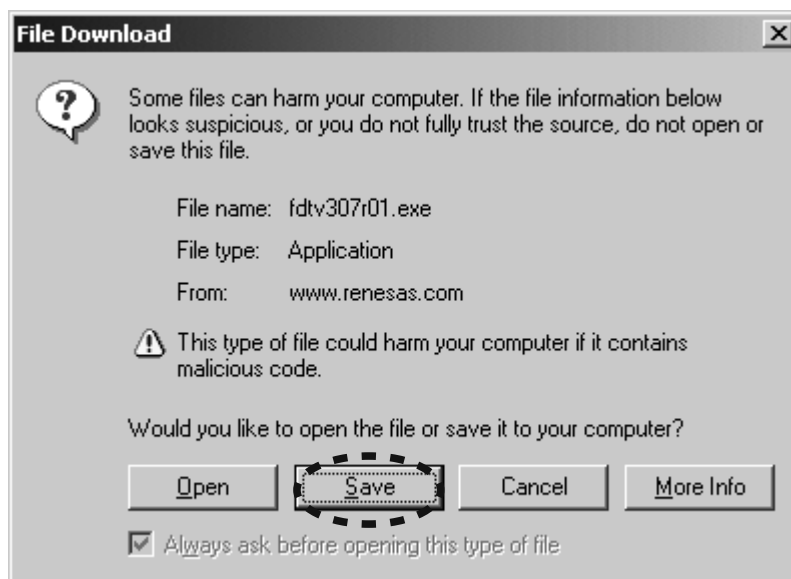

24. Save the fdtv307r01.exe on your PC's hard disc.

NOTE : A file name is change by improvement.

24. fdtv307r01.exeを任意のフォルダに保存します。

注意 : ファイル名はバージョンにより変わります。

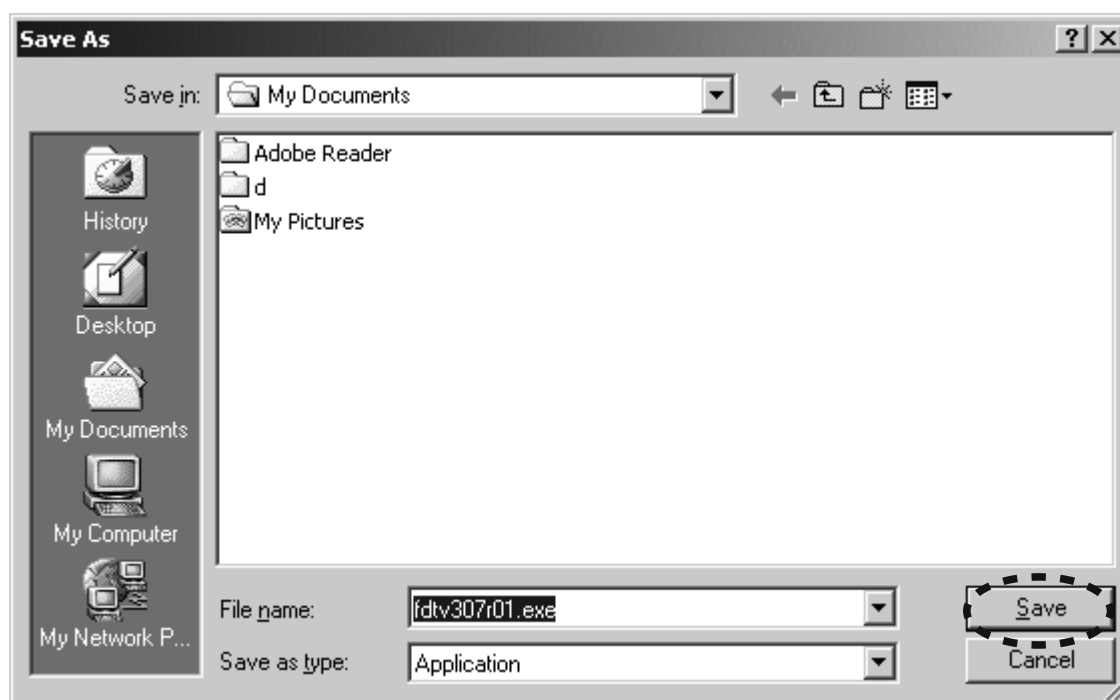

**[A-2] INSTALLS OF THE SOFTWARE
(Flash Development Toolkit Ver.3.07)**

1. Open the folder with the downloaded file.
2. And double click the **fdtv307r01.exe**.

**[A-2] INSTALLS OF THE SOFTWARE
(Flash Development Toolkit Ver.3.07)**

1. ダウンロードしたファイルのあるフォルダを開きます。
2. **fdtv307r01.exe**をダブルクリックします。

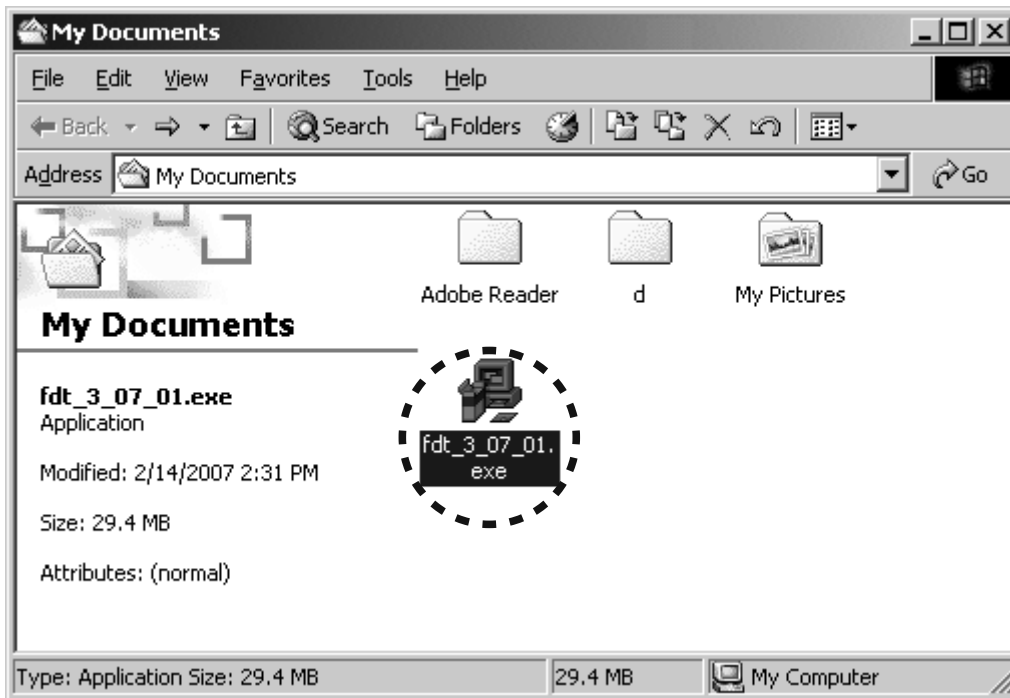

3. Click the **Next**.

3. **Next**をクリックします。

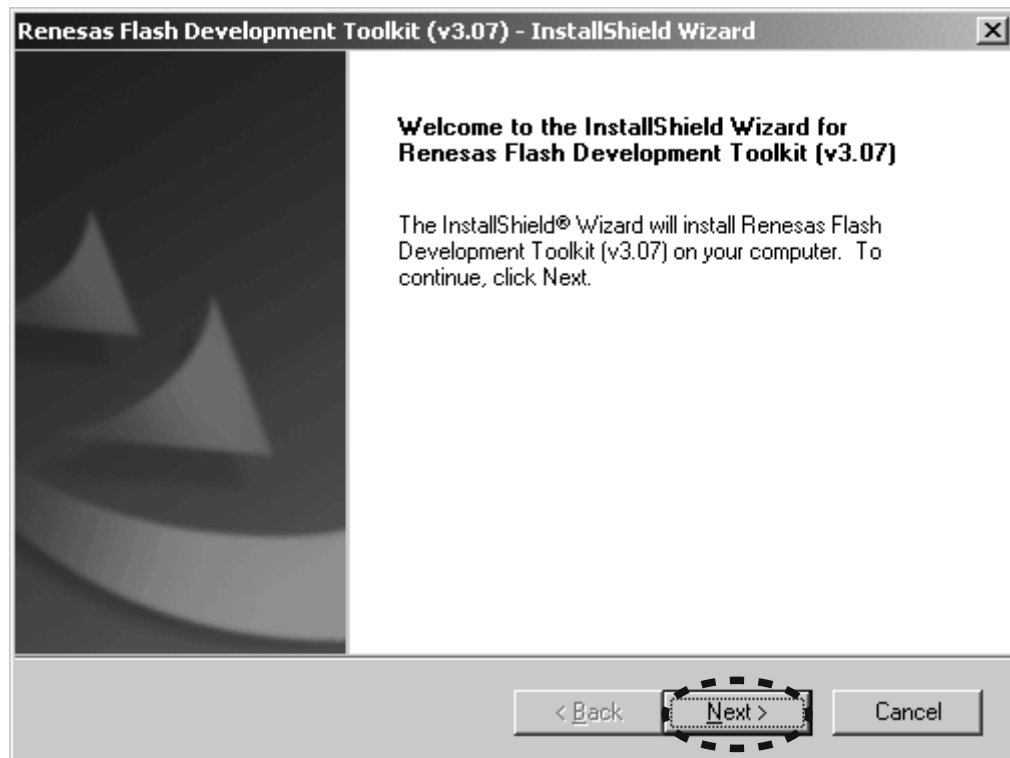

4. Check the **International [English]**, and click the **Next**. 4. **International [English]**にチェックを入れ**Next**をクリックします。

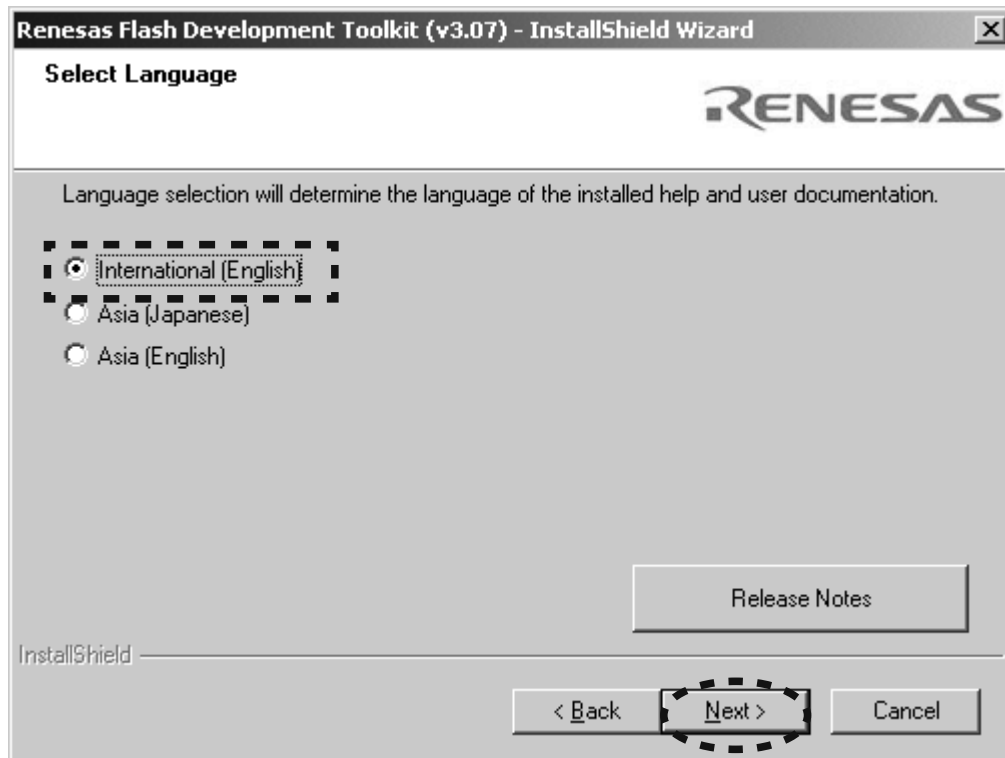

5. Check the **I accept the terms of the license agreement**, and Click the **Next**. 5. **I accept the terms of the license agreement**にチェックを入れ、**Next**をクリックします。

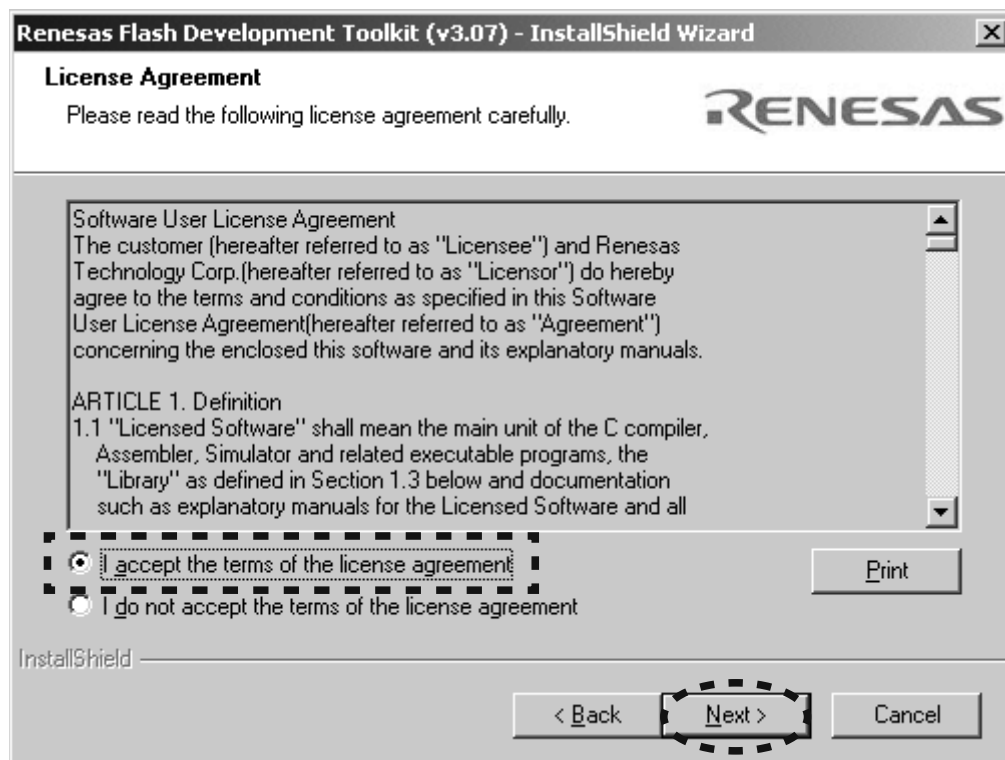

6 Click the **Next**.

6. **Next**をクリックします。

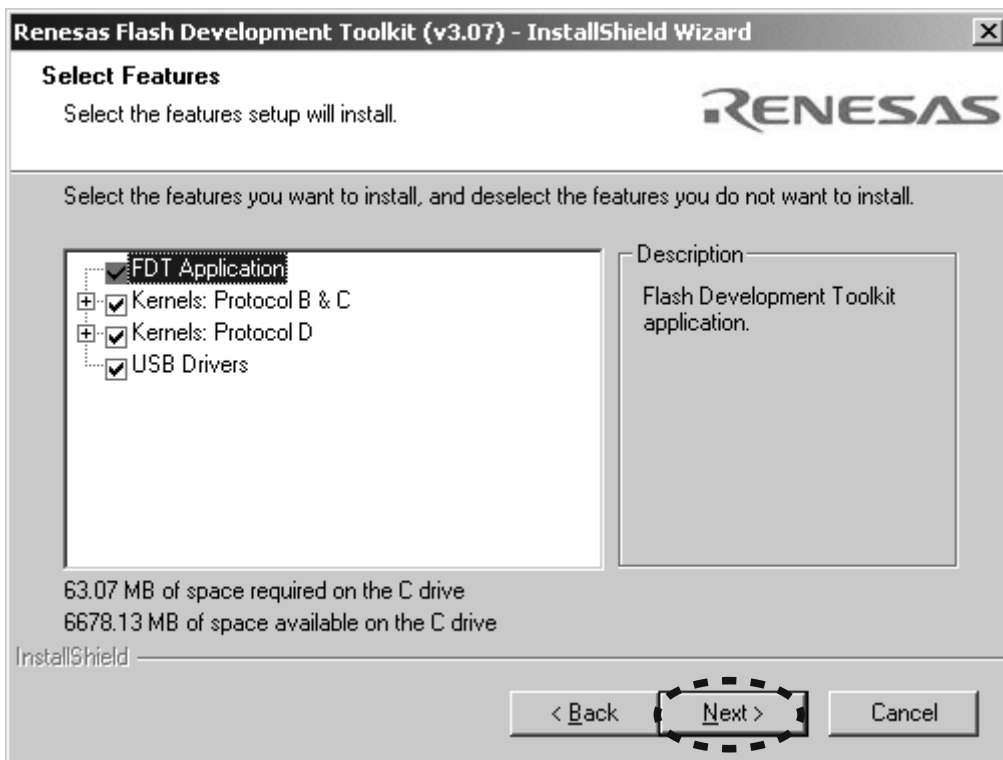

7. Check the all file type, and Click the **Next**.

7. 全てのファイルタイプにチェックを入れ、**Next**をクリックします。

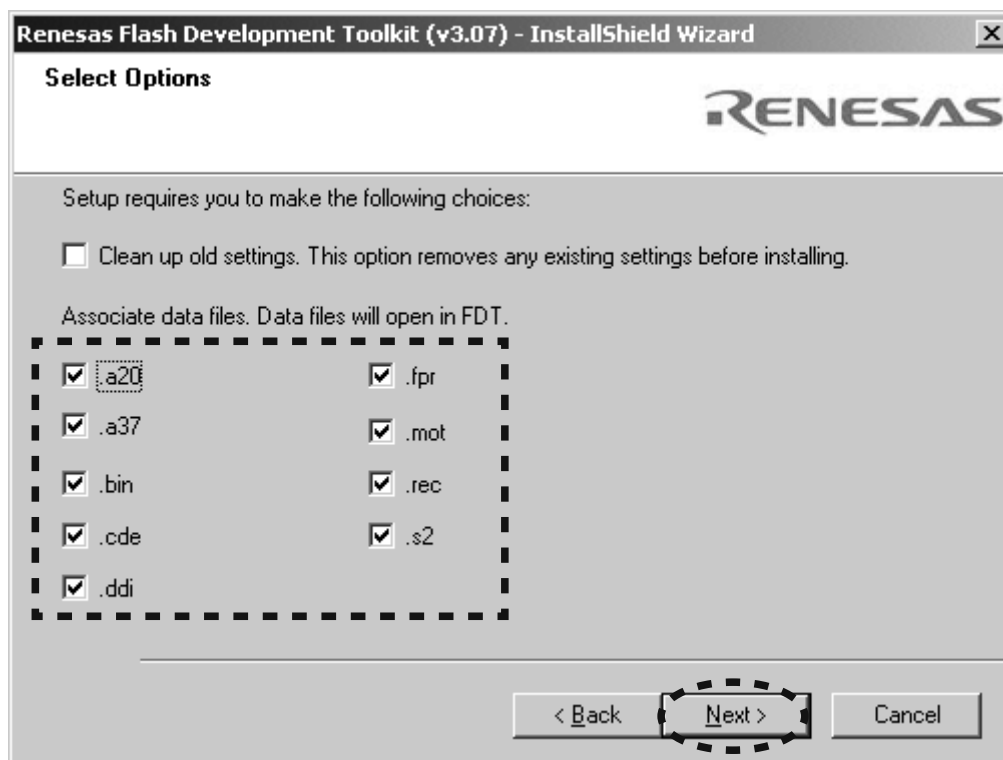

8. Click the **Next**.

8. **Next**をクリックします。

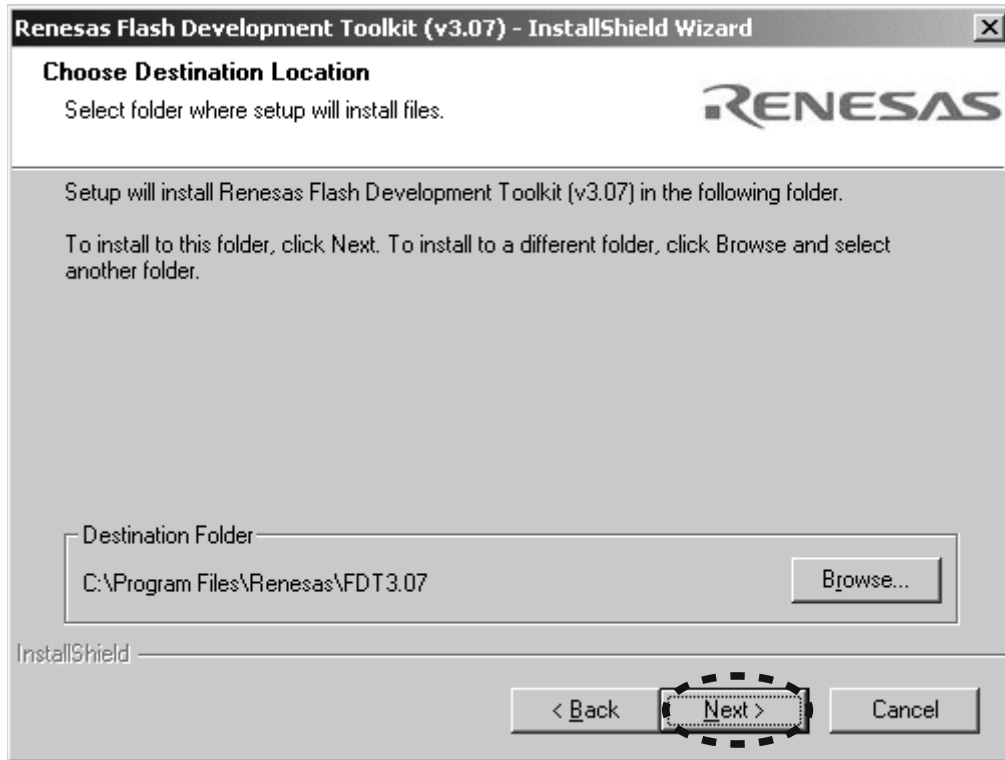

9. Click the **Install**.

9. **Install**をクリックします。

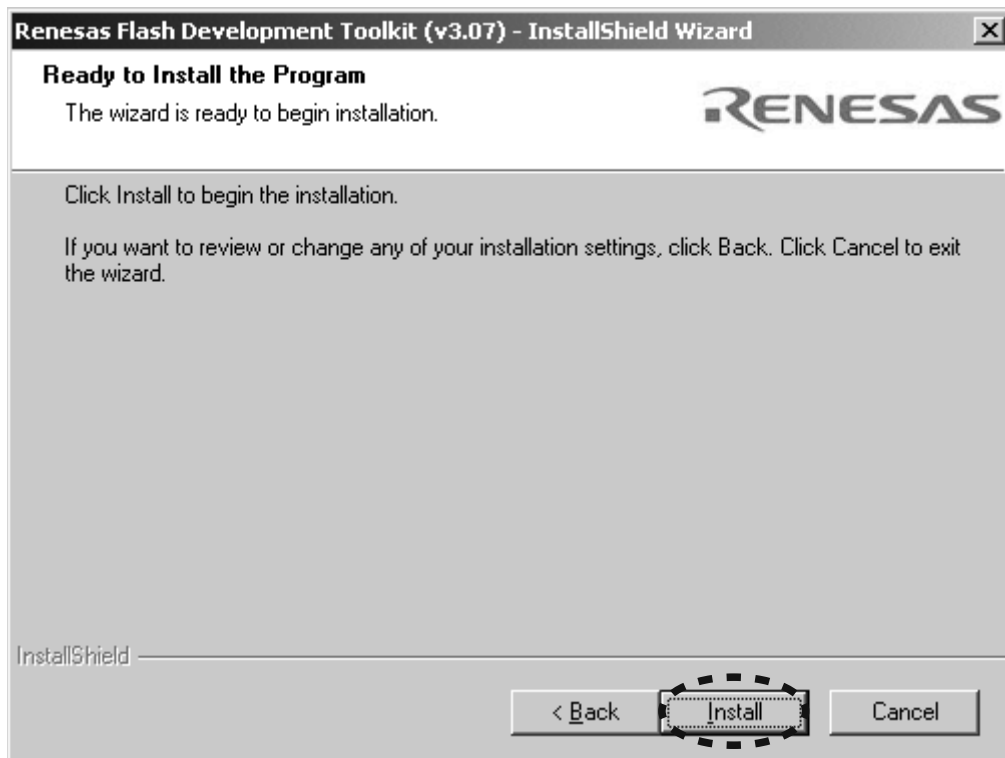

10. The Setup Status bar appears.

10. インストールの状態が表示されます。

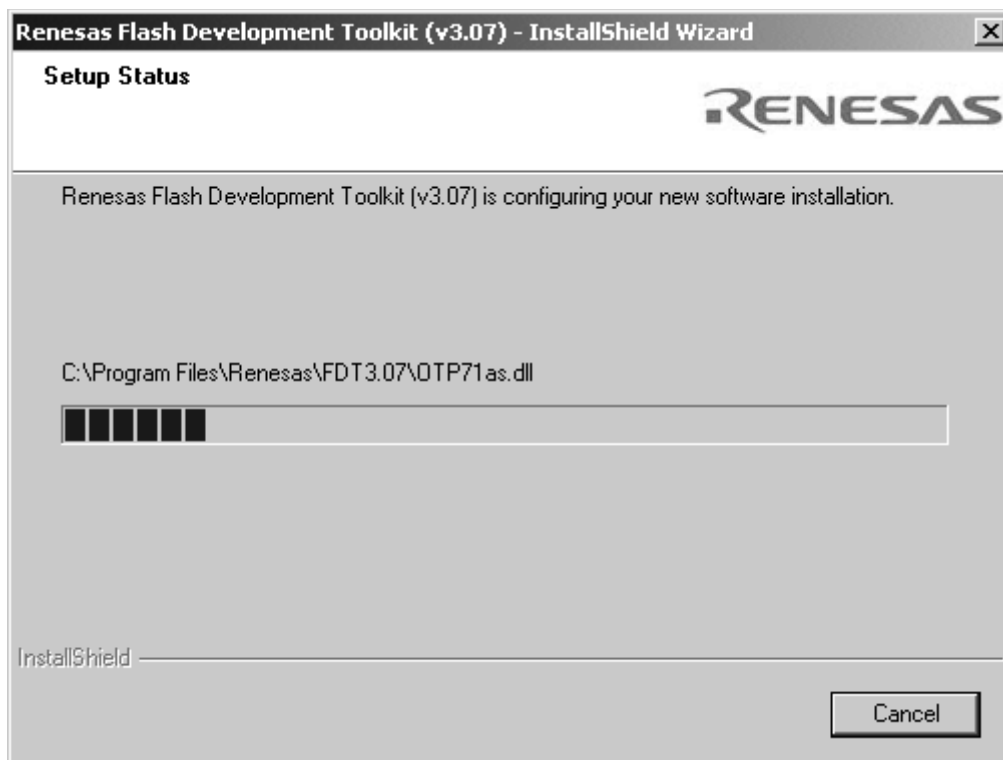

11. Un-Check the Launch AutoUpdate, and click the **Finish**.

11. Launch AutoUpdateのチェックを外し、**Finish**をクリックします。



[B] WRITING AND UPDATE SOFTWARE

Microprocessor needs writing software, when a microprocessor (QU01) is replaced.

Software for microprocessor (QU01) can be updated/downloaded.

Have update/download application software. ("fdtv307r01.exe (FDT3.07 Release 01) or latest version")

Update/Download microprocessor's software to internal Flash-ROM.

- This mode is to update/download the software for microprocessor.
- The target device is internal flash ROM of microprocessor (QU01) on FRONT PWB (P307).
- The updating/downloading of software takes about 30 seconds.

NECESSARY EQUIPMENT

The following items are required for updating/downloading.

- Windows PC (OS: Windows2000 or WindowsXP) with Serial port.
- RS-232C Dsub-9 pin cable (female to female/straight type).
- Writing data. P/N : 00M23AJ499A00 (SM11S1_vyymmdd.mot)
NOTE : A00 is a revision number. The latest revision is A00 at present. (October, 2007)
The yy is two digits of year. The mm is month.
The dd is date.
- Flash Development Toolkit 3.07 or latest version. (fdtv307r01.exe or latest version)
- Connection JIG (90M-PM11S1JIG).

[B] WRITING AND UPDATE SOFTWARE

メインマイコンQU01を交換したときは、QU01へプログラムを書き込む必要があります。

メインマイコンのソフトウェアは更新、および書き込みが出来ます。

更新および書き込みには書き込み用アプリケーションが必要です。("fdtv307r01.exe (FDT3.07 Release 01)または最新版")

Update/Download microprocessor's software to internal Flash-ROM.

- このモードはMAINマイコンの更新および書き込み用です。
- FRONT PWB基板(P307)のQU01のマイコン内部のフラッシュROMに書き込みます。
- 書き込みにかかる時間は約30秒です。

必要機器

下記は更新および書き込みに必要な機器です。

- Windows PC (OS : Windows2000 またはWindowsXP) で Serial ポートのあるもの。
- RS-232C ストレートケーブル(9Pin メス-9Pin メス)
- 書き込み用データ。 P/N : 00M23AJ499A00 (SM11S1_vyymmdd.mot)
注意 : A00はリリース番号。最新リリース番号はA00です。(2007年10月現在)
yyは年の下二桁、mmは月、ddは日
- Flash Development Toolkit 3.07または最新版。(fdtv307r01.exeまたは最新版)
- 接続治具(90M-PM11S1JIG)。

[B-1] Update/Download microprocessor's software to internal Flash-ROM.

[B-1-1] The writing software setup procedure

1. Launch the Flash Development Toolkit v3.07 (FDT).
NOTE : Please refer to "[A] SOFTWARE (fdtv307r01.exe) DOWNLOAD AND INSTALL PROCEDURE", when you do not have FDT.
2. Click **Start, Programs, Renesas, Flash Development Toolkit 3.07** and **Flash Development Toolkit 3.07**.

[B-1] Update/Download microprocessor's software to internal Flash-ROM.

[B-1-1] The writing software setup procedure

1. Flash Development Toolkit v3.07 (FDT)を起動します。
注意 : FDTを持っていない方は"[A] SOFTWARE (fdtv307r01.exe) DOWNLOAD AND INSTALL PROCEDURE"を参照してダウンロードしてください。
2. **Start, Programs, Renesas, Flash Development Toolkit 3.07, Flash Development Toolkit 3.07**をクリックします。

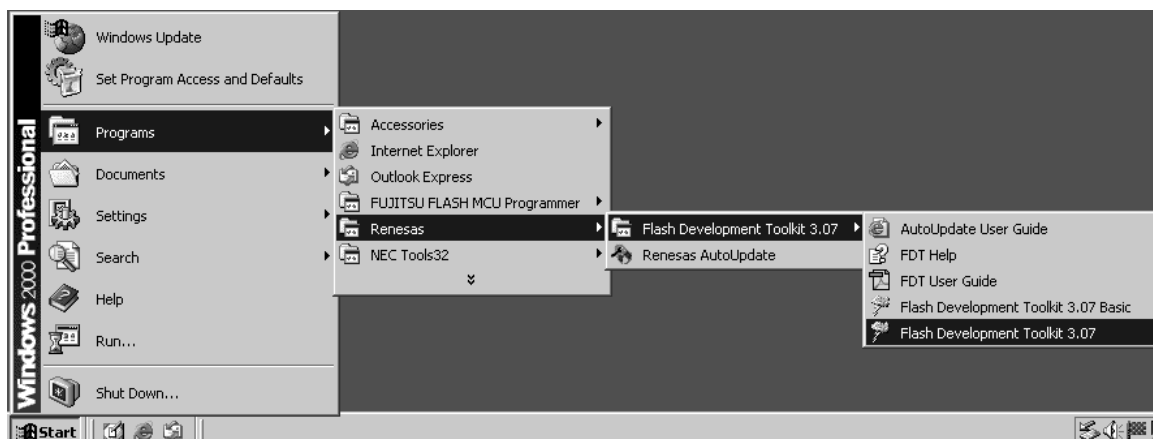

3. Check the **Create a new project workspace**, and click the **OK**.
NOTE : It needs setup for SM-11S1. When you have already setup, please advance to "[B-1-2] Writing Procedure for microprocessor".

3. **Create a new project workspace**をチェックし、**OK**をクリックします。
注意 : SM-11S1用の設定が必要です。既に設定が終わっている方は"[B-1-2] Writing Procedure for microprocessor"へ進んでください。

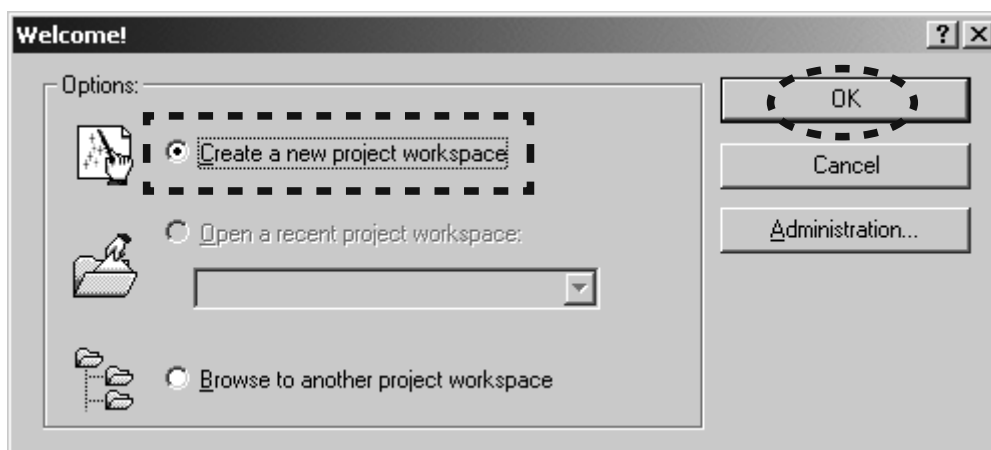

4. **SM-11S1** is inputted into the Workspace Name.
(It is simultaneously inputted into Project Name.)
Click the **OK**.

4. Workspace Nameに**SM-11S1**を入力します。
(同時にProject Nameにも入力されます)
OKをクリックします。

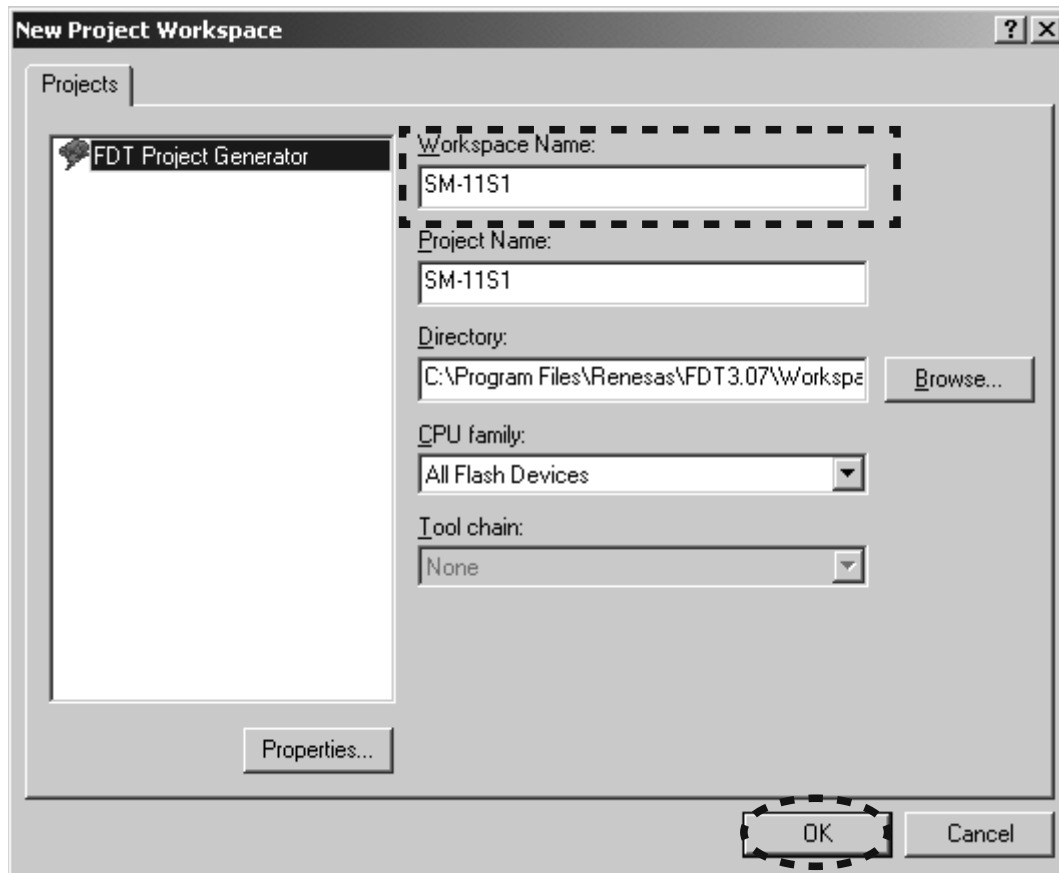

5. Choose the **H8/3687F** in Select Device. And click the **Next**.

5. Select Deviceから**H8/3687F**を選択し、**Next**をクリックします。

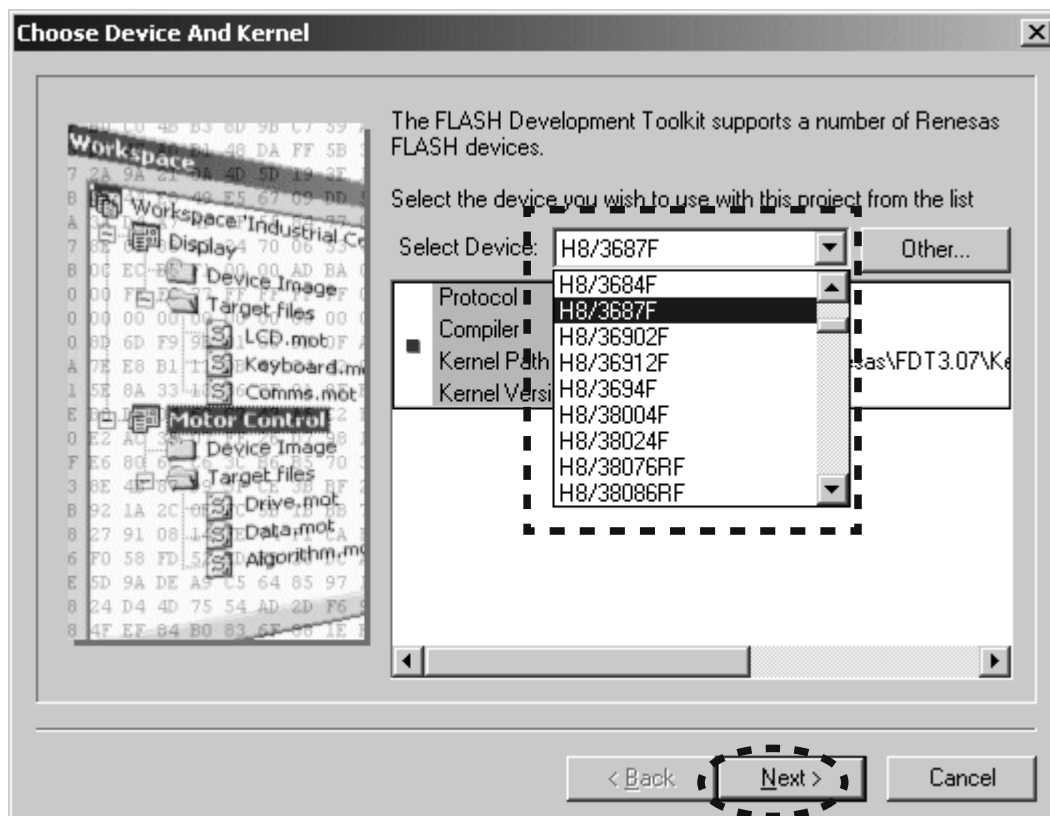

- 6. Choose the **Serial port number** in the Select Port. And click the **Next**.
- 6. Select Portから**Serial**ポート番号を選び、**Next**をクリックします。

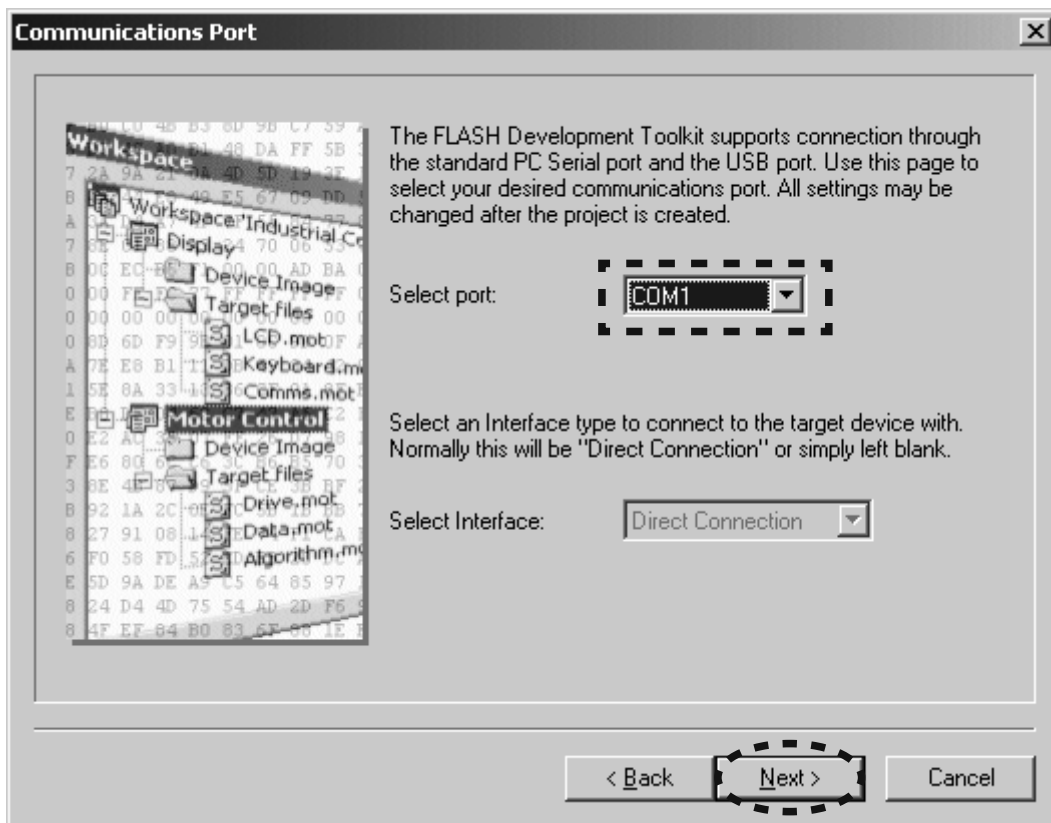

- 7. **8.0** is inputted into the Enter the CPU crystal frequency for the selected device. And click the **Next**.
- 7. Enter the CPU crystal frequency for the selected device に**8.0**を入力し、**Next**をクリックします。

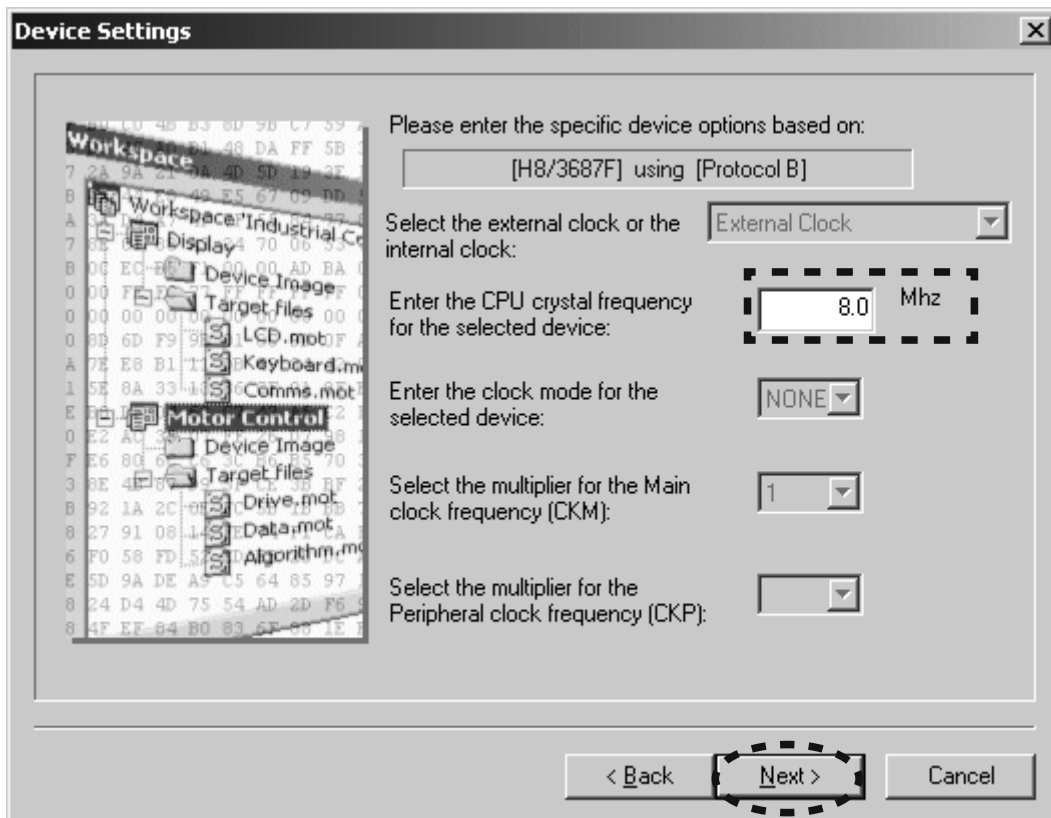

8. Check The **BOOT Mode** in Select Connection.
Un-check the **Use Default**, and choose the **19200** in Recommended Speeds.
Click the **Next**.

8. Select Connectionの**BOOT Mode**をチェックします。
Recommended Speedsの**Use Default**のチェックを外し、**19200**を選択します。
Nextをクリックします。

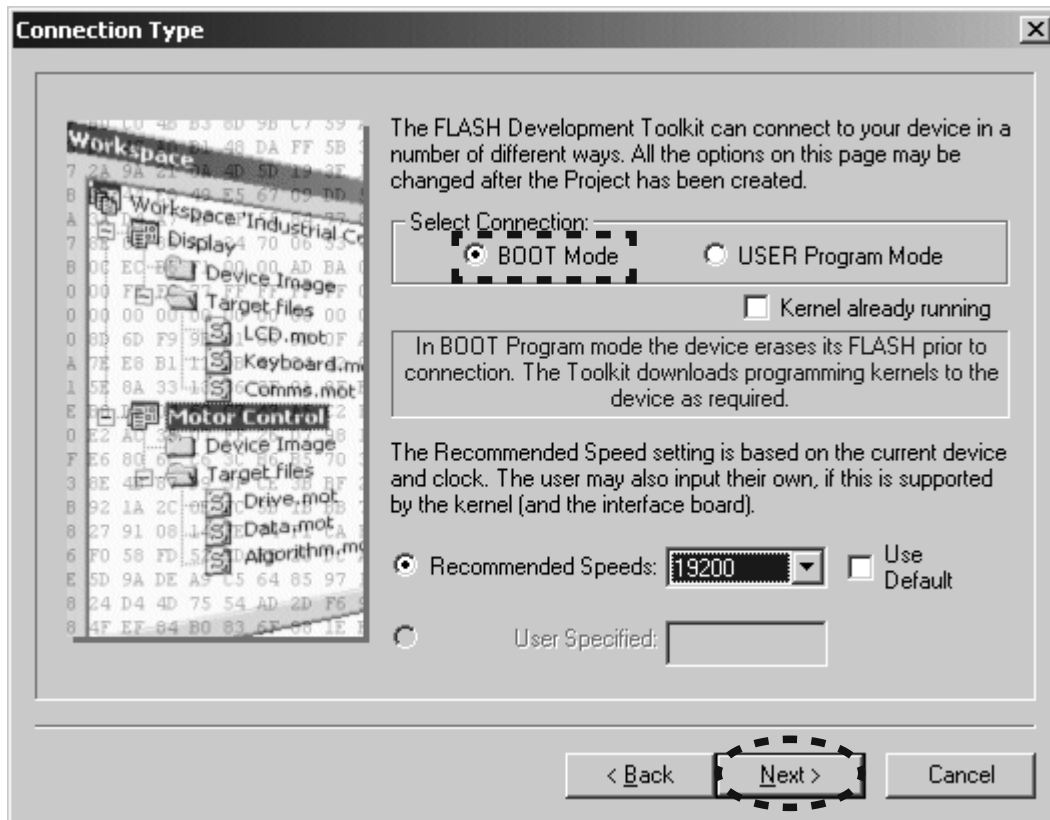

9. Check the **Automatic** in Protection.
Check the **Advanced** in Messaging.
Click the **Finish**.

9. Protectionの**Automatic**をチェックします。
Messagingの**Advanced**をチェックします。
Finishをクリックします。

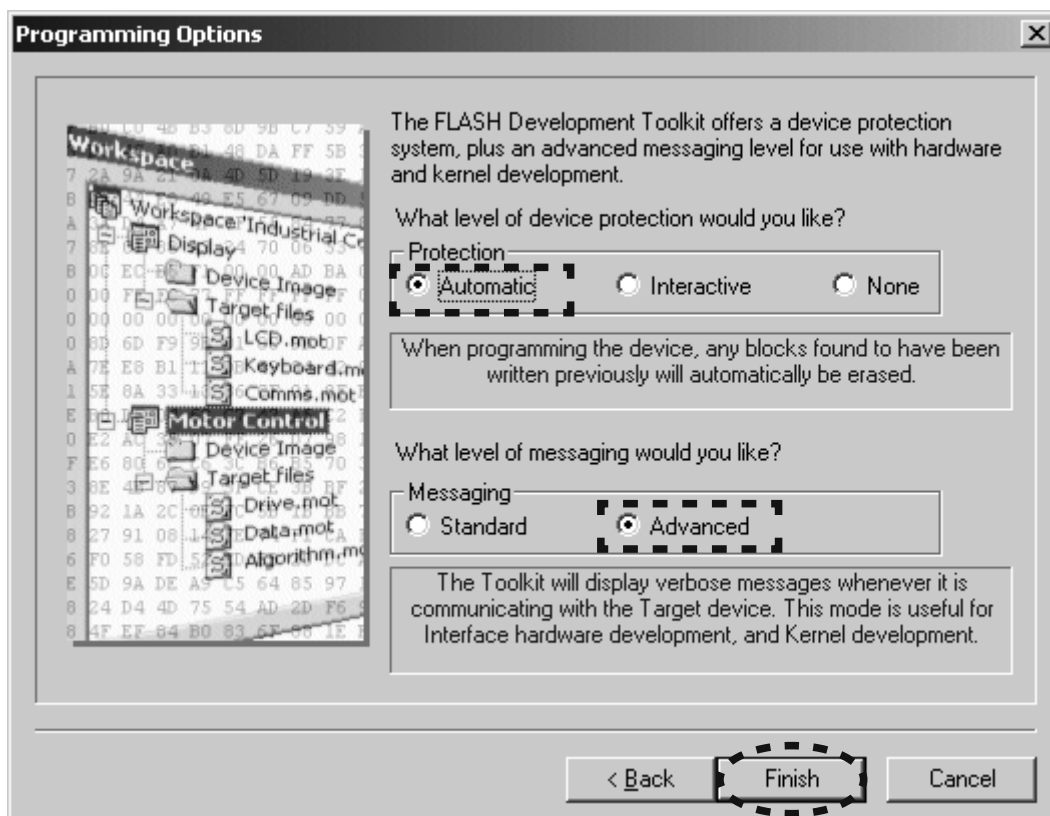

[B-1-2] Writing Procedure for microprocessor

1. Disconnect the mains cord from the unit.
2. Connect the RS-232C on the connection JIG and the Serial Port of windows PC with RS-232C cable.
3. Connect FFC (upside contact) to the rear panel of the unit from connection JIG.

[B-1-2] Writing Procedure for microprocessor

1. 本機の電源ケーブルを抜きます。
2. 接続治具のRS-232CコネクタとWindows PCのSerialポートをRS-232Cケーブルで接続します。
3. 本機のリアパネルに接続治具のFFC をコンタクト面を上にして差し込みます。

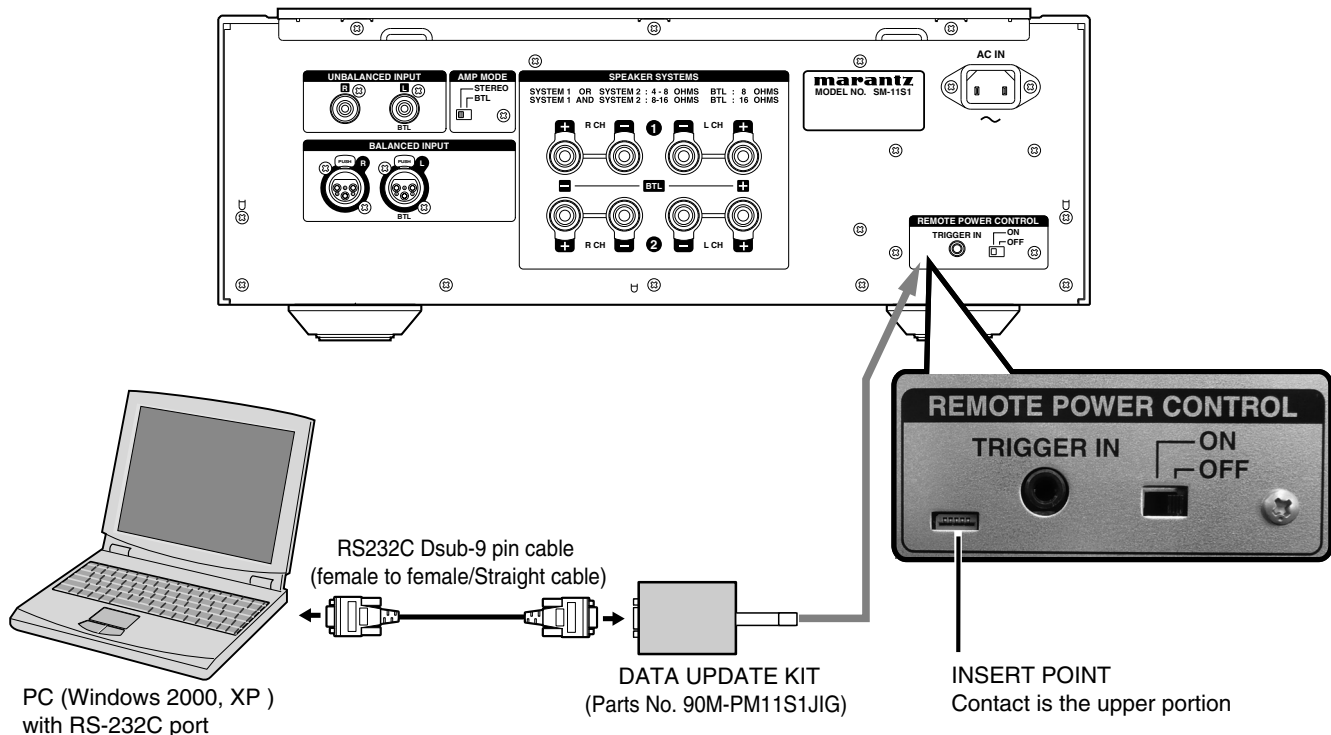

4. Connect the mains cord into the unit.
5. Launch the Flash Development Toolkit (FDT), When FDT is not launch. When FDT is already launch, please advance to step No.9.
6. Click **Start, Programs, Renesas, Flash Development Toolkit 3.07** and **Flash Development Toolkit 3.07**.

4. 本機に電源コードを接続します。
5. Flash Development Toolkit v3.07(FDT)を起動していない場合は起動します。既にFDTを起動している方はステップ9に進んでください。
6. **Start, Programs, Renesas, Flash Development Toolkit 3.07, Flash Development Toolkit 3.07**をクリックします。

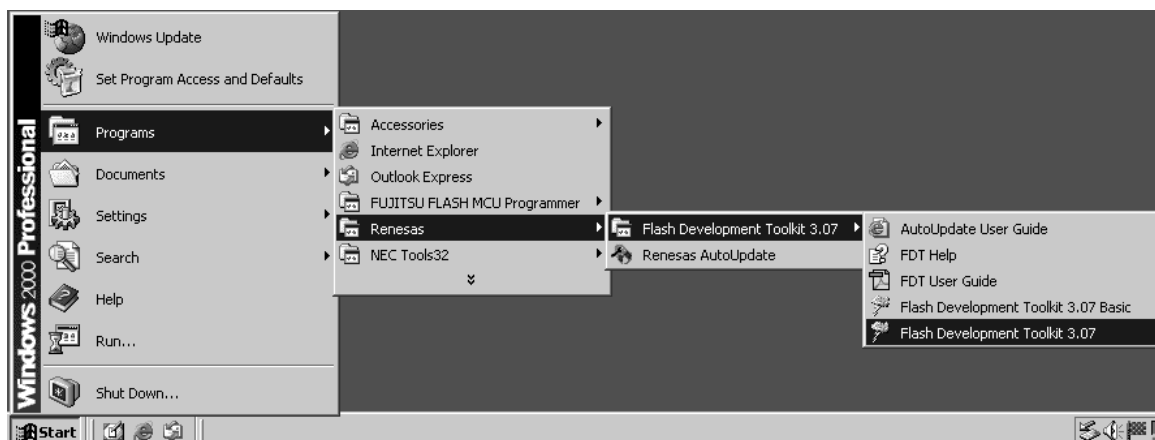

7. Check the **Browse to another project workspace**, and click **OK**.
7. **Browse to another project workspace**をチェックし、**OK**をクリックします。

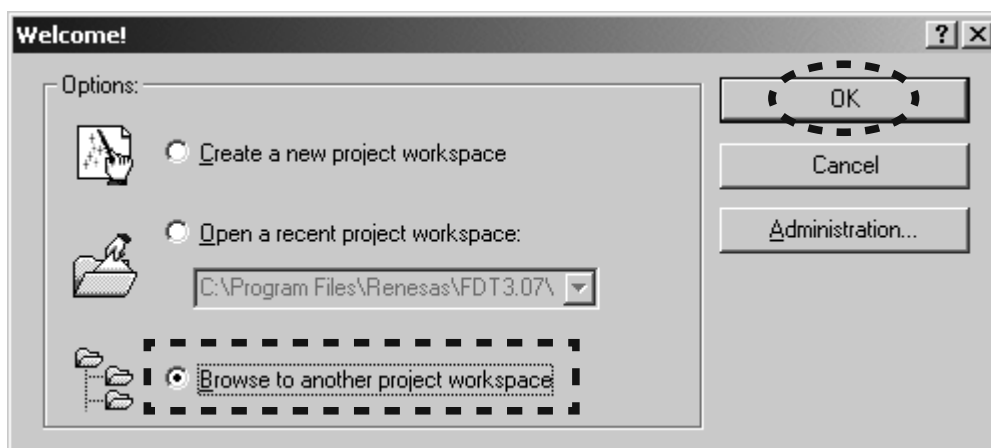

8. Choose **SM-11S1.AWS** in SM-11S1 folder under workspace folder. And Click the **Open**.
8. workspaceフォルダの下のSM-11S1フォルダ内の **SM-11S1.AWS**を選択し、**Open**をクリックします。

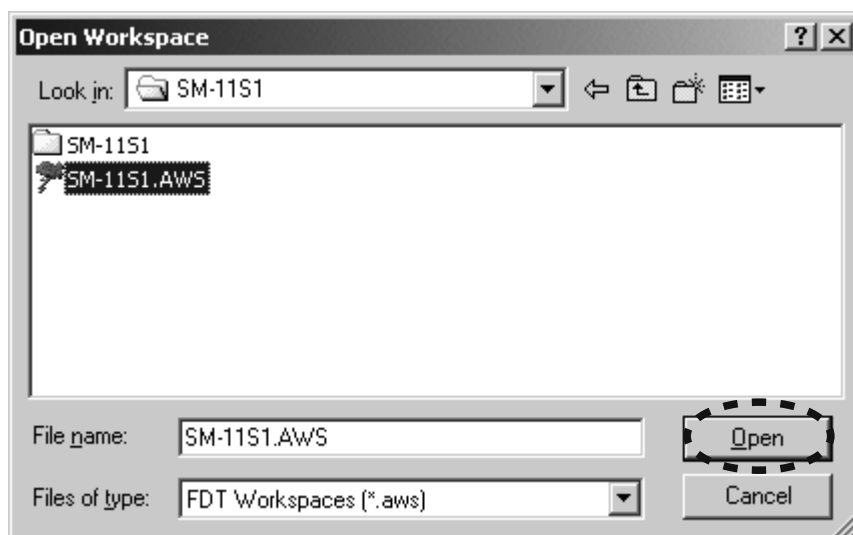

9. Right button of mouse click on the **SM-11S1**, and select the **Add Files...** in a menu.
9. **SM-11S1**を右クリックし、メニューから**Add Files...**をクリックします。

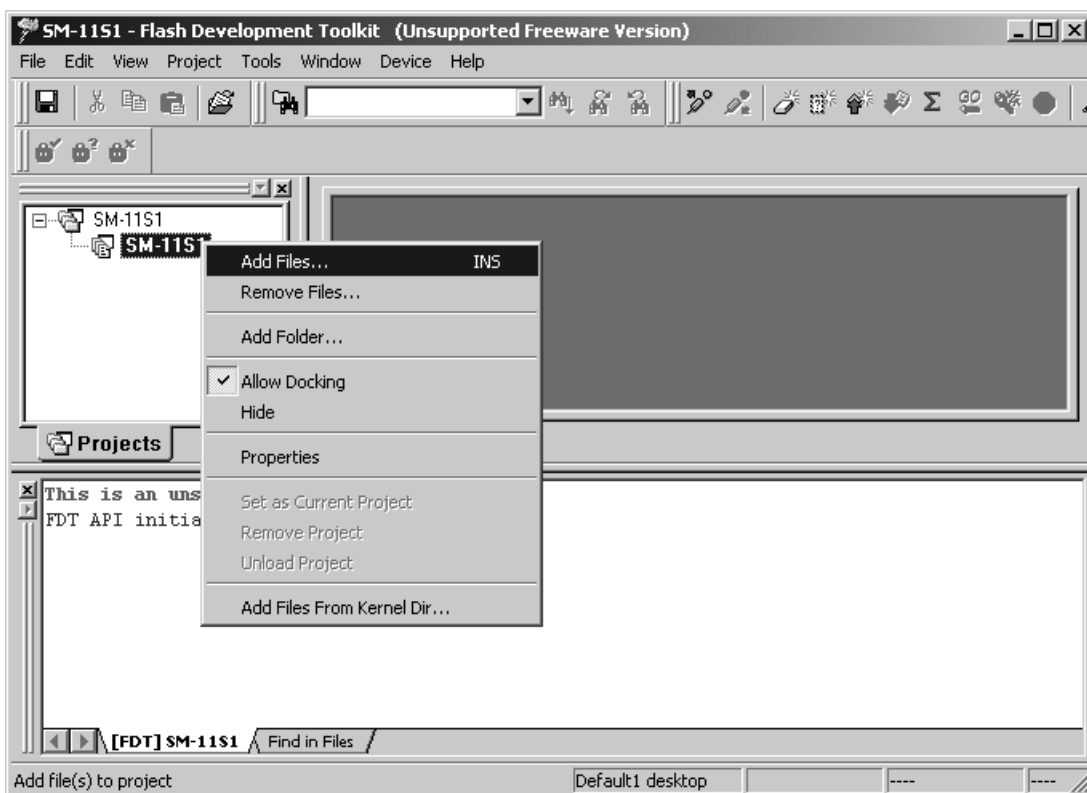

10. Choose the **SM11S1_vyymmdd.mot**, and click the **Add**.
10. **SM11S1_vyymmdd.mot**を選択し、**Add**をクリックします。
- NOTE :** The yy is two digits of year. The mm is month. The dd is date.
- 注意 :** yyは年の下二桁、mmは月、ddは日

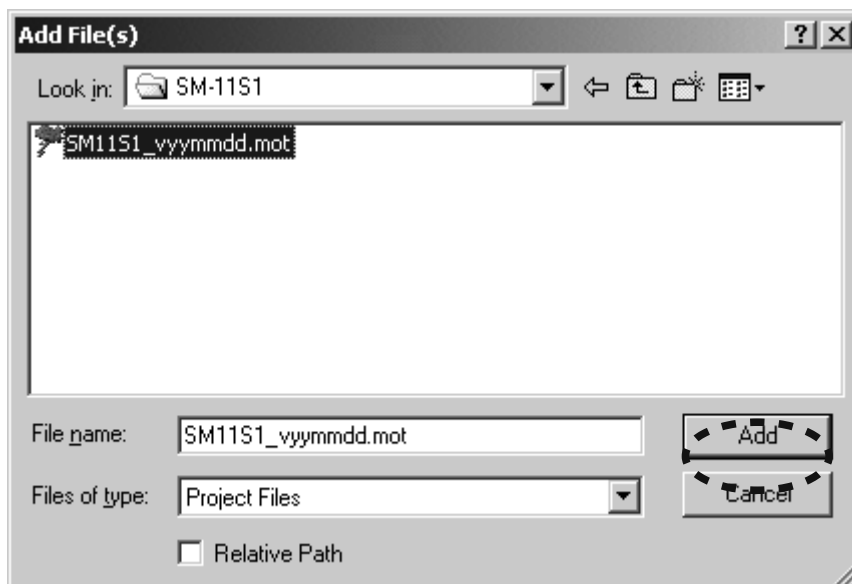

11. Press the **POWER ON/OFF** button for turn on the unit. At the time, the LCD display and LED does not light.
11. **POWER ON/OFF**ボタンを押し、本機の電源を入れます。この時、LCDディスプレイとLEDは点灯しません。

12. Click the **Device** in the menu bar and select the **Connect to Device**.

12. **Device**をクリックし、メニューから**Connect to Device**をクリックします。

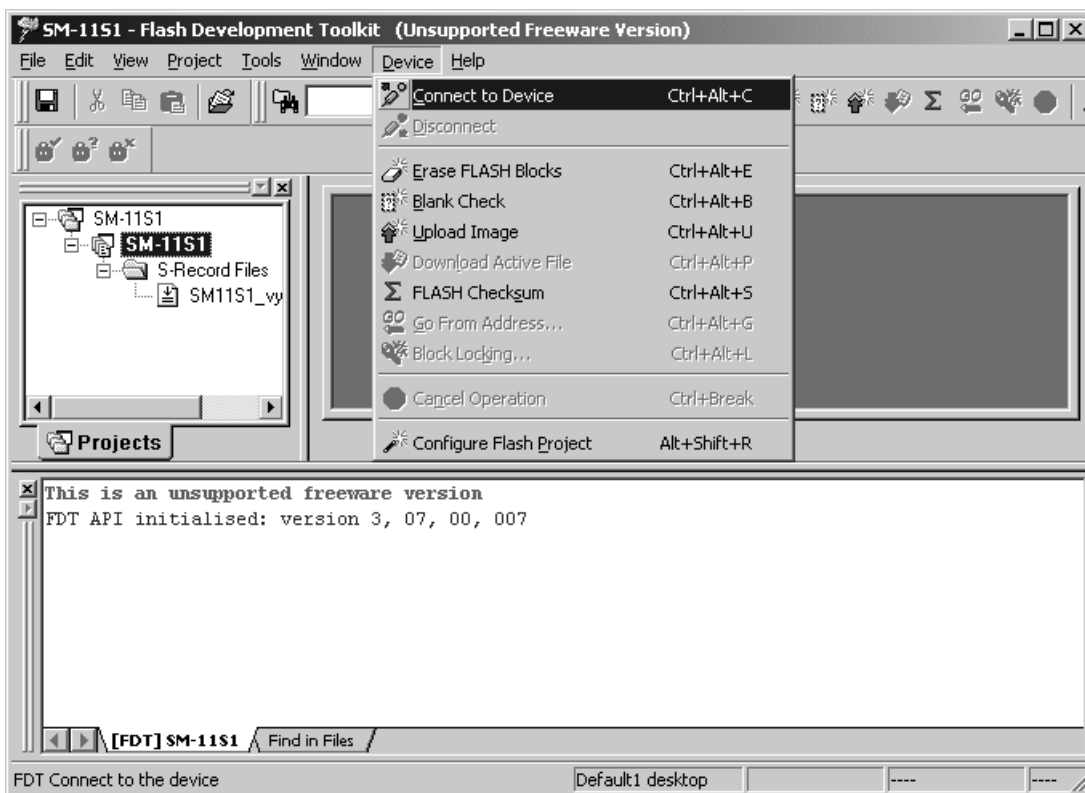

13. Press right button of mouse on the **SM11S1_vyymmdd**.

13. **SM11S1_vyymmdd.mot**を右クリックし、メニューから**Download File**をクリックします。

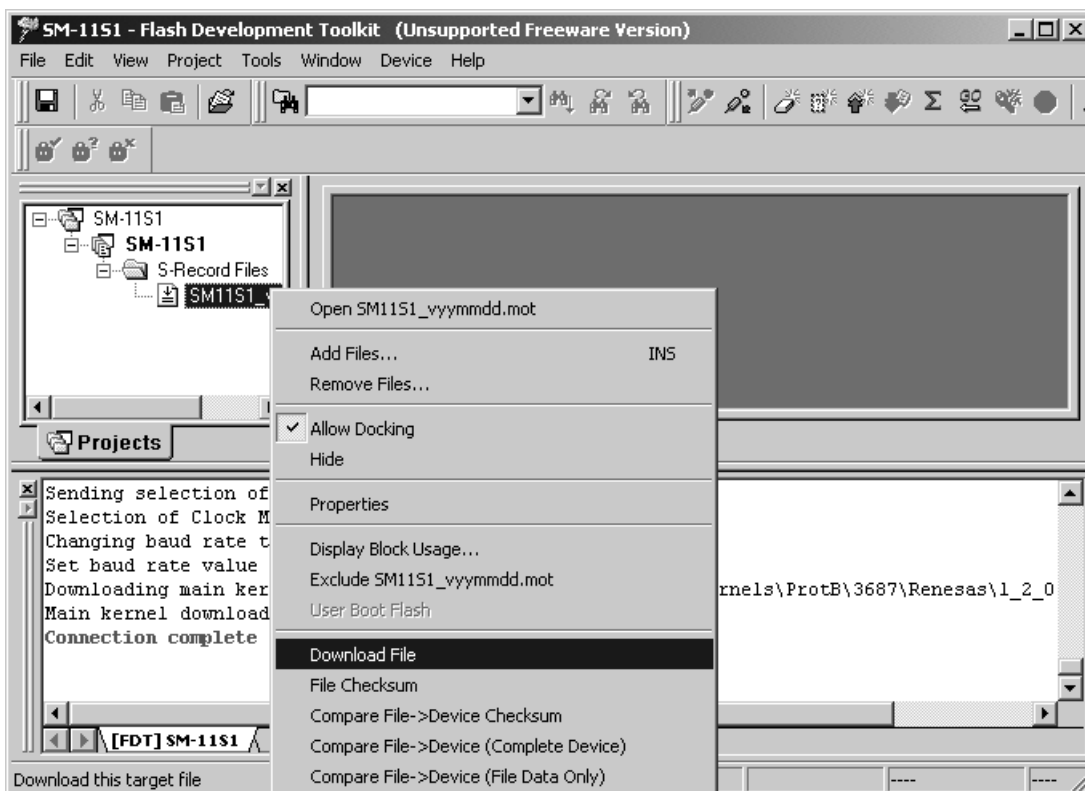

14. Software is written into the microprocessor.
The writing of software takes about 30 seconds.

14. ソフトウェアがマイコンに書き込まれます。
書き込みにかかる時間は約30秒です。

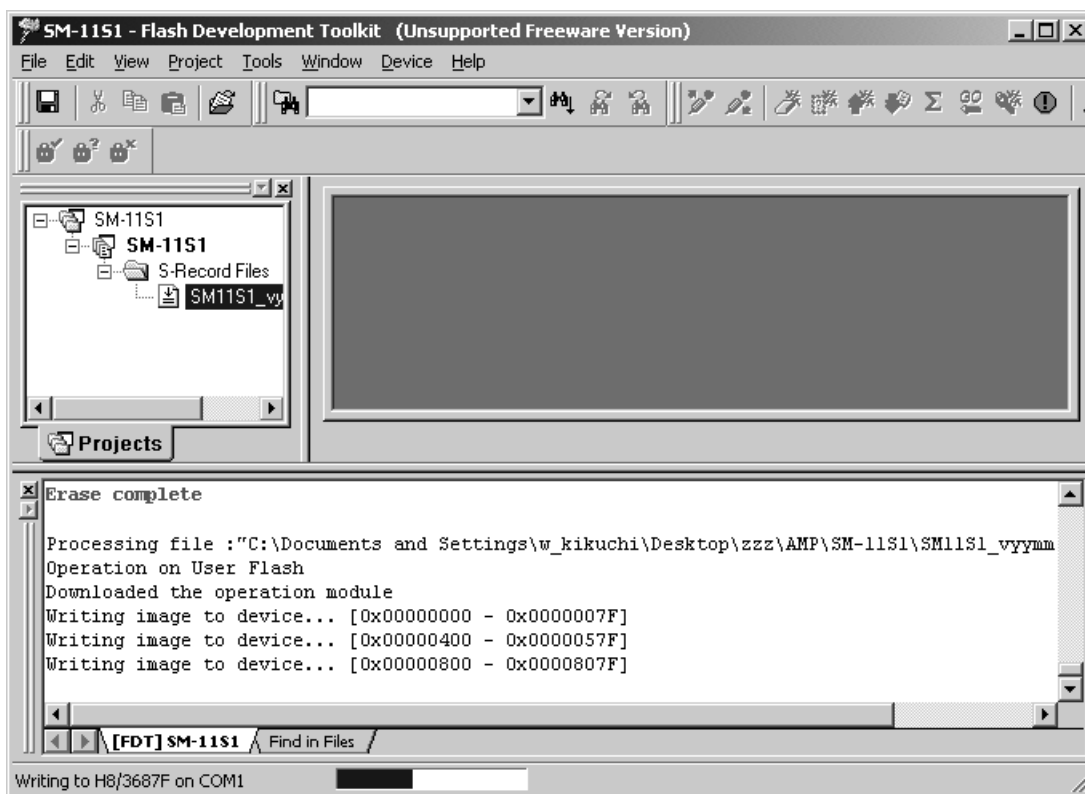

15. Click the **Device** in the menu bar and select the **Disconnect**.

15. **Device**をクリックし、メニューから**Disconnect**をクリックします。

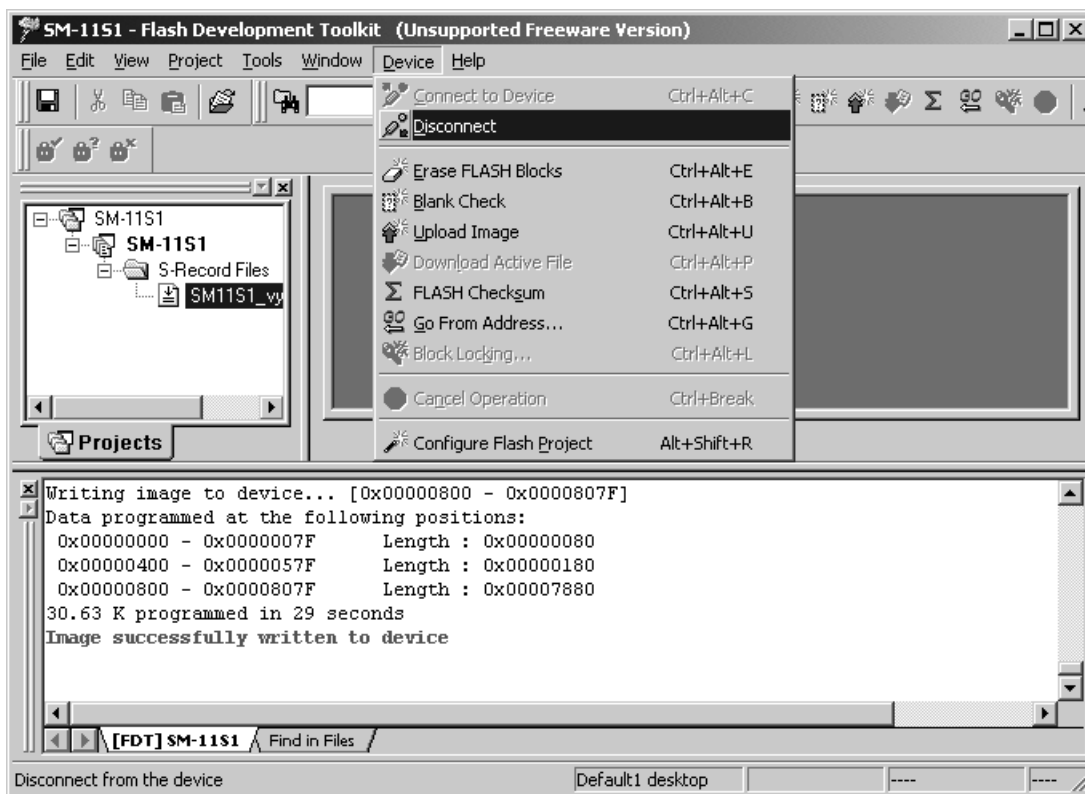

16. Click the **File** and select the **Exit** in menu.

16. **File**をクリックし、メニューから**Exit**をクリックします。

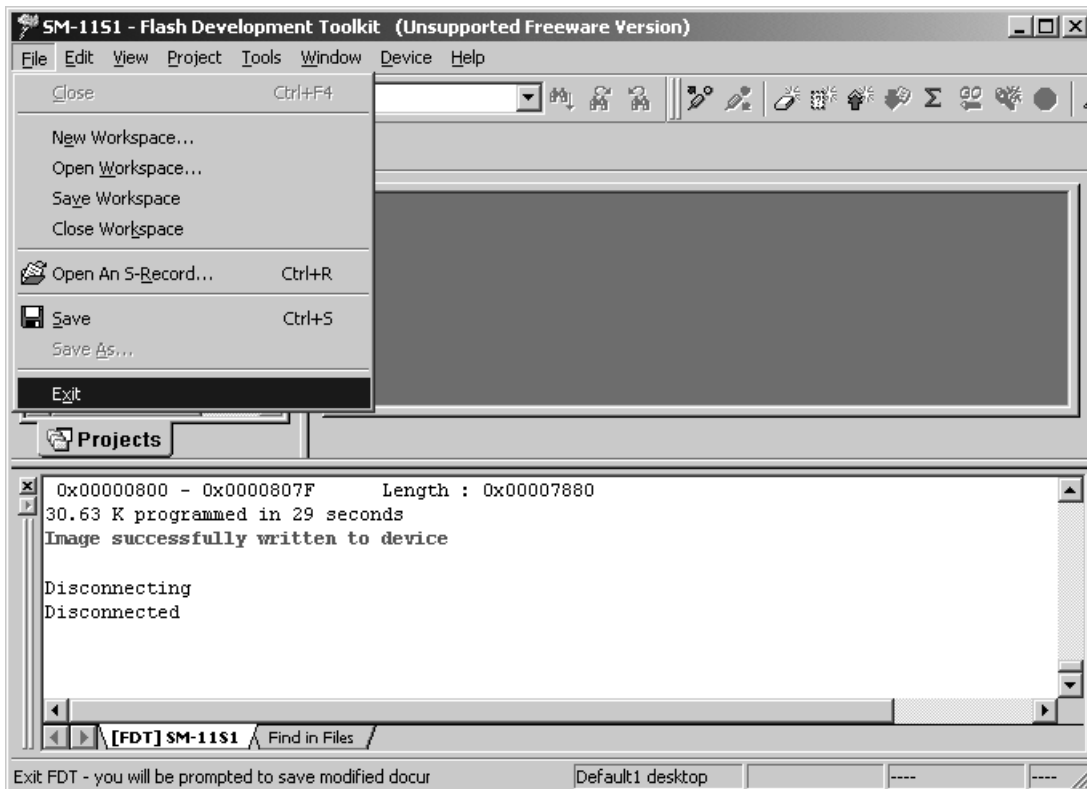

17. Press the **POWER ON/OFF** button for turn off the unit.

17. **POWER ON/OFF**ボタンを押し、本機の電源を切ります。

18. Disconnect the mains cord and FFC from the unit.

18.. 本機から電源コードとFFCを外します。

19. Check the version number of the firmware Refer to "4. SERVICE MODE".

19. Versionの確認をします。"4.SERVICE MODE"で確認します。書き込んだバージョンが正しければ書き換え完了です。

6. WIRING DIAGRAM

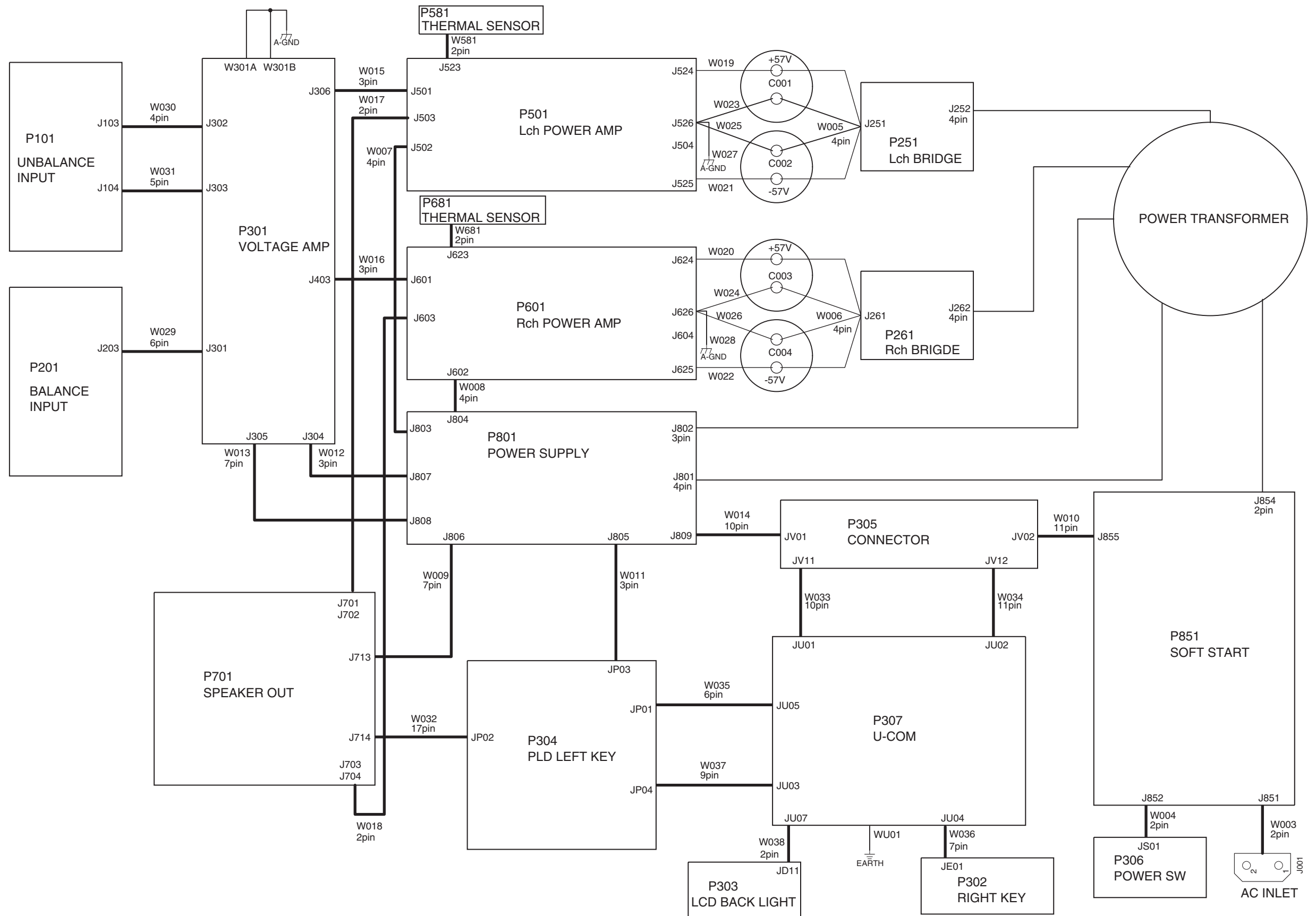

7. BLOCK DIAGRAM

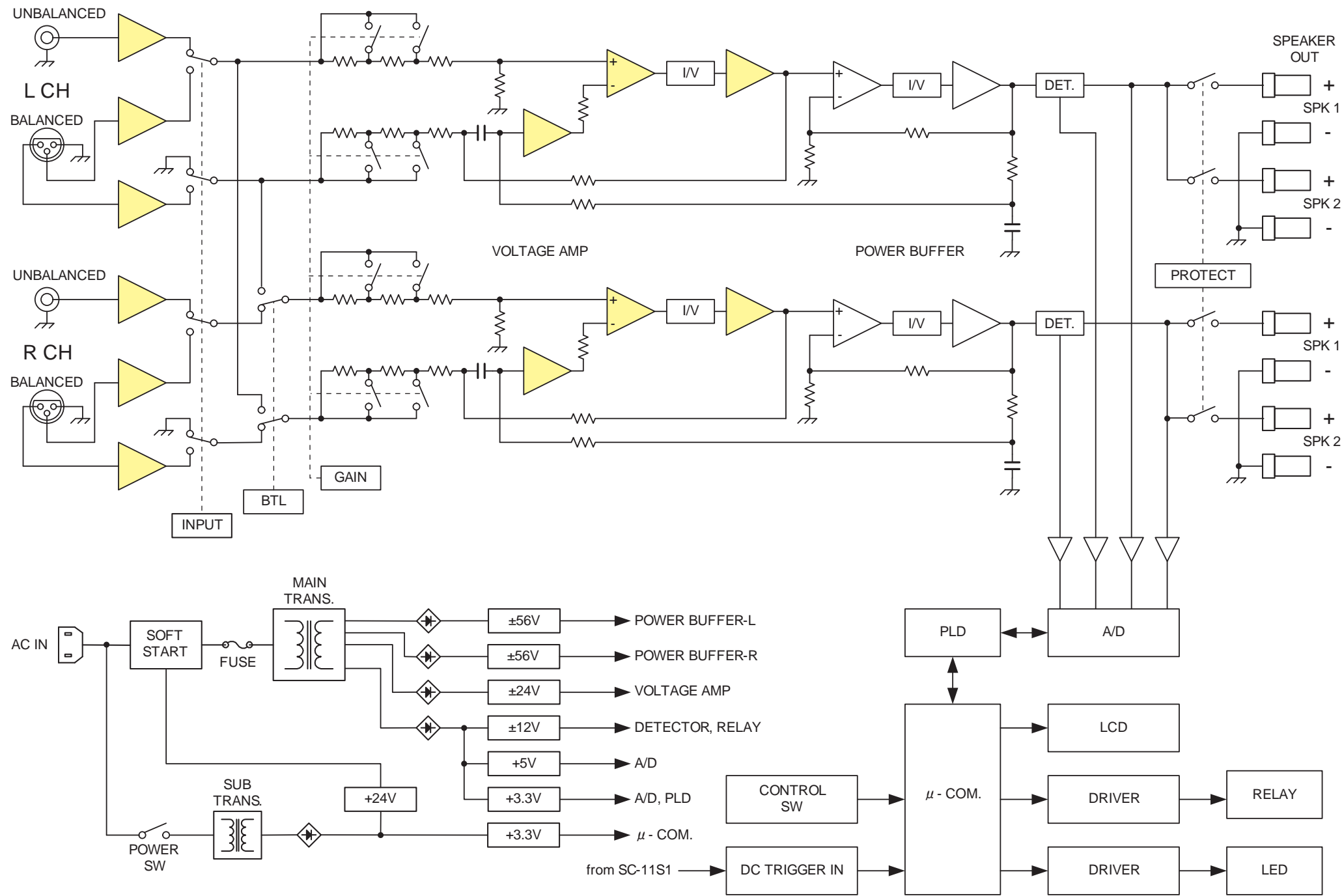

8. SCHEMATIC DIAGRAM

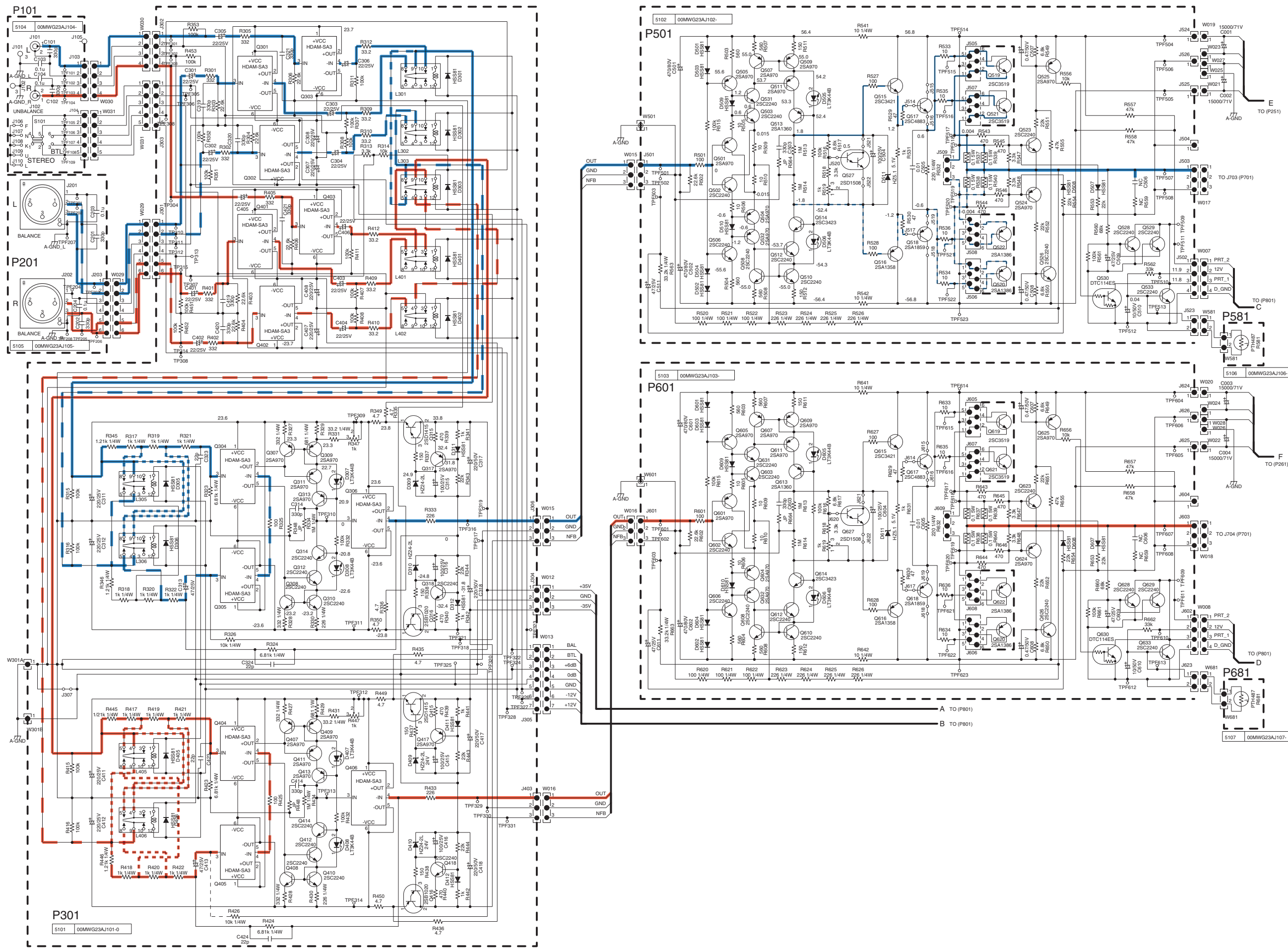

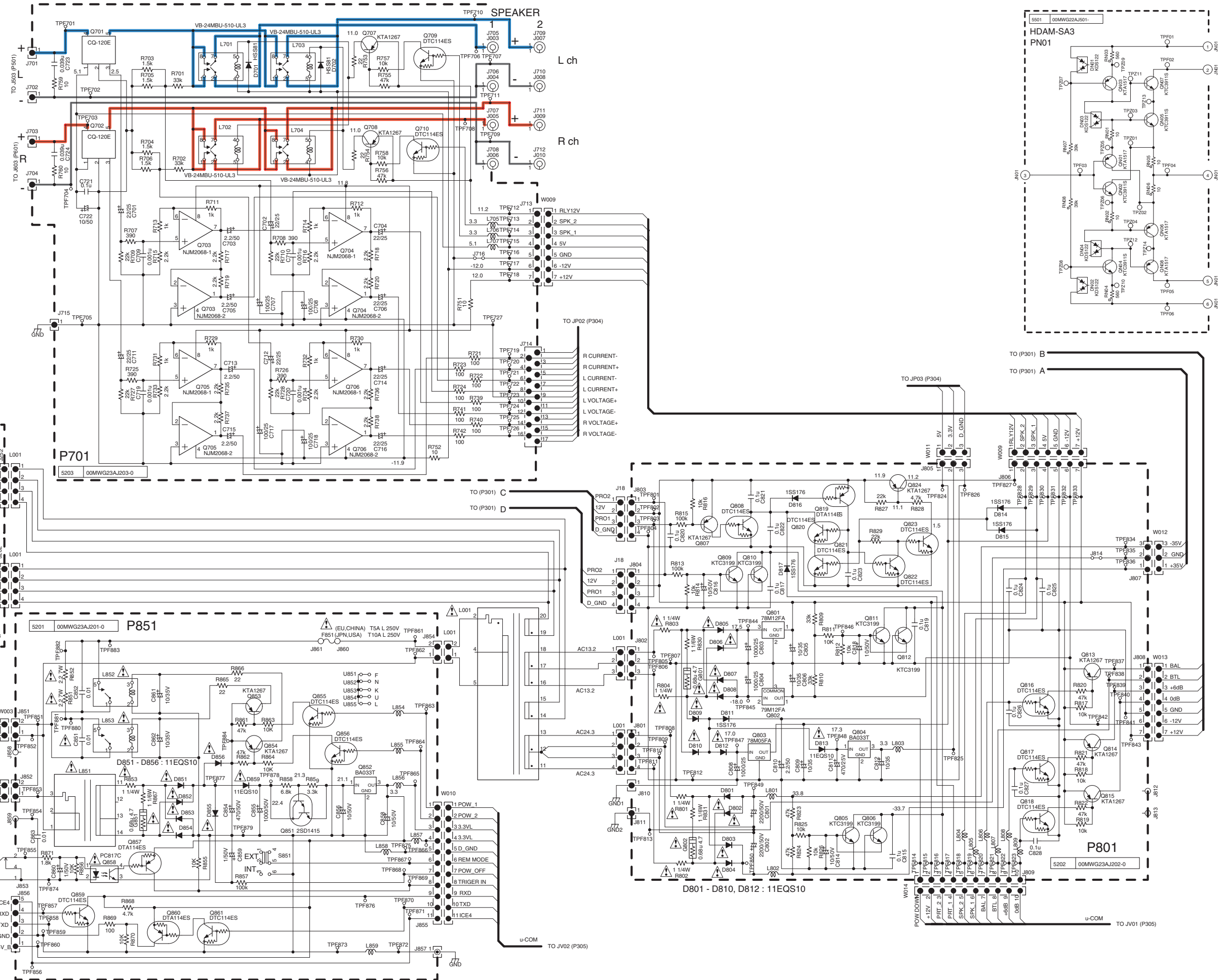

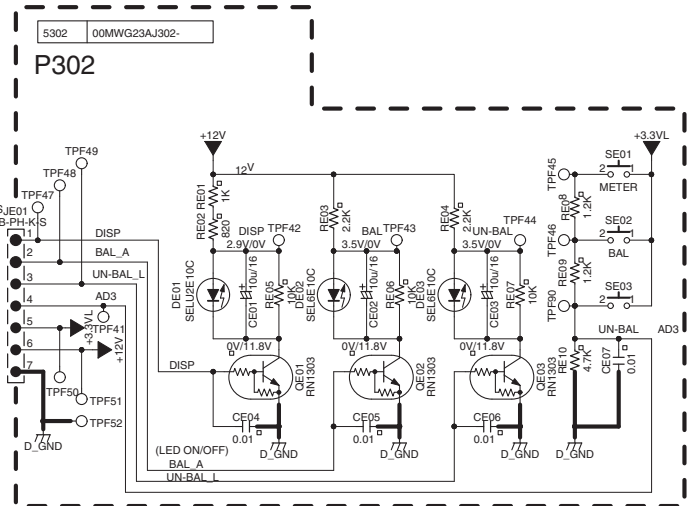
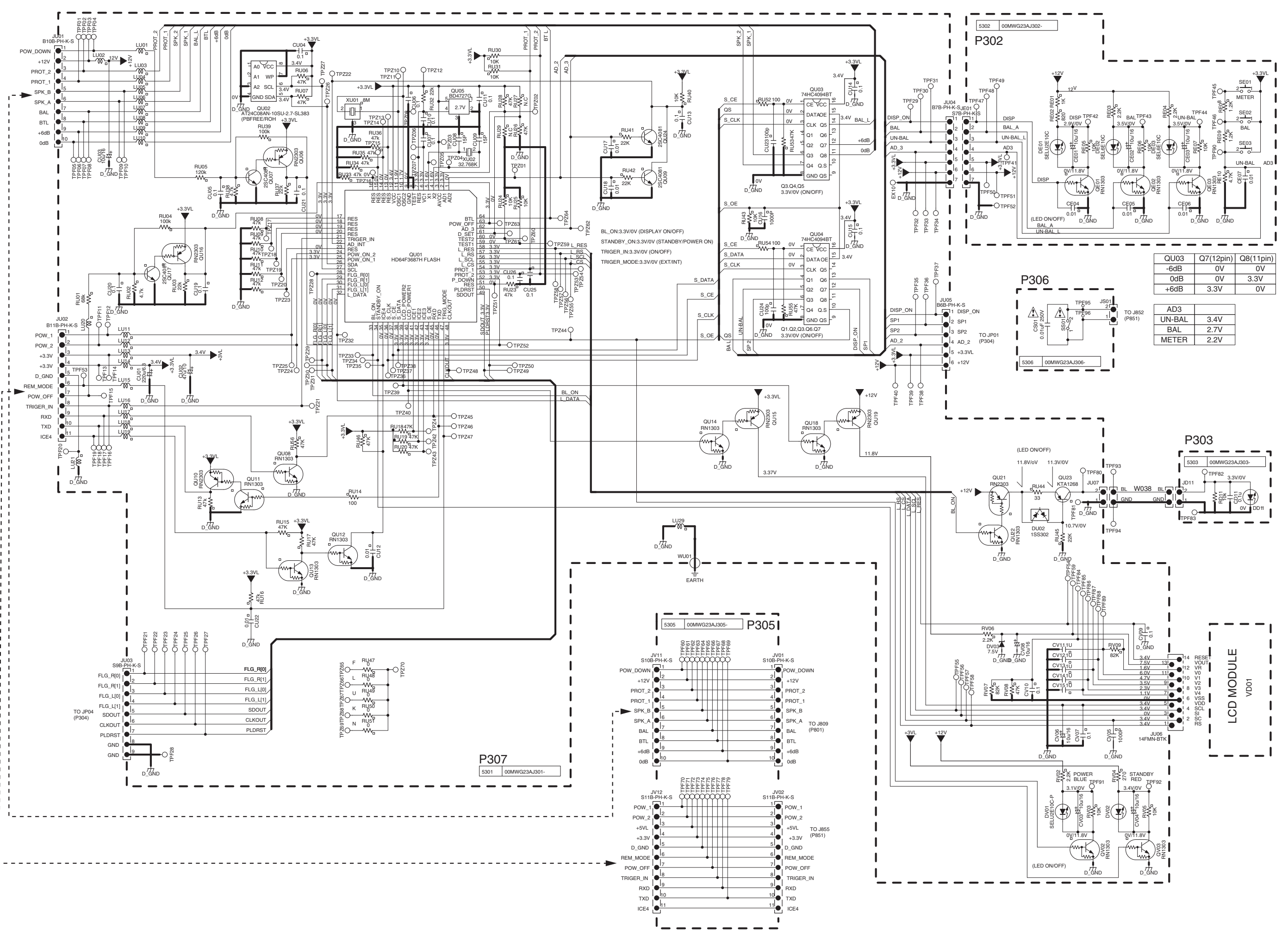

QU03	Q7(12pin)	Q8(11pin)
-6dB	0V	0V
0dB	0V	3.3V
+6dB	3.3V	0V

AD3	UN-BAL	3.4V
UN-BAL	BAL	2.7V
METER	METER	2.2V

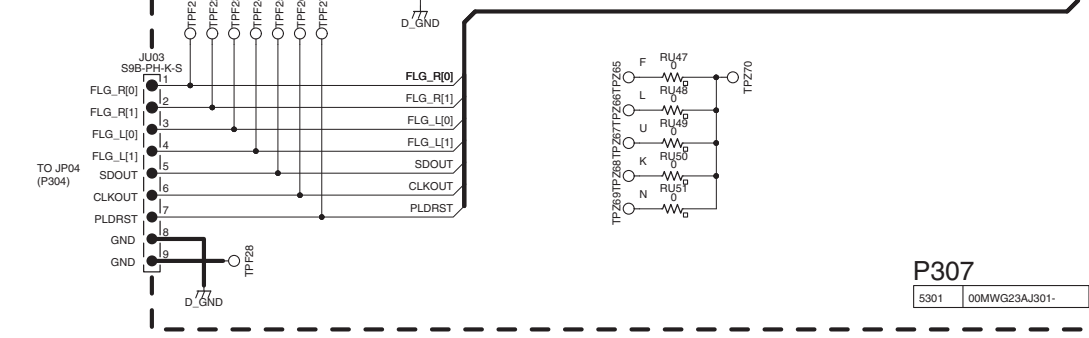
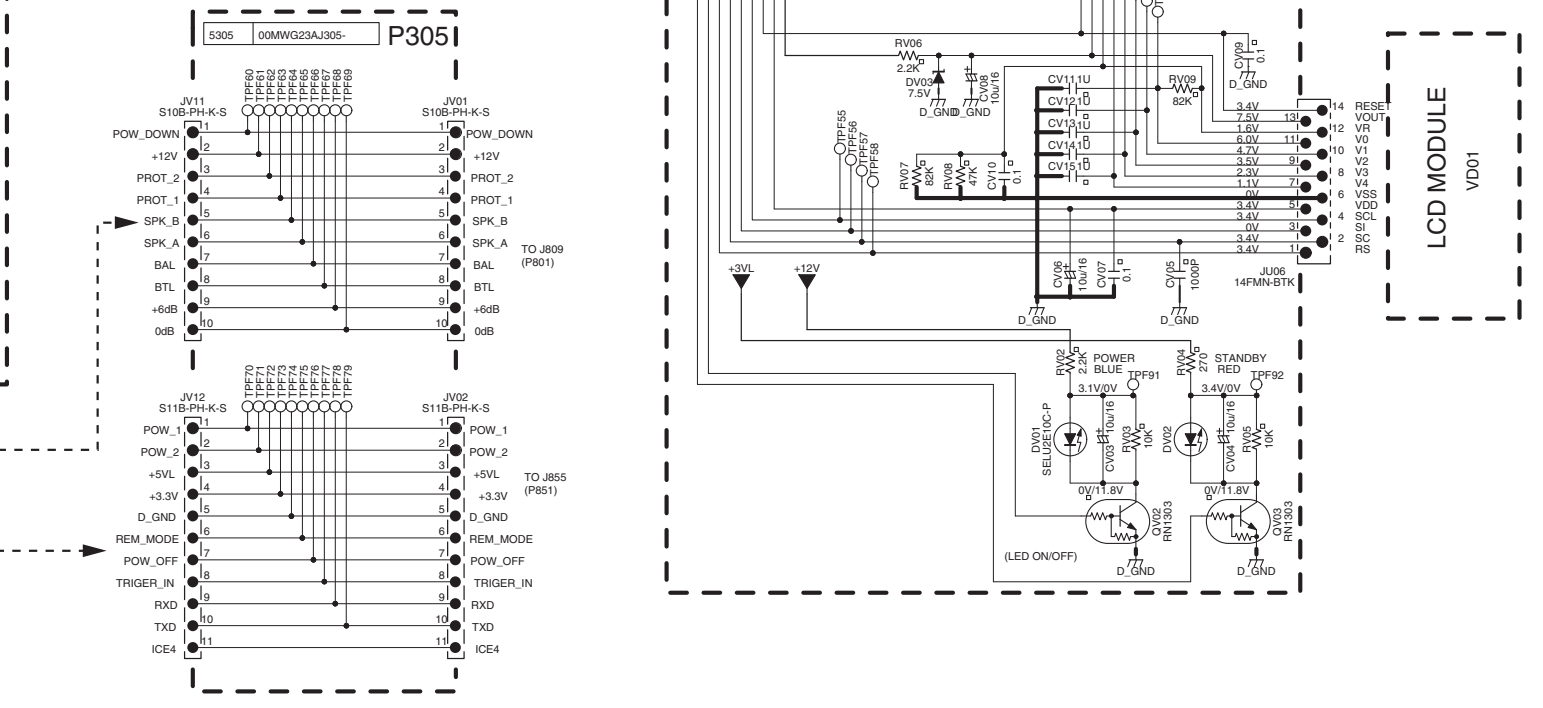
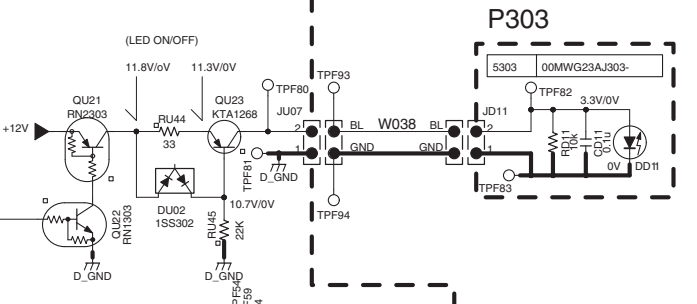
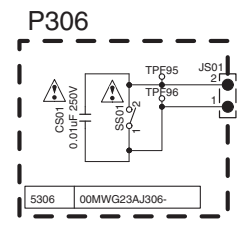

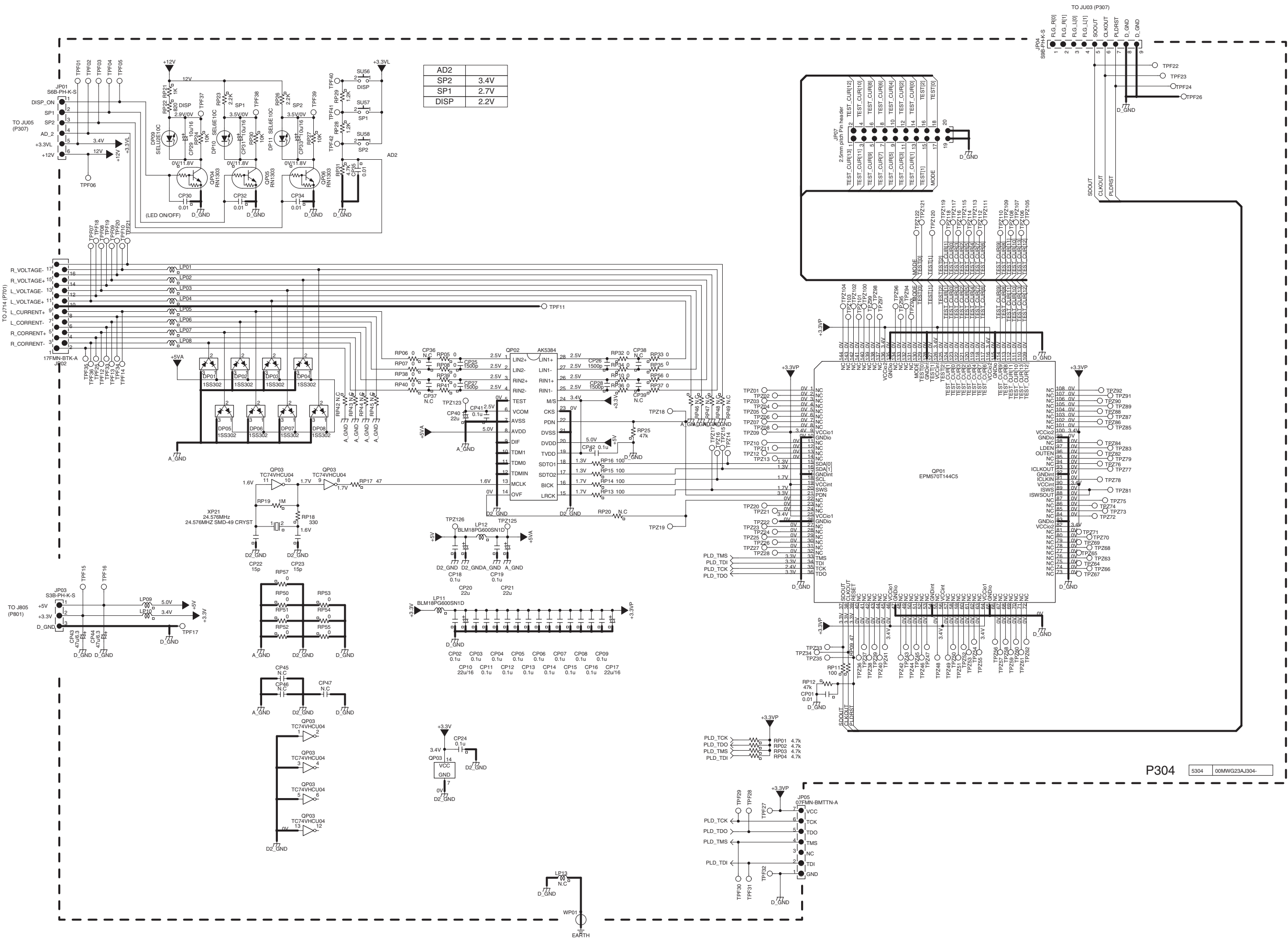

AD2	
SP2	3.4V
SP1	2.7V
DISP	2.2V

- CP02 0.1u
- CP03 0.1u
- CP04 0.1u
- CP05 0.1u
- CP06 0.1u
- CP07 0.1u
- CP08 0.1u
- CP09 0.1u
- CP10 22u/16
- CP11 0.1u
- CP12 0.1u
- CP13 0.1u
- CP14 0.1u
- CP15 0.1u
- CP16 0.1u
- CP17 22u/16

P304 5304 00MVG23AJ304-

9. PARTS LOCATION

P101B

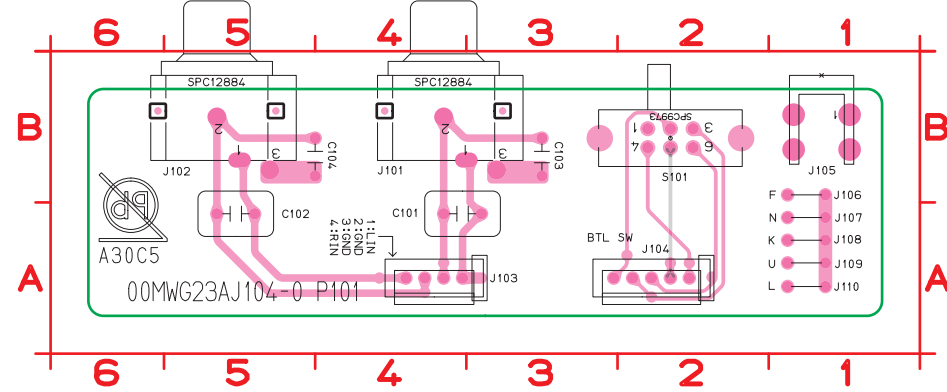

C101	A3
C102	A5
C103	B3
C104	B5
J101	B4
J102	B5
J103	A4
J104	A2
J105	B1
J106	B1
J107	A1
J108	A1
J109	A1
J110	A1
S101	B2

P201A

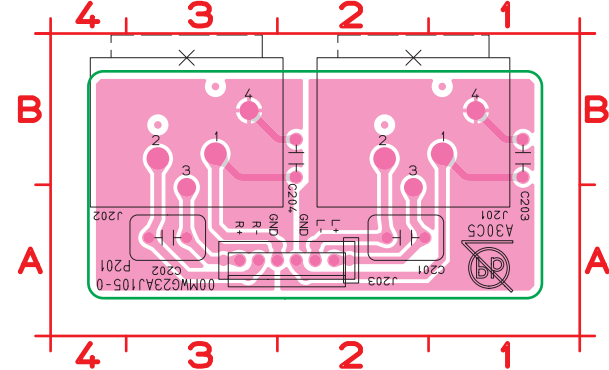

C201	A2
C202	A3
C203	B1
C204	B2
J201	B2
J202	B3
J203	A2

P251B

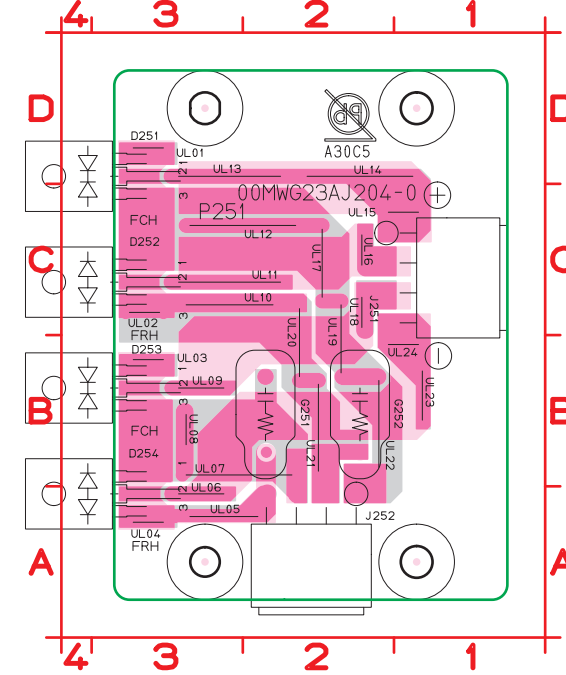

D251	D3	UL19	B2
D252	C3	UL20	B2
D253	B3	UL21	B2
D254	A3	UL22	B2
G251	B2	UL23	B1
G252	B2	UL24	B1
J251	C2		
J252	A2		
UL01	D3		
UL02	C3		
UL03	B3		
UL04	A3		
UL05	A2		
UL06	A3		
UL07	B2		
UL08	B3		
UL09	B3		
UL10	C2		
UL11	C2		
UL12	C2		
UL13	D2		
UL14	D1		
UL15	C1		
UL16	C2		
UL17	C2		
UL18	C2		

P261B

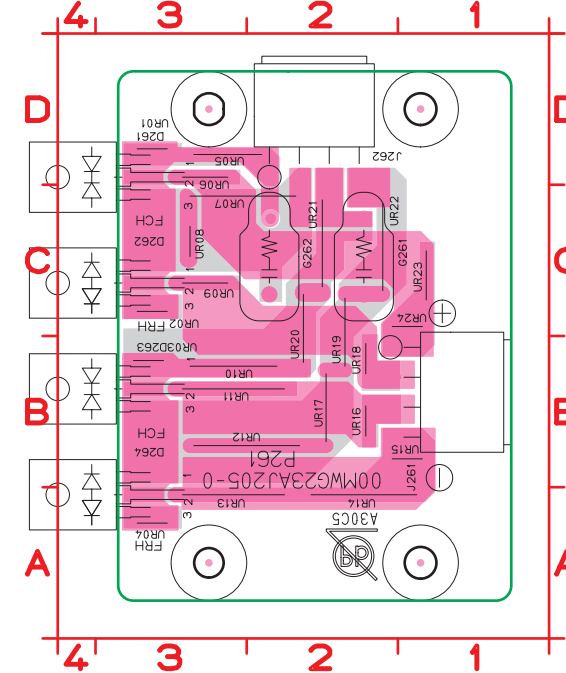

D261	D3	UR23	C1
D262	C3	UR24	C1
D263	B3		
D264	A3		
G261	C2		
G262	C2		
J261	B2		
J262	D2		
UR01	D3		
UR02	C3		
UR03	B3		
UR04	A3		
UR05	D2		
UR06	D3		
UR07	C2		
UR08	C3		
UR09	C3		
UR10	B2		
UR11	B2		
UR12	B2		
UR13	A2		
UR14	A1		
UR15	B1		
UR16	B2		
UR17	B2		
UR18	B2		
UR19	B2		
UR20	B2		
UR21	C2		
UR22	C2		

鉛フリー半田
半田付けには、鉛フリー半田 (Sn-Ag-Cu) を使用してください。

Lead-free Solder
When soldering, use the Lead-free Solder (Sn-Ag-Cu).

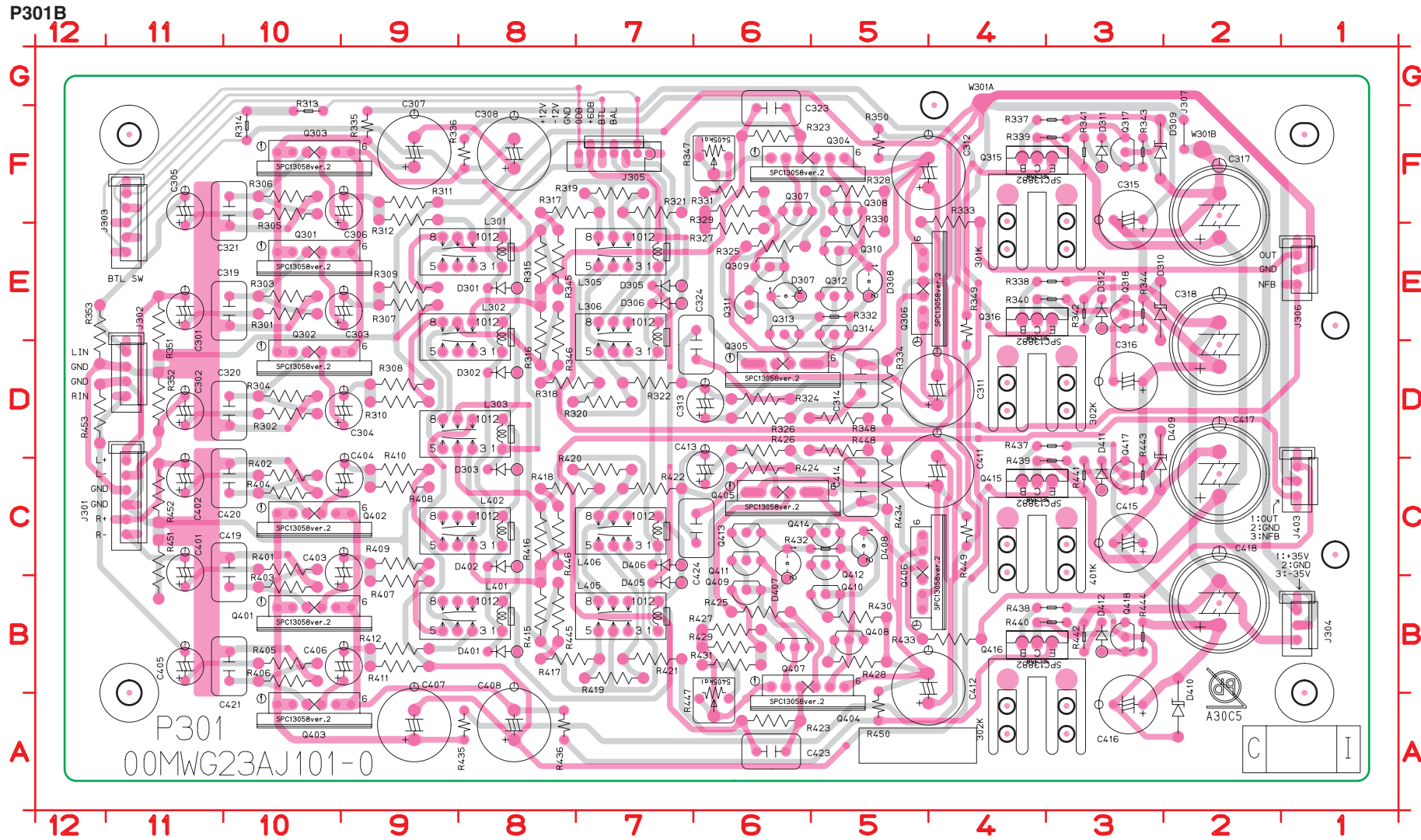

C301	E11	C323	F6	C420	C10	D407	C6	L401	B8	Q316	E4	Q417	C3	R318	D8	R337	F4	R403	B10	R424	C6	R443	C3
C302	D11	C324	E6	C421	B10	D408	C5	L402	C8	Q317	F3	Q418	B3	R319	F7	R338	E3	R404	C10	R425	B6	R444	B3
C303	E9	C401	B11	C423	A6	D409	C3	L405	B7	Q318	E3	R301	E10	R320	D8	R339	F4	R405	B10	R426	D6	R445	B8
C304	D9	C402	C11	C424	C6	D410	A2	L406	C7	Q401	B10	R302	D10	R321	F7	R340	E3	R406	B10	R427	B6	R446	C8
C305	E11	C403	B9	D301	E8	D411	C3	Q301	E10	Q402	C10	R303	E10	R322	D7	R341	F3	R407	B9	R428	B5	R447	A6
C306	E9	C404	C9	D302	D8	D412	B3	Q302	D10	Q403	A10	R304	D10	R323	F6	R342	E3	R408	C9	R429	B6	R448	D6
C307	F9	C405	B11	D303	C8	J301	C11	Q303	F10	Q404	B6	R305	F10	R324	D6	R343	F3	R409	C9	R430	B5	R449	C4
C308	F8	C406	B9	D305	E7	J302	D11	Q304	F6	Q405	C6	R306	F10	R325	E6	R344	E3	R410	C9	R431	B6	R450	B5
C311	D4	C407	A9	D306	E7	J303	F11	Q305	D6	Q406	C5	R307	E9	R326	D6	R345	E8	R411	B9	R432	C6	R451	B11
C312	F5	C408	A8	D307	E6	J304	B1	Q306	E5	Q407	B6	R308	D9	R327	E6	R346	D8	R412	B9	R433	B5	R452	C11
C313	D6	C411	C4	D308	E5	J305	F7	Q307	F6	Q408	B5	R309	E9	R328	F5	R347	F6	R415	B8	R434	C5	R453	D12
C314	D5	C412	A5	D309	F3	J306	E1	Q308	F5	Q409	B6	R310	D9	R329	F6	R348	D6	R416	C8	R435	A8	W301	G4
C315	F3	C413	C6	D310	E3	J307	F2	Q309	E6	Q410	B5	R311	F9	R330	E5	R349	D4	R417	B8	R436	A8	W301	F2
C316	D3	C414	C5	D311	F3	J403	C1	Q310	E5	Q411	C6	R312	F9	R331	F6	R350	F5	R418	C8	R437	D4		
C317	E2	C415	C3	D312	E3	L301	E8	Q311	E6	Q412	C5	R313	F10	R332	E5	R351	E11	R419	B7	R438	B3		
C318	D2	C416	A3	D401	B8	L302	D8	Q312	E5	Q413	C6	R314	F10	R333	F5	R352	D11	R420	C8	R439	C4		
C319	E10	C417	C2	D402	C8	L303	D8	Q313	E6	Q414	C5	R315	E8	R334	D5	R353	D12	R421	B7	R440	B3		
C320	D10	C418	B2	D405	B7	L305	E7	Q314	E5	Q415	C4	R316	E8	R335	F9	R401	C10	R422	C7	R441	C3		
C321	F10	C419	B10	D406	C7	L306	D7	Q315	F4	Q416	B4	R317	F8	R336	F8	R402	C10	R423	A6	R442	B3		

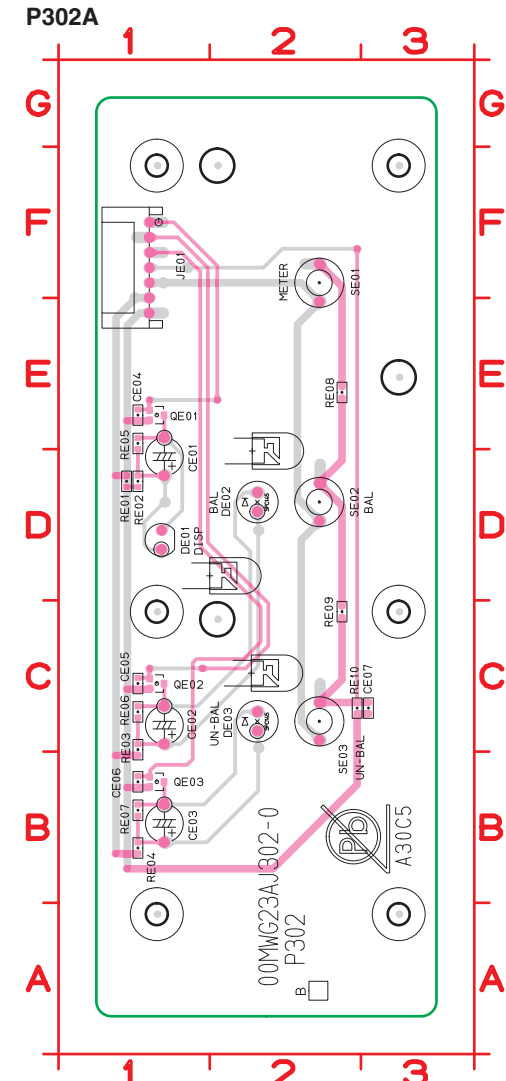

CE01	D1
CE02	C1
CE03	B1
CE04	E1
CE05	C1
CE06	B1
DE01	D1
DE02	D2
DE03	C2
JE01	F1
QE01	E1
QE02	C1
QE03	B1
RE01	D1
RE02	D1
RE03	C1
RE04	B1
RE05	E1
RE06	C1
RE07	B1
RE08	E2
RE09	C2
RE10	C2
SE01	F2
SE02	D2
SE03	C2

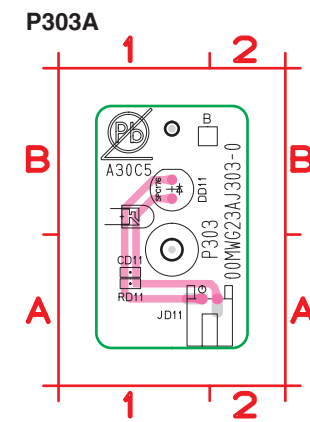

CD11	A1
DD11	B1
JD11	A1
RD11	A1

鉛フリー半田
半田付けには、鉛フリー半田 (Sn-Ag-Cu) を使用してください。

Lead-free Solder
When soldering, use the Lead-free Solder (Sn-Ag-Cu).

P304A

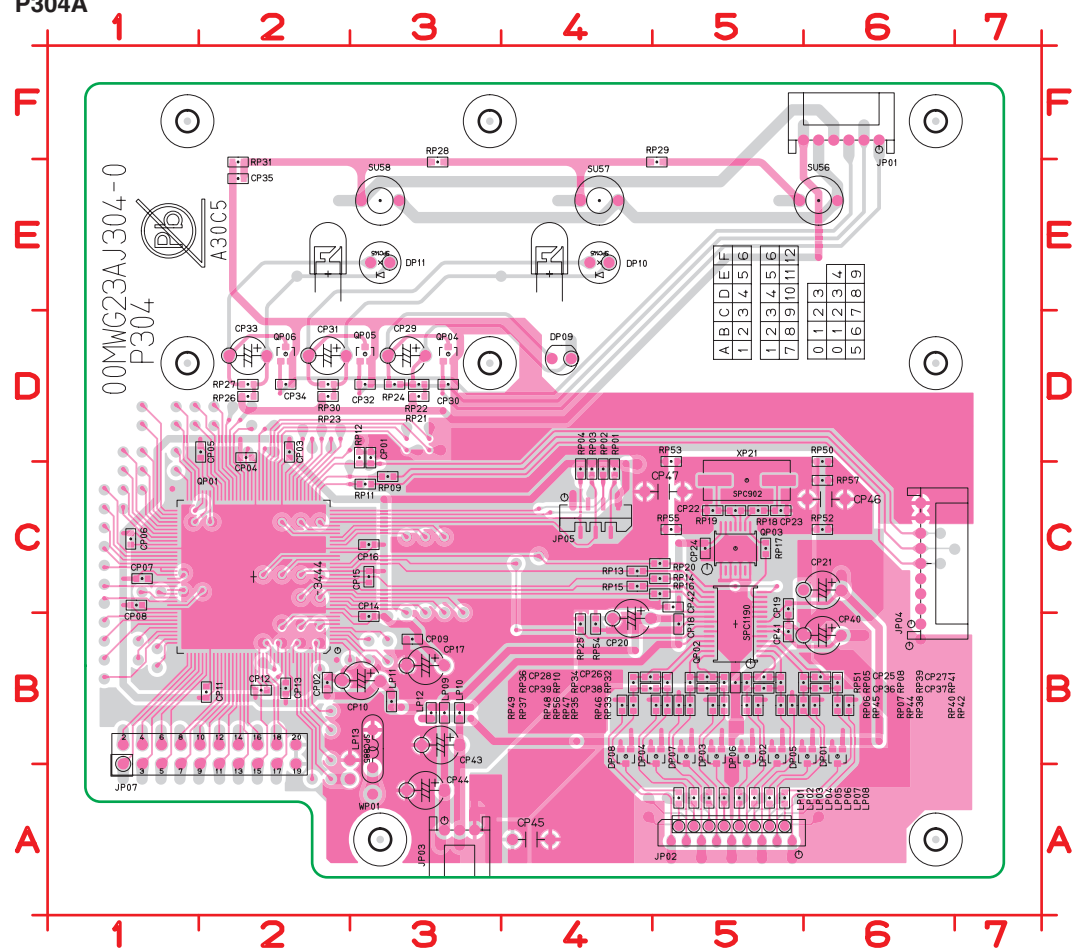

CP01 D3	CP24 C5	CP47 C5	LP06 A5	RP10 B5	RP33 B5	RP56 B5
CP02 B2	CP25 B5	DP01 B6	LP07 A5	RP11 C3	RP34 B5	RP57 C6
CP03 D2	CP26 B5	DP02 B5	LP08 A5	RP12 D3	RP35 B5	SU56 E6
CP04 D2	CP27 B6	DP03 B5	LP09 B3	RP13 C4	RP36 B4	SU57 E4
CP05 D2	CP28 B4	DP04 B5	LP10 B3	RP14 C5	RP37 B4	SU58 E3
CP06 C1	CP29 D3	DP05 B6	LP11 B3	RP15 C4	RP38 B6	WP01 A3
CP07 C1	CP30 D3	DP06 B5	LP12 B3	RP16 C5	RP39 B6	XP21 C5
CP08 C1	CP31 D2	DP07 B5	LP13 B3	RP17 C5	RP40 B6	
CP09 B3	CP32 D3	DP08 B4	QP01 C2	RP18 C5	RP41 B6	
CP10 B3	CP33 D2	DP09 D4	QP02 B5	RP19 C5	RP42 B6	
CP11 B2	CP34 D2	DP10 E4	QP03 C5	RP20 C5	RP43 B6	
CP12 B2	CP35 E2	DP11 E3	QP04 D3	RP21 D3	RP44 B5	
CP13 B2	CP36 B5	JP01 F6	QP05 D3	RP22 D3	RP45 B5	
CP14 B3	CP37 B6	JP02 A5	QP06 D2	RP23 D2	RP46 B5	
CP15 C3	CP38 B5	JP03 A3	RP01 C4	RP24 D3	RP47 B5	
CP16 C3	CP39 B4	JP04 B6	RP02 C4	RP25 B4	RP48 B5	
CP17 B3	CP40 B6	JP05 C4	RP03 C4	RP26 D2	RP49 B4	
CP18 B5	CP41 B5	JP07 B1	RP04 C4	RP27 D2	RP50 D6	
CP19 C5	CP42 C5	LP01 A5	RP05 B5	RP28 E3	RP51 B5	
CP20 B4	CP43 B3	LP02 A5	RP06 B5	RP29 E5	RP52 C6	
CP21 C6	CP44 A3	LP03 A5	RP07 B5	RP30 D2	RP53 D5	
CP22 C5	CP45 A4	LP04 A5	RP08 B5	RP31 E2	RP54 B4	
CP23 C5	CP46 C6	LP05 A5	RP09 C3	RP32 B5	RP55 C5	

P305B

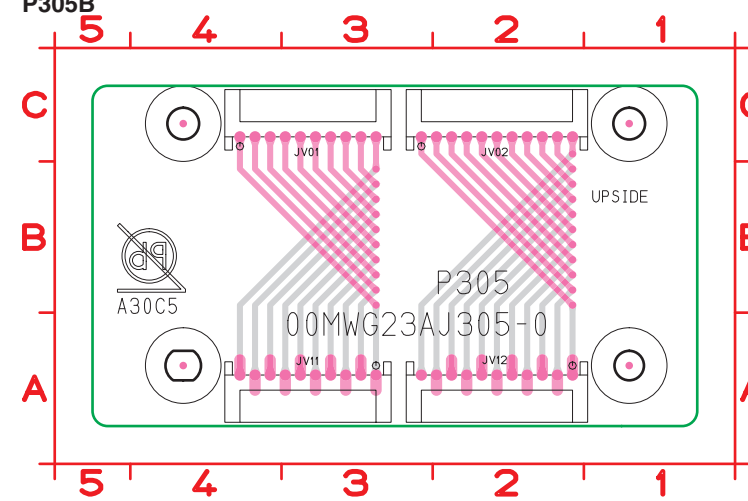

JV01 C4
JV02 C3
JV11 A3
JV12 A2

P306B

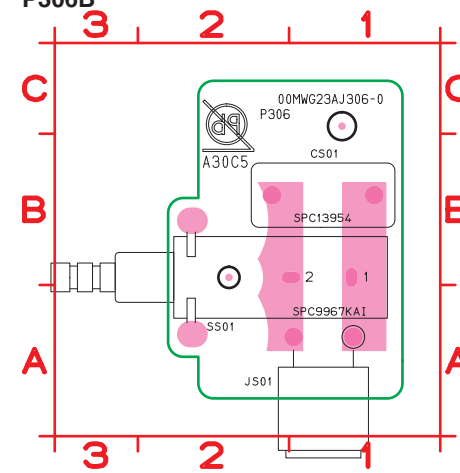

CS01 B1
JS01 A1
SS01 B1

鉛フリー半田
半田付けには、鉛フリー半田 (Sn-Ag-Cu) を使用してください。
Lead-free Solder
When soldering, use the Lead-free Solder (Sn-Ag-Cu).

P307A

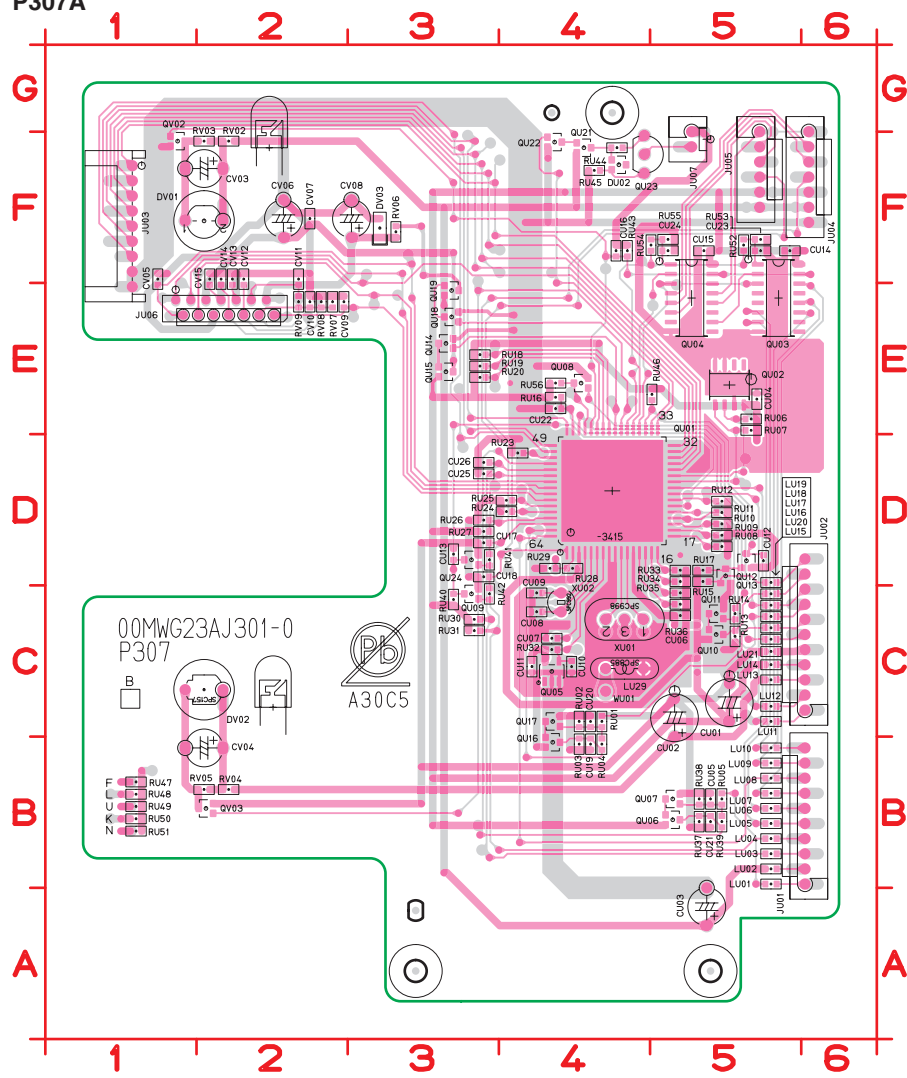

CU01	C5	CV07	F2	LU11	C5	QU19	E3	RU26	D3	RU56	E4
CU02	C5	CV08	F3	LU12	C5	QU21	F4	RU27	D3	RV02	F2
CU03	A5	CV09	E2	LU13	C5	QU22	F4	RU28	D4	RV03	F2
CU04	E5	CV10	E2	LU14	C5	QU23	F4	RU29	D4	RV04	B2
CU05	B5	CV11	F2	LU15	C5	QU24	D3	RU30	C3	RV05	B2
CU06	C5	CV12	F2	LU16	C5	QV02	F1	RU31	C3	RV06	F3
CU07	C4	CV13	F2	LU17	C5	QV03	B2	RU32	C4	RV07	E2
CU08	C4	CV14	F2	LU18	C5	RU01	C4	RU33	D5	RV08	E2
CU09	C4	CV15	F2	LU19	D5	RU02	C4	RU34	D5	RV09	E2
CU10	C4	DU02	F4	LU20	C5	RU03	B4	RU35	C5	WU01	C4
CU11	C4	DV01	F2	LU21	C5	RU04	B4	RU36	C5	XU01	C4
CU12	D5	DV02	C2	LU29	C4	RU05	B5	RU37	B5	XU02	C4
CU13	D3	DV03	F3	QU01	D4	RU06	E5	RU38	B5		
CU14	F5	JU01	B6	QU02	E5	RU07	E5	RU39	B5		
CU15	F5	JU02	C6	QU03	E5	RU08	D5	RU40	C3		
CU16	F4	JU03	F1	QU04	E5	RU09	D5	RU41	D3		
CU17	D3	JU04	G6	QU05	C4	RU10	D5	RU42	C3		
CU18	D3	JU05	G5	QU06	B5	RU11	D5	RU43	F4		
CU19	B4	JU06	E1	QU07	B5	RU12	D5	RU44	F4		
CU20	C4	JU07	G5	QU08	E4	RU13	C5	RU45	F4		
CU21	B5	LU01	B5	QU09	C3	RU14	C5	RU46	E5		
CU22	E4	LU02	B5	QU10	C5	RU15	D5	RU47	B1		
CU23	F5	LU03	B5	QU11	C5	RU16	E4	RU48	B1		
CU24	F5	LU04	B5	QU12	D5	RU17	D5	RU49	B1		
CU25	D3	LU05	B5	QU13	D5	RU18	E3	RU50	B1		
CU26	D3	LU06	B5	QU14	E3	RU19	E3	RU51	B1		
CV03	F2	LU07	B5	QU15	E3	RU20	E3	RU52	F5		
CV04	B2	LU08	B5	QU16	B4	RU23	D4	RU53	F5		
CV05	F1	LU09	B5	QU17	C4	RU24	D4	RU54	F5		
CV06	F2	LU10	B5	QU18	E3	RU25	D4	RU55	F5		

鉛フリー半田
半田付けには、鉛フリー半田 (Sn-Ag-Cu) を使用してください。

Lead-free Solder
When soldering, use the Lead-free Solder (Sn-Ag-Cu).

P501B

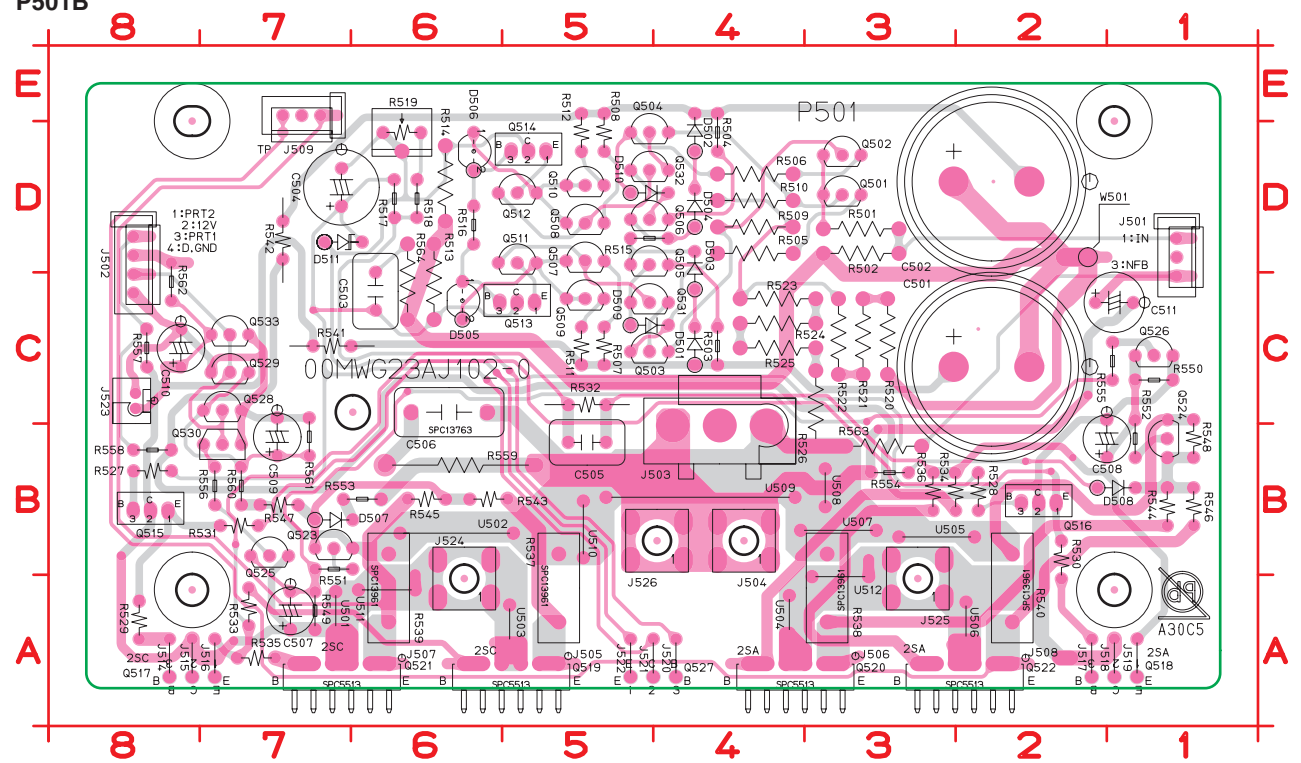

C501	C3	D509	C5	J521	A5	Q514	D5	R504	D4	R523	C4	R542	D7	R561	B7
C502	D3	D510	D5	J522	A5	Q515	B8	R505	D4	R524	C3	R543	B5	R562	C8
C503	C6	D511	D7	J523	C8	Q516	B2	R506	D4	R525	C4	R544	B1	R563	B3
C504	D7	J501	D1	J524	A6	Q517	A8	R507	C5	R526	C3	R545	B6	R564	D6
C505	B5	J502	D8	J525	A3	Q518	A1	R508	D5	R527	B8	R546	B1	U501	A7
C506	C6	J503	B4	J526	B4	Q523	B7	R509	D4	R528	B2	R547	B7	U502	B5
C507	A7	J504	B4	Q501	D3	Q524	B1	R510	D4	R529	A8	R548	C1	U503	A5
C508	B2	J505	A5	Q502	D3	Q525	B7	R511	C5	R530	A2	R549	A7	U504	A4
C509	B7	J506	A3	Q503	C5	Q526	C1	R512	D5	R531	B7	R550	C1	U505	B2
C510	C8	J507	A6	Q504	D5	Q527	A5	R513	C6	R532	C5	R551	B7	U506	A2
C511	C2	J508	A2	Q505	D5	Q528	C7	R514	D6	R533	A7	R552	B1	U507	B3
D501	C4	J509	E7	Q506	D5	Q529	C7	R515	D5	R534	B3	R553	B7	U508	B3
D502	D4	J514	A8	Q507	D5	Q530	B7	R516	D6	R535	A7	R554	B3	U509	B4
D503	C4	J515	A8	Q508	D5	Q531	C5	R517	D6	R536	B3	R555	C1	U510	B5
D504	D4	J516	A7	Q509	C5	Q532	D5	R518	D6	R537	A5	R556	B7	U511	A6
D505	C6	J517	A2	Q510	D5	Q533	C7	R519	D6	R538	B3	R557	C8	U512	A3
D506	D6	J518	A1	Q511	D5	R501	D3	R520	C3	R539	A6	R558	B8	W501	D2
D507	B7	J519	A1	Q512	D5	R502	D3	R521	C3	R540	B2	R559	B6		
D508	B2	J520	A4	Q513	C5	R503	C4	R522	C3	R541	C7	R560	B7		

P581B

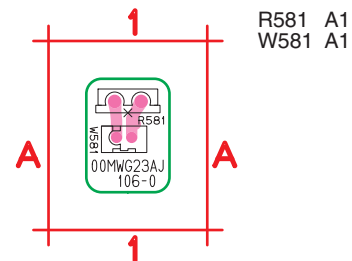

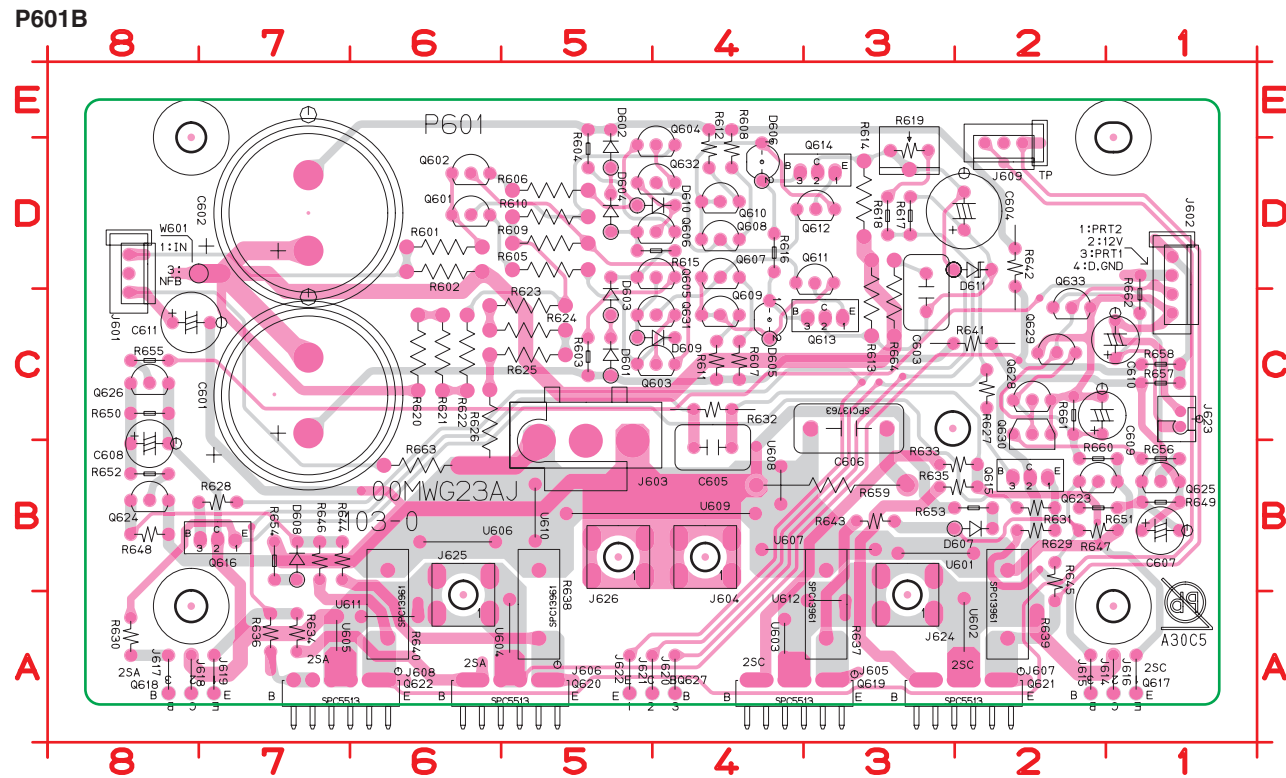

- | | | | | | | | |
|---------|---------|---------|---------|---------|---------|---------|---------|
| C601 C7 | D609 C5 | J621 A5 | Q614 D3 | R604 D5 | R623 C5 | R642 D2 | R661 C2 |
| C602 D7 | D610 D5 | J622 A5 | Q615 B2 | R605 D5 | R624 C6 | R643 B3 | R662 C1 |
| C603 C3 | D611 D3 | J623 C1 | Q616 B7 | R606 D5 | R625 C5 | R644 B7 | R663 B6 |
| C604 D2 | J601 D8 | J624 A3 | Q617 A1 | R607 C4 | R626 C6 | R645 A2 | R664 D3 |
| C605 B4 | J602 D1 | J625 A6 | Q618 A8 | R608 D4 | R627 C2 | R646 B7 | U601 B2 |
| C606 C3 | J603 B5 | J626 B4 | Q623 B2 | R609 D5 | R628 B7 | R647 B2 | U602 A2 |
| C607 B1 | J604 B5 | Q601 D6 | Q624 B8 | R610 D5 | R629 B2 | R648 B8 | U603 A4 |
| C608 B8 | J605 A3 | Q602 D6 | Q625 B1 | R611 C4 | R630 A8 | R649 B1 | U604 A5 |
| C609 C2 | J606 A5 | Q603 C4 | Q626 C8 | R612 D4 | R631 B2 | R650 C8 | U605 A7 |
| C610 C1 | J607 A2 | Q604 D4 | Q627 A5 | R613 C3 | R632 C4 | R651 B1 | U606 B6 |
| C611 C8 | J608 A6 | Q605 D4 | Q628 C2 | R614 D3 | R633 B2 | R652 B8 | U607 B3 |
| D601 C5 | J609 D2 | Q606 D4 | Q629 C2 | R615 D4 | R634 A7 | R653 B2 | U608 B4 |
| D602 D5 | J614 A2 | Q607 D4 | Q630 C2 | R616 D4 | R635 B2 | R654 B7 | U609 B4 |
| D603 C5 | J615 A1 | Q608 D4 | Q631 C4 | R617 D3 | R636 A7 | R655 C8 | U610 B5 |
| D604 D5 | J616 A1 | Q609 C4 | Q632 D4 | R618 D3 | R637 A3 | R656 B1 | U611 A6 |
| D605 C4 | J617 A8 | Q610 D4 | Q633 C2 | R619 D3 | R638 B5 | R657 C1 | U612 A3 |
| D606 D4 | J618 A8 | Q611 D3 | R601 D6 | R620 C6 | R639 A2 | R658 C1 | W601 D8 |
| D607 B3 | J619 A7 | Q612 D3 | R602 D6 | R621 C6 | R640 B6 | R659 B3 | |
| D608 B7 | J620 A4 | Q613 C3 | R603 C5 | R622 C6 | R641 C3 | R660 B1 | |

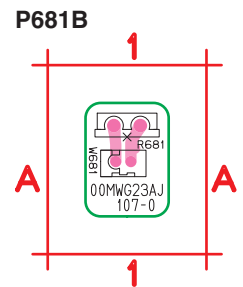

R681 A1
W681 A1

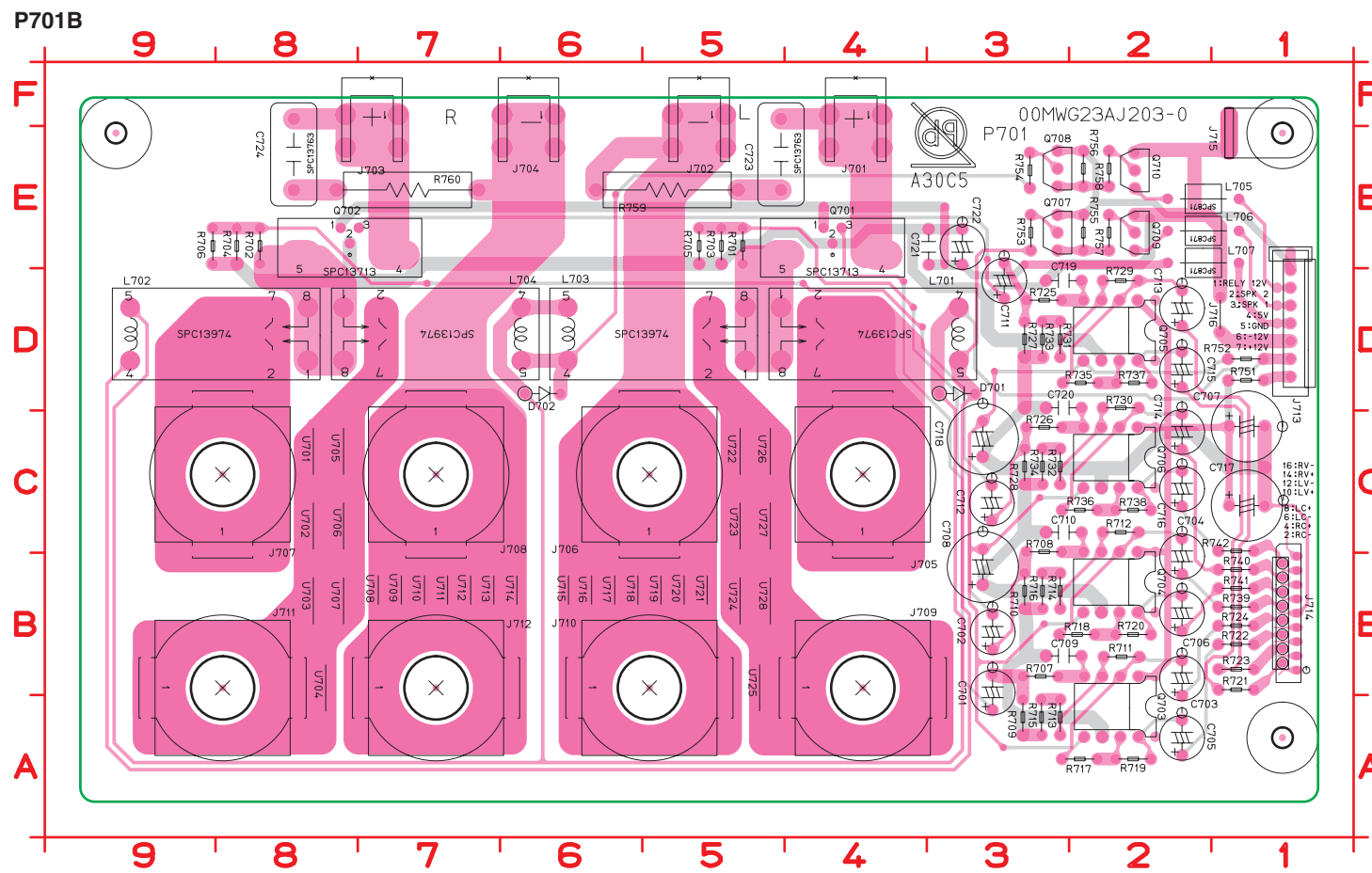

- | | | |
|---------|----------|---------|
| C873 B3 | D891 B6 | R882 B5 |
| C874 B4 | G871 A2 | R883 C6 |
| C875 B3 | J871 B1 | R884 C6 |
| C876 B4 | J872 D1 | R885 B8 |
| C877 C3 | J873 D10 | R886 B7 |
| C878 C4 | J874 B10 | R887 C7 |
| C879 C3 | J875 D6 | R889 C7 |
| C880 C5 | J876 D9 | R890 C8 |
| C881 B7 | L871 B2 | R891 A3 |
| C882 C7 | L872 B5 | R892 A5 |
| C883 B6 | L873 C1 | RH97 C8 |
| C884 C6 | L874 D1 | RH98 C9 |
| C885 C7 | L875 C10 | |
| C886 C6 | L876 C10 | |
| C887 B8 | L877 B8 | |
| C888 B7 | L878 B8 | |
| C889 C7 | L879 B8 | |
| CH97 B9 | L880 A8 | |
| CH98 C9 | L881 A8 | |
| D871 A3 | Q871 D3 | |
| D872 A3 | Q872 D4 | |
| D873 A3 | Q873 D3 | |
| D874 A3 | Q874 D4 | |
| D875 A4 | Q876 D8 | |
| D876 A4 | Q877 D7 | |
| D877 A4 | Q878 C6 | |
| D878 A4 | Q879 B8 | |
| D879 D3 | Q880 C8 | |
| D880 D4 | Q881 D2 | |
| D881 D3 | Q882 D5 | |
| D882 D4 | R871 B2 | |
| D883 D3 | R872 B2 | |
| D884 D4 | R874 E3 | |
| D885 A5 | R875 D3 | |
| D886 A5 | R876 D4 | |
| D887 A5 | R877 D3 | |
| D888 A5 | R878 D5 | |
| D889 B6 | R879 C2 | |
| D890 B5 | R880 C5 | |

鉛フリー半田
半田付けには、鉛フリー半田 (Sn-Ag-Cu) を使用してください。

Lead-free Solder
When soldering, use the Lead-free Solder (Sn-Ag-Cu).

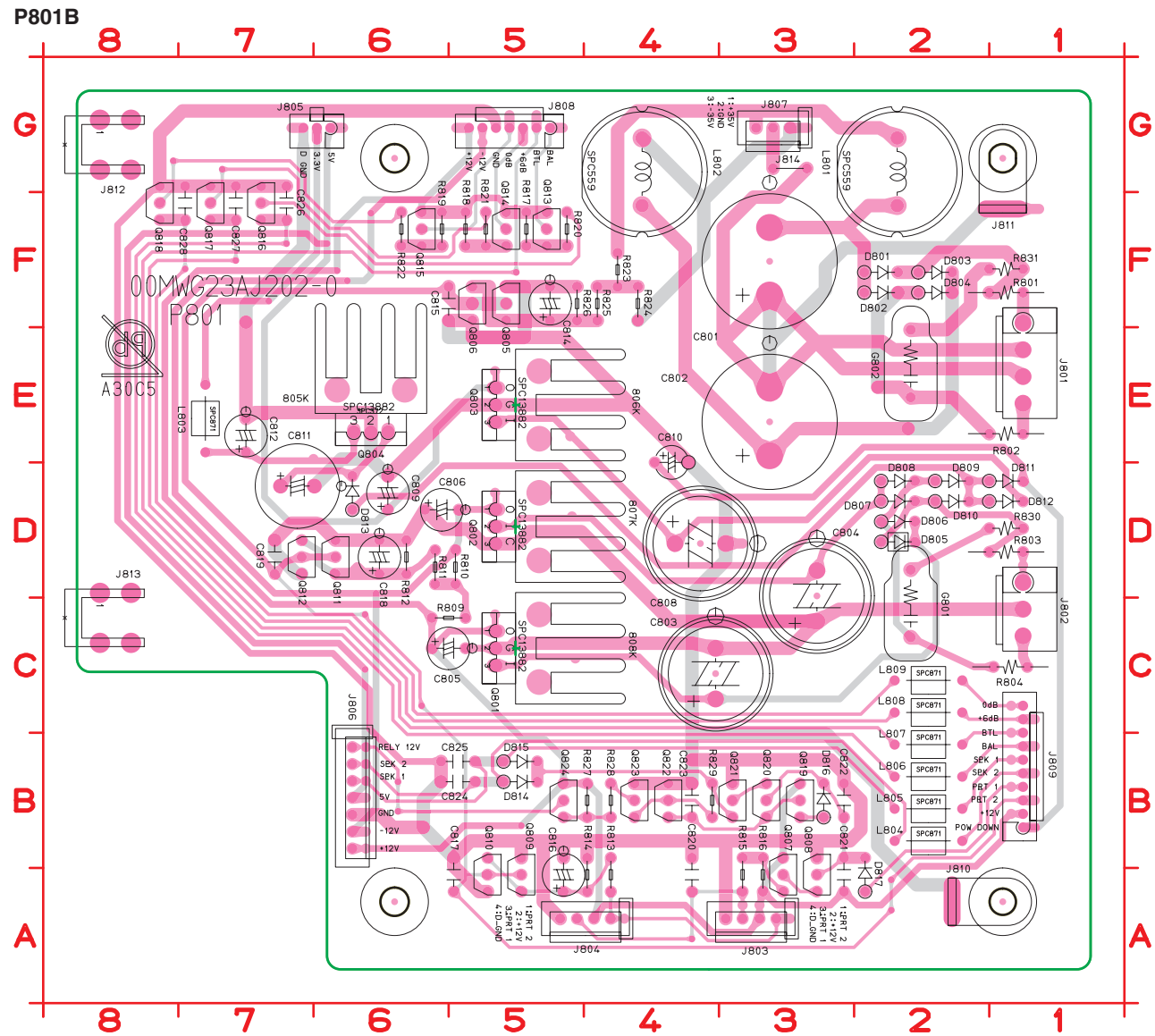

C801	F3	C820	A4	D809	D2	J807	G3	Q801	C5	Q818	F8	R815	A3
C802	E3	C821	A3	D810	D2	J808	G5	Q802	D5	Q819	B3	R816	A3
C803	C4	C822	B3	D811	D2	J809	B1	Q803	E5	Q820	B3	R817	F5
C804	C3	C823	B4	D812	D2	J810	A1	Q804	E6	Q821	B3	R818	F5
C805	C6	C824	B5	D813	D6	J811	G1	Q805	F5	Q822	B4	R819	F6
C806	D6	C825	B5	D814	B5	J812	G8	Q806	F5	Q823	B4	R820	F5
C808	D4	C826	F7	D815	B5	J813	C8	Q807	A3	Q824	B5	R821	F5
C809	D6	C827	F7	D816	B3	J814	G3	Q808	A3	R801	F1	R822	F6
C810	E4	C828	G7	D817	A2	L801	F2	Q809	A5	R802	E1	R823	F4
C811	D7	D801	F2	G801	D2	L802	F4	Q810	A5	R803	D1	R824	F4
C812	E7	D802	F2	G802	E2	L803	E7	Q811	D6	R804	C1	R825	F4
C814	F5	D803	F2	J801	F1	L804	B2	Q812	D7	R809	C6	R826	F5
C815	F6	D804	F2	J802	D1	L805	B2	Q813	F5	R810	D5	R827	B4
C816	A5	D805	D2	J803	A3	L806	B2	Q814	F5	R811	D6	R828	B4
C817	A5	D806	D2	J804	A4	L807	B2	Q815	F6	R812	D6	R829	B4
C818	D6	D807	D2	J805	G6	L808	C2	Q816	F7	R813	A4	R830	D1
C819	D7	D808	D2	J806	B6	L809	C2	Q817	F7	R814	A4	R831	F1

鉛フリー半田

半田付けには、鉛フリー半田 (Sn-Ag-Cu) を使用してください。

Lead-free Solder

When soldering, use the Lead-free Solder (Sn-Ag-Cu).

P851B

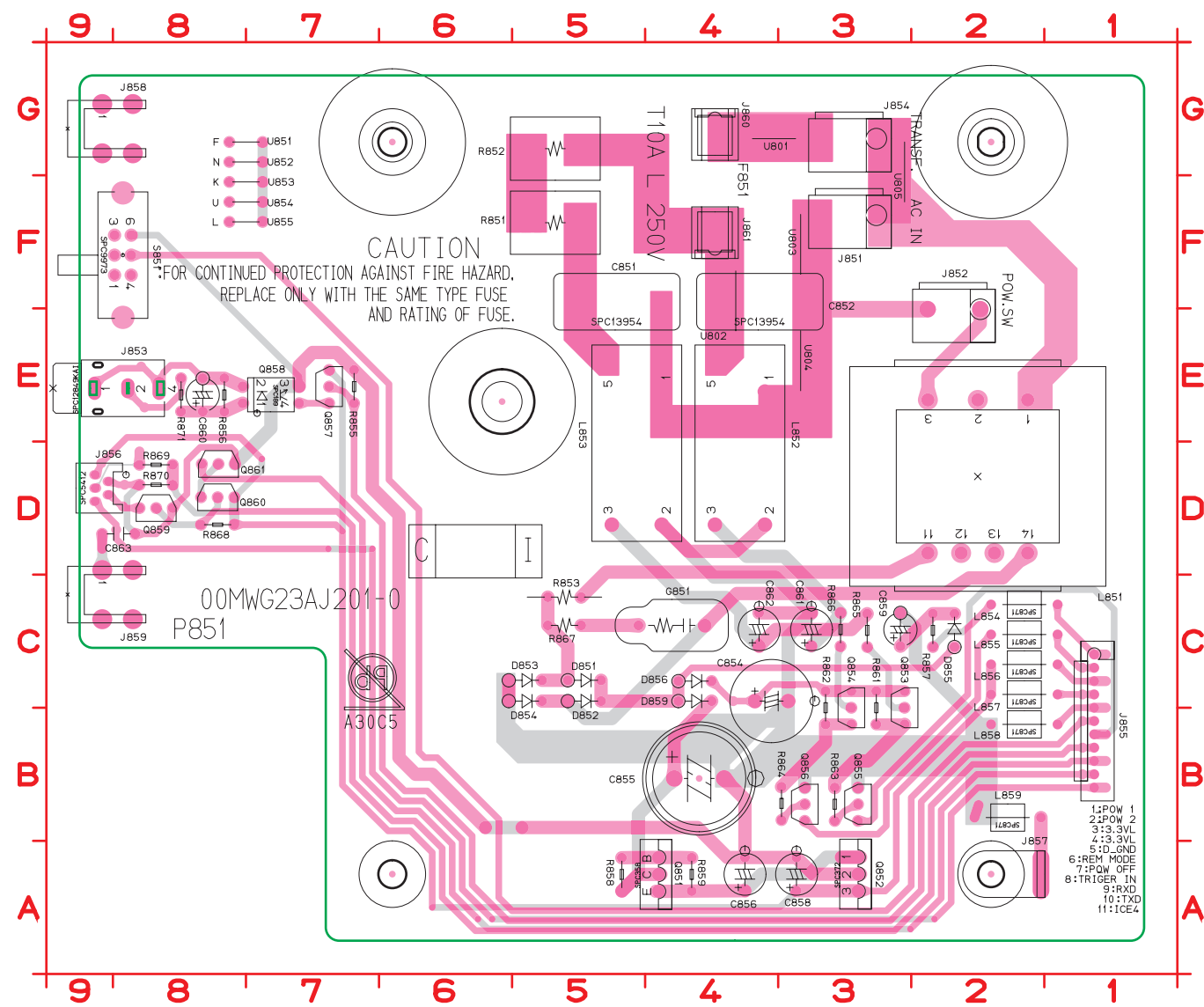

- | | | | |
|------|----|------|----|
| C851 | F4 | R852 | G5 |
| C852 | F3 | R853 | C5 |
| C854 | C4 | R855 | E7 |
| C855 | B4 | R856 | E8 |
| C856 | A4 | R857 | C2 |
| C858 | A3 | R858 | A5 |
| C859 | C3 | R859 | A4 |
| C860 | E8 | R861 | C3 |
| C861 | C3 | R862 | C3 |
| C862 | C4 | R863 | B3 |
| C863 | D8 | R864 | B3 |
| D851 | C5 | R865 | C3 |
| D852 | C5 | R866 | C3 |
| D853 | C6 | R867 | C5 |
| D854 | C6 | R868 | D8 |
| D855 | C2 | R869 | D8 |
| D856 | C4 | R870 | D8 |
| D859 | C4 | R871 | E8 |
| G851 | C5 | S851 | F8 |
| J851 | F3 | U801 | G3 |
| J852 | E2 | U802 | E4 |
| J853 | E9 | U803 | F3 |
| J854 | G3 | U804 | E3 |
| J855 | C1 | U805 | F3 |
| J856 | D9 | U851 | G7 |
| J857 | A2 | U852 | G7 |
| J858 | G9 | U853 | F7 |
| J859 | C9 | U854 | F7 |
| J860 | G4 | U855 | F7 |
| J861 | F4 | | |
| L851 | D2 | | |
| L852 | E4 | | |
| L853 | F4 | | |
| L854 | C2 | | |
| L855 | C2 | | |
| L856 | C2 | | |
| L857 | C2 | | |
| L858 | B2 | | |
| L859 | B2 | | |
| Q851 | A4 | | |
| Q852 | A3 | | |
| Q853 | C3 | | |
| Q854 | C3 | | |
| Q855 | B3 | | |
| Q856 | B3 | | |
| Q857 | E7 | | |
| Q858 | E8 | | |
| Q859 | D8 | | |
| Q860 | D8 | | |
| Q861 | D8 | | |
| R851 | F5 | | |

- | | |
|------|----|
| DN01 | B1 |
| DN02 | B2 |
| DN03 | A1 |
| DN04 | A2 |
| JN01 | A1 |
| RN01 | A1 |
| RN02 | A2 |
| RN03 | B1 |
| RN04 | B1 |
| RN05 | A1 |
| RN06 | A1 |
| RN07 | B1 |
| RN08 | B1 |

HDAM (PN01) A

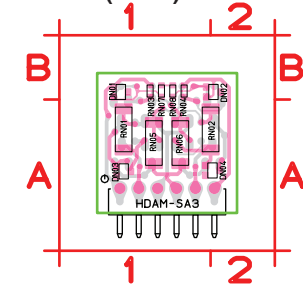

HDMI (PN01) B

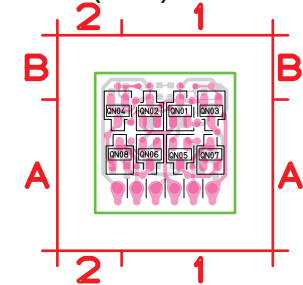

- | | |
|------|----|
| QN01 | A1 |
| QN02 | A1 |
| QN03 | A1 |
| QN04 | A2 |
| QN05 | A1 |
| QN06 | A1 |
| QN07 | A1 |
| QN08 | A2 |

鉛フリー半田
半田付けには、鉛フリー半田 (Sn-Ag-Cu) を使用してください。

Lead-free Solder
When soldering, use the Lead-free Solder (Sn-Ag-Cu).

10. EXPLODED VIEW AND PARTS LIST

SYMBOL	STYLE	PARTS NAME	MARK	MATERIAL/FINISH
5110		+B.H.M.SCREW	(M)	STEEL/COPPER
5126		+B.H.TAP TITE SCREW W/WASHER	(U)	STEEL/BLACK
5128		+B.H.TAP TITE SCREW(B TYPE)	(A)	STEEL/CHROMATE
5129		+B.H.TAP TITE SCREW(W/T.L.WASHER)		
5148		+B.H.M.SCREW(W/WASHER)		
5150		+F.H.TAP TITE SCREW(B TYPE)		
5159		+B.H.TAP TITE SCREW(S TYPE)		

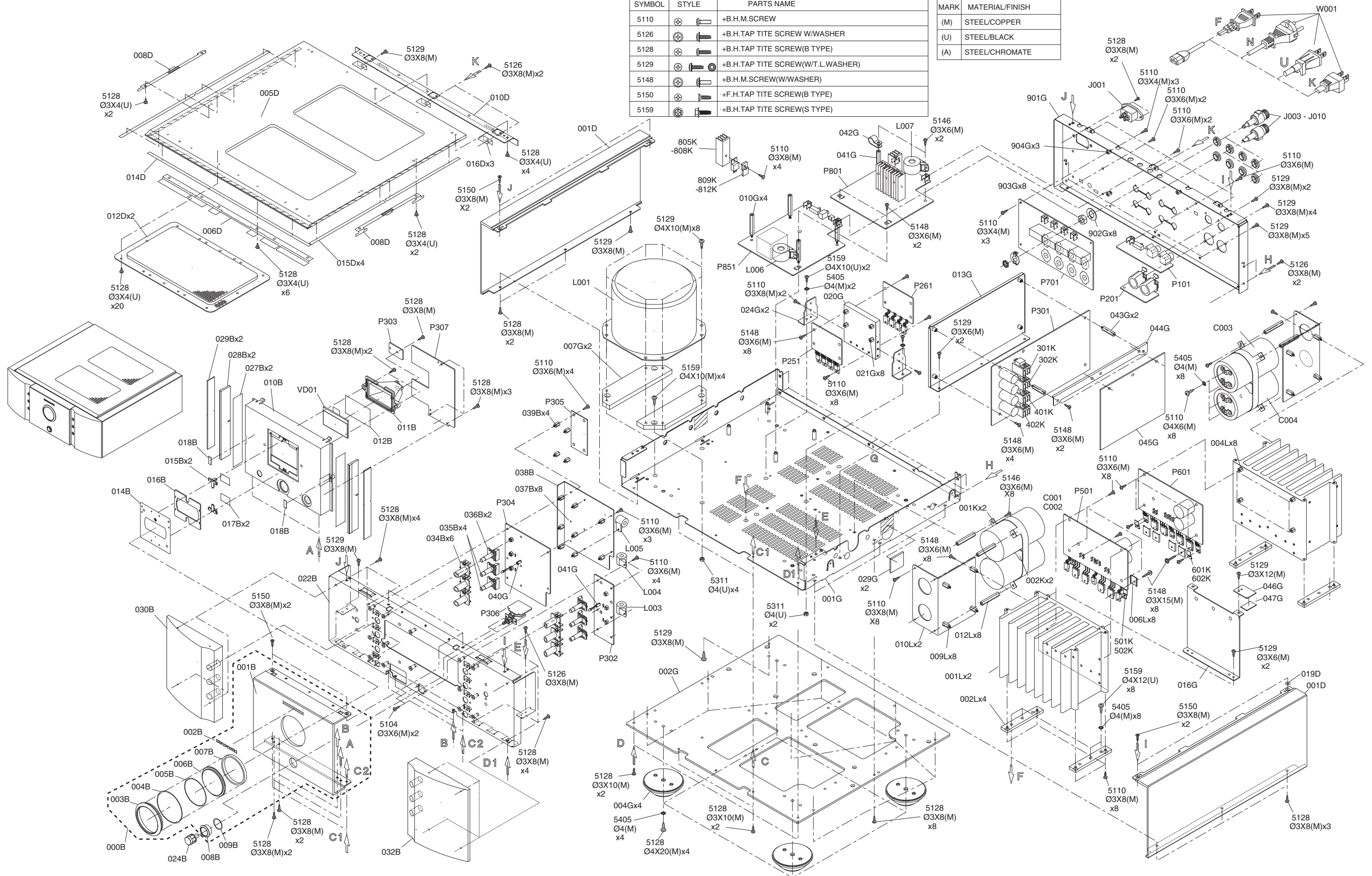

P.W.B. NAME	POS. NO.	VERS. COLOR	PART NO. (FOR EUR)	PART NO. (MZ)	PART NAME	DESCRIPTION
	000B	F N	nsp	99M23AJ248410	PANEL ASSY	FRONT AL PANEL ASSY SM-11S1 GOLD
	000B	/K1G	nsp	99M23AJ248410	PANEL ASSY	FRONT AL PANEL ASSY SM-11S1 GOLD
	000B	/N1G	99M23AJ248410	99M23AJ248410	PANEL ASSY	FRONT AL PANEL ASSY SM-11S1 GOLD
	000B	/N1S	99M23AJ248420	99M23AJ248420	PANEL ASSY	FRONT AL PANEL ASSY SM-11S1 SILVER
	000B	/U1G	nsp	99M23AJ248410	PANEL ASSY	FRONT AL PANEL ASSY SM-11S1 GOLD
	010B		00M04AJ105050	00M04AJ105050	CHASSIS	FRONT MOLD CHASSIS PM-11S1
	014B	F N	nsp	00M04AJ265120	INDICATOR	INDICATOR GOLD
	014B	/K1G	nsp	00M04AJ265120	INDICATOR	INDICATOR GOLD
	014B	/N1G	00M04AJ265120	00M04AJ265120	INDICATOR	INDICATOR GOLD
	014B	/N1S	00M04AJ265220	00M04AJ265220	INDICATOR	INDICATOR SILVER
	014B	/U1G	nsp	00M04AJ265120	-	INDICATOR GOLD
	015B		00M04AJ355010	00M04AJ355010	LENS	LENS-LCD ESCUTCHEON
	024B	F N	nsp	00M04AJ270110	BUTTON	POWER BUTTON GOLD
	024B	/K1G	nsp	00M04AJ270110	BUTTON	POWER BUTTON GOLD
	024B	/N1G	00M04AJ270110	00M04AJ270110	BUTTON	POWER BUTTON GOLD
	024B	/N1S	00M04AJ270210	00M04AJ270210	BUTTON	POWER BUTTON SILVER
	024B	/U1G	nsp	00M04AJ270110	BUTTON	POWER BUTTON GOLD
	028B		00M04AJ355030	00M04AJ355030	LENS	LENS SIDE
	030B	F N	nsp	00M23AJ063110	ESCUTCHEON	SIDE ESCUTCHEON L GOLD
	030B	/K1G	nsp	00M23AJ063110	ESCUTCHEON	SIDE ESCUTCHEON L GOLD
	030B	/N1G	00M23AJ063110	00M23AJ063110	ESCUTCHEON	SIDE ESCUTCHEON L GOLD
	030B	/N1S	00M23AJ063210	00M23AJ063210	ESCUTCHEON	SIDE ESCUTCHEON L SILVER
	030B	/U1G	nsp	00M23AJ063110	ESCUTCHEON	SIDE ESCUTCHEON L GOLD
	032B	F N	nsp	00M23AJ063120	ESCUTCHEON	SIDE ESCUTCHEON R GOLD
	032B	/K1G	nsp	00M23AJ063120	ESCUTCHEON	SIDE ESCUTCHEON R GOLD
	032B	/N1G	00M23AJ063120	00M23AJ063120	ESCUTCHEON	SIDE ESCUTCHEON R GOLD
	032B	/N1S	00M23AJ063220	00M23AJ063220	ESCUTCHEON	SIDE ESCUTCHEON R SILVER
	032B	/U1G	nsp	00M23AJ063120	ESCUTCHEON	SIDE ESCUTCHEON R GOLD
	034B	F N	nsp	00M04AJ259210	BUSHING	FUNCTION BUTTON BUSH GOLD
	034B	/K1G	nsp	00M04AJ259210	BUSHING	FUNCTION BUTTON BUSH GOLD
	034B	/N1G	00M04AJ259210	00M04AJ259210	BUSHING	FUNCTION BUTTON BUSH GOLD
	034B	/N1S	00M04AJ259110	00M04AJ259110	BUSHING	FUNCTION BUTTON BUSH SILVER
	034B	/U1G	nsp	00M04AJ259210	BUSHING	FUNCTION BUTTON BUSH GOLD
	035B	F N	nsp	00M04AJ270120	BUTTON	FUNCTION BUTTON LIGHTING GOLD
	035B	/K1G	nsp	00M04AJ270120	BUTTON	FUNCTION BUTTON LIGHTING GOLD
	035B	/N1G	00M04AJ270120	00M04AJ270120	BUTTON	FUNCTION BUTTON LIGHTING GOLD
	035B	/N1S	00M04AJ270220	00M04AJ270220	BUTTON	FUNCTION BUTTON LIGHTING SILVER
	035B	/U1G	nsp	00M04AJ270120	BUTTON	FUNCTION BUTTON LIGHTING GOLD
	036B	F N	nsp	00M04AJ270130	BUTTON	FUNCTION BUTTON GOLD
	036B	/K1G	nsp	00M04AJ270130	BUTTON	FUNCTION BUTTON GOLD
	036B	/N1G	00M04AJ270130	00M04AJ270130	BUTTON	FUNCTION BUTTON GOLD
	036B	/N1S	00M04AJ270230	00M04AJ270230	BUTTON	FUNCTION BUTTON SILVER
	036B	/U1G	nsp	00M04AJ270130	BUTTON	FUNCTION BUTTON GOLD
	001D	F N	nsp	00M04AJ249110	SIDE PANEL	SIDE PANEL GOLD
	001D	/K1G	nsp	00M04AJ249110	SIDE PANEL	SIDE PANEL GOLD
	001D	/N1G	00M04AJ249110	00M04AJ249110	SIDE PANEL	SIDE PANEL GOLD
	001D	/N1S	00M04AJ249210	00M04AJ249210	SIDE PANEL	SIDE PANEL SILVER
	001D	/U1G	nsp	00M04AJ249110	SIDE PANEL	SIDE PANEL GOLD
	005D	F N	nsp	00M21AJ257110	LID	TOP LID AL GOLD (HOLE TYPE)
	005D	/K1G	nsp	00M21AJ257110	LID	TOP LID AL GOLD (HOLE TYPE)
	005D	/N1G	00M21AJ257110	00M21AJ257110	LID	TOP LID AL GOLD (HOLE TYPE)
	005D	/N1S	00M21AJ257210	00M21AJ257210	LID	TOP LID AL SILVER (HOLE TYPE)
	005D	/U1G	nsp	00M21AJ257110	LID	TOP LID AL GOLD (HOLE TYPE)
	012D	F N	nsp	00M21AJ003110	PERFORATED	PERFORATED-TOP LID GOLD
	012D	/K1G	nsp	00M21AJ003110	PERFORATED	PERFORATED-TOP LID GOLD
	012D	/N1G	00M21AJ003110	00M21AJ003110	PERFORATED	PERFORATED-TOP LID GOLD
	012D	/N1S	00M21AJ003210	00M21AJ003210	PERFORATED	PERFORATED-TOP LID SILVER
	012D	/U1G	nsp	00M21AJ003110	PERFORATED	PERFORATED-TOP LID GOLD
	004G	F N	nsp	00M04AJ057510	LUG EYELET	LEGS GOLD
	004G	/K1G	nsp	00M04AJ057510	LUG EYELET	LEGS GOLD
	004G	/N1G	00M04AJ057510	00M04AJ057510	LUG EYELET	LEGS GOLD
	004G	/N1S	00M04AJ057520	00M04AJ057520	LUG EYELET	LEGS SILVER
	004G	/U1G	nsp	00M04AJ057510	LUG EYELET	LEGS GOLD
	C001		00MOB15907130	00MOB15907130	ELECT. CAP.	15000UF 71V LKGH2153MSGRZT
	C002		00MOB15907130	00MOB15907130	ELECT. CAP.	15000UF 71V LKGH2153MSGRZT
	C003		00MOB15907130	00MOB15907130	ELECT. CAP.	15000UF 71V LKGH2153MSGRZT
	C004		00MOB15907130	00MOB15907130	ELECT. CAP.	15000UF 71V LKGH2153MSGRZT

NOTE : "nsp" PART IS LISTED FOR REFERENCE ONLY, MARANTZ WILL NOT SUPPLY THESE PARTS.

P.W.B. NAME	POS. NO.	VERS. COLOR	PART NO. (FOR EUR)	PART NO. (MZ)	PART NAME	DESCRIPTION
	▲ J001		00MYJ04002640	00MYJ04002640	JACK	! R-301(21) AC INLET
	J003		00MYT01010360	00MYT01010360	TERMINAL	WBT-0765 POLE TERMINAL RED
	J004		00MYT01010370	00MYT01010370	TERMINAL	WBT-0765 POLE TERMINAL WHT
	J005		00MYT01010360	00MYT01010360	TERMINAL	WBT-0765 POLE TERMINAL RED
	J006		00MYT01010370	00MYT01010370	TERMINAL	WBT-0765 POLE TERMINAL WHT
	J007		00MYT01010360	00MYT01010360	TERMINAL	WBT-0765 POLE TERMINAL RED
	J008		00MYT01010370	00MYT01010370	TERMINAL	WBT-0765 POLE TERMINAL WHT
	J009		00MYT01010360	00MYT01010360	TERMINAL	WBT-0765 POLE TERMINAL RED
	J010		00MYT01010370	00MYT01010370	TERMINAL	WBT-0765 POLE TERMINAL WHT
	▲ L001	F N	nsp	00MTS45001160	TRANSF.	# POWER TRANSF. FOR 100V
	▲ L001	/K1G	nsp	00MTS45001170	TRANSF.	# POWER TRANSF. FOR 230V
	▲ L001	/N1G	00MTS45001170	00MTS45001170	TRANSF.	# POWER TRANSF. FOR 230V
	▲ L001	/N1S	00MTS45001170	00MTS45001170	TRANSF.	# POWER TRANSF. FOR 230V
	▲ L001	/U1G	nsp	00MTS45001180	TRANSF.	# POWER TRANSF. FOR 120V
	L003		00MFC50160030	00MFC50160030	FERRITE CORE	FERRITE CORE TFCK-16813
	L004		00MFC50160030	00MFC50160030	FERRITE CORE	FERRITE CORE TFCK-16813
	L005		00MFC50160030	00MFC50160030	FERRITE CORE	FERRITE CORE TFCK-16813
	L006		00MFC50160030	00MFC50160030	FERRITE CORE	FERRITE CORE TFCK-16813
	L007		00MFC50160030	00MFC50160030	FERRITE CORE	FERRITE CORE TFCK-16813
	P101		nsp	nsp	PWB ASSY	CINCH PIN JACK PWB ASSY
	P201		nsp	nsp	PWB ASSY	BALANCE INPUT PWB ASSY
	P251		nsp	nsp	PWB ASSY	BRIDGE L PWB ASSY
	P261		nsp	nsp	PWB ASSY	BRIDGE R PWB ASSY
	P301		nsp	nsp	PWB ASSY	PRE AMP PWB
	P302		nsp	nsp	PWB ASSY	RIGHT PWB ASSY
	P303		nsp	nsp	PWB ASSY	BACK LIGHT PWB ASSY
	P304		nsp	nsp	PWB ASSY	LEFT PWB ASSY
	P305		nsp	nsp	PWB ASSY	CONNECTOR PWB ASSY
	P306		nsp	nsp	PWB ASSY	POWER SW ASSY
	P307		nsp	nsp	PWB ASSY	FRONT PWB ASSY
	P501		nsp	nsp	PWB ASSY	POWER AMP L PWB ASSY
	P581		nsp	nsp	PWB ASSY	POSISTOR L PWB ASSY
	P601		nsp	nsp	PWB ASSY	POWER AMP R PWB
	P681		nsp	nsp	PWB ASSY	POSISTOR R PWB ASSY
	P701		nsp	nsp	PWB ASSY	SPK. TERMINAL PWB ASSY
	P801		nsp	nsp	PWB ASSY	POWER SUPPLY PWB ASSY
	P851		nsp	nsp	PWB ASSY	AC INPUT PWB ASSY
	VD01		00MHQ22901990	00MHQ22901990	DISPLAY	LCD MODULE FOR PM-11S1
	W032		nsp	00MYU17550520	FPC	SML2SC17(1)X542BDX6(BL)-P1.0-S4-M-N(35)
PACKING						
	001T	F N	nsp	00M23AJ851110	USER GUIDE	USER GUIDE F
	001T	/K1G	nsp	00M23AJ851350	USER GUIDE	USER GUIDE K
	001T	/N1G	00M23AJ851310	00M23AJ851310	USER GUIDE	USER GUIDE N
	001T	/N1S	00M23AJ851310	00M23AJ851310	USER GUIDE	USER GUIDE N
	001T	/U1G	nsp	00M23AJ851310	USER GUIDE	USER GUIDE N
	▲ W001	F N	nsp	00D2062141002	MAINS CORD	# MAINS CORD W/CON&PLUG
	▲ W001	/K1G	nsp	00MZC01808030	MAINS CORD	# MAINS CORD CHINA 250V 10A
	▲ W001	/N1G	00MZC01803080	00MZC01803080	MAINS CORD	# 2P MAINS CORD 10A 250V CLASS2
	▲ W001	/N1S	00MZC01803080	00MZC01803080	MAINS CORD	# 2P MAINS CORD 10A 250V CLASS2
	▲ W001	/U1G	nsp	00MZC01802100	MAINS CORD	# MAINS CORDSET 125V13A UL/CSA
NOT STANDARD SPARE PART						
	001S		nsp	00M23AJ801010	PACKING CASE	PACKING CASE
	002S	/N1G	nsp	00M23AJ805010	MASS CARTON	MASTER CARTON
	002S	/N1S	nsp	00M23AJ805010	MASS CARTON	MASTER CARTON
	003S		nsp	00M23AJ809010	CUSHION	CUSHION L
	004S		nsp	00M23AJ809020	CUSHION	CUSHION R

NOTE : "nsp" PART IS LISTED FOR REFERENCE ONLY, MARANTZ WILL NOT SUPPLY THESE PARTS.

11. MICROPROCESSOR AND IC DATA

P307 / QU01 : HD64F3687H

Pin	PORT	SIGNAL NAME	I/O	Function	Description
1	PB6_AN6	AD2	I	Analog KEY information	
2	PB7_AN7	AD1	I	Model select	
3	AVcc	AVCC	I	Analog power supply	
4	X2	X2	O	Sub clock output	
5	X1	X1	I	Sub clock input	32.758kHz
6	VCL	VC1	I	Internal step-down power supply	
7	/RES	RES	I	Reset pin	
8	TEST	TEST	I	Test Pin	Connect to GND
9	Vss	GND	I	GND	
10	OSC2	OSC2	O	Main clock output	
11	OSC1	OSC1	I	Main clock input	8MHz
12	Vcc	VCC	I	+3.3V Power supply	
13	P50_/WKP0	Reserved	-		External trigger
14	P51_/WKP1	Reserved	-		External trigger
15	P34	Reserved	-		
16	P35	Reserved	-		
17	P36	Reserved	-		
18	P37	Reserved	-		
19	P52_/WKP2	Reserved	-		External trigger
20	P53_/WKP3	Reserved	-		External trigger
21	P54_/WKP4	TRIGER_IN	I	DC Triger Input	External trigger(Active H)
22	P55_/WKP5_/ADTRG	AD_INT	I	Analog KEY information, Change detection	External trigger(Active L)
23	P10_TMOW	Reserved	-		
24	P11_PWM	POW_ON_2	O	Power ON Control	H/L = POW_ON/POW_OFF
25	P12	POW_ON_1	O	Power ON Control	H/L = POW_ON/POW_OFF
26	P56_SDA	SDA	I/O	EEPROM (AT24C04) Serial-Data	I2C_DATA
27	P57_SCL	SCL	O	EEPROM (AT24C04) Serial-Clock	I2C_CLOCK
28	P74_TMRIV	FLG_R[0]	I		
29	P75_TMCIV	FLG_R[1]	I		
30	P76_TMOV	FLG_L[0]	I		
31	P24	FLG_L[1]	I		
32	P63_FTIOD0	L_DATA	O	LCD-Controler(SPLC093C)Serial DATA OUT	
33	P62_FTIOC0	BL_ON	O	LCD back light ON/OFF	H/L = ON/OFF
34	P61_FTIOB0	STANDBY_ON	O	STANDBY LED ON	H/L = ID0,ID1/ID2,ID3
35	/NMI	ICE4	I	ICE connect pin	ICE brake control
36	P60_FTIOA0	S_CLK	O	LED+INPUT SELECTOER control, Serial-Interface Clock	
37	P64_FTIOA1	S_CE	O	LED+INPUT SELECTOER control, Serial-Interface CS	Active L
38	P65_FTIOB1	S_DATA	O	LED+INPUT SELECTOER control, Serial-Interface Data	
39	P66_FTIOC1	LCD_POWER1	O	LCD module power supply ON/OFF control (+3.3VL)	H/L = ON/OFF
40	P67_FTIOD1	LCD_POWER2	O	LCD module power supply ON/OFF control (+12V)	H/L = ON/OFF
41	P85	ICE1	-	ICE connect pin	
42	P86	ICE2	-	ICE connect pin	
43	P87	ICE3	-	ICE connect pin	
44	P20_SCK3	S_OE	O	LED+INPUT SELECTOER control, Serial-Interface OE	Active H
45	P21_RXD	RXD	I	SYSTEM Control bus input	
46	P22_TXD	TXD	O	SYSTEM Control bus output	
47	P23	TRIG_MODE	I	DC Triger INT/EXT	H/L = EXT/INT
48	P70_SCK3-2	CLKOUT	I		
49	P71_RXD-2	SDOUT	I		
50	P72_TXD-2	PLDRST	O	CPLD reset	
51	P14_/IRQ0	Reserved	-		
52	P15_/IRQ1_TMIB1	P_DOWN	I	Power down detect	External trigger(Active H)

P307 / QU01 : HD64F3687H

Pin	PORT	SIGNAL NAME	I/O	Function	Description
53	P16 /IRQ2	PROT_2	I	Power supply error detect	Active L(POW_OFF)
54	P17 /IRQ3_TRGV	PROT_1	I	DC/over current/Temp detect	Active L(Mute)
55	P33	L_CS	O	LCD-Controler(SPLC093C) CE	Active L
56	P32	L_SCL	O	LCD-Controler(SPLC093C) Serial CLOCK OUT	
57	P31	L_RS	O	LCD-Controler(SPLC093C) REGISTER SELECT	H/L = Data/Instruction
58	P30	L_RES	O	LCD-Controler(SPLC093C) RESET	Active L(Reset)
59	PB3_AN3	TEST_1	I	PWB mode setting 1	Port check
60	PB2_AN2	TEST_2	I	PWB mode setting 2	Port check
61	PB1_AN1	D-SET	I	LCD-Controler mode setting	H/L 100msec, each time
62	PB0_AN0	AD3	I	Analog KEY information	
63	PB4_AN4	POW_OFF	I	The Sub Transe ON/OFF detec	H/L = ON/OFF
64	PB5_AN5	BTL	I	BTL/Stereo select	H/L = BTL/Stereo

P304 / QP01 : EPM570T144C5

Pin	Port	Port name	IO	Note
1	IO	nc	nc	
2	IO	nc	nc	
3	IO	nc	nc	
4	IO	nc	nc	
5	IO	nc	nc	
6	IO	nc	nc	
7	IO	nc	nc	
8	IO	nc	nc	
9	VCCio1	+3.3V	Vcc	
10	GNDio	GND	Gnd	
11	IO	nc	nc	
12	IO	nc	nc	
13	IO	nc	nc	
14	IO	nc	nc	
15	IO	SDA1	in	
16	IO	SDA2	in	
17	GNDint	GND	Gnd	
18	IO	GCLK0	SCL	in
19	VCCint	+3.3V	Vcc	
20	IO	GCLK1	SWS	in
21	IO	AD_PD	out	
22	IO	nc	nc	
23	IO	nc	nc	
24	IO	nc	nc	
25	VCCio1	+3.3V	Vcc	
26	GNDio	GND	Gnd	
27	IO	nc	nc	
28	IO	nc	nc	
29	IO	nc	nc	
30	IO	nc	nc	
31	IO	nc	nc	
32	IO	nc	nc	
33	TMS	TMS	in	
34	TDI	TDI	in	
35	TCK	TCK	in	
36	TDO	TDO	out	
37	IO	SDOUT	out	
38	IO	CLKOUT	out	
39	IO	PLDRST	in	
40	IO	nc	nc	

Pin	Port	Port name	IO	Note
41	IO	nc	nc	
42	IO	nc	nc	
43	IO	nc	nc	
44	IO	nc	nc	
45	IO	nc	nc	
46	VCCio1	+3.3V	Vcc	
47	GNDio	GND	Gnd	
48	IO	nc	nc	
49	IO	nc	nc	
50	IO	nc	nc	
51	IO	nc	nc	
52	IO	nc	nc	
53	IO	nc	nc	
54	GNDint	GND	Gnd	
55	IO	nc	nc	
56	VCCint	+3.3V	Vcc	
57	IO	nc	nc	
58	IO	nc	nc	
59	IO	nc	nc	
60	IO	DEV_OE	nc	nc
61	IO	DEV_CLRn	nc	nc
62	IO	nc	nc	
63	IO	nc	nc	
64	VCCio1	+3.3V	Vcc	
65	GNDio	GND	Gnd	
66	IO	nc	nc	
67	IO	nc	nc	
68	IO	nc	nc	
69	IO	nc	nc	
70	IO	nc	nc	
71	IO	nc	nc	
72	IO	nc	nc	
73	IO	nc	nc	
74	IO	nc	nc	
75	IO	nc	nc	
76	IO	nc	nc	
77	IO	nc	nc	
78	IO	nc	nc	
79	IO	nc	nc	
80	IO	nc	nc	

P304 / QP01 : EPM570T144C5

Pin	Port	Port name	IO	Note
81	IO	nc	nc	
82	VCCio2	+3.3V	Vcc	
83	GNDio	GND	Gnd	
84	IO	nc	nc	
85	IO	nc	nc	
86	IO	nc	nc	
87	IO	nc	nc	
88	IO	ISWSOUT	out	
89	IO	ISWS	in	
90	VCCint	+3.3V	Vcc	
91	IO	nc	nc	
92	GNDint	GND	Gnd	
93	IO	nc	nc	
94	IO	nc	nc	
95	IO	nc	nc	
96	IO	nc	nc	
97	IO	nc	nc	
98	IO	nc	nc	
99	GNDio	GND	Gnd	
100	VCCio2	+3.3V	Vcc	
101	IO	nc	nc	
102	IO	nc	nc	
103	IO	nc	nc	
104	IO	nc	nc	
105	IO	nc	nc	
106	IO	nc	nc	
107	IO	nc	nc	
108	IO	nc	nc	
109	IO	nc	nc	
110	IO	nc	nc	
111	IO	nc	nc	
112	IO	nc	nc	

Pin	Port	Port name	IO	Note
113	IO	nc	nc	
114	IO	nc	nc	
115	GNDio	GND	Gnd	
116	VCCio2	+3.3V	Vcc	
117	IO	nc	nc	
118	IO	nc	nc	
119	IO	nc	nc	
120	IO	nc	nc	
121	IO	nc	nc	
122	IO	nc	nc	
123	IO	nc	nc	
124	IO	nc	nc	
125	IO	nc	nc	
126	VCCint	+3.3V	Vcc	
127	IO	nc	nc	
128	GNDint	GND	Gnd	
129	IO	nc	nc	
130	IO	nc	nc	
131	IO	nc	nc	
132	IO	nc	nc	
133	IO	nc	nc	
134	IO	nc	nc	
135	GNDio	GND	Gnd	
136	VCCio2	+3.3V	Vcc	
137	IO	nc	nc	
138	IO	nc	nc	
139	IO	nc	nc	
140	IO	nc	nc	
141	IO	nc	nc	
142	IO	nc	nc	
143	IO	nc	nc	
144	IO	nc	nc	

FEATURES

- 4-Channel $\Delta\Sigma$ ADC
- Differential Inputs
- Digital HPF for DC-Offset Cancel
- S/(N+D): 100dB@5V for 48kHz
- DR: 107dB@5V for 48kHz
- S/N: 107dB@5V for 48kHz
- Sampling Rate Ranging from 8kHz to 96kHz
- Master Clock:
 - 256fs/384fs/512fs/768fs (~ 48kHz)
 - 256fs/384fs (~ 96kHz)
- TTL Digital Input Level
- Output format: 24bit MSB justified, I²S or TDM
- Cascade TDM Interface
- Master & Slave Mode
- Overflow Flag
- Power Supply: 4.75 to 5.25V
- Power Supply for output buffer: 3.0 to 5.25V
- Ta = -40 ~ 85°C
- 28pin VSOP

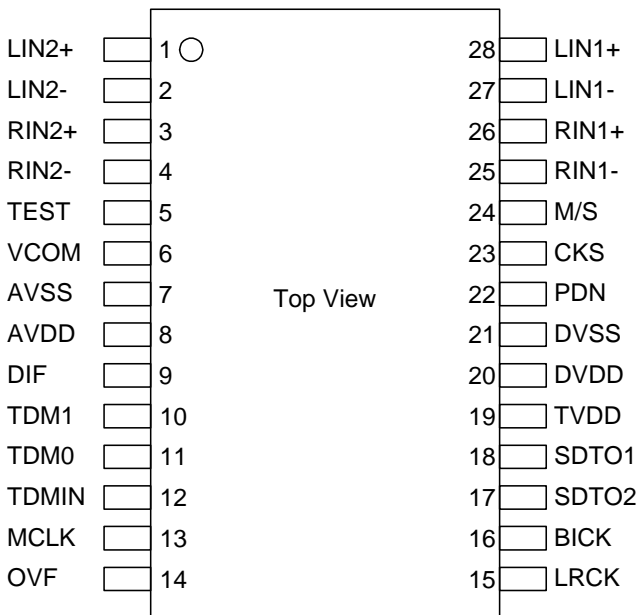
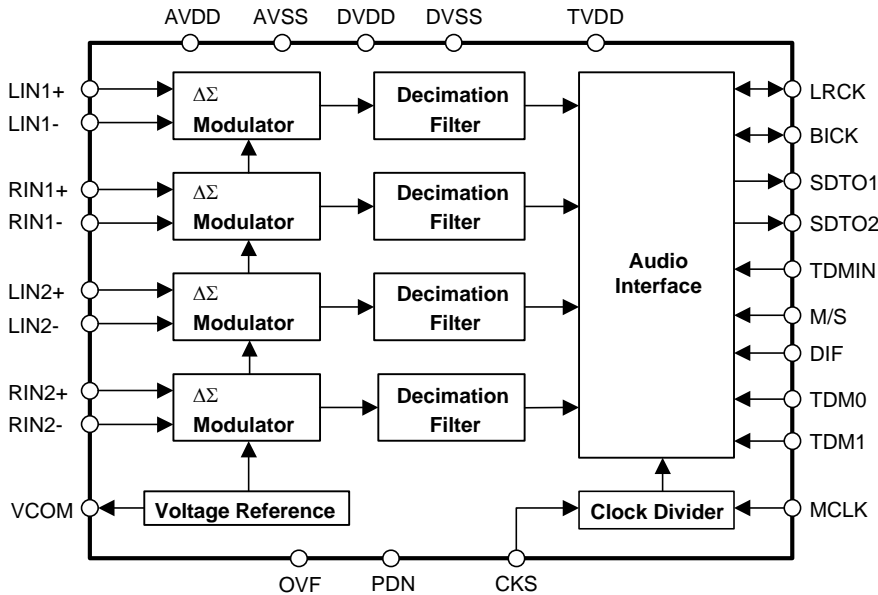

No.	Pin Name	I/O	Function
1	LIN2+	I	ADC2 Lch Positive Analog Input Pin
2	LIN2-	I	ADC2 Lch Negative Analog Input Pin
3	RIN2+	I	ADC2 Rch Positive Analog Input Pin
4	RIN2-	I	ADC2 Rch Negative Analog Input Pin
5	TEST	I	Test Pin (Connected to AVSS)
6	VCOM	O	Common Voltage Output Pin, AVDD/2 Normally connected to AVSS with a 0.1 μ F ceramic capacitor in parallel with an electrolytic capacitor less than 2.2 μ F.
7	AVSS	-	Analog Ground Pin
8	AVDD	-	Analog Power Supply Pin, 4.75 ~ 5.25V
9	DIF	I	Audio Interface Format Pin "L" : 24bit MSB justified, "H" : 24bit I ² S Compatible
10	TDM1	I	TDM I/F BICK Frequency Select Pin "L" : 256fs, "H" : 128fs
11	TDM0	I	TDM I/F Format Enable Pin "L" : Normal Mode, "H" : TDM Mode
12	TDMIN	I	TDM Data Input Pin
13	MCLK	I	Master Clock Input Pin
14	OVF	O	Analog Input Overflow Detect Pin This pin goes to "H" if one of four analog inputs overflows.
15	LRCK	I/O	Output Channel Clock Pin "L" Output in Master Mode at Power-down mode.
16	BICK	I/O	Audio Serial Data Clock Pin "L" Output in Master Mode at Power-down mode.
17	SDTO2	O	ADC2 Audio Serial Data Output Pin "L" Output at Power-down mode.
18	SDTO1	O	ADC1 Audio Serial Data Output Pin "L" Output at Power-down mode.
19	TVDD	-	Output Buffer Power Supply Pin, 3.0 ~ 5.25V
20	DVDD	-	Digital Power Supply Pin, 4.75 ~ 5.25V
21	DVSS	-	Digital Ground Pin
22	PDN	I	Power-Down Mode Pin When "L", the circuit is in power-down mode. The AK5384 should always be reset upon power-up.
23	CKS	I	Master Clock Select Pin "L" : 256fs, "H" : 512fs This pin is enabled in Master Mode.
24	M/S	I	Master / Slave Mode Pin "L" : Slave Mode, "H" : Master Mode
25	RIN1-	I	ADC1 Rch Negative Analog Input Pin
26	RIN1+	I	ADC1 Rch Positive Analog Input Pin
27	LIN1-	I	ADC1 Lch Negative Analog Input Pin
28	LIN1+	I	ADC1 Lch Positive Analog Input Pin

Note: All digital input pins should not be left floating.

P307 / QU02 : AT24C08A

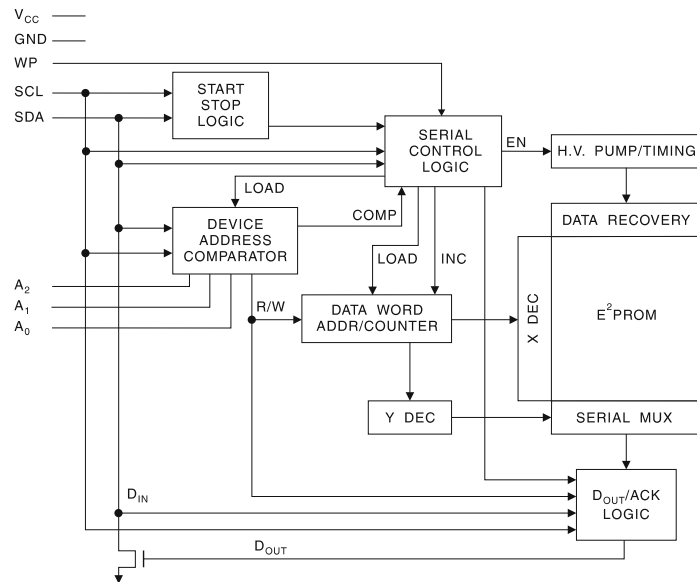
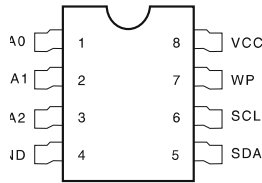

P307 / QU03, QU04 : 74HC4094

QU03 : 74HC4094

Pin	Port	I/O	Name	Function	Description
1	CE	IN	STROBE		
2	DATA	IN	DATA		
3	CLK	IN			
4	Q1	OUT			
5	Q2	OUT			
6	Q3	OUT	SPK_1	Speaker output relay ON	Active H
7	Q4	OUT	SPK_2	Speaker output relay ON	Active H
8	GND		GND		
9	QS	OUT			
10	Q'S	OUT			
11	Q8	OUT	0dB	*1	*1
12	Q7	OUT	+6dB	*1	*1
13	Q6	OUT			
14	Q5	OUT	BAL_L	Balanced input relay ON	Active H
15	OE	IN	OUTPUT ENABLE		
16	VCC		VCC		

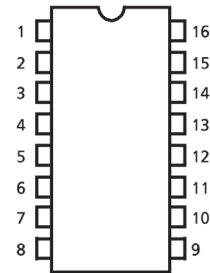

*1 Gain adjustment relay function

	0dB(11pin)	6dB(12pin)
-6dB	L	L
0dB	H	L
+6dB	L	H

QU04 : 74HC4094

Pin	Port	I/O	Name	Function	Description
1	CE	IN	STROBE		
2	DATA	IN	DATA		
3	CLK	IN			
4	Q1	OUT	BAL	Balanced Input LED ON	Active H
5	Q2	OUT	UN-BAL	Unbalanced Input LED ON	Active H
6	Q3	OUT	SP2	Speaker output LED ON	Active H
7	Q4	OUT			
8	GND		GND		
9	QS	OUT			
10	Q'S	OUT			
11	Q8	OUT			
12	Q7	OUT	DISP_ON	Side illuminations LED ON	Active H
13	Q6	OUT	SP1	Speaker output LED ON	Active H
14	Q5	OUT			
15	OE	IN	OUTPUT ENABLE		
16	VCC		VCC		

P.W.B. NAME	POS. NO.	VERS. COLOR	PART NO. (FOR EUR)	PART NO. (MZ)	PART NAME	DESCRIPTION
CINCH PIN JACK PWB P101 (00MWG23AJ104-)						
P101	C101	/K1G	nsp	00MOF56331540	FILM CAP.	STAR(126)100VDC331J7-10
P101	C101	/N1G	00MOF56331540	00MOF56331540	FILM CAP.	STAR(126)100VDC331J7-10
P101	C101	/N1S	00MOF56331540	00MOF56331540	FILM CAP.	STAR(126)100VDC331J7-10
P101	C102	/K1G	nsp	00MOF56331540	FILM CAP.	STAR(126)100VDC331J7-10
P101	C102	/N1G	00MOF56331540	00MOF56331540	FILM CAP.	STAR(126)100VDC331J7-10
P101	C102	/N1S	00MOF56331540	00MOF56331540	FILM CAP.	STAR(126)100VDC331J7-10
P101	J101		00MYT02011000	00MYT02011000	TERMINAL	1P CINCH PIN JACK T6782-AAAB
P101	J102		00MYT02011000	00MYT02011000	TERMINAL	1P CINCH PIN JACK T6782-AAAB
P101	S101		00MSS02021620	00MSS02021620	SLIDE SW	SSSU121700
BALANCE INPUT PWB P201 (00MWG23AJ105-)						
P201	C201	/K1G	nsp	00MOF56331540	FILM CAP.	STAR(126)100VDC331J7-10
P201	C201	/N1G	00MOF56331540	00MOF56331540	FILM CAP.	STAR(126)100VDC331J7-10
P201	C201	/N1S	00MOF56331540	00MOF56331540	FILM CAP.	STAR(126)100VDC331J7-10
P201	C202	/K1G	nsp	00MOF56331540	FILM CAP.	STAR(126)100VDC331J7-10
P201	C202	/N1G	00MOF56331540	00MOF56331540	FILM CAP.	STAR(126)100VDC331J7-10
P201	C202	/N1S	00MOF56331540	00MOF56331540	FILM CAP.	STAR(126)100VDC331J7-10
P201	J201		00MYJ01004340	00MYJ01004340	JACK	NC3FAH2 4P CANON TYPE
P201	J202		00MYJ01004340	00MYJ01004340	JACK	NC3FAH2 4P CANON TYPE
BRIDGE L PWB P251 (00MWG23AJ204-)						
P251	D251		00MHE10005100	00MHE10005100	DIODE	SBD UNIT FCH20A15 TO-220
P251	D252		00MHE10006100	00MHE10006100	DIODE	SBD UNIT FRH20A15 TO-220
P251	D253		00MHE10005100	00MHE10005100	DIODE	SBD UNIT FCH20A15 TO-220
P251	D254		00MHE10006100	00MHE10006100	DIODE	SBD UNIT FRH20A15 TO-220
P251	▲ G251		00MBF68400010	00MBF68400010	CAP.COMP.	! 0.68UF/4.7OHM
P251	▲ G252		00MBF68400010	00MBF68400010	CAP.COMP.	! 0.68UF/4.7OHM
BRIDGE R PWB P261 (00MWG23AJ205-)						
P261	D261		00MHE10005100	00MHE10005100	DIODE	SBD UNIT FCH20A15 TO-220
P261	D262		00MHE10006100	00MHE10006100	DIODE	SBD UNIT FRH20A15 TO-220
P261	D263		00MHE10005100	00MHE10005100	DIODE	SBD UNIT FCH20A15 TO-220
P261	D264		00MHE10006100	00MHE10006100	DIODE	SBD UNIT FRH20A15 TO-220
P261	▲ G261		00MBF68400010	00MBF68400010	CAP.COMP.	! 0.68UF/4.7OHM
P261	▲ G262		00MBF68400010	00MBF68400010	CAP.COMP.	! 0.68UF/4.7OHM
PRE AMP PWB P301 (00MWG23AJ101-)						
P301	C301		nsp	00MOA226025Z0	ELECT. CAP.	ROS-25V 220M - F3#PE - T2 (22UF 25V)
P301	C302		nsp	00MOA226025Z0	ELECT. CAP.	ROS-25V 220M - F3#PE - T2 (22UF 25V)
P301	C303		nsp	00MOA226025Z0	ELECT. CAP.	ROS-25V 220M - F3#PE - T2 (22UF 25V)
P301	C304		nsp	00MOA226025Z0	ELECT. CAP.	ROS-25V 220M - F3#PE - T2 (22UF 25V)
P301	C305		nsp	00MOA226025Z0	ELECT. CAP.	ROS-25V 220M - F3#PE - T2 (22UF 25V)
P301	C306		nsp	00MOA226025Z0	ELECT. CAP.	ROS-25V 220M - F3#PE - T2 (22UF 25V)
P301	C307		nsp	00MOA227025Z0	ELECT. CAP.	ROS-25V 221M - I5#PE - S13 (220UF 25V)
P301	C308		nsp	00MOA227025Z0	ELECT. CAP.	ROS-25V 221M - I5#PE - S13 (220UF 25V)
P301	C311		nsp	00MOA227025Z0	ELECT. CAP.	ROS-25V 221M - I5#PE - S13 (220UF 25V)
P301	C312		nsp	00MOA227025Z0	ELECT. CAP.	ROS-25V 221M - I5#PE - S13 (220UF 25V)
P301	C313		nsp	00MOA476025Z0	ELECT. CAP.	ROS-25V 470M - G3#PE - T2 (47UF 25V)
P301	C314		00MOF56331540	00MOF56331540	FILM CAP.	STAR(126)100VDC331J7-10
P301	C315		nsp	00MOA107025Z0	ELECT. CAP.	ROS-25V 101M - H4#PE - T2 (100UF 25V)
P301	C316		nsp	00MOA107025Z0	ELECT. CAP.	ROS-25V 101M - H4#PE - T2 (100UF 25V)
P301	C317		nsp	00MOA227050Z0	ELECT. CAP.	ROS-50V 221M - J6#PE - S1 (220UF 50V)
P301	C318		nsp	00MOA227050Z0	ELECT. CAP.	ROS-50V 221M - J6#PE - S1 (220UF 50V)
P301	C319		00MOF56331540	00MOF56331540	FILM CAP.	STAR(126)100VDC331J7-10
P301	C320		00MOF56331540	00MOF56331540	FILM CAP.	STAR(126)100VDC331J7-10
P301	C321		00MOF56331540	00MOF56331540	FILM CAP.	STAR(126)100VDC331J7-10
P301	C323		00MOF55220560	00MOF55220560	FILM CAP.	DAMG 22PF 630V
P301	C324		00MOF55220560	00MOF55220560	FILM CAP.	DAMG 22PF 630V
P301	C401		nsp	00MOA226025Z0	ELECT. CAP.	ROS-25V 220M - F3#PE - T2 (22UF 25V)
P301	C402		nsp	00MOA226025Z0	ELECT. CAP.	ROS-25V 220M - F3#PE - T2 (22UF 25V)
P301	C403		nsp	00MOA226025Z0	ELECT. CAP.	ROS-25V 220M - F3#PE - T2 (22UF 25V)
P301	C404		nsp	00MOA226025Z0	ELECT. CAP.	ROS-25V 220M - F3#PE - T2 (22UF 25V)
P301	C405		nsp	00MOA226025Z0	ELECT. CAP.	ROS-25V 220M - F3#PE - T2 (22UF 25V)
P301	C406		nsp	00MOA226025Z0	ELECT. CAP.	ROS-25V 220M - F3#PE - T2 (22UF 25V)
P301	C407		nsp	00MOA227025Z0	ELECT. CAP.	ROS-25V 221M - I5#PE - S13 (220UF 25V)
P301	C408		nsp	00MOA227025Z0	ELECT. CAP.	ROS-25V 221M - I5#PE - S13 (220UF 25V)
P301	C411		nsp	00MOA227025Z0	ELECT. CAP.	ROS-25V 221M - I5#PE - S13 (220UF 25V)
P301	C412		nsp	00MOA227025Z0	ELECT. CAP.	ROS-25V 221M - I5#PE - S13 (220UF 25V)
P301	C413		nsp	00MOA476025Z0	ELECT. CAP.	ROS-25V 470M - G3#PE - T2 (47UF 25V)
P301	C414		00MOF56331540	00MOF56331540	FILM CAP.	STAR(126)100VDC331J7-10

NOTE : "nsp" PART IS LISTED FOR REFERENCE ONLY, MARANTZ WILL NOT SUPPLY THESE PARTS.

P.W.B. NAME	POS. NO.	VERS. COLOR	PART NO. (FOR EUR)	PART NO. (MZ)	PART NAME	DESCRIPTION
P301	C415		nsp	00MOA107025Z0	ELECT. CAP.	ROS-25V 101M - H4#PE - T2 (100UF 25V)
P301	C416		nsp	00MOA107025Z0	ELECT. CAP.	ROS-25V 101M - H4#PE - T2 (100UF 25V)
P301	C417		nsp	00MOA227050Z0	ELECT. CAP.	ROS-50V 221M - J6#PE - S1 (220UF 50V)
P301	C418		nsp	00MOA227050Z0	ELECT. CAP.	ROS-50V 221M - J6#PE - S1 (220UF 50V)
P301	C419		00MOF56331540	00MOF56331540	FILM CAP.	STAR(126)100VDC331J7-10
P301	C420		00MOF56331540	00MOF56331540	FILM CAP.	STAR(126)100VDC331J7-10
P301	C421		00MOF56331540	00MOF56331540	FILM CAP.	STAR(126)100VDC331J7-10
P301	C423		00MOF55220560	00MOF55220560	FILM CAP.	DAMG 22PF 630V
P301	C424		00MOF55220560	00MOF55220560	FILM CAP.	DAMG 22PF 630V
P301	D301		nsp	00MHD20027010	DIODE	HSS81TD-E 150V 150MA
P301	D302		nsp	00MHD20027010	DIODE	HSS81TD-E 150V 150MA
P301	D303		nsp	00MHD20027010	DIODE	HSS81TD-E 150V 150MA
P301	D305		nsp	00MHD20027010	DIODE	HSS81TD-E 150V 150MA
P301	D306		nsp	00MHD20027010	DIODE	HSS81TD-E 150V 150MA
P301	D307		00MHI10095320	00MHI10095320	L.E.D.	LT3K44B GREEN 30MA
P301	D308		00MHI10095320	00MHI10095320	L.E.D.	LT3K44B GREEN 30MA
P301	D309		00MHD30012010	00MHD30012010	ZENER DIODE	HZ24-2L
P301	D310		00MHD30012010	00MHD30012010	ZENER DIODE	HZ24-2L
P301	D311		nsp	00MHD20027010	DIODE	HSS81TD-E 150V 150MA
P301	D312		nsp	00MHD20027010	DIODE	HSS81TD-E 150V 150MA
P301	D401		nsp	00MHD20027010	DIODE	HSS81TD-E 150V 150MA
P301	D402		nsp	00MHD20027010	DIODE	HSS81TD-E 150V 150MA
P301	D405		nsp	00MHD20027010	DIODE	HSS81TD-E 150V 150MA
P301	D406		nsp	00MHD20027010	DIODE	HSS81TD-E 150V 150MA
P301	D407		00MHI10095320	00MHI10095320	L.E.D.	LT3K44B GREEN 30MA
P301	D408		00MHI10095320	00MHI10095320	L.E.D.	LT3K44B GREEN 30MA
P301	D409		00MHD30012010	00MHD30012010	ZENER DIODE	HZ24-2L
P301	D410		00MHD30012010	00MHD30012010	ZENER DIODE	HZ24-2L
P301	D411		nsp	00MHD20027010	DIODE	HSS81TD-E 150V 150MA
P301	D412		nsp	00MHD20027010	DIODE	HSS81TD-E 150V 150MA
P301	L301		00D2140208003	00D2140208003	RELAY	RELAY(NA24W-K)
P301	L302		00D2140208003	00D2140208003	RELAY	RELAY(NA24W-K)
P301	L303		00D2140208003	00D2140208003	RELAY	RELAY(NA24W-K)
P301	L305		00D2140208003	00D2140208003	RELAY	RELAY(NA24W-K)
P301	L306		00D2140208003	00D2140208003	RELAY	RELAY(NA24W-K)
P301	L401		00D2140208003	00D2140208003	RELAY	RELAY(NA24W-K)
P301	L402		00D2140208003	00D2140208003	RELAY	RELAY(NA24W-K)
P301	L405		00D2140208003	00D2140208003	RELAY	RELAY(NA24W-K)
P301	L406		00D2140208003	00D2140208003	RELAY	RELAY(NA24W-K)
P301	Q301		00MKH22AJ1010	00MKH22AJ1010	UNIT & H-IC	HDAM-SA3
P301	Q302		00MKH22AJ1010	00MKH22AJ1010	UNIT & H-IC	HDAM-SA3
P301	Q303		00MKH22AJ1010	00MKH22AJ1010	UNIT & H-IC	HDAM-SA3
P301	Q304		00MKH22AJ1010	00MKH22AJ1010	UNIT & H-IC	HDAM-SA3
P301	Q305		00MKH22AJ1010	00MKH22AJ1010	UNIT & H-IC	HDAM-SA3
P301	Q306		00MKH22AJ1010	00MKH22AJ1010	UNIT & H-IC	HDAM-SA3
P301	Q307		00MHT109702A0	00MHT109702A0	TRS.	2SA970 GR OR BL
P301	Q308		00MHT322402A0	00MHT322402A0	TRS.	2SC2240 GR OR BL
P301	Q309		00MHT109702A0	00MHT109702A0	TRS.	2SA970 GR OR BL
P301	Q310		00MHT322402A0	00MHT322402A0	TRS.	2SC2240 GR OR BL
P301	Q311		00MHT109702A0	00MHT109702A0	TRS.	2SA970 GR OR BL
P301	Q312		00MHT322402A0	00MHT322402A0	TRS.	2SC2240 GR OR BL
P301	Q313		00MHT109702A0	00MHT109702A0	TRS.	2SA970 GR OR BL
P301	Q314		00MHT322402A0	00MHT322402A0	TRS.	2SC2240 GR OR BL
P301	Q315		00MHT41415100	00MHT41415100	TRS.	2SD1415
P301	Q316		00MHT21020100	00MHT21020100	TRS.	2SB1020
P301	Q317		00MHT109702A0	00MHT109702A0	TRS.	2SA970 GR OR BL
P301	Q318		00MHT322402A0	00MHT322402A0	TRS.	2SC2240 GR OR BL
P301	Q401		00MKH22AJ1010	00MKH22AJ1010	UNIT & H-IC	HDAM-SA3
P301	Q402		00MKH22AJ1010	00MKH22AJ1010	UNIT & H-IC	HDAM-SA3
P301	Q403		00MKH22AJ1010	00MKH22AJ1010	UNIT & H-IC	HDAM-SA3
P301	Q404		00MKH22AJ1010	00MKH22AJ1010	UNIT & H-IC	HDAM-SA3
P301	Q405		00MKH22AJ1010	00MKH22AJ1010	UNIT & H-IC	HDAM-SA3
P301	Q406		00MKH22AJ1010	00MKH22AJ1010	UNIT & H-IC	HDAM-SA3
P301	Q407		00MHT109702A0	00MHT109702A0	TRS.	2SA970 GR OR BL
P301	Q408		00MHT322402A0	00MHT322402A0	TRS.	2SC2240 GR OR BL
P301	Q409		00MHT109702A0	00MHT109702A0	TRS.	2SA970 GR OR BL
P301	Q410		00MHT322402A0	00MHT322402A0	TRS.	2SC2240 GR OR BL

NOTE : "nsp" PART IS LISTED FOR REFERENCE ONLY, MARANTZ WILL NOT SUPPLY THESE PARTS.

P.W.B. NAME	POS. NO.	VERS. COLOR	PART NO. (FOR EUR)	PART NO. (MZ)	PART NAME	DESCRIPTION
P301	Q411		00MHT109702A0	00MHT109702A0	TRS.	2SA970 GR OR BL
P301	Q412		00MHT322402A0	00MHT322402A0	TRS.	2SC2240 GR OR BL
P301	Q413		00MHT109702A0	00MHT109702A0	TRS.	2SA970 GR OR BL
P301	Q414		00MHT322402A0	00MHT322402A0	TRS.	2SC2240 GR OR BL
P301	Q415		00MHT41415100	00MHT41415100	TRS.	2SD1415
P301	Q416		00MHT21020100	00MHT21020100	TRS.	2SB1020
P301	Q417		00MHT109702A0	00MHT109702A0	TRS.	2SA970 GR OR BL
P301	Q418		00MHT322402A0	00MHT322402A0	TRS.	2SC2240 GR OR BL
P301	R313		nsp	00MGD05332160	RES.	3.3K OHM +-5% 1/6W
P301	R314		nsp	00MGD05103160	RES.	10K OHM +-5% 1/6W
P301	R332		nsp	00MGD05104160	RES.	100K OHM +-5% 1/6W
P301	R337		nsp	00MGD05151160	RES.	150 OHM +-5% 1/6W
P301	R338		nsp	00MGD05151160	RES.	150 OHM +-5% 1/6W
P301	R339		nsp	00MGD05471160	RES.	470 OHM +-5% 1/6W
P301	R340		nsp	00MGD05471160	RES.	470 OHM +-5% 1/6W
P301	R341		nsp	00MGD05102160	RES.	1K OHM +-5% 1/6W
P301	R342		nsp	00MGD05102160	RES.	1K OHM +-5% 1/6W
P301	R343		nsp	00MGD05223160	RES.	22K OHM +-5% 1/6W
P301	R344		nsp	00MGD05223160	RES.	22K OHM +-5% 1/6W
P301	R347		00MRA01020780	00MRA01020780	TRIM. RES.	1K OHM RH0683C13R
P301	R432		nsp	00MGD05104160	RES.	100K OHM +-5% 1/6W
P301	R437		nsp	00MGD05151160	RES.	150 OHM +-5% 1/6W
P301	R438		nsp	00MGD05151160	RES.	150 OHM +-5% 1/6W
P301	R439		nsp	00MGD05471160	RES.	470 OHM +-5% 1/6W
P301	R440		nsp	00MGD05471160	RES.	470 OHM +-5% 1/6W
P301	R441		nsp	00MGD05102160	RES.	1K OHM +-5% 1/6W
P301	R442		nsp	00MGD05102160	RES.	1K OHM +-5% 1/6W
P301	R443		nsp	00MGD05223160	RES.	22K OHM +-5% 1/6W
P301	R444		nsp	00MGD05223160	RES.	22K OHM +-5% 1/6W
P301	R447		00MRA01020780	00MRA01020780	TRIM. RES.	1K OHM RH0683C13R
					RIGHT PWB P302 (00MWG23AJ302-)	
P302	CE04		nsp	00MDK96103300	CER. CAP.	0.01UF +-10% 50V C1608JB1H103K
P302	CE05		nsp	00MDK96103300	CER. CAP.	0.01UF +-10% 50V C1608JB1H103K
P302	CE06		nsp	00MDK96103300	CER. CAP.	0.01UF +-10% 50V C1608JB1H103K
P302	CE07		nsp	00MDK96103300	CER. CAP.	0.01UF +-10% 50V C1608JB1H103K
P302	DE01		00MHI10046080	00MHI10046080	L.E.D.	BLUE LED SELU2E10C-P-E/F 3
P302	DE02		00MHI10047080	00MHI10047080	L.E.D.	SEL6E10C BLUE LED
P302	DE03		00MHI10047080	00MHI10047080	L.E.D.	SEL6E10C BLUE LED
P302	QE01		00MBA21303000	00MBA21303000	TRS.	DTC124EU RN1303 UMT
P302	QE02		00MBA21303000	00MBA21303000	TRS.	DTC124EU RN1303 UMT
P302	QE03		00MBA21303000	00MBA21303000	TRS.	DTC124EU RN1303 UMT
P302	RE01		nsp	00MNN05102610	CHIP RES.	1K OHM +-5% 1/16W
P302	RE02		nsp	00MNN05821610	CHIP RES.	820 OHM +-5% 1/16W
P302	RE03		nsp	00MNN05222610	CHIP RES.	2.2K OHM +-5% 1/16W
P302	RE04		nsp	00MNN05222610	CHIP RES.	2.2K OHM +-5% 1/16W
P302	RE05		nsp	00MNN05103610	CHIP RES.	10K OHM +-5% 1/16W
P302	RE06		nsp	00MNN05103610	CHIP RES.	10K OHM +-5% 1/16W
P302	RE07		nsp	00MNN05103610	CHIP RES.	10K OHM +-5% 1/16W
P302	RE08		nsp	00MNN05122610	CHIP RES.	1.2K OHM +-5% 1/16W
P302	RE09		nsp	00MNN05122610	CHIP RES.	1.2K OHM +-5% 1/16W
P302	RE10		nsp	00MNN05472610	CHIP RES.	4.7K OHM +-5% 1/16W
P302	SE01		00MSP01013370	00MSP01013370	PUSH SW	EVQ11L05R H/5MM 160GF
P302	SE02		00MSP01013370	00MSP01013370	PUSH SW	EVQ11L05R H/5MM 160GF
P302	SE03		00MSP01013370	00MSP01013370	PUSH SW	EVQ11L05R H/5MM 160GF
					BACK LIGHT PWB P303 (00MWG23AJ303-)	
P303	CD11		nsp	00MDK98104200	CER. CAP.	GRM39F104Z16 0.1UF
P303	DD11		00MHI10005980	00MHI10005980	L.E.D.	NSPW515BS-S-CO
P303	RD11		nsp	00MNN05103610	CHIP RES.	10K OHM +-5% 1/16W
					LEFT PWB P304 (00MWG23AJ304-)	
P304	CP01		nsp	00MDK96103300	CER. CAP.	0.01UF +-10% 50V C1608JB1H103K
P304	CP02		nsp	00MDK96104300	CER. CAP.	C1608X7R1H104K
P304	CP03		nsp	00MDK96104200	CER. CAP.	0.1 UF +-10 % B 10V
P304	CP04		nsp	00MDK96104200	CER. CAP.	0.1 UF +-10 % B 10V
P304	CP05		nsp	00MDK96104200	CER. CAP.	0.1 UF +-10 % B 10V
P304	CP06		nsp	00MDK96104200	CER. CAP.	0.1 UF +-10 % B 10V
P304	CP07		nsp	00MDK96104200	CER. CAP.	0.1 UF +-10 % B 10V
P304	CP08		nsp	00MDK96104200	CER. CAP.	0.1 UF +-10 % B 10V

NOTE : "nsp" PART IS LISTED FOR REFERENCE ONLY, MARANTZ WILL NOT SUPPLY THESE PARTS.

P.W.B. NAME	POS. NO.	VERS. COLOR	PART NO. (FOR EUR)	PART NO. (MZ)	PART NAME	DESCRIPTION
P304	CP09		nsp	00MDK96104200	CER. CAP.	0.1 UF +-10 % B 10V
P304	CP11		nsp	00MDK96104200	CER. CAP.	0.1 UF +-10 % B 10V
P304	CP12		nsp	00MDK96104200	CER. CAP.	0.1 UF +-10 % B 10V
P304	CP13		nsp	00MDK96104200	CER. CAP.	0.1 UF +-10 % B 10V
P304	CP14		nsp	00MDK96104200	CER. CAP.	0.1 UF +-10 % B 10V
P304	CP15		nsp	00MDK96104200	CER. CAP.	0.1 UF +-10 % B 10V
P304	CP16		nsp	00MDK96104200	CER. CAP.	0.1 UF +-10 % B 10V
P304	CP18		nsp	00MDK96104300	CER. CAP.	C1608X7R1H104K
P304	CP19		nsp	00MDK96104300	CER. CAP.	C1608X7R1H104K
P304	CP22		nsp	00MDD95150300	CER. CAP.	15 PF +-5 % CG 50V GR39
P304	CP23		nsp	00MDD95150300	CER. CAP.	15 PF +-5 % CG 50V GR39
P304	CP24		nsp	00MDK96104300	CER. CAP.	C1608X7R1H104K
P304	CP25		nsp	00MDK96152300	CER. CAP.	1500PF (GR39)
P304	CP26		nsp	00MDK96152300	CER. CAP.	1500PF (GR39)
P304	CP27		nsp	00MDK96152300	CER. CAP.	1500PF (GR39)
P304	CP28		nsp	00MDK96152300	CER. CAP.	1500PF (GR39)
P304	CP30		nsp	00MDK96103300	CER. CAP.	0.01UF +-10% 50V C1608JB1H103K
P304	CP32		nsp	00MDK96103300	CER. CAP.	0.01UF +-10% 50V C1608JB1H103K
P304	CP34		nsp	00MDK96103300	CER. CAP.	0.01UF +-10% 50V C1608JB1H103K
P304	CP35		nsp	00MDK96103300	CER. CAP.	0.01UF +-10% 50V C1608JB1H103K
P304	CP41		nsp	00MDK96104300	CER. CAP.	C1608X7R1H104K
P304	CP42		nsp	00MDK96104300	CER. CAP.	C1608X7R1H104K
P304	DP01		00MHZ20018050	00MHZ20018050	CHIP DIODE	1SS302
P304	DP02		00MHZ20018050	00MHZ20018050	CHIP DIODE	1SS302
P304	DP03		00MHZ20018050	00MHZ20018050	CHIP DIODE	1SS302
P304	DP04		00MHZ20018050	00MHZ20018050	CHIP DIODE	1SS302
P304	DP05		00MHZ20018050	00MHZ20018050	CHIP DIODE	1SS302
P304	DP06		00MHZ20018050	00MHZ20018050	CHIP DIODE	1SS302
P304	DP07		00MHZ20018050	00MHZ20018050	CHIP DIODE	1SS302
P304	DP08		00MHZ20018050	00MHZ20018050	CHIP DIODE	1SS302
P304	DP09		00MHI10046080	00MHI10046080	L.E.D.	BLUE LED SELU2E10C-P-E/F 3
P304	DP10		00MHI10047080	00MHI10047080	L.E.D.	SEL6E10C BLUE LED
P304	DP11		00MHI10047080	00MHI10047080	L.E.D.	SEL6E10C BLUE LED
P304	LP01		00MFC90020210	00MFC90020210	FERRITE CORE	MLB-1608-1000A-N2
P304	LP02		00MFC90020210	00MFC90020210	FERRITE CORE	MLB-1608-1000A-N2
P304	LP03		00MFC90020210	00MFC90020210	FERRITE CORE	MLB-1608-1000A-N2
P304	LP04		00MFC90020210	00MFC90020210	FERRITE CORE	MLB-1608-1000A-N2
P304	LP05		00MFC90020210	00MFC90020210	FERRITE CORE	MLB-1608-1000A-N2
P304	LP06		00MFC90020210	00MFC90020210	FERRITE CORE	MLB-1608-1000A-N2
P304	LP07		00MFC90020210	00MFC90020210	FERRITE CORE	MLB-1608-1000A-N2
P304	LP08		00MFC90020210	00MFC90020210	FERRITE CORE	MLB-1608-1000A-N2
P304	LP09		00MFC90020210	00MFC90020210	FERRITE CORE	MLB-1608-1000A-N2
P304	LP10		00MFC90020210	00MFC90020210	FERRITE CORE	MLB-1608-1000A-N2
P304	LP11		00MFN31010060	00MFN31010060	EMI FILTER	EMI FILTER BLM11P600S
P304	LP12		00MFN31010060	00MFN31010060	EMI FILTER	EMI FILTER BLM11P600S
P304	QP01		00MHJ23AJX00F	00MHJ23AJX00F	EPROM/EEPROM	EPM570T144C5N (SOFT_SM-11S1)
P304	QP02		00MHC10047480	00MHC10047480	IC	AK5384
P304	QP03		00D2623077900	00D2623077900	IC	TC74VHCU04FT +REF
P304	QP04		00MBA21303000	00MBA21303000	TRS.	DTC124EU RN1303 UMT
P304	QP05		00MBA21303000	00MBA21303000	TRS.	DTC124EU RN1303 UMT
P304	QP06		00MBA21303000	00MBA21303000	TRS.	DTC124EU RN1303 UMT
P304	RP01		nsp	00MNN05472610	CHIP RES.	4.7K OHM +-5% 1/16W
P304	RP02		nsp	00MNN05472610	CHIP RES.	4.7K OHM +-5% 1/16W
P304	RP03		nsp	00MNN05472610	CHIP RES.	4.7K OHM +-5% 1/16W
P304	RP04		nsp	00MNN05472610	CHIP RES.	4.7K OHM +-5% 1/16W
P304	RP05		nsp	00MNN05000610	CHIP RES.	0 OHM +-5% 1/16W
P304	RP06		nsp	00MNN05000610	CHIP RES.	0 OHM +-5% 1/16W
P304	RP07		nsp	00MNN05000610	CHIP RES.	0 OHM +-5% 1/16W
P304	RP08		nsp	00MNN05000610	CHIP RES.	0 OHM +-5% 1/16W
P304	RP09		nsp	00MNN05470610	CHIP RES.	47 OHM +-5% 1/16W
P304	RP10		nsp	00MNN05000610	CHIP RES.	0 OHM +-5% 1/16W
P304	RP11		nsp	00MNN05101610	CHIP RES.	100 OHM +-5% 1/16W
P304	RP12		nsp	00MNN05473610	CHIP RES.	47K OHM +-5% 1/16W
P304	RP13		nsp	00MNN05101610	CHIP RES.	100 OHM +-5% 1/16W
P304	RP14		nsp	00MNN05101610	CHIP RES.	100 OHM +-5% 1/16W
P304	RP15		nsp	00MNN05101610	CHIP RES.	100 OHM +-5% 1/16W
P304	RP16		nsp	00MNN05101610	CHIP RES.	100 OHM +-5% 1/16W

NOTE : "nsp" PART IS LISTED FOR REFERENCE ONLY, MARANTZ WILL NOT SUPPLY THESE PARTS.

P.W.B. NAME	POS. NO.	VERS. COLOR	PART NO. (FOR EUR)	PART NO. (MZ)	PART NAME	DESCRIPTION
P304	RP17		nsp	00MNN05470610	CHIP RES.	47 OHM +-5% 1/16W
P304	RP18		nsp	00MNN05331610	CHIP RES.	330 OHM +-5% 1/16W
P304	RP19		nsp	00MNN05105610	CHIP RES.	1M OHM +-5% 1/16W
P304	RP21		nsp	00MNN05102610	CHIP RES.	1K OHM +-5% 1/16W
P304	RP22		nsp	00MNN05821610	CHIP RES.	820 OHM +-5% 1/16W
P304	RP23		nsp	00MNN05222610	CHIP RES.	2.2K OHM +-5% 1/16W
P304	RP24		nsp	00MNN05103610	CHIP RES.	10K OHM +-5% 1/16W
P304	RP25		nsp	00MNN05473610	CHIP RES.	47K OHM +-5% 1/16W
P304	RP26		nsp	00MNN05222610	CHIP RES.	2.2K OHM +-5% 1/16W
P304	RP27		nsp	00MNN05103610	CHIP RES.	10K OHM +-5% 1/16W
P304	RP28		nsp	00MNN05122610	CHIP RES.	1.2K OHM +-5% 1/16W
P304	RP29		nsp	00MNN05122610	CHIP RES.	1.2K OHM +-5% 1/16W
P304	RP30		nsp	00MNN05103610	CHIP RES.	10K OHM +-5% 1/16W
P304	RP31		nsp	00MNN05472610	CHIP RES.	4.7K OHM +-5% 1/16W
P304	RP32		nsp	00MNN05000610	CHIP RES.	0 OHM +-5% 1/16W
P304	RP33		nsp	00MNN05000610	CHIP RES.	0 OHM +-5% 1/16W
P304	RP34		nsp	00MNN05000610	CHIP RES.	0 OHM +-5% 1/16W
P304	RP35		nsp	00MNN05000610	CHIP RES.	0 OHM +-5% 1/16W
P304	RP36		nsp	00MNN05000610	CHIP RES.	0 OHM +-5% 1/16W
P304	RP37		nsp	00MNN05000610	CHIP RES.	0 OHM +-5% 1/16W
P304	RP38		nsp	00MNN05000610	CHIP RES.	0 OHM +-5% 1/16W
P304	RP39		nsp	00MNN05000610	CHIP RES.	0 OHM +-5% 1/16W
P304	RP40		nsp	00MNN05000610	CHIP RES.	0 OHM +-5% 1/16W
P304	RP41		nsp	00MNN05000610	CHIP RES.	0 OHM +-5% 1/16W
P304	RP50		nsp	00MNN05000610	CHIP RES.	0 OHM +-5% 1/16W
P304	RP51		nsp	00MNN05000610	CHIP RES.	0 OHM +-5% 1/16W
P304	RP52		nsp	00MNN05000610	CHIP RES.	0 OHM +-5% 1/16W
P304	RP53		nsp	00MNN05000610	CHIP RES.	0 OHM +-5% 1/16W
P304	RP54		nsp	00MNN05000610	CHIP RES.	0 OHM +-5% 1/16W
P304	RP55		nsp	00MNN05000610	CHIP RES.	0 OHM +-5% 1/16W
P304	RP56		nsp	00MNN05000610	CHIP RES.	0 OHM +-5% 1/16W
P304	RP57		nsp	00MNN05000610	CHIP RES.	0 OHM +-5% 1/16W
P304	SU56		00MSP01013370	00MSP01013370	PUSH SW	EVQ11L05R H/5MM 160GF
P304	SU57		00MSP01013370	00MSP01013370	PUSH SW	EVQ11L05R H/5MM 160GF
P304	SU58		00MSP01013370	00MSP01013370	PUSH SW	EVQ11L05R H/5MM 160GF
P304	XP21		00MJX24005350	00MJX24005350	X'TAL	24.576MHZ SMD-49
					POWER SW P306 (00MWG23AJ306-)	
P306	▲ CS01		00MDF77103500	00MDF77103500	FILM CAP.	! 0.01UF M 250V AC
P306	▲ SS01		00MSP01012500	00MSP01012500	PUSH SW	! ESB92S13B TV-5 STROKE=1.5MM
					FRONT PWB P307 (00MWG23AJ301-)	
P307	CU04		nsp	00MDK96104300	CER. CAP.	C1608X7R1H104K
P307	CU05		nsp	00MDK96104300	CER. CAP.	C1608X7R1H104K
P307	CU06		nsp	00MDK96104300	CER. CAP.	C1608X7R1H104K
P307	CU07		nsp	00MDK96104300	CER. CAP.	C1608X7R1H104K
P307	CU08		nsp	00MDD95150300	CER. CAP.	15 PF +-5 % CG 50V GR39
P307	CU09		nsp	00MDD95150300	CER. CAP.	15 PF +-5 % CG 50V GR39
P307	CU10		nsp	00MDK96104300	CER. CAP.	C1608X7R1H104K
P307	CU11		nsp	00MDK96104300	CER. CAP.	C1608X7R1H104K
P307	CU12		nsp	00MDK96103300	CER. CAP.	0.01UF +-10% 50V C1608JB1H103K
P307	CU13		nsp	00MDK96104300	CER. CAP.	C1608X7R1H104K
P307	CU14		nsp	00MDK96104300	CER. CAP.	C1608X7R1H104K
P307	CU15		nsp	00MDK96104300	CER. CAP.	C1608X7R1H104K
P307	CU16		nsp	00MDK96102300	CER. CAP.	1000 PF +-10 % B 50V GR36
P307	CU17		nsp	00MDK96103300	CER. CAP.	0.01UF +-10% 50V C1608JB1H103K
P307	CU18		nsp	00MDK96103300	CER. CAP.	0.01UF +-10% 50V C1608JB1H103K
P307	CU19		nsp	00MDK96104300	CER. CAP.	C1608X7R1H104K
P307	CU20		nsp	00MDK96104300	CER. CAP.	C1608X7R1H104K
P307	CU21		nsp	00MDK96104300	CER. CAP.	C1608X7R1H104K
P307	CU22		nsp	00MDK96103300	CER. CAP.	0.01UF +-10% 50V C1608JB1H103K
P307	CU23		nsp	00MDD95101300	CER. CAP.	100 PF +-5 % CG 50V GR39
P307	CU24		nsp	00MDD95101300	CER. CAP.	100 PF +-5 % CG 50V GR39
P307	CU25		nsp	00MDK96104300	CER. CAP.	C1608X7R1H104K
P307	CU26		nsp	00MDK96104300	CER. CAP.	C1608X7R1H104K
P307	CV05		nsp	00MDK96102300	CER. CAP.	1000 PF +-10 % B 50V GR36
P307	CV07		nsp	00MDK96104300	CER. CAP.	C1608X7R1H104K
P307	CV09		nsp	00MDK96104300	CER. CAP.	C1608X7R1H104K
P307	CV10		nsp	00MDK96104300	CER. CAP.	C1608X7R1H104K

NOTE : "nsp" PART IS LISTED FOR REFERENCE ONLY, MARANTZ WILL NOT SUPPLY THESE PARTS.

P.W.B. NAME	POS. NO.	VERS. COLOR	PART NO. (FOR EUR)	PART NO. (MZ)	PART NAME	DESCRIPTION
P307	CV11		nsp	00MDK98105200	CER. CAP.	1UF 10V F
P307	CV12		nsp	00MDK98105200	CER. CAP.	1UF 10V F
P307	CV13		nsp	00MDK98105200	CER. CAP.	1UF 10V F
P307	CV14		nsp	00MDK98105200	CER. CAP.	1UF 10V F
P307	CV15		nsp	00MDK98105200	CER. CAP.	1UF 10V F
P307	DU02		00MHZ20018050	00MHZ20018050	CHIP DIODE	1SS302
P307	DV01		00MHI10046080	00MHI10046080	L.E.D.	BLUE LED SELU2E10C-P-E/F 3
P307	DV02		00MHI10005340	00MHI10005340	L.E.D.	HLMF-K200 #2UL RED H=9 3MM
P307	DV03		00MHZ30751000	00MHZ30751000	CHIP DIODE	7.5V ZENER MA8075-M,UDPS7.5B
P307	LU01		00MFC90020210	00MFC90020210	FERRITE CORE	MLB-1608-1000A-N2
P307	LU02		00MFC90020210	00MFC90020210	FERRITE CORE	MLB-1608-1000A-N2
P307	LU03		00MFC90020210	00MFC90020210	FERRITE CORE	MLB-1608-1000A-N2
P307	LU04		00MFC90020210	00MFC90020210	FERRITE CORE	MLB-1608-1000A-N2
P307	LU05		00MFC90020210	00MFC90020210	FERRITE CORE	MLB-1608-1000A-N2
P307	LU06		00MFC90020210	00MFC90020210	FERRITE CORE	MLB-1608-1000A-N2
P307	LU07		00MFC90020210	00MFC90020210	FERRITE CORE	MLB-1608-1000A-N2
P307	LU08		00MFC90020210	00MFC90020210	FERRITE CORE	MLB-1608-1000A-N2
P307	LU09		00MFC90020210	00MFC90020210	FERRITE CORE	MLB-1608-1000A-N2
P307	LU10		00MFC90020210	00MFC90020210	FERRITE CORE	MLB-1608-1000A-N2
P307	LU11		00MFC90020210	00MFC90020210	FERRITE CORE	MLB-1608-1000A-N2
P307	LU12		00MFC90020210	00MFC90020210	FERRITE CORE	MLB-1608-1000A-N2
P307	LU13		00MFC90020210	00MFC90020210	FERRITE CORE	MLB-1608-1000A-N2
P307	LU14		00MFC90020210	00MFC90020210	FERRITE CORE	MLB-1608-1000A-N2
P307	LU15		00MFC90020210	00MFC90020210	FERRITE CORE	MLB-1608-1000A-N2
P307	LU16		00MFC90020210	00MFC90020210	FERRITE CORE	MLB-1608-1000A-N2
P307	LU17		00MFC90020210	00MFC90020210	FERRITE CORE	MLB-1608-1000A-N2
P307	LU18		00MFC90020210	00MFC90020210	FERRITE CORE	MLB-1608-1000A-N2
P307	LU19		00MFC90020210	00MFC90020210	FERRITE CORE	MLB-1608-1000A-N2
P307	LU20		00MFC90020210	00MFC90020210	FERRITE CORE	MLB-1608-1000A-N2
P307	LU21		00MFC90020210	00MFC90020210	FERRITE CORE	MLB-1608-1000A-N2
P307	LU29		00MFC90090010	00MFC90090010	FERRITE CORE	ZBF503D-00(TA)-01
P307	QU01		00MHC60037010	00MHC60037010	U-PRO	HD64F3687H FLASH
P307			00M23AJ499A00	00M23AJ499A00	SOFTWARE	SOFTWARE FOR SM-11S1 VER. 001
P307	QU02		00MHC10433990	00MHC10433990	IC	AT24C08AN-10SI-2.7
P307	QU03		00MHC809449R0	00MHC809449R0	IC	74HC4094BT
P307	QU04		00MHC809449R0	00MHC809449R0	IC	74HC4094BT
P307	QU05		00MHC10229210	00MHC10229210	IC	BD4727G 2.7V RESET IC
P307	QU06		00MBA10013050	00MBA10013050	TRS.	RN2303 PNPX1(22K+22K)
P307	QU07		00MHX300012A0	00MHX300012A0	CHIP TRS.	2SC4081 (Q/R) 2SC4116 (Y/GR)
P307	QU08		00MBA21303000	00MBA21303000	TRS.	DTC124EU RN1303 UMT
P307	QU09		00MHX300012A0	00MHX300012A0	CHIP TRS.	2SC4081 (Q/R) 2SC4116 (Y/GR)
P307	QU10		00MBA10013050	00MBA10013050	TRS.	RN2303 PNPX1(22K+22K)
P307	QU11		00MBA21303000	00MBA21303000	TRS.	DTC124EU RN1303 UMT
P307	QU12		00MBA21303000	00MBA21303000	TRS.	DTC124EU RN1303 UMT
P307	QU13		00MBA21303000	00MBA21303000	TRS.	DTC124EU RN1303 UMT
P307	QU14		00MBA21303000	00MBA21303000	TRS.	DTC124EU RN1303 UMT
P307	QU15		00MBA10013050	00MBA10013050	TRS.	RN2303 PNPX1(22K+22K)
P307	QU16		00MBA10013050	00MBA10013050	TRS.	RN2303 PNPX1(22K+22K)
P307	QU17		00MHX300012A0	00MHX300012A0	CHIP TRS.	2SC4081 (Q/R) 2SC4116 (Y/GR)
P307	QU18		00MBA21303000	00MBA21303000	TRS.	DTC124EU RN1303 UMT
P307	QU19		00MBA10013050	00MBA10013050	TRS.	RN2303 PNPX1(22K+22K)
P307	QU21		00MBA10013050	00MBA10013050	TRS.	RN2303 PNPX1(22K+22K)
P307	QU22		00MBA21303000	00MBA21303000	TRS.	DTC124EU RN1303 UMT
P307	QU23		00MHT600121A0	00MHT600121A0	TRS.	KTA1268 GR
P307	QU24		00MHX300012A0	00MHX300012A0	CHIP TRS.	2SC4081 (Q/R) 2SC4116 (Y/GR)
P307	QV02		00MBA21303000	00MBA21303000	TRS.	DTC124EU RN1303 UMT
P307	QV03		00MBA21303000	00MBA21303000	TRS.	DTC124EU RN1303 UMT
P307	RU01		nsp	00MNN05683610	CHIP RES.	68K OHM +-5% 1/16W
P307	RU02		nsp	00MNN05472610	CHIP RES.	4.7K OHM +-5% 1/16W
P307	RU03		nsp	00MNN05223610	CHIP RES.	22K OHM +-5% 1/16W
P307	RU04		nsp	00MNN05104610	CHIP RES.	100K OHM +-5% 1/16W
P307	RU05		nsp	00MNN05124610	CHIP RES.	120K OHM +-5% 1/16W
P307	RU06		nsp	00MNN05473610	CHIP RES.	47K OHM +-5% 1/16W
P307	RU07		nsp	00MNN05473610	CHIP RES.	47K OHM +-5% 1/16W
P307	RU08		nsp	00MNN05473610	CHIP RES.	47K OHM +-5% 1/16W
P307	RU09		nsp	00MNN05473610	CHIP RES.	47K OHM +-5% 1/16W
P307	RU10		nsp	00MNN05473610	CHIP RES.	47K OHM +-5% 1/16W

NOTE : "nsp" PART IS LISTED FOR REFERENCE ONLY, MARANTZ WILL NOT SUPPLY THESE PARTS.

P.W.B. NAME	POS. NO.	VERS. COLOR	PART NO. (FOR EUR)	PART NO. (MZ)	PART NAME	DESCRIPTION
P307	RU11		nsp	00MNN05473610	CHIP RES.	47K OHM +-5% 1/16W
P307	RU12		nsp	00MNN05473610	CHIP RES.	47K OHM +-5% 1/16W
P307	RU13		nsp	00MNN05473610	CHIP RES.	47K OHM +-5% 1/16W
P307	RU14		nsp	00MNN05101610	CHIP RES.	100 OHM +-5% 1/16W
P307	RU15		nsp	00MNN05473610	CHIP RES.	47K OHM +-5% 1/16W
P307	RU16		nsp	00MNN05473610	CHIP RES.	47K OHM +-5% 1/16W
P307	RU17		nsp	00MNN05473610	CHIP RES.	47K OHM +-5% 1/16W
P307	RU18		nsp	00MNN05473610	CHIP RES.	47K OHM +-5% 1/16W
P307	RU19		nsp	00MNN05473610	CHIP RES.	47K OHM +-5% 1/16W
P307	RU20		nsp	00MNN05473610	CHIP RES.	47K OHM +-5% 1/16W
P307	RU23		nsp	00MNN05473610	CHIP RES.	47K OHM +-5% 1/16W
P307	RU24		nsp	00MNN05103610	CHIP RES.	10K OHM +-5% 1/16W
P307	RU25		nsp	00MNN05103610	CHIP RES.	10K OHM +-5% 1/16W
P307	RU26		nsp	00MNN05473610	CHIP RES.	47K OHM +-5% 1/16W
P307	RU28		nsp	00MNN05473610	CHIP RES.	47K OHM +-5% 1/16W
P307	RU30		nsp	00MNN05103610	CHIP RES.	10K OHM +-5% 1/16W
P307	RU31		nsp	00MNN05103610	CHIP RES.	10K OHM +-5% 1/16W
P307	RU32		nsp	00MNN05223610	CHIP RES.	22K OHM +-5% 1/16W
P307	RU33		nsp	00MNN05473610	CHIP RES.	47K OHM +-5% 1/16W
P307	RU34		nsp	00MNN05473610	CHIP RES.	47K OHM +-5% 1/16W
P307	RU35		nsp	00MNN05473610	CHIP RES.	47K OHM +-5% 1/16W
P307	RU36		nsp	00MNN05473610	CHIP RES.	47K OHM +-5% 1/16W
P307	RU37		nsp	00MNN05223610	CHIP RES.	22K OHM +-5% 1/16W
P307	RU38		nsp	00MNN05472610	CHIP RES.	4.7K OHM +-5% 1/16W
P307	RU39		nsp	00MNN05104610	CHIP RES.	100K OHM +-5% 1/16W
P307	RU40		nsp	00MNN05103610	CHIP RES.	10K OHM +-5% 1/16W
P307	RU41		nsp	00MNN05223610	CHIP RES.	22K OHM +-5% 1/16W
P307	RU42		nsp	00MNN05223610	CHIP RES.	22K OHM +-5% 1/16W
P307	RU43		nsp	00MNN05103610	CHIP RES.	10K OHM +-5% 1/16W
P307	RU44		nsp	00MNN05330610	CHIP RES.	33 OHM +-5% 1/16W
P307	RU45		nsp	00MNN05223610	CHIP RES.	22K OHM +-5% 1/16W
P307	RU46		nsp	00MNN05473610	CHIP RES.	47K OHM +-5% 1/16W
P307	RU47		nsp	00MNN05000610	CHIP RES.	0 OHM +-5% 1/16W
P307	RU48		nsp	00MNN05000610	CHIP RES.	0 OHM +-5% 1/16W
P307	RU49		nsp	00MNN05000610	CHIP RES.	0 OHM +-5% 1/16W
P307	RU50		nsp	00MNN05000610	CHIP RES.	0 OHM +-5% 1/16W
P307	RU51		nsp	00MNN05000610	CHIP RES.	0 OHM +-5% 1/16W
P307	RU52		nsp	00MNN05101610	CHIP RES.	100 OHM +-5% 1/16W
P307	RU53		nsp	00MNN05473610	CHIP RES.	47K OHM +-5% 1/16W
P307	RU54		nsp	00MNN05101610	CHIP RES.	100 OHM +-5% 1/16W
P307	RU55		nsp	00MNN05473610	CHIP RES.	47K OHM +-5% 1/16W
P307	RU56		nsp	00MNN05473610	CHIP RES.	47K OHM +-5% 1/16W
P307	RV02		nsp	00MNN05222610	CHIP RES.	2.2K OHM +-5% 1/16W
P307	RV03		nsp	00MNN05103610	CHIP RES.	10K OHM +-5% 1/16W
P307	RV04		nsp	00MNN05221610	CHIP RES.	220 OHM +-5% 1/16W
P307	RV05		nsp	00MNN05103610	CHIP RES.	10K OHM +-5% 1/16W
P307	RV06		nsp	00MNN05222610	CHIP RES.	2.2K OHM +-5% 1/16W
P307	RV07		nsp	00MNN05823610	CHIP RES.	82K OHM +-5% 1/16W
P307	RV08		nsp	00MNN05473610	CHIP RES.	47K OHM +-5% 1/16W
P307	RV09		nsp	00MNN05823610	CHIP RES.	82K OHM +-5% 1/16W
P307	XU01		00MFQ08004060	00MFQ08004060	CER. VIB.	CSTS MG 8MHZ (15PF)
P307	XU02		00MXO001001T0	00MXO001001T0	X'TAL	DT-38 32.768KHZ
					POWER AMP L PWB P501 (00MWG23AJ102-)	
P501	C501		00MOB47708050	00MOB47708050	ELECT. CAP.	470UF/80V PB-FREE
P501	C502		00MOB47708050	00MOB47708050	ELECT. CAP.	470UF/80V PB-FREE
P501	C503		00MOF56331540	00MOF56331540	FILM CAP.	STAR(126)100VDC331J7-10
P501	C504		nsp	00MOA107025Z0	ELECT. CAP.	ROS-25V 101M - H4#PE - T2 (100UF 25V)
P501	C505		00MOF55103580	00MOF55103580	FILM CAP.	0.01UF 100V +-5% FNS
P501	C507		nsp	00MOA47405020	ELECT. CAP.	0.47UF M 50V RA-2
P501	C508		nsp	00MOA47405020	ELECT. CAP.	0.47UF M 50V RA-2
P501	C509		nsp	00MOA47602520	ELECT. CAP.	47 UF M 25V RA-2
P501	C510		nsp	00MOA10605020	ELECT. CAP.	10 UF M 50V RA-2
P501	C511		nsp	00MOA476025Z0	ELECT. CAP.	ROS-25V 470M - G3#PE - T2 (47UF 25V)
P501	D501		nsp	00MHD20027010	DIODE	HSS81TD-E 150V 150MA
P501	D502		nsp	00MHD20027010	DIODE	HSS81TD-E 150V 150MA
P501	D503		nsp	00MHD20027010	DIODE	HSS81TD-E 150V 150MA
P501	D504		nsp	00MHD20027010	DIODE	HSS81TD-E 150V 150MA

NOTE : "nsp" PART IS LISTED FOR REFERENCE ONLY, MARANTZ WILL NOT SUPPLY THESE PARTS.

P.W.B. NAME	POS. NO.	VERS. COLOR	PART NO. (FOR EUR)	PART NO. (MZ)	PART NAME	DESCRIPTION
P501	D505		00MHI10095320	00MHI10095320	L.E.D.	LT3K44B GREEN 30MA
P501	D506		00MHI10095320	00MHI10095320	L.E.D.	LT3K44B GREEN 30MA
P501	D507		nsp	00MHD20027010	DIODE	HSS81TD-E 150V 150MA
P501	D508		nsp	00MHD20027010	DIODE	HSS81TD-E 150V 150MA
P501	D509		nsp	00MHD20027010	DIODE	HSS81TD-E 150V 150MA
P501	D510		nsp	00MHD20027010	DIODE	HSS81TD-E 150V 150MA
P501	D511		00MHD30511000	00MHD30511000	ZENER DIODE	5.1V ZENER EQUIVALENT
P501	J505		00MYP07005670	00MYP07005670	PLUG	IMSA-6065B-06Z065-PT1
P501	J506		00MYP07005670	00MYP07005670	PLUG	IMSA-6065B-06Z065-PT1
P501	J507		00MYP07005670	00MYP07005670	PLUG	IMSA-6065B-06Z065-PT1
P501	J508		00MYP07005670	00MYP07005670	PLUG	IMSA-6065B-06Z065-PT1
P501	K501		00MHK185919C0	00MHK185919C0	TRS. KIT	A1859/C4883 O OR Y PAIR FOR Q517/Q518
P501	K502		00MHK138619F0	00MHK138619F0	TRS. KIT	A1386/C3519 PAIR FOR Q519/Q520 Q521/Q522
P501	Q501		00MHT109702A0	00MHT109702A0	TRS.	2SA970 GR OR BL
P501	Q502		00MHT322402A0	00MHT322402A0	TRS.	2SC2240 GR OR BL
P501	Q503		00MHT322402A0	00MHT322402A0	TRS.	2SC2240 GR OR BL
P501	Q504		00MHT109702A0	00MHT109702A0	TRS.	2SA970 GR OR BL
P501	Q505		00MHT109702A0	00MHT109702A0	TRS.	2SA970 GR OR BL
P501	Q506		00MHT322402A0	00MHT322402A0	TRS.	2SC2240 GR OR BL
P501	Q507		00MHT109702A0	00MHT109702A0	TRS.	2SA970 GR OR BL
P501	Q508		00MHT322402A0	00MHT322402A0	TRS.	2SC2240 GR OR BL
P501	Q509		00MHT109702A0	00MHT109702A0	TRS.	2SA970 GR OR BL
P501	Q510		00MHT322402A0	00MHT322402A0	TRS.	2SC2240 GR OR BL
P501	Q511		00MHT109702A0	00MHT109702A0	TRS.	2SA970 GR OR BL
P501	Q512		00MHT322402A0	00MHT322402A0	TRS.	2SC2240 GR OR BL
P501	Q513		00MHT113602A0	00MHT113602A0	TRS.	2SA1360 O OR Y
P501	Q514		00MHT334232A0	00MHT334232A0	TRS.	2SC3423 O OR Y
P501	Q515		00MHT334212A0	00MHT334212A0	TRS.	2SC3421 O/Y 120V 1A PC=1.5W (10W)
P501	Q516		00MHT113582A0	00MHT113582A0	TRS.	2SA1358 O/Y 120V 1A PC=1.5W (10W)
P501	Q517		nsp	nsp	TRS.	2SC4883 O OR Y PAIR OF K501
P501	Q518		nsp	nsp	TRS.	2SA1859 O OR Y PAIR OF K501
P501	Q519		nsp	nsp	TRS.	2SC3519 O/P/Y PAIR OF K502 WITH Q520
P501	Q520		nsp	nsp	TRS.	2SA1386 O/P/Y PAIR OF K502 WITH Q519
P501	Q521		nsp	nsp	TRS.	2SC3519 O/P/Y PAIR OF K502 WITH Q522
P501	Q522		nsp	nsp	TRS.	2SA1386 O/P/Y PAIR OF K502 WITH Q521
P501	Q523		00MHT322402A0	00MHT322402A0	TRS.	2SC2240 GR OR BL
P501	Q524		00MHT109702A0	00MHT109702A0	TRS.	2SA970 GR OR BL
P501	Q525		00MHT109702A0	00MHT109702A0	TRS.	2SA970 GR OR BL
P501	Q526		00MHT322402A0	00MHT322402A0	TRS.	2SC2240 GR OR BL
P501	Q527		00MHT415080A0	00MHT415080A0	TRS.	2SD1508 HFE>4000
P501	Q528		00MHT322402A0	00MHT322402A0	TRS.	2SC2240 GR OR BL
P501	Q529		00MHT322402A0	00MHT322402A0	TRS.	2SC2240 GR OR BL
P501	Q530		00MBA20001000	00MBA20001000	TRS.	DTC114ES/UN4211 10K 10K
P501	Q531		00MHT322402A0	00MHT322402A0	TRS.	2SC2240 GR OR BL
P501	Q532		00MHT109702A0	00MHT109702A0	TRS.	2SA970 GR OR BL
P501	Q533		00MHT322402A0	00MHT322402A0	TRS.	2SC2240 GR OR BL
P501	R503		nsp	00MGD05561160	RES.	560 OHM +-5% 1/6W
P501	R504		nsp	00MGD05561160	RES.	560 OHM +-5% 1/6W
P501	R515		nsp	00MGD05104160	RES.	100K OHM +-5% 1/6W
P501	R516		nsp	00MGD05104160	RES.	100K OHM +-5% 1/6W
P501	R517		nsp	00MGD05682160	RES.	6.8K OHM +-5% 1/6W
P501	R518		nsp	00MGD05332160	RES.	3.3K OHM +-5% 1/6W
P501	R519		00MRA01020760	00MRA01020760	TRIM. RES.	1K OHM VERTICAL
P501	R537		00MGO05001050	00MGO05001050	RES.	0.1 OHMS +-5% 5W PBR58
P501	R538		00MGO05001050	00MGO05001050	RES.	0.1 OHMS +-5% 5W PBR58
P501	R539		00MGO05001050	00MGO05001050	RES.	0.1 OHMS +-5% 5W PBR58
P501	R540		00MGO05001050	00MGO05001050	RES.	0.1 OHMS +-5% 5W PBR58
P501	R549		nsp	00MGD05682160	RES.	6.8K OHM +-5% 1/6W
P501	R550		nsp	00MGD05682160	RES.	6.8K OHM +-5% 1/6W
P501	R551		nsp	00MGD05223160	RES.	22K OHM +-5% 1/6W
P501	R552		nsp	00MGD05223160	RES.	22K OHM +-5% 1/6W
P501	R553		nsp	00MGD05223160	RES.	22K OHM +-5% 1/6W
P501	R554		nsp	00MGD05223160	RES.	22K OHM +-5% 1/6W
P501	R555		nsp	00MGD05473160	RES.	47K OHM +-5% 1/6W
P501	R556		nsp	00MGD05103160	RES.	10K OHM +-5% 1/6W
P501	R557		nsp	00MGD05473160	RES.	47K OHM +-5% 1/6W
P501	R558		nsp	00MGD05473160	RES.	47K OHM +-5% 1/6W

NOTE : "nsp" PART IS LISTED FOR REFERENCE ONLY, MARANTZ WILL NOT SUPPLY THESE PARTS.

P.W.B. NAME	POS. NO.	VERS. COLOR	PART NO. (FOR EUR)	PART NO. (MZ)	PART NAME	DESCRIPTION
P501	R560		nsp	00MGD05683160	RES.	68K OHM +-5% 1/6W
P501	R561		nsp	00MGD05104160	RES.	100K OHM +-5% 1/6W
P501	R562		nsp	00MGD05333160	RES.	33K OHM +-5% 1/6W
					POSISTOR L PWB P581 (00MWG23AJ106-)	
P581	R581		00MHP00009230	00MHP00009230	VARIATOR	POSISTOR PTH487 (01BB-120)
					POWER AMP R PWB P601 (00MWG23AJ103-)	
P601	C601		00MOB47708050	00MOB47708050	ELECT. CAP.	470UF/80V PB-FREE
P601	C602		00MOB47708050	00MOB47708050	ELECT. CAP.	470UF/80V PB-FREE
P601	C603		00MOF56331540	00MOF56331540	FILM CAP.	STAR(126)100VDC331J7-10
P601	C604		nsp	00MOA107025Z0	ELECT. CAP.	ROS-25V 101M - H4#PE - T2 (100UF 25V)
P601	C605		00MOF55103580	00MOF55103580	FILM CAP.	0.01UF 100V +-5% FNS
P601	C607		nsp	00MOA47405020	ELECT. CAP.	0.47UF M 50V RA-2
P601	C608		nsp	00MOA47405020	ELECT. CAP.	0.47UF M 50V RA-2
P601	C609		nsp	00MOA47602520	ELECT. CAP.	47 UF M 25V RA-2
P601	C610		nsp	00MOA10605020	ELECT. CAP.	10 UF M 50V RA-2
P601	C611		nsp	00MOA476025Z0	ELECT. CAP.	ROS-25V 470M - G3#PE - T2 (47UF 25V)
P601	D601		nsp	00MHD20027010	DIODE	HSS81TD-E 150V 150MA
P601	D602		nsp	00MHD20027010	DIODE	HSS81TD-E 150V 150MA
P601	D603		nsp	00MHD20027010	DIODE	HSS81TD-E 150V 150MA
P601	D604		nsp	00MHD20027010	DIODE	HSS81TD-E 150V 150MA
P601	D605		00MHI10095320	00MHI10095320	L.E.D.	LT3K44B GREEN 30MA
P601	D606		00MHI10095320	00MHI10095320	L.E.D.	LT3K44B GREEN 30MA
P601	D607		nsp	00MHD20027010	DIODE	HSS81TD-E 150V 150MA
P601	D608		nsp	00MHD20027010	DIODE	HSS81TD-E 150V 150MA
P601	D609		nsp	00MHD20027010	DIODE	HSS81TD-E 150V 150MA
P601	D610		nsp	00MHD20027010	DIODE	HSS81TD-E 150V 150MA
P601	D611		00MHD30511000	00MHD30511000	ZENER DIODE	5.1V ZENER EQUIVALENT
P601	J605		00MYP07005670	00MYP07005670	PLUG	IMSA-6065B-06Z065-PT1
P601	J606		00MYP07005670	00MYP07005670	PLUG	IMSA-6065B-06Z065-PT1
P601	J607		00MYP07005670	00MYP07005670	PLUG	IMSA-6065B-06Z065-PT1
P601	J608		00MYP07005670	00MYP07005670	PLUG	IMSA-6065B-06Z065-PT1
P601	K601		00MHK185919C0	00MHK185919C0	TRS. KIT	A1859/C4883 O OR Y PAIR FOR Q617/Q618
P601	K602		00MHK138619F0	00MHK138619F0	TRS. KIT	A1386/C3519 PAIR FOR Q619/Q620 Q621/Q622
P601	Q601		00MHT109702A0	00MHT109702A0	TRS.	2SA970 GR OR BL
P601	Q602		00MHT322402A0	00MHT322402A0	TRS.	2SC2240 GR OR BL
P601	Q603		00MHT322402A0	00MHT322402A0	TRS.	2SC2240 GR OR BL
P601	Q604		00MHT109702A0	00MHT109702A0	TRS.	2SA970 GR OR BL
P601	Q605		00MHT109702A0	00MHT109702A0	TRS.	2SA970 GR OR BL
P601	Q606		00MHT322402A0	00MHT322402A0	TRS.	2SC2240 GR OR BL
P601	Q607		00MHT109702A0	00MHT109702A0	TRS.	2SA970 GR OR BL
P601	Q608		00MHT322402A0	00MHT322402A0	TRS.	2SC2240 GR OR BL
P601	Q609		00MHT109702A0	00MHT109702A0	TRS.	2SA970 GR OR BL
P601	Q610		00MHT322402A0	00MHT322402A0	TRS.	2SC2240 GR OR BL
P601	Q611		00MHT109702A0	00MHT109702A0	TRS.	2SA970 GR OR BL
P601	Q612		00MHT322402A0	00MHT322402A0	TRS.	2SC2240 GR OR BL
P601	Q613		00MHT113602A0	00MHT113602A0	TRS.	2SA1360 O OR Y
P601	Q614		00MHT334232A0	00MHT334232A0	TRS.	2SC3423 O OR Y
P601	Q615		00MHT334212A0	00MHT334212A0	TRS.	2SC3421 O/Y 120V 1A PC=1.5W (10W)
P601	Q616		00MHT113582A0	00MHT113582A0	TRS.	2SA1358 O/Y 120V 1A PC=1.5W (10W)
P601	Q617		00MHT348832A0	00MHT348832A0	TRS.	2SC4883 O OR Y PAIR OF K601
P601	Q618		00MHT118592A0	00MHT118592A0	TRS.	2SA1859 O OR Y PAIR OF K601
P601	Q619		00MHT335192A0	00MHT335192A0	TRS.	2SC3519 O/P/Y PAIR OF K602 WITH Q620
P601	Q620		00MHT113862A0	00MHT113862A0	TRS.	2SA1386 O/P/Y PAIR OF K602 WITH Q619
P601	Q621		00MHT335192A0	00MHT335192A0	TRS.	2SC3519 O/P/Y PAIR OF K602 WITH Q622
P601	Q622		00MHT113862A0	00MHT113862A0	TRS.	2SA1386 O/P/Y PAIR OF K602 WITH Q621
P601	Q623		00MHT322402A0	00MHT322402A0	TRS.	2SC2240 GR OR BL
P601	Q624		00MHT109702A0	00MHT109702A0	TRS.	2SA970 GR OR BL
P601	Q625		00MHT109702A0	00MHT109702A0	TRS.	2SA970 GR OR BL
P601	Q626		00MHT322402A0	00MHT322402A0	TRS.	2SC2240 GR OR BL
P601	Q627		00MHT415080A0	00MHT415080A0	TRS.	2SD1508 HFE>4000
P601	Q628		00MHT322402A0	00MHT322402A0	TRS.	2SC2240 GR OR BL
P601	Q629		00MHT322402A0	00MHT322402A0	TRS.	2SC2240 GR OR BL
P601	Q630		00MBA20001000	00MBA20001000	TRS.	DTC114ES/UN4211 10K 10K
P601	Q631		00MHT322402A0	00MHT322402A0	TRS.	2SC2240 GR OR BL
P601	Q632		00MHT109702A0	00MHT109702A0	TRS.	2SA970 GR OR BL
P601	Q633		00MHT322402A0	00MHT322402A0	TRS.	2SC2240 GR OR BL
P601	R603		nsp	00MGD05561160	RES.	560 OHM +-5% 1/6W

NOTE : "nsp" PART IS LISTED FOR REFERENCE ONLY, MARANTZ WILL NOT SUPPLY THESE PARTS.

P.W.B. NAME	POS. NO.	VERS. COLOR	PART NO. (FOR EUR)	PART NO. (MZ)	PART NAME	DESCRIPTION
P601	R604		nsp	00MGD05561160	RES.	560 OHM +-5% 1/6W
P601	R615		nsp	00MGD05104160	RES.	100K OHM +-5% 1/6W
P601	R616		nsp	00MGD05104160	RES.	100K OHM +-5% 1/6W
P601	R617		nsp	00MGD05682160	RES.	6.8K OHM +-5% 1/6W
P601	R618		nsp	00MGD05332160	RES.	3.3K OHM +-5% 1/6W
P601	R619		00MRA01020760	00MRA01020760	TRIM. RES.	1K OHM VERTICAL
P601	R637		00MGO05001050	00MGO05001050	RES.	0.1 OHMS +-5% 5W PBR58
P601	R638		00MGO05001050	00MGO05001050	RES.	0.1 OHMS +-5% 5W PBR58
P601	R639		00MGO05001050	00MGO05001050	RES.	0.1 OHMS +-5% 5W PBR58
P601	R640		00MGO05001050	00MGO05001050	RES.	0.1 OHMS +-5% 5W PBR58
P601	R649		nsp	00MGD05682160	RES.	6.8K OHM +-5% 1/6W
P601	R650		nsp	00MGD05682160	RES.	6.8K OHM +-5% 1/6W
P601	R651		nsp	00MGD05223160	RES.	22K OHM +-5% 1/6W
P601	R652		nsp	00MGD05223160	RES.	22K OHM +-5% 1/6W
P601	R653		nsp	00MGD05223160	RES.	22K OHM +-5% 1/6W
P601	R654		nsp	00MGD05223160	RES.	22K OHM +-5% 1/6W
P601	R655		nsp	00MGD05473160	RES.	47K OHM +-5% 1/6W
P601	R656		nsp	00MGD05103160	RES.	10K OHM +-5% 1/6W
P601	R657		nsp	00MGD05473160	RES.	47K OHM +-5% 1/6W
P601	R658		nsp	00MGD05473160	RES.	47K OHM +-5% 1/6W
P601	R660		nsp	00MGD05683160	RES.	68K OHM +-5% 1/6W
P601	R661		nsp	00MGD05104160	RES.	100K OHM +-5% 1/6W
P601	R662		nsp	00MGD05333160	RES.	33K OHM +-5% 1/6W
					POSISTOR R PWB P681 (00MWG23AJ107-)	
P681	R681		00MHP00009230	00MHP00009230	VARISTOR	POSISTOR PTH487 (01BB-120)
					SPK.TERMINAL PWB P701 (00MWG23AJ203-)	
P701	C701		nsp	00MOA22602520	ELECT. CAP.	22 UF M 25V RA-2
P701	C702		nsp	00MOA22602520	ELECT. CAP.	22 UF M 25V RA-2
P701	C703		nsp	00MOA22505020	ELECT. CAP.	2.2 UF M 50V RA-2
P701	C704		nsp	00MOA22602520	ELECT. CAP.	22 UF M 25V RA-2
P701	C705		nsp	00MOA22505020	ELECT. CAP.	2.2 UF M 50V RA-2
P701	C706		nsp	00MOA22602520	ELECT. CAP.	22 UF M 25V RA-2
P701	C707		nsp	00MOA107025R0	ELECT. CAP.	ROA-25V 101M -H4#PE - T2 (100UF 25V)
P701	C708		nsp	00MOA107025R0	ELECT. CAP.	ROA-25V 101M -H4#PE - T2 (100UF 25V)
P701	C709		00MOF15102540	00MOF15102540	FILM CAP.	1000PF J 100V APSV
P701	C710		00MOF15102540	00MOF15102540	FILM CAP.	1000PF J 100V APSV
P701	C711		nsp	00MOA22602520	ELECT. CAP.	22 UF M 25V RA-2
P701	C712		nsp	00MOA22602520	ELECT. CAP.	22 UF M 25V RA-2
P701	C713		nsp	00MOA22505020	ELECT. CAP.	2.2 UF M 50V RA-2
P701	C714		nsp	00MOA22602520	ELECT. CAP.	22 UF M 25V RA-2
P701	C715		nsp	00MOA22505020	ELECT. CAP.	2.2 UF M 50V RA-2
P701	C716		nsp	00MOA22602520	ELECT. CAP.	22 UF M 25V RA-2
P701	C717		nsp	00MOA107025R0	ELECT. CAP.	ROA-25V 101M -H4#PE - T2 (100UF 25V)
P701	C718		nsp	00MOA107025R0	ELECT. CAP.	ROA-25V 101M -H4#PE - T2 (100UF 25V)
P701	C719		00MOF15102540	00MOF15102540	FILM CAP.	1000PF J 100V APSV
P701	C720		00MOF15102540	00MOF15102540	FILM CAP.	1000PF J 100V APSV
P701	C722		nsp	00MOA10602520	ELECT. CAP.	10 UF M 25V RA-2
P701	C723		00MOF55393580	00MOF55393580	FILM CAP.	0.039UF 100V +-5% FAS
P701	C724		00MOF55393580	00MOF55393580	FILM CAP.	0.039UF 100V +-5% FAS
P701	D701		nsp	00MHD20027010	DIODE	HSS81TD-E 150V 150MA
P701	D702		nsp	00MHD20027010	DIODE	HSS81TD-E 150V 150MA
P701	L701		00MLY20240310	00MLY20240310	RELAY	VB-24MBU-510-UC
P701	L702		00MLY20240310	00MLY20240310	RELAY	VB-24MBU-510-UC
P701	L703		00MLY20240310	00MLY20240310	RELAY	VB-24MBU-510-UC
P701	L704		00MLY20240310	00MLY20240310	RELAY	VB-24MBU-510-UC
P701	L705		00MFC90050060	00MFC90050060	FERRITE CORE	FERRIT BEADS (B-01-AT1F)
P701	L706		00MFC90050060	00MFC90050060	FERRITE CORE	FERRIT BEADS (B-01-AT1F)
P701	L707		00MFC90050060	00MFC90050060	FERRITE CORE	FERRIT BEADS (B-01-AT1F)
P701	Q701		00MHG00002480	00MHG00002480	HALL DEVICE	CQ-120E
P701	Q702		00MHG00002480	00MHG00002480	HALL DEVICE	CQ-120E
P701	Q703		00MHC10053090	00MHC10053090	IC	NJM2068DD
P701	Q704		00MHC10053090	00MHC10053090	IC	NJM2068DD
P701	Q705		00MHC10053090	00MHC10053090	IC	NJM2068DD
P701	Q706		00MHC10053090	00MHC10053090	IC	NJM2068DD
P701	Q707		00MHT600111B0	00MHT600111B0	TRS.	KTA1267 Y
P701	Q708		00MHT600111B0	00MHT600111B0	TRS.	KTA1267 Y
P701	Q709		00MBA20001000	00MBA20001000	TRS.	DTC114ES/UN4211 10K 10K

NOTE : *nsp* PART IS LISTED FOR REFERENCE ONLY, MARANTZ WILL NOT SUPPLY THESE PARTS.

P.W.B. NAME	POS. NO.	VERS. COLOR	PART NO. (FOR EUR)	PART NO. (MZ)	PART NAME	DESCRIPTION
P701	Q710		00MBA20001000	00MBA20001000	TRS.	DTC114ES/UN4211 10K 10K
P701	R701		nsp	00MGD05333160	RES.	33K OHM +-5% 1/6W
P701	R702		nsp	00MGD05333160	RES.	33K OHM +-5% 1/6W
P701	R703		nsp	00MGD05152160	RES.	1.5K OHM +-5% 1/6W
P701	R704		nsp	00MGD05152160	RES.	1.5K OHM +-5% 1/6W
P701	R705		nsp	00MGD05152160	RES.	1.5K OHM +-5% 1/6W
P701	R706		nsp	00MGD05152160	RES.	1.5K OHM +-5% 1/6W
P701	R707		nsp	00MGD05391160	RES.	390 OHM +-5% 1/6W
P701	R708		nsp	00MGD05391160	RES.	390 OHM +-5% 1/6W
P701	R709		nsp	00MGD05223160	RES.	22K OHM +-5% 1/6W
P701	R710		nsp	00MGD05223160	RES.	22K OHM +-5% 1/6W
P701	R711		nsp	00MGD05102160	RES.	1K OHM +-5% 1/6W
P701	R712		nsp	00MGD05102160	RES.	1K OHM +-5% 1/6W
P701	R713		nsp	00MGD05102160	RES.	1K OHM +-5% 1/6W
P701	R714		nsp	00MGD05102160	RES.	1K OHM +-5% 1/6W
P701	R715		nsp	00MGD05222160	RES.	2.2K OHM +-5% 1/6W
P701	R716		nsp	00MGD05222160	RES.	2.2K OHM +-5% 1/6W
P701	R717		nsp	00MGD05222160	RES.	2.2K OHM +-5% 1/6W
P701	R718		nsp	00MGD05222160	RES.	2.2K OHM +-5% 1/6W
P701	R719		nsp	00MGD05222160	RES.	2.2K OHM +-5% 1/6W
P701	R720		nsp	00MGD05222160	RES.	2.2K OHM +-5% 1/6W
P701	R721		nsp	00MGD05101160	RES.	100 OHM +-5% 1/6W
P701	R722		nsp	00MGD05101160	RES.	100 OHM +-5% 1/6W
P701	R723		nsp	00MGD05101160	RES.	100 OHM +-5% 1/6W
P701	R724		nsp	00MGD05101160	RES.	100 OHM +-5% 1/6W
P701	R725		nsp	00MGD05391160	RES.	390 OHM +-5% 1/6W
P701	R726		nsp	00MGD05391160	RES.	390 OHM +-5% 1/6W
P701	R727		nsp	00MGD05223160	RES.	22K OHM +-5% 1/6W
P701	R728		nsp	00MGD05223160	RES.	22K OHM +-5% 1/6W
P701	R729		nsp	00MGD05102160	RES.	1K OHM +-5% 1/6W
P701	R730		nsp	00MGD05102160	RES.	1K OHM +-5% 1/6W
P701	R731		nsp	00MGD05102160	RES.	1K OHM +-5% 1/6W
P701	R732		nsp	00MGD05102160	RES.	1K OHM +-5% 1/6W
P701	R733		nsp	00MGD05222160	RES.	2.2K OHM +-5% 1/6W
P701	R734		nsp	00MGD05222160	RES.	2.2K OHM +-5% 1/6W
P701	R735		nsp	00MGD05222160	RES.	2.2K OHM +-5% 1/6W
P701	R736		nsp	00MGD05222160	RES.	2.2K OHM +-5% 1/6W
P701	R737		nsp	00MGD05222160	RES.	2.2K OHM +-5% 1/6W
P701	R738		nsp	00MGD05222160	RES.	2.2K OHM +-5% 1/6W
P701	R739		nsp	00MGD05101160	RES.	100 OHM +-5% 1/6W
P701	R740		nsp	00MGD05101160	RES.	100 OHM +-5% 1/6W
P701	R741		nsp	00MGD05101160	RES.	100 OHM +-5% 1/6W
P701	R742		nsp	00MGD05101160	RES.	100 OHM +-5% 1/6W
P701	R755		nsp	00MGD05473160	RES.	47K OHM +-5% 1/6W
P701	R756		nsp	00MGD05473160	RES.	47K OHM +-5% 1/6W
P701	R757		nsp	00MGD05103160	RES.	10K OHM +-5% 1/6W
P701	R758		nsp	00MGD05103160	RES.	10K OHM +-5% 1/6W
P701	R759		00MNK05100030	00MNK05100030	METAL RES.	10 OHM +-5% 3W
P701	R760		00MNK05100030	00MNK05100030	METAL RES.	10 OHM +-5% 3W
					POWER SUPPLY PWB P801 (00MWG23AJ202-)	
P801	C801		nsp	00MOA22805030	ELECT. CAP.	2200UF 50V LKG1H222MESYZT
P801	C802		nsp	00MOA22805030	ELECT. CAP.	2200UF 50V LKG1H222MESYZT
P801	C803		nsp	00MOA108025R0	ELECT. CAP.	ROA-25V 102M - J7#PE - S1 (1000UF 25V
P801	C804		nsp	00MOA108025R0	ELECT. CAP.	ROA-25V 102M - J7#PE - S1 (1000UF 25V
P801	C805		nsp	00MOA106035Z0	ELECT. CAP.	ROS-35V 100M - F3#PE - T2 (10UF 35V)
P801	C806		nsp	00MOA106035Z0	ELECT. CAP.	ROS-35V 100M - F3#PE - T2 (10UF 35V)
P801	C808		nsp	00MOA108025R0	ELECT. CAP.	ROA-25V 102M - J7#PE - S1 (1000UF 25V
P801	C809		nsp	00MOA106035Z0	ELECT. CAP.	ROS-35V 100M - F3#PE - T2 (10UF 35V)
P801	C810		nsp	00MOA22505020	ELECT. CAP.	2.2 UF M 50V RA-2
P801	C811		nsp	00MOA477025R0	ELECT. CAP.	ROA-25V 471M -I6#PE - S13 (470UF 25V)
P801	C812		nsp	00MOA106035Z0	ELECT. CAP.	ROS-35V 100M - F3#PE - T2 (10UF 35V)
P801	C814		nsp	00MOA10605020	ELECT. CAP.	10 UF M 50V RA-2
P801	C816		nsp	00MOA10605020	ELECT. CAP.	10 UF M 50V RA-2
P801	C818		nsp	00MOA10605020	ELECT. CAP.	10 UF M 50V RA-2
P801	▲ D801		00MHD20055100	00MHD20055100	DIODE	! SHOTTKY 11EQS10 1A 100V
P801	▲ D802		00MHD20055100	00MHD20055100	DIODE	! SHOTTKY 11EQS10 1A 100V
P801	▲ D803		00MHD20055100	00MHD20055100	DIODE	! SHOTTKY 11EQS10 1A 100V

NOTE : *nsp* PART IS LISTED FOR REFERENCE ONLY, MARANTZ WILL NOT SUPPLY THESE PARTS.

P.W.B. NAME	POS. NO.	VERS. COLOR	PART NO. (FOR EUR)	PART NO. (MZ)	PART NAME	DESCRIPTION
P801	▲ D804		00MHD20055100	00MHD20055100	DIODE	! SHOTTKY 11EQS10 1A 100V
P801	▲ D805		00MHD20055100	00MHD20055100	DIODE	! SHOTTKY 11EQS10 1A 100V
P801	▲ D806		00MHD20055100	00MHD20055100	DIODE	! SHOTTKY 11EQS10 1A 100V
P801	▲ D807		00MHD20055100	00MHD20055100	DIODE	! SHOTTKY 11EQS10 1A 100V
P801	▲ D808		00MHD20055100	00MHD20055100	DIODE	! SHOTTKY 11EQS10 1A 100V
P801	▲ D809		00MHD20055100	00MHD20055100	DIODE	! SHOTTKY 11EQS10 1A 100V
P801	▲ D810		00MHD20055100	00MHD20055100	DIODE	! SHOTTKY 11EQS10 1A 100V
P801	D811		nsp	00MHD20002000	DIODE	1SS133 T-77
P801	▲ D812		00MHD20055100	00MHD20055100	DIODE	! SHOTTKY 11EQS10 1A 100V
P801	▲ D813		00MHD20055100	00MHD20055100	DIODE	! SHOTTKY 11EQS10 1A 100V
P801	D814		nsp	00MHD20002000	DIODE	1SS133 T-77
P801	D815		nsp	00MHD20002000	DIODE	1SS133 T-77
P801	D816		nsp	00MHD20002000	DIODE	1SS133 T-77
P801	D817		nsp	00MHD20002000	DIODE	1SS133 T-77
P801	▲ G801		00MBF68400010	00MBF68400010	CAP.COMP.	! 0.68UF/4.7OHM
P801	▲ G802		00MBF68400010	00MBF68400010	CAP.COMP.	! 0.68UF/4.7OHM
P801	L801		00MLC21060720	00MLC21060720	COIL	10MH SL1923-103KR33
P801	L802		00MLC21060720	00MLC21060720	COIL	10MH SL1923-103KR33
P801	L803		00MFC90050060	00MFC90050060	FERRITE CORE	FERRIT BEADS (B-01-AT1F)
P801	L804		00MFC90050060	00MFC90050060	FERRITE CORE	FERRIT BEADS (B-01-AT1F)
P801	L805		00MFC90050060	00MFC90050060	FERRITE CORE	FERRIT BEADS (B-01-AT1F)
P801	L806		00MFC90050060	00MFC90050060	FERRITE CORE	FERRIT BEADS (B-01-AT1F)
P801	L807		00MFC90050060	00MFC90050060	FERRITE CORE	FERRIT BEADS (B-01-AT1F)
P801	L808		00MFC90050060	00MFC90050060	FERRITE CORE	FERRIT BEADS (B-01-AT1F)
P801	L809		00MFC90050060	00MFC90050060	FERRITE CORE	FERRIT BEADS (B-01-AT1F)
P801	Q801		00MHC3851209F	00MHC3851209F	IC	NJM78M12FA
P801	Q802		00MHC3951209F	00MHC3951209F	IC	NJM79M12AF -12V 0.5A
P801	Q803		00MHC3850509F	00MHC3850509F	IC	NJM78M05FA
P801	Q804		00MHC36J3321F	00MHC36J3321F	IC	BA033T +3.3V 1A TYPE
P801	Q805		00MHT800921B0	00MHT800921B0	TRS.	KTC3199 Y
P801	Q806		00MHT800921B0	00MHT800921B0	TRS.	KTC3199 Y
P801	Q807		00MHT600111B0	00MHT600111B0	TRS.	KTA1267 Y
P801	Q808		00MBA20001000	00MBA20001000	TRS.	DTC114ES/UN4211 10K 10K
P801	Q809		00MHT800921B0	00MHT800921B0	TRS.	KTC3199 Y
P801	Q810		00MHT800921B0	00MHT800921B0	TRS.	KTC3199 Y
P801	Q811		00MHT800921B0	00MHT800921B0	TRS.	KTC3199 Y
P801	Q812		00MHT800921B0	00MHT800921B0	TRS.	KTC3199 Y
P801	Q813		00MHT600111B0	00MHT600111B0	TRS.	KTA1267 Y
P801	Q814		00MHT600111B0	00MHT600111B0	TRS.	KTA1267 Y
P801	Q815		00MHT600111B0	00MHT600111B0	TRS.	KTA1267 Y
P801	Q816		00MBA20001000	00MBA20001000	TRS.	DTC114ES/UN4211 10K 10K
P801	Q817		00MBA20001000	00MBA20001000	TRS.	DTC114ES/UN4211 10K 10K
P801	Q818		00MBA20001000	00MBA20001000	TRS.	DTC114ES/UN4211 10K 10K
P801	Q819		00MBA10001000	00MBA10001000	TRS.	DTA114ES/UN4111 10K 10K
P801	Q820		00MBA20001000	00MBA20001000	TRS.	DTC114ES/UN4211 10K 10K
P801	Q821		00MBA20001000	00MBA20001000	TRS.	DTC114ES/UN4211 10K 10K
P801	Q822		00MBA20001000	00MBA20001000	TRS.	DTC114ES/UN4211 10K 10K
P801	Q823		00MBA20001000	00MBA20001000	TRS.	DTC114ES/UN4211 10K 10K
P801	Q824		00MHT600111B0	00MHT600111B0	TRS.	KTA1267 Y
P801	▲ R801		00MGG05010140	00MGG05010140	RES.	! 1 OHM +5% 1/4W ERD25FYJ1R0T
P801	▲ R802		00MGG05010140	00MGG05010140	RES.	! 1 OHM +5% 1/4W ERD25FYJ1R0T
P801	▲ R803		00MGG05010140	00MGG05010140	RES.	! 1 OHM +5% 1/4W ERD25FYJ1R0T
P801	▲ R804		00MGG05010140	00MGG05010140	RES.	! 1 OHM +5% 1/4W ERD25FYJ1R0T
P801	R809		nsp	00MGD05333160	RES.	33K OHM +5% 1/6W
P801	R810		nsp	00MGD05333160	RES.	33K OHM +5% 1/6W
P801	R811		nsp	00MGD05103160	RES.	10K OHM +5% 1/6W
P801	R812		nsp	00MGD05103160	RES.	10K OHM +5% 1/6W
P801	R813		nsp	00MGD05104160	RES.	100K OHM +5% 1/6W
P801	R814		nsp	00MGD05103160	RES.	10K OHM +5% 1/6W
P801	R815		nsp	00MGD05104160	RES.	100K OHM +5% 1/6W
P801	R816		nsp	00MGD05103160	RES.	10K OHM +5% 1/6W
P801	R817		nsp	00MGD05103160	RES.	10K OHM +5% 1/6W
P801	R818		nsp	00MGD05103160	RES.	10K OHM +5% 1/6W
P801	R819		nsp	00MGD05103160	RES.	10K OHM +5% 1/6W
P801	R820		nsp	00MGD05473160	RES.	47K OHM +5% 1/6W
P801	R821		nsp	00MGD05473160	RES.	47K OHM +5% 1/6W
P801	R822		nsp	00MGD05473160	RES.	47K OHM +5% 1/6W

NOTE : "nsp" PART IS LISTED FOR REFERENCE ONLY, MARANTZ WILL NOT SUPPLY THESE PARTS.

P.W.B. NAME	POS. NO.	VERS. COLOR	PART NO. (FOR EUR)	PART NO. (MZ)	PART NAME	DESCRIPTION
P801	R823		nsp	00MGD05473160	RES.	47K OHM +-5% 1/6W
P801	R824		nsp	00MGD05473160	RES.	47K OHM +-5% 1/6W
P801	R825		nsp	00MGD05103160	RES.	10K OHM +-5% 1/6W
P801	R826		nsp	00MGD05103160	RES.	10K OHM +-5% 1/6W
P801	R827		nsp	00MGD05223160	RES.	22K OHM +-5% 1/6W
P801	R828		nsp	00MGD05472160	RES.	4.7K OHM +-5% 1/6W
P801	R829		nsp	00MGD05223160	RES.	22K OHM +-5% 1/6W
					AC INPUT PWB P851 (00MWG23AJ201-)	
P851	▲ C851		00MDF77103500	00MDF77103500	FILM CAP.	! 0.01UF M 250V AC
P851	▲ C852		00MDF77103500	00MDF77103500	FILM CAP.	! 0.01UF M 250V AC
P851	C854		nsp	00MOA47705020	ELECT. CAP.	470 UF M 50V RA-2
P851	C855		nsp	00MOA10805020	ELECT. CAP.	ELNA RA2 16X25
P851	C856		nsp	00MOA10605020	ELECT. CAP.	10 UF M 50V RA-2
P851	C858		nsp	00MOA10605020	ELECT. CAP.	10 UF M 50V RA-2
P851	C859		nsp	00MOA10505020	ELECT. CAP.	1 UF M 50V RA-2
P851	C861		nsp	00MOA106035Z0	ELECT. CAP.	ROS-35V 100M - F3#PE - T2 (10UF 35V)
P851	C862		nsp	00MOA106035Z0	ELECT. CAP.	ROS-35V 100M - F3#PE - T2 (10UF 35V)
P851	▲ D851		00MHD20055100	00MHD20055100	DIODE	! SHOTTKY 11EQS10 1A 100V
P851	▲ D852		00MHD20055100	00MHD20055100	DIODE	! SHOTTKY 11EQS10 1A 100V
P851	▲ D853		00MHD20055100	00MHD20055100	DIODE	! SHOTTKY 11EQS10 1A 100V
P851	▲ D854		00MHD20055100	00MHD20055100	DIODE	! SHOTTKY 11EQS10 1A 100V
P851	▲ D855		00MHD20055100	00MHD20055100	DIODE	! SHOTTKY 11EQS10 1A 100V
P851	▲ D856		00MHD20055100	00MHD20055100	DIODE	! SHOTTKY 11EQS10 1A 100V
P851	▲ D859		00MHD20055100	00MHD20055100	DIODE	! SHOTTKY 11EQS10 1A 100V
P851	▲ F851	F N	nsp	0520100200020	FUSE	! 0218010.MXP
P851	▲ F851	/K1G	nsp	0520100170060	FUSE	# T5A L 250V 02180005MXP
P851	▲ F851	/N1G	0520100170060	0520100170060	FUSE	# T5A L 250V 02180005MXP
P851	▲ F851	/N1S	0520100170060	0520100170060	FUSE	# T5A L 250V 02180005MXP
P851	▲ F851	/U1G	nsp	0520100200020	FUSE	! 0218010.MXP
P851	▲ G851		00MBF68400010	00MBF68400010	CAP.COMP.	! 0.68UF/4.7OHM
P851	J853		00MYJ01004670	00MYJ01004670	JACK	LGY6501-0600 3.5 MINI JACK
P851	▲ L851	F N	nsp	00MTS13521210	TRANSF.	# POWER TRANSF. FOR BACKUP 100V
P851	▲ L851	/K1G	nsp	00MTS13521230	TRANSF.	# POWER TRANSF. FOR BACKUP 230V
P851	▲ L851	/N1G	00MTS13521230	00MTS13521230	TRANSF.	# POWER TRANSF. FOR BACKUP 230V
P851	▲ L851	/N1S	00MTS13521230	00MTS13521230	TRANSF.	# POWER TRANSF. FOR BACKUP 230V
P851	▲ L851	/U1G	nsp	00MTS13521220	TRANSF.	# POWER TRANSF. FOR BACKUP 120V
P851	▲ L852		00MLY10240240	00MLY10240240	RELAY	! VS24MB-NR TV-8 SEMKO LISTED
P851	▲ L853		00MLY10240240	00MLY10240240	RELAY	! VS24MB-NR TV-8 SEMKO LISTED
P851	L854		00MFC90050060	00MFC90050060	FERRITE CORE	FERRIT BEADS (B-01-AT1F)
P851	L855		00MFC90050060	00MFC90050060	FERRITE CORE	FERRIT BEADS (B-01-AT1F)
P851	L856		00MFC90050060	00MFC90050060	FERRITE CORE	FERRIT BEADS (B-01-AT1F)
P851	L857		00MFC90050060	00MFC90050060	FERRITE CORE	FERRIT BEADS (B-01-AT1F)
P851	L858		00MFC90050060	00MFC90050060	FERRITE CORE	FERRIT BEADS (B-01-AT1F)
P851	L859		00MFC90050060	00MFC90050060	FERRITE CORE	FERRIT BEADS (B-01-AT1F)
P851	Q851		00MHT41415100	00MHT41415100	TRS.	2SD1415
P851	Q852		00MHC36J3321F	00MHC36J3321F	IC	BA033T +3.3V 1A TYPE
P851	Q853		00MHT600111B0	00MHT600111B0	TRS.	KTA1267 Y
P851	Q854		00MHT600111B0	00MHT600111B0	TRS.	KTA1267 Y
P851	Q855		00MBA20001000	00MBA20001000	TRS.	DTC114ES/UN4211 10K 10K
P851	Q856		00MBA20001000	00MBA20001000	TRS.	DTC114ES/UN4211 10K 10K
P851	Q857		00MBA10001000	00MBA10001000	TRS.	DTA114ES/UN4111 10K 10K
P851	▲ Q858		00MHW10006320	00MHW10006320	PHOTO UNIT	! PC-817 PHOTO CUPLER 1PAIR
P851	Q859		00MBA20001000	00MBA20001000	TRS.	DTC114ES/UN4211 10K 10K
P851	Q860		00MBA10001000	00MBA10001000	TRS.	DTA114ES/UN4111 10K 10K
P851	Q861		00MBA20001000	00MBA20001000	TRS.	DTC114ES/UN4211 10K 10K
P851	▲ R851		00MNQ15022070	00MNQ15022070	ROTOR RES.	! 2.2 OHM 7W W/TEMP. FUSE
P851	▲ R852		00MNQ15022070	00MNQ15022070	ROTOR RES.	! 2.2 OHM 7W W/TEMP. FUSE
P851	▲ R853		00MGG05010140	00MGG05010140	RES.	! 1 OHM +-5% 1/4W ERD25FYJ1R0T
P851	R855		nsp	00MGD05103160	RES.	10K OHM +-5% 1/6W
P851	R856		nsp	00MGD05103160	RES.	10K OHM +-5% 1/6W
P851	R857		nsp	00MGD05104160	RES.	100K OHM +-5% 1/6W
P851	R858		nsp	00MGD05682160	RES.	6.8K OHM +-5% 1/6W
P851	R859		nsp	00MGD05332160	RES.	3.3K OHM +-5% 1/6W
P851	R861		nsp	00MGD05473160	RES.	47K OHM +-5% 1/6W
P851	R862		nsp	00MGD05473160	RES.	47K OHM +-5% 1/6W
P851	R863		nsp	00MGD05103160	RES.	10K OHM +-5% 1/6W
P851	R864		nsp	00MGD05103160	RES.	10K OHM +-5% 1/6W

NOTE : "nsp" PART IS LISTED FOR REFERENCE ONLY, MARANTZ WILL NOT SUPPLY THESE PARTS.

P.W.B. NAME	POS. NO.	VERS. COLOR	PART NO. (FOR EUR)	PART NO. (MZ)	PART NAME	DESCRIPTION
P851	R868		nsp	00MGD05472160	RES.	4.7K OHM +-5% 1/6W
P851	R869		nsp	00MGD05101160	RES.	100 OHM +-5% 1/6W
P851	R870		nsp	00MGD05103160	RES.	10K OHM +-5% 1/6W
P851	R871		nsp	00MGD05182160	RES.	1.8K OHM +-5% 1/6W
P851	S851		00MSS02021620	00MSS02021620	SLIDE SW	SSSU121700
					HDAM-S3 PWB (00MWG22AJ501-)	
PN01	DN01		00MHZ20014990	00MHZ20014990	CHIP DIODE	KDS122
PN01	DN02		00MHZ20014990	00MHZ20014990	CHIP DIODE	KDS122
PN01	DN03		00MHZ20014990	00MHZ20014990	CHIP DIODE	KDS122
PN01	DN04		00MHZ20014990	00MHZ20014990	CHIP DIODE	KDS122
PN01	JN01		00MYP07005670	00MYP07005670	PLUG	IMSA-6065B-06Z065-PT1
PN01	QN01		00D2710320900	00D2710320900	TRS.	KTA1517-GR-RTK/P
PN01	QN02		00D2730481900	00D2730481900	TRS.	KTC3911S-GR-RTK/P
PN01	QN03		00D2710320900	00D2710320900	TRS.	KTA1517-GR-RTK/P
PN01	QN04		00D2730481900	00D2730481900	TRS.	KTC3911S-GR-RTK/P
PN01	QN05		00D2730481900	00D2730481900	TRS.	KTC3911S-GR-RTK/P
PN01	QN06		00D2710320900	00D2710320900	TRS.	KTA1517-GR-RTK/P
PN01	QN07		00D2730481900	00D2730481900	TRS.	KTC3911S-GR-RTK/P
PN01	QN08		00D2710320900	00D2710320900	TRS.	KTA1517-GR-RTK/P
PN01	RN03		nsp	00MNN05561610	CHIP RES.	560 OHM +-5% 1/16W
PN01	RN04		nsp	00MNN05561610	CHIP RES.	560 OHM +-5% 1/16W
PN01	RN07		nsp	00MNN05393610	CHIP RES.	39K OHM +-5% 1/16W
PN01	RN08		nsp	00MNN05393610	CHIP RES.	39K OHM +-5% 1/16W

NOTE : "nsp" PART IS LISTED FOR REFERENCE ONLY, MARANTZ WILL NOT SUPPLY THESE PARTS.

13. ABOUT REPLACE THE MICROPROCESSOR WITH A NEW ONE

When replaced of the U-PRO (Microprocessor) or the Flash ROM, confirm contents of the following.

PWB Name	Pos. No.	Description	After replaced	Remark
P307	QU01	HD64F3687H FLASH	C	Software: 00M23AJ499A00

After replaced

- A** : Mask ROM (With software). No need write-in of software to the microprocessor.
- B** : Flash ROM (With software). Usually, no need write-in of software. But, when the software was updated, you should be write-in of the new software to the microprocessor or flash ROM. Please check the software version.
- C** : Empty Flash ROM (Without software). You should be write-in of the software to the microprocessor or flash ROM. Refer to "Update procedure" or "writing procedure", when you should be write-in the software.

マイコン等を交換した場合の対応について

U-PRO(マイコン)およびFlash ROM等を交換した場合の対応方法を下記の記載します。

PWB Name	Pos. No.	Description	交換時の対応	備考
P307	QU01	HD64F3687H FLASH	C	Software: 00M23AJ499A00

交換時の対応

- A** : Mask ROM (ソフトウェア書き込み済み) 交換時にソフトウェアの書き込みは必要ありません。
- B** : Flash ROM (ソフトウェア書き込み済み) パージョンアップにより交換時にソフトウェアの書き換えが必要な場合があります。バージョンの確認をしてください。
- C** : 空ROM (Flash ROM) 交換時必ずソフトウェアの書き込みが必要になります。Update、書き込み方法を参照してください。