

SERVICE MANUAL

ST251/ST251L

This service manual explains them by extracting the different specifications from those of the ST440/ST440L, based on the ST440/ST440L. For both electrical and mechanical information on the after-sales service which is not stated, all information is described in the ST440/ST440L service manual. The dispatch of the parts for after-sales service has to be referred to this service manual, with the first priority. For this reason, please use this service manual with referring to the ST440/ST440L service manual, without fail.

Different Parts between MODEL ST251/ST251L and MODEL ST440/ST440L

Page	REF. DESIG.	ST440/ST440L (N, A)	ST251/ST251L (N, A)	DESCRIPTION
18	A	448H248400	473H248400	Front Panel Assembly (ST251) Front Panel Assembly (ST251L) Front Panel (ST251) Front Panel (ST251L) Escutcheon Window Button MEMORY 1~8 Control Board Chassis, Front Packing Case (ST251) Packing Case (ST251L) User Manual User Manual. Spec. Circuit Diagram (ST251) Circuit Diagram (ST251L) AC Power Cord (A only)
	A1	449H248400	474H248400	
	001B	448H248010	473H248010	
	001B	449H248010	474H248010	
	002B	448H063020	473H063020	
	003B	448H158010	473H158010	
	011B	448H270020	448H270220	
	013B	448H127510	448H127530	
	001G	448H105010	473H105010	
	001S	448H801010	473H801010	
	001S	449H801010	474H801010	
	001T	448H851310	473H851310	
	002T	448H851320	473H851320	
003T	448H856010	473H856010		
003T	449H856010	474H856010		
W001	ZC01604010	ZC02006020		
19	002D	51280408U0	51706009U0	Spec. Set Screw
	001F	448H105030	473H105030	Chassis, Main (ST251) Chassis, Main (ST251L) Leg
	001F	449H105010	474H105010	
016F	415H057010	011T057010		
20	CA01	CT12000090	CT10900010	Trimming 9pF
	CA05	DF15471550	DF15391550	Film 390pF
	CA06	DD15180370	DD15150370	Ceramic 15pF
	CA28	DF15223310	DF15153310	Film 0.015μF
	CA37	_____	DD15560300	Ceramic 56pF
	CA38	_____	DD10050300	Ceramic 5pF
	C218	EA10602530	EA10601610	Elect 10μF 16V
	C219	EA22505030	EA10601610	Elect 10μF 16V
	C501	DD15470300	DD15180370	Ceramic 18pF
	C502	DD15470300	DD15180370	Ceramic 18pF
	C506	DK18103300	EA10701610	Elect 100μF 16V
	C512	DK18103310	EA10505010	Elect 1μF 50V
	C513	EA33601630	EA10701610	Elect 100μF 16V
	C516	_____	DK18103310	Ceramic 0.01μF
	C517	_____	DK18103310	Ceramic 0.01μF
	C805	EA22701030	EA10601610	Elect 10μF 16V
	C813	_____	EA10601610	Elect 10μF 16V

Different Parts between MODEL ST251/ST251L and MODEL ST440/ST440L

Page	REF. DESIG.	ST440/ST440L (N, A)	ST251/ST251L (N, A)	DESCRIPTION
21	RA12 RA13 R101 R202 R206 R220 R227 R521 R522 R804 R810	GD05101140 GD05153140 _____ GD05181140 GD05681140 GD05222140 _____ _____ _____ GD05102140 GD05394140	GD05470140 GD05102140 GD05221140 GG05101140 GD05471140 GD05470140 GD05104140 GD05331140 GD05471140 GD05221140 _____	47Ω 1KΩ 220Ω 100Ω 470Ω 47Ω 100KΩ 330Ω 470Ω 220Ω Delete
22	DA01 DA07 DA08 D205 D504 QA03 ? QA07 Q202 Q203 Q302 Q303 ? Q306 Q501 Q503 Q504 Q505 Q507 ? Q510 Q805 A101 A101 A101 FA02 FA02 J102 X501 RS11	HD40003420 _____ _____ _____ HD20001000 HT327852D0 HT327852D0 HT327852D0 HT111752D0 HT327852D0 _____ HT327852D0 HT111752D0 HT111752D0 HT327852D0 HT327852D0 AV01202130 _____ FF10045320 _____ YT02020280 XB115001L2 GD05331140	HD40006030 HD40006030 HD20001000 HD10003020 _____ HT30001000 HT30001000 HT30001000 HT10001000 HT30001000 HC10070050 HT30001000 HT10001000 HT10001000 HT30001000 HT30001000 _____ AV01202130 AV01202180 _____ FF10045270 YT02020380 XI01150010 GD05271140	Varicap SVC321SP Varicap SVC321SP Diode 1S1555 Diode 20A90 Delete Transistor 2SC2785, 2SC536SP etc. Transistor 2SC2785, 2SC536SP etc. Transistor 2SC2785, 2SC536SP etc. Transistor 2SA1175, 2SA608SP etc. Transistor 2SC2785, 2SC536SP etc. IC TC9147BP (ST251L) Transistor 2SC2785, 2SC536SP etc. Transistor 2SA1175, 2SA608SP etc. Transistor 2SA1175, 2SA608SP etc. Transistor 2SC2785, 2SC536SP etc. Transistor 2SC2785, 2SC536SP etc. Delete (N, A) V.H.F. Tuner (ST251L) V.H.F. Tuner (N, A) Delete (ST251) Ceramic Filter (ST251L) Terminal Output Crystal 7.2MHz 270Ω
23	QS03 QS04 ? QS06	HT111752D0 HT327852D0	HT10001000 HT30001000	Transistor 2SA1175, 2SA608SP etc. Transistor 2SC2785, 2SC536SP etc.

TECHNICAL SPECIFICATIONS

FM TUNER SECTION

Frequency Range	87.5 ~108 MHz
Usable Sensitivity	
Mono (S/N 26 dB, 75 ohms)	0.9 μ V
Stereo (S/N 46 dB, 75 ohms)	25 μ V
Alternate Channel Selectivity 98 MHz	60 dB
Image Response Rejection	50 dB
IF Rejection	75 dB
Spurious Response Rejection	75 dB
AM Suppression	55 dB
Signal-to-Noise Ratio	
Unweighted	
Mono	75 dB
Stereo	64 dB
Weighted	
Mono	76 dB
Stereo	68 dB
Pilot Signal & Subcarrier Rejection	
19 kHz	35 dB
38 kHz	45 dB
Total Harmonic Distortion	
Mono	0.1%
Stereo	0.2%
Frequency Response	
30 Hz ~15 kHz	+0.5 dB, -1.5 dB
Separation	
Stereo	45 dB
Channel Balance	0.2 dB

MW TUNER SECTION

Frequency Range	531 ~1602 kHz
Usable Sensitivity 20 dB S/N 30% Mod., 999 kHz	400 μ V/m
Selectivity 999 kHz, \pm 9 kHz	30 dB
Image Rejection, 999 kHz	40 dB
IF Rejection, 999 kHz	60 dB
Signal-to-Noise Ratio, 999 kHz	54 dB
Total Harmonic Distortion, 999 kHz	0.3%

LW TUNER SECTION

Frequency Range	153 ~281 kHz
Usable Sensitivity 20 dB S/N 30% Mod., 250 kHz	800 μ V/m
Image Rejection, 250 kHz	50 dB
IF Rejection, 250 kHz	70 dB
Signal-to-Noise Ratio, 250 kHz	50 dB

GENERAL

Power Requirements (ST440)	110-120/220-240V AC, 50/60 Hz
(ST440L)	220-240V AC, 50/60 Hz
Power Consumption	10 W
Dimensions	
Panel Width	

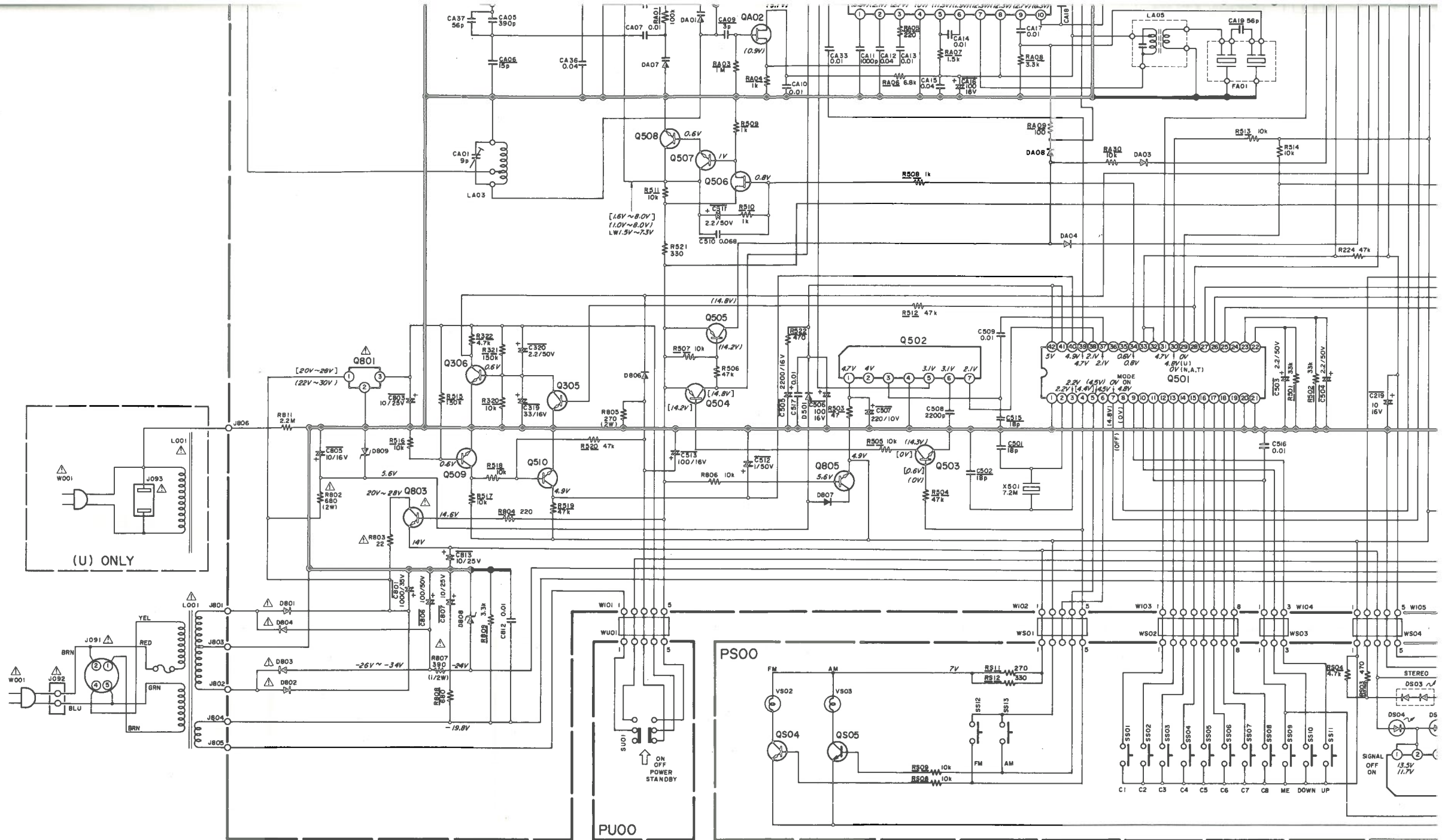

J091	BY05060060	VOLTAGE SELECTOR	S101	SS02020730	SLIDE SWITCH SCAN/MODE
J092	YP04000580	PLUG AC INLET	S102	SP02010630	PUSH SWITCH SCAN/MODE
L001	TS14138020	POWER TRANSF.	VS01	HQ30703060	DISPLAY UNIT
L051	LA00035010	ANT. COIL LOOP	VS02	IN10080620	LAMP.
W001	ZC02006020	A.C. POWER CORD [A]	VS03	IN10080620	LAMP.
W001	ZC01805010	A.C. POWER CORD [N]	X501	XI01150010	CRYSTAL 7.2MHZ
A101	AV01202180	V.H.F. TUNER FE407-G23	J101	YT01050040	TERMINAL FM ANT.
CA01	CT10900010	TRIMMING CAP. 9pF	J102	YT02020380	TERMINAL OUTPUT JACK
FA01	FF10045320	CERAMIC FILTER SFZ450F3L	LA01	LO10013170	OSC COIL (AM)
F201	FF11070620	CERAMIC FILTER SFE10.7MS3-A	LA03	LA10295070	ANT. COIL (AM)
F202	FF11070620	CERAMIC FILTER SFE10.7MS3-A	LA05	LI10013210	I.F.T. (AM)
RA14	RA02230600	TRIMMING 22KΩ	L201	LI20029040	I.F.T. (FM)
R216	RA04730600	TRIMMING 47KΩ	L202	LS10295030	M.P.X. COIL
R303	RA04720600	TRIMMING 4.7KΩ			
R317	RA02240600	TRIMMING 220KΩ			
SS01	SP01010570	PUSH SWITCH			
SS13	SP02011000	PUSH SWITCH POWER			
SU01	SP02011000	PUSH SWITCH POWER			

NOTE ON SAFETY :

Symbol Δ Fire or electrical shock hazard. Only original parts should be used to replace any part marked with symbol Δ . Any other component substitution (other than original type), may increase risk of fire or electrical shock hazard.

"SERVICE IN ANY MISC REPAIR BY

R*** (1) G
R*** (2) G
C*** : C
(1) D

C*** : C
(1) D

Model ST251

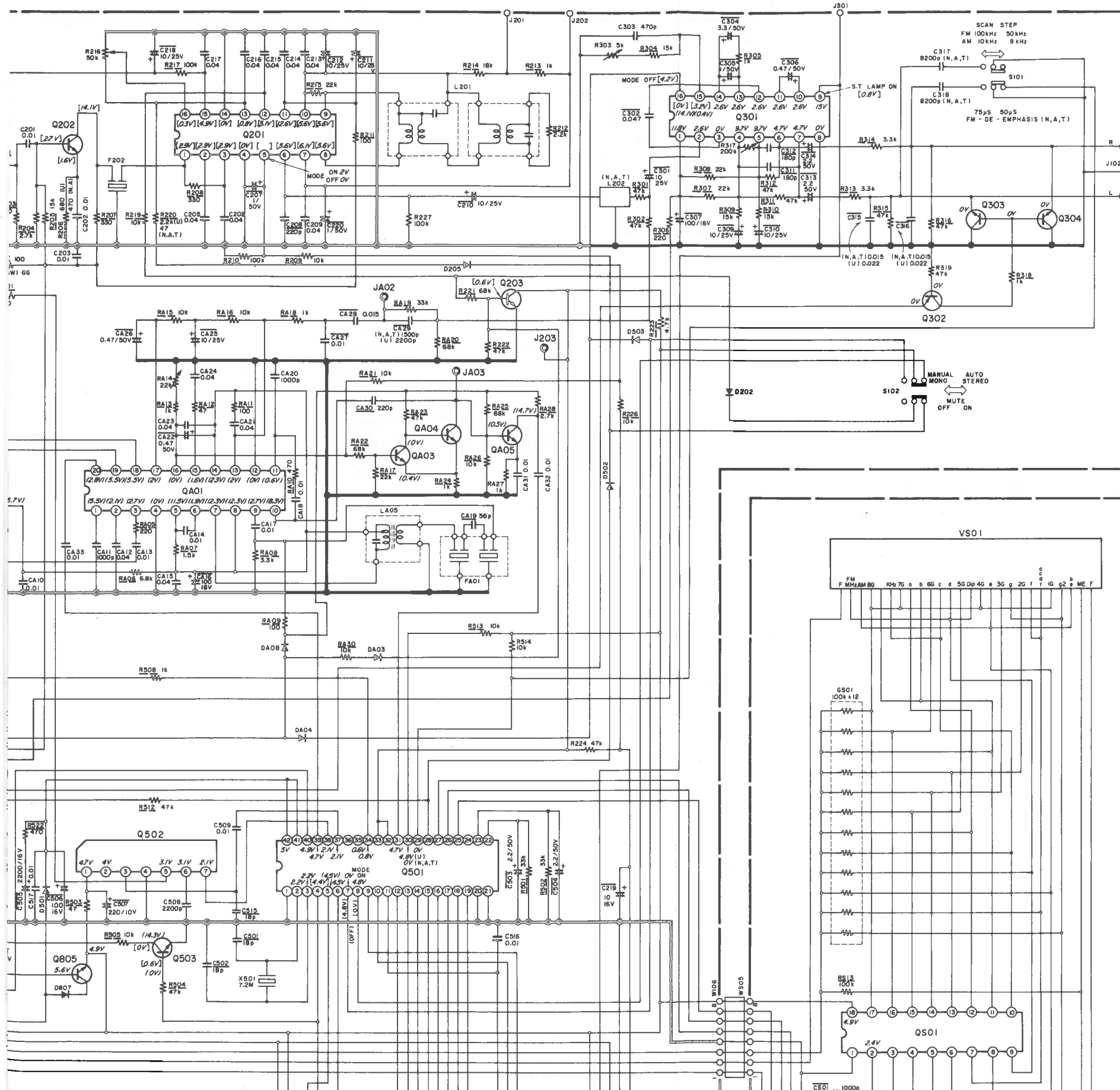

QA01
HC1005803-0
LA1245

QA02
HF200551D-0
2SK55D

QA03,QA04,QA05,Q504
Q505,Q506,Q202
Q203,Q303,Q304
Q305,Q306,Q503,Q510
Q507,Q508,Q805,Q509
HT30001000
2SC536SP, 2SC2458
2SC2787, 2SC1740C

QA08,QA09
HT409852B-0
2SD985L.K

Q501
HC1010805-0
TC9158P

Q502
HC1006202-0
AN6876

Q503
Q302,Q504,Q505
HT10001000
2SA608SP
2SA1048, 2SA1175
2SA933S

Q201
HC1002803-0
LA1231N

Q301
HC1004602-0
AN7470

Q501 (N.A.)
HC1009605-0
TC9157P

Q502
HC1007205-0
TD6104P

Q506
HF200300B-0
2SK30AY1

Q801
HC1007703-0
L78M15

Q803
HT403131D-0
2SD313D

D202,DA03,DA04
D501,D502,D503
DA08,D806,D807
HD2000100-0
1S1555, 1S2473, DS448
MA155 ETC.

DA01
HD4000603-0
SVC321SP

D801,D802
D803,D804
HD2002203-0
DSF10C

D809
HD3000502-0
MA1056

D205
HD10003020
20A90

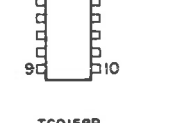
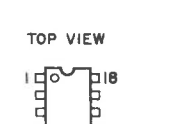
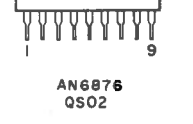
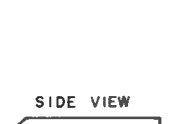
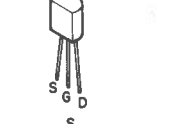
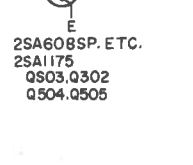
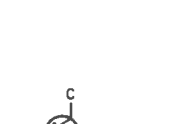
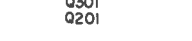
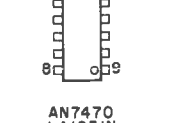
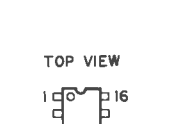
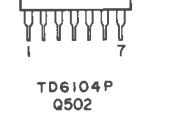
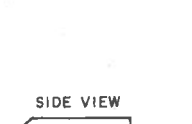
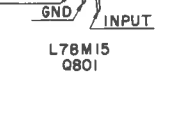
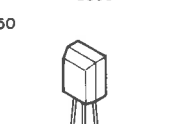
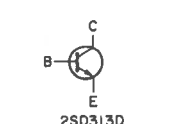
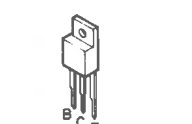
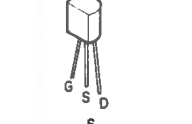
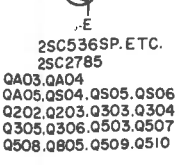
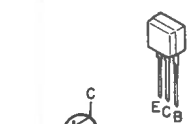

D205
HD10003020
20A90

AN7470
LA1231N
Q301
Q201

TC9158P
Q501

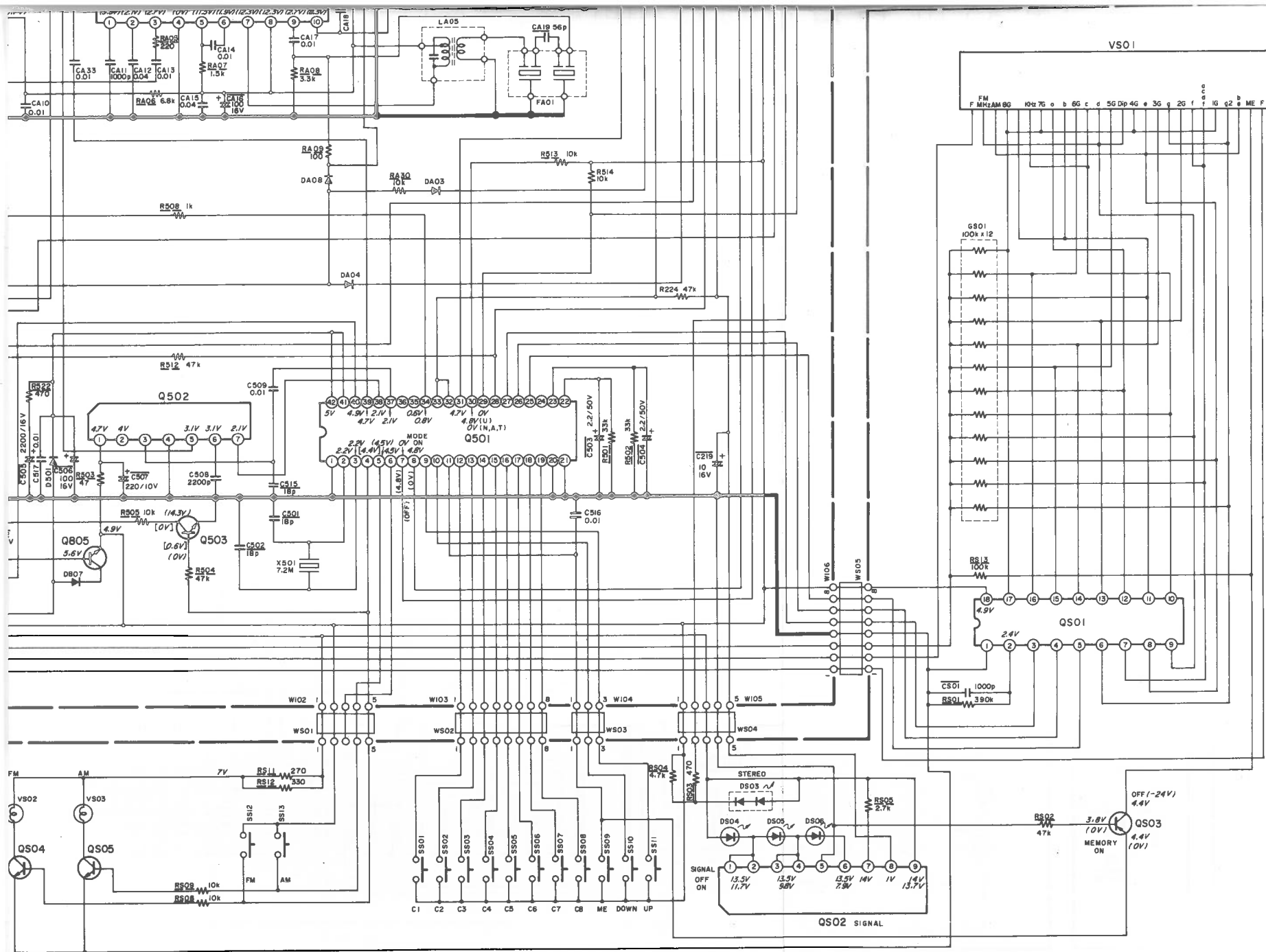

- Q301 HC1004602-0 AN7470
- Q501 (N.A) HC1009605-0 TC9157P
- Q501 (U) HC10070050 TC9147BP
- Q502 HC1007205-0 TD6104P
- Q506 HF2003008-0 25K30AY1
- Q801 HC1007703-0 L78M15
- Q803 HT40313D-0 25D313D
- D202, DA03, DA04 D501, D502, D503 DA08, D806, D807 HD2000100-0 1S1555, 1S2473, DS448 MA150 ETC.
- DA01 HD400603-0 SVC321SP
- D801, D802 D803, D804 HD2002203-0 DSF10C
- D809 HD3000502-0 MA1056
- D205 HD10003020 20A90

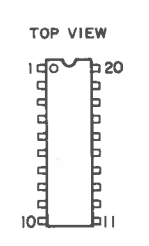
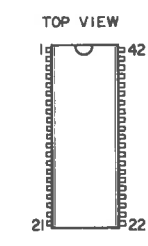
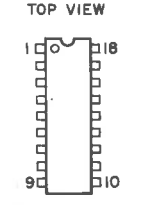
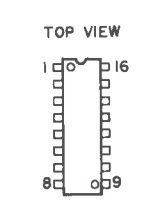
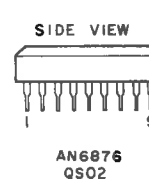
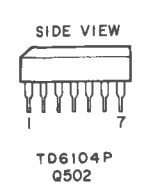
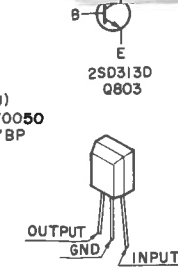

- SELECTOR S101 SS02020730 SLIDE SWITCH SCAN/MODE
- NLET S102 SP02010630 PUSH SWITCH SCAN/MODE
- ANSF. VS01 HQ30703060 DISPLAY UNIT
- LOOP VS02 IN10080620 LAMP.
- CORD [A] VS03 IN10080620 LAMP.
- CORD [N] X501 XI01150010 CRYSTAL 7.2MHz
- ER FE407-G23 J101 YT01050040 TERMINAL FM ANT.
- CAP. 9pF J102 YT02020380 TERMINAL OUTPUT JACK
- FILTER SFZ450F3L LA01 LO10013170 OSC COIL (AM)
- FILTER SFE10.7MS3-A LA03 LA10295070 ANT. COIL (AM)
- FILTER SFE10.7MS3-A LA05 LI10013210 I.F.T. (AM)
- 22KΩ L201 LI20029040 I.F.T. (FM)
- 47KΩ L202 LS10295030 M.P.X. COIL
- 4.7KΩ
- 220KΩ

"SERVICE INFORMATION IS FOR USE BY QUALIFIED PERSONNEL ONLY - ANY MISADJUSTMENT OR MISALIGNMENT MAY BE TREATED AS A NON-WARRANTY REPAIR BY ANY MARANTZ SERVICE CENTRE -"

Kind of Common Parts

- RESISTOR**
- R*** (1) GD05 --- 140, Carbon film fixed resistor, ±5% 1/4W
- R*** (2) GD05 --- 160, Carbon film fixed resistor, ±5% 1/6W
- C*** : CERAMIC CAP.**
- (1) DD1 ---- 370, Ceramic condenser, disc type (titan condenser) Temp. coeff. P350 ~ N1000 50V
- C*** : CERAMIC CAP.**
- (1) DK16 --- 300, High dielectric constant ceramic condenser, disc type (titan variable) Temp. chara. 2B4 50V

- C*** : ELECTROLY CAP. (E) / FILM CAP. (F)**
- (1) EA ----- 10, Electrolytic condenser, one-way lead type, tolerance ±20%
- (2) DF15 --- 350, Plastic film condenser, one-way type, Mylar, ±5% 50V

*In case of ordering the common parts, please establish the correct parts number of 10 figures by the procedure "ASSIGNMENT OF COMMON PARTS CODES"

CH
CH POWER

Components and wiring are subject to change for modification without notice.

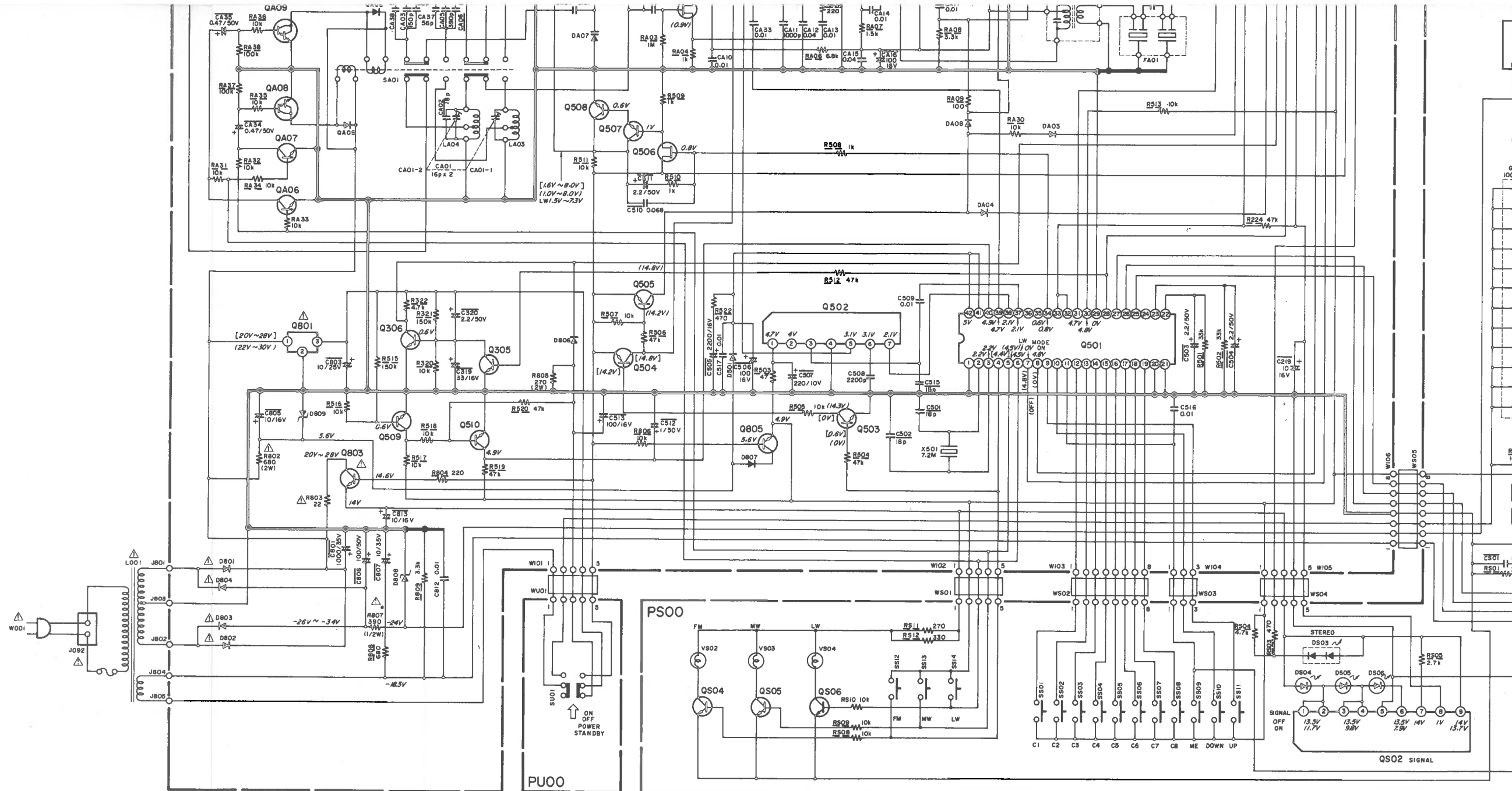

NOTE ON SAFETY :

Symbol Δ Fire or electrical shock hazard. Only original parts should be used to replace any part marked with symbol Δ . Any other component substitution (other than original type), may increase risk of fire or electrical shock hazard.

J092	YP04000580	PLUG AC INLET	RA14	RA02230600	TRIMMING 22K Ω
L001	TS14138030	POWER TRANSF.	R216	RA04730600	TRIMMING 47K Ω
L051	LA00035010	ANT. COIL LOOP	R303	RA04720600	TRIMMING 4.7K Ω
W001	ZC01805010	AC POWER CORD	R317	RA02240600	TRIMMING 220K Ω
A101	AV01202130	V.H.F. TUNER FE306-A14	SA01	SZ04240010	SOLENOID SWITCH
CA01	CT21400010	TRIMMING CAP.	SS01		
FA01	FF10045320	CERAMIC FILTER SFZ450F3L		SP01010570	PUSH SWITCH
FA02	FF10045270	CERAMIC FILTER BFU-450C	SS14		
F201	FF11070620	CERAMIC FILTER SFE10.7MS3-A	SU01	SP02011000	PUSH SWITCH POWER
F202	FF11070620	CERAMIC FILTER SFE10.7MS3-A	S102	SP02010630	PUSH SWITCH SCAN/MODE
J101	YT01050040	TERMINAL FM ANT.	VS01	HQ30704060	DISPLAY UNIT
J102	YT02020380	TERMINAL OUTPUT JACK	VS02		
LA01	LO10013170	OSC COIL (MW)		IN10080620	LAMP.
LA02	LO10013180	OSC COIL (LW)	VS04		
LA03	LA10295070	ANT. COIL (MW)	X501	XI01150010	CRYSTAL 7.2MHZ
LA04	LA10295080	ANT. COIL (LW)			
LA05	LI10013210	I.F.T. (AM)			
L201	LI20029040	I.F.T. (FM)			
L202	LS10295030	M.P.X. COIL			

"SERVICE INFORMATION IS FOR ANY MISADJUSTMENT OR MISAL REPAIR BY ANY MARANTZ SERV

Kind of Comm

RESISTOR

R*** (1) GD05 --- 140, Carbon fi
 R*** (2) GD05 --- 160, Carbon fi
 C*** : CERAMIC CAP.
 (1) DD1 --- 370, Ceramic c
 disc type
 Temp. co

C*** : CERAMIC CAP.
 (1) DK16 --- 300, High diele
 disc type
 Temp. ch

Components and wiring are subject to change for modification without notice.

Model ST251L

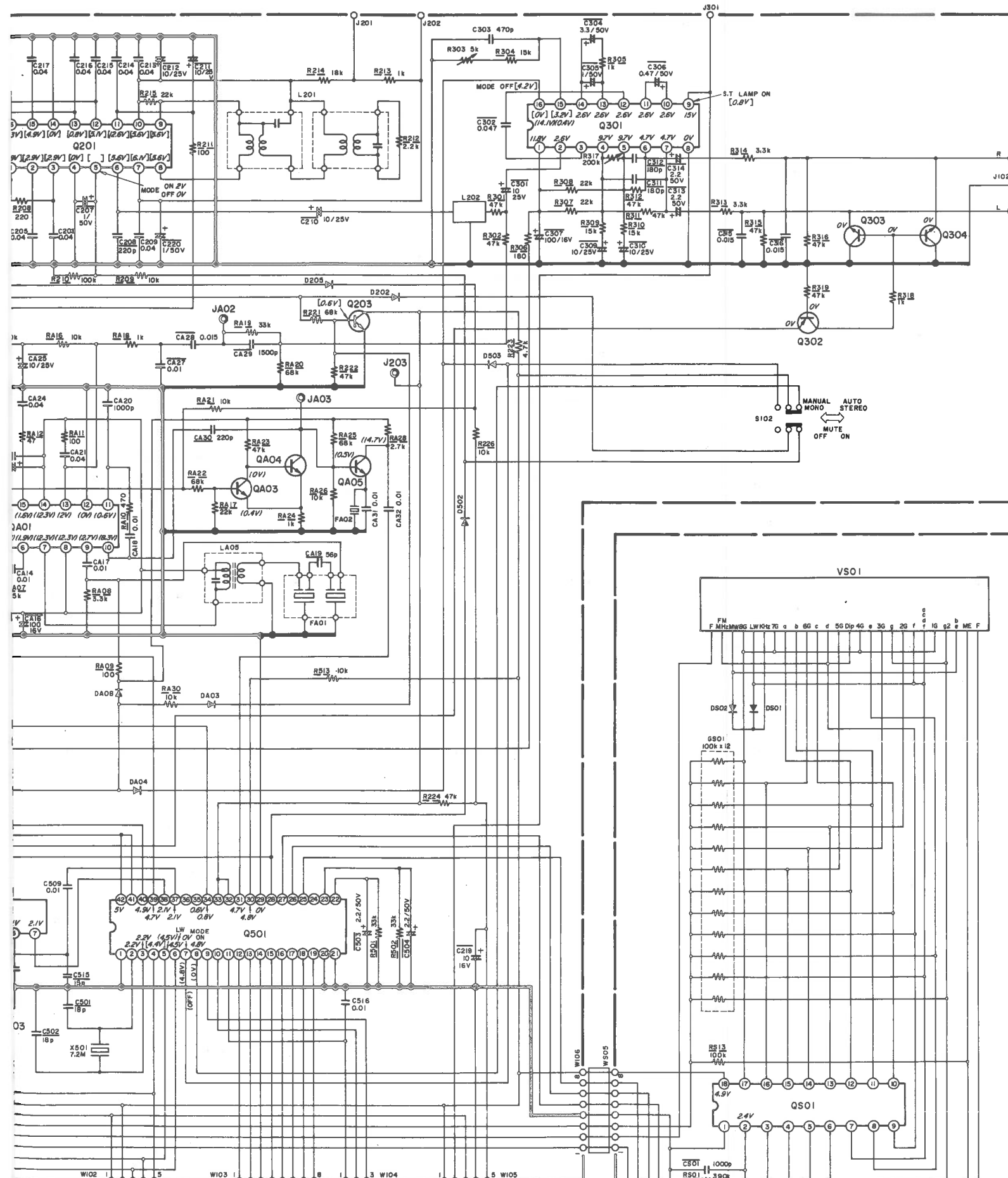

QA01
HC1005803-0
LA1245

QA02
HF200551D-0
2SK55D

QA03,QA04,QA05
QA06,QA07,QA04
QS05,QA06,Q202
Q203,Q303,Q304
Q305,Q306,Q503,Q510
Q507,Q508,Q805,Q509
HD30001000
2SC536SP, 2SC245B
2SC2785, 2SC1740C

QA08,QA09
HT409852B-0
2SD985L.K

QS01
HC1010805-0
TC9158P

QS02
HC1006202-0
AN6876

QS03
Q302,Q504,Q505
HT10001000
2SA608SP
2SA1048, 2SA1175
2SA9335

Q201
HC1002803-0
LA1231N

Q301
HC1004602-0
AN7470

Q501
HC10070050
TC9147BP

Q502
HC1007205-0
TD6104P

Q506
HF200300B-0
2SK30AY1

Q801
HC1007703-0
L78M15

Q803
HT403131D-0
2SD313D

D202,DA03,DA04
D501,D502,D503
DA08,DB06,DB07
HD2002203-0
1S1555,1S2473,DS448
MA150 ETC.

DA01
HD40006030
SVC321SP

D801,D802
D803,D804
HD2002203-0
DSF10C

D809
HD3000502-0
MA1056

D205
HD10003020
20A90

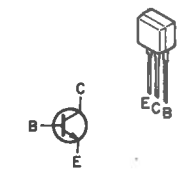

2SC536SP, ETC.
2SC2785
QA03,QA04,QA05,QA06
QA07,QA08,QA09,QA06
Q202,Q203,Q303,Q304
Q305,Q306,Q503,Q507
Q508,Q805,Q509,Q510



2SA608SP, ETC.
2SA1175
QS03,Q302
Q504,Q505

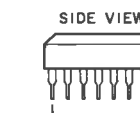
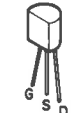

TD6104P
QS02

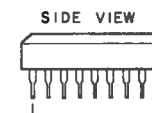

AN6876
QS02

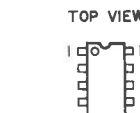

AN7470
LA1231N
Q301
Q201

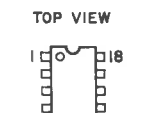

TC9158P
QS01

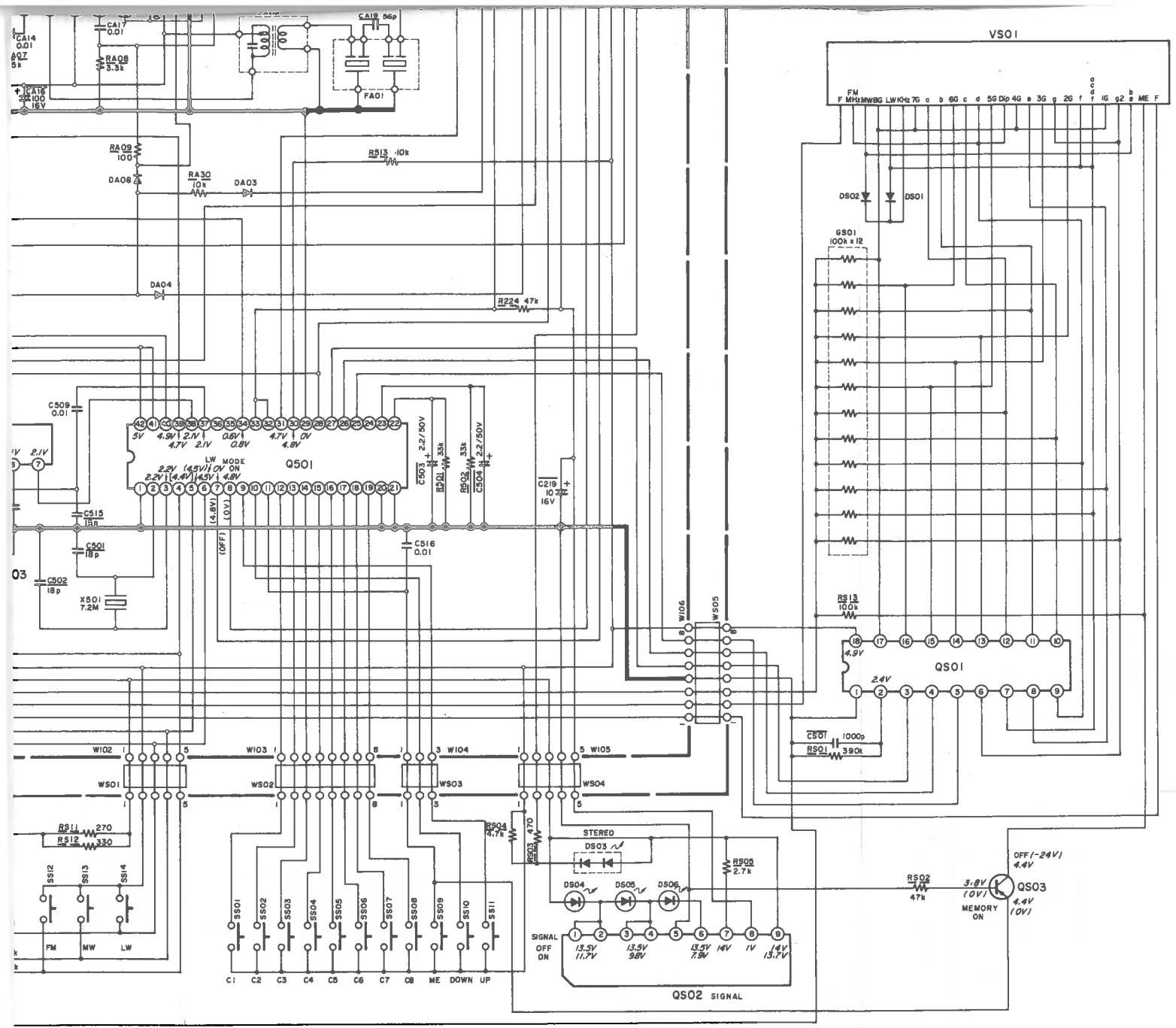

- Q301 HC1004602-0 AN7470
- Q501 HC10070050 TC9147BP
- Q502 HC1007205-0 TD6104P
- Q506 HF200300B-0 2SK30AY1
- Q801 HC1007703-0 L78M15
- Q803 HT403131D-0 2SD313D
- D202, DA03, DA04 D501, D502, D503 DA08, D806, D807 HD2000100-0 IS1555, IS2473, DS448 MA150 ETC.
- DA01 HD40006030 SVC321SP
- D801, D802 D803, D804 HD2002203-0 DSF10C
- D809 HD3000502-0 MA1056
- D205 HD10003020 20A90

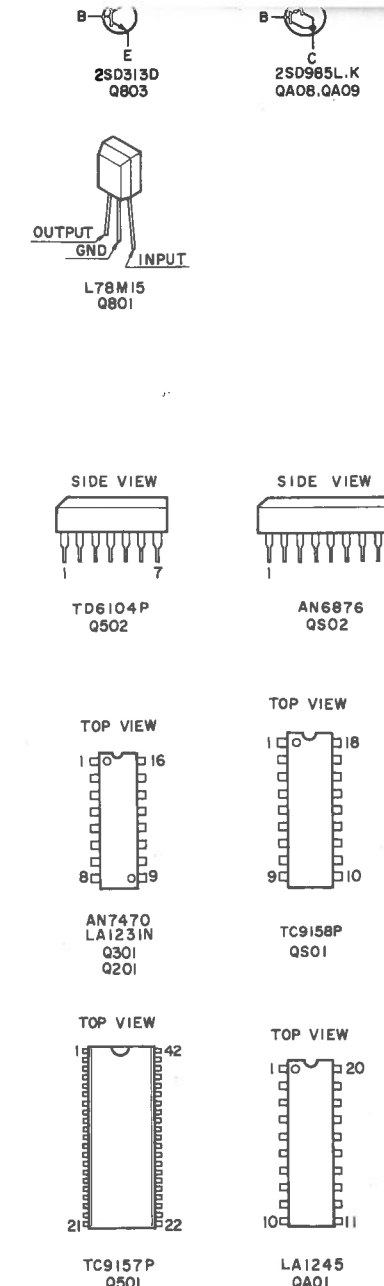

- RA02230600 TRIMMING 22KΩ
- RA04730600 TRIMMING 47KΩ
- RA04720600 TRIMMING 4.7KΩ
- RA02240600 TRIMMING 220KΩ
- SZ04240010 SOLENOID SWITCH
- SP01010570 PUSH SWITCH
- SP02011000 PUSH SWITCH POWER
- SP02010630 PUSH SWITCH SCAN/MODE
- HQ30704060 DISPLAY UNIT
- IN10080620 LAMP.
- XI01150010 CRYSTAL 7.2MHz

"SERVICE INFORMATION IS FOR USE BY QUALIFIED PERSONNEL ONLY – ANY MISADJUSTMENT OR MISALIGNMENT MAY BE TREATED AS A NON-WARRANTY REPAIR BY ANY MARANTZ SERVICE CENTRE –"

Kind of Common Parts

- RESISTOR**
- R*** (1) GD05 --- 140, Carbon film fixed resistor, ±5% 1/4W
 - R*** (2) GD05 --- 160, Carbon film fixed resistor, ±5% 1/6W
- C*** : CERAMIC CAP.**
- (1) DD1 --- 370, Ceramic condenser, disc type (titan condenser) Temp. coeff. P350 ~ N1000 50V
- C*** : CERAMIC CAP.**
- (1) DK16 --- 300, High dielectric constant ceramic condenser, disc type (titan variable) Temp. chara. 2B4 50V

- ELECTROLY CAP. (E) / FILM CAP. (F)**
- (1) EA --- 10, Electrolytic condenser, one-way lead type, tolerance ±20%
 - (2) DF15 --- 350, Plastic film condenser, one-way type, Mylar, ±5% 50V

* In case of ordering the common parts, please establish the correct parts number of 10 figures by the procedure "ASSIGNMENT OF COMMON PARTS CODES"

Components and wiring are subject to change for modification without notice.



marantz®