

Service Manual

UD9004 /U1B/N1B/S1B/R1B

SUPER AUDIO CD/
BLU-RAY DISC PLAYER

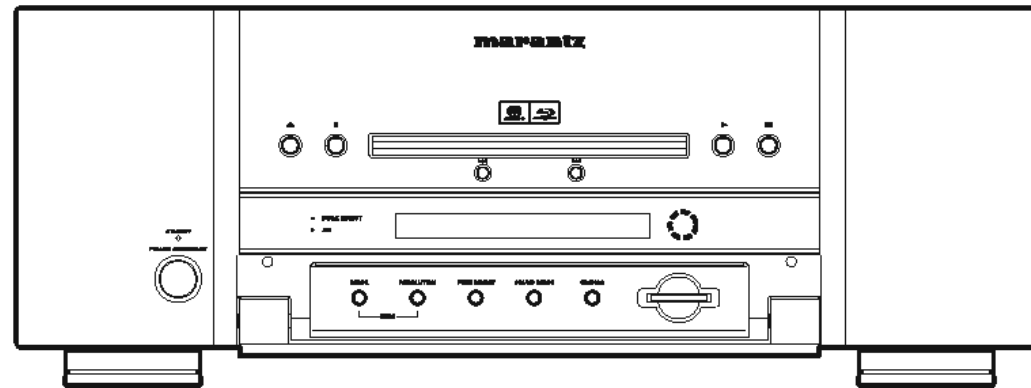

TABLE OF CONTENTS

SECTION	PAGE
SERVICE HINTS AND TOOLS.....	1
SAFETY PRECAUTIONS.....	2
DIMENSION.....	3
WIRE ARRANGEMENT.....	4
DISASSEMBLY.....	5
AJUSTING THE POSITION OF THE LOADER PANEL.....	16
DIAGNOSTICS OF OPTICAL PICKUP AND REPLACING FE MAIN P.W.B AND BD MECHANISM UNIT ASSY.....	17
SERVICE MODE.....	19
VERSION UPGRADE PROCEDURE OF FIRMWARE.....	29
TROUBLE SHOOTING.....	33
BLOCK DIAGRAM.....	45
SEMICONDUCTORS.....	47
PRINTED WIRING BOARDS.....	69
NOTE FOR PARTS LIST.....	81
PARTS LIST OF P.W.B. UNIT.....	82
WIRING DIAGRAM.....	129
EXPLODED VIEW.....	130
PARTS LIST OF EXPLODED VIEW.....	131
EXPLODED VIEW OF SACD MECHANISM.....	133
POINTS OF GREASING.....	134
PARTS LIST OF EXPLODED VIEW OF SACD MECHANISM.....	135
PACKING VIEW.....	137
PARTS LIST OF PACKING & ACCESSORIES.....	138
MEASURING METHOD AND WAVEFORMS.....	139
NOTE FOR SCHEMATIC DIAGRAM.....	144
SCHEMATIC DIAGRAMS.....	145

Please use this service manual with referring to the user guide (D.F.U.) without fail.

marantz®

UD9004

Ver.3

Please refer to
MODIFICATION NOTICE

MARANTZ DESIGN AND SERVICE

Using superior design and selected high grade components, **MARANTZ** company has created the ultimate in stereo sound. Only original **MARANTZ** parts can insure that your **MARANTZ** product will continue to perform to the specifications for which it is famous.

Parts for your **MARANTZ** equipment are generally available to our National Marantz Subsidiary or Agent.

ORDERING PARTS :



Parts can be ordered either by mail or by Fax.. In both cases, the correct part number has to be specified.

The following information must be supplied to eliminate delays in processing your order :

1. Complete address
2. Complete part numbers and quantities required
3. Description of parts
4. Model number for which part is required
5. Way of shipment
6. Signature : any order form or Fax. must be signed, otherwise such part order will be considered as null and void.

USA MARANTZ AMERICA, INC 100 CORPORATE DRIVE MAHWAH, NEW JERSEY 07430 USA	EUROPE / TRADING D&M EUROPE B. V. P. O. BOX 8744, BUILDING SILVERPOINT BEEMDSTRAAT 11, 5653 MA EINDHOVEN THE NETHERLANDS PHONE +31 - 40 - 2507844 FAX : +31 - 40 - 2507860	CANADA D&M Canada Inc. 5-505 APPLE CREEK BLVD. MARKHAM, ONTARIO L3R 5B1 CANADA PHONE : 905 - 415 - 9292 FAX : 905 - 475 - 4159
JAPAN D&M Holdings Inc. D&M BUILDING, 2-1 NISSHIN-CHO, KAWASAKI-KU, KAWASAKI-SHI, KANAGAWA, 210-8569 JAPAN	株式会社 ディーアンドエムホールディングス 本 社 〒210-8569 神奈川県川崎市川崎区日進町2-1 D&Mビル	KOREA D&M SALES AND MARKETING KOREA LTD. 2F, YEON BLDG., 88-5, BANPO-DONG, SEOCHO-GU, SEOUL KOREA PHONE : +82 - 2 - 715 - 9041 FAX : +82 - 2 - 715 - 9040
		CHINA D&M SALES AND MARKETING SHANGHAI LTD. ROOM 808 SHANGHAI AIRPORT CITY TERMINAL NO 1600 NANJING (WEST) ROAD, SHANGHAI, CHINA, 200040 TEL : 021 - 6248 - 5151 FAX : 021 - 6248 - 4434

NOTE ON SAFETY :

Symbol  Fire or electrical shock hazard. Only original parts should be used to replaced any part marked with symbol . Any other component substitution (other than original type), may increase risk of fire or electrical shock hazard.

安全上の注意 :

がついている部品は、安全上重要な部品です。必ず指定されている部品番号のものを使用して下さい。

SHOCK, FIRE HAZARD SERVICE TEST :

CAUTION : After servicing this appliance and prior to returning to customer, measure the resistance between either primary AC cord connector pins (with unit NOT connected to AC mains and its Power switch ON), and the face or Front Panel of product and controls and chassis bottom.

Any resistance measurement less than 1 Megohms should cause unit to be repaired or corrected before AC power is applied, and verified before it is return to the user/customer.

Ref. UL Standard No. 60065.

In case of difficulties, do not hesitate to contact the Technical Department at above mentioned address.

SERVICE HINTS AND TOOLS

SERVICE HINTS

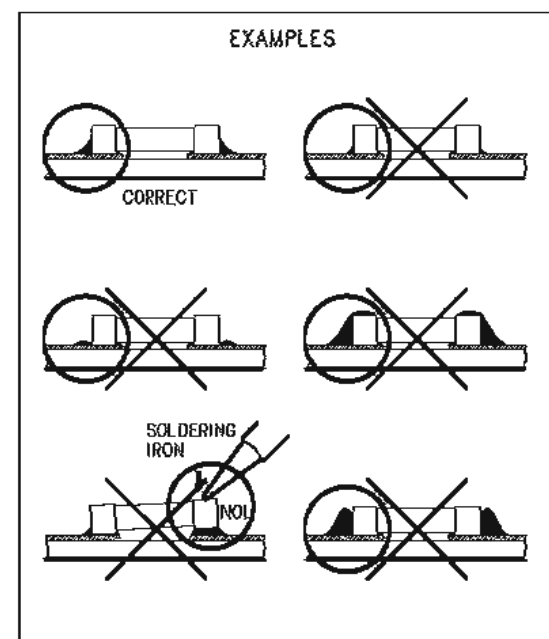
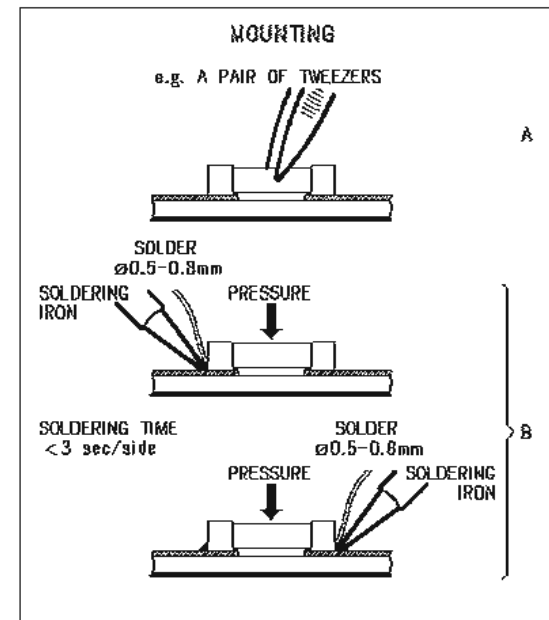
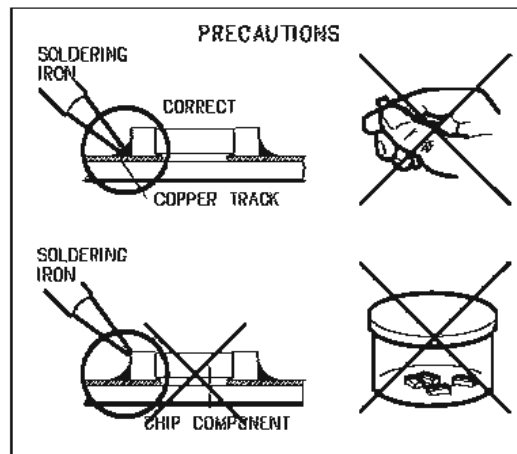
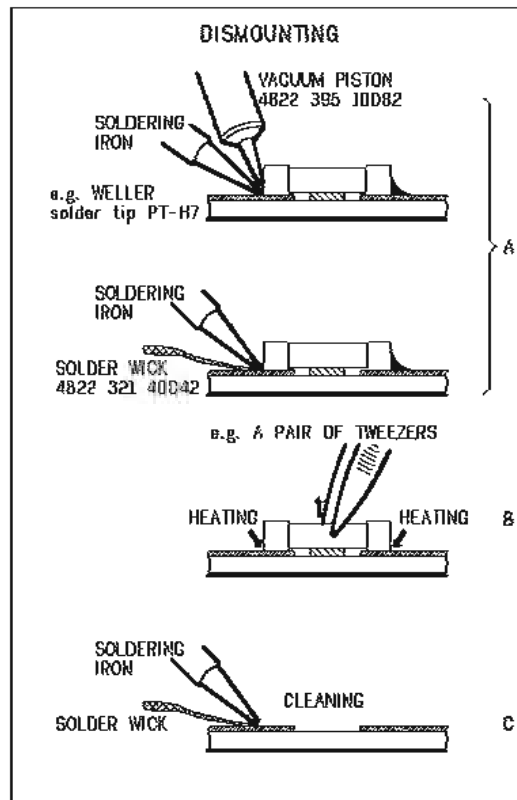
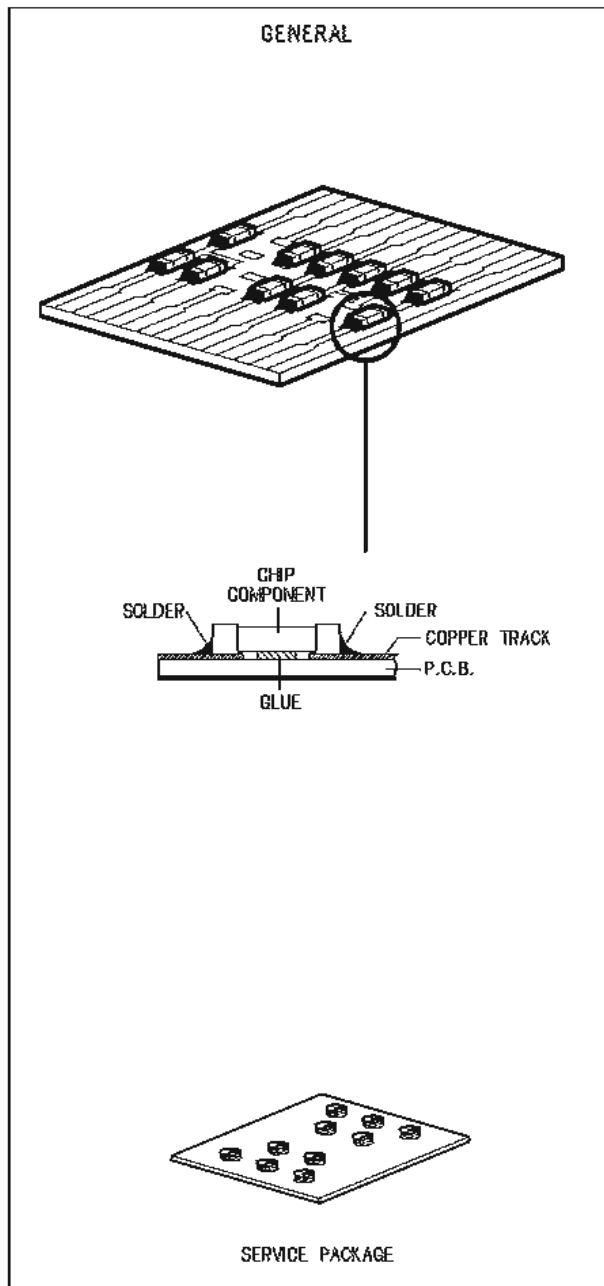

SAFETY PRECAUTIONS

The following check should be performed for the continued protection of the customer and service technician.

LEAKAGE CURRENT CHECK

Before returning the unit to the customer, make sure you make either (1) a leakage current check or (2) a line to chassis resistance check. If the leakage current exceeds 0.5 milliamps, or if the resistance from chassis to either side of the power cord is less than 460 kohms, the unit is defective.

LASER RADIATION

Caution - Class 1M visible and invisible laser radiation when open.

Do not view directly optical instruments.

CAUTION

Please heed the points listed below during servicing and inspection.

◎ Heed the cautions!

Spots requiring particular attention when servicing, such as the cabinet, parts, chassis, etc., have cautions indicated on labels. Be sure to heed these cautions and the cautions indicated in the handling instructions.

◎ Caution concerning electric shock!

- (1) An AC voltage is impressed on this set, so touching internal metal parts when the set is energized could cause electric shock. Take care to avoid electric shock, by for example using an isolating transformer and gloves when servicing while the set is energized, unplugging the power cord when replacing parts, etc.
- (2) There are high voltage parts inside. Handle with extra care when the set is energized.

◎ Caution concerning disassembly and assembly!

Through great care is taken when manufacturing parts from sheet metal, there may in some rare cases be burrs on the edges of parts which could cause injury if fingers are moved across them. Use gloves to protect your hands.

◎ Only use designated parts!

The set's parts have specific safety properties (fire resistance, voltage resistance, etc.). For replacement parts, be sure to use parts which have the same properties. In particular, for the important safety parts that are marked \triangle on wiring diagrams and parts lists, be sure to use the designated parts.

◎ Be sure to mount parts and arrange the wires as they were originally!

For safety reasons, some parts use tape, tubes or other insulating materials, and some parts are mounted away from the surface of printed circuit boards. Care is also taken with the positions of the wires and clamps are used to keep wires away from heating and high voltage parts, so be sure to set everything back as it was originally.

◎ Inspect for safety after servicing!

Check that all screws, parts and wires removed or disconnected for servicing have been put back in their original positions, inspect that no parts around the area that has been serviced have been negatively affected, conduct an insulation check on the external metal connectors and between the blades of the power plug, and otherwise check that safety is ensured.

(Insulation check procedure)

Unplug the power cord from the power outlet, disconnect the antenna, plugs, etc., and turn the power switch on. Using a 500V insulation resistance tester, check that the inplug and the externally exposed metal parts (antenna terminal, headphones terminal, input terminal, etc.) is 1M Ω or greater. If it is less, the set must be inspected and repaired.

CAUTION

Concerning important safety parts

Many of the electric and structural parts used in the set have special safety properties. In most cases these properties are difficult to distinguish by sight, and using replacement parts with higher ratings (rated power and withstand voltage) does not necessarily guarantee that safety performance will be preserved. Parts with safety properties are indicated as shown below on the wiring diagrams and parts lists in this service manual. Be sure to replace them with parts with the designated part number.

- (1) Schematic diagrams Indicated by the \triangle mark.
- (2) Parts lists Indicated by the \triangle mark.

Using parts other than the designated parts could result in electric shock, fires or other dangerous situations.

DIMENSION

DIMENSIONS Unit : mm (in)

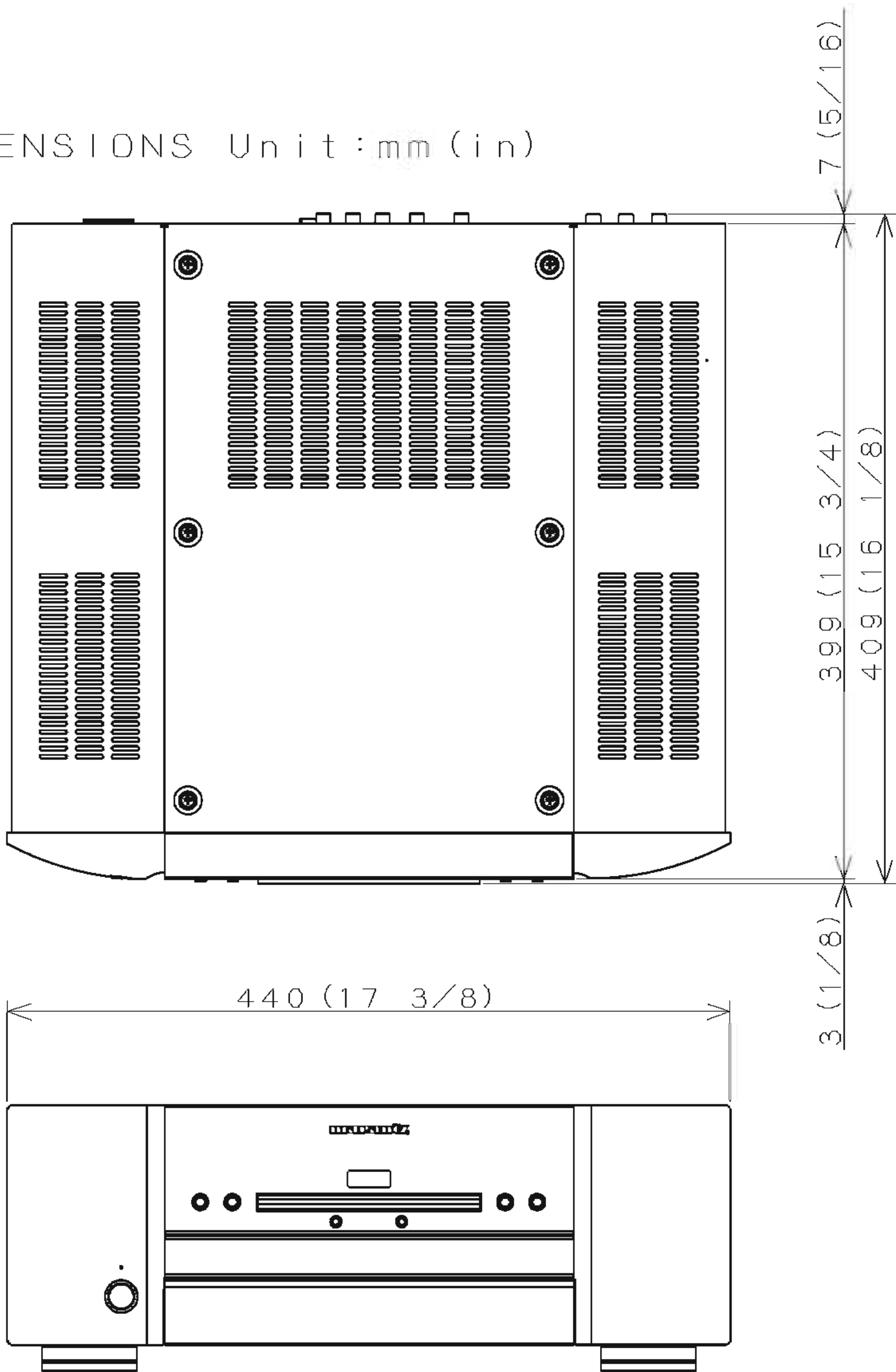

ワイヤー整形図

調整や部品の交換等により、ワイヤー類の結束をはずしたり移動させた場合には、それらの作業が完了した時点でワイヤーの整形をおこなってください。正しく整形されてないとノイズ発生の原因となることがあります。

上面からみたワイヤー整形

Front Panel side

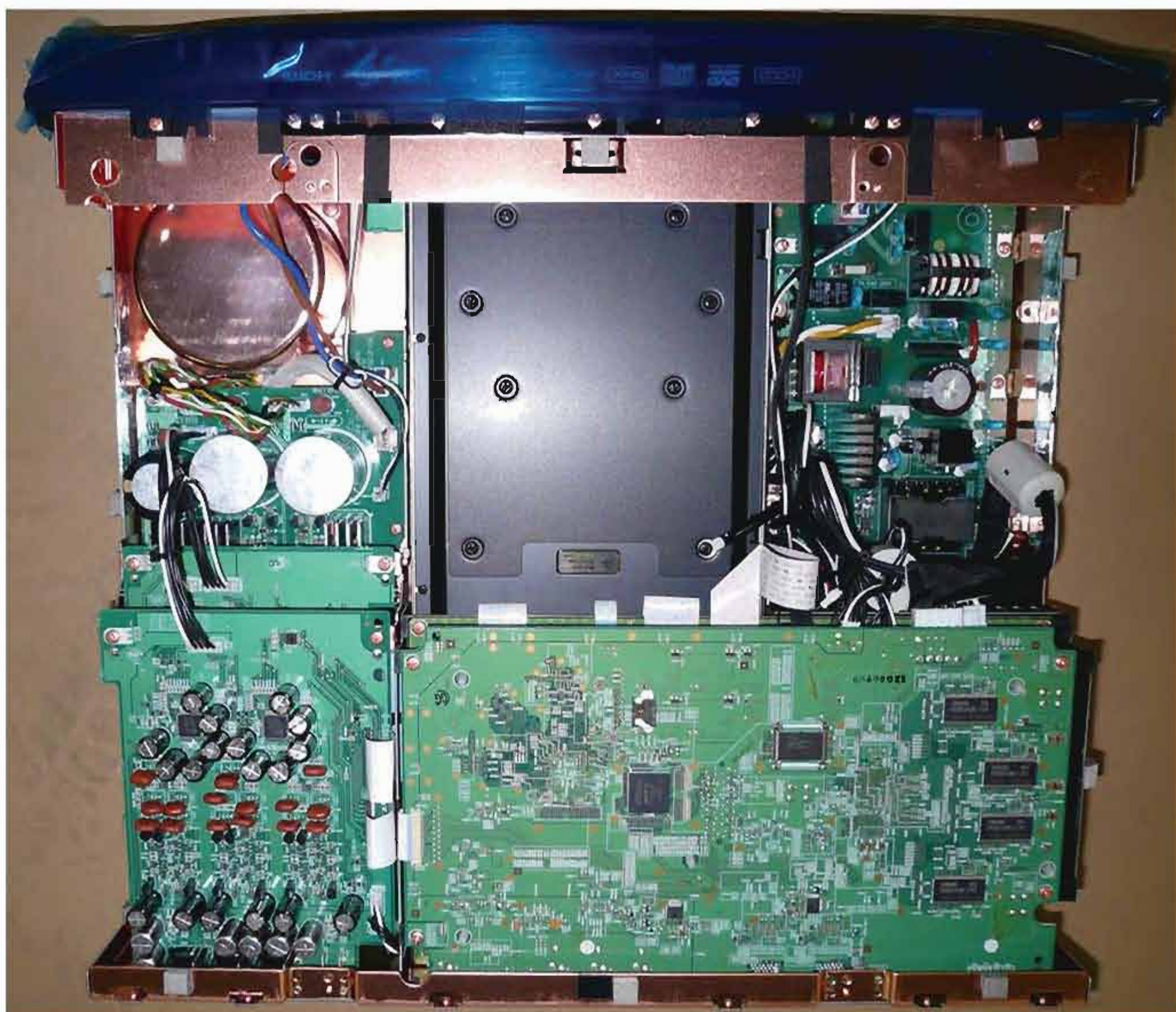

Back Panel side

DISASSEMBLY

- Disassemble in order of the arrow of the figure of following flow.
- In the case of the re-assembling, assemble it in order of the reverse of the following flow.
- In the case of the re-assembling, observe "attention of assembling" it.
- When reattaching the BOTTOM COVER after removing it, be careful that it does not run against the REAR PANEL.

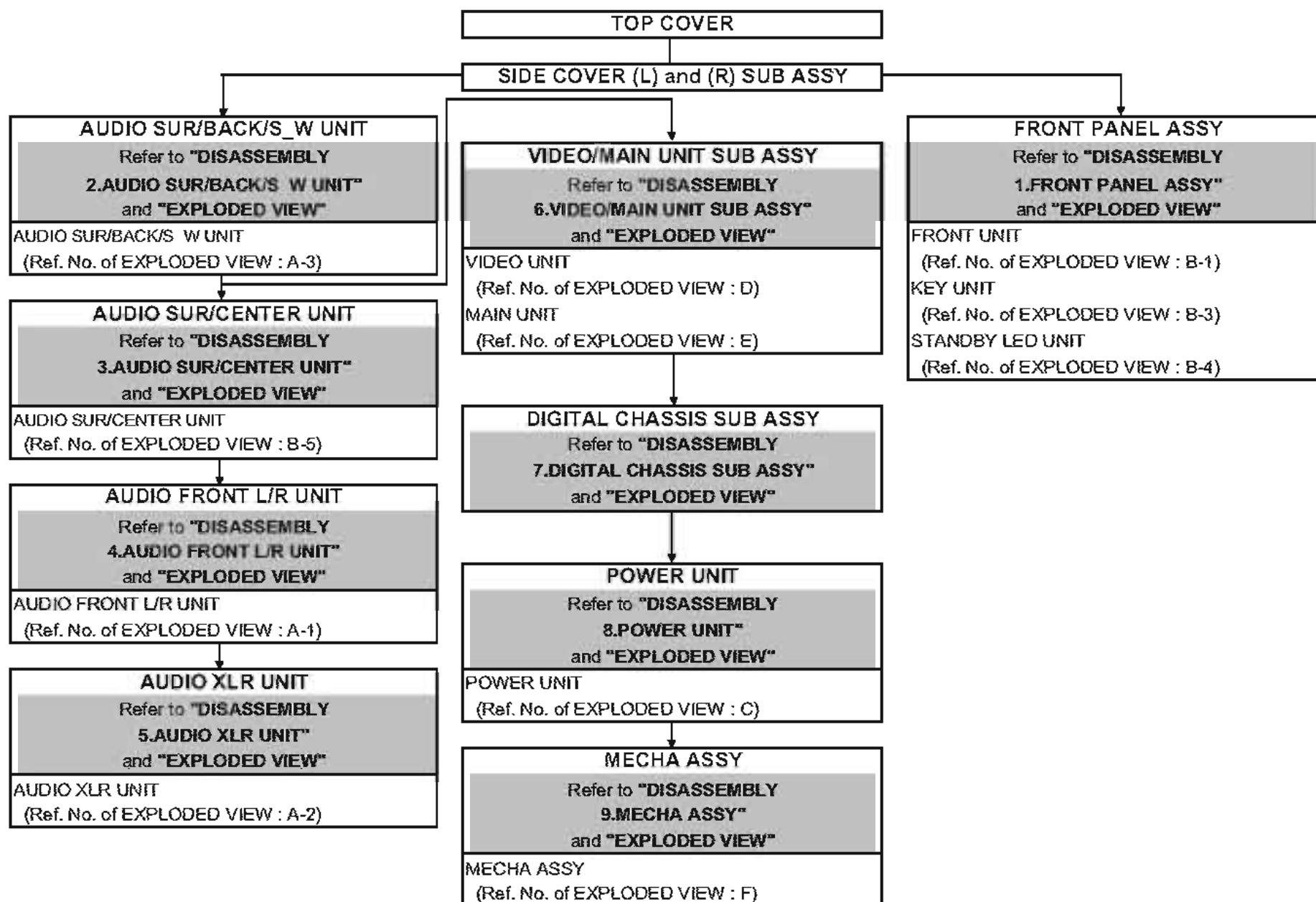

About the photos used for descriptions in the “DISASSEMBLY” section.

- The direction from which the photographs used herein were photographed is indicated at “Direction of photograph: ***” at the left of the respective photographs.
- Refer to the table below for a description of the direction in which the photos were taken.
- Photographs for which no direction is indicated were taken from above the product.

The viewpoint of each photograph
(Photography direction)

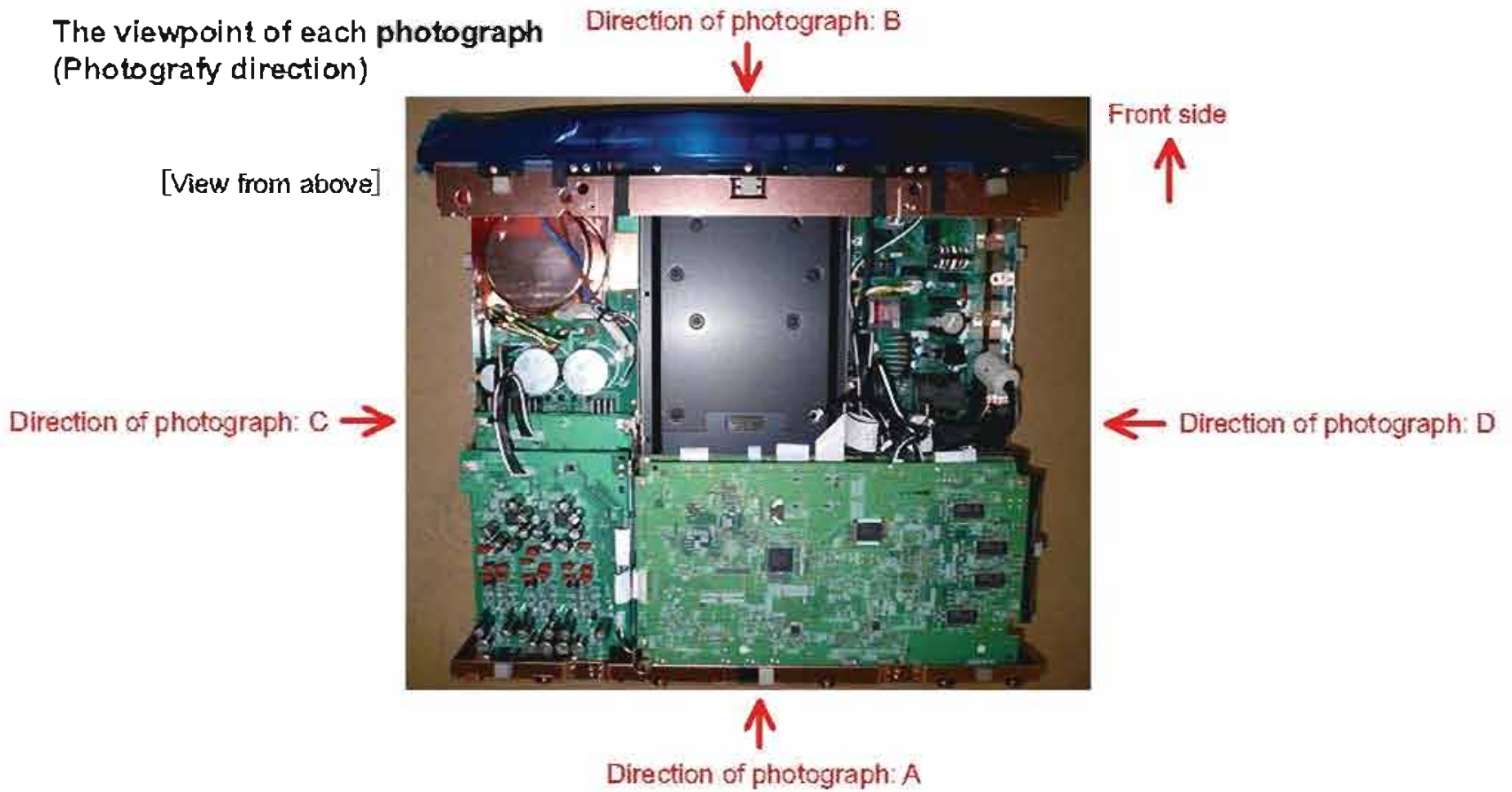

1. FRONT PANEL ASSY

Proceeding : **TOP COVER** → **SIDE COVER (L) and (R) SUB ASSY**
→ **FRONT PANEL ASSY**

(1) Remove the screws.

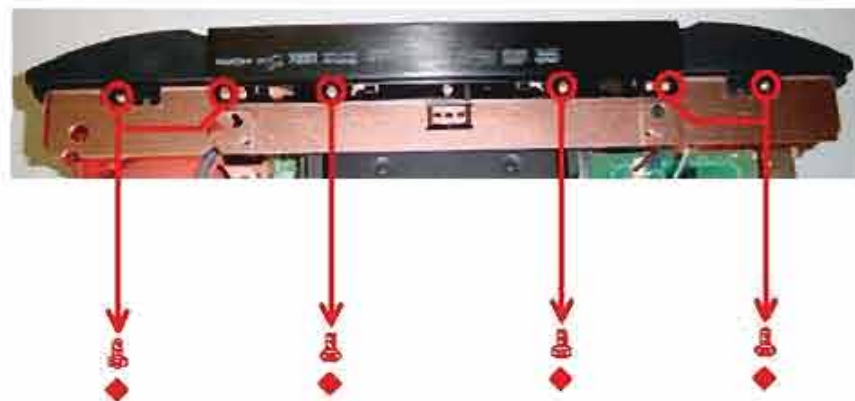

(2) Remove the screws. Disconnect the connector wire and FFC Cable.

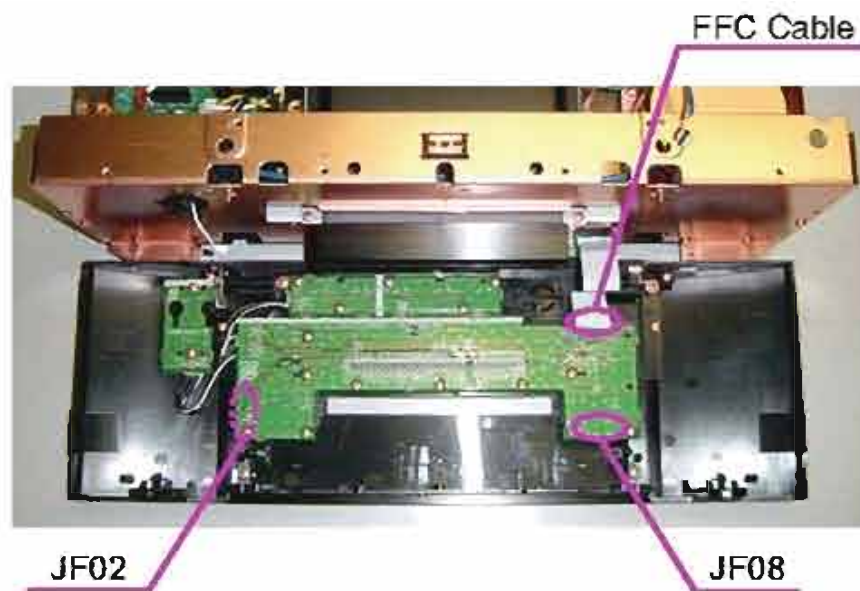

Please refer to "EXPLODED VIEW" for the disassembly method of each P.W.B included in FRONT PANEL ASSY.

2. AUDIO SUR/BACK/S_W UNIT

Proceeding : **TOP COVER** → **SIDE COVER (L) and (R) SUB ASSY**

→ **AUDIO SUR/BACK/S_W UNIT**

(1) Remove the screws.

Direction of photograph: A



(2) Disconnect the connector wires and FFC cables then remove the screws.

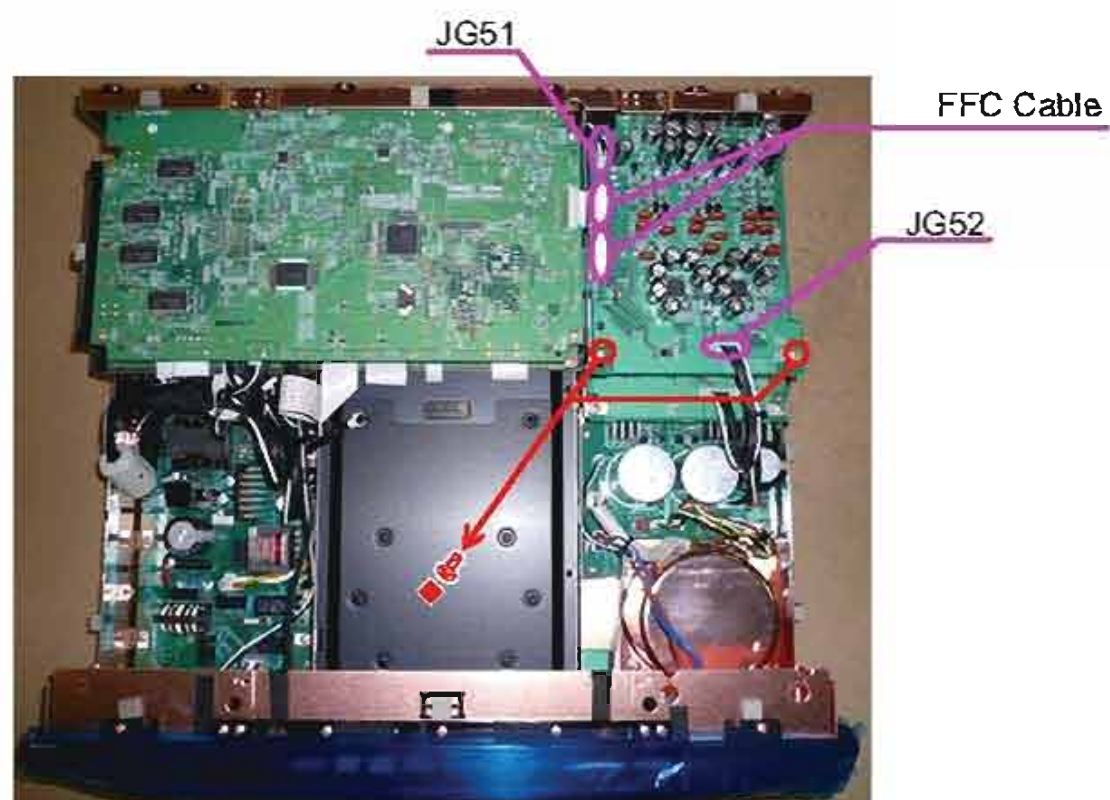

3. AUDIO SUR/CENTER UNIT

手順 : **TOP COVER** → **SIDE COVER (L) and (R) SUB ASSY**
→ **AUDIO SUR/BACK/S_W UNIT** → **AUDIO SUR/CENTER UNIT**

(1) Remove the screws.



(2) Remove the screws.

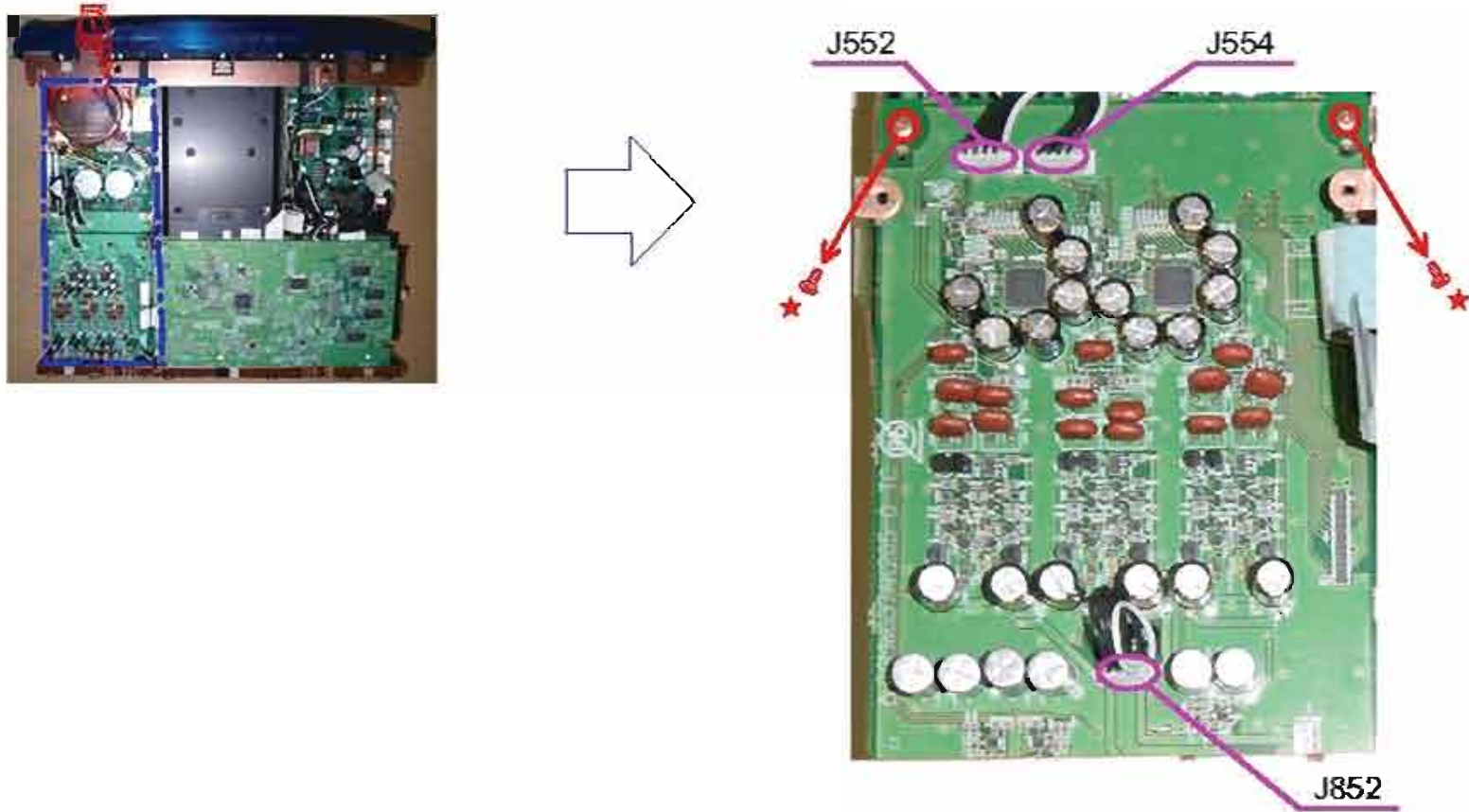

4. AUDIO FRONT L/R UNIT

Proceeding : **TOP COVER** → **SIDE COVER (L) and (R) SUB ASSY**
→ **AUDIO SUR/BACK/S_W UNIT** → **AUDIO SUR/CENTER UNIT**
→ **AUDIO FRONT L/R UNIT**

(1) Remove the screws.

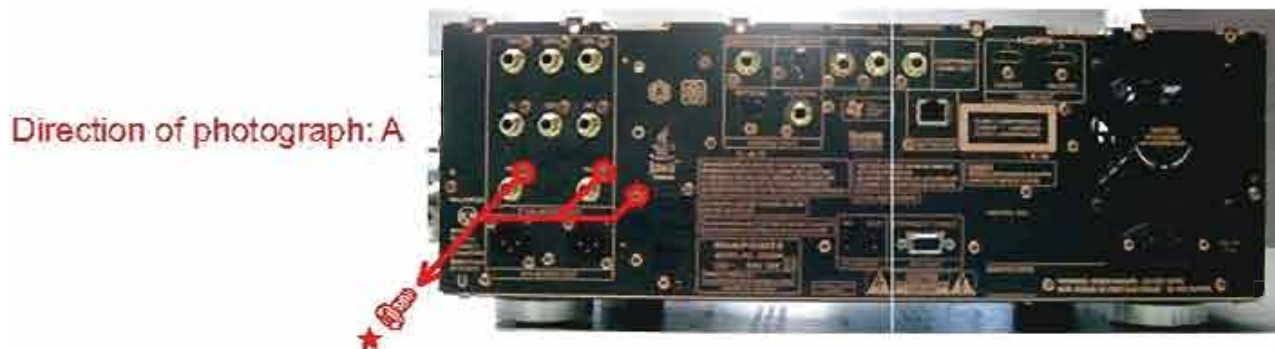

(2) Disconnect the connector wire and FFC cables, then remove the screws.

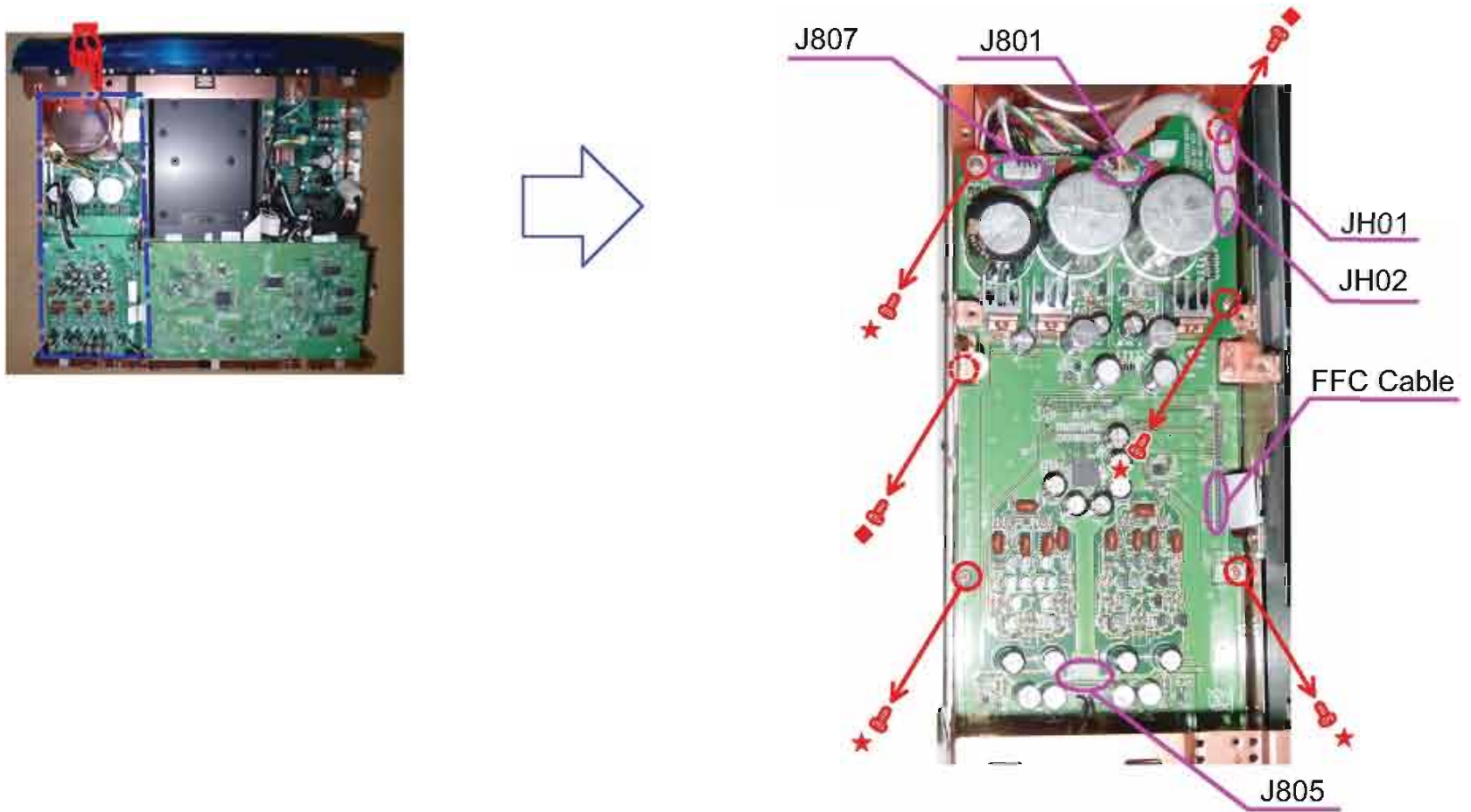

5. AUDIO XLR UNIT

Proceeding : **TOP COVER** → **SIDE COVER (L) and (R) SUB ASSY**
→ **AUDIO SUR/BACK/S_W UNIT** → **AUDIO SUR/CENTER UNIT**
→ **AUDIO FRONT L/R UNIT** → **AUDIO XLR UNIT**

(1) Remove the screws.

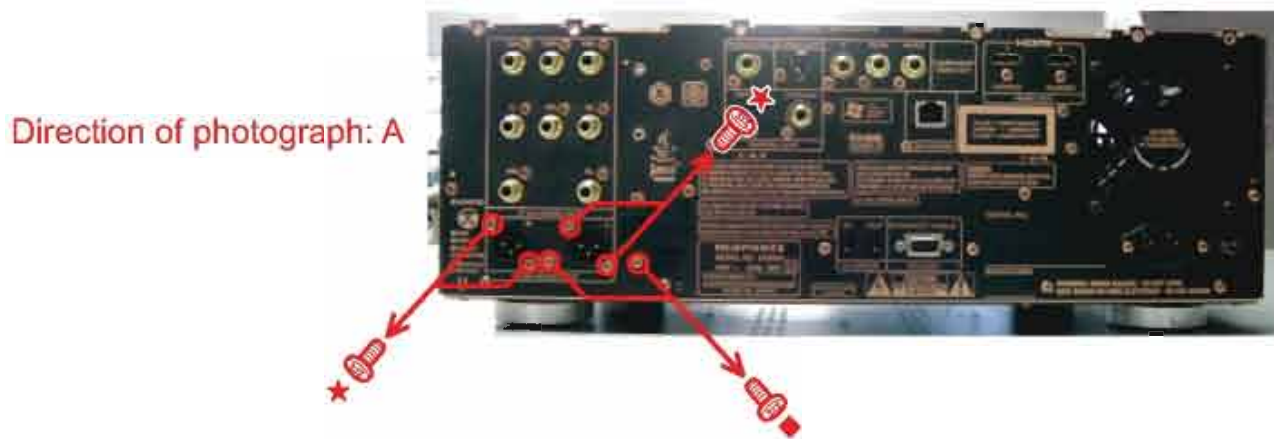

(2) Remove the screws.

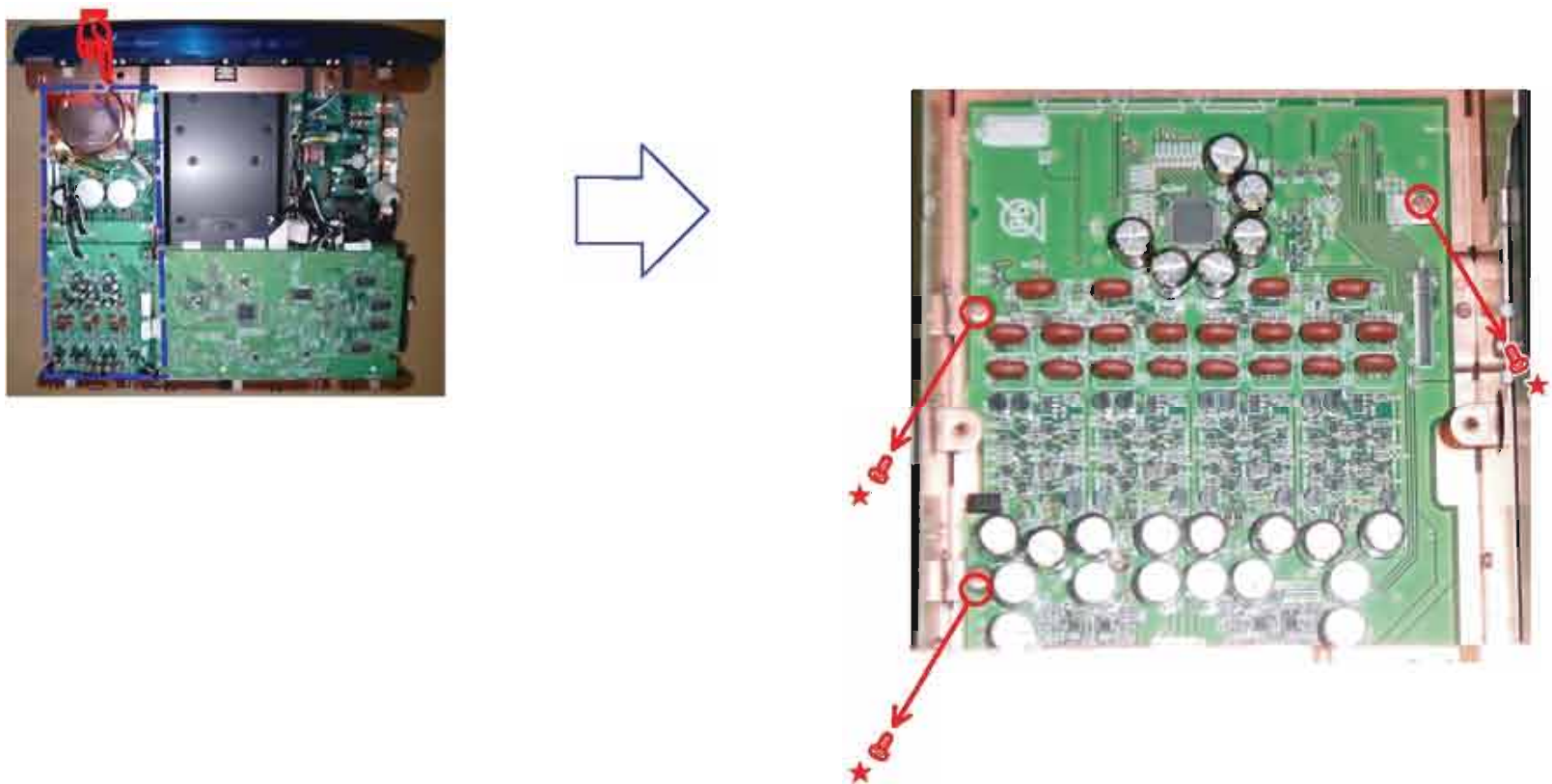

6. VIDEO/MAIN UNIT SUB ASSY

Proceeding : **TOP COVER** → **SIDE COVER (L) and (R) SUB ASSY**
→ **AUDIO SUR/BACK/S_W UNIT** → **VIDEO/MAIN UNIT SUB ASSY**

(1) Remove the screws.



(2) Disconnect the connector wire and FFC cables.

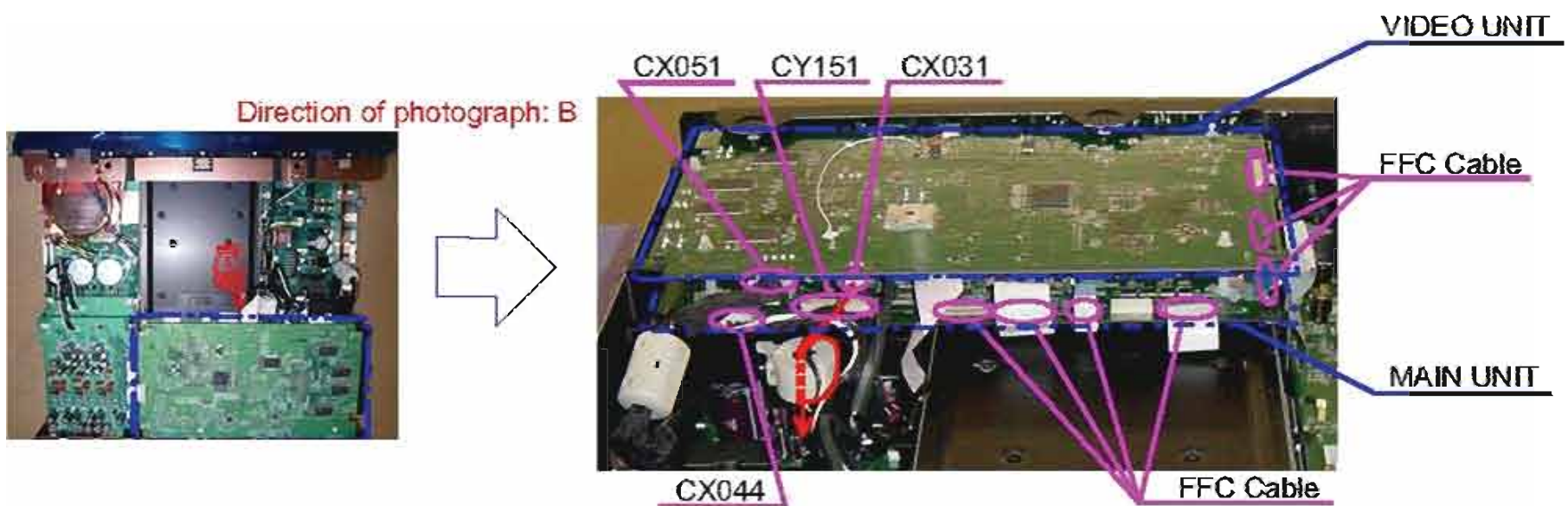

(3) Cut the wire clamp band. Remove the screws, then remove "VIDEO/MAIN UNIT SUB ASSY". Refer to the diagram next page for instructions on removing.



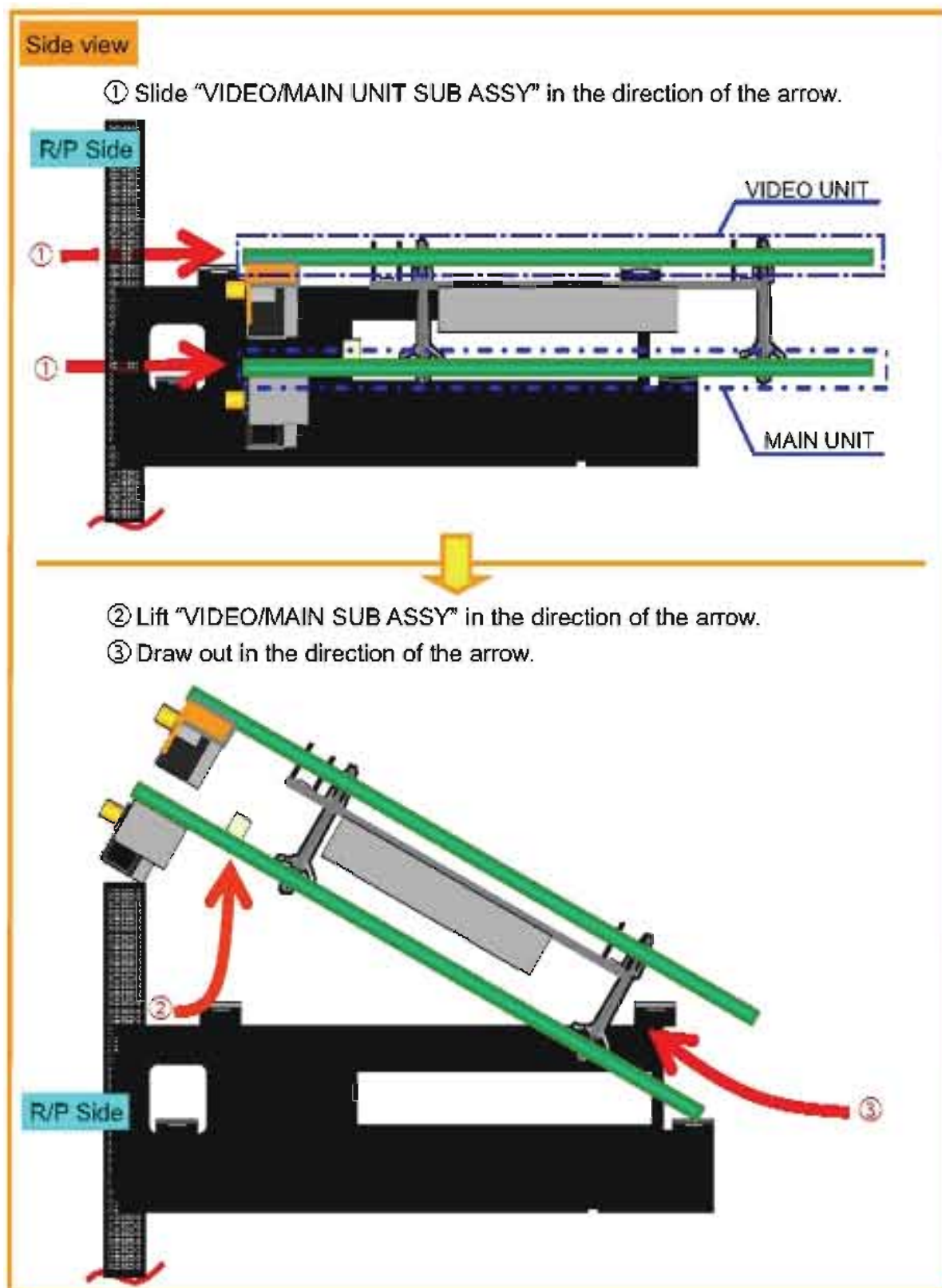

Please refer to "EXPLODED VIEW" for the disassembly method of each P.W.B included in VIDEO/MAIN UNIT SUB ASSY.

7. DIGITAL CHASSIS SUB ASSY

Proceeding : **TOP COVER** → **SIDE COVER (L) and (R) SUB ASSY**
→ **AUDIO SUR/BACK/S_W UNIT** → **VIDEO/MAIN UNIT SUB ASSY**
→ **DIGITAL CHASSIS SUB ASSY**

(1) Remove the screws.

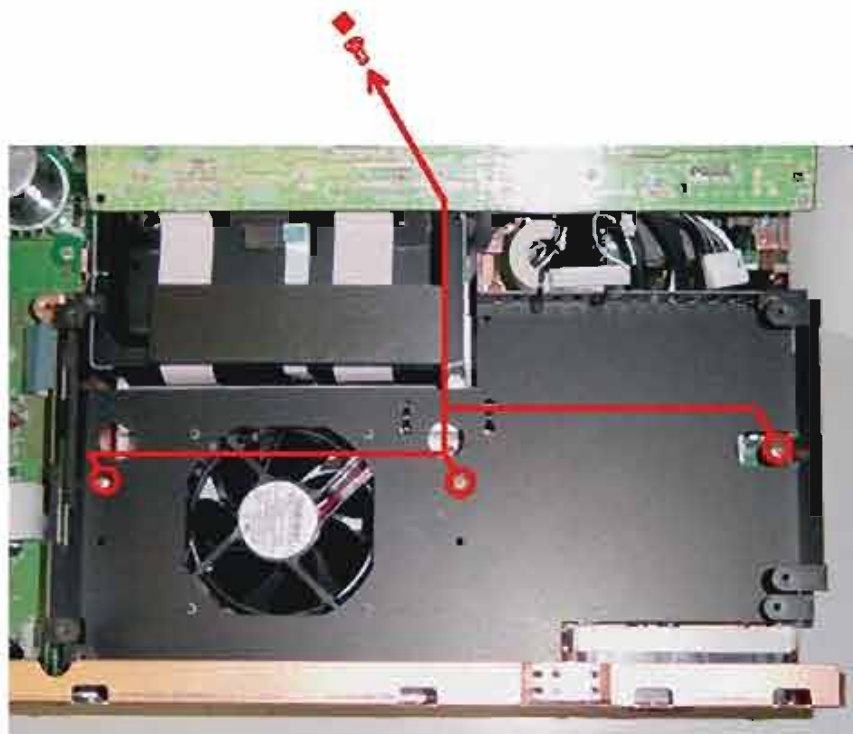

(2) Disconnect the connector wire.

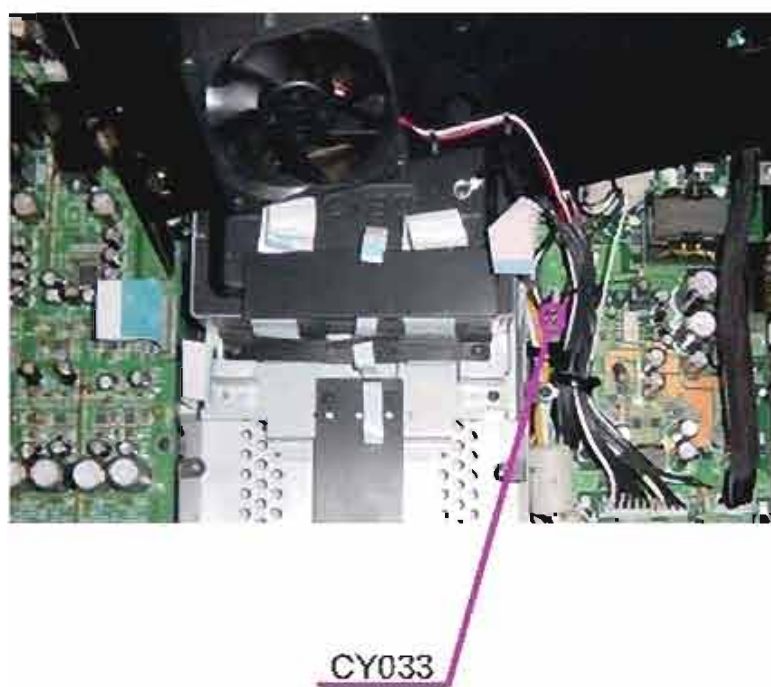

8. POWER UNIT

Proceeding : **TOP COVER** → **SIDE COVER (L) and (R) SUB ASSY**
→ **AUDIO SUR/BACK/S_W UNIT** → **VIDEO/MAIN UNIT SUB ASSY**
→ **DIGITAL CHASSIS SUB ASSY** → **POWER UNIT**

(1) Cut the wire clamp band, then disconnect the connector wires.

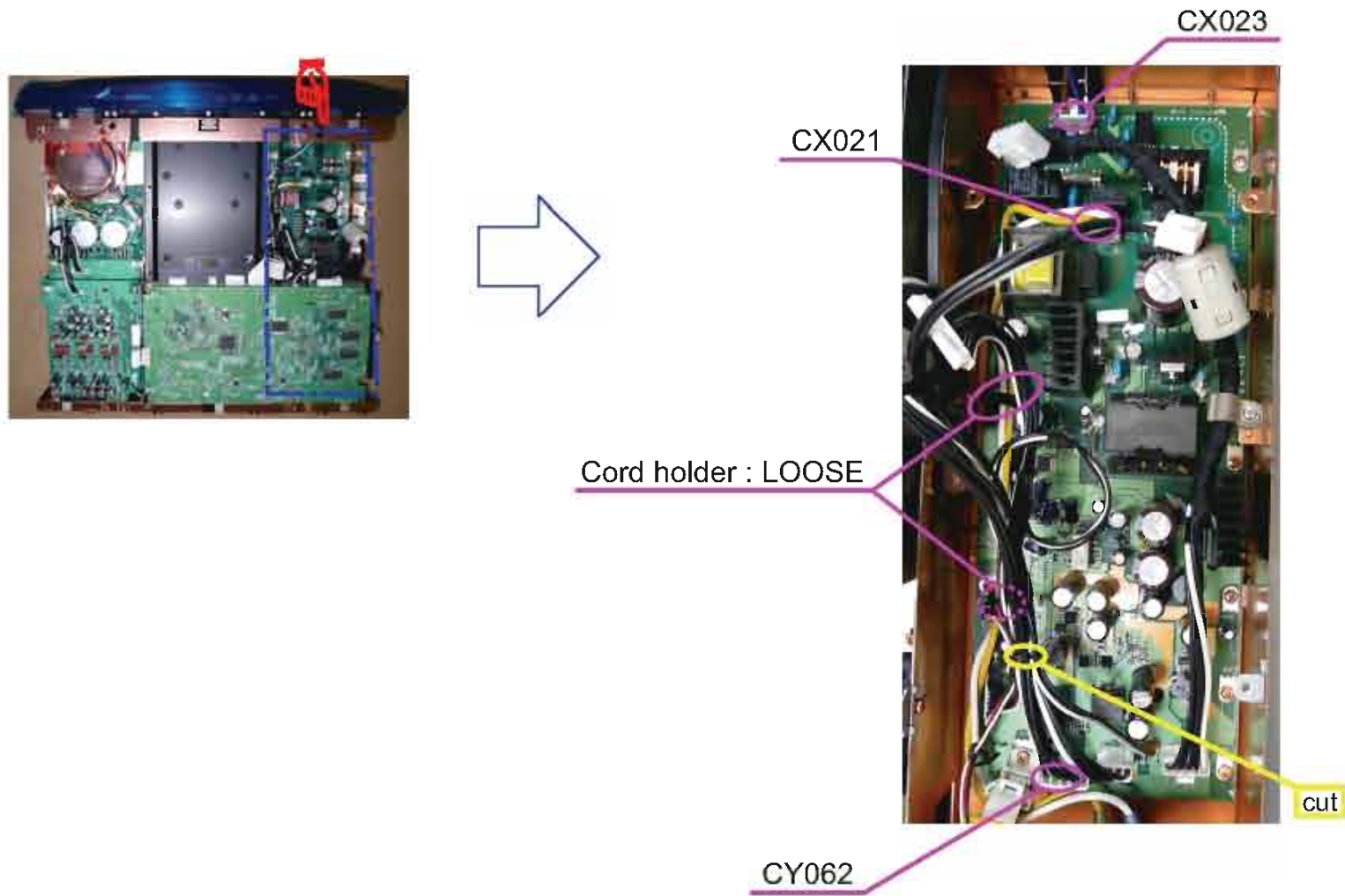

(2) Remove the screws.

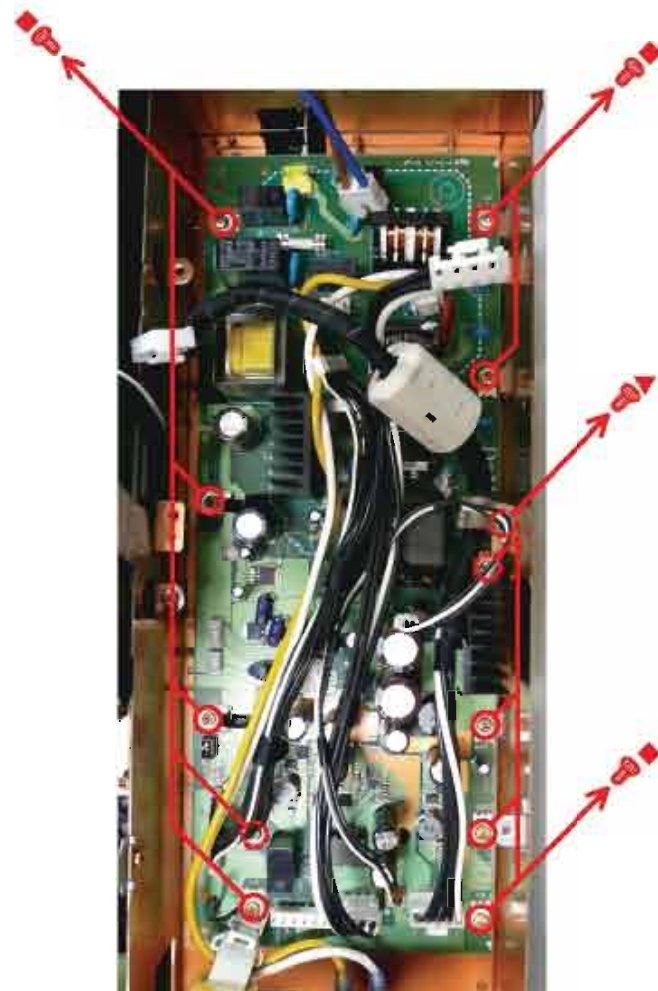

9. MECHA ASSY

Proceeding : **TOP COVER** → **SIDE COVER (L) and (R) SUB ASSY**
→ **AUDIO SUR/BACK/S_W UNIT** → **VIDEO/MAIN UNIT SUB ASSY**
→ **DIGITAL CHASSIS SUB ASSY** → **POWER UNIT**
→ **MECHA ASSY**

(1) Cut the wire clamp band, then disconnect the connector wires. Remove the screws, then remove "MECHA ASSY" in the direction of the arrow.

※ When mounting the mechanism, adjust the position of the loader panel. (See page 16)

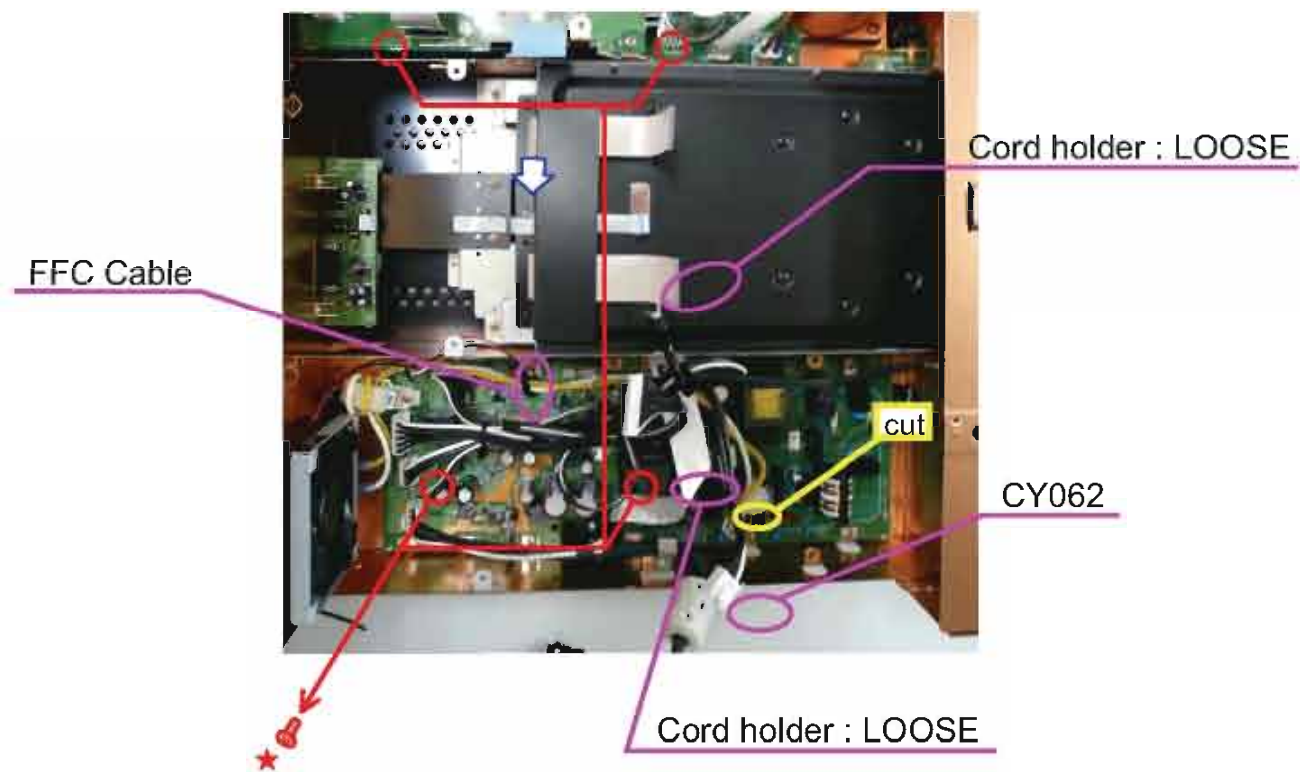

Removing discs

Proceeding : **TOP COVER** → **SIDE COVER (L) and (R) SUB ASSY** → **FRONT PANEL ASSY**
→ **VIDEO/MAIN UNIT SUB ASSY** → **DIGITAL CHASSIS SUB ASSY**
→ **BLIND SHEET** → **Clamp cover**

- (1) Remove the screws(★ mark), then lift the clamp cover to unhook the hooks.
 - (2) Remove the Clamp cover in the direction of the arrow, then remove the disc inside.
- ※ Be careful not to scratch the disc when removing the Clamp cover.

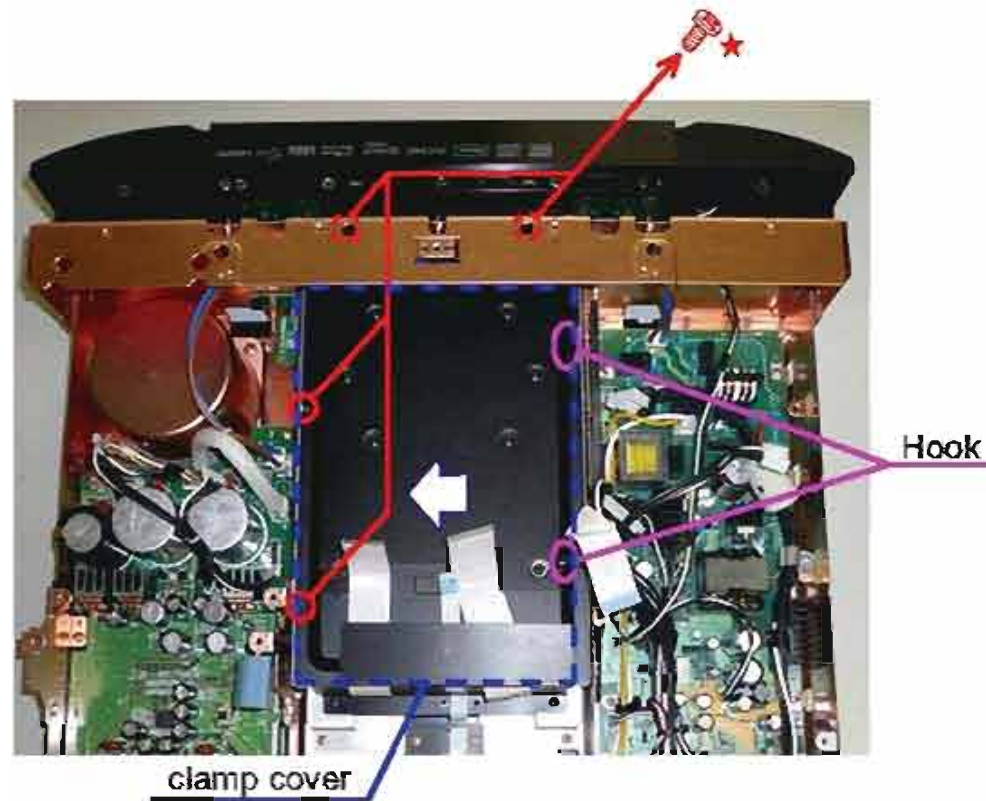

AJUSTING THE POSITION OF THE LOADER PANEL

Perform this adjustment when repairing for uneven gaps around the loader panel (top, bottom, left and right) and when re-mounting mechanisms removed when making repairs.

<Preparations>

- First turn on the power, open and close the tray once, then turn the power off.
- Check the various actual gaps.
- Loose the screws marked ▲ and ✖ fixing the mechanism in place.

1. Adjusting the gaps

1.1. Adjusting the left and right gaps

- (1) With the mechanism pressing against the front, adjust so that there is no gap on the left and right.

1.2. Adjusting the top and bottom gaps

- (1) Using a hexagonal wrench, turn the screws marked ★ on the left and right to adjust the top and bottom gaps of the left and right trays
(When it turns to clockwise, the opening above spreads.)
- (2) Fasten the mechanism using the two screws marked ▲.
- (3) Fasten the mechanism using the two screws marked ✖.

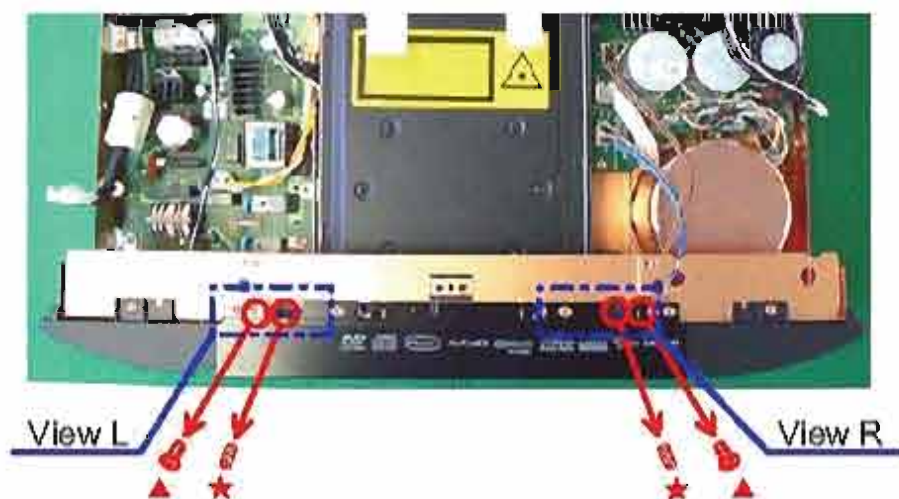
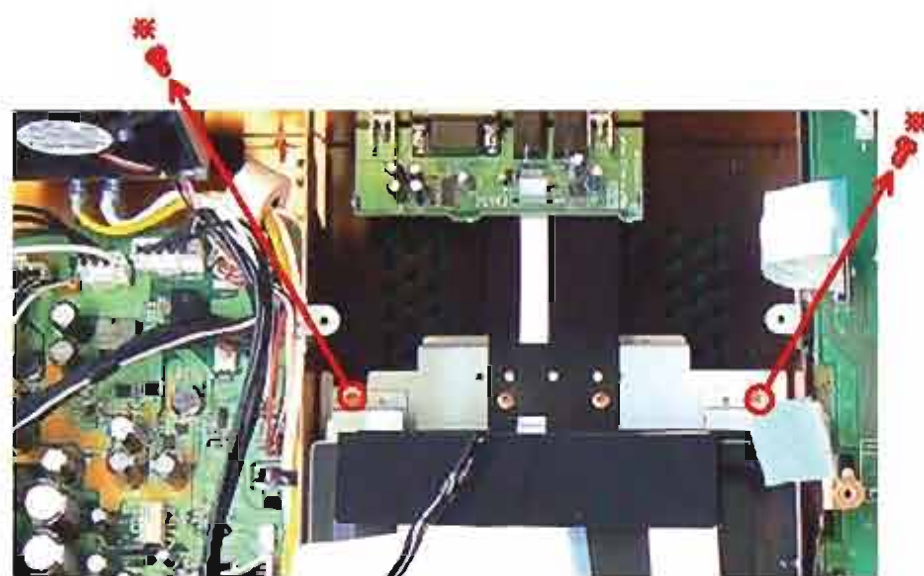

Detail of View L

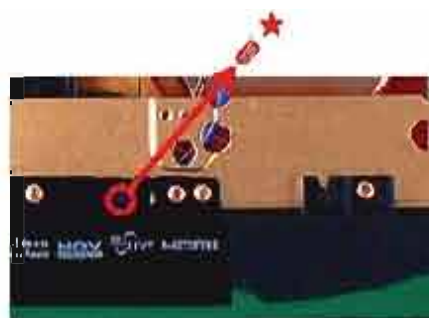

Detail of View R

2. Final check

After completing the operations, turn on the power and open and close the tray once to check the gap.

DIAGNOSTICS OF OPTICAL PICKUP AND REPLACING FE MAIN P.W.B AND BD MECHANISM UNIT ASSY

Make failure diagnostics of the Optical Pickup as follows.

If the laser drive current (Iop) becomes more than ± 12 [mA] of the initial value, the Optical Pickup should be replaced.

The laser drive current initial value is checked by "Iop checked Method" of next page.

In case of replacing the Pickup, change the whole part of the FE Main P.W.B and BD Mechanism Unit Assy.

No mechanical adjustment is necessary after the replacement.

Laser drive current initial value:

	FL Display (The display part of 13 digits)												
	1	2	3	4	5	6	7	8	9	10	11	12	13
CD:	T	2	1	-	m	m	m	m	-	n	n	n	n
DVD:	T	2	2	-	m	m	m	m	-	n	n	n	n
BD(SL):	T	2	3	-	m	m	m	m	-	n	n	n	n
BD(DL):	T	2	4	-	m	m	m	m	-	n	n	n	n

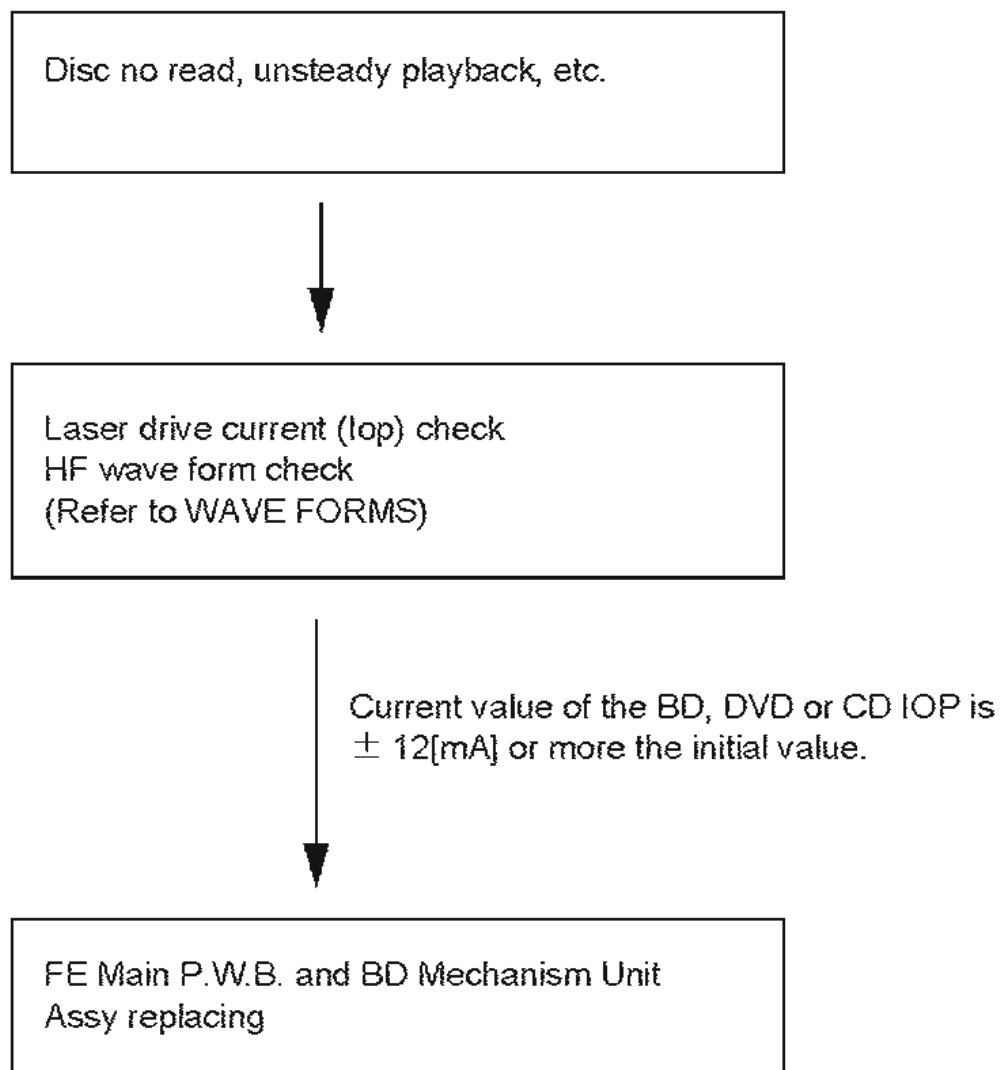

1. IOP checked Method

Select the laser ON/OFF(CD/DVD/BD)mode of the test mode, and check the IOP value of CD laser, DVD laser or BD laser.

(See page 19 for test mode.)

FL Display (The display part of 13 digits)												
1	2	3	4	5	6	7	8	9	10	11	12	13
T	2		L	3	3	3	0	0	n	0	f	f

DVD laser current check

Press the 8 or 9 button to display the laser current value, and then select [X].

Check the current value of IOP (nnnn).

FL Display (The display part of 13 digits)												
1	2	3	4	5	6	7	8	9	10	11	12	13
T	2	X	-	m	m	m	m	-	n	n	n	n

(X=1 : CD laser mode, 2 : DVD laser mode, 3 : BD(SL) laser mode, 4 : BD(DL) laser mode)
(nn.nn[mA] : Current value)

2. To clear the accumulated laser on time

Press the ► button while the accumulated laser on time is displayed ("TC1", "TC2", "TC3") until " * " appears at the fourth position. Press the ◀◀ or ▶▶ button to select "TC4". If the ► button is pressed while "TC1" is displayed, the accumulated laser on time of CD, DVD and BD is cleared.

FL Display (The display part of 13 digits)												
1	2	3	4	5	6	7	8	9	10	11	12	13
T	C	4	*	-	-	-	-	-	-	-	-	-

When "TC1", "TC2" or "TC3" is selected with the ◀◀ or ▶▶ button, "mmmmmm" is displayed as "0" so you can check.

FL Display (The display part of 13 digits)												
1	2	3	4	5	6	7	8	9	10	11	12	13
T	C	Y	-	-	-	m	m	m	m	m	m	h

(Y=1 : CD, 2 : DVD, 3 : BD, mmmmmm : Time(Fractions of hours are counted up one hour on the display.)

SERVICE MODE

1. Heat run mode

1.1. preparation

- (1) Equipment used : Heat run disc (This operation may not work with any discs other than the heat run discs listed below.)
CD : CD TEST DISC (TCD-HR01)
DVD : DVD TEST DISC (TDV-HR01)
BD : BD TEST DISC (TBD-HR01)
- (2) Unit setting : No spec other than the following procedure

1.2. procedure

- (1) Pressing the ▲ and ► buttons simultaneously, plug the AC cord into a power outlet.
When the heat run mode is set, the “►” and “■” indicators light.
- (2) Press the ▲ button and open a tray.
- (3) Set a disc to the tray and press the ► button. The “►” and “■” indicators blinks and heat run operation starts.
DVD : After playback title-1 and title-10 of the disc, the tray open/close is made automatically, then playback the title-1 and title-10 again.
CD/BD : The disc is played through once from title 1 through the last title, the tray opens and closes automatically, then the disc is played through again from title 1 through the last title.
- (4) This heat run operation continues automatically or it stops caused by an error. In case of some error, the following error messages are displayed on the FL tube.

No.	Error contents	FL display
1	Tray Error	ERROR 01
2	Bad Disc	ERROR 02
3	Search Error	ERROR 03
4	Read Error	ERROR 04
5	Communications error	ERROR 05
6	Other (Front end error)	ERROR 06

2. Initial setting mode

2.1. Preparation

- (1) Equipment used: None
- (2) Unit setting: No spec other than the following procedure.

2.2. Procedure

- ※ Initialize the BD player when μ com, peripheral parts of μ com, or MAIN P.W.B. unit has been replaced in servicing.
※ All user setting will be lost and its factory setting will be restored when this initialization is made. Be sure to memorize your setting for restoring again after the initialization.

- (1) Turn on the UD9004's power. "NO DISC" is displayed on the fluorescent tube.
- (2) Press the UD9004's PLAY, EJECT and SOUND MODE buttons simultaneously. "INITIALIZING" is displayed on the fluorescent tube. 
- (3) The display on the fluorescent tube switches to "INITIALIZED", the "NO DISC" display reappears and initialization is completed.

3. μ com firm check mode

3.1. Preparation

- (1) Equipment used: None
- (2) Unit setting: No spec other than the following procedure.

3.2. Procedure

※ System μ com and other μ com firm check mode.

This mode is for displaying the status of each μ com employed.

- (1) Pressing the \blacktriangle and \blacktriangleright buttons simultaneously, plug the AC cord into a power outlet.
- (2) "NO DISC" is displayed on the fluorescent tube.
- (3) Press remote controller "3265".
- (4) Each time the POP UP MENU button or Cursor buttons(\blacktriangle or \blacktriangledown) on the remote control unit is pressed, μ com firm is displayed one after another.
Ex.: [Sys Ver000103, Sys Day090219, Sys GEN100000.....]

4. Tray lock mode

4.1. Preparation

- (1) Equipment used: None
- (2) Unit setting: No spec other than the following procedure.

4.2. Procedure

【Setting】

- (1) Pressing the \blacktriangleright and \blacksquare buttons for simultaneously, plug the AC cord into a power outlet.
 - (2) "TRAY LOCK" is displayed on the fluorescent tube.
- ※ Press the \blacktriangleright and \blacksquare buttons until "TRAY LOCK" appears. \triangle
3

【Cancel】

- (1) Unplug the UD9004's AC cord from the power outlet.
 - (2) Pressing the \blacktriangleright and \blacksquare buttons simultaneously, plug the AC cord into a power outlet.
 - (3) "PLEASE WAIT" is displayed on the fluorescent tube and tray opening/closing is enabled.
- ※ Press the \blacktriangleright and \blacksquare buttons until "PLEASE WAIT" appears. \triangle
3
- ※ The tray lock mode is also canceled when the product is initialized.

5. Test mode

5.1. Entering the test mode

The test mode is entered by pressing the ▲ and ■ buttons simultaneously, plug the AC cord into a power outlet. When the test mode is set, the “▶” and “||” indicators light.

FL tube display when test mode entered

FL Display (The display part of 13 digits)												
1	2	3	4	5	6	7	8	9	10	11	12	13
		T	E	S	T		M	O	D	E		

When the test mode is set, a color bar appears on the monitor.

5.2. Selecting the mode

• The following modes are available.

- (1) Laser on/off (CD/DVD/BD) mode : T2
- (2) Servo adjustment value display mode : T3
- (3) Error rate (skew) measurement mode : T7
- (4) Accumulated laser on time display mode : TC
- (5) Track buffer output mode : TE
- (6) Picking up No. display mode : TG
- (7) Error log display mode : TH
- (8) Test mode cancel : TI

① When the ▶▶| button is pressed after entering the test mode, the display switches in the order: “T2, T3, T7, TC, TE, TG, TH, TI, T2 …”

FL Display (The display part of 13 digits)												
1	2	3	4	5	6	7	8	9	10	11	12	13
T	2		L	a	s	e	r	O	n	O	f	f

FL Display (The display part of 13 digits)												
1	2	3	4	5	6	7	8	9	10	11	12	13
T	3		S	e	r	v	O		A	d	J	.

FL Display (The display part of 13 digits)												
1	2	3	4	5	6	7	8	9	10	11	12	13
T	7		E	r	r	O	r		R	a	t	e

FL Display (The display part of 13 digits)												
1	2	3	4	5	6	7	8	9	10	11	12	13
T	C		L	a	s	e	r	O	n	T	i	m

FL Display (The display part of 13 digits)												
1	2	3	4	5	6	7	8	9	10	11	12	13
T	E		T	r	a	c	k		B	u	f	

FL Display (The display part of 13 digits)												
1	2	3	4	5	6	7	8	9	10	11	12	13
T	G		O	P	U		N	U	m	b	e	r

FL Display (The display part of 13 digits)												
1	2	3	4	5	6	7	8	9	10	11	12	13
T	H		E	r	r	O	r		L	O	g	

FL Display (The display part of 13 digits)												
1	2	3	4	5	6	7	8	9	10	11	12	13
T	I		T	e	s	t		E	x	i	t	

② When the |◀◀ button is pressed, the display switches in the opposite order from ① above, starting from the current position (for example, if currently at “TA”, it switches as follows: “T2, T3, T7, TC, TE, TG, TH, TI, T2 …”).

5.3. About each mode

- With the mode selected, press the ► button to set that mode.

(1) Laser on/off (CD/DVD/BD) mode

Press the ◀◀ or ▶▶ button to select [X] and press the ► button to set it.
Laser on/off control is executed and the laser current is displayed.

FL Display (The display part of 13 digits)												
1	2	3	4	5	6	7	8	9	10	11	12	13
T	2	X		m	m	m	m		n	n	n	n

(X=1 : CD laser mode, 2 : DVD laser mode, 3 : BD(SL) laser mode, 4 : BD(DL) laser mode)
(mm.mm[mA] : Stored data, nn.nn[mA] : Current value)

- ※ When the current value is more that ± 12.00 [mA] of saved data, it becomes the pickup transducer's target.
In this case, replace the mechanism unit.

If stored value is not

FL Display (The display part of 13 digits)												
1	2	3	4	5	6	7	8	9	10	11	12	13
T	2	X							n	n	n	n

(X=1 : CD laser mode, 2 : DVD laser mode, 3 : BD(SL) laser mode, 4 : BD(DL) laser mode)
(nn.nn[mA] : Current value)

When the ■ button is pressed, the layer above the current layer is displayed. See "5.4 Stopping the mode" (page 23).

(2) Servo adjustment value display mode

Press the ◀◀ or ▶▶ button to select [XXX]. Refer to [Table 1 - Servo adjustment value display mode details] (page 23).

FL Display (The display part of 13 digits)												
1	2	3	4	5	6	7	8	9	10	11	12	13
T	X	X	X									

(XXX : Servo adjustment value)

Press the ► button to set. The contents indicated on "Table 1: Details of the servo adjustment value display mode" (page 23) are displayed.

FL Display (The display part of 13 digits)												
1	2	3	4	5	6	7	8	9	10	11	12	13
T	X	X	X	m	m	m	m	m	m		n	n

(XXX : Selection mode, mmmmmm : Address(HEX), nn:Data(HEX))

The first time, the address specification position is the uppermost position (5th place). The address specification position moves downwards each time the ► button is pressed.

The address specification position flashes (at an interval of about 0.5 seconds). If the ► button is pressed after moving to the lowermost position (10th place), the position moves to the uppermost position

Use the ◀◀ or ▶▶ button to change the display at the address specification position.

When the ■ button is pressed, the layer above the current layer is displayed. See "5.4 Stopping the mode" (page 23).

(3) Error rate measurement mode

Press the **◀◀** or **▶▶** button to select [YY].
 Refer to [Table 2 - Error rate details]. (page 24)

FL Display (The display part of 13 digits)												
1	2	3	4	5	6	7	8	9	10	11	12	13
T	Y	Y	F	F	F	F	F	F	F	F	F	F

(X : measurement mode, F : Address and error rate (When not set, "F" is displayed.)
 Press the PLAY button to begin error rate measurement. The address and error rate are displayed.
 For a description of the displayed measurement results, see "Table 2: Error rate details" (page 24).

FL Display (The display part of 13 digits)												
1	2	3	4	5	6	7	8	9	10	11	12	13
T	Y	Y	m	m	m	m	m	m	l	l	l	l

(YY : selection mode [71 to 94], m : address [PBA][HEX], l : error rate [COUNT/SEC] [HEX])

(Note) CD (4x-speed) : Renewal of data is carried out for every 300 frame.
 Error rate of 75 frames is displayed.

DVD(2x-speed) : Renewal of data is carried out for every 80ECC block.
 Error rate of 8ECC block is displayed.

BD (2x-speed) : Renewal of data is carried out for every 136LDC clusters block.
 Error rate of 8LDC clusters block is displayed.

The mode chosen when selection mode was changed into the trace execution and the **▶** button was pushed is performed from the beginning.

When the **▶** button is pushed without changing selection mode, the mode under selection is performed from the beginning.

(If the **▶** button is pushed, the address corresponding to the chosen mode will be searched again.)

The pause mode is set after tracing is completed.

When the **■** button is pressed, the layer above the current layer is displayed. See "5.4 Stopping the mode" (page 23).

(4) Accumulated laser on time display mode

Press the **◀◀** or **▶▶** button to select [Y] and press the **▶** button to set it.
 The accumulated laser on time is displayed..

FL Display (The display part of 13 digits)												
1	2	3	4	5	6	7	8	9	10	11	12	13
T	B	Y				m	m	m	m	m	m	h

(Y=1 : CD, 2 : DVD , 3 : BD, mmmmmm : Time(Fractions of hours are counted up one hour on the display.)

When the **■** button is pressed, the layer above the current layer is displayed. See "5.4 Stopping the mode" (page 23).

---To clear the accumulated laser on time---

Press the **▶** button while the accumulated laser on time is displayed ("TC1", "TC2", "TC3") until " * " appears at the fourth position..

FL Display (The display part of 13 digits)												
1	2	3	4	5	6	7	8	9	10	11	12	13
T	C	Y	*				m	m	m	m	m	m

Press the **◀◀** or **▶▶** button to select "TC4"

FL Display (The display part of 13 digits)												
1	2	3	4	5	6	7	8	9	10	11	12	13
T	C	4	*									

If the **▶** button is pressed while "TC4" is displayed, the accumulated laser on time of CD, DVD and BD is cleared.

FL Display (The display part of 13 digits)												
1	2	3	4	5	6	7	8	9	10	11	12	13
T	C	1				0	0	0	0	0	0	h

When "TC1", "TC2" or "TC3" is selected with the **◀◀** or **▶▶** button, "mmmmmm" is displayed as "0" so you can check.

(5) Track buffer output mode

Press the **◀◀** or **▶▶** button to select "Y" and switch the track buffer output.

FL Display (The display part of 13 digits)												
1	2	3	4	5	6	7	8	9	10	11	12	13
T	E	Y	T	0	0	0	k		E	U	f	f

(Y=1 : Track buffer being output, 0 : Track buffer output off)

When the **■** button is pressed, the layer above the current layer is displayed. See "5.4 Stopping the mode" (page 23).

(6) Picking up No. display mode

Press the **◀◀** or **▶▶** button to switch to the pickup number display.
The pickup number is a 14-digit number, so it is displayed in two sections.

FL Display (The display part of 13 digits)												
1	2	3	4	5	6	7	8	9	10	11	12	13
T	G	X		Y	Y	Y	Y	Y	Y	Y		

(X (display position) = 1 : Lower digits, 2 : Upper digits. YYYYYYY: Pickup number)

When the **■** button is pressed, the layer above the current layer is displayed. See "5.4 Stopping the mode" (page 23).

(7) Error log display mode

Press the **◀◀** or **▶▶** button to switch to the error log display.
For Error log No. and description of the displayed measurement results, see "Table 3: Error log details" (page 25).

FL Display (The display part of 13 digits)												
1	2	3	4	5	6	7	8	9	10	11	12	13
n	T	H	X									

(n : Error information No.(1 ~ 5), X: Error log No.)

Display when there is no error

FL Display (The display part of 13 digits)												
1	2	3	4	5	6	7	8	9	10	11	12	13
n	T	H	1		N	0		E	0	0	0	0

Press the **◀◀** or **▶▶** button to switch to the [n]. When there is error, error log No. display.

When the **■** button is pressed, the layer above the current layer is displayed. See "5.4 Stopping the mode" (page 23).

(8) Test mode cancel

A confirmation message is displayed. Press the PLAY button to set, canceling the test mode.

FL Display (The display part of 13 digits)												
1	2	3	4	5	6	7	8	9	10	11	12	13
T	I	1		R	e	e	l	l	Y	?		

When the **■** button is pressed, the layer above the current layer is displayed. See "5.4 Stopping the mode" (page 23).

5.4. Stopping the mode

When the ■ button is pressed, the layer above the current layer is displayed. The relationship between the different modes and the display of the different layers is shown on the table below.

Mode	1 layer	2 layer	3 layer
Laser on/off (CD/DVD/BD) mode	T2 LaserOnOff	T2X mmmm nnnn	Non
Servo adjustment value display mode	T3 Servo Adj.	TXX	TXXmmmmmm nn
Error rate (skew) measurement mode	T7 Error Rate	TYFFFFFFFFFFFF	TYmmmmmmllll
Accumulated laser on time display mode	TC LaserOnTim	TCY mmmmmmh	TCY* mmmmmmh TC4*
Track buffer output mode	TE Track Buf	TEYTrack Buff	Non
Picking up No. display mode	TG OPU Number	TGX YYYYYYY	Non
Error log display mode	TH Error Log	nTHX nTH1 No Error	nTHX ddddd nTHAyyy dddd
Test mode cancel	TI Test Exit	TI1 Really?	Non

5.5. About the OPEN/CLOSE (▲)button

Even during the test mode, the tray is opened and closed when the ▲ button is pressed.

5.6. Test mode detailed table

Table 1: Servo adjustment value display mode details

No.	XXX	Name	Address range	Meaning
0	T30	BUF_ID_SDRAM	0x000000~0x3FFFFFF	SDRAM
1	T31	BUF_ID_MPU_ALL	0x000000~0xBEFF3F	MPU(Abs Access)
2	T32	BUF_ID_MPU_RMCR	0x000000~0x00FFFF	ROMCOR
3	T33	BUF_ID_MPU_SYSCFG	0x000000~0x000FFF	SystemConfiguration
4	T34	BUF_ID_MPU_DMAC	0x000000~0x0004FF	DMAC
5	T35A	BUF_ID_MPU_ITIM0	0x000000~0x0000FF	ITIM 0
6	T35B	BUF_ID_MPU_ITIM1	0x000000~0x0000FF	ITIM 1
7	T35C	BUF_ID_MPU_ITIM2	0x000000~0x0000FF	ITIM 2
8	T35D	BUF_ID_MPU_ITIM3	0x000000~0x0000FF	ITIM 3
9	T35E	BUF_ID_MPU_ITIM4	0x000000~0x0000FF	ITIM 4
10	T35F	BUF_ID_MPU_ITIM5	0x000000~0x0000FF	ITIM 5
11	T36	BUF_ID_MPU_RSV2	0x000000~0x0079FF	Reserved
12	T37	BUF_ID_MPU_WDT	0x000000~0x000FFF	WDT
13	T38	BUF_ID_MPU_UART0	0x000000~0x0000FF	UART 0
14	T39	BUF_ID_MPU_UART1	0x000000~0x0000FF	UART 1
15	T40	BUF_ID_MPU_CSIO0	0x000000~0x0000FF	CSIO 0
16	T41	BUF_ID_MPU_CSIO1	0x000000~0x0000FF	CSIO 1
17	T42	BUF_ID_MPU_GPIO0	0x000000~0x0000FF	GPIO 0
18	T43	BUF_ID_MPU_GPIO1	0x000000~0x0000FF	GPIO 1
19	T44	BUF_ID_MPU_GPIO2	0x000000~0x0000FF	GPIO 2
20	T45	BUF_ID_MPU_RSV5	0x000000~0x00BCFF	Reserved
21	T46	BUF_ID_MPU_HEXBIU	0x000000~0x000FFF	HEXBIU
22	T47	BUF_ID_MPU_HCSC	0x000000~0x000FFF	HCSC
23	T48	BUF_ID_MPU_RSV6	0x000000~0x7DDFFF	Reserved
24	T49	BUF_ID_MPU_RSV7	0x000000~0x3DFEFF	Reserved
25	T50	BUF_ID_MPU_INT	0x000000~0x00003F	INT
26	T51	BUF_ID_IRAM	0x000000~0x003FFF	IRAM(internal SRAM)
27	T52	BUF_ID_DSP	0x000000~0x001FFF	DSP Register
28	T53	BUF_ID_AFE	0x000000~0x0000FF	AFE Register
29	T54	BUF_ID_SVO_ALL	0x000000~0x001FFF	SVO REG ABS ACCESS
30	T55	BUF_ID_SVO_REG	0x000000~0x0007FF	SVERVO REG
31	T56	BUF_ID_SVO_SVRAM	0x000000~0x0005FF	SVRAM
32	T57A	BUF_ID_SVO_CRAM0	0x000000~0x0001FF	CRAM0

No.	XXX	Name	Address range	Meaning
33	T57B	BUF_ID_SVO_CRAM1	0x000000~0x0001FF	CRAM1
34	T57C	BUF_ID_SVO_CRAM2	0x000000~0x0001FF	CRAM2
35	T57D	BUF_ID_SVO_CRAM3	0x000000~0x0001FF	CRAM3
36	T58A	BUF_ID_SVO_ZRAM0	0x000000~0x0001FF	ZRAM0
37	T58B	BUF_ID_SVO_ZRAM1	0x000000~0x0001FF	ZRAM1
38	T58C	BUF_ID_SVO_ZRAM2	0x000000~0x0001FF	ZRAM2
39	T58D	BUF_ID_SVO_ZRAM3	0x000000~0x0001FF	ZRAM3
40	T59	BUF_ID_EPRM	0x000000~0x000FFF	EEPROM
41	T60	BUF_ID_PUCONT_LDD	0x000000~0x000007	LDD
42	T61	BUF_ID_SVRESULT	0x000000~0x0002C3	SvResult
43	T62	BUF_ID_LD_TIME	0x000000~0x00000D	LD ON Time Integrated value
44	T63	BUF_ID_IOP	0x000000~0x000007	IOP(Stored value)

Table 2: Error rate details

YY	Measurement position	Error rate display details for each media type			Remarks
		BD	DVD	CD	
71	The inner circumference of 1-layer	BIS error detection signed number	It is invalid.	It is invalid.	When this is selected for DVD or CD, it shifts to YY=73.
72	The inner circumference of 1-layer	BIS error uncorrectable signed numbe	It is invalid.	It is invalid.	When this is selected for DVD or CD, it shifts to YY=73.
73	The inner circumference of 1-layer	LDC error detection signed number	PI error detection number	C1 error detection number	
74	The inner circumference of 1-layer	LDC error uncorrectable signed numbe	PO uncorrectable error number	C2 uncorrectable error number	
75	The central circumference of 1-layer	BIS error detection signed number	It is invalid.	It is invalid.	When this is selected for DVD or CD, it shifts to YY=77.
76	The central circumference of 1-layer	BIS error uncorrectable signed numbe	It is invalid.	It is invalid.	When this is selected for DVD or CD, it shifts to YY=77.
77	The central circumference of 1-layer	LDC error detection signed number	PI error detection number	C1 error detection number	
78	The central circumference of 1-layer	LDC error uncorrectable signed numbe	PO uncorrectable error number	C2 uncorrectable error number	
79	The outer circumference of 1-layer	BIS error detection signed number	It is invalid.	It is invalid.	When this is selected for DVD or CD, it shifts to YY=81.
80	The outer circumference of 1-layer	BIS error uncorrectable signed numbe	It is invalid.	It is invalid.	When this is selected for DVD or CD, it shifts to YY=81.
81	The outer circumference of 1-layer	LDC error detection signed number	PI error detection number	C1 error detection number	
82	The outer circumference of 1-layer	LDC error uncorrectable signed numbe	PO uncorrectable error number	C2 uncorrectable error number	
83	The inner circumference of 2-layer	BIS error detection signed number	It is invalid.	It is invalid.	When this is selected for 2-layer DVD, it shifts to YY=85. When this is selected for 1-layer DVD or CD, it shifts to YY=73.
84	The inner circumference of 2-layer	BIS error uncorrectable signed number	It is invalid.	It is invalid.	When this is selected for DVD 2-layer, it shifts to YY=85. When this is selected for DVD 1-layer or CD, it shifts to YY=73.

YY	Measurement position	Error rate display details for each media type			Remarks
		BD	DVD	CD	
85	The inner circumference of 2-layer	LDC error detection signed number	PI error detection number	It is invalid.	When this is selected for 1-layer DVD or CD, it shifts to YY=73.
86	The inner circumference of 2-layer	LDC error uncorrectable signed numbe	PO uncorrectable error number	It is invalid.	When this is selected for 1-layer DVD or CD, it shifts to YY=73.
87	The central circumference of 2-layer	BIS error detection signed number	It is invalid.	It is invalid.	When this is selected for DVD 2-layer, it shifts to YY=89. When this is selected for DVD 1-layer or CD, it shifts to YY=77.
88	The central circumference of 2-layer	BIS error uncorrectable signed numbe	It is invalid.	It is invalid.	When this is selected for DVD 2-layer, it shifts to YY=89. When this is selected for DVD 1-layer or CD, it shifts to YY=77.
89	The central circumference of 2-layer	LDC error detection signed number	PI error detection number	It is invalid.	When this is selected for DVD 1-layer or CD, it shifts to YY=77.
90	The central circumference of 2-layer	LDC error uncorrectable signed numbe	PO uncorrectable error number	It is invalid.	When this is selected for DVD 1-layer or CD, it shifts to YY=77.
91	The outer circumference of 1-layer	BIS error detection signed number	It is invalid.	It is invalid.	When this is selected for DVD 2-layer, it shifts to YY=93. When this is selected for DVD 1-layer or CD, it shifts to YY=81.
92	The outer circumference of 1-layer	BIS error uncorrectable signed numbe	It is invalid.	It is invalid.	When this is selected for DVD 2-layer, it shifts to YY=93. When this is selected for DVD 1-layer or CD, it shifts to YY=81.
93	The outer circumference of 1-layer	LDC error detection signed number	PI error detection number	It is invalid.	When this is selected for DVD 1-layer or CD, it shifts to YY=81.
94	The outer circumference of 1-layer	LDC error uncorrectable signed numbe	PO uncorrectable error number	It is invalid.	When this is selected for DVD 1-layer or CD, it shifts to YY=81.

*The inner circumference of the layer refers to the physical inner circumference for DVD parallel, the physical outer circumference for the opposite case.

*The inner circumference of the layer refers to the physical outer circumference for DVD parallel, the physical inner circumference for the opposite case.

Table 3: Error log details

Error log No.	Contents (Error log overall layout)	Remarks
1	LD On Time (4Byte)	
2	Error type (2Byte)	See "Table 3-1: Error type details"
(31 to 34 displayed in 4-byte units)	Reserve (16Byte)	
4	Media type (2Byte)	See "Table 3-2: Media type details"
5	Reserve (4Byte)	
6	Reserve (4Byte)	
7	Reserve (2Byte)	
8	HyBrid Disc layer (2Byte)	See "Table 3-3: HyBrid Disc current layer details"
9 (91 to 92 displayed in 7-digit units) (Matched to TG pickup number display)	PU# (16Byte)	
A (A000 to A161 displayed in 2-digit units)	Reserve (708Byte)	
B (B1 to B3 displayed in 4-digit units)	Reserve (11Byte)	
C	Reserve (1Byte)	
D (D1 to D3 displayed in 4-digit units)	Reserve (12Byte)	

Table 3-1: Error type details

Error type	Error code
NoError	0x0000
Focus does not turn on.	0x0001
Tracking does not turn on.	0x0002
CLV does not turn on.	0x0003
ID cannot be read.	0x0004
Loader error	0x0005
Thread error	0x0006
Expander error	0x0007
Other error	0x0008
Error disc (Failure to recognition of disc)	0x0009
Seek error	0x0010
Lead error	0x0020
Other	Reserved

Tracking does not turn on.

Table 3-3: HyBrid Disc current layer details

HyBrid Disc current layer	Current layer code
SACD layer	0x0000
CD layer	0x0001
DVD layer	0x0002
BD layer	0x0003
Other	Reserved

Table 3-2: Media type details

Media type	Media code
DVD-ROM	0x0001
DVD-R	0x0002
DVD-RW	0x0003
DVD-PLUS-R	0x0004
DVD-PLUS-RW	0x0005
DVD-ROM DL	0x0006
DVD+R DL	0x0007
DVD-R DL	0x0008
DVD+RW DL	0x0009
DVD-RW DL	0x000A
CD-ROM	0x000B
CD-R	0x000C
CD-RW	0x000D
BD-RE SL	0x000E
BD-RE DL	0x000F
BD-R SL	0x0010
BD-R DL	0x0011
BD-R SL LTH	0x0012
BD-ROM SL	0x0013
BD-ROM DL	0x0014
BD-Hybrid	0x0015
SACD-Hybrid	0x0016
SACD DL	0x0017
SACD SL	0x0018
DVD-Hybrid	0x0019
Unknown	0xFFFF
Other	Reserved

VERSION UPGRADE PROCEDURE OF FIRMWARE

You can update by downloading the latest firmware from the Internet.
To update the IP ROM, refer to "Updating the IP ROM" on page 28.

1. Update from the Internet

1.1. Connecting to the Network

(1) System Requirement

- Internet Connection by Broadband Circuit
- Modem
- Router
- Ethernet cable (CAT-5 or greater recommended)

(2) Setting

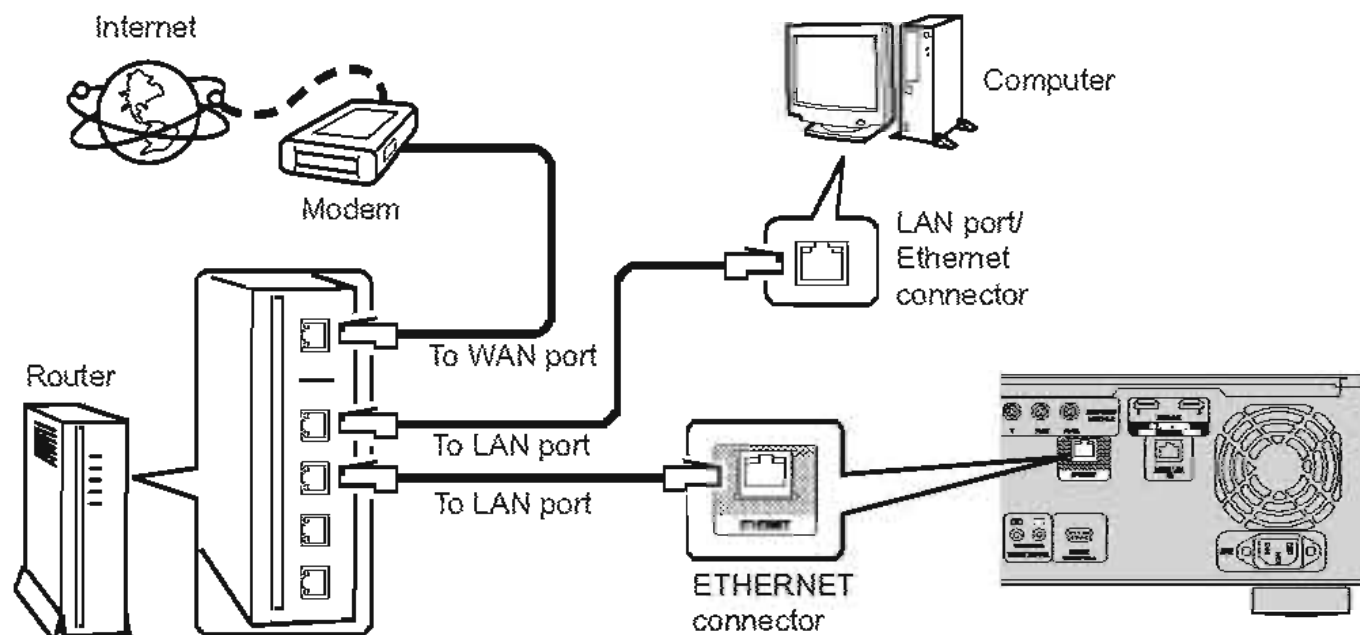

1.2. Check for Update and Update

Check if the latest firmware exists. You can also check approximately how long it will take to complete an update.

- (1) Press the SETUP button on the remote control to display the GUI menu.
- (2) Use the cursor buttons to select "Other settings" → "Firmware update" → "Update check".
- (3) Press the ENTER button.
 - The latest version of the firmware uploaded to the web is displayed.
 - If the latest firmware version is on the web, proceed to (4).
 - If the latest firmware is already installed, press the SETUP button to close the menu.
- (4) Use the cursor buttons to select "Update", then press the ENTER button.
 - During update, the power indicator lights red and the GUI screen is shut down. And a rough remaining time is indicated on the display.
 - When updating is complete the power indicator turns off and normal status is resumed.
- (5) Press the SETUP button to close the menu.

--- Cautions on Firmware Update ---

- In order to use these functions, you must have the correct system requirements and settings for a broadband Internet connection.
- Do not turn off the power until updating is completed.

Even with a broadband connection to the Internet, approximately about 1 hour is required for the updating procedure to be completed.

Once updating starts, normal operations on the UD9004 cannot be performed until updating is completed. Also, setting items of the GUI menu of UD9004 or setting items of the image adjustment may be initialized.

Make a note of the settings before updating, and set them again after updating.

2. Update of the IP ROM

NOTE : When the firmware is updated, the UD9004's settings and picture adjustments may be reset. Make a note of the settings before updating, and set them again after updating.

2.1. Installation of application for IP ROM update

Prepare a computer connected to the Internet.

- (1) From the SDI's UD9004 screen, download the following application software:
 - Soft : silicon developer toolkit

2.2. Preparations (proceeding to connections and the product mode)

- (1) Connect the set and computer using an RS-232C cable (straight type).
- (2) With no disc loaded in the set, plug the AC cord into the power outlet while pressing the SD/DISC and **III** buttons on the main unit simultaneously.
 - The product mode is set and the "HD" indicator lights.
 - While in the product mode, no video signals are output from the HDMI terminal.
- (3) After "NO DISC" appears on the FL tube, press the SD/DISC button to display "IP/S Update".
 - The display switches as shown below each time the SD/DISC button is pressed.
"SD Mode" → "F/E Update" → "IP/S Update" → "Disc Mode" → "SD Mode"
- (4) Press the **▶** button/
"IP/S Writing" is displayed on the FL tube.

2.3. Update

- (1) From the Windows Start menu, open "All Programs" → "Silicon Optix" → "Developers ToolKit" → "Updater" → "Updater.exe".
- (2) At "Targets on" (①), select "UART", then click the "Search" button (②).

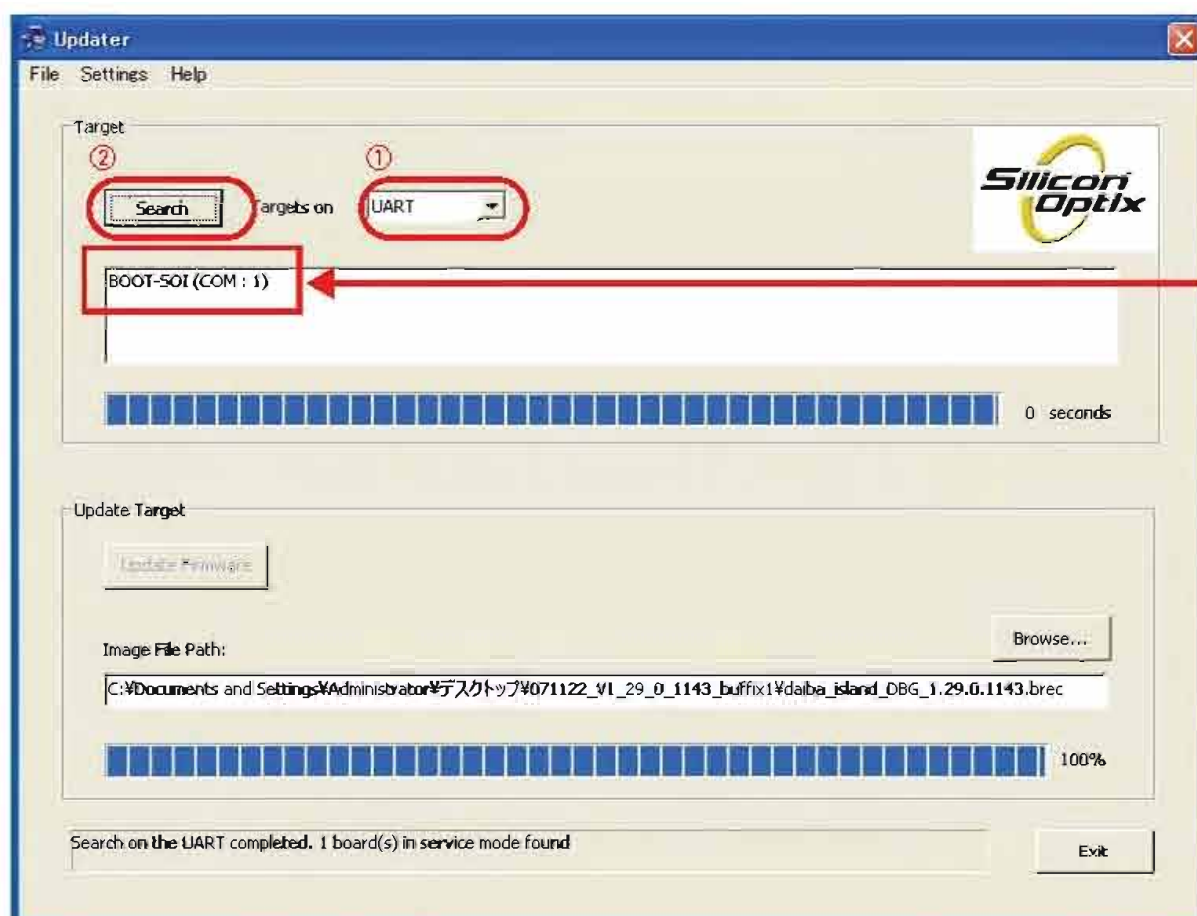

▪ "BOOT-SOI(COM:1)" is displayed if the target is recognized normally.

- (3) After selecting the "BOOT-SOI(COM:1)" item, click the "Browse" button to select the IP ROM to be updated. Check the selected file in the "Image File Path window", then click the "Update Firmware" button to begin updating.

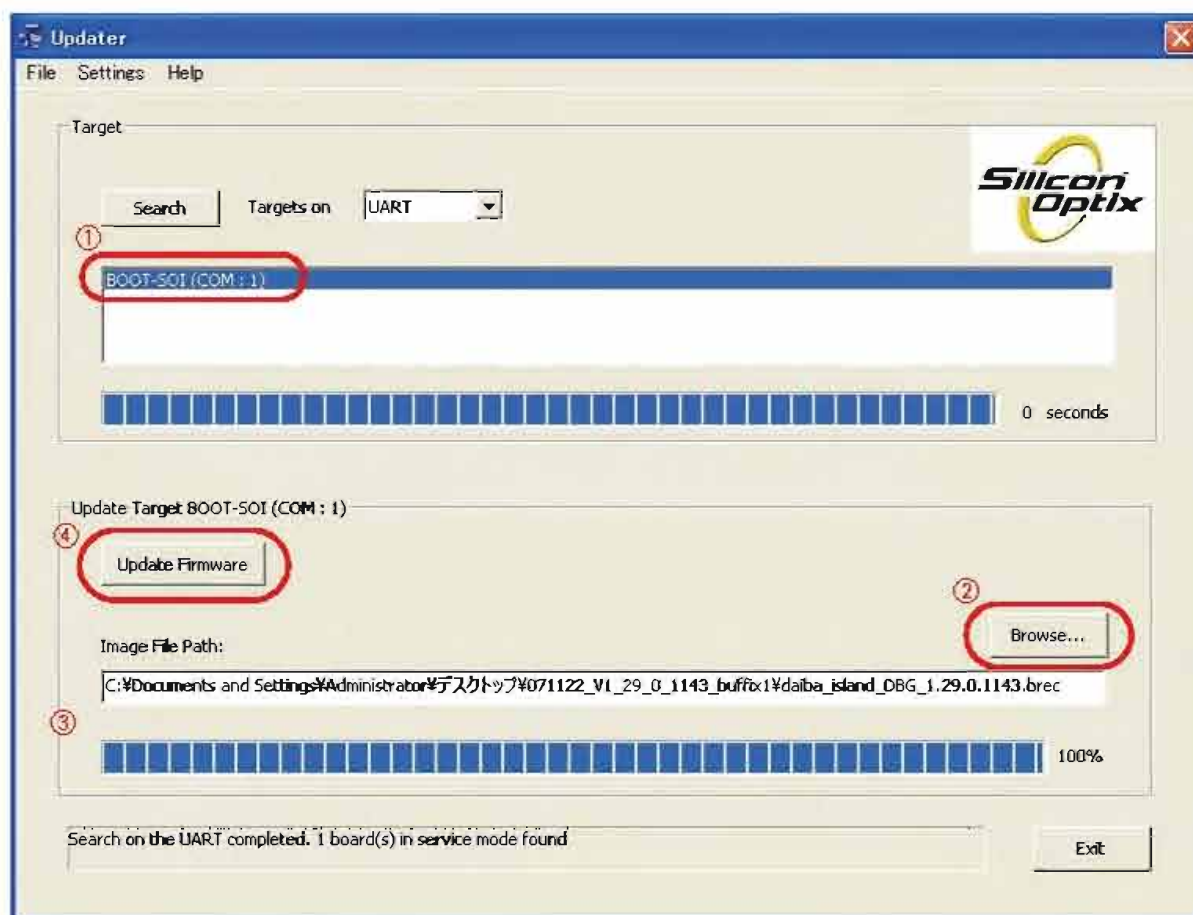

- (4) During update, the update status is indicated "Burning flash, please wait...". (Approximately 9 minutes are required for updating to be completed.)

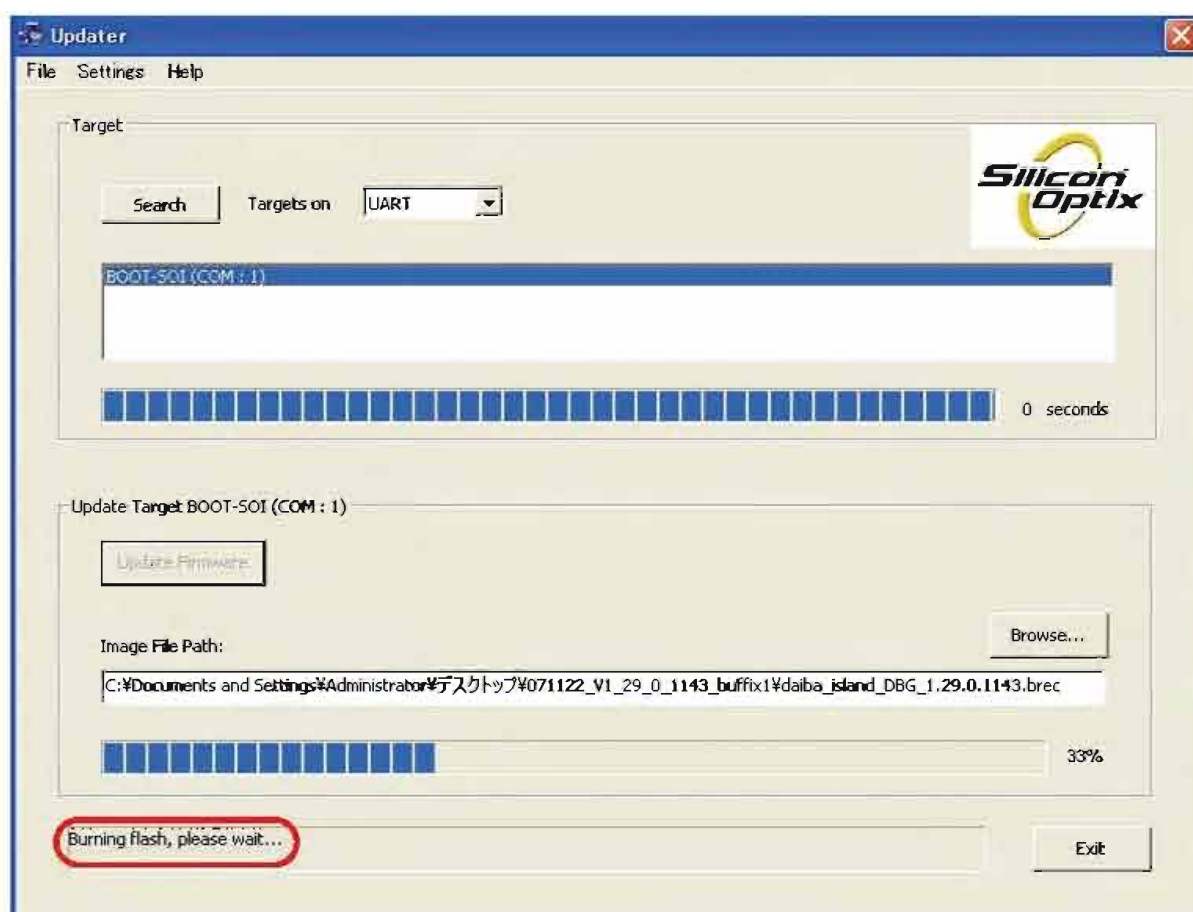

- (5) Once the update status reaches 100%, "Succeeded updating the firmware" is displayed and updating is completed.

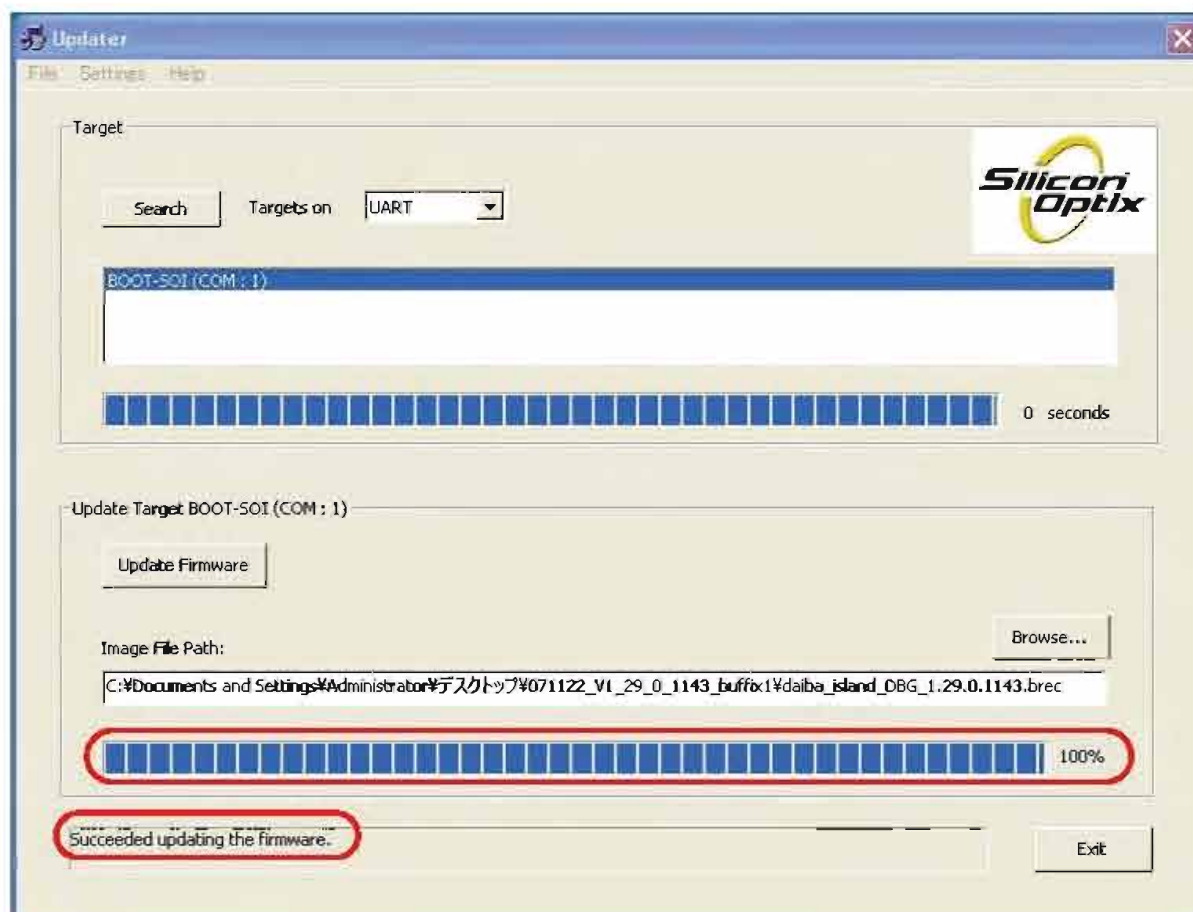

- (6) Once updating is completed, unplug the AC cord.
(7) Reconnect the AC cord to the outlet, wait 3 minutes, then unplug it.
At this time, no video signals are output from the HDMI terminal, even if the power is turned on.

2.4. Version check

- (1) With no disc loaded in the set, plug the AC cord into the power outlet while pressing the ▲ and ► buttons on the main unit simultaneously.
 - "NO DISC" is displayed on the FL tube.
- (2) Press remote controller "3265".
- (3) Press the Cursor buttons(▲ or ▼) on the remote control unit, check the "IP Ver XXXXXX" is displayed on the FL tube.
 - XXXXXX : Version of updated IP ROM

2.5. Service check

Play a Blu-ray disc (1080p/24) and check that the video output operates normally.

- Connect the TV and UD9004 with an HDMI cable.
- There is no need to set the HDMI output resolution in order to check.

--- Cautions on Firmware Update ---

- When the firmware is updated, the UD9004's settings and picture adjustments may be reset. Make a note of the settings before updating, and set them again after updating.
- Do not unplug the RS-232C cable or set the power to standby during updating.
- Normal operations are not possible during updating.

TROUBLE SHOOTING

1. 8U-37AK510101, 8U-37AK510201, 8U-37AK510301, 8U-37AK520501

Check connection MAIN PWB UNIT
8U-37AK550001(MAIN UNIT)
• [CY252]input signal.
• [CY253]input signal.

N.G. →

Check soldering, FFC cable
• [CY252]:8U-37AK550001
• [CY253]:8U-37AK550001
• Check FFC cable insertion

↓ O.K.

Check DATA Signal
8U-37AK510101
• [QA31]
3,5,18,19,42pin(WCK=16/8/4fs,
BCK=512/256/128fs,
DATA,MCK=512/256/128fs)

8U-37AK510201
• [QX31]
3,5,18,19,42pin(WCK=16/8/4fs,
BCK=512/256/128fs,
DATA,MCK=512/256/128fs)

8U-37AK510301
• [QG31][QW31]
3,5,18,19,42pin(WCK=16/8/4fs,
BCK=512/256/128fs,
DATA,MCK=512/256/128fs)

8U-37AK520501
• [QA31]
3,5,18,19,42pin(WCK=16/8/4fs,
BCK=512/256/128fs,
DATA,MCK=512/256/128fs)

N.G. →

Check soldering, FFC cable
• [JA51]:8U-37AK510101
• [JA52]:8U-37AK510101
• [JX53]:8U-37AK510201
• [JG53]:8U-37AK510301
• [JX54]:8U-37AK510301
• [JS53]:8U-37AK520501
• Check FFC cable insertion

2. 8U-37AK53000 (POWER UNIT)

2.1. The power cannot be turned on.

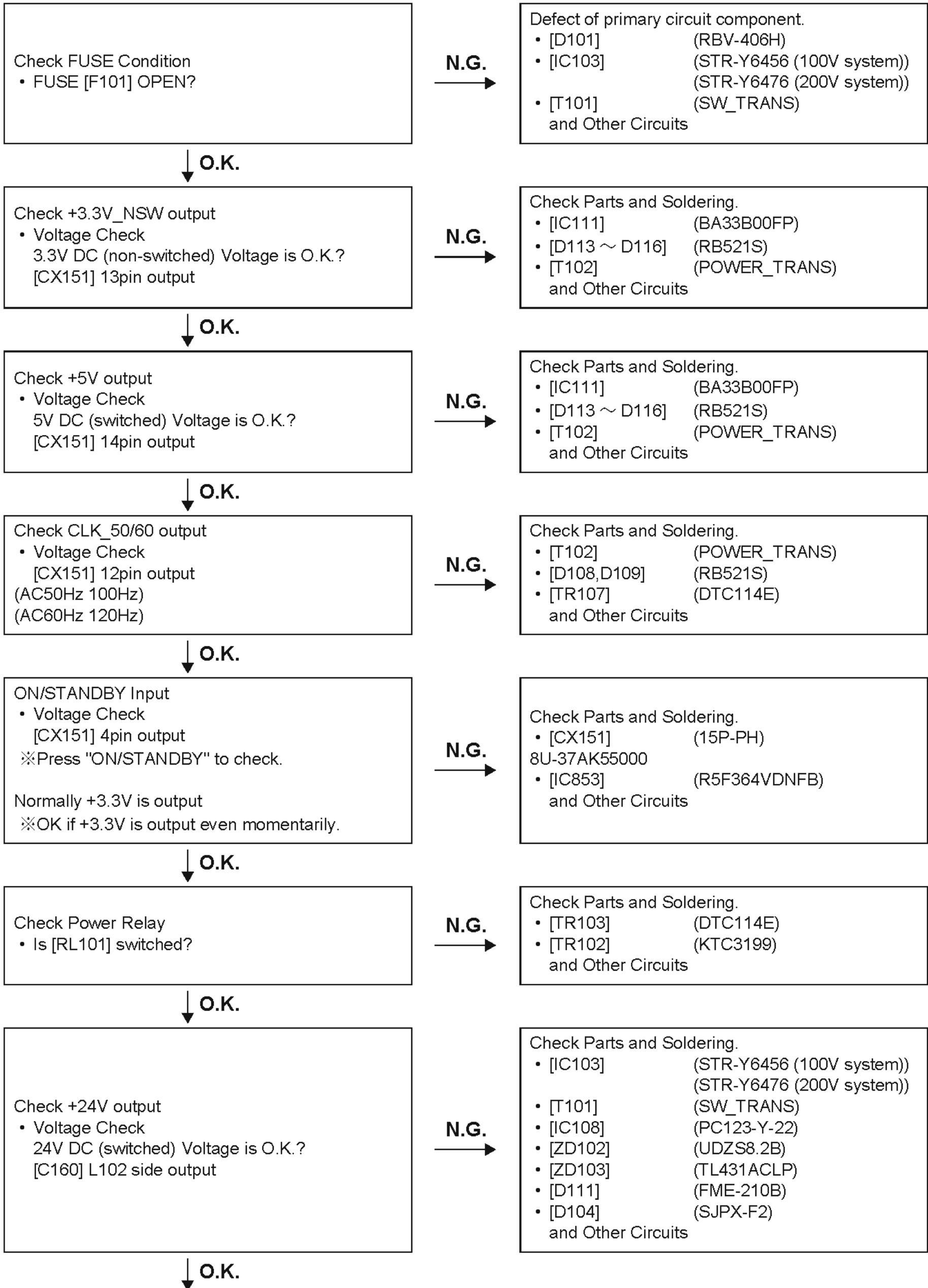

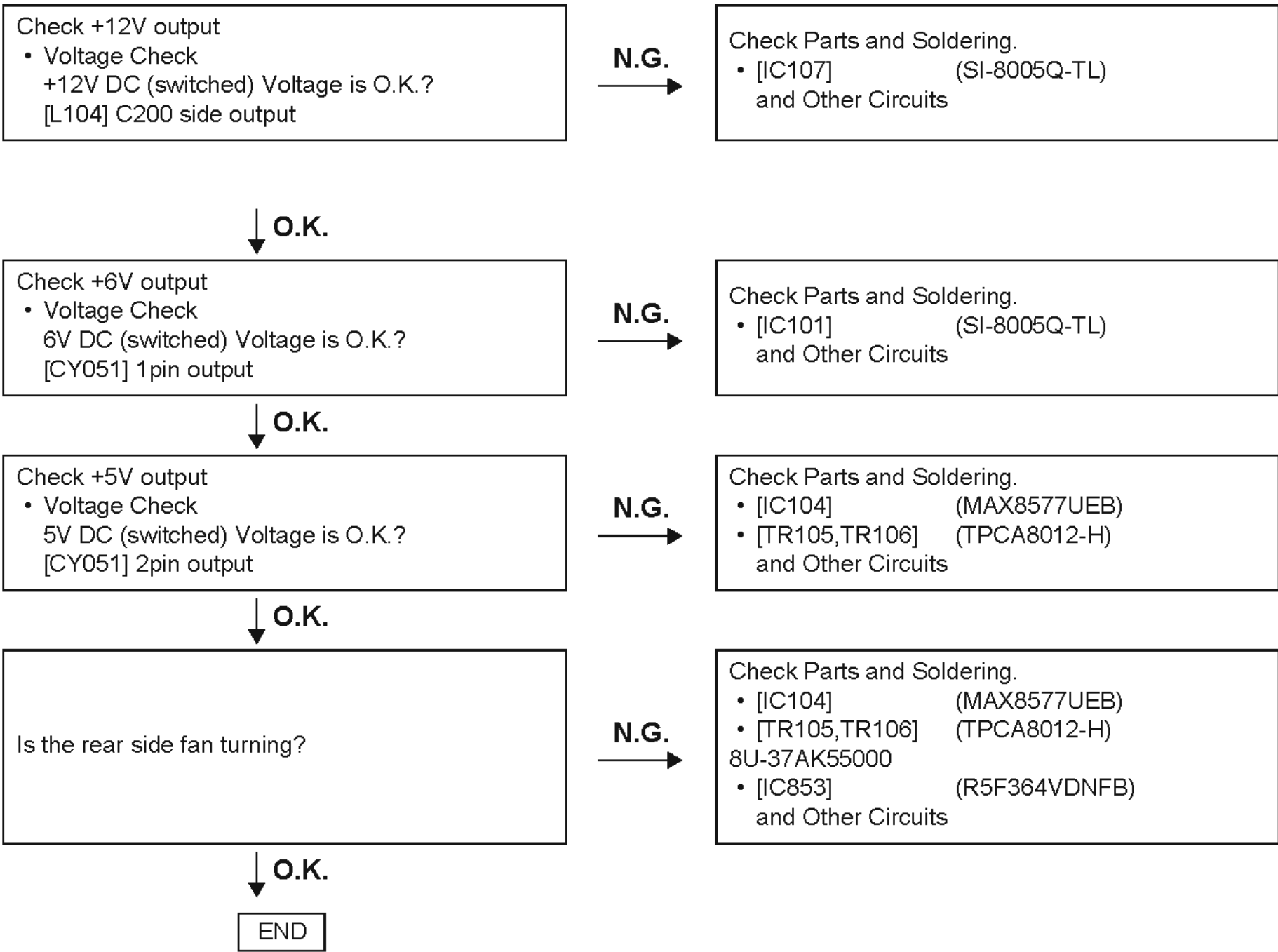

3. 8U-37AK510201(DISPLAY UNIT)

3.1. FL TUBE dosen't light

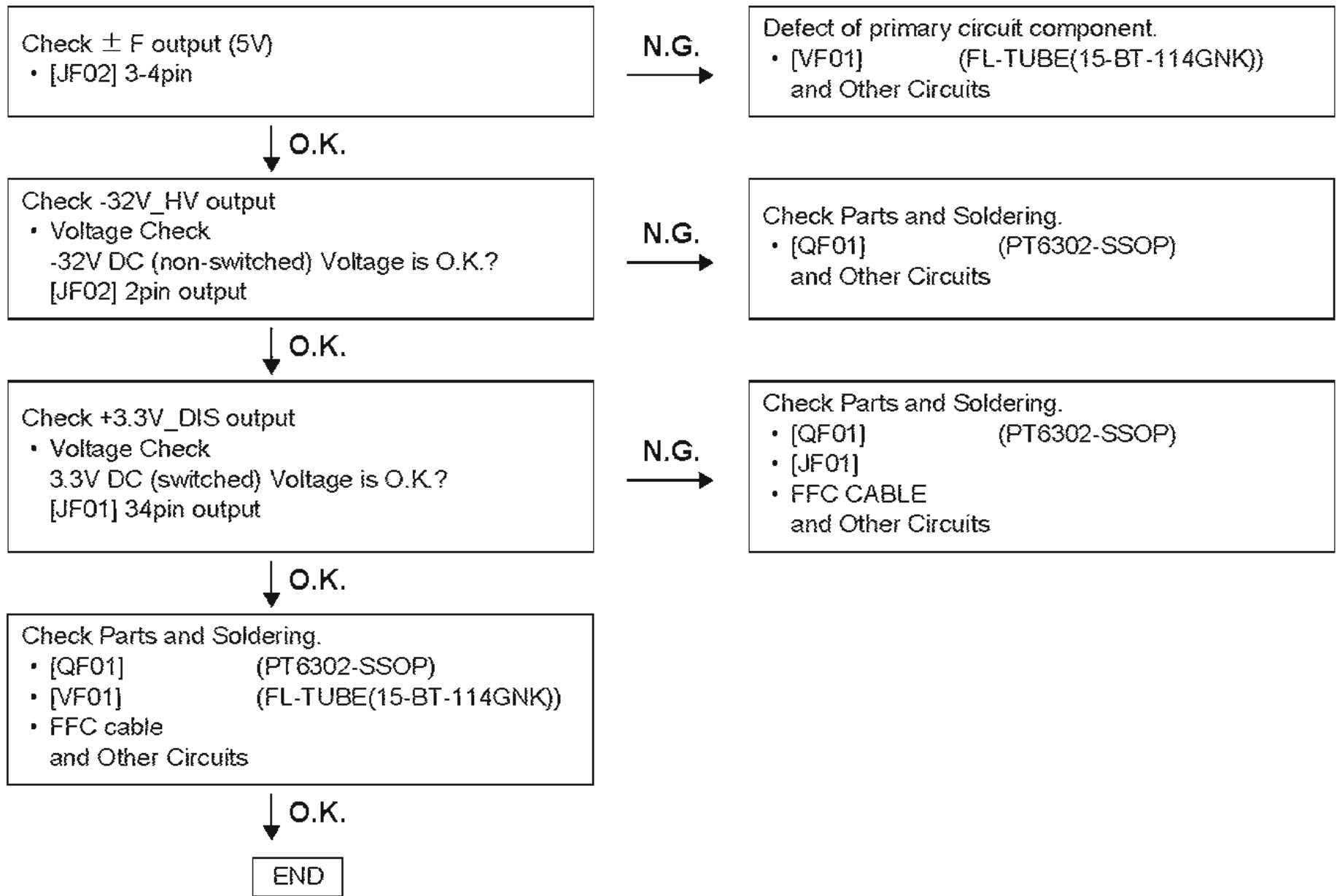

4. 8U-37AK55000 (MAIN UNIT)

4.1. No System Power up or Loading

No Video or Audio output

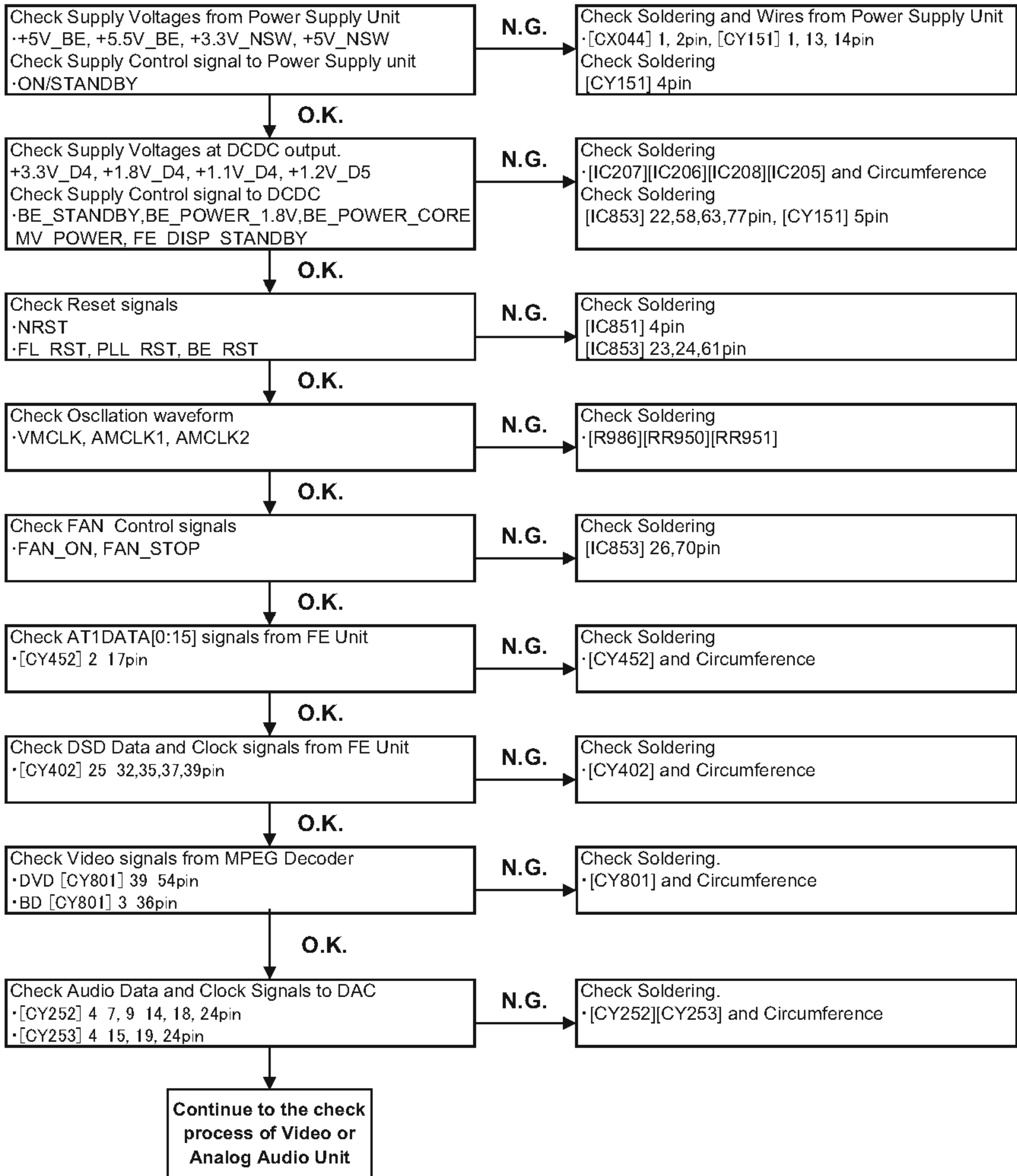

4.2. No Ether-net Operation

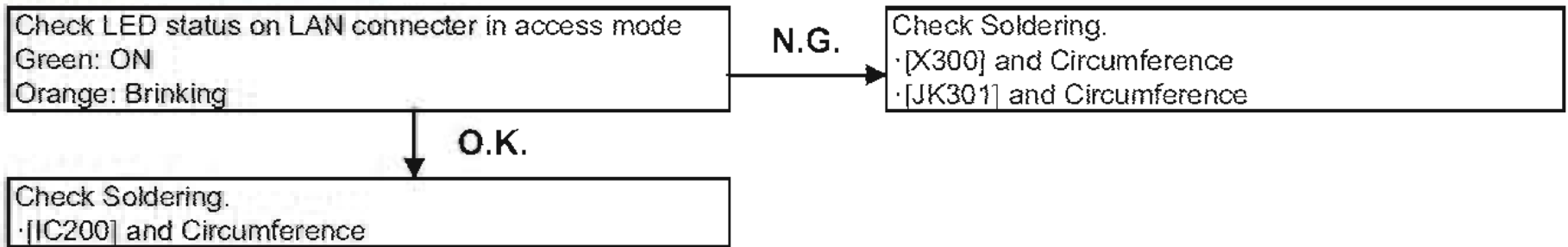

4.3. No SD Card Operation

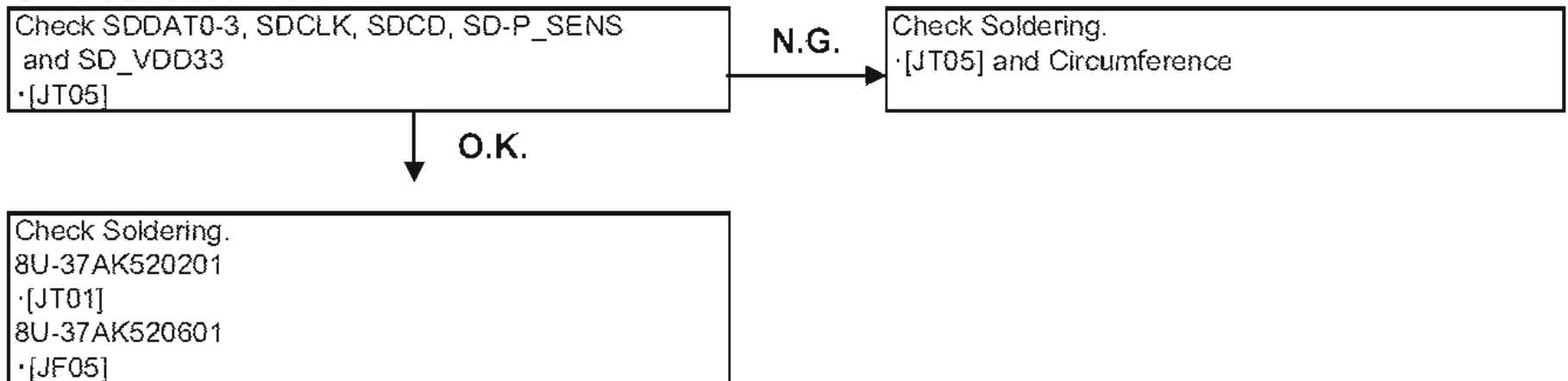

5. 8U-310002 (VIDEO UNIT)

5.1. Video output does not be outputted.

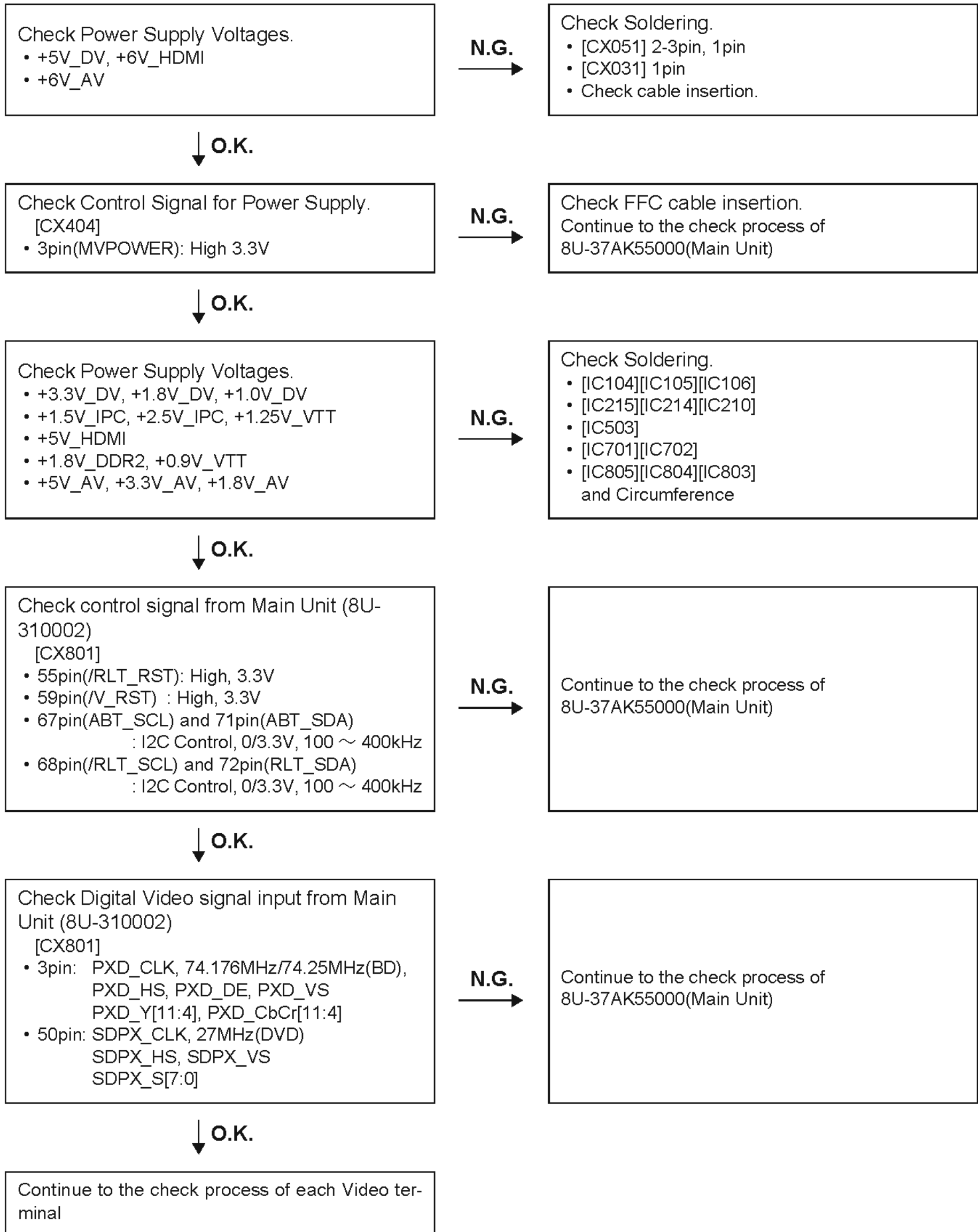

5.2. Video/S-Video Out does not be outputted

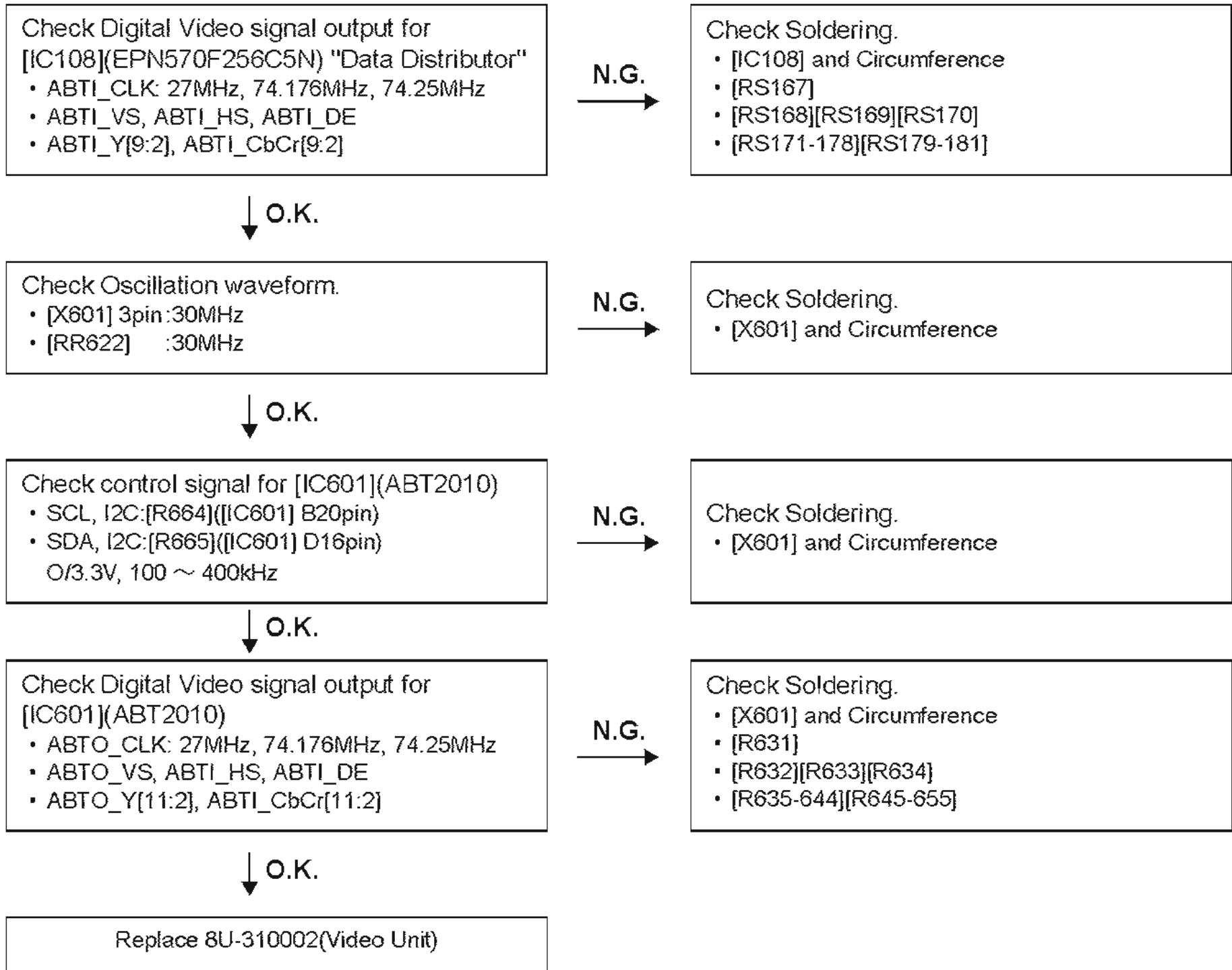

5.3. Component Out does not be outputted

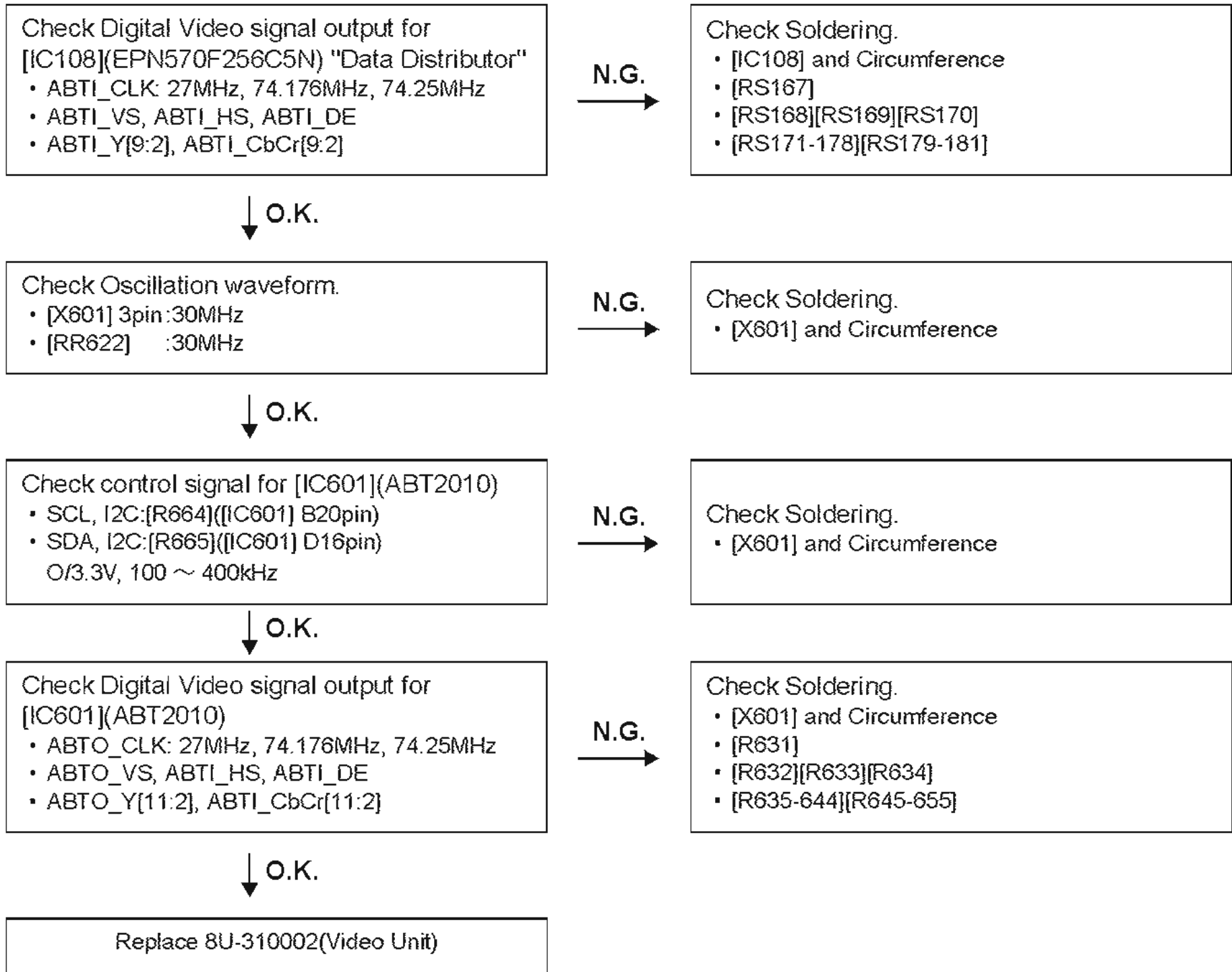

5.4. HDMI Out does not be outputted

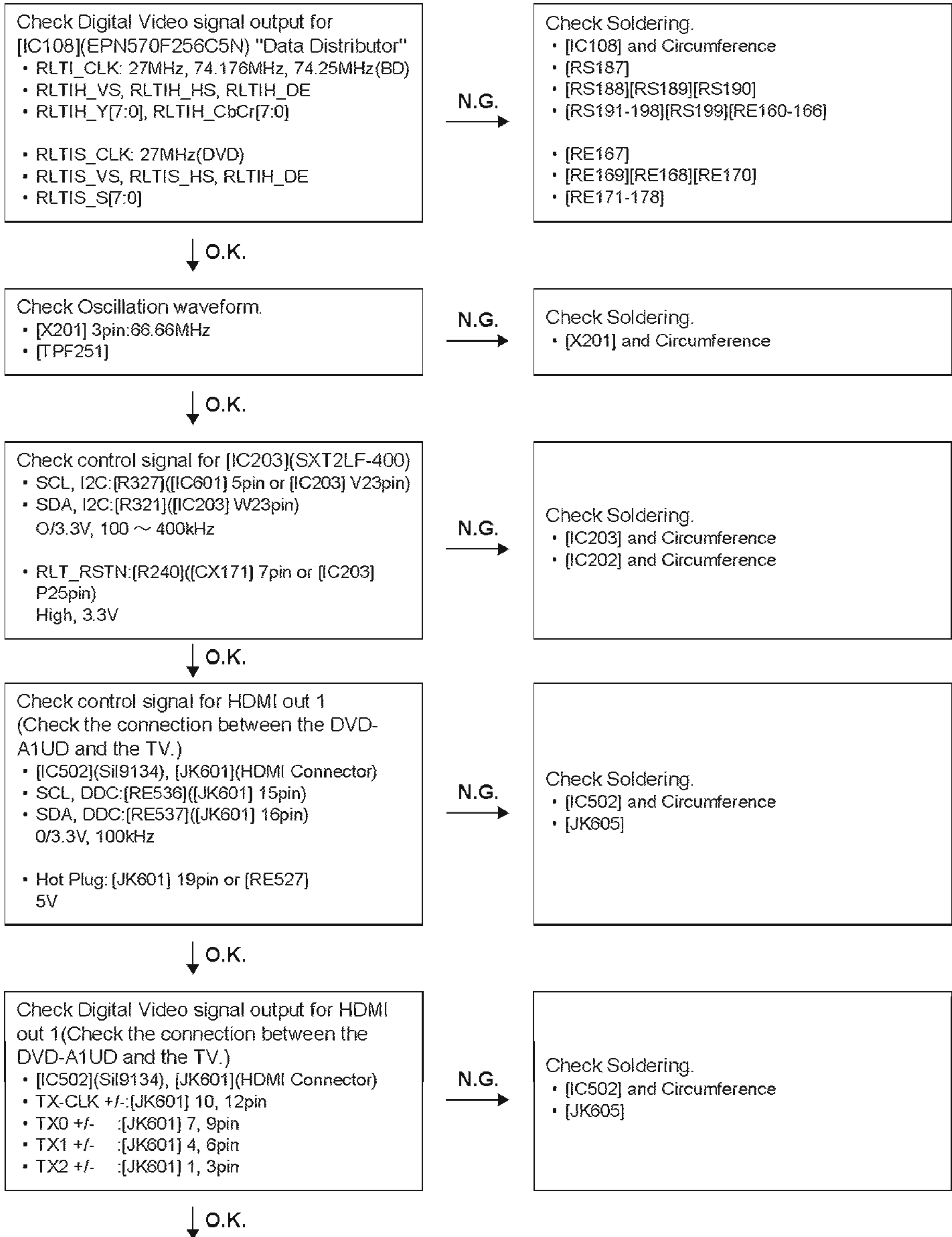

Check control signal for HDMI out 2 (Check the connection between the DVD-A1UD and the TV.)

- [IC504](SiI9134) and [JK605](HDMI Connector)
- SCL, DDC:[RS530]([JK605] 15pin)
- SDA, DDC:[RS531]([JK605] 16pin)
0/3.3V, 100kHz
- Hot Plug: [JK601] 19pin or [RS523] 5V

N.G.
→

- Check Soldering.
- [IC504] and Circumference
 - [JK605]

↓ O.K.

Check Digital Video signal output for HDMI out 2 (Check the connection between the DVD-A1UD and the TV.)

- [IC504](SiI9134), [JK605](HDMI Connector)
- TX-CLK +/-:[JK605] 10, 12pin
- TX0 +/- :[JK605] 7, 9pin
- TX1 +/- :[JK605] 4, 6pin
- TX2 +/- :[JK605] 1, 3pin

N.G.
→

- Check Soldering.
- [IC504] and Circumference
 - [JK605]

↓ O.K.

Replace 8U-310002(Video Unit)

6. 8U-310010 (FE/SACD UNIT)

6.1. BD or DVD or CD or SACD check

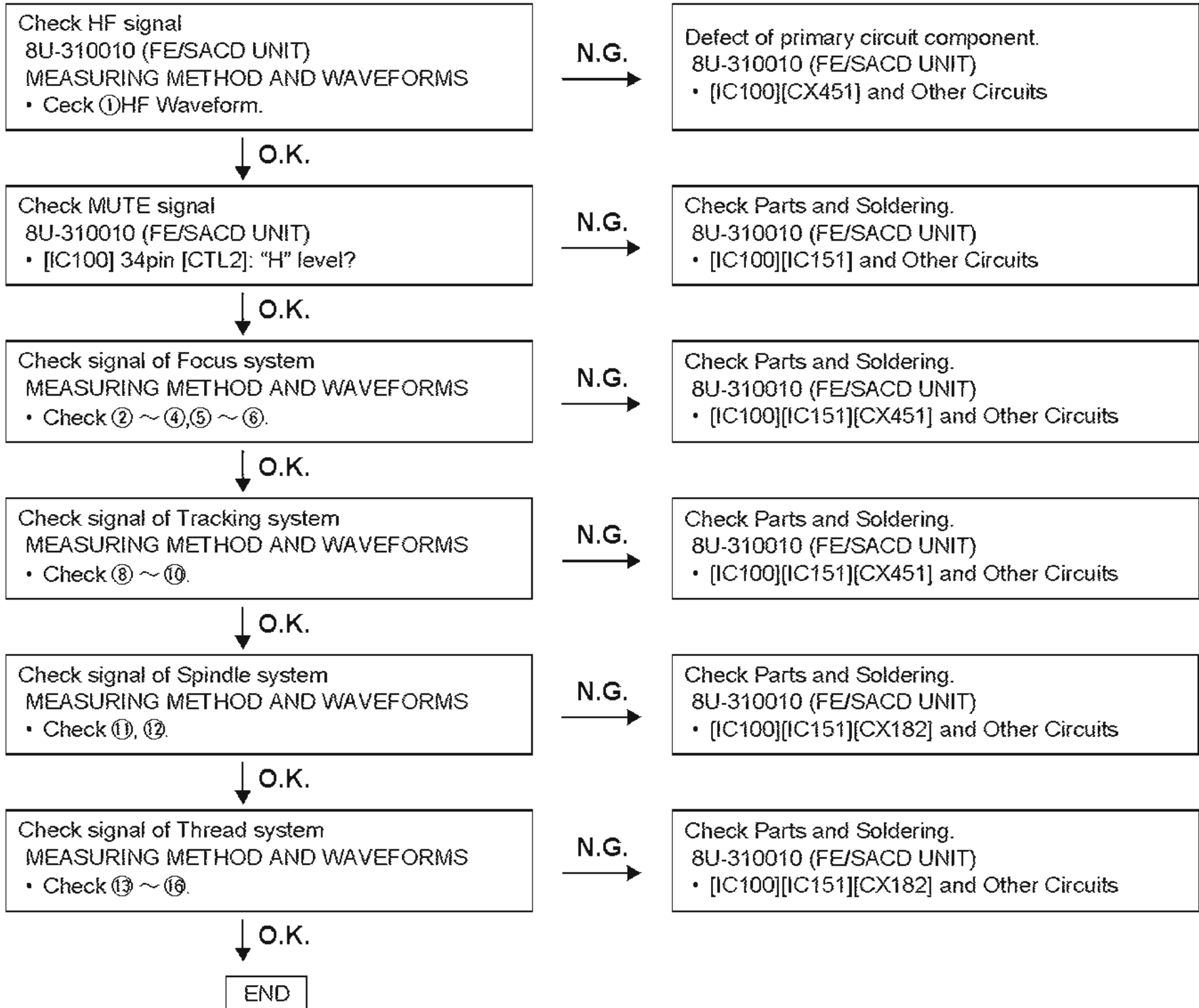

Block Diagram

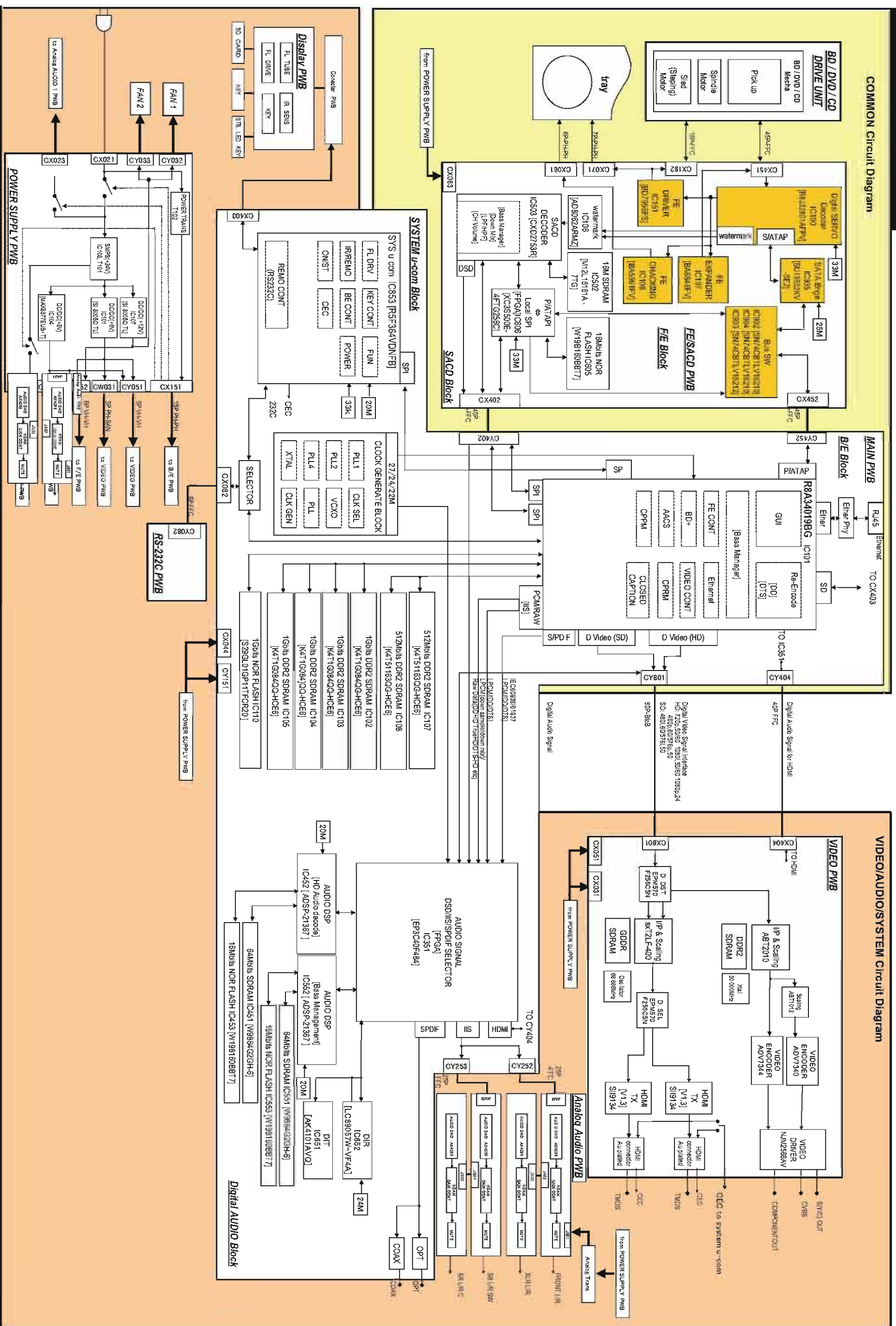

SEMICONDUCTORS

Only major semiconductors are shown, general semiconductors etc. are omitted to list.
 The semiconductor which described a detailed drawing in a schematic diagram are omitted to list.

1. IC's

SI9134CTU (8U-310002 : IC502,IC504)

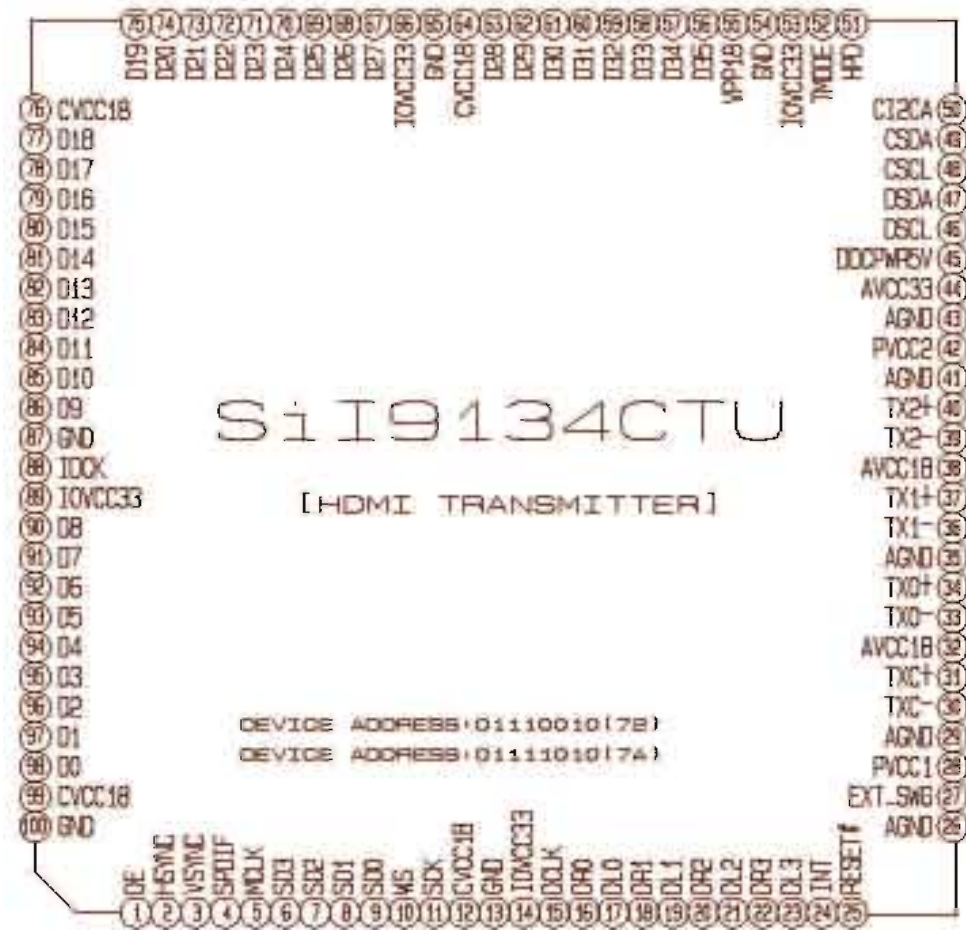

SI9134CTU Block Diagram

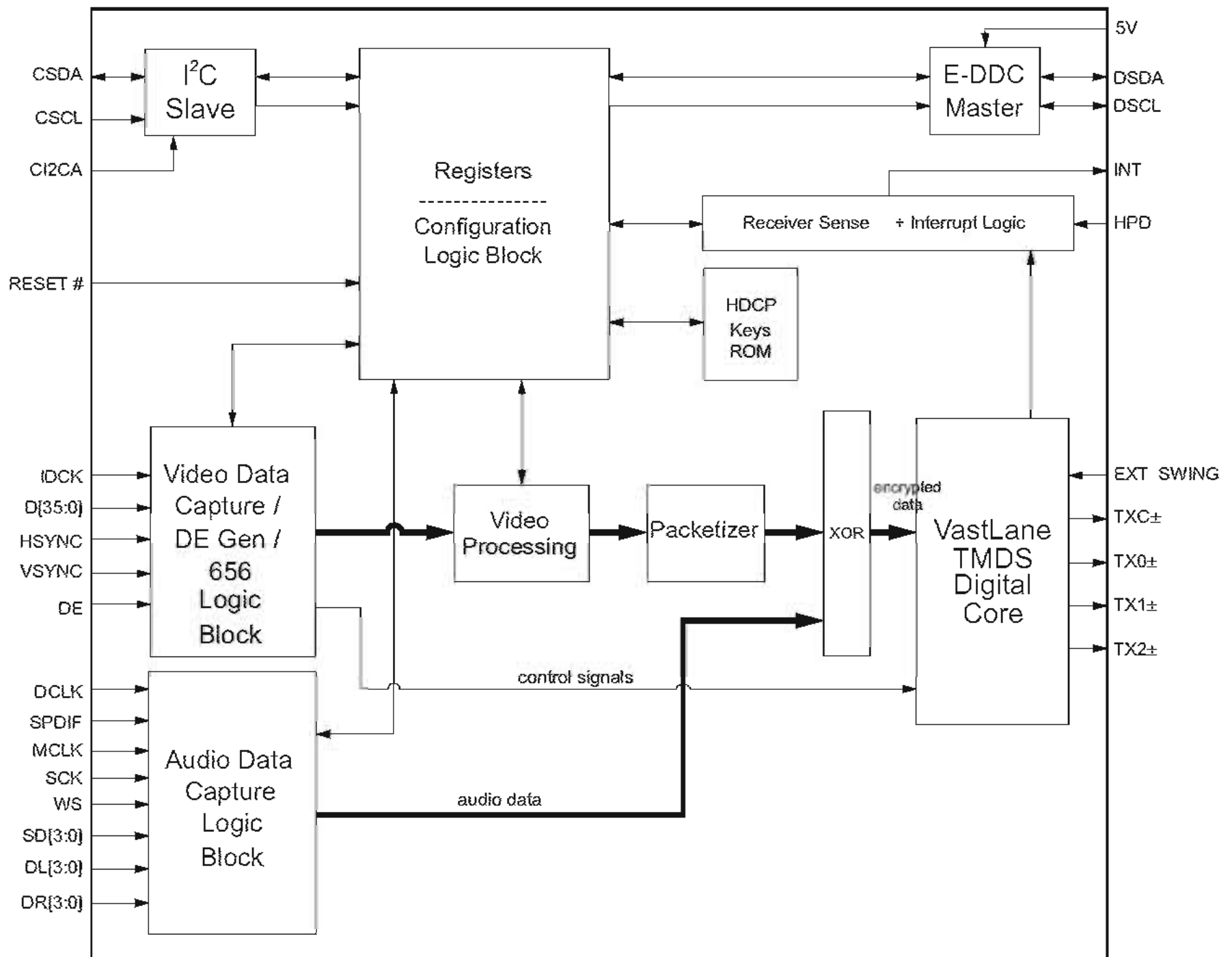

SII9134CTU Pin Function

Pin Name	Pin #	Type	Dir	Description
D0	98	LVTTL	Input	These are the lower 12 bits of the 36-bit pixel bus. These pins are highly configurable and support multiple RGB and YCbCr formats. See Data Bus Mappings on page 30 for complete information.
D1	97	LVTTL	Input	
D2	96	LVTTL	Input	
D3	95	LVTTL	Input	
D4	94	LVTTL	Input	
D5	93	LVTTL	Input	
D6	92	LVTTL	Input	
D7	91	LVTTL	Input	
D8	90	LVTTL	Input	
D9	86	LVTTL	Input	
D10	85	LVTTL	Input	
D11	84	LVTTL	Input	
D12	83	LVTTL	Input	These are the middle 12 bits of the 36-bit pixel bus.
D13	82	LVTTL	input	
D14	81	LVTTL	Input	
D15	80	LVTTL	input	
D16	79	LVTTL	Input	
D17	78	LVTTL	Input	
D18	77	LVTTL	Input	
D19	75	LVTTL	Input	
D20	74	LVTTL	Input	
D21	73	LVTTL	input	
D22	72	LVTTL	Input	
D23	71	LVTTL	input	
D24	70	LVTTL	Input	
D25	69	LVTTL	input	
D26	68	LVTTL	Input	
D27	67	LVTTL	Input	
D28	63	LVTTL	input	
D29	62	LVTTL	Input	
D30	61	LVTTL	Input	
D31	60	LVTTL	Input	
D32	59	LVTTL	input	
D33	58	LVTTL	Input	
D34	57	LVTTL	input	
D35	56	LVTTL	Input	
IDCK	88	LVTTL	Input	Input Data Clock
DE	1	LVTTL	Input	Data enable
HSYNC	2	LVTTL	Input	Horizontal Sync input control signal
VSYNC	3	LVTTL	Input	Vertical Sync input control signal
SCK	11	LVTTL	Input	I2S Serial Clock
WS	10	LVTTL	Input	I2S Word Select
SD0	9	LVTTL	Input	I2S Serial Data
SD1	8	LVTTL	Input	I2S Serial Data
SD2	7	LVTTL	input	I2S Serial Data
SD3	6	LVTTL	Input	I2S Serial Data
DL0	17	LVTTL	Input	One-bit Audio Data Left 0
DR0	16	LVTTL	Input	One-bit Audio Data Right 0
DL1	19	LVTTL	Input	One-bit Audio Data Left 1
DR1	18	LVTTL	input	One-bit Audio Data Right 1
DL2	21	LVTTL	Input	One-bit Audio Data Left 2
DR2	20	LVTTL	input	One-bit Audio Data Right 2
DL3	23	LVTTL	Input	One-bit Audio Data Left 3
DR3	22	LVTTL	input	One-bit Audio Data Right 3
DCLK	15	LVTTL	Input	One-bit Audio Clock Input
MCLK	5	LVTTL	Input	Audio Input Master Clock
SPDIF	4	LVTTL	Input	S/PDIF Audio Input

R5F364VDNFB (8U-37AK55000 : IC853)

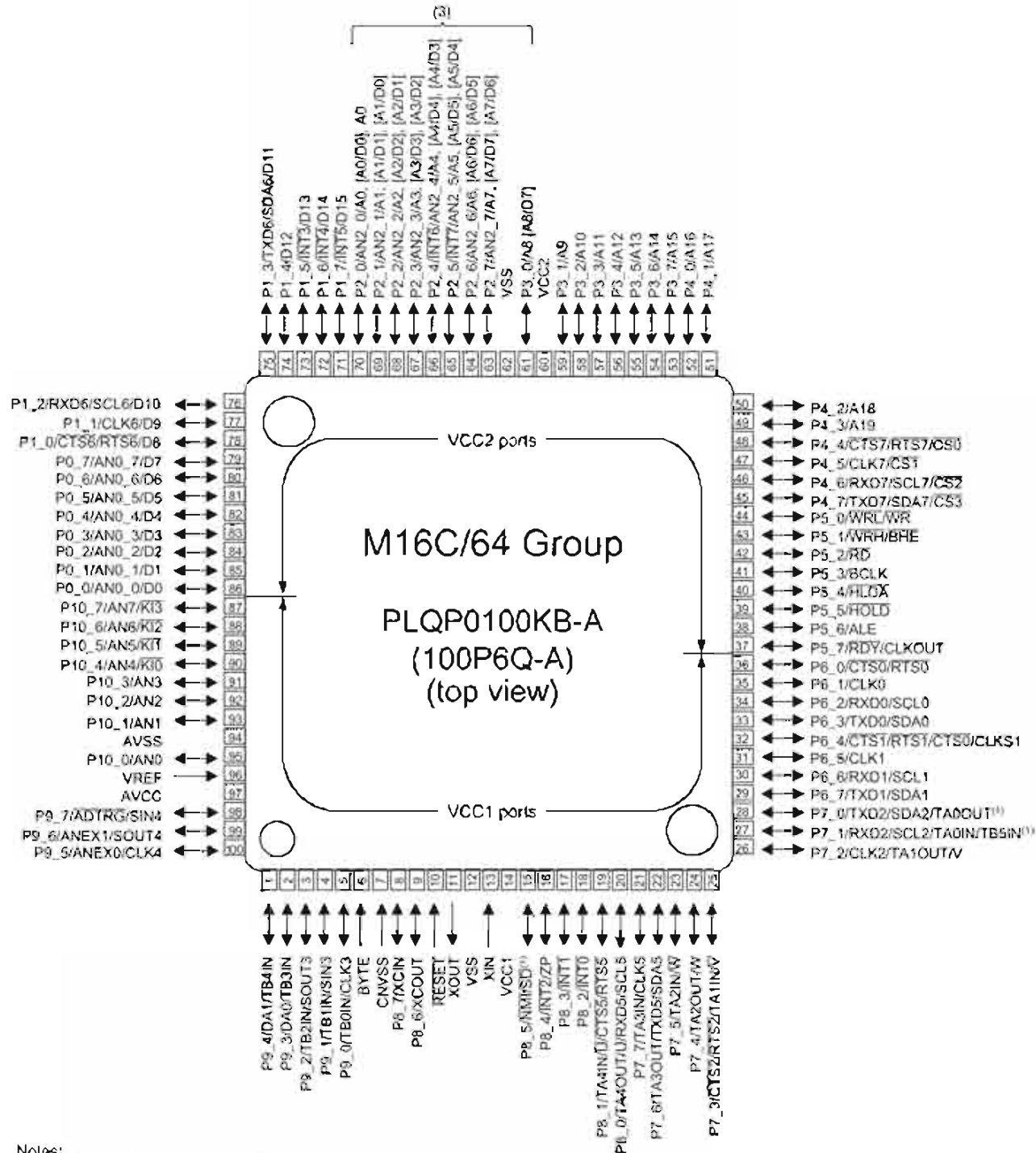

- Notes:
- 1 N-channel open-drain output.
 - 2 Check the position of Pin 1 by referring to appendix 1, Package Dimensions.
 - 3 Symbols in brackets [] represent a functional signal as a whole.

R5F364VDNFB Block Diagram

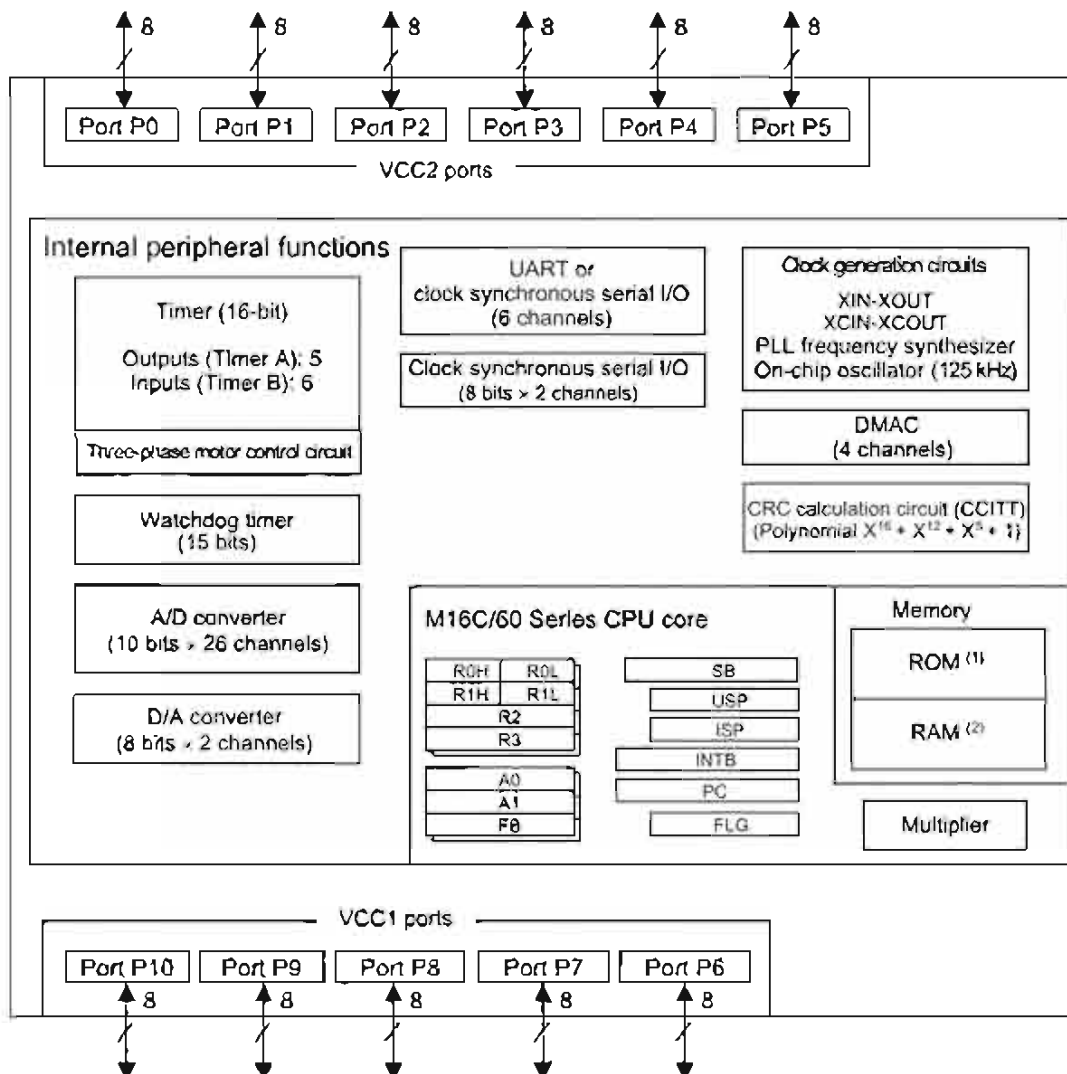

- Notes :
1. ROM size depends on MCU type.
 2. RAM size depends on MCU type

R5F364VDNFB Pin Function

Pin No.		Control Pin	Port	I/O Pin Functions for of Peripheral Modules				Bus Control Pin
FA	FB			Interrupt	Timer	Serial interface	A/D converter D/A converter	
1	99		P9_6			SOUT4	ANEX1	
2	100		P9_5			CLK4	ANEX0	
3	1		P9_4		TB4IN		DA1	
4	2		P9_3		TB3IN		DA0	
5	3		P9_2		TB2IN	SOUT3		
6	4		P9_1		TB1IN	SIN3		
7	5		P9_0		TB0IN	CLK3		
8	6	BYTE						
9	7	CNVSS						
10	8	XCIN	P8_7					
11	9	XCOUT	P8_6					
12	10	RESET						
13	11	XOUT						
14	12	VSS						
15	13	XIN						
16	14	VCC1						
17	15		P8_5	NMI	SD			
18	16		P8_4	INT2	ZP			
19	17		P8_3	INT1				
20	18		P8_2	INT0				
21	19		P8_1		TA4IN/U	CTS5/RTS5		
22	20		P8_0		TA4OUT/U	RXD5/SCL5		
23	21		P7_7		TA3IN	CLK5		
24	22		P7_6		TA3OUT	TXD5/SDA5		
25	23		P7_5		TA2IN/W			
26	24		P7_4		TA2OUT/W			
27	25		P7_3		TA1IN/V	CTS2/RTS2		
28	26		P7_2		TA1OUT/V	CLK2		
29	27		P7_1		TA0IN/TB5IN	RXD2/SCL2		
30	28		P7_0		TA0OUT	TXD2/SDA2		
31	29		P6_7			TXD1/SDA1		
32	30		P6_6			RXD1/SCL1		
33	31		P6_5			CLK1		
34	32		P6_4			CTS1/RTS1/CTS0/CLKS1		
35	33		P6_3			TXD0/SDA0		
36	34		P6_2			RXD0/SCL0		
37	35		P6_1			CLK0		
38	36		P6_0			CTS0/RTS0		
39	37		P5_7					RDY/CLKOUT
40	38		P5_6					ALE
41	39		P5_5					HOLD
42	40		P5_4					HLDA
43	41		P5_3					BCLK
44	42		P5_2					RD
45	43		P5_1					WRH/BHE
46	44		P5_0					WRL/WR
47	45		P4_7			TXD7/SDA7		CS3
48	46		P4_6			RXD7/SCL7		CS2
49	47		P4_5			CLK7		CS1
50	48		P4_4			CTS7/RTS7		CS0

Pin No.		Control Pin	Port	I/O Pin Functions for of Peripheral Modules				Bus Control Pin
FA	FB			Interrupt	Timer	Serial interface	A/D converter D/A converter	
51	49		P4_3					A19
52	50		P4_2					A18
53	51		P4_1					A17
54	52		P4_0					A16
55	53		P3_7					A15
56	54		P3_6					A14
57	55		P3_5					A13
58	56		P3_4					A12
59	57		P3_3					A11
60	58		P3_2					A10
61	59		P3_1					A9
62	60	VCC2						
63	61		P3_0					A8, [A8/D7]
64	62	VSS						
65	63		P2_7				AN2_7	A7, [A7/D7], [A7/D6]
66	64		P2_6				AN2_6	A6, [A6/D6], [A6/D5]
67	65		P2_5	$\overline{\text{INT7}}$			AN2_5	A5, [A5/D5], [A5/D4]
68	66		P2_4	$\overline{\text{INT6}}$			AN2_4	A4, [A4/D4], [A4/D3]
69	67		P2_3				AN2_3	A3, [A3/D3], [A3/D2]
70	68		P2_2				AN2_2	A2, [A2/D2], [A2/D1]
71	69		P2_1				AN2_1	A1, [A1/D1], [A1/D0]
72	70		P2_0				AN2_0	A0, [A0/D0], A0
73	71		P1_7	$\overline{\text{INT5}}$				D15
74	72		P1_6	$\overline{\text{INT4}}$				D14
75	73		P1_5	$\overline{\text{INT3}}$				D13
76	74		P1_4					D12
77	75		P1_3			TXD6/SDA6		D11
78	76		P1_2			RXD6/SCL6		D10
79	77		P1_1			CLK6		D9
80	78		P1_0			$\overline{\text{CTS6/RTS6}}$		D8
81	79		P0_7				AN0_7	D7
82	80		P0_6				AN0_6	D6
83	81		P0_5				AN0_5	D5
84	82		P0_4				AN0_4	D4
85	83		P0_3				AN0_3	D3
86	84		P0_2				AN0_2	D2
87	85		P0_1				AN0_1	D1
88	86		P0_0				AN0_0	D0
89	87		P10_7	$\overline{\text{KI3}}$			AN7	
90	88		P10_6	$\overline{\text{KI2}}$			AN6	
91	89		P10_5	$\overline{\text{KI1}}$			AN5	
92	90		P10_4	$\overline{\text{KI0}}$			AN4	
93	91		P10_3				AN3	
94	92		P10_2				AN2	
95	93		P10_1				AN1	
96	94	AVSS						
97	95		P10_0				AN0	
98	96	VREF						
99	97	AVCC						
100	98		P9_7			SIN4	$\overline{\text{ADTRG}}$	

K4D261638K-LC40 (8U-310002 : IC204-209,IC211,IC212)

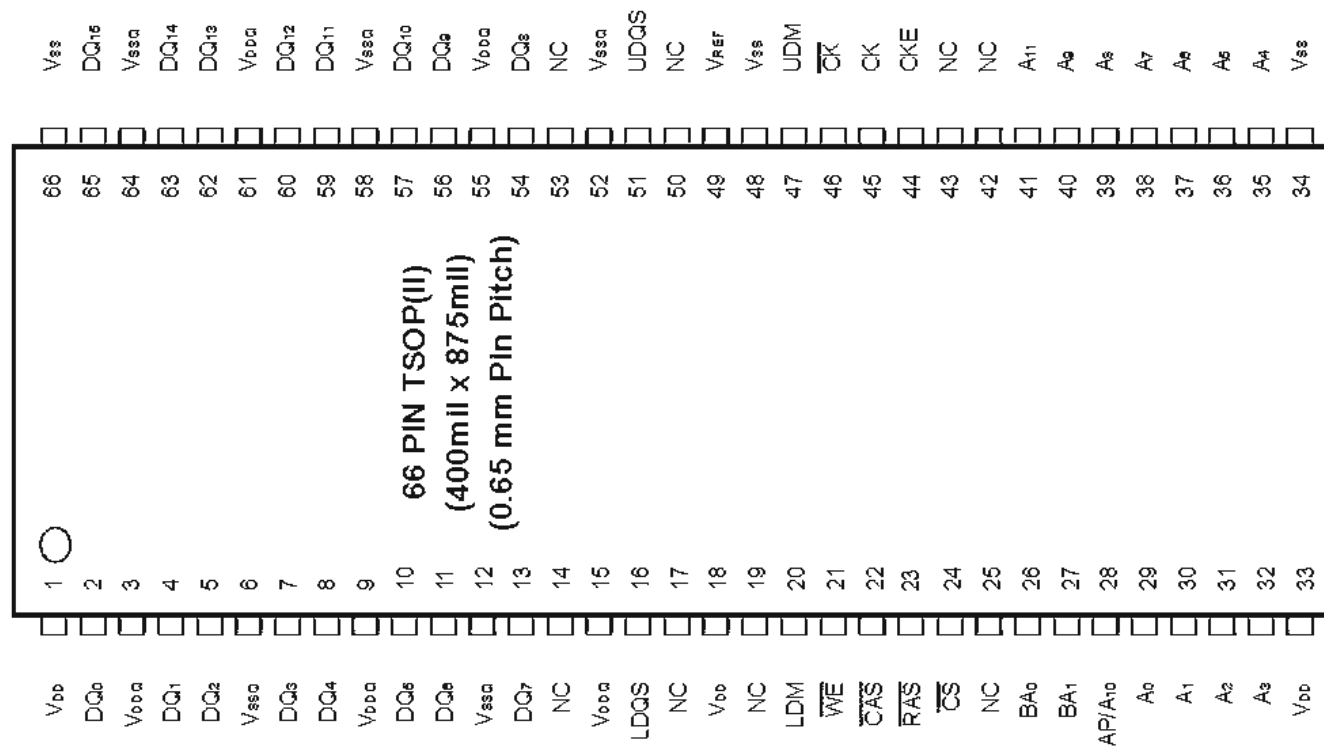

K4D261638K-LC40 Block Diagram

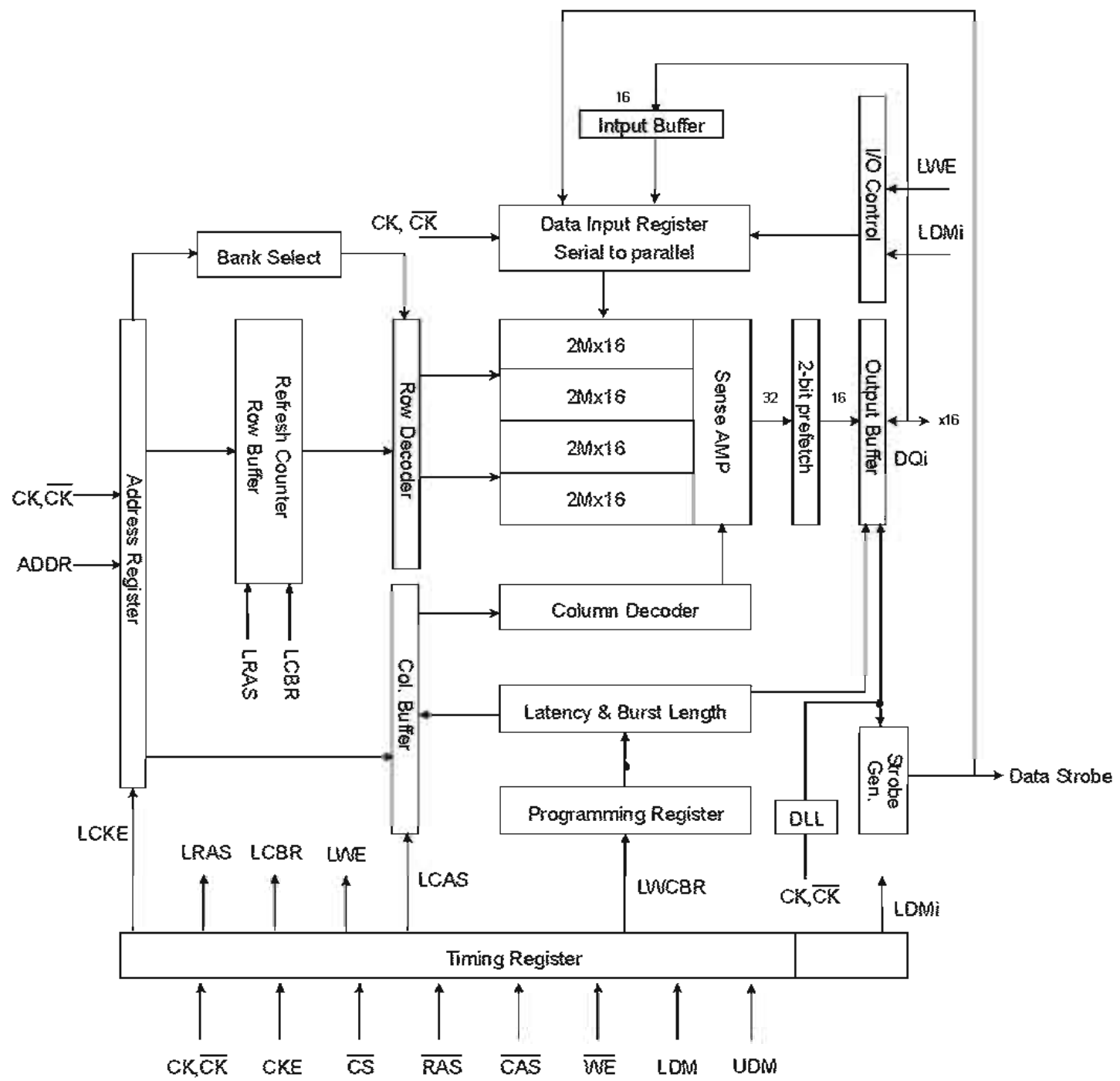

K4D261638K-LC40 Pin Function

Symbol	Type	Function
CK, \overline{CK}^*1	Input	The differential system clock Input. All of the inputs are sampled on the rising edge of the clock except DQ's and DM's that are sampled on both edges of the DQS.
CKE	Input	Activates the CK signal when high and deactivates the \overline{CK} signal when low. By deactivating the clock, CKE low indicates the Power down mode or Self refresh mode.
\overline{CS}	Input	\overline{CS} enables the command decoder when low and disabled the command decoder when high. When the command decoder is disabled, new commands are ignored but previous operations continue.
\overline{RAS}	Input	Latches row addresses on the positive going edge of the CK with \overline{RAS} low. Enables row access & precharge.
\overline{CAS}	Input	Latches column addresses on the positive going edge of the CK with \overline{CAS} low. Enables column access.
\overline{WE}	Input	Enables write operation and row precharge. Latches data in starting from \overline{CAS} , \overline{WE} active.
LDQS, UDQS	Input/Output	Data input and output are synchronized with both edge of DQS. For the x16, LDQS corresponds to the data on DQ0-DQ7 ; UDQS corresponds to the data on DQ8-DQ15.
LDM, UDM	Input	Data in Mask. Data In is masked by DM Latency=0 when DM is high in burst write. For the x16, LDM corresponds to the data on DQ0-DQ7 ; UDM corresponds to the data on DQ8-DQ15.
DQ0 ~ DQ15	Input/Output	Data inputs/Outputs are multiplexed on the same pins.
BA0, BA1	Input	Selects which bank is to be active.
A0 ~ A11	Input	Row/Column addresses are multiplexed on the same pins. Row addresses : RA0 ~ RA11, Column addresses : CA0 ~ CA8.
VDD/VSS	Power Supply	Power and ground for the input buffers and core logic.
VDDQ/VSSQ	Power Supply	Isolated power supply and ground for the output buffers to provide improved noise immunity.
VREF	Power Supply	Reference voltage for inputs, used for SSTL interface.
NC/RFU	No connection/ Reserved for future use	This pin is recommended to be left "No connection" on the device

*1 : The timing reference point for the differential clocking is the cross point of CK and \overline{CK} .
For any applications using the single ended clocking, apply VREF to \overline{CK} pin.

ADV7344BSTZ (8U-310002 : IC802)

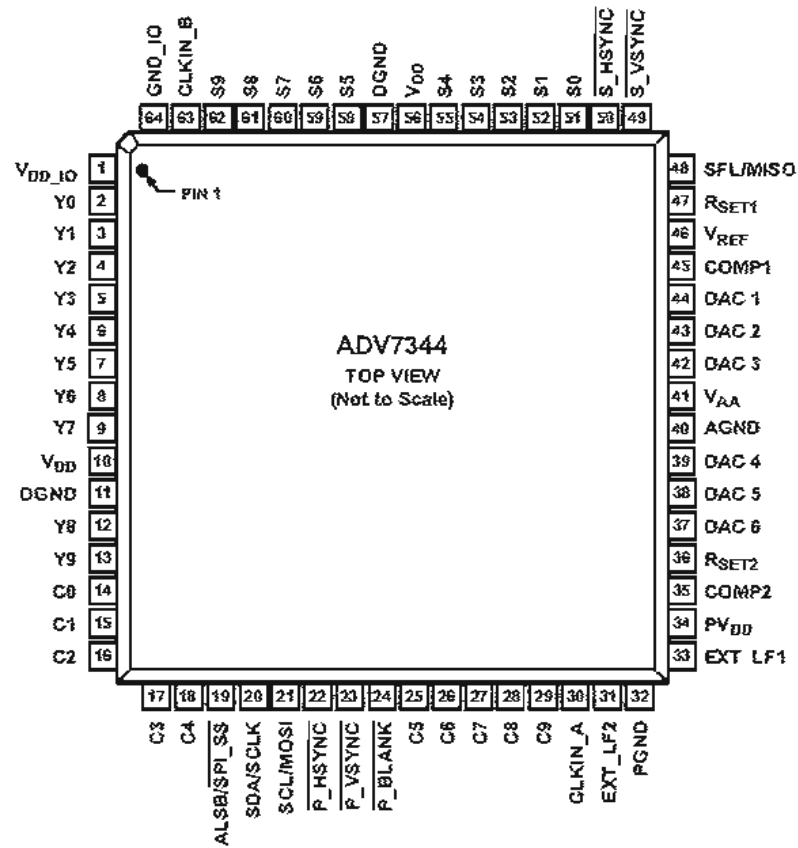

ADV7344BSTZ Block Diagram

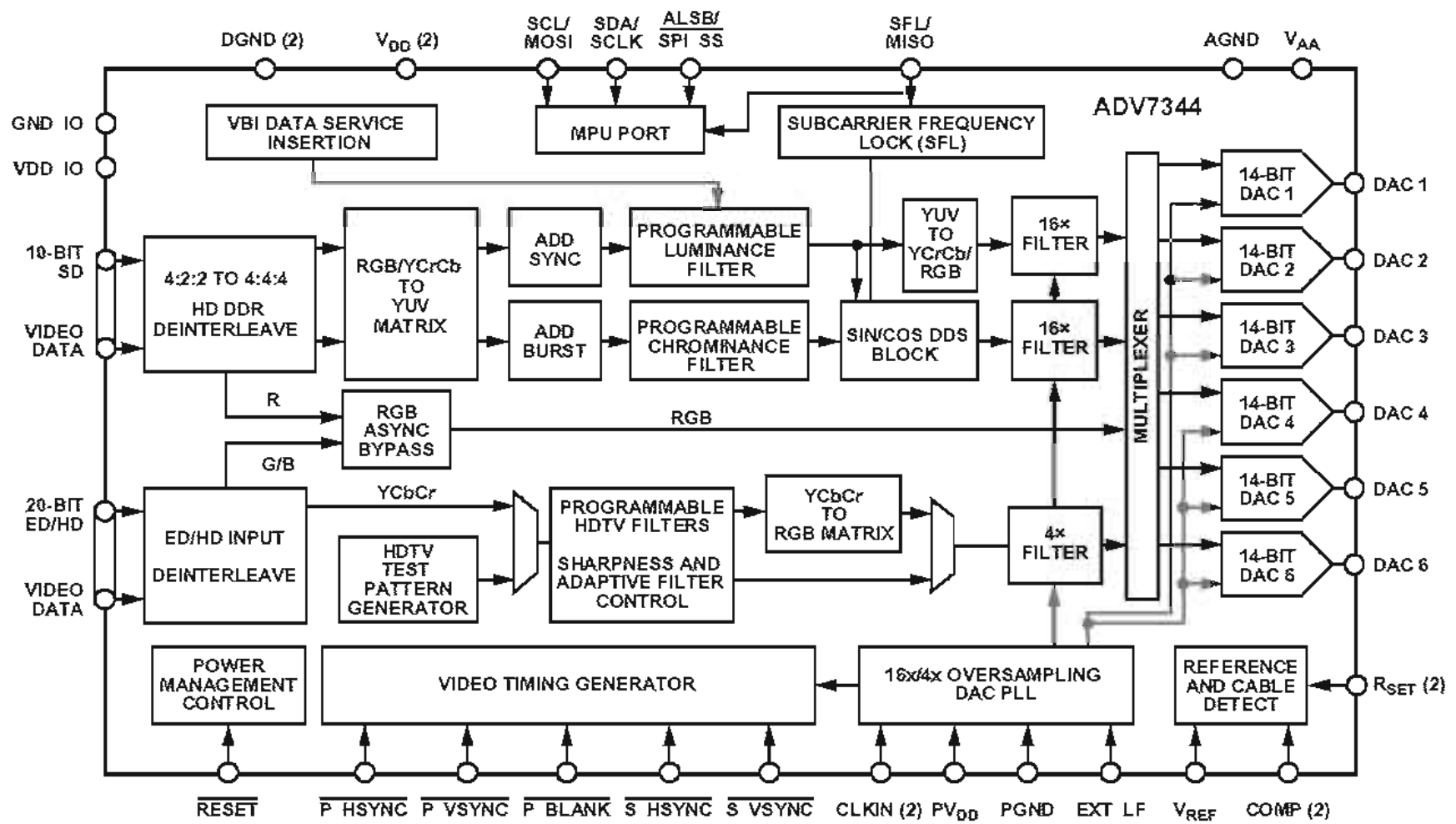

ADV7344BSTZ Pin Function

Pin No.	Mnemonic	Input/Output	Description
13, 12, 9 to 2	Y9 to Y0	I	10-Bit Pixel Port (Y9 to Y0). Y0 is the LSB. Refer to Table 31 for input modes.
29 to 25, 18 to 14	C9 to C0	I	10-Bit Pixel Port (C9 to C0). C0 is the LSB. Refer to Table 31 for input modes.
62 to 58, 55 to 51	S9 to S0	I	10-Bit Pixel Port (S9 to S0). S0 is the LSB. Refer to Table 31 for input modes.
30	CLKIN_A	I	Pixel Clock Input for HD only (74.25 MHz), ED ¹ only (27 MHz or 54 MHz) or SD only (27 MHz).
63	CLKIN_B	I	Pixel Clock Input for Dual Modes Only. Requires a 27 MHz reference clock for ED operation or a 74.25 MHz reference clock for HD operation.
50	S_HSYNC	I/O	SD Horizontal Synchronization Signal. This pin can also be configured to output an SD, ED, or HD horizontal synchronization signal. See the External Horizontal and Vertical Synchronization Control section.
49	S_VSYNC	I/O	SD Vertical Synchronization Signal. This pin can also be configured to output an SD, ED, or HD vertical synchronization signal. See the External Horizontal and Vertical Synchronization Control section.
22	P_HSYNC	I	ED/HD Horizontal Synchronization Signal. See the External Horizontal and Vertical Synchronization Control section.
23	P_VSYNC	I	ED/HD Vertical Synchronization Signal. See the External Horizontal and Vertical Synchronization Control section.
24	P_BLANK	I	ED/HD Blanking Signal. See the External Horizontal and Vertical Synchronization Control section.
48	SFL/MISO	I/O	Multifunctional Pin: Subcarrier Frequency Lock (SFL) Input/SPI Data Output. The SFL input is used to drive the color subcarrier DDS system, timing reset, or subcarrier reset.
47	RSET1	I	This pin is used to control the amplitudes of the DAC 1, DAC 2, and DAC 3 outputs. For full-drive operation (for example, into a 37.5 Ω load), a 510 Ω resistor must be connected from RSET1 to AGND. For low drive operation (for example, into a 300 Ω load), a 4.12 k Ω resistor must be connected from RSET1 to AGND.
36	RSET2	I	This pin is used to control the amplitudes of the DAC 4, DAC 5, and DAC 6 outputs. A 4.12 k Ω resistor must be connected from RSET2 to AGND.
45, 35	COMP1, COMP2	O	Compensation Pins. Connect a 2.2 nF capacitor from both COMP pins to V _{AA} .

Pin No.	Mnemonic	Input/Output	Description
44, 43, 42	DAC 1, DAC 2, DAC 3	O	DAC Outputs. Full and low drive capable DACs.
39, 38, 37	DAC 4, DAC 5, DAC 6	O	DAC Outputs. Low drive only capable DACs.
21	SCL/MOSI	I	Multifunctional Pin: I ² C Clock Input/SPI Data Input.
20	SDA/SCLK	I/O	Multifunctional Pin: I ² C Data Input/Output. Also, SPI clock input.
19	ALSBI/SPI_SS	I	Multifunctional Pin: This signal sets up the LSB ² of the MPU I ² C address. Also, SPI slave select.
46	V _{REF}		Optional External Voltage Reference Input for DACs or Voltage Reference Output.
41	V _{AA}	P	Analog Power Supply (3.3 V).
10, 56	V _{DD}	P	Digital Power Supply (1.8 V). For dual-supply configurations, V _{DD} can be connected to other 1.8 V supplies through a ferrite bead or suitable filtering.
1	V _{DD_IO}	P	Input/Output Digital Power Supply (3.3 V).
34	PV _{DD}	P	PLL Power Supply (1.8 V). For dual-supply configurations, PV _{DD} can be connected to other 1.8 V supplies through a ferrite bead or suitable filtering.
33	EXT_LF1	I	External Loop Filter for On-Chip PLL 1.
31	EXT_LF2	I	External Loop Filter for On-Chip PLL 2.
32	PGND	G	PLL Ground Pin.
40	AGND	G	Analog Ground Pin.
11, 57	DGND	G	Digital Ground Pin.
64	GND_IO	G	Input/Output Supply Ground Pin.

¹ ED = enhanced definition = 525p and 625p.

² LSB = least significant bit. In the ADV7344, setting the LSB to 0 sets the I²C address to 0xD4. Setting it to 1 sets the I²C address to 0xD6.

ADV7340BSTZ (8U-310002 : IC808)

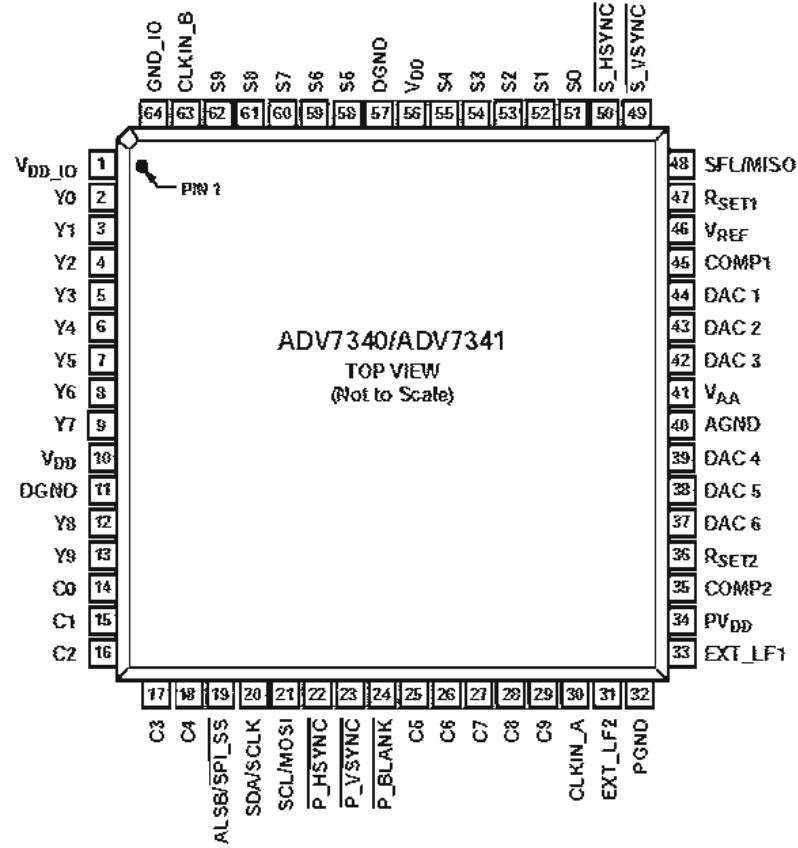

ADV7340BSTZ Block Diagram

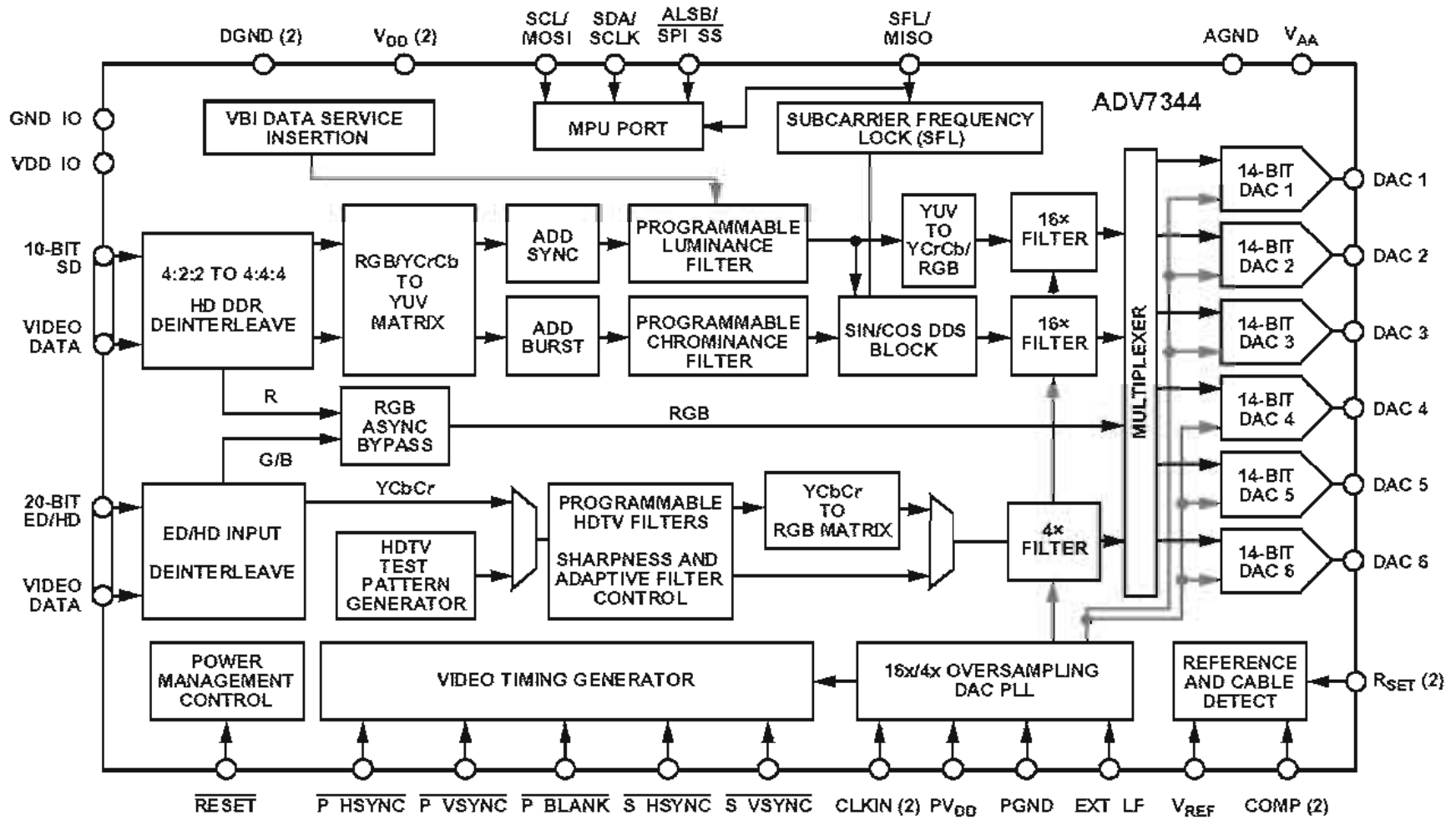

ADV7340BSTZ Pin Function

Pin No.	Mnemonic	Input/Output	Description
13, 12, 9 to 2	Y9 to Y0	I	10-Bit Pixel Port (Y9 to Y0). Y0 is the LSB. Refer to Table 31 for input modes.
29 to 25, 18 to 14	C9 to C0	I	10-Bit Pixel Port (C9 to C0). C0 is the LSB. Refer to Table 31 for input modes.
62 to 58, 55 to 51	S9 to S0	I	10-Bit Pixel Port (S9 to S0). S0 is the LSB. Refer to Table 31 for input modes.
30	CLKIN_A	I	Pixel Clock Input for HD Only (74.25 MHz), ED ¹ Only (27 MHz or 54 MHz), or SD Only (27 MHz).
63	CLKIN_B	I	Pixel Clock Input for Dual Modes Only. Requires a 27 MHz reference clock for ED operation or a 74.25 MHz reference clock for HD operation.
50	$\overline{S_HSYNC}$	I/O	SD Horizontal Synchronization Signal. This pin can also be configured to output an SD, ED, or HD horizontal synchronization signal. See the External Horizontal and Vertical Synchronization Control section.
49	$\overline{S_VSYNC}$	I/O	SD Vertical Synchronization Signal. This pin can also be configured to output an SD, ED, or HD vertical synchronization signal. See the External Horizontal and Vertical Synchronization Control section.
22	$\overline{P_HSYNC}$	I	ED/HD Horizontal Synchronization Signal. See the External Horizontal and Vertical Synchronization Control section.
23	$\overline{P_VSYNC}$	I	ED/HD Vertical Synchronization Signal. See the External Horizontal and Vertical Synchronization Control section.
24	$\overline{P_BLANK}$	I	ED/HD Blanking Signal. See the External Horizontal and Vertical Synchronization Control section.
48	SFL/MISO	I/O	Multifunctional Pin: Subcarrier Frequency Lock (SFL) Input/SPI Data Output. The SFL input is used to drive the color subcarrier DDS system, timing reset, or subcarrier reset.
47	R _{SET1}	I	This pin is used to control the amplitudes of the DAC 1, DAC 2, and DAC 3 outputs. For full-drive operation (for example, into a 37.5 Ω load), a 510 Ω resistor must be connected from R _{SET1} to AGND. For low drive operation (for example, into a 300 Ω load), a 4.12 k Ω resistor must be connected from R _{SET1} to AGND.
36	R _{SET2}	I	This pin is used to control the amplitudes of the DAC 4, DAC 5, and DAC 6 outputs. A 4.12 k Ω resistor must be connected from R _{SET2} to AGND.

Pin No.	Mnemonic	Input/Output	Description
44, 43, 42	DAC 1, DAC 2, DAC 3	O	DAC Outputs. Full and low drive capable DACs.
39, 38, 37	DAC 4, DAC 5, DAC 6	O	DAC Outputs. Low drive only capable DACs.
21	SCL/MOSI	I	Multifunctional Pin: PC Clock Input/SPI Data Input.
20	SDA/SCLK	I/O	Multifunctional Pin: PC Data Input/Output. Also, SPI clock input.
19	$\overline{ALS\overline{B}/S\overline{PI_SS}}$	I	Multifunctional Pin: This signal sets up the LSB ² of the MPU PC address. Also, SPI slave select.
46	V _{REF}		Optional External Voltage Reference Input for DACs or Voltage Reference Output.
41	V _{AA}	P	Analog Power Supply (3.3 V).
10, 56	V _{DD}	P	Digital Power Supply (1.8 V). For dual-supply configurations, V _{DD} can be connected to other 1.8 V supplies through a ferrite bead or suitable filtering.
1	V _{DD_IO}	P	Input/Output Digital Power Supply (3.3 V).
34	PV _{DD}	P	PLL Power Supply (1.8 V). For dual-supply configurations, PV _{DD} can be connected to other 1.8 V supplies through a ferrite bead or suitable filtering.
33	EXT_LF1	I	External Loop Filter for On-Chip PLL 1.
31	EXT_LF2	I	External Loop Filter for On-Chip PLL 2.
32	PGND	G	PLL Ground Pin.
40	AGND	G	Analog Ground Pin.
11, 57	DGND	G	Digital Ground Pin.
64	GND_IO	G	Input/Output Supply Ground Pin.

¹ ED = enhanced definition = 525p and 625p.

² LSB = least significant bit. In the ADV7344, setting the LSB to 0 sets the PC address to 0xD4. Setting it to 1 sets the PC address to 0xD6.

PT6302-R-001(L) (8U-37AK53000 : IC401)

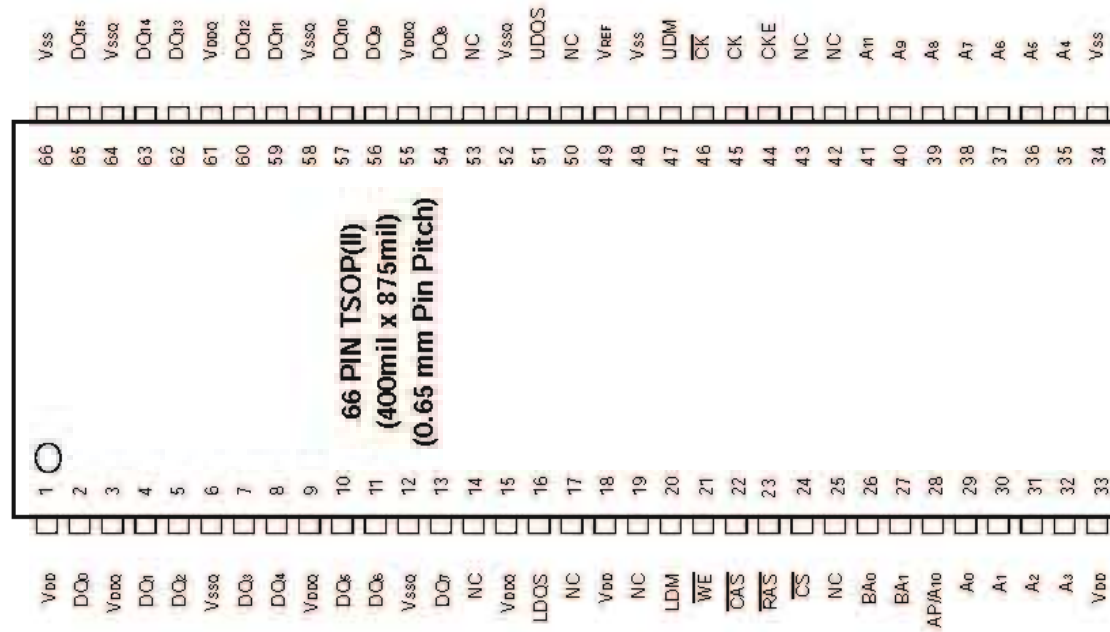

PT6302-R-001(L) Block Diagram

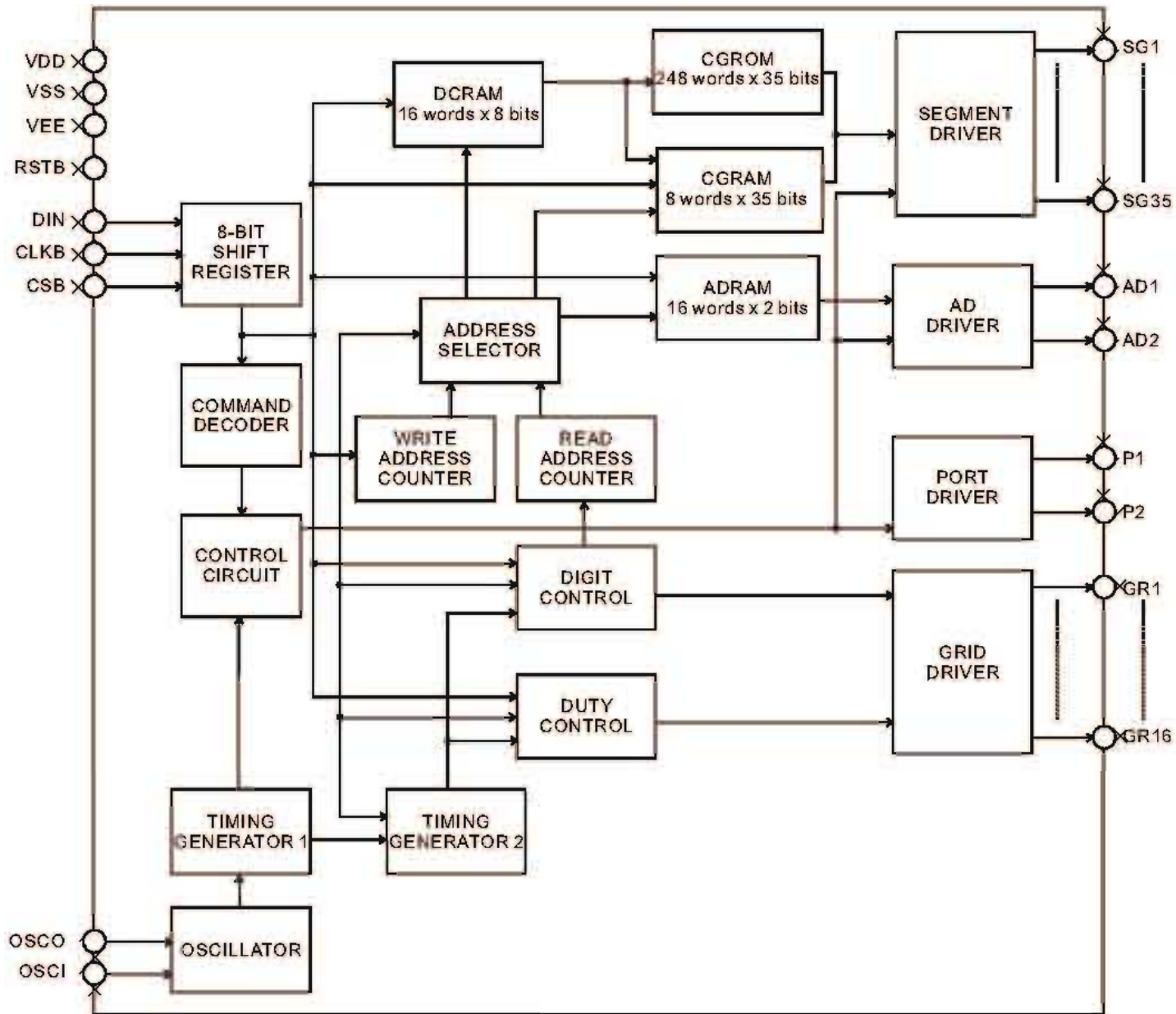

PT6302-R-001(L) Pin Function

Pin Name	I/O	Description	Pin No.	
			LQFP	SSOP
SG5 to SG35 SG4 to SG1	O	Segment driver output pin	1 ~ 31 64 ~ 61	9 ~ 39 8 ~ 5
GR1 to GR16	O	Grid driver output pin	32 ~ 47	40 ~ 55
VEE	-	Power supply	48	56
VSS	-	Ground pin	49	57
OSCI	I	Oscillator input pin	50	58
OSCO	O	Oscillator output pin	51	59
RSTB	I	Reset input pin When this pin is set to "LOW", all functions are initialized.	52	60
CSB	I	Chip select input pin When this pin is set to "High" Level, the serial data transfer is disabled.	53	61
CLKB	I	Shift clock input pin The serial data is shifted at the rising edge of CLKB.	54	62
DIN	I	Serial data input pin	55	63
VDD	-	Positive power supply	56	64
P1 to P2	O	General purpose output pin	57 ~ 58	1 ~ 2
AD2 to AD1	O	Segment driver output pin	59 ~ 60	3 ~ 4

S29GL064N90TFI040# (8U-310002 : IC213)

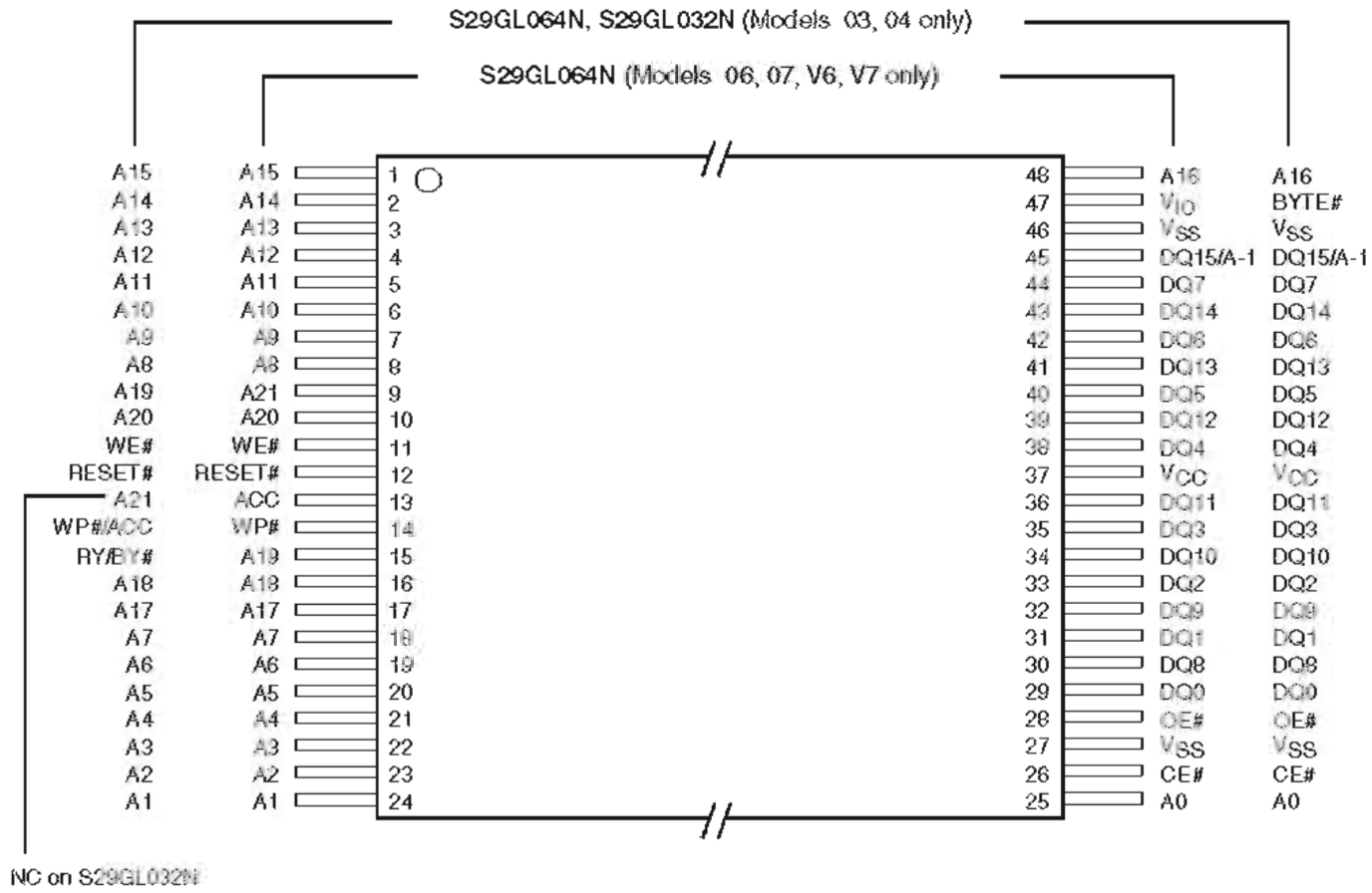

S29GL064N90TFI040# Block Diagram

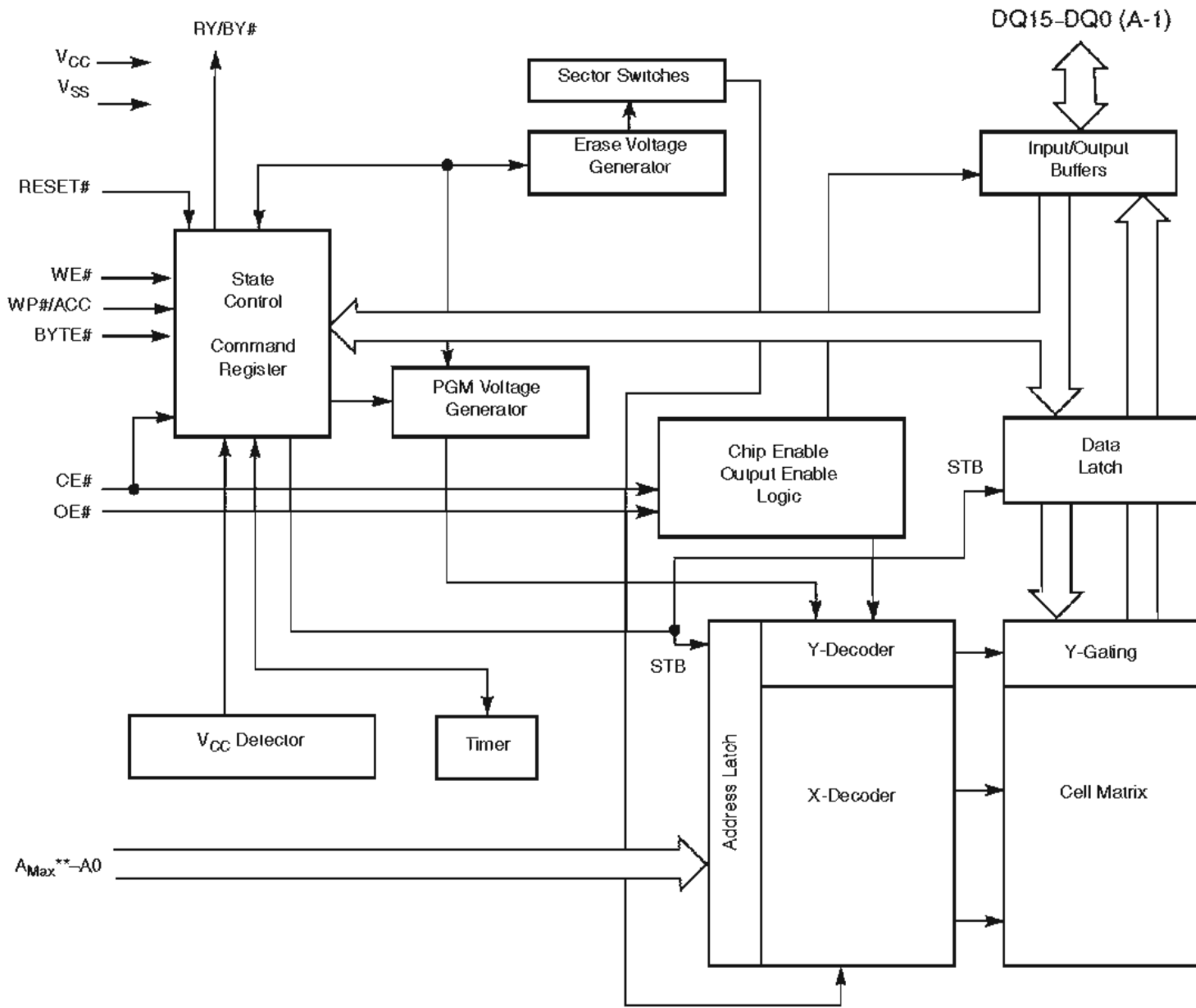

Note
 **A_{MAX} GL064N = A21, GL032N = A20.

S29GL064N90TFI040# Pin Function

Pin	Description
A21-A0	22 Address inputs (S29GL064N)
A20-A0	21 Address inputs (S29GL032N)
DQ7-DQ0	8 Data inputs/outputs
DQ14-DQ0	15 Data inputs/outputs
DQ15/A-1	DQ15 (Data input/output, word mode), A-1 (LSB Address input, byte mode)
CE#	Chip Enable input
OE#	Output Enable input
WE#	Write Enable input
WP#/ACC	Hardware Write Protect input/Programming Acceleration input
ACC	Acceleration input
WP#	Hardware Write Protect input
RESET#	Hardware Reset Pin input
RY/BY#	Ready/Busy output
BYTE#	Selects 8-bit or 16-bit mode
V _{CC}	3.0 volt-only single power supply (see Product Selector Guide for speed options and voltage supply tolerances)
V _{IO}	Output Buffer Power
V _{SS}	Device Ground
NC	Pin Not Connected Internally

AK4399EQ (8U-210016 : IC101)

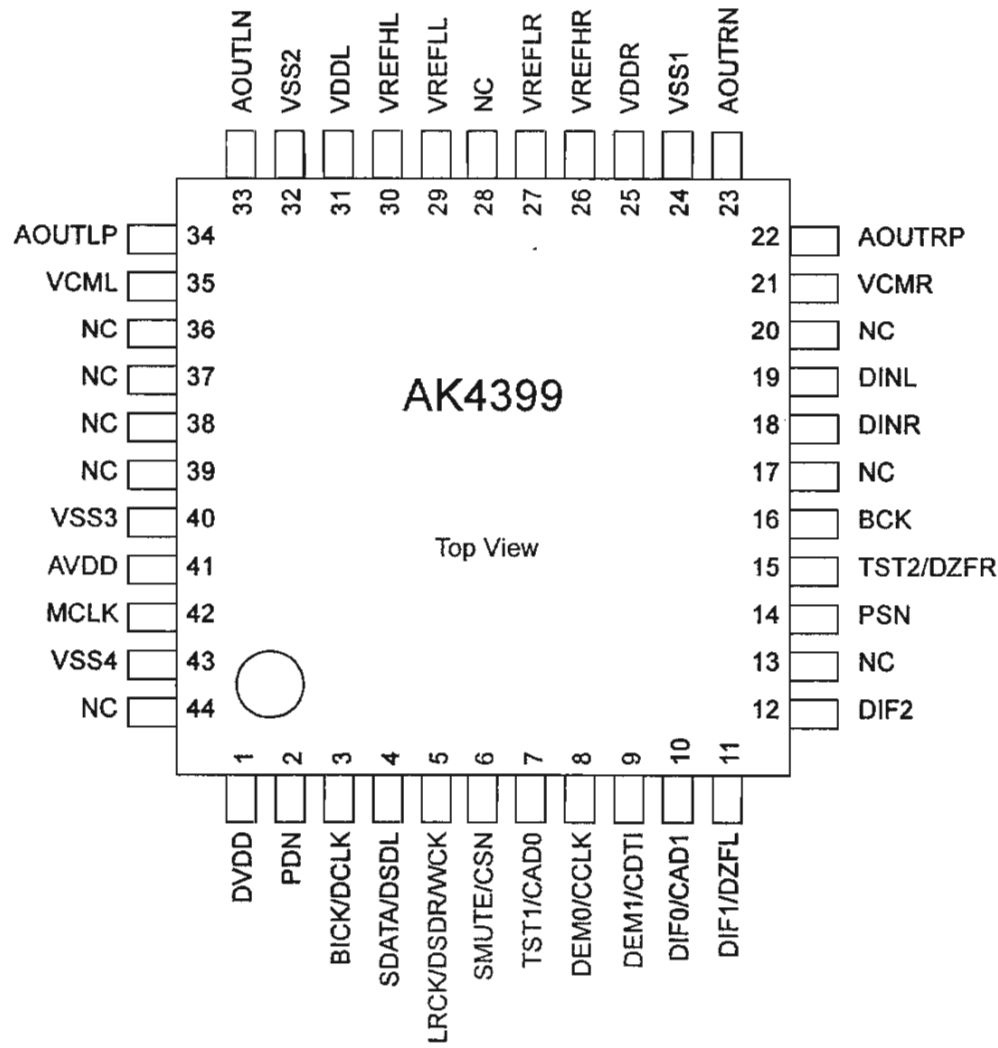

AK4399EQ Block Diagram

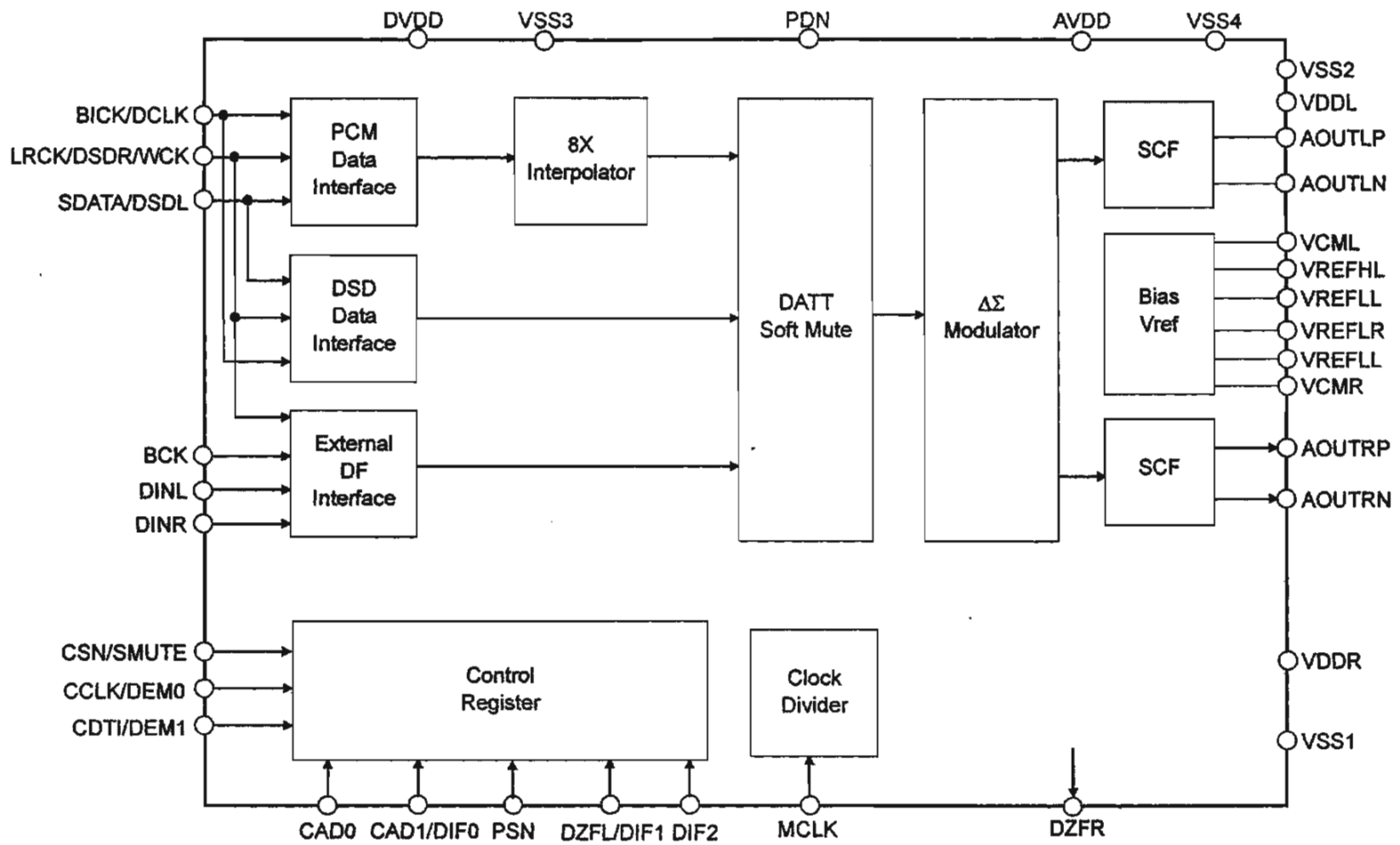

AK4399EQ Pin Function

No.	Pin Name	I/O	Function
1	DVDD	-	Digital Power Supply Pin, 4.75 ~ 5.25V
2	PDN	I	Power-Down Mode Pin When at "L", the AK4399 is in power-down mode and is held in reset. The AK4399 should always be reset upon power-up.
3	BICK	I	Audio Serial Data Clock Pin in PCM Mode
	DCLK	I	DSD Clock Pin in DSD Mode
4	SDATA	I	Audio Serial Data Input Pin in PCM Mode
	DSDL	I	DSD Lch Data Input Pin in DSD Mode
5	LRCK	I	L/R Clock Pin in PCM Mode
	DSDR	I	DSD Rch Data Input Pin in DSD Mode
	WCK	I	Word Clock input pin
6	SMUTE	I	Soft Mute Pin in Parallel Control Mode When this pin is changed to "H", soft mute cycle is initiated. When returning "L", the output mute releases.
	CSN	I	Chip Select Pin in Serial Control Mode
7	TST1	I	Test Pin in Parallel Control Mode (Internal pull-down pin)
	CAD0	I	Chip Address 0 Pin in Serial Control Mode (Internal pull-down pin)
8	DEM0	I	De-emphasis Enable 0 Pin in Parallel Control Mode
	CCLK	I	Control Data Clock Pin in Serial Control Mode
9	DEM1	I	De-emphasis Enable 1 Pin in Parallel Control Mode
	CDTI	I	Control Data Input Pin in Serial Control Mode
10	DIF0	I	Digital Input Format 0 Pin in PCM Mode
	CAD1	I	Chip Address 1 Pin in Serial Control Mode
11	DIF1	I	Digital Input Format 1 Pin in PCM Mode
	DZFL	O	Lch Zero Input Detect Pin in Serial Control Mode
12	DIF2	I	Digital Input Format 2 Pin in PCM Mode
13	NC	-	No internal bonding. Connect to GND.

Note: All input pins except internal pull-up/down pins should not be left floating.

14	PSN	I	Parallel or Serial Select Pin "L": Serial Control Mode, "H": Parallel Control Mode (Internal pull-up pin)
15	TST2	I	Test pin in Parallel Control Mode. Connect to GND.
	DZFR	O	Rch Zero Input Detect Pin in Serial Control Mode
16	BCK	I	Audio Serial Data Clock Pin (Internal pull-down pin)
17	NC	-	No internal bonding. Connect to GND.
18	DINR	I	Rch Audio Serial Data Input Pin (Internal pull-down pin)
19	DINL	I	Lch Audio Serial Data Input Pin (Internal pull-down pin)
20	NC	-	No internal bonding. Connect to GND.
21	VCMR	-	Right channel Common Voltage Pin, Normally connected to VSS with a TBD electrolytic cap.
22	AOUTRP	O	Rch Positive Analog Output Pin
23	AOUTRN	O	Rch Negative Analog Output Pin
24	VSS1	-	Ground Pin
25	VDDR	-	Rch Analog Power Supply Pin, 4.75 ~ 5.25V
26	VREFHR	I	Rch High Level Voltage Reference Input Pin
27	VREFLR	I	Rch Low Level Voltage Reference Input Pin
28	NC	-	No internal bonding. Connect to GND.
29	VREFLL	I	Lch Low Level Voltage Reference Input Pin
30	VREFHL	I	Lch High Level Voltage Reference Input Pin
31	VDDL	-	Lch Analog Power Supply Pin, 4.75 ~ 5.25V
32	VSS2	-	Ground Pin
33	AOUTLN	O	Lch Negative Analog Output Pin
34	AOUTLP	O	Lch Positive Analog Output Pin
35	VCML	-	Left channel Common Voltage Pin, Normally connected to VSS with a TBD electrolytic cap.
36	NC	-	No internal bonding. Connect to GND.
37	NC	-	No internal bonding. Connect to GND.
38	NC	-	No internal bonding. Connect to GND.
39	NC	-	No internal bonding. Connect to GND.
40	VSS3	-	Ground Pin
41	AVDD	-	Analog Power Supply Pin, 4.75 ~ 5.25V
42	MCLK	I	Master Clock Input Pin
43	VSS4	-	Ground Pin
44	NC	-	No internal bonding. Connect to GND.

Note: All input pins except internal pull-up/down pins should not be left floating.

PCA9539PW,188 (8U-310002 : IC102)

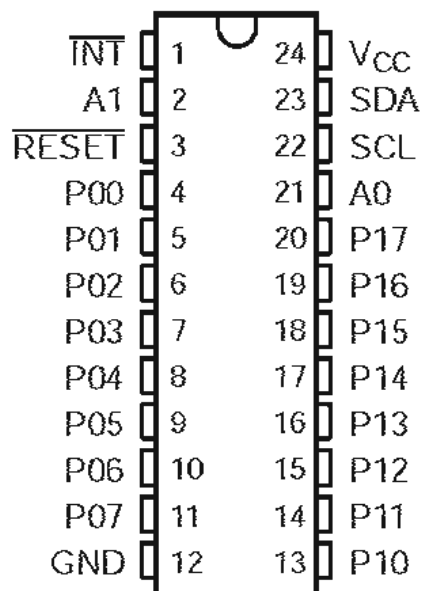

PCA9539PW,188 Pin Function

NO.		NAME	DESCRIPTION
SOIC (DWW), SSOP (DB), QSOP (DBQ), TSSOP (PW), AND TVSOP (DGV)	QFN (RGE)		
1	22	INT	Interrupt output. Connect to V _{CC} through a pullup resistor.
2	23	A1	Address input. Connect directly to V _{CC} or ground.
3	24	RESET	Active-low reset input. Connect to V _{CC} through a pullup resistor if no active connection is used.
4	1	P00	P-port input/output. Push-pull design structure.
5	2	P01	P-port input/output. Push-pull design structure.
6	3	P02	P-port input/output. Push-pull design structure.
7	4	P03	P-port input/output. Push-pull design structure.
8	5	P04	P-port input/output. Push-pull design structure.
9	6	P05	P-port input/output. Push-pull design structure.
10	7	P06	P-port input/output. Push-pull design structure.
11	8	P07	P-port input/output. Push-pull design structure.
12	9	GND	Ground
13	10	P10	P-port input/output. Push-pull design structure.
14	11	P11	P-port input/output. Push-pull design structure.
15	12	P12	P-port input/output. Push-pull design structure.
16	13	P13	P-port input/output. Push-pull design structure.
17	14	P14	P-port input/output. Push-pull design structure.
18	15	P15	P-port input/output. Push-pull design structure.
19	16	P16	P-port input/output. Push-pull design structure.
20	17	P17	P-port input/output. Push-pull design structure.
21	18	A0	Address input. Connect directly to V _{CC} or ground.
22	19	SCL	Serial clock bus. Connect to V _{CC} through a pullup resistor.
23	20	SDA	Serial data bus. Connect to V _{CC} through a pullup resistor.
24	21	V _{CC}	Supply voltage

HIN202EIBNZ-T (8U-37AK53000 : IC403)

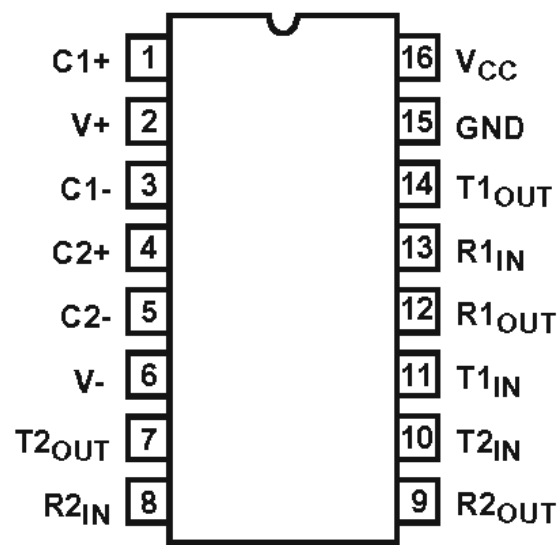

HIN202EIBNZ-T Pin Function

PIN	FUNCTION
V _{CC}	Power Supply Input 5V ±10%, (5V ±5% HIN207E).
V+	Internally generated positive supply (+10V nominal).
V-	Internally generated negative supply (-10V nominal).
GND	Ground Lead. Connect to 0V.
C1+	External capacitor (+ terminal) is connected to this lead.
C1-	External capacitor (- terminal) is connected to this lead.
C2+	External capacitor (+ terminal) is connected to this lead.
C2-	External capacitor (- terminal) is connected to this lead.
T _{IN}	Transmitter Inputs. These leads accept TTL/CMOS levels. An internal 400k pull-up resistor to V _{CC} is connected to each lead.
T _{OUT}	Transmitter Outputs. These are RS-232 levels (nominally ±10V).
R _{IN}	Receiver Inputs. These inputs accept RS-232 input levels. An internal 5k pull-down resistor to GND is connected to each input.
R _{OUT}	Receiver Outputs. These are TTL/CMOS levels.
\overline{EN} , EN	Receiver Enable Input. With \overline{EN} = 5V (HIN213E EN=0V), the receiver outputs are placed in a high impedance state.
SD, \overline{SD}	Shutdown Input. With SD = 5V (HIN213E \overline{SD} = 0V), the charge pump is disabled, the receiver outputs are in a high impedance state (except R4 and R5 of HIN213E) and the transmitters are shut off.
NC	No Connect. No connections are made to these leads.

2. FL DISPLAY

FL TUBE (15-BT-114GNK) (8U-37AK53000 : FL401)

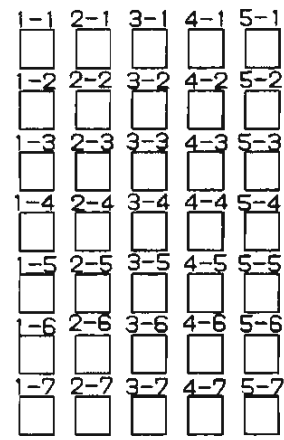
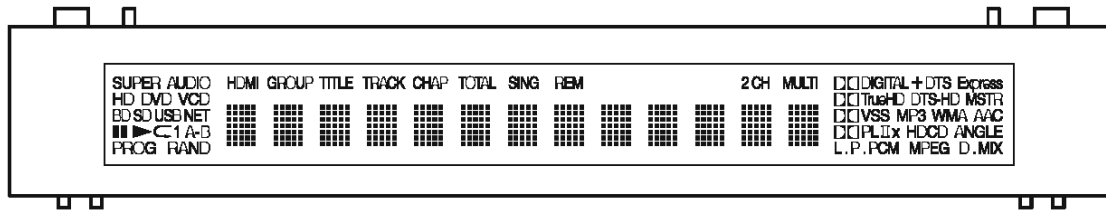

(2G~14G)

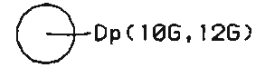

GRID ASSIGNMENT

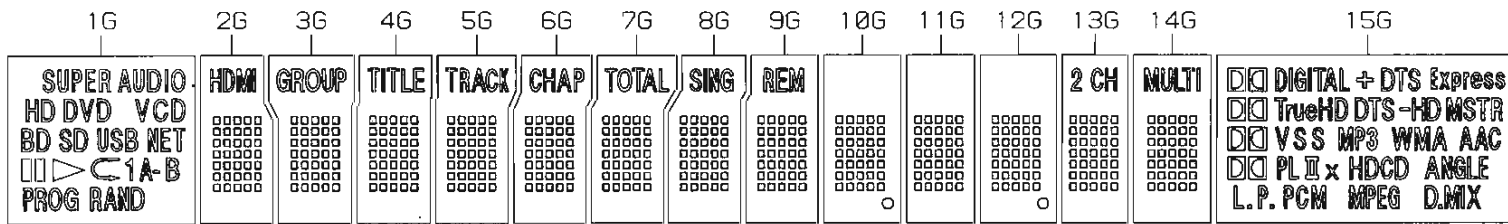

PIN CONNECTION

PIN NO.	54	44	44	44	44	44	44	33	33	33	33	33	33	22	22	22	22	22	22	11	11	11	11	11	11	11	11	11	11	11	11	11	11	11	11	11	11	11			
CONNECTION	P	P	P	P	P	P	P	P	P	P	P	P	P	P	P	P	P	P	P	P	N	N	N	N	N	N	N	N	N	N	N	N	N	N	N	N	N	N	F		
	67	65	64	63	62	61	60	59	58	57	56	55	54	53	52	51	40	39	38	37	36	35	34	33	32	31	20	19	18	17	16	15	14	13	12	11	10	9	8	7	6

PIN NO.	66	65	55	55	55	55	55	55	55	55	55	55	55	55	55	55	55	55	55	55	55	55	55	55	55	55	55	55	55	55	55	55	55	55	55	55	55	55	55	55	55	55	55	55	55		
CONNECTION	F	N	N	N	2	2	3	3	3	3	3	3	3	3	3	3	3	3	3	3	3	3	3	3	3	3	3	3	3	3	3	3	3	3	3	3	3	3	3	3	3	3	3	3	3	3	3

NOTE 1) F-,F+ --- Filament
 2) NP ----- No pin
 3) DL ----- Datum Line
 4) 1G~15G --- Grid
 5) Solder composition is Sn-3Ag-0.5Cu

6) NC ----- No connection
 (NC pin should be electrically open on the PC board)
 7) NX ----- No extend pin

ANODE CONNECTION

	1G	2G	3G	4G	5G	6G	7G	8G	9G	10G	11G	12G	13G	14G	15G
P1	SUPER	1-1	1-1	1-1	1-1	1-1	1-1	1-1	1-1	1-1	1-1	1-1	1-1	1-1	DIGITAL
P2	AUDIO	2-1	2-1	2-1	2-1	2-1	2-1	2-1	2-1	2-1	2-1	2-1	2-1	2-1	+
P3	HD	3-1	3-1	3-1	3-1	3-1	3-1	3-1	3-1	3-1	3-1	3-1	3-1	3-1	,,DTS
P4	DVD	4-1	4-1	4-1	4-1	4-1	4-1	4-1	4-1	4-1	4-1	4-1	4-1	4-1	Express
P5	V	5-1	5-1	5-1	5-1	5-1	5-1	5-1	5-1	5-1	5-1	5-1	5-1	5-1	TrueHD
P6	CD	1-2	1-2	1-2	1-2	1-2	1-2	1-2	1-2	1-2	1-2	1-2	1-2	1-2	DTS
P7	BD	2-2	2-2	2-2	2-2	2-2	2-2	2-2	2-2	2-2	2-2	2-2	2-2	2-2	-HD
P8	SD	3-2	3-2	3-2	3-2	3-2	3-2	3-2	3-2	3-2	3-2	3-2	3-2	3-2	MSTR
P9	USB	4-2	4-2	4-2	4-2	4-2	4-2	4-2	4-2	4-2	4-2	4-2	4-2	4-2	DIG
P10	NET	5-2	5-2	5-2	5-2	5-2	5-2	5-2	5-2	5-2	5-2	5-2	5-2	5-2	Vs
P11	11	1-3	1-3	1-3	1-3	1-3	1-3	1-3	1-3	1-3	1-3	1-3	1-3	1-3	,\$
P12	▷	2-3	2-3	2-3	2-3	2-3	2-3	2-3	2-3	2-3	2-3	2-3	2-3	2-3	MP3
P13	C	3-3	3-3	3-3	3-3	3-3	3-3	3-3	3-3	3-3	3-3	3-3	3-3	3-3	WMA
P14	1	4-3	4-3	4-3	4-3	4-3	4-3	4-3	4-3	4-3	4-3	4-3	4-3	4-3	AAC
P15	A-	5-3	5-3	5-3	5-3	5-3	5-3	5-3	5-3	5-3	5-3	5-3	5-3	5-3	DIG
P16	B	1-4	1-4	1-4	1-4	1-4	1-4	1-4	1-4	1-4	1-4	1-4	1-4	1-4	PL
P17	PROG	2-4	2-4	2-4	2-4	2-4	2-4	2-4	2-4	2-4	2-4	2-4	2-4	2-4	II
P18	RAND	3-4	3-4	3-4	3-4	3-4	3-4	3-4	3-4	3-4	3-4	3-4	3-4	3-4	X
P19	-	4-4	4-4	4-4	4-4	4-4	4-4	4-4	4-4	4-4	4-4	4-4	4-4	4-4	HDCD
P20	-	5-4	5-4	5-4	5-4	5-4	5-4	5-4	5-4	5-4	5-4	5-4	5-4	5-4	ANGLE
P21	-	1-5	1-5	1-5	1-5	1-5	1-5	1-5	1-5	1-5	1-5	1-5	1-5	1-5	L.
P22	-	2-5	2-5	2-5	2-5	2-5	2-5	2-5	2-5	2-5	2-5	2-5	2-5	2-5	P.
P23	-	3-5	3-5	3-5	3-5	3-5	3-5	3-5	3-5	3-5	3-5	3-5	3-5	3-5	PCM
P24	-	4-5	4-5	4-5	4-5	4-5	4-5	4-5	4-5	4-5	4-5	4-5	4-5	4-5	MPEG
P25	-	5-5	5-5	5-5	5-5	5-5	5-5	5-5	5-5	5-5	5-5	5-5	5-5	5-5	DMIX
P26	-	1-6	1-6	1-6	1-6	1-6	1-6	1-6	1-6	1-6	1-6	1-6	1-6	1-6	-
P27	-	2-6	2-6	2-6	2-6	2-6	2-6	2-6	2-6	2-6	2-6	2-6	2-6	2-6	-
P28	-	3-6	3-6	3-6	3-6	3-6	3-6	3-6	3-6	3-6	3-6	3-6	3-6	3-6	-
P29	-	4-6	4-6	4-6	4-6	4-6	4-6	4-6	4-6	4-6	4-6	4-6	4-6	4-6	-
P30	-	5-6	5-6	5-6	5-6	5-6	5-6	5-6	5-6	5-6	5-6	5-6	5-6	5-6	-
P31	-	1-7	1-7	1-7	1-7	1-7	1-7	1-7	1-7	1-7	1-7	1-7	1-7	1-7	-
P32	-	2-7	2-7	2-7	2-7	2-7	2-7	2-7	2-7	2-7	2-7	2-7	2-7	2-7	-
P33	-	3-7	3-7	3-7	3-7	3-7	3-7	3-7	3-7	3-7	3-7	3-7	3-7	3-7	-
P34	-	4-7	4-7	4-7	4-7	4-7	4-7	4-7	4-7	4-7	4-7	4-7	4-7	4-7	-
P35	-	5-7	5-7	5-7	5-7	5-7	5-7	5-7	5-7	5-7	5-7	5-7	5-7	5-7	-
P36	-	HDMI	GROUP	TITLE	TRACK	CHAP	TOTAL	SING	REM	Dp	-	Dp	2 CH	MULTI	-

--MEMO--

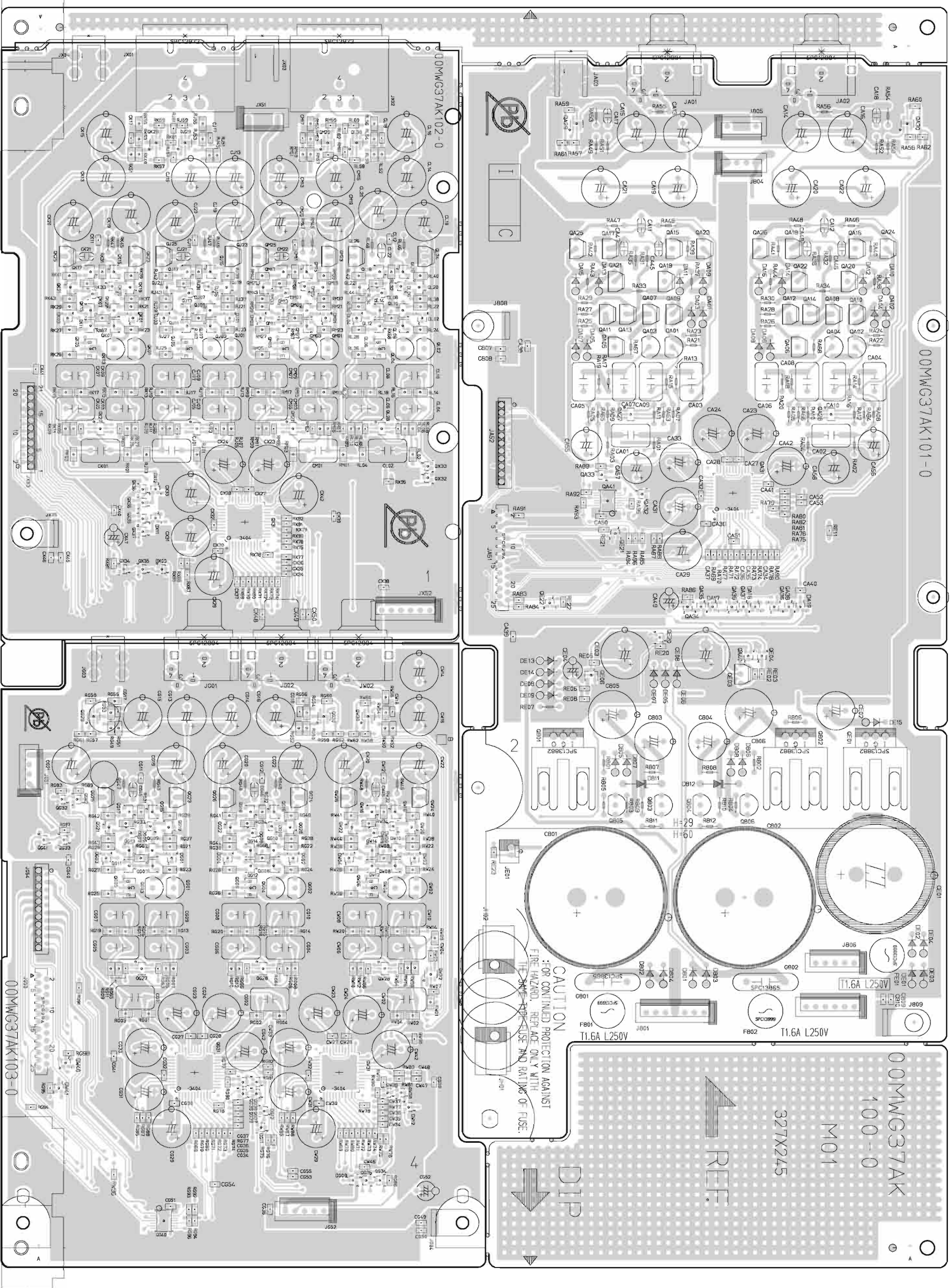

CAUTION
FOR CONTINUED PROTECTION AGAINST
FIRE HAZARD, REPLACE ONLY WITH
THE SAME TYPE, RATING AND RATING OF FUSE.

REF

DIP

00MWG37AK
100-0

M01

327X245

00MWG37AK101-0

00MWG37AK102-0

00MWG37AK103-0

UD9004

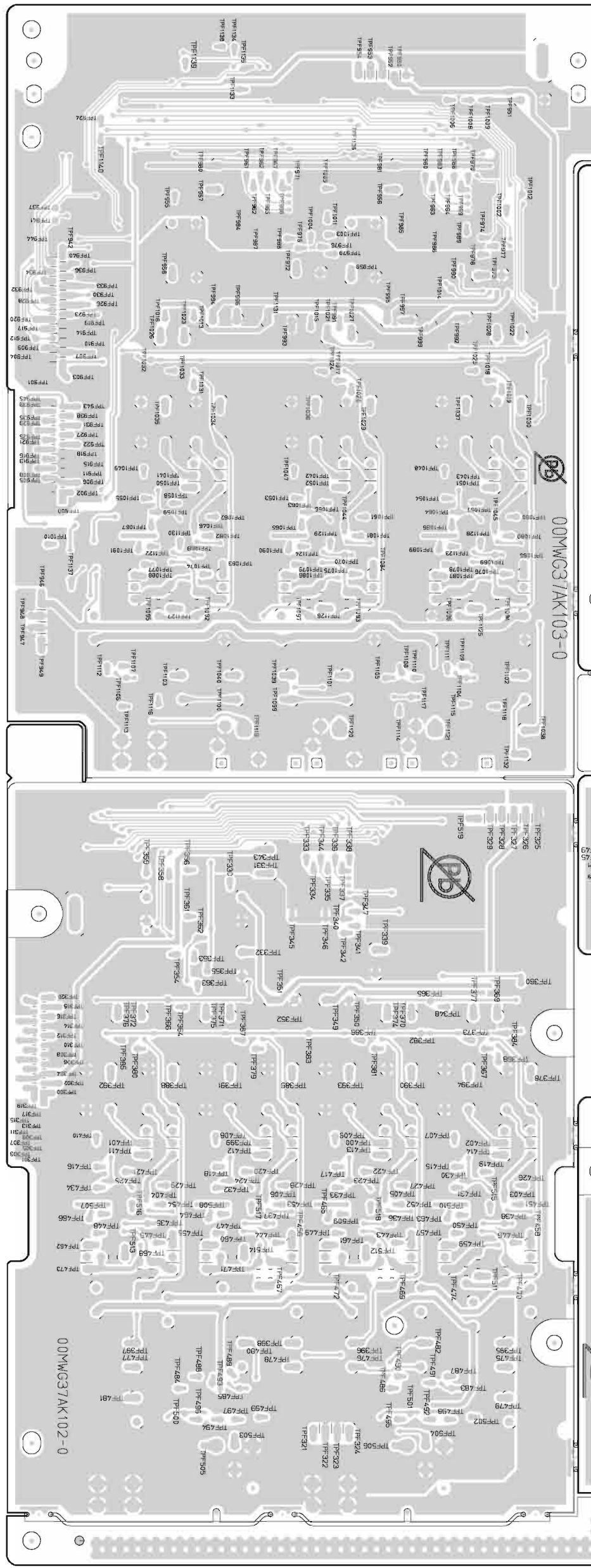
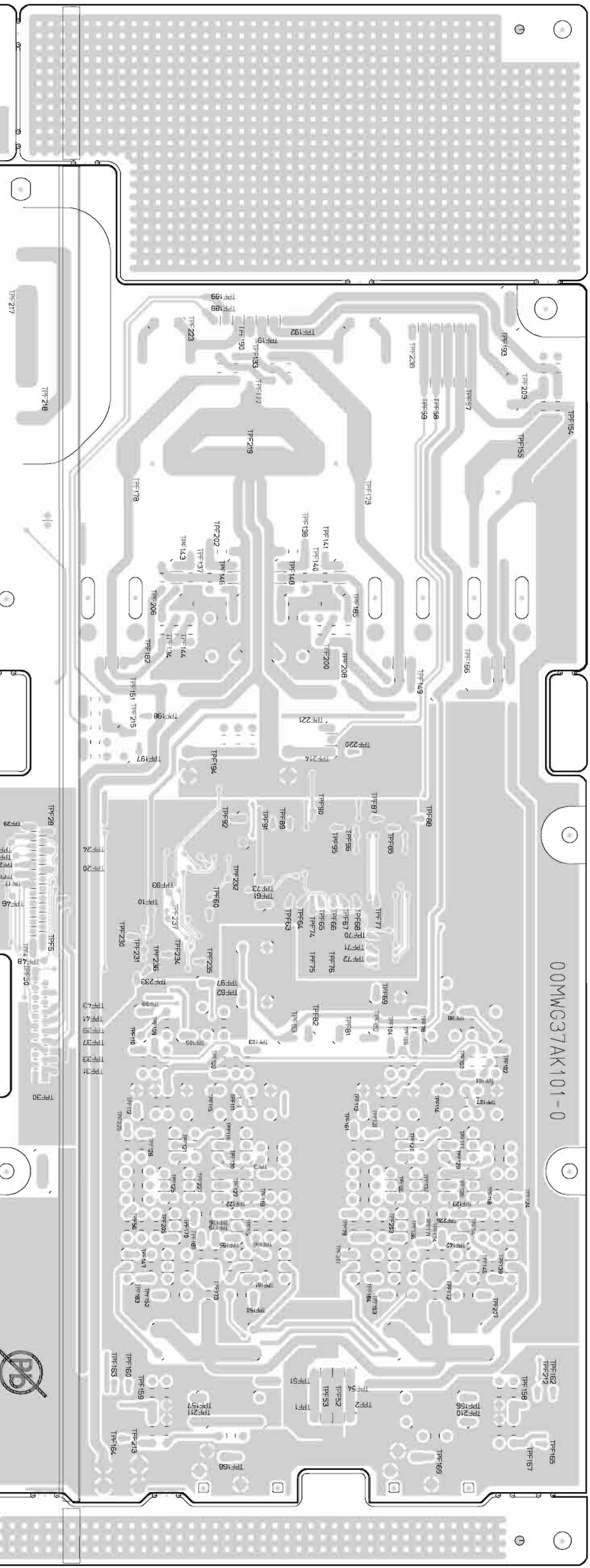

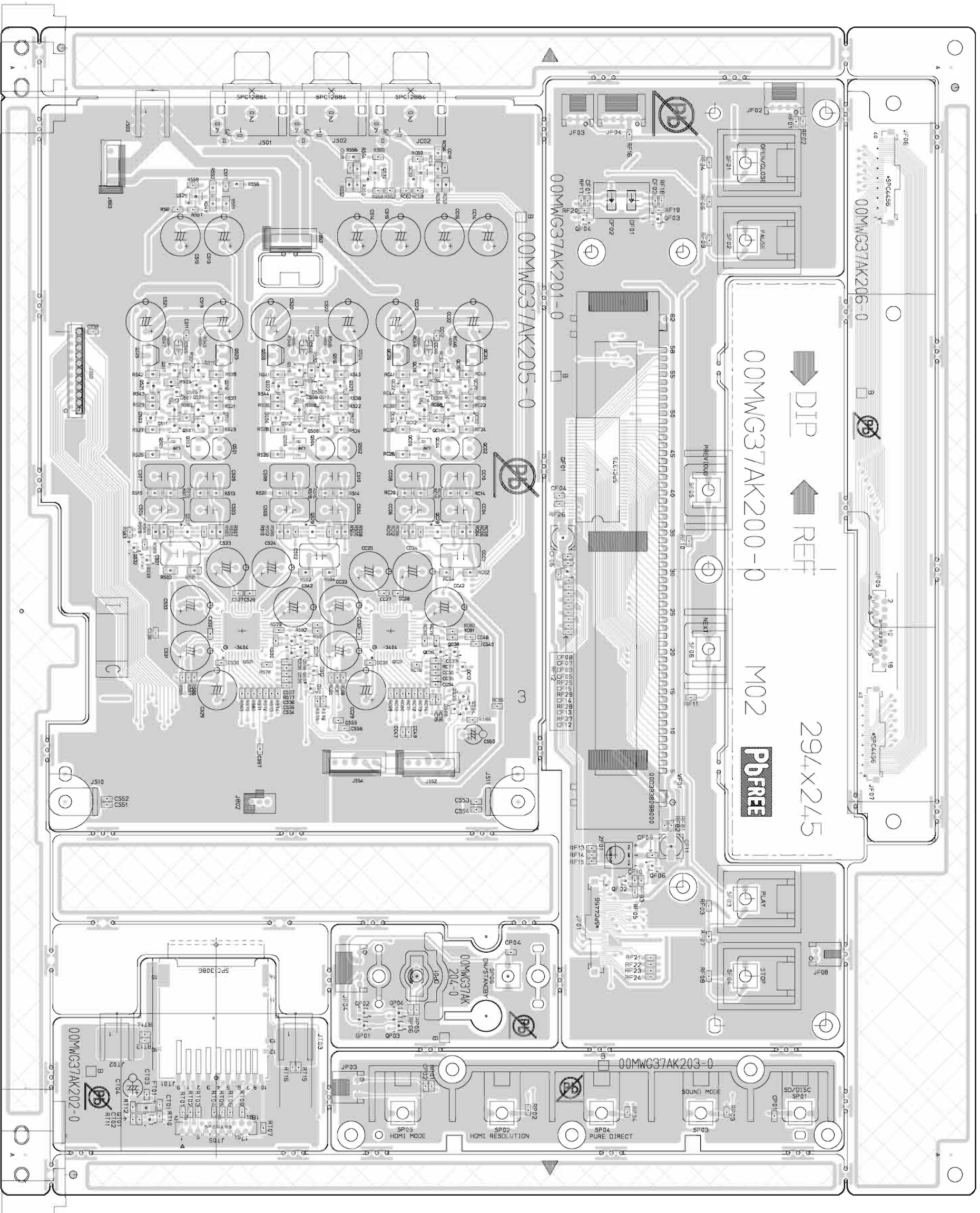

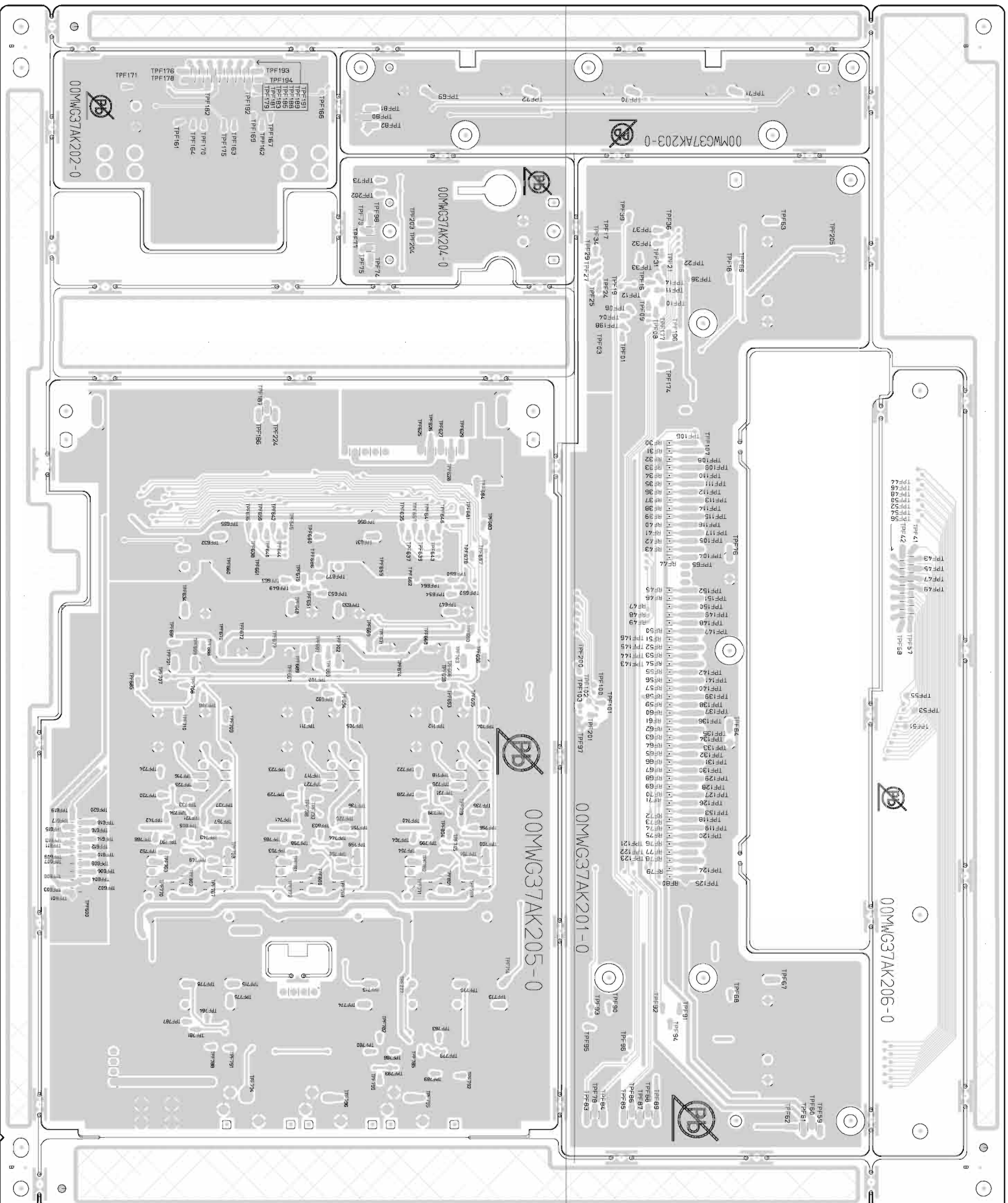

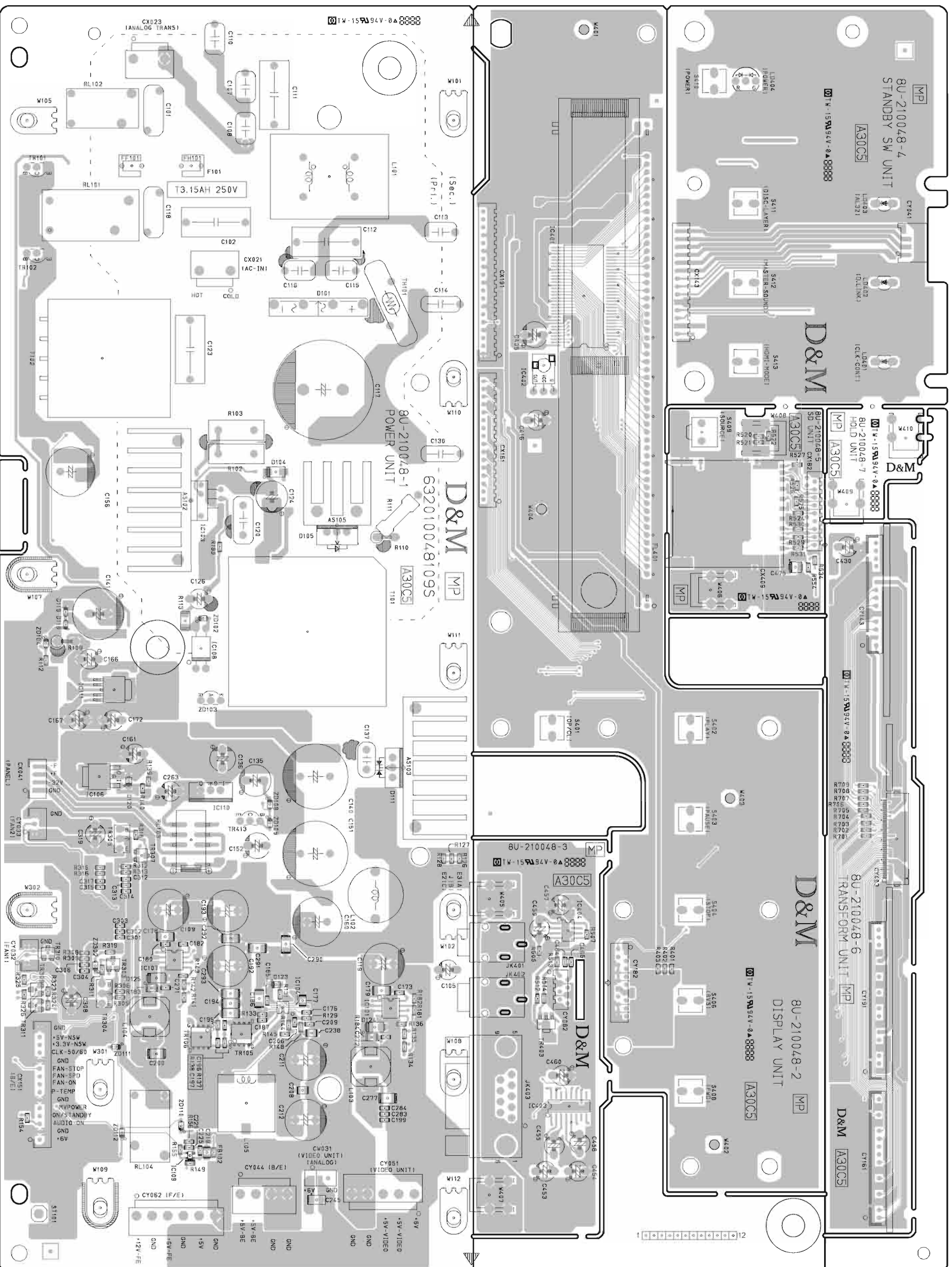

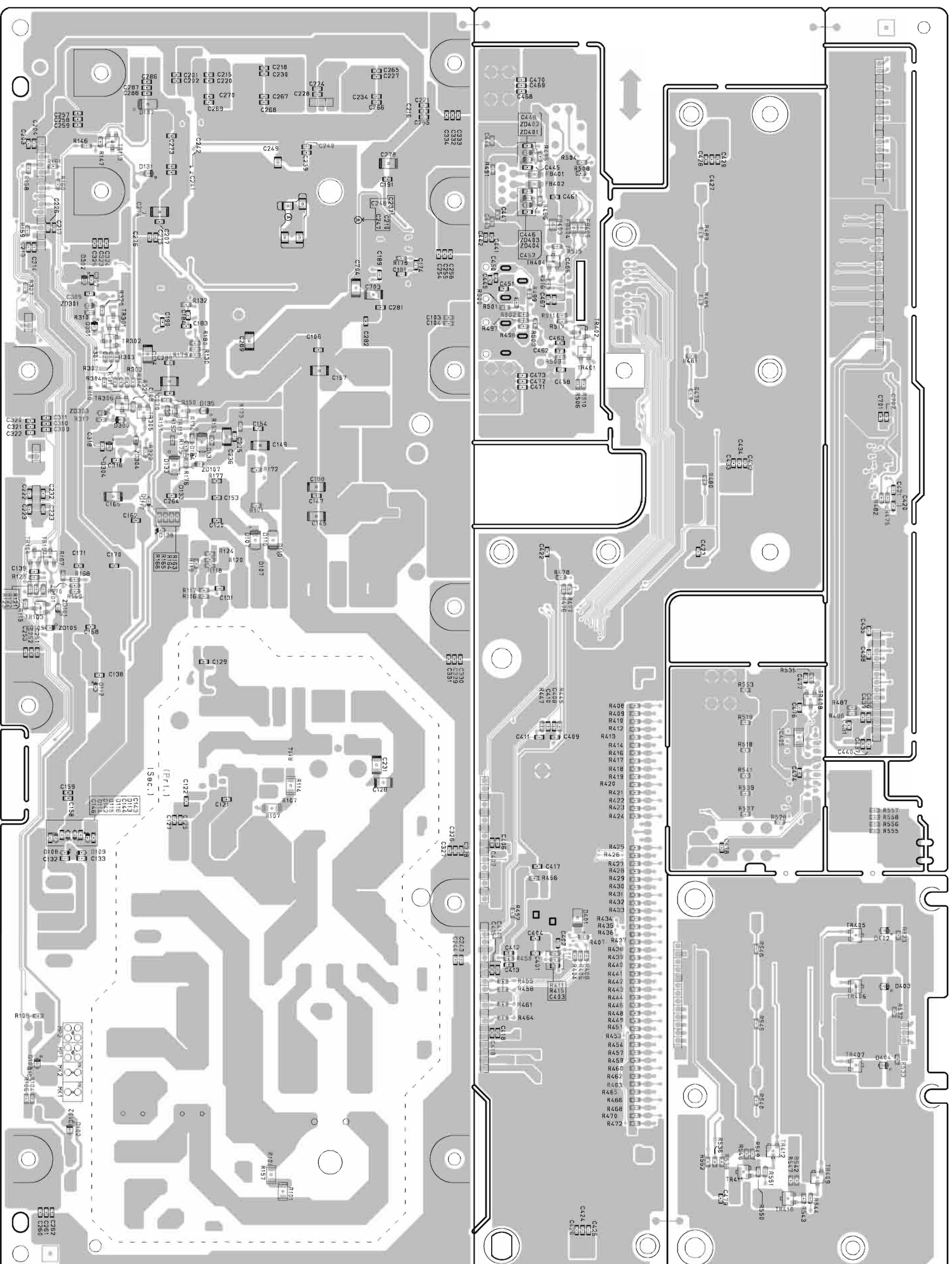

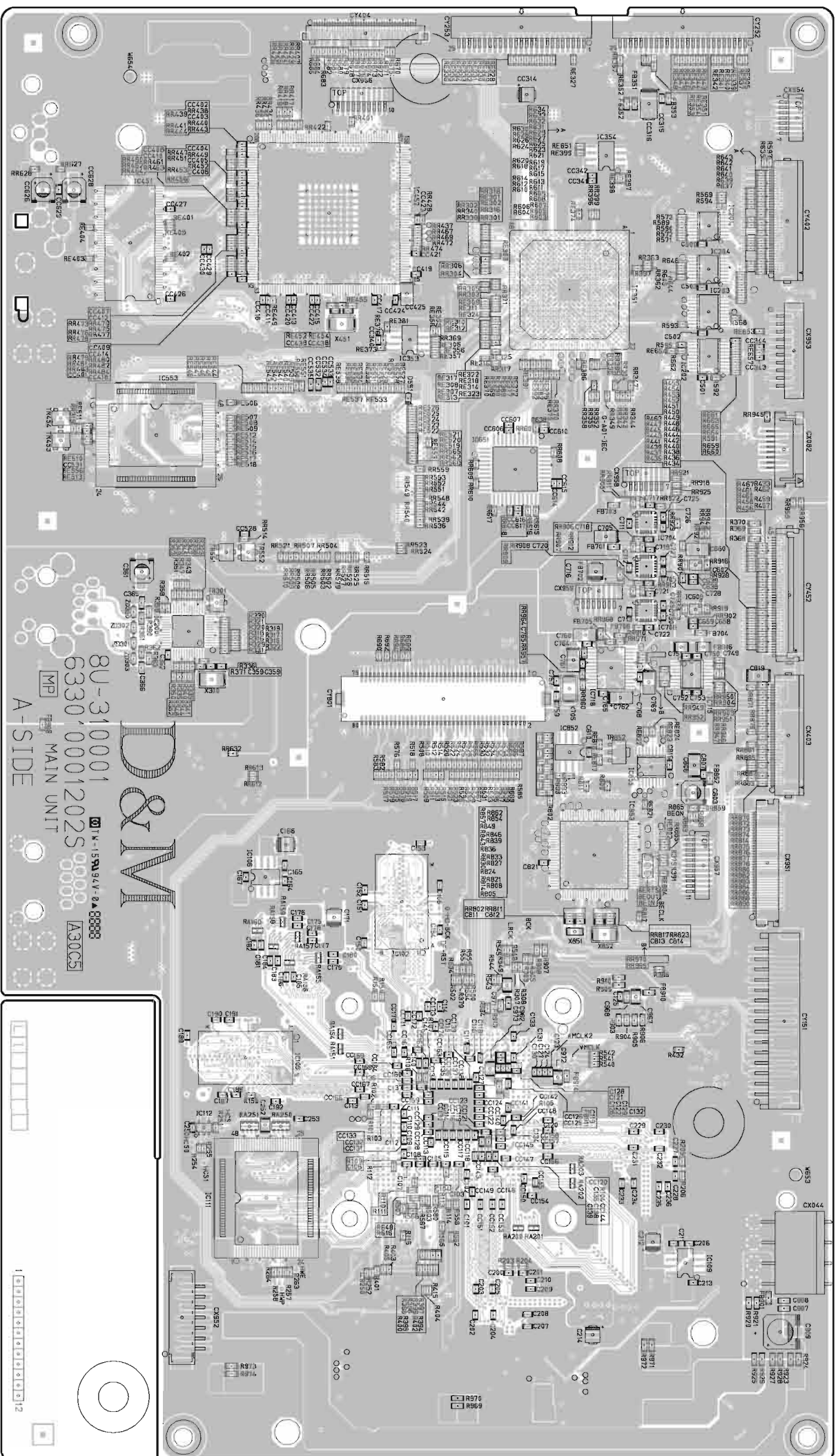

COMPONENT SIDE

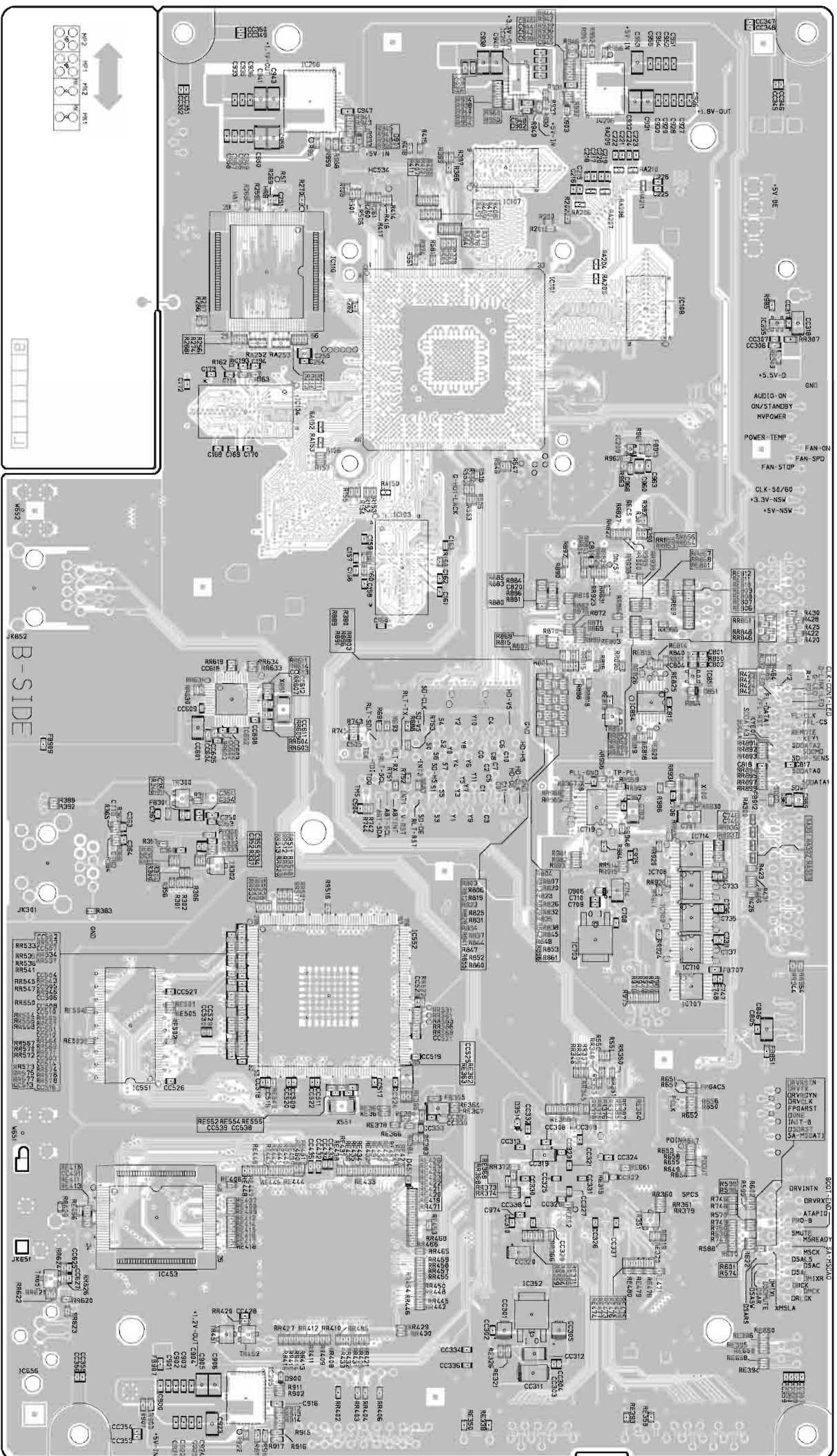

FOIL SIDE

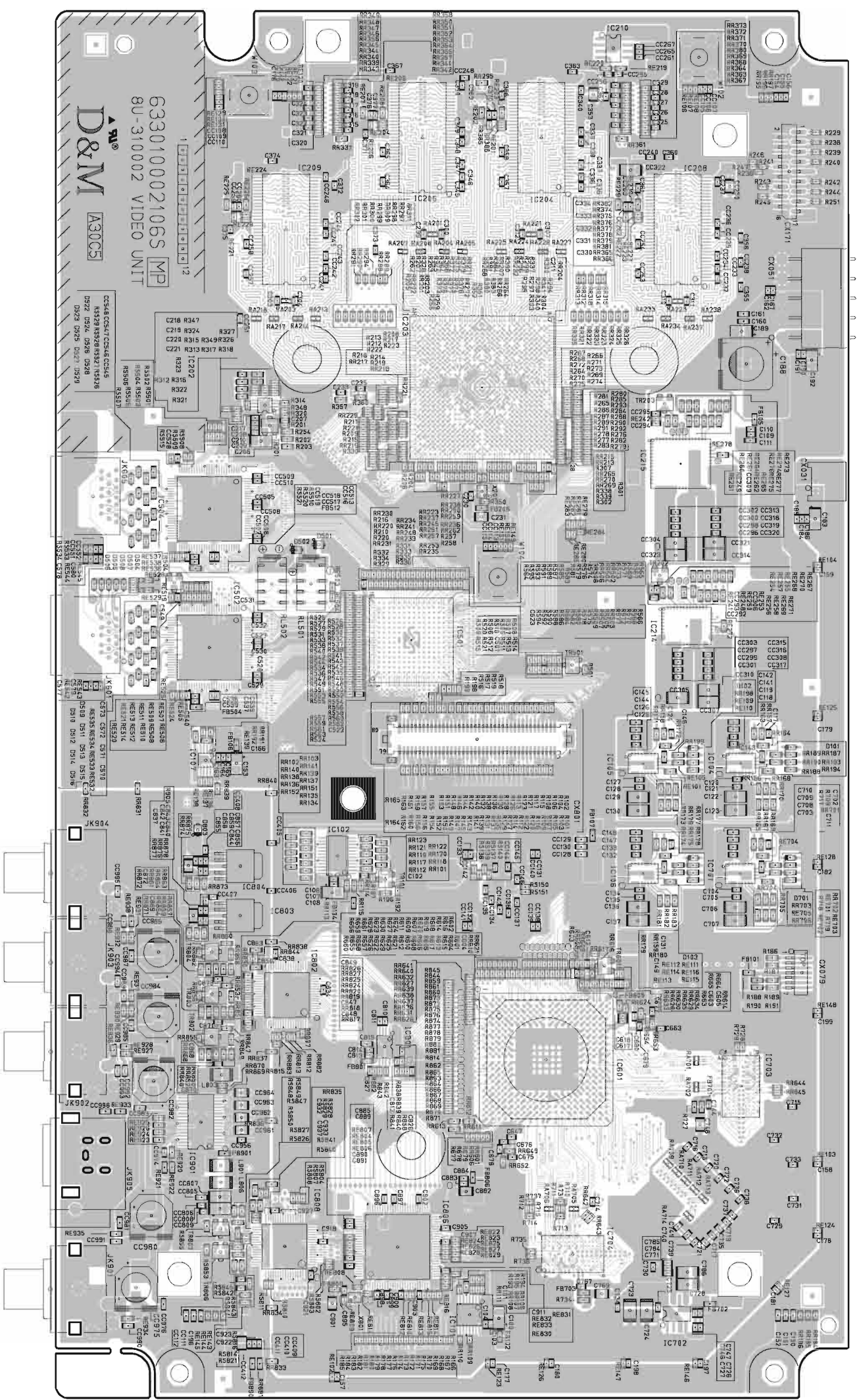

COMPONENT SIDE

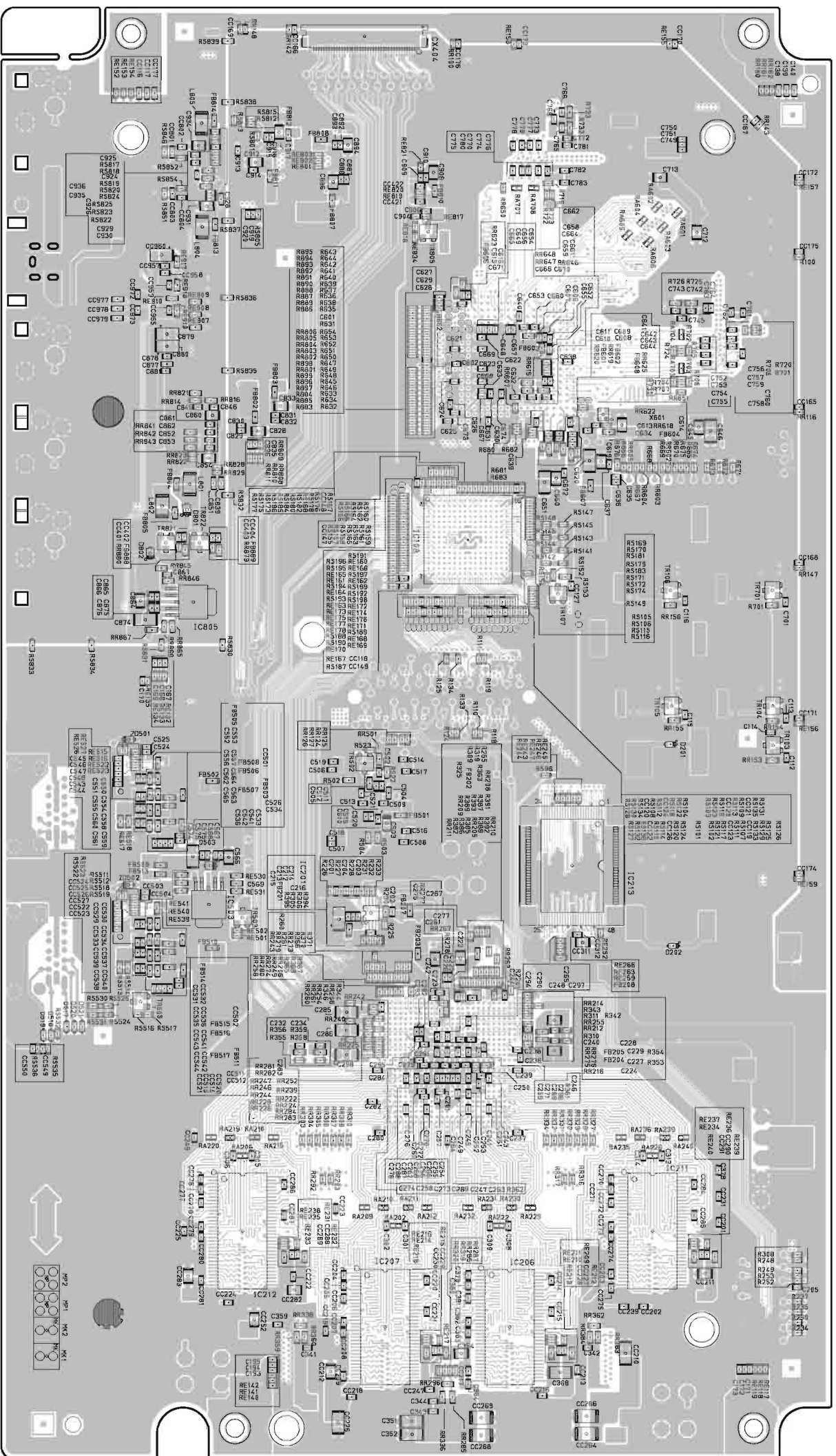

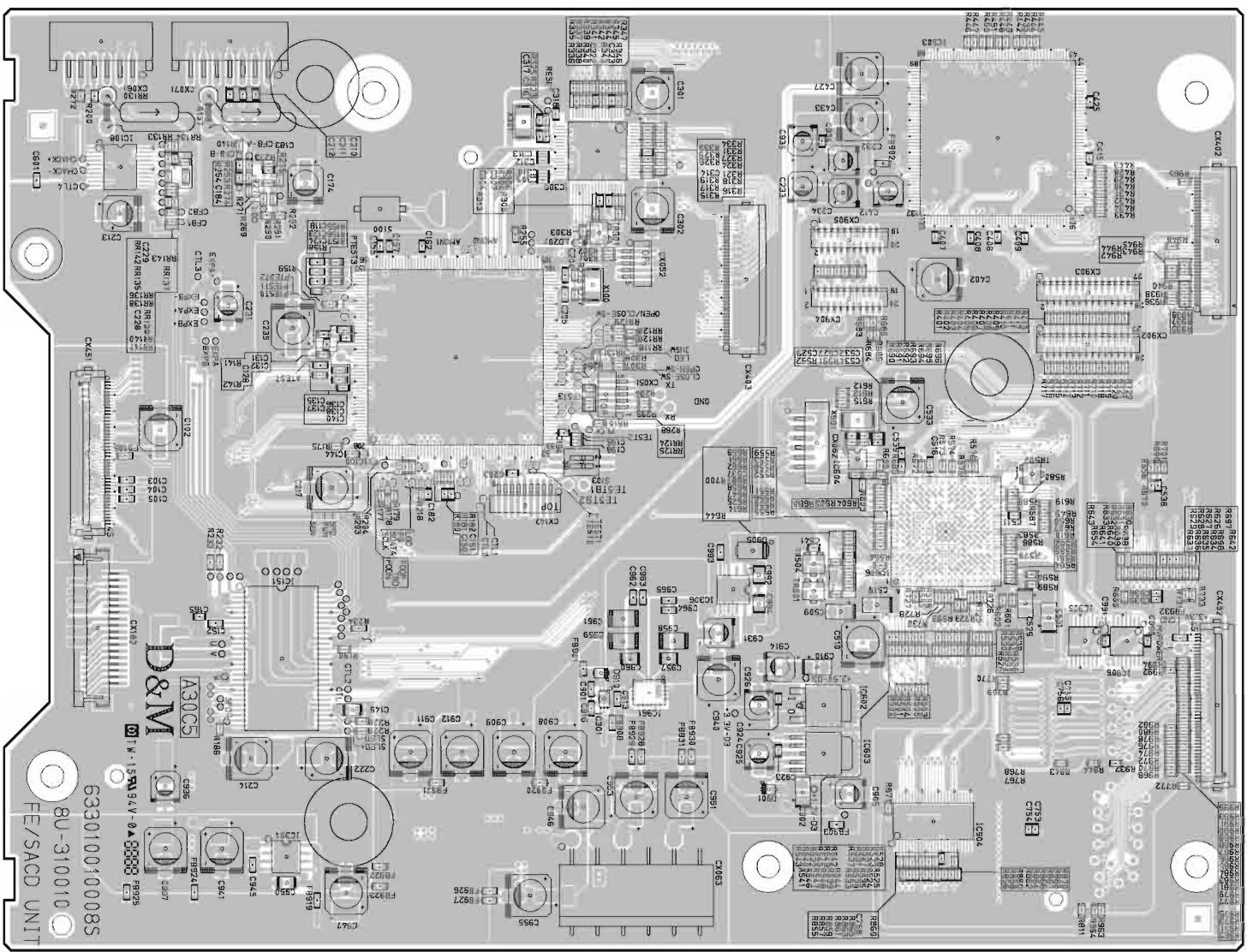

COMPONENT SIDE

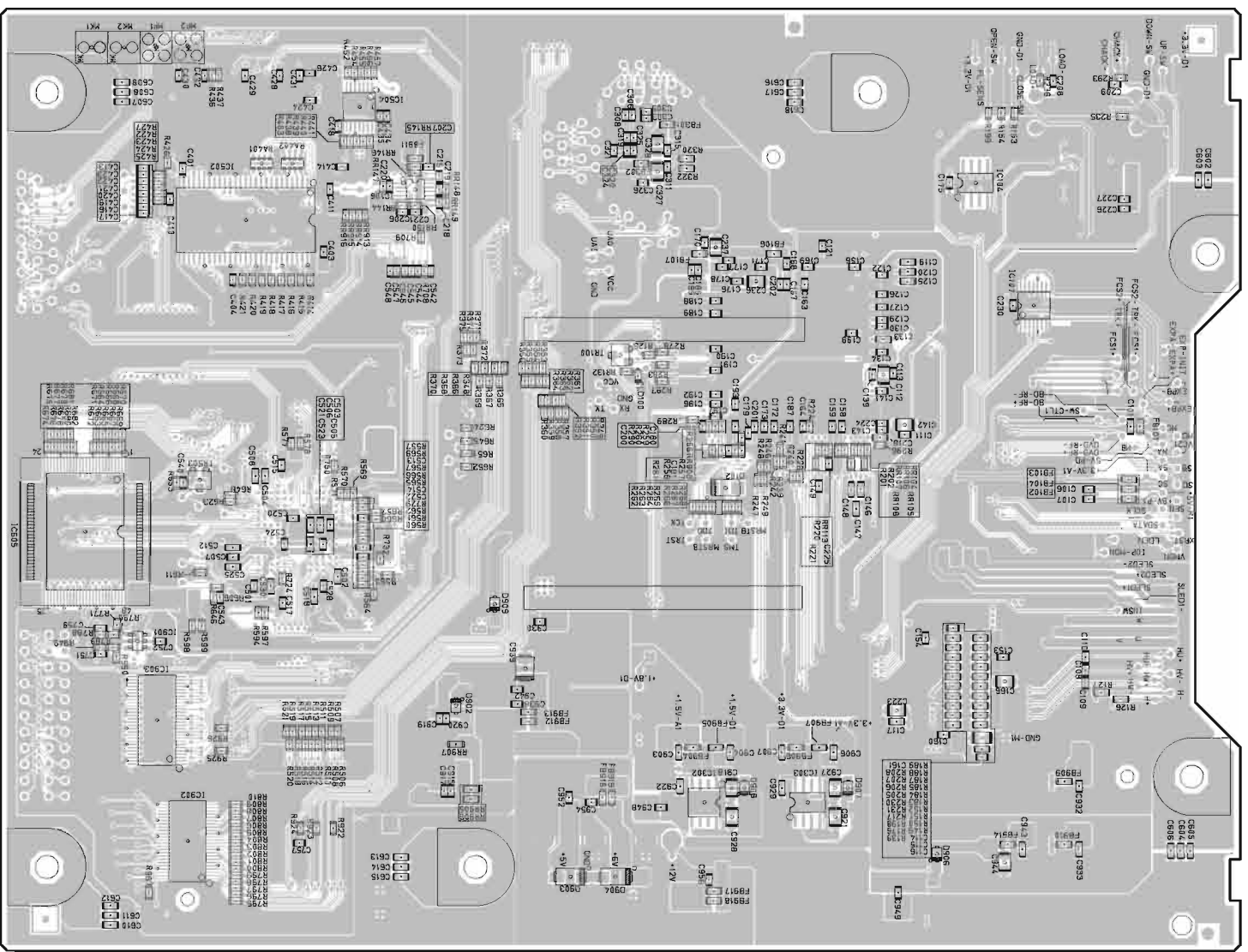

FOIL SIDE

1U-3791 FG CX P.W.B. UNIT

8U-210075A FE REG PWB UNIT ASSY

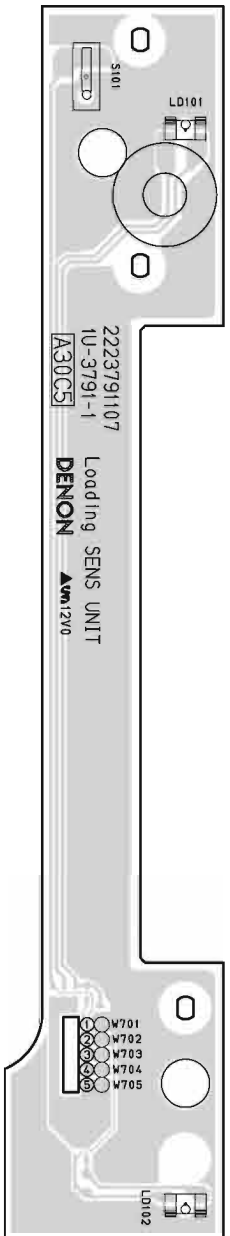

COMPONENT SIDE

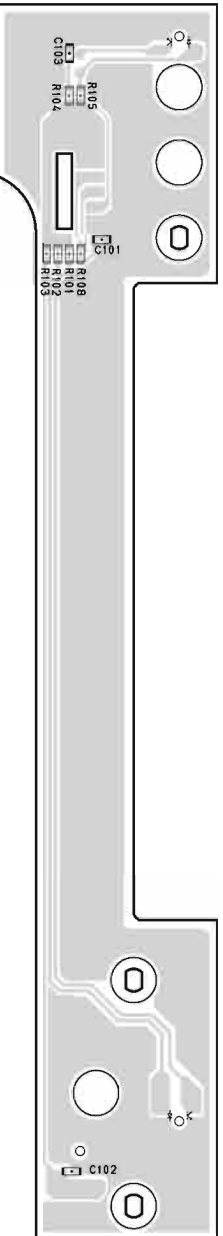

FOIL SIDE

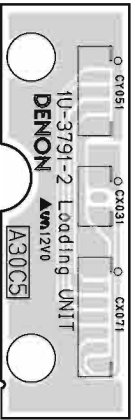

COMPONENT SIDE

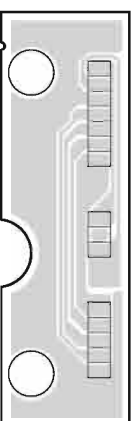

FOIL SIDE

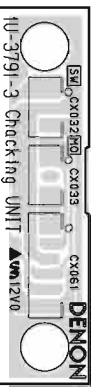

COMPONENT SIDE



FOIL SIDE

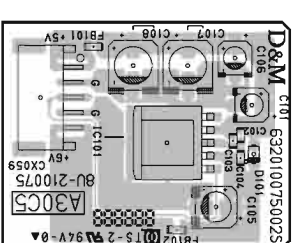

FOIL SIDE

NOTE FOR PARTS LIST

1. Parts for which "nsp" is indicated on this table cannot be supplied.
2. When ordering of part, clearly indicate "I" and "I" (i) to avoid mis-supplying.
3. Ordering part without stating its part number can not be supplied.
4. Part indicated with the mark "★" is not illustrated in the exploded view.
5. Not including General-purpose Carbon Film Resistor in the P.W.Board parts list. (Refer to the Schematic Diagram for those parts.)
6. Not including General-purpose Carbon Chip Resistor in the P.W.Board parts list. (Refer to the Schematic Diagram for those parts.)

WARNING:

Parts marked with this symbol \triangle have critical characteristics.
Use ONLY replacement parts recommended by the manufacturer.

● Resistors

Ex.: RN 14K 2E 182 G FR

Type Shape and performance Power Resistance Allowable error Others

RD : Carbon	2B : 1/8 W	F : ±1%	P : Pulse-resistant type
RC : Composition	2E : 1/4 W	G : ±2%	NL : Low noise type
RS : Metal oxide film	2H : 1/2 W	J : ±5%	NB : Non-burning type
RW : winding	3A : 1 W	K : ±10%	FR : Fuse-resistor
RN : Metal film	3D : 2 W	M : ±20%	F : Lead wire forming
RK : Metal mixture	3F : 3 W		
	3H : 5 W		

* Resistance

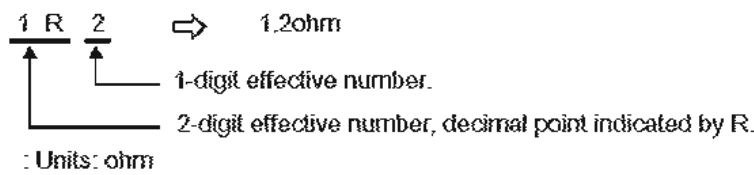
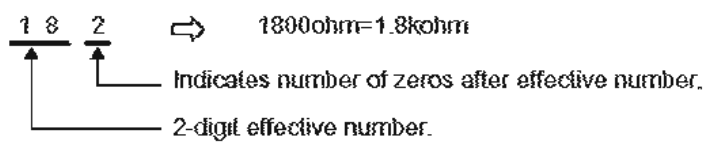

● Capacitors

Ex.: CE 04W 1H 3R2 M BP

Type Shape and performance Dielectric strength Capacity Allowable error Others

CE : Aluminum foil electrolytic	0J : 6.3 V	F : ±1%	HS : High stability type
CA : Aluminium solid electrolytic	1A : 10 V	G : ±2%	BP : Non-polar type
CS : Tantalum electrolytic	1C : 16 V	J : ±5%	HR : Ripple-resistant type
CQ : Film	1E : 25 V	K : ±10%	DL : For charge and discharge
CK : Ceramic	1V : 35 V	M : ±20%	HF : For assuring high frequency
CC : Ceramic	1H : 50 V	Z : ±80%	U : UL part
CP : Oil	2A : 100 V	: -20%	C : CSA part
CM : Mica	2B : 125 V	P : +100%	W : UL-CSA part
CF : Metallized	2C : 160 V	C : ±0.25pF	F : Lead wire forming
CH : Metallized	2D : 200 V	D : ±0.5pF	
	2E : 250 V	= : Others	
	2H : 500 V		
	2J : 630 V		

* Capacity (electrolyte only)

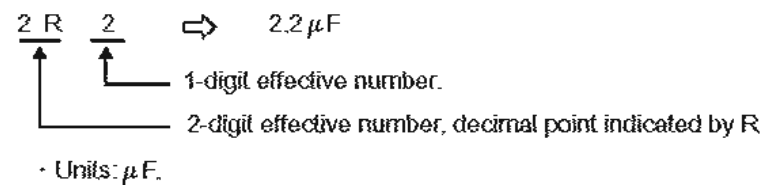
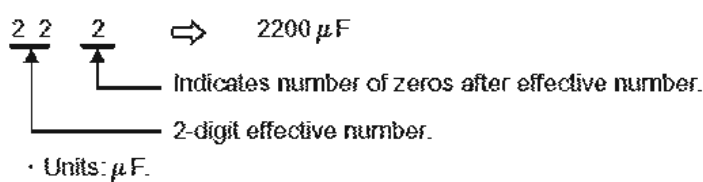

* Capacity (except electrolyte)

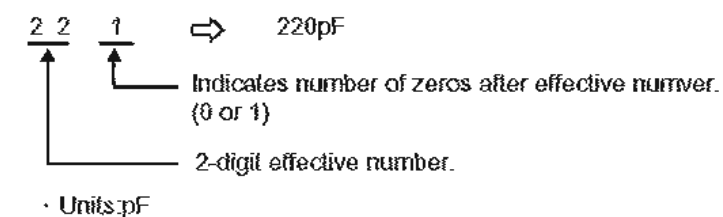
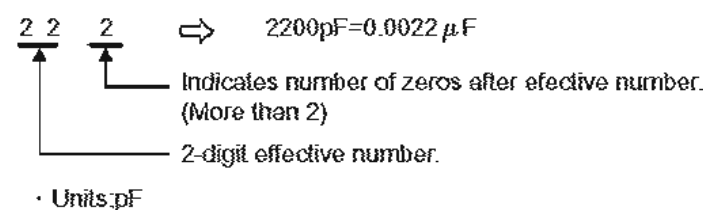

· When the dielectric strength is indicated in AC, "AC" is included after the dielectric strength value.

PARTS LIST OF P.W.B. UNIT

* Parts for which "nsp" is indicated on this table cannot be supplied.

* The parts listed below are for maintenance only, might differ from the parts used in the unit in appearances or dimensions.

Note: The symbols in the column "Remarks" indicate the following destinations.

U : North America model N : Europe model S : Singapore model R : Russia model

8U-37AK51000 AUDIO PWB UNIT ASSY

Ref. No.	Part No. (for EUR)	Part No.	Part Name	Remarks	Q'ty	New
SEMICONDUCTORS GROUP						
D801-804 D805-808 D811,812	00MHD20003710 00D2760401905 00MHD30021010	00MHD20003710 00D2760401905 00MHD30021010	! SCHOTTKY 1S100 1A 100V RECTRON 1SS133T77 (TAPE) ZENER HZ6A3L(HITACHI)			
DA01-04 DA05-12 DA13-16 DA17-19	00D2760401905 00D2760401905 00D2760401905 00MHZ21005000	00D2760401905 00D2760401905 00D2760401905 00MHZ21005000	1SS133T77 (TAPE) 1SS133T77 (TAPE) 1SS133T77 (TAPE) 1SS301 DAN202U UMT TYPE			
DE01-04 DE05-06 DE07,15 DE08,09 DE13,14	00MHD20003710 00MHD20002710 00D2760401905 00MHD20002710 00MHD20002710	00MHD20003710 00MHD20002710 00D2760401905 00MHD20002710 00MHD20002710	! SCHOTTKY 1S100 1A 100V RECTRON 1D3 1A/200V 1SS133T77 (TAPE) 1D3 1A/200V 1D3 1A/200V			
DG01-08 DG09 DG11,12	00MHZ20018050 00MHZ21005000 00MHZ21005000	00MHZ20018050 00MHZ21005000 00MHZ21005000	1SS302 (TE85L F) (TOSHIBA) 1SS301 DAN202U UMT TYPE 1SS301 DAN202U UMT TYPE			
DJ01 DJ03 DJ05 DJ07	00MHZ20018050 00MHZ20018050 00MHZ20018050 00MHZ20018050	00MHZ20018050 00MHZ20018050 00MHZ20018050 00MHZ20018050	1SS302 (TE85L F) (TOSHIBA) 1SS302 (TE85L F) (TOSHIBA) 1SS302 (TE85L F) (TOSHIBA) 1SS302 (TE85L F) (TOSHIBA)			
DK01 DK03 DK05 DK07 DL02	00MHZ20018050 00MHZ20018050 00MHZ20018050 00MHZ20018050 00MHZ20018050	00MHZ20018050 00MHZ20018050 00MHZ20018050 00MHZ20018050 00MHZ20018050	1SS302 (TE85L F) (TOSHIBA) 1SS302 (TE85L F) (TOSHIBA) 1SS302 (TE85L F) (TOSHIBA) 1SS302 (TE85L F) (TOSHIBA) 1SS302 (TE85L F) (TOSHIBA)			
DL04 DL06 DL08 DM01	00MHZ20018050 00MHZ20018050 00MHZ20018050 00MHZ20018050	00MHZ20018050 00MHZ20018050 00MHZ20018050 00MHZ20018050	1SS302 (TE85L F) (TOSHIBA) 1SS302 (TE85L F) (TOSHIBA) 1SS302 (TE85L F) (TOSHIBA) 1SS302 (TE85L F) (TOSHIBA)			
DM03 DM05 DM07 DW02	00MHZ20018050 00MHZ20018050 00MHZ20018050 00MHZ20018050	00MHZ20018050 00MHZ20018050 00MHZ20018050 00MHZ20018050	1SS302 (TE85L F) (TOSHIBA) 1SS302 (TE85L F) (TOSHIBA) 1SS302 (TE85L F) (TOSHIBA) 1SS302 (TE85L F) (TOSHIBA)			
DW04 DW06 DW08 DW12	00MHZ20018050 00MHZ20018050 00MHZ20018050 00MHZ21005000	00MHZ20018050 00MHZ20018050 00MHZ20018050 00MHZ21005000	1SS302 (TE85L F) (TOSHIBA) 1SS302 (TE85L F) (TOSHIBA) 1SS302 (TE85L F) (TOSHIBA) 1SS301 DAN202U UMT TYPE			
DX09 DX11 DX12	00MHZ21005000 00MHZ21005000 00MHZ21005000	00MHZ21005000 00MHZ21005000 00MHZ21005000	1SS301 DAN202U UMT TYPE 1SS301 DAN202U UMT TYPE 1SS301 DAN202U UMT TYPE			

Ref. No.	Part No. (for EUR)	Part No.	Part Name	Remarks	Q'ty	New
Q801	00MHT41415100	00MHT41415100	TRANSISTOR 2SD1415			
Q802	00MHT21020100	00MHT21020100	2SB1020			
Q803	00MHT109702A0	00MHT109702A0	2SC2240 GR OR BL TOSHIBA			
Q804,805	00MHT109702A0	00MHT109702A0	2SA970 (GR) OR (BL) TOSHIBA			
Q806	00MHT109702A0	00MHT109702A0	2SC2240 GR OR BL TOSHIBA			
QA01-04	00MHF203691B0	00MHF203691B0	2SK369 BL VGDS-40V PD0.4W			
QA05-06	00MHT109702A0	00MHT109702A0	2SC2240 GR OR BL TOSHIBA			
QA07-10	00MHT109702A0	00MHT109702A0	2SA970 (GR) OR (BL) TOSHIBA			
QA11-14	00MHT109702A0	00MHT109702A0	2SC2240 GR OR BL TOSHIBA			
QA15,16	00MHT109702A0	00MHT109702A0	2SA970 (GR) OR (BL) TOSHIBA			
QA17-18	00MHT109702A0	00MHT109702A0	2SC2240 GR OR BL TOSHIBA			
QA19,20	00MHT109702A0	00MHT109702A0	2SA970 (GR) OR (BL) TOSHIBA			
QA21,22	00MHT109702A0	00MHT109702A0	2SC2240 GR OR BL TOSHIBA			
QA23,24	00D2730281906	00D2730281906	2SC2705 (O)(Y)TPE6			
QA25,26	00D2710168900	00D2710168900	2SA1145 (O)(Y)TPE6			
QA27-QA30	00MBA20035210	00MBA20035210	HN1C03F(B)(NPNX2(MUTING))			
QA31	235810023600S	235810023600S	AK4399EQ			
QA32	00MBA20035210	00MBA20035210	DTC114EU			
QA33	00MBA10026210	00MBA10026210	DTA114EU			
QA34	00MBA20035210	00MBA20035210	DTC114EU			
QA35	00MBA10026210	00MBA10026210	DTA114EU			
QA36	00MBA20035210	00MBA20035210	DTC114EU			
QA37-38	00MBA10026210	00MBA10026210	DTA114EU			
QA39	00MBA20035210	00MBA20035210	DTC114EU			
QA40	00MBA20035210	00MBA20035210	DTC114EU			
QA41	00D2623411906	00D2623411906	TC74VHC04FT			
QE01	00D2630809006	00D2630809006	NJM7805FA(S)			
QE03	00MHT10001000	00MHT10001000	A1048,A933S,A1267,ETC.			
QE04	00MBA20035210	00MBA20035210	DTC114EU			
QE06	00MHX333241B0	00MHX333241B0	2SC3324 (B)			
QE20-22	00MBA20035210	00MBA20035210	DTC114EU			
QG01-04	00MHF203691B0	00MHF203691B0	2SK369 BL VGDS-40V PD0.4W			
QG05,06	00MHX328731B0	00MHX328731B0	2SC2873 (Y)			
QG07-10	00MHX113121B0	00MHX113121B0	2SA1312 (B)			
QG11-14	00MHX333241B0	00MHX333241B0	2SC3324 (B)			
QG15-16	00MHX113121B0	00MHX113121B0	2SA1312 (B)			
QG17-18	00MHX333241B0	00MHX333241B0	2SC3324 (B)			
QG19,20	00MHX113121B0	00MHX113121B0	2SA1312 (B)			
QG21-22	00MHX333241B0	00MHX333241B0	2SC3324 (B)			
QG23-24	00D2730281906	00D2730281906	2SC2705 (O)(Y)TPE6			
QG25-26	00D2710168900	00D2710168900	2SA1145 (O)(Y)TPE6			
QG27-30	00MBA20035210	00MBA20035210	HN1C03F(B)(NPNX2(MUTING))			
QG31	235810023600S	235810023600S	AK4399EQ			
QG32	00MBA20035210	00MBA20035210	DTC114EU			
QG33	00MBA10026210	00MBA10026210	DTA114EU			
QG34	00MBA20035210	00MBA20035210	DTC114EU			
QG35	00MBA10026210	00MBA10026210	DTA114EU			
QG36	00MBA20035210	00MBA20035210	DTC114EU			
QG37,38	00MBA10026210	00MBA10026210	DTA114EU			
QG39	00MBA20035210	00MBA20035210	DTC114EU			
QG40	00D2623411906	00D2623411906	TC74VHC04FT			
QG41	00MBA20035210	00MBA20035210	DTC114EU			

Ref. No.	Part No. (for EUR)	Part No.	Part Name	Remarks	Q'ty	New
QG42	00MBA10026210	00MBA10026210	DTA114EU			
QJ01	00MHF203691B0	00MHF203691B0	2SK369 BL VGDS-40V PD0.4W			
QJ03	00MHF203691B0	00MHF203691B0	2SK369 BL VGDS-40V PD0.4W			
QJ05	00MHX328731B0	00MHX328731B0	2SC2873 (Y)			
QJ07	00MHX113121B0	00MHX113121B0	2SA1312 (B)			
QJ09	00MHX113121B0	00MHX113121B0	2SA1312 (B)			
QJ11	00MHX333241B0	00MHX333241B0	2SC3324 (B)			
QJ13	00MHX333241B0	00MHX333241B0	2SC3324 (B)			
QJ15	00MHX113121B0	00MHX113121B0	2SA1312 (B)			
QJ17	00MHX333241B0	00MHX333241B0	2SC3324 (B)			
QJ19	00MHX113121B0	00MHX113121B0	2SA1312 (B)			
QJ21	00MHX333241B0	00MHX333241B0	2SC3324 (B)			
QJ23	00D2730281906	00D2730281906	2SC2705 (O)/(Y)TPE6			
QJ25	00D2710168900	00D2710168900	2SA1145 (O)/(Y)TPE6			
QJ27	00MBA20035210	00MBA20035210	HN1C03F(B)(NPNX2(MUTING))			
QJ29	00MBA20035210	00MBA20035210	HN1C03F(B)(NPNX2(MUTING))			
QK01	00MHF203691B0	00MHF203691B0	2SK369 BL VGDS-40V PD0.4W			
QK03	00MHF203691B0	00MHF203691B0	2SK369 BL VGDS-40V PD0.4W			
QK05,06	00MHX328731B0	00MHX328731B0	2SC2873 (Y)			
QK07	00MHX113121B0	00MHX113121B0	2SA1312 (B)			
QK09	00MHX113121B0	00MHX113121B0	2SA1312 (B)			
QK11	00MHX333241B0	00MHX333241B0	2SC3324 (B)			
QK13	00MHX333241B0	00MHX333241B0	2SC3324 (B)			
QK15	00MHX113121B0	00MHX113121B0	2SA1312 (B)			
QK17	00MHX333241B0	00MHX333241B0	2SC3324 (B)			
QK19	00MHX113121B0	00MHX113121B0	2SA1312 (B)			
QK21	00MHX333241B0	00MHX333241B0	2SC3324 (B)			
QK23	00D2730281906	00D2730281906	2SC2705 (O)/(Y)TPE6			
QK25	00D2710168900	00D2710168900	2SA1145 (O)/(Y)TPE6			
QK27	00MBA20035210	00MBA20035210	HN1C03F(B)(NPNX2(MUTING))			
QK29	00MBA20035210	00MBA20035210	HN1C03F(B)(NPNX2(MUTING))			
QL02	00MHF203691B0	00MHF203691B0	2SK369 BL VGDS-40V PD0.4W			
QL04	00MHF203691B0	00MHF203691B0	2SK369 BL VGDS-40V PD0.4W			
QL08	00MHX113121B0	00MHX113121B0	2SA1312 (B)			
QL10	00MHX113121B0	00MHX113121B0	2SA1312 (B)			
QL12	00MHX333241B0	00MHX333241B0	2SC3324 (B)			
QL14	00MHX333241B0	00MHX333241B0	2SC3324 (B)			
QL16	00MHX113121B0	00MHX113121B0	2SA1312 (B)			
QL18	00MHX333241B0	00MHX333241B0	2SC3324 (B)			
QL20	00MHX113121B0	00MHX113121B0	2SA1312 (B)			
QL22	00MHX333241B0	00MHX333241B0	2SC3324 (B)			
QL24	00D2730281906	00D2730281906	2SC2705 (O)/(Y)TPE6			
QL26	00D2710168900	00D2710168900	2SA1145 (O)/(Y)TPE6			
QL28	00MBA20035210	00MBA20035210	HN1C03F(B)(NPNX2(MUTING))			
QL30	00MBA20035210	00MBA20035210	HN1C03F(B)(NPNX2(MUTING))			
QM01	00MHF203691B0	00MHF203691B0	2SK369 BL VGDS-40V PD0.4W			
QM03	00MHF203691B0	00MHF203691B0	2SK369 BL VGDS-40V PD0.4W			
QM05	00MHX328731B0	00MHX328731B0	2SC2873 (Y)			
QM07	00MHX113121B0	00MHX113121B0	2SA1312 (B)			
QM09	00MHX113121B0	00MHX113121B0	2SA1312 (B)			
QM11	00MHX333241B0	00MHX333241B0	2SC3324 (B)			

	Ref. No.	Part No. (for EUR)	Part No.	Part Name	Remarks	Q'ty	New
	QM13	00MHX333241B0	00MHX333241B0	2SC3324 (B)			
	QM15	00MHX113121B0	00MHX113121B0	2SA1312 (B)			
	QM17	00MHX333241B0	00MHX333241B0	2SC3324 (B)			
	QM19	00MHX113121B0	00MHX113121B0	2SA1312 (B)			
	QM21	00MHX333241B0	00MHX333241B0	2SC3324 (B)			
	QM23	00D2730281906	00D2730281906	2SC2705 (O)/(Y)TPE6			
	QM25	00D2710168900	00D2710168900	2SA1145 (O)/(Y)TPE6			
	QM27	00MBA20035210	00MBA20035210	HN1C03F(B)(NPNX2(MUTING))			
	QM29	00MBA20035210	00MBA20035210	HN1C03F(B)(NPNX2(MUTING))			
	QW02	00MHF203691B0	00MHF203691B0	2SK369 BL VGDS-40V P00.4W			
	QW04	00MHF203691B0	00MHF203691B0	2SK369 BL VGDS-40V P00.4W			
	QW06	00MHX328731B0	00MHX328731B0	2SC2873 (Y)			
	QW08	00MHX113121B0	00MHX113121B0	2SA1312 (B)			
	QW10	00MHX113121B0	00MHX113121B0	2SA1312 (B)			
	QW12	00MHX333241B0	00MHX333241B0	2SC3324 (B)			
	QW14	00MHX333241B0	00MHX333241B0	2SC3324 (B)			
	QW16	00MHX113121B0	00MHX113121B0	2SA1312 (B)			
	QW18	00MHX333241B0	00MHX333241B0	2SC3324 (B)			
	QW20	00MHX113121B0	00MHX113121B0	2SA1312 (B)			
	QW22	00MHX333241B0	00MHX333241B0	2SC3324 (B)			
	QW24	00D2730281906	00D2730281906	2SC2705 (O)/(Y)TPE6			
	QW26	00D2710168900	00D2710168900	2SA1145 (O)/(Y)TPE6			
	QW28	00MBA20035210	00MBA20035210	HN1C03F(B)(NPNX2(MUTING))			
	QW30	00MBA20035210	00MBA20035210	HN1C03F(B)(NPNX2(MUTING))			
	QW31	235810023600S	235810023600S	AK4399EQ			
	QW32	00MBA20035210	00MBA20035210	HN1C03F(B)(NPNX2(MUTING))			
	QW36	00MBA20035210	00MBA20035210	DTC114EU			
	QW40	00MBA20035210	00MBA20035210	DTC114EU			
	QW41	00MBA20035210	00MBA20035210	DTC114EU			
	QX31	235810023600S	235810023600S	AK4399EQ			
	QX32	00MBA20035210	00MBA20035210	DTC114EU			
	QX33	00MBA10026210	00MBA10026210	DTA114EU			
	QX34	00MBA20035210	00MBA20035210	DTC114EU			
	QX35	00MBA10026210	00MBA10026210	DTA114EU			
	QX36	00MBA20035210	00MBA20035210	DTC114EU			
	QX37	00MBA10026210	00MBA10026210	DTA114EU			
	QX38	00MBA10026210	00MBA10026210	DTA114EU			
	QX39	00MBA20035210	00MBA20035210	DTC114EU			
RESISTORS GROUP							
	R801,802	00D2412396986	00D2412396986	RD14B2E181JT(5)			
	R803,804	00D2412403934	00D2412403934	RD14B2E104JT(5)			
	R805,806	00D2412395987	00D2412395987	RD14B2E680JT(5)			
	R807,808	00D2412399970	00D2412399970	RD14B2E332JT(5)			
	R809,810	00D2412398971	00D2412398971	RD14B2E122JT(5)			
	R811,812	00D2412399970	00D2412399970	RD14B2E332JT(5)			
	RA01-04	00D2412398955	00D2412398955	RD14B2E102JT(5)			
	RA05-06	00D2412401978	00D2412401978	RD14B2E223JT(5)			
	RA07-10	00D2412400995	00D2412400995	RD14B2E103JT(5)			
	RA11-14	00D2412401978	00D2412401978	RD14B2E223JT(5)			
	RA15-18	00D2412399970	00D2412399970	RD14B2E332JT(5)			

	Ref. No.	Part No. (for EUR)	Part No.	Part Name	Remarks	Q'ty	New
	RA19,20	00D2412401994	00D2412401994	RD14B2E273JT(5)			
	RA21-24	00D2412396944	00D2412396944	RD14B2E121JT(5)			
	RA25,26	00D2412395987	00D2412395987	RD14B2E680JT(5)			
	RA27-30	00D2412397998	00D2412397998	RD14B2E561JT(5)			
	RA31,32	00D2412396928	00D2412396928	RD14B2E101JT(5)			
	RA33,34	00D2412402919	00D2412402919	RD14B2E333JT(5)			
	RA35,36	nsp	nsp	0 OHM \pm 5% 1/6W			
	RA37,38	00D2412397927	00D2412397927	RD14B2E271JT(5)			
	RA39-42	00D2412396928	00D2412396928	RD14B2E101JT(5)			
	RA43,44	00D2412397927	00D2412397927	RD14B2E271JT(5)			
	RA45-48	00D2412393989	00D2412393989	RD14B2E100JT(5)			
	RA49,50	nsp	nsp	220 OHM \pm 5% 1/6W			
	RA51,52	00D2412402951	00D2412402951	RD14B2E473JT(5)			
	RA53,54	nsp	nsp	220 OHM \pm 5% 1/6W			
	RA55,56	00D2412395990	00D2412395990	RD14B2E750JT(5)			
	RA63-A66	00D2412400911	00D2412400911	RD14B2E472JT(5)			
	RA67,68	00D2412402919	00D2412402919	RD14B2E333JT(5)			
	RA85	nsp	nsp	RM73B-330JT +1608			
	RA87,88	nsp	nsp	RM73B-0R0KT +1608			
	RA91,92	nsp	nsp	RM73B-0R0KT +1608			
	RA95,96	nsp	nsp	RM73B-0R0KT +1608			
	RE07	00D2412398955	00D2412398955	RD14B2E102JT(5)			
	RE11	nsp	nsp	RM73B-0R0KT +1608			
	RG05,06	00MNI01223110	00MNI01223110	22K OHM \pm 1% 1/10W			
	RG07-10	00MNI01103110	00MNI01103110	10K OHM \pm 1% 1/10W			
	RG11-14	00MNI01223110	00MNI01223110	22K OHM \pm 1% 1/10W			
	RG19,20	00MNI01273110	00MNI01273110	27K OHM \pm 1% 1/10W			
	RG45-48	00D2412393989	00D2412393989	RD14B2E100JT(5)			
	RG49,50	00MNI05221110	00MNI05221110	220 OHM \pm 5% 1/10W			
	RG53,54	00MNI05221110	00MNI05221110	220 OHM \pm 5% 1/10W			
	RG85	nsp	nsp	RM73B-330JT +1608			
	RG87,88	nsp	nsp	RM73B-0R0KT +1608			
	RG91	nsp	nsp	RM73B-0R0KT +1608			
	RG94	nsp	nsp	RM73B-0R0KT +1608			
	RG96	nsp	nsp	RM73B-0R0KT +1608			
	RJ05	00MNI01123110	00MNI01123110	12K OHM \pm 1% 1/10W			
	RJ07	00MNI01103110	00MNI01103110	10K OHM \pm 1% 1/10W			
	RJ09	00MNI01103110	00MNI01103110	10K OHM \pm 1% 1/10W			
	RJ11	00MNI01123110	00MNI01123110	12K OHM \pm 1% 1/10W			
	RJ19	00MNI01103110	00MNI01103110	18K OHM \pm 1% 1/10W			
	RJ45	00D2412393989	00D2412393989	RD14B2E100JT(5)			
	RJ47	00D2412393989	00D2412393989	RD14B2E100JT(5)			
	RJ49	00MNI05221110	00MNI05221110	220 OHM \pm 5% 1/10W			
	RJ53	00MNI05221110	00MNI05221110	220 OHM \pm 5% 1/10W			
	RK05	00MNI01123110	00MNI01123110	12K OHM \pm 1% 1/10W			
	RK07	00MNI01103110	00MNI01103110	10K OHM \pm 1% 1/10W			
	RK09	00MNI01103110	00MNI01103110	10K OHM \pm 1% 1/10W			
	RK11	00MNI01123110	00MNI01123110	12K OHM \pm 1% 1/10W			
	RK19	00MNI01103110	00MNI01103110	18K OHM \pm 1% 1/10W			
	RK45	00D2412393989	00D2412393989	RD14B2E100JT(5)			
	RK47	00D2412393989	00D2412393989	RD14B2E100JT(5)			

	Ref. No.	Part No. (for EUR)	Part No.	Part Name	Remarks	Q'ty	New
	RK49	00MNI05221110	00MNI05221110	220 OHM +- 5% 1/10W			
	RK53	00MNI05221110	00MNI05221110	220 OHM +- 5% 1/10W			
	RL06	00MNI01123110	00MNI01123110	12K OHM +- 1% 1/10W			
	RL08	00MNI01103110	00MNI01103110	10K OHM +- 1% 1/10W			
	RL10	00MNI01103110	00MNI01103110	10K OHM +- 1% 1/10W			
	RL12	00MNI01123110	00MNI01123110	12K OHM +- 1% 1/10W			
	RL20	00MNI01103110	00MNI01103110	18K OHM +- 1% 1/10W			
	RL46	00D2412393989	00D2412393989	RD14B2E100JT(5)			
	RL48	00D2412393989	00D2412393989	RD14B2E100JT(5)			
	RL50	00MNI05221110	00MNI05221110	220 OHM +- 5% 1/10W			
	RL54	00MNI05221110	00MNI05221110	220 OHM +- 5% 1/10W			
	RM05	00MNI01123110	00MNI01123110	12K OHM +- 1% 1/10W			
	RM07	00MNI01103110	00MNI01103110	10K OHM +- 1% 1/10W			
	RM09	00MNI01103110	00MNI01103110	10K OHM +- 1% 1/10W			
	RM11	00MNI01123110	00MNI01123110	12K OHM +- 1% 1/10W			
	RM19	00MNI01103110	00MNI01103110	18K OHM +- 1% 1/10W			
	RM45	00D2412393989	00D2412393989	RD14B2E100JT(5)			
	RM47	00D2412393989	00D2412393989	RD14B2E100JT(5)			
	RM49	00MNI05221110	00MNI05221110	220 OHM +- 5% 1/10W			
	RM53	00MNI05221110	00MNI05221110	220 OHM +- 5% 1/10W			
	RW01	00MNI01273110	00MNI01273110	27K OHM +- 1% 1/10W			
	RW03	00MNI01273110	00MNI01273110	27K OHM +- 1% 1/10W			
	RW08	00MNI01103110	00MNI01103110	10K OHM +- 1% 1/10W			
	RW10	00MNI01103110	00MNI01103110	10K OHM +- 1% 1/10W			
	RW14	00MNI05473110	00MNI05473110	47K OHM +- 5% 1/10W			
	RW20	00MNI01273110	00MNI01273110	27K OHM +- 1% 1/10W			
	RW46	00D2412393989	00D2412393989	RD14B2E100JT(5)			
	RW48	00D2412393989	00D2412393989	RD14B2E100JT(5)			
	RW50	00MNI05221110	00MNI05221110	220 OHM +- 5% 1/10W			
	RW54	00MNI05221110	00MNI05221110	220 OHM +- 5% 1/10W			
	RW85	nsp	nsp	RM73B-330JT +1608			
	RW87,88	nsp	nsp	RM73B-0R0KT +1608			
	RW95	nsp	nsp	RM73B-0R0KT +1608			
	RW96	nsp	nsp	RM73B-0R0KT +1608			
	RX85	nsp	nsp	RM73B-330JT +1608			
	RX87,RX88	nsp	nsp	RM73B-0R0KT +1608			
	RX95	nsp	nsp	RM73B-0R0KT +1608			
CAPACITORS GROUP							
	C801,802	00MOB47803590	00MOB47803590	4700U 35V(LAO)(LF)-BLOCK AQL-0298 ELNA			
	C803,804	00MOA107016R0	00MOA107016R0	ROA-16V 101M -H3#PE - T2 (100UF 16V)			
	C805,806	00MOA477016Z0	00MOA477016Z0	ROS-16V 471M - I6#PE - S13 (470UF 16V)			
	C807-810	nsp	nsp	CK73F1E104ZT +1608			
	CA01,02	00MOF55561570	00MOF55561570	DTG100VDC561J-FC			
	CA03-06	00MOF55821570	00MOF55821570	DTG100VDC821J-FC			
	CA07-10	00MOF55181560	00MOF55181560	DAMG630VDC181J-FC			
	CA11,12	00MOF55181560	00MOF55181560	DAMG630VDC181J-FC			
	CA13-16	00MOA227016Z0	00MOA227016Z0	ROS-16V 221M - H5#PE - T2 (220UF 16V)			
	CA19-A22	00MOA227025R0	00MOA227025R0	ROA-25V 221M -H5#PE - T2 (220UF 25V)			

Ref. No.	Part No. (for EUR)	Part No.	Part Name	Remarks	Q'ty	New
CA23,24 CA27,28	00MOA227016R0 nsp	00MOA227016R0 nsp	ROA-16V 221M -H4#PE - T2 (220UF 16V) CK73F1E104ZT +1608			
CA29 CA30 CA31 CA32 CA33	00MOA107025R0 nsp 00MOA107025R0 nsp 00MOA107025R0	00MOA107025R0 nsp 00MOA107025R0 nsp 00MOA107025R0	ROA-25V 101M -H4#PE - T2 (100UF 25V) CK73F1E104ZT +1608 ROA-25V 101M -H4#PE - T2 (100UF 25V) CK73F1E104ZT +1608 ROA-25V 101M -H4#PE - T2 (100UF 25V)			
CA34 CA35 CA36 CA37 CA38-41	nsp nsp nsp nsp nsp	00MDD95101360 00MDD95101360 00MDD95101360 00MDD95101360 nsp	100PF +- 5% UJ 100PF +- 5% UJ 100PF +- 5% UJ 100PF +- 5% UJ CK73F1E104ZT +1608			
CA42 CA45,46 CA50 CA55-58	00MOA107025R0 nsp nsp 00MOA476025Z0	00MOA107025R0 nsp nsp 00MOA476025Z0	ROA-25V 101M -H4#PE - T2 (100UF 25V) 47PF CK73F1E104ZT +1608 ROS-25V 470M - G3#PE - T2 (47UF 25V)			
CE01 CE02 CE03 CE04 CE08	00MOB33802570 00MOA47701620 00MOA47705020 00MOA10510020 00MOA47705020	00MOB33802570 00MOA47701620 00MOA47705020 00MOA10510020 00MOA47705020	3300U 25V(ALP) (LF)-BLOCK CAP 470UF 16V M RA-2 470 UF M 50V RA-2 1UF100V RA-2TYPE 470 UF M 50V RA-2			
CG01,02 CG03-06 CG07-10 CG11,12	00MOF55561570 00MOF55821570 00MOF55181560 nsp	00MOF55561570 00MOF55821570 00MOF55181560 00MDD95101360	DTG100VDC561J-FC DTG100VDC821J-FC DAMG630VDC181J-FC 100PF +- 5% UJ			
CG13-16 CG19-22 CG23,24 CG27-28 CG29	00MOA227016Z0 00MOA227025R0 00MOA227016R0 nsp 00MOA107025R0	00MOA227016Z0 00MOA227025R0 00MOA227016R0 nsp 00MOA107025R0	ROS-16V 221M - H5#PE - T2 (220UF 16V) ROA-25V 221M -H5#PE - T2 (220UF 25V) ROA-16V 221M -H4#PE - T2 (220UF 16V) CK73F1E104ZT +1608 ROA-25V 101M -H4#PE - T2 (100UF 25V)			
CG30 CG31 CG32 CG33 CG34-37	nsp 00MOA107025R0 nsp 00MOA107025R0 nsp	nsp 00MOA107025R0 nsp 00MOA107025R0 00MDD95101360	CK73F1E104ZT +1608 ROA-25V 101M -H4#PE - T2 (100UF 25V) CK73F1E104ZT +1608 ROA-25V 101M -H4#PE - T2 (100UF 25V) 100PF +- 5% UJ			
CG38,39 CG40-41 CG42 CG45,46 CG49-50	nsp nsp 00MOA107025R0 nsp nsp	nsp nsp 00MOA107025R0 nsp nsp	CK73F1E104ZT +1608 CK73F1E104ZT +1608 ROA-25V 101M -H4#PE - T2 (100UF 25V) 47PF CK73F1E104ZT +1608			
CG51	nsp	nsp	CK73F1E104ZT +1608			
CJ01 CJ03 CJ05	00MOF55561570 00MOF55821570 00MOF55821570	00MOF55561570 00MOF55821570 00MOF55821570	DTG100VDC561J-FC DTG100VDC821J-FC DTG100VDC821J-FC			
CJ07 CJ09 CJ11 CJ13 CJ15	00MOF55181560 00MOF55181560 nsp 00MOA227016Z0 00MOA227016Z0	00MOF55181560 00MOF55181560 00MDD95101360 00MOA227016Z0 00MOA227016Z0	DAMG630VDC181J-FC DAMG630VDC181J-FC 100PF +- 5% UJ ROS-16V 221M - H5#PE - T2 (220UF 16V) ROS-16V 221M - H5#PE - T2 (220UF 16V)			
CJ19,20 CJ21	00MOA227025R0 00MOF15101540	00MOA227025R0 00MOF15101540	ROA-25V 221M -H5#PE - T2 (220UF 25V) 100PF J 100V APSV			

Ref. No.	Part No. (for EUR)	Part No.	Part Name	Remarks	Q'ty	New
CK01	00MOF55561570	00MOF55561570	DTG100VDC561J-FC			
CK03	00MOF55821570	00MOF55821570	DTG100VDC821J-FC			
CK05	00MOF55821570	00MOF55821570	DTG100VDC821J-FC			
CK07	00MOF55181560	00MOF55181560	DAMG630VDC181J-FC			
CK09	00MOF55181560	00MOF55181560	DAMG630VDC181J-FC			
CK11	nsp	00MDD95101360	100PF +- 5% UJ			
CK13	00MOA227016Z0	00MOA227016Z0	ROS-16V 221M - H5#PE - T2 (220UF 16V)			
CK15	00MOA227016Z0	00MOA227016Z0	ROS-16V 221M - H5#PE - T2 (220UF 16V)			
CK19,20	00MOA227025R0	00MOA227025R0	ROA-25V 221M -H5#PE - T2 (220UF 25V)			
CK21	00MOF15101540	00MOF15101540	100PF J 100V APSV			
CL02	00MOF55561570	00MOF55561570	DTG100VDC561J-FC			
CL04	00MOF55821570	00MOF55821570	DTG100VDC821J-FC			
CL06	00MOF55821570	00MOF55821570	DTG100VDC821J-FC			
CL08	00MOF55181560	00MOF55181560	DAMG630VDC181J-FC			
CL10	00MOF55181560	00MOF55181560	DAMG630VDC181J-FC			
CL12	nsp	00MDD95101360	100PF +- 5% UJ			
CL14	00MOA227016Z0	00MOA227016Z0	ROS-16V 221M - H5#PE - T2 (220UF 16V)			
CL16	00MOA227016Z0	00MOA227016Z0	ROS-16V 221M - H5#PE - T2 (220UF 16V)			
CL19,20	00MOA227025R0	00MOA227025R0	ROA-25V 221M -H5#PE - T2 (220UF 25V)			
CL22	00MOF15101540	00MOF15101540	100PF J 100V APSV			
CM01	00MOF55561570	00MOF55561570	DTG100VDC561J-FC			
CM03	00MOF55821570	00MOF55821570	DTG100VDC821J-FC			
CM07	00MOF55181560	00MOF55181560	DAMG630VDC181J-FC			
CM09	00MOF55181560	00MOF55181560	DAMG630VDC181J-FC			
CM11	nsp	00MDD95101360	100PF +- 5% UJ			
CM13	00MOA227016Z0	00MOA227016Z0	ROS-16V 221M - H5#PE - T2 (220UF 16V)			
CM15	00MOA227016Z0	00MOA227016Z0	ROS-16V 221M - H5#PE - T2 (220UF 16V)			
CM19,20	00MOA227025R0	00MOA227025R0	ROA-25V 221M -H5#PE - T2 (220UF 25V)			
CM22	00MOF15101540	00MOF15101540	100PF J 100V APSV			
CW02	00MOF55561570	00MOF55561570	DTG100VDC561J-FC			
CW04	00MOF55821570	00MOF55821570	DTG100VDC821J-FC			
CW06	00MOF55821570	00MOF55821570	DTG100VDC821J-FC			
CW08	00MOF55181560	00MOF55181560	DAMG630VDC181J-FC			
CW10	00MOF55181560	00MOF55181560	DAMG630VDC181J-FC			
CW12	nsp	00MDD95101360	100PF +- 5% UJ			
CW14	00MOA227016Z0	00MOA227016Z0	ROS-16V 221M - H5#PE - T2 (220UF 16V)			
CW16	00MOA227016Z0	00MOA227016Z0	ROS-16V 221M - H5#PE - T2 (220UF 16V)			
CW20	00MOA227025R0	00MOA227025R0	ROA-25V 221M -H5#PE - T2 (220UF 25V)			
CW22	00MOA227025R0	00MOA227025R0	ROA-25V 221M -H5#PE - T2 (220UF 25V)			
CW2-28	nsp	nsp	CK73F1E104ZT +1608			
CW23,24	00MOA227016R0	00MOA227016R0	ROA-16V 221M -H4#PE - T2 (220UF 16V)			
CW29	00MOA107025R0	00MOA107025R0	ROA-25V 101M -H4#PE - T2 (100UF 25V)			
CW30	nsp	nsp	CK73F1E104ZT +1608			
CW31	00MOA107025R0	00MOA107025R0	ROA-25V 101M -H4#PE - T2 (100UF 25V)			
CW32	nsp	nsp	CK73F1E104ZT +1608			
CW33	00MOA107025R0	00MOA107025R0	ROA-25V 101M -H4#PE - T2 (100UF 25V)			
CW34	nsp	00MDD95101360	100PF +- 5% UJ			
CW35-37	nsp	00MDD95101360	100PF +- 5% UJ			
CW42	00MOA107025R0	00MOA107025R0	ROA-25V 101M -H4#PE - T2 (100UF 25V)			
CW45	nsp	nsp	47PF			
CX23,24	00MOA227016R0	00MOA227016R0	ROA-16V 221M -H4#PE - T2 (220UF 16V)			

	Ref. No.	Part No. (for EUR)	Part No.	Part Name	Remarks	Q'ty	New
	CX27,28 CX29	nsp 00MOA107025R0	nsp 00MOA107025R0	CK73F1E104ZT +1608 ROA-25V 101M -H4#PE - T2 (100UF 25V)			
	CX30 CX31 CX32 CX33 CX34-37	nsp 00MOA107025R0 nsp 00MOA107025R0 nsp	nsp 00MOA107025R0 nsp 00MOA107025R0 nsp	CK73F1E104ZT +1608 ROA-25V 101M -H4#PE - T2 (100UF 25V) CK73F1E104ZT +1608 ROA-25V 101M -H4#PE - T2 (100UF 25V) 100PF +- 5% UJ			
	CX38-41 CX42 CX45,46	nsp 00MOA107025R0 nsp	nsp 00MOA107025R0 nsp	CK73F1E104ZT +1608 ROA-25V 101M -H4#PE - T2 (100UF 25V) CK73F1E104ZT +1608			
OTHERS PARTS GROUP							
	121L 122L 351G	00M309V267010 00M51100308M9 00M257K109010	00M309V267010 00M51100308M9 00M257K109010	HEAT SINK SCREW SHIELD			
△	F801,802	00MFS20160200	00MFS20160200	FUSE 1.6A 250V SEMKO VDE			
△	FE01	00MFS20160200	00MFS20160200	FUSE 1.6A 250V SEMKO VDE			
	J801 J804,805 J806 J807 J808,809	00MYP06010460 00MYP0600391X 00MYP0601045X 00MYP0600384X nsp	00MYP06010460 00MYP0600391X 00MYP0601045X 00MYP0600384X nsp	B7B-EH B4B-EH-TS (LF)(SN) 4P RADIAL TAPING B5B-EH-TS (LF)(SN) 5P RADIAL TAPING B6B-EH-TS (LF)(SN) 6P RADIAL TAPING JST GND TERMINAL FOR PCB			
	JA01,02 JA03 JA51 JA52	643010023605S nsp 00D2051260004 00MYJ07019450	643010023605S nsp 00D2051260004 00MYJ07019450	1P PIN JACK(AU,shield) M1698-A NEJI TERMINAL 25P FFC BASE (9610SA 21FMN-BTRK FFC CONNECTOR 1MM			
	JE01 JG01,02	00MYJ06006220 643010023605S	00MYJ06006220 643010023605S	82B-PH-K-S (LF)(SN) 1P PIN JACK(AU,shield)			
	JW02 JG03 JG04 JG51	643010023605S nsp nsp 00MYP0600391X	643010023605S nsp nsp 00MYP0600391X	1P PIN JACK(AU,shield) M1698-A NEJI TERMINAL GND TERMINAL FOR PCB B4B-EH-TS (LF)(SN) 4P RADIAL TAPING			
	JG52 JG53 JG54 JH01,02	00MYP0601045X 00D2051260004 00MYJ07019450 00MYP04000760	00MYP0601045X 00D2051260004 00MYJ07019450 00MYP04000760	B5B-EH-TS (LF)(SN) 5P RADIAL TAPING 25P FFC BASE (9610SA 21FMN-BTRK FFC CONNECTOR 1MM CONNECTOR 2P B3P-VH			
	JX01,02 JX03,04 JX05 JX51	644010087206S nsp nsp 00MYP0600391X	644010087206S nsp nsp 00MYP0600391X	NC3MAH M1698-A NEJI TERMINAL GND TERMINAL FOR PCB B4B-EH-TS (LF)(SN) 4P RADIAL TAPING			
	JX52 JX53	00MYP0600384X 00MYJ07019450	00MYP0600384X 00MYJ07019450	B6B-EH-TS (LF)(SN) 6P RADIAL TAPING JST 21FMN-BTRK FFC CONNECTOR 1MM			

8U-37AK52000 AUDIO PWB UNIT ASSY

Ref. No.	Part No. (for EUR)	Part No.	Part Name	Remarks	Q'ty	New
SEMICONDUCTORS GROUP						
QC02	00MHF203691B0	00MHF203691B0	2SK369 BL VGDS-40V PD0.4W			
QC04	00MHF203691B0	00MHF203691B0	2SK369 BL VGDS-40V PD0.4W			
QC06	00MHX328731B0	00MHX328731B0	2SC2873 (Y)			
QC08	00MHX113121B0	00MHX113121B0	2SA1312 (B)			
QC10	00MHX113121B0	00MHX113121B0	2SA1312 (B)			
QC12	00MHX333241B0	00MHX333241B0	2SC3324 (B)			
QC14	00MHX333241B0	00MHX333241B0	2SC3324 (B)			
QC16	00MHX113121B0	00MHX113121B0	2SA1312 (B)			
QC18	00MHX333241B0	00MHX333241B0	2SC3324 (B)			
QC20	00MHX113121B0	00MHX113121B0	2SA1312 (B)			
QC22	00MHX333241B0	00MHX333241B0	2SC3324 (B)			
QC24	00D2730281906	00D2730281906	2SC2705 (O)/(Y)TPE6			
QC26	00D2710168900	00D2710168900	2SA1145 (O)/(Y)TPE6			
QC28	00MBA20035210	00MBA20035210	HN1C03F(B)(NPNX2(MUTING))			
QC30	00MBA20035210	00MBA20035210	HN1C03F(B)(NPNX2(MUTING))			
QC31	235810023600S	235810023600S	AK4399EQ			
QC36	00MBA20035210	00MBA20035210	DTC114EU			
QC38	00MBA10026210	00MBA10026210	DTA114EU			
QF01	00D2623606902	00D2623606902	PT6302-R-001(L)			
QF02-QF04	00MBA20035210	00MBA20035210	DTC114EU			
QF06	00MBA10026210	00MBA10026210	DTA114EU			
QP01,QP02	00MBA20035210	00MBA20035210	DTC114EU			
QP03,QP04	00MBA10026210	00MBA10026210	DTA114EU			
QS01-QS04	00MHF203691B0	00MHF203691B0	2SK369 BL VGDS-40V PD0.4W			
QS05, QS06	00MHX328731B0	00MHX328731B0	2SC2873 (Y)			
QS07-QS09	00MHX113121B0	00MHX113121B0	2SA1312 (B)			
QS10	00MHX113121B0	00MHX113121B0	2SA1312 (B)			
QS11-QS13	00MHX333241B0	00MHX333241B0	2SC3324 (B)			
QS14	00MHX333241B0	00MHX333241B0	2SC3324 (B)			
QS15, QS16	00MHX113121B0	00MHX113121B0	2SA1312 (B)			
QS17, QS18	00MHX333241B0	00MHX333241B0	2SC3324 (B)			
QS19, QS20	00MHX113121B0	00MHX113121B0	2SA1312 (B)			
QS21, QS22	00MHX333241B0	00MHX333241B0	2SC3324 (B)			
QS23, QS24	00D2730281906	00D2730281906	2SC2705 (O)/(Y)TPE6			
QS25, QS26	00D2710168900	00D2710168900	2SA1145 (O)/(Y)TPE6			
QS27-QS30	00MBA20035210	00MBA20035210	HN1C03F(B)(NPNX2(MUTING))			
QS31	235810023600S	235810023600S	AK4399EQ			
QS32	00MBA20035210	00MBA20035210	DTC114EU			
QS33	00MBA10026210	00MBA10026210	DTA114EU			
QS34	00MBA20035210	00MBA20035210	DTC114EU			
QS35	00MBA10026210	00MBA10026210	DTA114EU			
QS36	00MBA20035210	00MBA20035210	DTC114EU			
QS37, QS38	00MBA10026210	00MBA10026210	DTA114EU			
QS39	00MBA20035210	00MBA20035210	DTC114EU			
QT01	00D2730470908	00D2730470908	2SC4116-Y-TE85L +C			
DC02	00MHZ20018050	00MHZ20018050	1SS302 (TE85L F) (TOSHIBA)			
DC04	00MHZ20018050	00MHZ20018050	1SS302 (TE85L F) (TOSHIBA)			
DC06	00MHZ20018050	00MHZ20018050	1SS302 (TE85L F) (TOSHIBA)			
DC08	00MHZ20018050	00MHZ20018050	1SS302 (TE85L F) (TOSHIBA)			

Ref. No.	Part No. (for EUR)	Part No.	Part Name	Remarks	Q'ty	New
DC12	00MHZ21005000	00MHZ21005000	1SS301 DAN202U UMT TYPE			
DS01-DS04 DS05-DS08 DS09 DS11,DS12	00MHZ20018050 00MHZ20018050 00MHZ21005000 00MHZ21005000	00MHZ20018050 00MHZ20018050 00MHZ21005000 00MHZ21005000	1SS302 (TE85L F) (TOSHIBA) 1SS302 (TE85L F) (TOSHIBA) 1SS301 DAN202U UMT TYPE 1SS301 DAN202U UMT TYPE			
DF01,DF02 DF03 DF10	00MHI10042080 00MHZ21005000 00D2760760905	00MHI10042080 00MHZ21005000 00D2760760905	SECT1E01C-S 1SS301 DAN202U UMT TYPE MTZJ3.6B T77			
DP01 FT01 ZF01	00D3939650007 259810001507S 00MHW10004210	00D3939650007 259810001507S 00MHW10004210	LED(SPR-39MWW) nanoSMDC075F RPM6936-V4 (IR SENSOR)			
VF01	00D3938098000	00D3938098000	FL TUBE(15-BT-114GNK)			
RESISTORS GROUP						
RC06 RC08 RC10 RC12 RC14	00MNI01223110 00MNI01103110 00MNI01103110 00MNI01223110 00MNI01223110	00MNI01223110 00MNI01103110 00MNI01103110 00MNI01223110 00MNI01223110	22K OHM +- 1% 1/10W 10K OHM +- 1% 1/10W 10K OHM +- 1% 1/10W 22K OHM +- 1% 1/10W 22K OHM +- 1% 1/10W			
RC20 RC46 RC48 RC50 RC54	00MNI01273110 nsp nsp 00MNI05221110 00MNI05221110	00MNI01273110 nsp nsp 00MNI05221110 00MNI05221110	27K OHM +- 1% 1/10W RD14B2E100JT(5) RD14B2E100JT(5) 220 OHM +- 5% 1/10W 220 OHM +- 5% 1/10W			
RC85 RC87,RC88 RC95 RF01,RF02	nsp nsp nsp nsp	nsp nsp nsp nsp	RM73B-330JT +1608 RM73B-0R0KT +1608 RM73B-0R0KT +1608 RM73B-0R0KT +1608			
RF03,RF04 RF10 RF16 RF21-RF24 RF25	nsp nsp nsp nsp nsp	nsp nsp nsp nsp nsp	RM73B-102JT +1608 RM73B-132JT +1608 RM73B-102JT +1608 RM73B-0R0KT +1608 RM73B-102JT +1608			
RF81 RF82 RP03	nsp nsp nsp	nsp nsp nsp	RM73B-221JT +1608 RM73B-221JT +1608 RM73B-132JT +1608			
RS05,RS06 RS07-RS10 RS11-RS14 RS19,RS20 RS45-RS48	00MNI01223110 00MNI01103110 00MNI01223110 00MNI01273110 nsp	00MNI01223110 00MNI01103110 00MNI01223110 00MNI01273110 nsp	22K OHM +- 1% 1/10W 10K OHM +- 1% 1/10W 22K OHM +- 1% 1/10W 27K OHM +- 1% 1/10W RD14B2E100JT(5)			
RS49-RS54 RS85 RS87,RS88	00MNI05221110 nsp nsp	00MNI05221110 nsp nsp	220 OHM +- 5% 1/10W RM73B-330JT +1608 RM73B-0R0KT +1608			

Ref. No.	Part No. (for EUR)	Part No.	Part Name	Remarks	Q'ty	New
RT07	nsp	nsp	RM73B-0R0KT +1608			
RT09	nsp	nsp	RM73B-0R0KT +1608			
RT13-RT16	nsp	nsp	RM73B-0R0KT +1608			
CAPACITORS GROUP						
CC02	00MOF55561570	00MOF55561570	DTG100VDC561J-FC			
CC04	00MOF55821570	00MOF55821570	DTG100VDC821J-FC			
CC06	00MOF55821570	00MOF55821570	DTG100VDC821J-FC			
CC08	00MOF55181560	00MOF55181560	DAMG630VDC181J-FC			
CC10	00MOF55181560	00MOF55181560	DAMG630VDC181J-FC			
CC12	nsp	00MDD95101360	100PF +- 5% UJ			
CC14	00MOA227016Z0	00MOA227016Z0	ROS-16V 221M -H5#PE - T2 (220UF 16V)			
CC16	00MOA227016Z0	00MOA227016Z0	ROS-16V 221M -H5#PE - T2 (220UF 16V)			
CC20	00MOA227025R0	00MOA227025R0	ROA-25V 221M -H5#PE - T2 (220UF 25V)			
CC22	00MOA227025R0	00MOA227025R0	ROA-25V 221M -H5#PE - T2 (220UF 25V)			
CC23,CC24	00MOA227016R0	00MOA227016R0	ROA-16V 221M -H4#PE - T2 (220UF 16V)			
CC27,CC28	nsp	nsp	CK73F1E104ZT +1608			
CC29	00MOA107025R0	00MOA107025R0	ROA-25V 101M -H4#PE - T2 (100UF 25V)			
CC30	nsp	nsp	CK73F1E104ZT +1608			
CC31	00MOA107025R0	00MOA107025R0	ROA-25V 101M -H4#PE - T2 (100UF 25V)			
CC32	nsp	nsp	CK73F1E104ZT +1608			
CC33	00MOA107025R0	00MOA107025R0	ROA-25V 101M -H4#PE - T2 (100UF 25V)			
CC34-CC37	nsp	00MDD95101360	100PF +- 5% UJ			
CC42	00MOA107025R0	00MOA107025R0	ROA-25V 101M -H4#PE - T2 (100UF 25V)			
CC46	nsp	nsp	47PF			
CF01	nsp	nsp	CK73F1E104ZT +1608			
CF03	nsp	nsp	CK73F1E104ZT +1608			
CF04	00D2570504966	00D2570504966	CC73CH1H390JT +1608			
CF05	nsp	nsp	CK73F1E104ZT +1608			
CF06	00D2574012917	00D2574012917	CE67C1C220MT (RV2) +REF			
CF07,CF08	nsp	nsp	CK73F1E104ZT +1608			
CF09	nsp	nsp	CK73F1E104ZT +1608			
CF10	nsp	00MDK96331300	330PF (GR39)			
CF11	00D2574012917	00D2574012917	CE67C1C220MT (RV2) +REF			
CF12-CF15	00D2570504966	00D2570504966	CC73CH1H390JT +1608			
CP01,CP02	nsp	nsp	CK73F1E104ZT +1608			
CP03,CP04	nsp	nsp	CK73F1E104ZT +1608			
CS01,CS02	00MOF55561570	00MOF55561570	DTG100VDC561J-FC			
CS03-CS06	00MOF55821570	00MOF55821570	DTG100VDC821J-FC			
CS07-CS10	00MOF55181560	00MOF55181560	DAMG630VDC181J-FC			
CS11,CS12	nsp	00MDD95101360	100PF +- 5% UJ			
CS13-CS16	00MOA227016Z0	00MOA227016Z0	ROS-16V 221M -H5#PE - T2 (220UF 16V)			
CS19-CS22	00MOA227025R0	00MOA227025R0	ROA-25V 221M -H5#PE - T2 (220UF 25V)			
CS23,CS24	00MOA227016R0	00MOA227016R0	ROA-16V 221M -H4#PE - T2 (220UF 16V)			
CS27,CS28	nsp	nsp	CK73F1E104ZT +1608			
CS29	00MOA107025R0	00MOA107025R0	ROA-25V 101M -H4#PE - T2 (100UF 25V)			
CS30	nsp	nsp	CK73F1E104ZT +1608			
CS31	00MOA107025R0	00MOA107025R0	ROA-25V 101M -H4#PE - T2 (100UF 25V)			
CS32	nsp	nsp	CK73F1E104ZT +1608			
CS33	00MOA107025R0	00MOA107025R0	ROA-25V 101M -H4#PE - T2 (100UF 25V)			
CS34	nsp	00MDD95101360	100PF +- 5% UJ			

Ref. No.	Part No. (for EUR)	Part No.	Part Name	Remarks	Q'ty	New
CS35-CS37	nsp	00MDD95101360	100PF +- 5% UJ			
CS38-CS40 CS42 CS45,CS46 CT01-CT03	nsp 00MOA107025R0 nsp nsp	nsp 00MOA107025R0 nsp nsp	CK73F1E104ZT +1608 ROA-25V 101M -H4#PE - T2 (100UF 25V) 47PF CK73F1E104ZT +1608			
CT04	00MOA47601620	00MOA47601620	47 UF M 16V RA-2			
OTHERS PARTS GROUP						
100B	471510027005M	471510027005M	BUFFER IR UO9004 37AK			
202L 210L	00D4610991026 00D4610415007	00D4610991026 00D4610415007	RUBBER SHEET RUBBER SHEET			
J852,J853	00MYP0600391X	00MYP0600391X	B4B-EH-TS (LF)(SN) 4P RADIAL TAPING			
JC02	643010023605S	643010023605S	1P PIN JACK(AU,shield)			
JS01,JS02	643010023605S	643010023605S	1P PIN JACK(AU,shield)			
JF01 JF02 JF03 JF04 JF05	645010030500S 00MYJ06006440 00MYJ06006430 00MYJ06006450 00D2051397003	645010030500S 00MYJ06006440 00MYJ06006430 00MYJ06006450 00D2051397003	40P FFC BASE(FY-BMGB-TB) S4B-PH-K-S (LF)(SN) S3B-PH-K-S (LF)(SN) S5B-PH-K-S (LF)(SN) 18P FFC BASE(9610SA)			
JF06,JF07 JF08	645010030500S 00MYJ06006420	645010030500S 00MYJ06006420	40P FFC BASE(FY-BMGB-TB) S2B-PH-K-S (LF)(SN)			
JP03 JP04	00MYJ06006430 00MYJ06006450	00MYJ06006430 00MYJ06006450	S3B-PH-K-S (LF)(SN) S5B-PH-K-S (LF)(SN)			
JS03 JS10,JS11 JS52 JS53	nsp nsp 00MYP0601045X 00MYJ07019450	nsp nsp 00MYP0601045X 00MYJ07019450	M1698-A NEJI TERMINAL GND TERMINAL FOR PCB B5B-EH-TS (LF)(SN) 5P RADIAL TAPING 21FMN-BTRK FFC CONNECTOR 1MM			
JS54	00MYP0601045X	00MYP0601045X	B5B-EH-TS (LF)(SN) 5P RADIAL TAPING			
JT01 JT02,JT03 JT05	644810076505S nsp 00D2051397003	644810076505S nsp 00D2051397003	SDK-9BNS-K13-GN(LF)(SN) M1698 PWB GND TERMINAL WITH M3 18P FFC BASE(9610SA)			
SF01-SF06 SP01-SP05 SP06	00MSP01013370 00MSP01013370 00MSP01013370	00MSP01013370 00MSP01013370 00MSP01013370	EVQ11L05R H/5MM 160GF EVQ11L05R H/5MM 160GF EVQ11L05R H/5MM 160GF			

8U-37AK530002 POWER PWB UNIT ASSY(U model)
 8U-37AK530003 POWER PWB UNIT ASSY(N, S, R model)



Ref. No.	Part No. (for EUR)	Part No.	Part Name	Remarks	Q'ty	New
SEMICONDUCTORS GROUP						
IC101	231810041507S	231810041507S	SI-8005Q-TL	for N, S, R		
IC103	231010029703S	231010029703S	STRY6476			
IC103	231010030703S	231010030703S	STRY6456			
IC104	231810040504S	231810040504S	MAX8577EU8+T			
IC106	00D2631283906	00D2631283906	KIA7809AF			
IC107	231810041507S	231810041507S	SI-8005Q-TL			
IC108	00D2623047008	00D2623047008	PC123Y22			
IC110	00D2631244000	00D2631244000	KIA78D05PI-U/P			
IC111	00D2631240907	00D2631240907	BA33B00FP-E2			
IC403	00D2623571901	00D2623571901	HIN202EIBNZ-T			
IC404	00D2622580906	00D2622580906	CXA1511M +C			
TR101,TR102	00D2730468907	00D2730468907	KTC3199-GRAT/P			
TR103	00D2690082902	00D2690082902	DTC114EKT96 +C			
TR104	00D2730464901	00D2730464901	KTC3875S-GRRTK/P			
TR105,TR106	222850007501S	222850007501S	TPCA8012-H			
TR107	00D2690082902	00D2690082902	DTC114EKT96 +C			
TR113	00D2730464901	00D2730464901	KTC3875S-GRRTK/P			
TR115	00D2730464901	00D2730464901	KTC3875S-GRRTK/P			
TR301,TR302	00D2690192902	00D2690192902	KRC102S-RTK/P (10K-10K)			
TR303	00D2690184907	00D2690184907	KRA102S-RTK/P (10K-10K)			
TR304	00D2740188905	00D2740188905	2SD1858TV2(Q/R)			
TR305,TR306	00D2690192902	00D2690192902	KRC102S-RTK/P (10K-10K)			
TR307	00D2690184907	00D2690184907	KRA102S-RTK/P (10K-10K)			
TR308	00D2740188905	00D2740188905	2SD1858TV2(Q/R)			
TR401	00D2690055900	00D2690055900	DTA144EKT96 +C			
TR402	00D2690054901	00D2690054901	DTC144EKT96 +C			
TR403	00D2720160901	00D2720160901	2SB1132T100Q +C			
TR404	00D2690054901	00D2690054901	DTC144EKT96 +C			
TR413	00D2720025907	00D2720025907	2SB562(C)TF			
D101	203050014100S	203050014100S	RBV-406H			
D102,D103	00D2760717903	00D2760717903	1SS355 TE-17 +C			
D104	203850008503S	203850008503S	SJPX-F2			
D105	00D2760758001	00D2760758001	SARS03			
D107	203850008503S	203850008503S	SJPX-F2			
D108,D109	00D2760750902	00D2760750902	RB521S-30TE61 +REF			
D110	203850008503S	203850008503S	SJPX-F2			
D111	204050011708S	204050011708S	FME-210B			
D112-D117	00D2760750902	00D2760750902	RB521S-30TE61 +REF			
D118,D119	00D2760750902	00D2760750902	RB521S-30TE61 +REF			
D120	00D2760717903	00D2760717903	1SS355 TE-17 +C			
D123	00D2760717903	00D2760717903	1SS355 TE-17 +C			
D124,D125	203850012502S	203850012502S	SJPB-L4			
D131	00D2760717903	00D2760717903	1SS355 TE-17 +C			
D133,D134	203850008503S	203850008503S	SJPX-F2			
D135	00D2760717903	00D2760717903	1SS355 TE-17 +C			
D137	203850012502S	203850012502S	SJPB-L4			
D301	00D2760717903	00D2760717903	1SS355 TE-17 +C			
D302	00D2760794900	00D2760794900	KDS160-RTK/P			
D303	00D2760717903	00D2760717903	1SS355 TE-17 +C			
D304	00D2760794900	00D2760794900	KDS160-RTK/P			

Ref. No.	Part No. (for EUR)	Part No.	Part Name	Remarks	Q'ty	New
ZD101	00D2760798922	00D2760798922	UDZS18B-TE17			
ZD102	00D2760798948	00D2760798948	UDZS8.2B-TE17			
ZD103	00D2631185907	00D2631185907	TL431ACLP			
ZD108,ZD109	00D2760683998	00D2760683998	UDZS16B-TE17 +C			
ZD110	00D2760798919	00D2760798919	UDZS6.8B-TE17			
ZD111	00D2760683998	00D2760683998	UDZS16B-TE17 +C			
ZD112	00D2760798919	00D2760798919	UDZS6.8B-TE17			
ZD302	00D2760798919	00D2760798919	UDZS6.8B-TE17			
ZD304	00D2760798919	00D2760798919	UDZS6.8B-TE17			
RESISTORS GROUP						
R102	00D2432094080	00D2432094080	RW99=3DR39JF	for N, S, R		
R103	00D2432094006	00D2432094006	RW99=3DR12JF			
R103	00D2432094080	00D2432094080	RW99=3DR39JF	for N, S, R		
R106	nsp	nsp	RM73B-102JT +1608			
R107	129550006510S	129550006510S	RM73B2B473JT			
R109	00D2442055954	00D2442055954	RS1483A151JNBST(S)			
R110	00D2442686909	00D2442686909	RS1483D154JNBST(S)			
R113	129550006510S	129550006510S	RM73B2B473JT	for N, S, R		
R113	129550006510S	129550006510S	RM73B2B473JT			
R114	nsp	nsp	RM73B2B100JT +3216			
R115,R116	nsp	nsp	RM73B-102JT +1608			
R119	nsp	nsp	RM73B-102JT +1608			
R123	nsp	nsp	RM73B-0R0KT +1608			
R124	nsp	nsp	RM73B-152JT +1608			
R131	nsp	nsp	RM73B-4R7FJ(RP1608 1/8) +1608			
R138	nsp	nsp	RM73B-2R2FJ(RP1608 1/8) +1608			
R140	nsp	nsp	RM73B-0R0KT +1608			
R146	nsp	nsp	RM73B-102JT +1608			
R150	nsp	nsp	RM73B-102JT +1608			
R152-R154	nsp	nsp	RM73B-0R0KT +1608			
R158-R160	nsp	nsp	RM73B-0R0KT +1608			
R161	nsp	nsp	RM73B-0R0KT +1608			
R185	nsp	nsp	RM73B-0R0KT +1608			
R301-R306	nsp	nsp	RM73B-0R0KT +1608			
R308	nsp	nsp	RM73B-0R0KT +1608			
R309,R310	nsp	nsp	RM73B-0R0KT +1608			
R311	nsp	nsp	RM73B-102JT +1608			
R312,R313	nsp	nsp	RM73B-0R0KT +1608			
R315-R317	nsp	nsp	RM73B-0R0KT +1608			
R318	nsp	nsp	RM73B-102JT +1608			
R327	nsp	nsp	RM73B-0R0KT +1608			
R495,R496	nsp	nsp	RM73B-102JT +1608			
R497	nsp	nsp	RM73B-0R0KT +1608			
R498,R499	nsp	nsp	RM73B-0R0KT +1608			
R501	nsp	nsp	RM73B-0R0KT +1608			
R502	nsp	nsp	RM73B-102JT +1608			
R504	nsp	nsp	RM73B-102JT +1608			
R505	nsp	nsp	RM73B-102JT +1608			
R508	nsp	nsp	RM73B-102JT +1608			
R510	nsp	nsp	RM73B-102JT +1608			
R513-R517	nsp	nsp	RM73B-0R0KT +1608			

△

△

△

Ref. No.	Part No. (for EUR)	Part No.	Part Name	Remarks	Q'ty	New
CAPACITORS GROUP						
C101	00D2538026703	00D2538026703	CK45E2EAC472MC			
C102	00D2568039029	00D2568039029	CF99-2EAC334K(LEMX)			
C103,C104	nsp	nsp	RM73B-0R0KT +1608			
C105	00D2544722949	00D2544722949	CE04W1H010MT(GR)			
C106	nsp	nsp	CK73B1H102KT +1608			
C107,C108	00D2538035710	00D2538035710	CK45E2EAC222MC(KY)	for N, S, R		
C107,C108	00D2538035710	00D2538035710	CK45E2EAC222MC(KY)			
C109	00D2544708701	00D2544708701	CE04W1V471MC J20(KY)	for N, S, R		
C110	00D2538035710	00D2538035710	CK45E2EAC222MC(KY)			
C110	00D2538035710	00D2538035710	CK45E2EAC222MC(KY)			
C111,C112	00D2568039029	00D2568039029	CF99-2EAC334K(LEMX)			
C113	00D2538035710	00D2538035710	CK45E2EAC222MC(KY)			
C114	00D2538029713	00D2538029713	CK45F2EAC471KC(KX)			
C115,C116	00D2538035710	00D2538035710	CK45E2EAC222MC(KY)			
C117	134010168233S	134010168233S	CE68W2G181M Q35(KMM)	for N, S, R		
C117	134010168219S	134010168219S	CE68W2D471M Q30(KMM)			
C118	00D2538026703	00D2538026703	CK45E2EAC472MC			
C119	00D2544708701	00D2544708701	CE04W1V471MC J20(KY)	for N, S, R		
C120	132050023202S	132050023202S	CK45B3D471KC(DEHR)			
C120	132050024205S	132050024205S	CK45B3D102KC(DEHR)			
C122	00D2570520911	00D2570520911	CK73B1A224KT +1608			
C123	00D2568039029	00D2568039029	CF99-2EAC334K(LEMX)			
C124	134050069402S	134050069402S	CE04W2A270MT HB5(KY)			
C126	00D2544524972	00D2544524972	CE04W1H4R7MT SMG/RE3			
C128	132510036571S	132510036571S	CK73B2J153KT(3216)			
C129	nsp	nsp	CK73B1H472KT +1608			
C130	00D2538029700	00D2538029700	CK45F2EAC222MC (KX)			
C131	nsp	nsp	CK73F1E104ZT +1608			
C132,C133	nsp	nsp	CK73B1E223KT +1608			
C134	nsp	nsp	CK73B1H225KT			
C135	134050069402S	134050069402S	CE04W2A270MT HB5(KY)			
C136	00D2544711918	00D2544711918	CE04W1A221MT F11(KY)			
C137	00D2534548706	00D2534548706	CC45R3A102KC			
C138	nsp	nsp	CK73B1H102KT +1608			
C139	nsp	nsp	CK73B1C473KT +1608			
C140	00D2544758706	00D2544758706	CE04W1V272MC LP1(KY)			
C141	00D2544721995	00D2544721995	CE04W1V102MT(GR)			
C142-C144	nsp	nsp	CK73B1H103KT (1608) +1608			
C145	nsp	nsp	CK73B1H225KT			
C146	nsp	nsp	CK73B1H103KT (1608) +1608			
C147	nsp	nsp	CK73B1H102KT +1608			
C148	nsp	nsp	CK73B1H225KT			
C149	nsp	nsp	CK73B1H225KT			
C150	nsp	nsp	CK73F1E104ZT +1608			
C151	00D2544758706	00D2544758706	CE04W1V272MC LP1(KY)			
C152	00D2544755903	00D2544755903	CE04W1H560MT(KY)			
C153,C154	nsp	nsp	CK73B1H102KT +1608			
C156	00D2544806700	00D2544806700	CE04W1C222MC K25(KY)			
C157	nsp	nsp	CK73B1H225KT			
C158	nsp	nsp	CK73F1E104ZT +1608			
C159	nsp	nsp	CK73B1H102KT +1608			
C160	00D2544708701	00D2544708701	CE04W1V471MC J20(KY)			
C161	00D2544718940	00D2544718940	CE04W1C101MT(GR)			
C162	nsp	nsp	CK73F1E104ZT +1608			

△

△

△

△

	Ref. No.	Part No. (for EUR)	Part No.	Part Name	Remarks	Q'ty	New
	C165 C166,C167	nsp 00D2544718940	nsp 00D2544718940	CK73B1H225KT CE04W1C101MT(GR)			
	C168 C170,C171 C172 C173 C174	nsp nsp 00D2544718940 nsp nsp	nsp nsp 00D2544718940 nsp nsp	CK73F1E104ZT +1608 CK73F1E104ZT +1608 CE04W1C101MT(GR) CK73R1H104KT (1608) CK73B1H102KT +1608			
	C176 C177 C178,C179 C180 C182	nsp nsp 132550039509S nsp nsp	nsp nsp 132550039509S nsp nsp	CK73B1H103KT (1608) +1608 CK73B1A106KT +2125 CK73X7R1H225KT(GRM_3216) CK73R1H104KT (1608) CK73R1H104KT (1608)			
	C184 C185 C186 C187 C188	nsp nsp 132550039509S nsp nsp	nsp nsp 132550039509S nsp nsp	CC73CH1E681JT +1608 CK73B1E104KT +1608 CK73X7R1H225KT(GRM_3216) CK73R1H103KT (1608) CK73B1H225KT			
	C189-C191 C192,C193 C194,C195 C197 C199	nsp 00D2544708701 132550039509S nsp nsp	nsp 00D2544708701 132550039509S nsp nsp	CK73B1H103KT (1608) +1608 CE04W1V471MC J20(KY) CK73X7R1H225KT(GRM_3216) CK73B1H102KT +1608 CK73B1H102KT +1608			
	C200 C201 C202 C203 C204	nsp nsp nsp nsp nsp	nsp nsp nsp nsp nsp	GRM32EB31C476KE15L CK73F1E104ZT +1608 CK73B1H103KT (1608) +1608 CK73F1E104ZT +1608 CK73B1H103KT (1608) +1608			
	C206 C207 C208 C209 C210	nsp nsp nsp nsp nsp	nsp nsp nsp nsp nsp	CK73B1E333KT +1608 CC73CH1H102JT +1608 CK73B1A106KT +2125 CK73B1E104KT +1608 CK73B1A106KT +2125			
	C211,C212 C213 C214 C215-C218 C220,C221	134050072101S nsp nsp nsp nsp	134050072101S nsp nsp nsp nsp	CE04W1A222M(HZ) CK73F1E104ZT +1608 CK73B1H103KT (1608) +1608 CK73F1E104ZT +1608 CK73B1H103KT (1608) +1608			
	C222 C223,C224 C226 C227 C228	nsp nsp nsp nsp nsp	nsp nsp nsp nsp nsp	CK73B1H102KT +1608 CK73F1E104ZT +1608 CK73B1H103KT (1608) +1608 CK73F1E104ZT +1608 CK73B1H103KT (1608) +1608			
	C229 C230 C231 C232-C234 C235	nsp nsp 132510036571S nsp nsp	nsp nsp 132510036571S nsp nsp	CK73B1E104KT +1608 CK73B1H103KT (1608) +1608 CK73B2J153KT(3216) CK73B1H103KT (1608) +1608 CK73B1H102KT +1608			
	C236 C237,C238 C241 C242 C247-C249	nsp nsp nsp nsp nsp	nsp nsp nsp nsp nsp	CK73B1H225KT CK73B1A106KT +2125 CK73B1E104KT +1608 CK73B1H103KT (1608) +1608 CK73B1A106KT +2125			
	C251 C252 C253	nsp nsp nsp	nsp nsp nsp	CK73B1H103KT (1608) +1608 CK73B1H102KT +1608 CC73CH1H101JT +1608			

	Ref. No.	Part No. (for EUR)	Part No.	Part Name	Remarks	Q'ty	New
	C254	nsp	nsp	CK73B1H103KT (1608) +1608			
	C255	nsp	nsp	CK73B1H102KT +1608			
	C256	nsp	nsp	CC73CH1H101JT +1608			
	C257	nsp	nsp	CK73B1H103KT (1608) +1608			
	C258	nsp	nsp	CK73B1H102KT +1608			
	C259,C260	nsp	nsp	CC73CH1H101JT +1608			
	C261	nsp	nsp	CC73CH1H102JT +1608			
	C262	nsp	nsp	CK73B1H103KT (1608) +1608			
	C263	00D2544717925	00D2544717925	CE04W1A101MT(GR)			
	C264	nsp	nsp	CK73F1E104ZT +1608			
	C265	nsp	nsp	CC73CH1H101JT +1608			
	C266,C267	nsp	nsp	CK73B1H102KT +1608			
	C268,C269	nsp	nsp	CC73CH1H101JT +1608			
	C270	nsp	nsp	CK73B1H102KT +1608			
	C271	nsp	nsp	CK73B1H222KT +1608			
	C272,C273	nsp	nsp	CK73B1H102KT +1608			
	C274	nsp	nsp	GRM32EB31C476KE15L			
	C275	nsp	nsp	CK73B1H103KT (1608) +1608			
	C276	nsp	nsp	CK73B1H102KT +1608			
	C277,C278	nsp	nsp	GRM32EB31C476KE15L			
	C279	nsp	nsp	CK73B1H102KT +1608			
	C280	nsp	nsp	CK73B1H103KT (1608) +1608			
	C281	nsp	nsp	CK73B1H102KT +1608			
	C282,C283	nsp	nsp	CK73B1H103KT (1608) +1608			
	C284	nsp	nsp	CK73B1E104KT +1608			
	C285	nsp	nsp	CK73B1H103KT (1608) +1608			
	C286	nsp	nsp	CK73B1H102KT +1608			
	C287	nsp	nsp	CK73B1H103KT (1608) +1608			
	C288	nsp	nsp	CK73B1E104KT +1608			
	C292,C293	nsp	nsp	CK73B1H225KT			
	C301	nsp	nsp	CK73F1E104ZT +1608			
	C302	nsp	nsp	CK73B1H103KT (1608) +1608			
	C303-C305	nsp	nsp	CK73F1E104ZT +1608			
	C308	00D2544718937	00D2544718937	CE04W1C470MT(GR)			
	C309	nsp	nsp	CK73B1H103KT (1608) +1608			
	C310	nsp	nsp	CK73B1H102KT +1608			
	C311	nsp	nsp	CC73CH1H101JT +1608			
	C312	nsp	nsp	CK73F1E104ZT +1608			
	C313	nsp	nsp	CK73B1H103KT (1608) +1608			
	C314-C316	nsp	nsp	CK73F1E104ZT +1608			
	C319	00D2544718937	00D2544718937	CE04W1C470MT(GR)			
	C320	nsp	nsp	CK73B1H103KT (1608) +1608			
	C321	nsp	nsp	CK73B1H102KT +1608			
	C322,C323	nsp	nsp	CC73CH1H101JT +1608			
	C324	nsp	nsp	CC73CH1H102JT +1608			
	C325	nsp	nsp	CK73B1H103KT (1608) +1608			
	C326	nsp	nsp	CC73CH1H101JT +1608			
	C327	nsp	nsp	CC73CH1H102JT +1608			
	C328	nsp	nsp	CK73B1H103KT (1608) +1608			
	C329	nsp	nsp	CC73CH1H101JT +1608			
	C330	nsp	nsp	CC73CH1H102JT +1608			
	C331	nsp	nsp	CK73B1H103KT (1608) +1608			
	C332	nsp	nsp	CC73CH1H101JT +1608			
	C333	nsp	nsp	CC73CH1H102JT +1608			
	C334	nsp	nsp	CK73B1H103KT (1608) +1608			

Ref. No.	Part No. (for EUR)	Part No.	Part Name	Remarks	Q'ty	New
C443,C444 C445,C446	nsp nsp	nsp nsp	RM73B-0R0KT +1608 CC73CH1H101JT +1608			
C447 C449 C450 C451 C453-C456	nsp nsp nsp nsp 00D2544722907	nsp nsp nsp nsp 00D2544722907	RM73B-0R0KT +1608 CK73B1H103KT (1608) +1608 CK73B1H102KT +1608 CK73B1H103KT (1608) +1608 CE04W1H0R1MT(GR)			
C457 C458 C459 C460 C461	00D2544718937 nsp 00D2544722949 00D2544718937 nsp	00D2544718937 nsp 00D2544722949 00D2544718937 nsp	CE04W1C470MT(GR) CK73B1H103KT (1608) +1608 CE04W1H010MT(GR) CE04W1C470MT(GR) CK73F1E104ZT +1608			
C462 C463,C464 C466 C468 C469	nsp nsp nsp nsp nsp	nsp nsp nsp nsp nsp	CC73CH1H101JT +1608 CK73B1H103KT (1608) +1608 CK73B1H103KT (1608) +1608 CC73CH1H101JT +1608 CC73CH1H102JT +1608			
C470 C471 C472 C473 C703,C704	nsp nsp nsp nsp nsp	nsp nsp nsp nsp nsp	CK73B1H103KT (1608) +1608 CC73CH1H101JT +1608 CC73CH1H102JT +1608 CK73B1H103KT (1608) +1608 CK73B1H225KT			
OTHERS PARTS GROUP						
AS102 AS103 AS105	447310015018S 00D4170706007 00D4170476023	447310015018S 00D4170706007 00D4170476023	RADIATOR(PUE36-30) RADIATOR (PUE36) RADIATOR			
CW031 CX021 CX023	612050152002S 00D2050581001 00D2050581085	612050152002S 00D2050581001 00D2050581085	3P 290mm PH-SAN 2P VH CON BASE (White) 2P VH CON BASE (Blue)			
CX023 CX041 CX151 CY032	00D2051093006 00D2050343045 00D2050343045 00D2050321038	00D2051093006 00D2050343045 00D2050343045 00D2050321038	2P VH CONNECTOR BASA 4P CONN.BASE(KRPH) 15P CONN.BASE(KRPH) 3P CONNE.BASE(RED)	for N, S, R for U		
CY033 CY044 CY051 CY062 CY082	00D2050343032 00D2050653049 00D2050653052 00D2050653065 645010026600S	00D2050343032 00D2050653049 00D2050653052 00D2050653065 645010026600S	3P CONN.BASE(KRPH) 4P VH CON.BASE 5P VH CONNECTOR BASE 6P VH CONNECTOR BASE 8P_FFC_BASE(9610SA)			
△ F101 FB401-FB405	00D2061099045 00D2350147909	00D2061099045 00D2350147909	FUSE(02153.15MXP/250V) E.FIL(BLM21PG221SN1)+2125			
FF101 FH101 JK401,JK402	00D2020040909 00D2020040909 00D2048260004	00D2020040909 00D2020040909 00D2048260004	FUSE CLIP(TAPE) FUSE CLIP(TAPE) MINI JACK			
JK403 L101	00D2051305008 00D2390040011	00D2051305008 00D2390040011	9P DSUB CONNECTOR L.FILTER(HR28RE183)			
				for N, S, R		

	Ref. No.	Part No. (for EUR)	Part No.	Part Name	Remarks	Q'ty	New
	L101	00D2390038023	00D2390038023	L.FILTER(HR28RE332)			
	L102	111010010249S	111010010249S	INDUCTOR(PC13-3R9N)			
	L103	111810014502S	111810014502S	INDUCTOR 10UH(7E10H)			
	L104	00D2350185903	00D2350185903	INDUCTOR 47UH(7E10H)			
	L105	111810020507S	111810020507S	CDEP147NP-5R9MC73			
	RL101	00D2140242001	00D2140242001	RELAY(DLS9D1-O_M)			
	RL102	682010007608S	682010007608S	RELAY(DQ12D1-0(M))			
	RL103	00D2140222908	00D2140222908	RELAY(E2-24N35) +REF			
	RL104	682010007608S	682010007608S	RELAY(DQ12D1-0(M))			
	ST101	00D2050452017	00D2050452017	STYLE PIN			
△	T101	102010009009S	102010009009S	SW_TRANS(E2 3912)	for N, S, R		△
△	T102	00D2336614003	00D2336614003	POWER TRANS(MINI/E3)	for U		
△	T102	00D2336615002	00D2336615002	POWER TRANS(MINI/E2)	for N, S, R		△
	TH101	252010002200S	252010002200S	NTPAN4R0LDKB0			
	W101,W102	nsp	nsp	GND TERMINAL FOR PCB			
	W105	nsp	nsp	GND TERMINAL FOR PCB			
	W107-W111	nsp	nsp	GND TERMINAL FOR PCB			
	W112	nsp	nsp	GND TERMINAL FOR PCB			
	W301,W302	nsp	nsp	GND TERMINAL FOR PCB			
	W405	00D2051034007	00D2051034007	M3 SCREW TERMINAL			
	W407	00D2051034007	00D2051034007	M3 SCREW TERMINAL			
		0RD4700051009	0RD4700051009	3X8 CPS(SW,W) ZNP			
		00D4610991026	00D4610991026	RUBBER SHEET			

8U-37AK550002 MAIN PWB UNIT ASSY(U model)
 8U-37AK550003 MAIN PWB UNIT ASSY(N model)
 8U-37AK550004 MAIN PWB UNIT ASSY(S model)
 8U-37AK550005 MAIN PWB UNIT ASSY(R model)

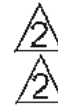

Ref. No.	Part No. (for EUR)	Part No.	Part Name	Remarks	Q'ty	New
SEMICONDUCTORS GROUP						
IC101	nsp	nsp	R8A340198G			
IC105	nsp	nsp	K4T1G084QQ-HCE6			
IC106	nsp	nsp	LP2996MX			
IC107	nsp	nsp	K4T51163QG-HCE6			
IC108	nsp	nsp	K4T51163QG-HCE6			
IC109	nsp	nsp	LP2996MX			
IC110	nsp	nsp	BE ROM SUB ASSY (S29GL01GP11TFCR20#)			
IC112	nsp	nsp	SN74LVC1G08DBV +C			
IC200	nsp	nsp	RTL8201CP			
IC201	nsp	nsp	SN74LV594APWR			
IC202,203	nsp	nsp	TC74VHC244FT			
IC204	nsp	nsp	SN74LV594APWR			
IC205,206	nsp	nsp	EN5336QI-T			
IC207	nsp	nsp	EN5322QI-T			
IC208	nsp	nsp	EN5366QI-T			
IC351	nsp	nsp	EP3C40F484C8N			
IC352	nsp	nsp	BA258C0FP-E2			
IC354	nsp	nsp	EPCS16S18N			
IC355	nsp	nsp	RN5RZ50B-TR			
IC451	nsp	nsp	W9864G2GH-6			
IC452	nsp	nsp	ADSP21367KSWZ2AA1UD1			
IC453	nsp	nsp	DSP1 ROM SUB ASSY (W19B160BBT7H)			
IC551	nsp	nsp	W9864G2GH-6			
IC552	nsp	nsp	ADSP21367KSWZ2AA1UD2			
IC553	nsp	nsp	DSP2 ROM SUB ASSY (W19B160BBT7H)			
IC602	nsp	nsp	FCXO-05B(22.5792MHz)			
IC609	nsp	nsp	FCXO-05B(24.576MHz)			
IC651	nsp	nsp	AK4101AVQ			
IC652	nsp	nsp	LC89057W-VF4A			
IC656	nsp	nsp	GP1FAV55TK0F			
IC703	nsp	nsp	BD18KA5FP-E2			
IC704-706	nsp	nsp	BU7331EKN-E2			
IC707	nsp	nsp	SN74LVC04APW-EL2			
IC708	nsp	nsp	SN74LVC157APW-EL2 +C			
IC709	nsp	nsp	SN74LVC157APW-EL2 +C			
IC710	nsp	nsp	SN74LVC157APW-EL2 +C			
IC714	nsp	nsp	SN74LVC74APWR			
IC715	nsp	nsp	SM8707HV-G-E2			
IC718	nsp	nsp	BU2365FV-E2			
IC719	nsp	nsp	SM5158AM-G-E2			
IC851	nsp	nsp	BD4730G-TR			
IC852	nsp	nsp	S-24CS08AFJ-TB +C			
IC853	nsp	nsp	SYSTEM ROM SUB ASSY (R5F364VDNFB)			
IC854	nsp	nsp	SN74LVC157APW-EL2 +C			
IC855	nsp	nsp	SN74LVC157APW-EL2 +C			
TR301,302	nsp	nsp	KRC102S-RTK/P (10K-10K)			
TR451	nsp	nsp	KRC102S-RTK/P (10K-10K)			
TR452,453	nsp	nsp	KRA102S-RTK/P (10K-10K)			

NOTE :
 When update Firmware, please
 confirm a last version in SDI.
 Use the service board after
 updating it.

	Ref. No.	Part No. (for EUR)	Part No.	Part Name	Remarks	Q'ty	New
	TR454	nsp	nsp	KRC102S-RTK/P (10K-10K)			
	TR551	nsp	nsp	KRC102S-RTK/P (10K-10K)			
	TR552	nsp	nsp	KRA102S-RTK/P (10K-10K)			
	TR651	nsp	nsp	2SC2412K_T146R			
	TR851	nsp	nsp	DTC144EKT96 +C			
	TR852	nsp	nsp	2SB1132T100Q +C			
	D851	nsp	nsp	1SS355 TE-17 +C			
	D906	nsp	nsp	1SS355 TE-17 +C			
	D900-903	nsp	nsp	RB521S-30TE61 +REF			
RESISTORS GROUP							
	R101-103	nsp	nsp	RM73B-472JT+1005			
	R104-107	nsp	nsp	RM73B-820FT(1005)			
	R108	nsp	nsp	RM73B-102JT			
	R109-114	nsp	nsp	RM73B-473JT+1005			
	R115	nsp	nsp	RM73B-0R0KT+1005			
	R150-157	nsp	nsp	RM73B-220JT+1005			
	R158,159	nsp	nsp	RM73B-101JT+1005			
	R160R-163	nsp	nsp	RM73B-820FT(1005)			
	R203-206	nsp	nsp	RM73B-820FT(1005)			
	R250	nsp	nsp	RM73B-472JT+1005			
	R252	nsp	nsp	RM73B-472JT+1005			
	R254-260	nsp	nsp	RM73B-220JT+1005			
	R262,264	nsp	nsp	RM73B-472JT+1005			
	R265-267	nsp	nsp	RM73B-472JT+1005			
	R269	nsp	nsp	RM73B-220JT+1005			
	R270-272	nsp	nsp	RM73B-0R0KT+1005			
	R300,301	nsp	nsp	RM73B-473JT+1005			
	R302	nsp	nsp	RM73B-473JT+1005			
	R304	nsp	nsp	RM73B-473JT+1005			
	R306	nsp	nsp	RM73B-473JT+1005			
	R308	nsp	nsp	RM73B-102JT			
	R311	nsp	nsp	RM73B-0R0KT+1005			
	R315-321	nsp	nsp	RM73B-220JT+1005			
	R329	nsp	nsp	RM73B-220JT+1005			
	R336R	nsp	nsp	RM73B-0R0KT+1005			
	R338	nsp	nsp	RM73B-220JT+1005			
	R339	nsp	nsp	RM73B-472JT+1005			
	R341	nsp	nsp	RM73B-472JT+1005			
	R342,343	nsp	nsp	RM73B-220JT+1005			
	R344	nsp	nsp	RM73B-472JT+1005			
	R345	nsp	nsp	RM73B-220JT+1005			
	R346	nsp	nsp	RM73B-472JT+1005			
	R347	nsp	nsp	RM73B-220JT+1005			
	R348	nsp	nsp	RM73B-472JT+1005			
	R349	nsp	nsp	RM73B-220JT+1005			
	R350	nsp	nsp	RM73B-472JT+1005			
	R351	nsp	nsp	RM73B-220JT+1005			
	R352	nsp	nsp	RM73B-472JT+1005			
	R353	nsp	nsp	RM73B-220JT+1005			
	R354,355	nsp	nsp	RM73B-472JT+1005			
	R358	nsp	nsp	RM73B-220JT+1005			
	R364	nsp	nsp	RM73B-0R0KT+1005			
	R365	nsp	nsp	RM73B-0R0KT+1005			
	R366,367	nsp	nsp	RM73B-0R0KT+1005			
	R368-370	nsp	nsp	RM73B-0R0KT +1608			

	Ref. No.	Part No. (for EUR)	Part No.	Part Name	Remarks	Q'ty	New
	R374-379	nsp	nsp	RM73B-0R0KT+1005			
	R380,381	nsp	nsp	RM73B-0R0KT+1005			
	R383	nsp	nsp	RM73B-0R0KT+1005			
	R385	nsp	nsp	RM73B-102JT			
	R390	nsp	nsp	RM73B-0R0KT+1005			
	R391	nsp	nsp	RM73B-473JT+1005			
	R394,395	nsp	nsp	RM73B-473JT+1005			
	R397	nsp	nsp	RM73B-473JT+1005			
	R399	nsp	nsp	RM73B-473JT+1005			
	R400	nsp	nsp	RM73B-473JT+1005			
	R402-405	nsp	nsp	RM73B-473JT+1005			
	R404	nsp	nsp	RM73B-0R0KT+1005			
	R406-408	nsp	nsp	RM73B-0R0KT+1005			
	R409-411	nsp	nsp	RM73B-0R0KT+1005			
	R415	nsp	nsp	RM73B-0R0KT+1005			
	R416,417	nsp	nsp	RM73B-0R0KT+1005			
	R420-422	nsp	nsp	RM73B-102JT			
	R424,425	nsp	nsp	RM73B-102JT			
	R427-431	nsp	nsp	RM73B-102JT			
	R432	nsp	nsp	RM73B-472JT+1005			
	R449,450	nsp	nsp	RM73B-0R0KT+1005			
	R451,452	nsp	nsp	RM73B-0R0KT+1005			
	R453-462	nsp	nsp	RM73B-0R0KT+1005			
	R461,462	nsp	nsp	RM73B-0R0KT+1005			
	R464	nsp	nsp	RM73B-0R0KT+1005			
	R467	nsp	nsp	RM73B-0R0KT+1005			
	R500-503	nsp	nsp	RM73B-0R0KT+1005			
	R504-507	nsp	nsp	RM73B-0R0KT+1005			
	R508-539	nsp	nsp	RM73B-220JT+1005			
	R540-543	nsp	nsp	RM73B-0R0KT+1005			
	R544-569	nsp	nsp	RM73B-0R0KT+1005			
	R571-573	nsp	nsp	RM73B-0R0KT+1005			
	R575-577	nsp	nsp	RM73B-0R0KT+1005			
	R578-583	nsp	nsp	RM73B-0R0KT+1005			
	R584-587	nsp	nsp	RM73B-220JT+1005			
	R590,591	nsp	nsp	RM73B-0R0KT+1005			
	R594	nsp	nsp	RM73B-0R0KT+1005			
	R595	nsp	nsp	RM73B-101JT+1005			
	R596	nsp	nsp	RM73B-473JT+1005			
	R597	nsp	nsp	RM73B-0R0KT+1005			
	R598	nsp	nsp	RM73B-472JT+1005			
	R599-601	nsp	nsp	RM73B-473JT+1005			
	R603,604	nsp	nsp	RM73B-0R0KT+1005			
	R605-617	nsp	nsp	RM73B-0R0KT+1005			
	R620	nsp	nsp	RM73B-0R0KT+1005			
	R636	nsp	nsp	RM73B-473JT+1005			
	R637-639	nsp	nsp	RM73B-0R0KT+1005			
	R640-645	nsp	nsp	RM73B-0R0KT+1005			
	R647	nsp	nsp	RM73B-0R0KT+1005			
	R649	nsp	nsp	RM73B-0R0KT+1005			
	R650,651	nsp	nsp	RM73B-0R0KT+1005			
	R653	nsp	nsp	RM73B-0R0KT+1005			
	R659-663	nsp	nsp	RM73B-0R0KT+1005			
	R664,665	nsp	nsp	RM73B-0R0KT+1005			
	R666-669	nsp	nsp	RM73B-220JT+1005			
	R670,671	nsp	nsp	RM73B-0R0KT+1005			
	R672-685	nsp	nsp	RM73B-0R0KT+1005			
	R687	nsp	nsp	RM73B-473JT+1005			

	Ref. No.	Part No. (for EUR)	Part No.	Part Name	Remarks	Q'ty	New
	R742,743 R744, 745 R802 R803-805	nsp nsp nsp nsp	nsp nsp nsp nsp	RM73B-0R0KT+1005 RM73B-0R0KT+1005 RM73B-0R0KT+1005 RM73B-102JT			
	R807 R808 R815-817 R819 R821	nsp nsp nsp nsp nsp	nsp nsp nsp nsp nsp	RM73B-0R0KT+1005 RM73B-0R0KT+1005 RM73B-102JT RM73B-0R0KT+1005 RM73B-0R0KT+1005	for U, S for U for N		
	R824 R826 R829 R830 R832	nsp nsp nsp nsp nsp	nsp nsp nsp nsp nsp	RM73B-181JT RM73B-0R0KT+1005 RM73B-271JT +1005 RM73B-271JT +1005 RM73B-0R0KT+1005	for S, R for N for R for S, R for R		
	R833 R836 R840 R843 R846	nsp nsp nsp nsp nsp	nsp nsp nsp nsp nsp	RM73B-0R0KT+1005 RM73B-391JT +1005 RM73B-0R0KT+1005 RM73B-681JT RM73B-0R0KT+1005	for S for R for R for R		
	R850 R851 R863 R881 R883-892	nsp nsp nsp nsp nsp	nsp nsp nsp nsp nsp	RM73B-0R0KT+1005 RM73B-0R0KT+1005 RM73B-0R0KT+1005 RM73B-0R0KT+1005 RM73B-0R0KT+1005			
	R900,901 R902 R903-905 R906-910 R916,917	nsp nsp nsp nsp nsp	nsp nsp nsp nsp nsp	RM73B-0R0KT +1608 RM73B-0R0KT+1005 RM73B-0R0KT +1608 RM73B-0R0KT +1608 RM73B-122FT +1608			
	R919 R922 R923925 R926-928 R930	nsp nsp nsp nsp nsp	nsp nsp nsp nsp nsp	RM73B-102FT +1608 RM73B-0R0KT+1005 RM73B-0R0KT +1608 RM73B-0R0KT +1608 RM73B-0R0KT+1005			
	R934 R938 R940 R-944 R949	nsp nsp nsp nsp nsp	nsp nsp nsp nsp nsp	RM73B-0R0KT+1005 RM73B-0R0KT+1005 RM73B-0R0KT+1005 RM73B-222FT_1608 RM73B-0R0KT +1608			
	R952 R956 R957 R959 R960	nsp nsp nsp nsp nsp	nsp nsp nsp nsp nsp	RM73B-102FT +1608 RM73B-0R0KT+1005 RM73B-0R0KT+1005 RM73B-102FT +1608 RM73B-0R0KT+1005			
	R969-972 R973,974 R985 RA150-154 RA155-RA160	nsp nsp nsp nsp nsp	nsp nsp nsp nsp nsp	RM73B-0R0KT +1608 RM73B-0R0KT +1608 RM73B-0R0KT+1005 MNR04=220(1005X4) MNR04=750(1005X4)			
	RA200-202 RA203-205 RA206,207 RA208-211 RA250-253	nsp nsp nsp nsp nsp	nsp nsp nsp nsp nsp	MNR04=220(1005X4) MNR04=220(1005X4) MNR04=750(1005X4) MNR04=750(1005X4) MNR14=103JE0 +C			
	RA300-303 RE301-303 RE304 RE305	nsp nsp nsp nsp	nsp nsp nsp nsp	MNR04=223(1005X4) RM73B-0R0KT+1005 RM73B-102JT RM73B-0R0KT+1005			

△

△

△

△

△

△

△

△

△

	Ref. No.	Part No. (for EUR)	Part No.	Part Name	Remarks	Q'ty	New
	RE307-311	nsp	nsp	RM73B-101JT+1005			
	RE312,313	nsp	nsp	RM73B-101JT+1005			
	RE317,318	nsp	nsp	RM73B-101JT+1005			
	RE321	nsp	nsp	RM73B-0R0KT +1608			
	RE322-324	nsp	nsp	RM73B-0R0KT+1005			
	RE325	nsp	nsp	RM73B-0R0KT+1005			
	RE326	nsp	nsp	RM73B-0R0KT +1608			
	RE326	nsp	nsp	RM73B-0R0KT +1608			
	RE327-337	nsp	nsp	RM73B-0R0KT+1005			
	RE338	nsp	nsp	RM73B-0R0KT+1005			
	RE339-342	nsp	nsp	RM73B-0R0KT+1005			
	RE343-348	nsp	nsp	RM73B-0R0KT+1005			
	RE349	nsp	nsp	RM73B-0R0KT +1608			
	RE350	nsp	nsp	RM73B-0R0KT+1005			
	RE351	nsp	nsp	MMZ1005D241CT			
	RE353	nsp	nsp	RM73B-0R0KT+1005			
	RE355	nsp	nsp	RM73B-101JT+1005			
	RE359	nsp	nsp	MMZ1005D241CT			
	RE369,370	nsp	nsp	RM73B-0R0KT+1005			
	RE372	nsp	nsp	RM73B-0R0KT+1005			
	RE374	nsp	nsp	RM73B-101JT+1005			
	RE375	nsp	nsp	RM73B-0R0KT+1005			
	RE377	nsp	nsp	RM73B-0R0KT+1005			
	RE382	nsp	nsp	RM73B-0R0KT+1005			
	RE385	nsp	nsp	RM73B-102JT			
	RE387	nsp	nsp	RM73B-102JT			
	RE388	nsp	nsp	RM73B-0R0KT+1005			
	RE389-392	nsp	nsp	RM73B-0R0KT+1005			
	RE393	nsp	nsp	RM73B-0R0KT+1005			
	RE394,395	nsp	nsp	RM73B-101JT+1005			
	RE396-399	nsp	nsp	RM73B-101JT+1005			
	RE402,403	nsp	nsp	RM73B-0R0KT+1005			
	RE404,405	nsp	nsp	RM73B-0R0KT+1005			
	RE450,451	nsp	nsp	RM73B-220JT+1005			
	RE471	nsp	nsp	RM73B-101JT+1005			
	RE502,505	nsp	nsp	RM73B-0R0KT+1005			
	RE550,551	nsp	nsp	RM73B-220JT+1005			
	RE651	nsp	nsp	RM73B-101JT+1005			
	RE658-660	nsp	nsp	RM73B-102JT			
	RE661	nsp	nsp	RM73B-0R0KT+1005			
	RE801	nsp	nsp	RM73B-472JT+1005			
	RE803,804	nsp	nsp	RM73B-472JT+1005			
	RE805	nsp	nsp	RM73B-0R0KT+1005			
	RE806-824	nsp	nsp	RM73B-0R0KT+1005			
	RE825	nsp	nsp	RM73B-472JT+1005			
	RR301,302	nsp	nsp	RM73B-101JT+1005			
	RR303-306	nsp	nsp	RM73B-101JT+1005			
	RR307	nsp	nsp	RM73B-0R0KT +1608			
	RR315	nsp	nsp	RM73B-0R0KT+1005			
	RR316	nsp	nsp	RM73B-101JT+1005			
	RR317,318	nsp	nsp	RM73B-0R0KT+1005			
	RR339,340	nsp	nsp	RM73B-101JT+1005			
	RR344	nsp	nsp	RM73B-473JT+1005			
	RR347	nsp	nsp	RM73B-473JT+1005			
	RR359,360	nsp	nsp	RM73B-0R0KT+1005			
	RR362	nsp	nsp	RM73B-0R0KT+1005			
	RR364	nsp	nsp	RM73B-102JT			
	RR366	nsp	nsp	RM73B-101JT+1005			

	Ref. No.	Part No. (for EUR)	Part No.	Part Name	Remarks	Q'ty	New
	RR367	nsp	nsp	MMZ1005D241CT			
	RR369,370	nsp	nsp	RM73B-0R0KT+1005			
	RR371-374	nsp	nsp	RM73B-102JT			
	RR375-377	nsp	nsp	RM73B-0R0KT+1005			
	RR395	nsp	nsp	RM73B-0R0KT+1005			
	RR396	nsp	nsp	RM73B-0R0KT+1005			
	RR398,399	nsp	nsp	RM73B-0R0KT+1005			
	RR402	nsp	nsp	RM73B-0R0KT +1608			
	RR403,404	nsp	nsp	RM73B-0R0KT +1608			
	RR406	nsp	nsp	RM73B-0R0KT +1608			
	RR446	nsp	nsp	RM73B-0R0KT+1005			
	RR448	nsp	nsp	RM73B-0R0KT+1005			
	RR450	nsp	nsp	RM73B-0R0KT+1005			
	RR454	nsp	nsp	RM73B-0R0KT+1005			
	RR465	nsp	nsp	RM73B-0R0KT+1005			
	RR540	nsp	nsp	RM73B-0R0KT+1005			
	RR542	nsp	nsp	RM73B-0R0KT+1005			
	RR544	nsp	nsp	RM73B-0R0KT+1005			
	RR548R	nsp	nsp	RM73B-0R0KT+1005			
	RR559	nsp	nsp	RM73B-0R0KT+1005			
	RR601	nsp	nsp	RM73B-102JT			
	RR603	nsp	nsp	RM73B-0R0KT+1005			
	RR610	nsp	nsp	RM73B-0R0KT+1005			
	RR619	nsp	nsp	RM73B-102JT			
	RR623	nsp	nsp	RM73B-0R0KT+1005			
	RR628	nsp	nsp	RM73B-0R0KT+1005			
	RR803	nsp	nsp	RM73B-0R0KT+1005			
	RR804	nsp	nsp	RM73B-472JT+1005			
	RR811	nsp	nsp	RM73B-274FT(1005)			
	RR813	nsp	nsp	RM73B-0R0KT+1005			
	RR815	nsp	nsp	RM73B-0R0KT+1005			
	RR817	nsp	nsp	RM73B-0R0KT+1005			
	RR822	nsp	nsp	RM73B-0R0KT+1005			
	RR825	nsp	nsp	RM73B-0R0KT+1005			
	RR827	nsp	nsp	RM73B-0R0KT+1005			
	RR829	nsp	nsp	RM73B-0R0KT+1005			
	RR846-848	nsp	nsp	RM73B-0R0KT+1005			
	RR850-856	nsp	nsp	RM73B-0R0KT+1005			
	RR869	nsp	nsp	RM73B-472JT+1005			
	RR870	nsp	nsp	RM73B-0R0KT+1005			
	RR871	nsp	nsp	RM73B-0R0KT+1005			
	RR878-890	nsp	nsp	RM73B-0R0KT+1005			
	RR896	nsp	nsp	RM73B-0R0KT+1005			
	RR897	nsp	nsp	RM73B-473JT+1005			
	RR915,916	nsp	nsp	RM73B-0R0KT+1005			
	RR919	nsp	nsp	RM73B-0R0KT+1005			
	RR926	nsp	nsp	RM73B-0R0KT+1005			
	RR933	nsp	nsp	RM73B-0R0KT+1005			
	RR936,937	nsp	nsp	RM73B-0R0KT+1005			
	RR942	nsp	nsp	RM73B-0R0KT+1005			
	RR943-945	nsp	nsp	RM73B-0R0KT+1005			
	RR946	nsp	nsp	RM73B-473JT+1005			
	RR954-956	nsp	nsp	RM73B-0R0KT+1005			
	RR964	nsp	nsp	RM73B-0R0KT+1005			
	RR969	nsp	nsp	RM73B-0R0KT+1005			
	RR971	nsp	nsp	RM73B-0R0KT+1005			

Ref. No.	Part No. (for EUR)	Part No.	Part Name	Remarks	Q'ty	New
CAPACITORS GROUP						
C101-128	nsp	nsp	CK73F1C104ZT +1005			
C123	nsp	nsp	CK73F1H103ZT +1005			
C125-127	nsp	nsp	CK73F1H103ZT +1005			
C129,130	nsp	nsp	CK73F1C104ZT +1005			
C131,132	nsp	nsp	CK73F1H103ZT +1005			
C133	nsp	nsp	CK73F1H103ZT +1005			
C134-141	nsp	nsp	CK73B1A104KT +1005			
C150-165	nsp	nsp	CK73B1A104KT +1005			
C166	nsp	nsp	CS77B0J470MT(NOJ)			
C167-170	nsp	nsp	CK73B1A104KT +1005			
C171	nsp	nsp	CS77B0J470MT(NOJ)			
C172-174	nsp	nsp	CK73B1A104KT +1005			
C175-180	nsp	nsp	CK73F1C104ZT +1005			
C181-186	nsp	nsp	CK73F1C104ZT +1005			
C187	nsp	nsp	CK73B1A104KT +1005			
C188-194	nsp	nsp	CK73B1A104KT +1005			
C200	nsp	nsp	CK73B1A104KT +1005			
C201-211	nsp	nsp	CK73B1A104KT +1005			
C212	nsp	nsp	CS77B0J470MT(NOJ)			
C213	nsp	nsp	CK73B1A104KT +1005			
C214	nsp	nsp	CS77B0J470MT(NOJ)			
C215,216	nsp	nsp	CK73F1C104ZT +1005			
C217-226	nsp	nsp	CK73F1C104ZT +1005			
C227-230	nsp	nsp	CK73B1A104KT +1005			
C231-236	nsp	nsp	CK73B1A104KT +1005			
C250	nsp	nsp	CK73F1C104ZT +1005			
C252	nsp	nsp	CK73B0J226MT			
C253,254	nsp	nsp	CK73F1C104ZT +1005			
C255	nsp	nsp	CK73B0J226MT			
C350	nsp	nsp	CK73B0J475KT +1608			
C351,352	nsp	nsp	CK73B1H102KT +1005			
C638	nsp	nsp	CK73B1H102KT +1005			
C658	nsp	nsp	CK73B1H102KT +1005			
C709	nsp	nsp	CK73B1H102KT +1005			
C734	nsp	nsp	CK73B1H102KT +1005			
C736	nsp	nsp	CK73B1H102KT +1005			
C736	nsp	nsp	CK73B1H102KT +1005			
C738	nsp	nsp	CK73B1H102KT +1005			
C353,354	nsp	nsp	CK73B1A104KT +1005			
C355	nsp	nsp	CK73B1A104KT +1005			
C357	nsp	nsp	CK73B1A104KT +1005			
C360	nsp	nsp	CK73B1A104KT +1005			
C363,364	nsp	nsp	CK73B1A104KT +1005			
C711-713	nsp	nsp	CK73B1A104KT +1005			
C358,359	nsp	nsp	CC73CH1H120JT +1005			
C361	nsp	nsp	CE67C0J220MT (RV2) +REF			
C803	nsp	nsp	CE67C0J220MT (RV2) +REF			
C362	nsp	nsp	CK73B1E103KT(1005)			
C365,366	nsp	nsp	CK73B1E104KT +1608			
C367	nsp	nsp	CK73B1E103KT(1005)			
C500-502	nsp	nsp	CK73F1C104ZT +1005			
C503-505	nsp	nsp	CK73F1C104ZT +1005			
C639	nsp	nsp	CC73CH1H101JT +1005			
C659	nsp	nsp	CC73CH1H101JT +1005			
C660	nsp	nsp	CS77B1A100MT(NOJ)			
C705	nsp	nsp	CS77B1A100MT(NOJ)			

	Ref. No.	Part No. (for EUR)	Part No.	Part Name	Remarks	Q'ty	New
	C708	nsp	nsp	CK73B1E103KT(1005)			
	C710	nsp	nsp	CK73F1C104ZT +1005			
	C714	nsp	nsp	CS77B0J220MT(NOJ)			
	C716	nsp	nsp	CS77B0J470MT(NOJ)			
	C717-722	nsp	nsp	CK73B1A104KT +1005			
	C725,726	nsp	nsp	CK73B1A104KT +1005			
	C727-730	nsp	nsp	CK73B1A104KT +1005			
	C733	nsp	nsp	CK73B1E103KT(1005)			
	C735	nsp	nsp	CK73B1E103KT(1005)			
	C737	nsp	nsp	CK73B1E103KT(1005)			
	C745	nsp	nsp	CK73B1E103KT(1005)			
	C746	nsp	nsp	CK73B1H102KT +1005			
	C747	nsp	nsp	CK73B1A104KT +1005			
	C748	nsp	nsp	CK73B1H102KT +1005			
	C749	nsp	nsp	CK73F1C104ZT +1005			
	C75	nsp	nsp	CK73F1C104ZT +1005			
	C750	nsp	nsp	CK73F1H103ZT +1005			
	C751	nsp	nsp	CK73B1A106KT +2125			
	C753	nsp	nsp	CK73F1H103ZT +1005			
	C757	nsp	nsp	CC73CH1H100DT +1005			
	C758	nsp	nsp	CK73B1H222KT +1005			
	C759	nsp	nsp	CC73CH1H100DT +1005			
	C760	nsp	nsp	CS77B0J220MT(NOJ)			
	C761-763	nsp	nsp	CS77B0J220MT(NOJ)			
	C764-766	nsp	nsp	CK73B1A104KT +1005			
	C767,768	nsp	nsp	CK73B1A104KT +1005			
	C769	nsp	nsp	CS77B0J220MT(NOJ)			
	C802	nsp	nsp	CK73F1C104ZT +1005			
	C805	nsp	nsp	CK73F1C104ZT +1005			
	C806	nsp	nsp	CK73D0J226MT(3216)			
	C807	nsp	nsp	CK73F1C104ZT +1005			
	C808	nsp	nsp	CK73D0J226MT(3216)			
	C810	nsp	nsp	CK73F1C104ZT +1005			
	C811,812	nsp	nsp	CC73CH1H220JT +1005			
	C813,814	nsp	nsp	CC73CH1H8R0DT +1005			
	C815,816	nsp	nsp	CK73F1C104ZT +1005			
	C818	nsp	nsp	CK73B1A104KT +1005			
	C819	nsp	nsp	CK73D0J226MT(3216)			
	C820	nsp	nsp	CK73F1C104ZT +1005			
	C821	nsp	nsp	CK73F1C104ZT +1005			
	C900C,901	nsp	nsp	CK73B0J475KT +1608			
	C902	nsp	nsp	CK73F1E104ZT +1608			
	C903	nsp	nsp	CK73F1H103ZT +1608			
	C904	nsp	nsp	CK73B1H102KT +1608			
	C905,906	nsp	nsp	CK73D0J226MT(3216)			
	C907	nsp	nsp	CK73F1E104ZT +1608			
	C908	nsp	nsp	CK73F1H103ZT +1608			
	C909	nsp	nsp	CE67C1C101MT (RV2) +REF			
	C916	nsp	nsp	CK73F1H103ZT +1608			
	C921	nsp	nsp	CK73B0J475KT +1608			
	C922	nsp	nsp	CK73F1E104ZT +1608			
	C923	nsp	nsp	CK73D0J226MT(3216)			
	C924	nsp	nsp	CK73F1H103ZT +1608			
	C925	nsp	nsp	CK73B1H102KT +1608			
	C926C,927	nsp	nsp	CK73B0J475KT +1608			
	C928	nsp	nsp	CK73F1E104ZT +1608			
	C929	nsp	nsp	CK73F1H103ZT +1608			
	C930	nsp	nsp	CK73B1H102KT +1608			

	Ref. No.	Part No. (for EUR)	Part No.	Part Name	Remarks	Q'ty	New
	C931,932	nsp	nsp	CK73D0J226MT(3216)			
	C933,934	nsp	nsp	CK73B1H103KT (1608) +1608			
	C935	nsp	nsp	CK73B1H102KT +1608			
	C936,937	nsp	nsp	CK73B1E104KT +1608			
	C938	nsp	nsp	CK73D0J226MT(3216)			
	C939	nsp	nsp	CK73B1H103KT (1608) +1608			
	C940,941	nsp	nsp	CK73D0J226MT(3216)			
	C942	nsp	nsp	CK73B1E104KT +1608			
	C943	nsp	nsp	CK73D0J226MT(3216)			
	C944	nsp	nsp	CK73B0J475KT +1608			
	C945	nsp	nsp	CK73F1H103ZT +1608			
	C946	nsp	nsp	CK73B0J475KT +1608			
	C947	nsp	nsp	CK73B1H153KT +1608			
	C948	nsp	nsp	CK73F1A105ZT +1608			
	C949	nsp	nsp	CK73B1E104KT +1608			
	C950	nsp	nsp	CK73D0J226MT(3216)			
	C951	nsp	nsp	CK73B0J475KT +1608			
	C952	nsp	nsp	CK73F1E104ZT +1608			
	C953	nsp	nsp	CK73D0J226MT(3216)			
	C954	nsp	nsp	CK73F1H103ZT +1608			
	C955	nsp	nsp	CK73B1H102KT +1608			
	C956	nsp	nsp	CK73B1H102KT +1608			
	C957	nsp	nsp	CK73B1H103KT (1608) +1608			
	C958	nsp	nsp	CK73B1E104KT +1608			
	C959	nsp	nsp	CK73D0J226MT(3216)			
	C961	nsp	nsp	CK73B1E104KT +1608			
	C962	nsp	nsp	CK73B0J226MT			
	C965	nsp	nsp	CK73B0J226MT			
	C967	nsp	nsp	CK73B0J226MT			
	C968	nsp	nsp	CK73B1E104KT +1608			
	C971,972	nsp	nsp	CK73B0J226MT			
	C973	nsp	nsp	CK73B1E104KT +1608			
	CC113-116	nsp	nsp	CK73F1C104ZT +1005			
	CC117-174	nsp	nsp	CK73F1C104ZT +1005			
	CC301	nsp	nsp	CS77B0J470MT(NOJ)			
	CC302	nsp	nsp	CK73F1H103ZT +1005			
	CC303	nsp	nsp	CK73B1H102KT +1005			
	CC304	nsp	nsp	CK73F1C104ZT +1005			
	CC305	nsp	nsp	CS77B0J470MT(NOJ)			
	CC306	nsp	nsp	CK73F1A105ZT +1608			
	CC307	nsp	nsp	CK73B1E103KT(1005)			
	CC308-310	nsp	nsp	CC73CH1H470JT			
	CC311	nsp	nsp	CS77B0J101MT(NOJ)			
	CC313	nsp	nsp	CK73F1C104ZT +1005			
	CC314	nsp	nsp	CS77B0J470MT(NOJ)			
	CC315	nsp	nsp	CK73F1C104ZT +1005			
	CC316	nsp	nsp	CS77B0J101MT(NOJ)			
	CC317	nsp	nsp	CK73F1C104ZT +1005			
	CC318	nsp	nsp	CS77B1A100MT(NOJ)			
	CC319,320	nsp	nsp	CS77B1A100MT(NOJ)			
	CC321,322	nsp	nsp	CK73B1H102KT +1005			
	CC323,324	nsp	nsp	CK73B1E103KT(1005)			
	CC325,326	nsp	nsp	CC73CH1H101JT +1005			
	CC327,328	nsp	nsp	CK73B1H102KT +1005			
	CC329,330	nsp	nsp	CK73B1E103KT(1005)			
	CC331,332	nsp	nsp	CC73CH1H101JT +1005			
	CC334	nsp	nsp	CC73CH1H101JT +1005			

	Ref. No.	Part No. (for EUR)	Part No.	Part Name	Remarks	Q'ty	New
	CC336,337	nsp	nsp	CK73B1H102KT +1005			
	CC338	nsp	nsp	CC73CH1H101JT +1005			
	CC341	nsp	nsp	CC73CH1H101JT +1005			
	CC342	nsp	nsp	CK73B1H102KT +1005			
	CC345-352	nsp	nsp	RM73B-0R0KT+1005			
	CC353,354	nsp	nsp	CK73F1C104ZT +1005			
	CC355,356	nsp	nsp	CK73F1H103ZT +1005			
	CC357,358	nsp	nsp	CK73F1C104ZT +1005			
	CC359,360	nsp	nsp	CK73F1H103ZT +1005			
	CC401-407	nsp	nsp	CC73CH1H101JT +1005			
	CC408	nsp	nsp	CC73CH1H101JT +1005			
	CC409	nsp	nsp	CK73B1H102KT +1005			
	CC410-413	nsp	nsp	CK73B1H102KT +1005			
	CC414-416	nsp	nsp	CK73B1H102KT +1005			
	CC417-421	nsp	nsp	CK73B1A104KT +1005			
	CC422-424	nsp	nsp	CK73B1A104KT +1005			
	CC425	nsp	nsp	CS77B1A100MT(NOJ)			
	CC427,428	nsp	nsp	CK73B1A104KT +1005			
	CC430,431	nsp	nsp	CK73B1A104KT +1005			
	CC432	nsp	nsp	CK73B0J475KT +1608			
	CC434	nsp	nsp	CK73B1A104KT +1005			
	CC435	nsp	nsp	CK73B0J475KT +1608			
	CC438,439	nsp	nsp	CC73CH1H7R0DT +1005			
	CC501-507	nsp	nsp	CC73CH1H101JT +1005			
	CC508	nsp	nsp	CC73CH1H101JT +1005			
	CC509-513	nsp	nsp	CK73B1H102KT +1005			
	CC514-516	nsp	nsp	CK73B1H102KT +1005			
	CC517-524	nsp	nsp	CK73B1A104KT +1005			
	CC525	nsp	nsp	CS77B1A100MT(NOJ)			
	CC527,528	nsp	nsp	CK73B1A104KT +1005			
	CC530,531	nsp	nsp	CK73B1A104KT +1005			
	CC532	nsp	nsp	CK73B0J475KT +1608			
	CC534	nsp	nsp	CK73B1A104KT +1005			
	CC535	nsp	nsp	CK73B0J475KT +1608			
	CC538,539	nsp	nsp	CC73CH1H7R0DT +1005			
	CC601	nsp	nsp	CK73D0J226MT(3216)			
	CC602,603	nsp	nsp	CK73F1C104ZT +1005			
	CC604	nsp	nsp	CK73B1E223KT +1608			
	CC605	nsp	nsp	CK73B1A104KT +1005			
	CC606	nsp	nsp	CK73F1H103ZT +1005			
	CC607	nsp	nsp	CK73B1H102KT +1005			
	CC608,609	nsp	nsp	CK73F1C104ZT +1005			
	CC610,617	nsp	nsp	CK73B1H102KT +1005			
	CC611,612	nsp	nsp	CC73CH1H100DT +1005			
	CC613-615	nsp	nsp	CK73F1C104ZT +1005			
	CC616	nsp	nsp	CK73F1H103ZT +1005			
	CC618	nsp	nsp	CK73F1C104ZT +1005			
	CC626	nsp	nsp	CE67C1C100MT(RV2)			
	CC628	nsp	nsp	CE67C1H010MT(RV2)			
	CC629	nsp	nsp	CK73F1H103ZT +1005			
OTHERS PARTS GROUP							
	CW01	nsp	nsp	2P 80mm ZM			
	CX044	nsp	nsp	B4PS-VH			
	CX082	nsp	nsp	8P FFC BASE(IMS-9617S-08Y909)			
	CX403	nsp	nsp	40P-FFC-BASE(FH12)			

	Ref. No.	Part No. (for EUR)	Part No.	Part Name	Remarks	Q'ty	New
	CX953 CY151 CY252,253	nsp nsp nsp	nsp nsp nsp	10P ZH-ZR CON.BASE-T CONN. S15B-PH-SM4-TB (LF)(SN)JST 25P FFC BASE (9610SD +REF			
	CY402 CY404 CY452 CY801	nsp nsp nsp nsp	nsp nsp nsp nsp	40P-FFC-BASE(FH12) 40P FFC BASE(FY-BMGB-TB) 45P-FFC-BASE(9637SA) 80P-SOCKET(404)			
	FB300,301 FB351-353 FB851,852 FB901 FB907	nsp nsp nsp nsp nsp	nsp nsp nsp nsp nsp	CHIP EMIFIL(11A121) +1608 FBMJ1608HS280NT +1608 FBMJ1608HS280NT +1608 FBMJ1608HS280NT +1608 FBMJ1608HS280NT +1608			
	FB910 FB701-704 FB706,707 FB911-914 FB916	nsp nsp nsp nsp nsp	nsp nsp nsp nsp nsp	FBMJ1608HS280NT +1608 BLM18AG121SN1D BLM18AG121SN1D FBMJ1608HS280NT +1608 E.FIL(BLM21PG221SN1)+2125			
	JK301 JK651 W651,652	00D2051333009 643010023605S nsp	00D2051333009 643010023605S nsp	8P MODULAR 1P PIN JACK(AU ,shield) M3 SCREW TERMINAL			
	X300 X451 X551 X651	nsp nsp nsp nsp	nsp nsp nsp nsp	FCX-03(25MHZ) FCX-03(20.815MHz) FCX-03(20.815MHz) FCX-03(24.576MHz)			
	X705 X851 X852 ZD300-303	nsp nsp nsp nsp	nsp nsp nsp nsp	FCX-03(27.000MHz) 15ppm TFX-02(32.768kHz) FCX-03(20.000MHz) 20ppm ESD PROTECTOR(6802)			

8U-310002AZ VIDEO PWB UNIT ASSY

Ref. No.	Part No. (for EUR)	Part No.	Part Name	Remarks	Q'ty	New
SEMICONDUCTORS GROUP						
IC102	nsp	nsp	PCA9539PW,188			*
IC104-106	nsp	nsp	EN5322QI-T			
IC108	nsp	nsp	EPM570F256C5N			
IC202	nsp	nsp	TC7W241FU(TE12L)			
IC203	nsp	nsp	sxT2LF-400(Realta)			
IC204-209	nsp	nsp	K4D261638K-LC40			
IC210	nsp	nsp	LP2995M			
IC211,212	nsp	nsp	K4D261638K-LC40			*
IC213	nsp	nsp	IP ROM SUB ASSY (S29GL064N90TFI040#)			
IC214	nsp	nsp	EN5336QI-T			*
IC215	nsp	nsp	EN5366QI-T			*
IC501	nsp	nsp	EPM570F256C5N			
IC502	nsp	nsp	SII9134CTU			
IC503	nsp	nsp	BD7820FP-E2			
IC504	nsp	nsp	SII9134CTU			
IC601	nsp	nsp	ABT2010			*
IC701	nsp	nsp	EN5322QI-T			*
IC702	nsp	nsp	LP2996MX			
IC703,704	nsp	nsp	K4T51163QG-HCE7			*
IC802	nsp	nsp	ADV7344BSTZ			*
IC803-805	nsp	nsp	BD7820FP-E2			
IC806	nsp	nsp	ABT1012			*
IC808	nsp	nsp	ADV7340BSTZ			
IC901	nsp	nsp	NJM2566AV			
TR103-106	nsp	nsp	KRC104S-RTK/P (47K-47K)			
TR202,203	nsp	nsp	KRC104S-RTK/P (47K-47K)			
TR503	nsp	nsp	KTC3875S-GR-RTK/P			
TR701	nsp	nsp	KRC104S-RTK/P (47K-47K)			
TR802-804	nsp	nsp	2SA1022-B +C			
TR806,807	nsp	nsp	2SA1022-B +C			
TR821,822	nsp	nsp	KRC104S-RTK/P (47K-47K)			
D101-103	nsp	nsp	RB521S-30TE61 +REF			
D201,202	nsp	nsp	RB521S-30TE61 +REF			
D501-503	nsp	nsp	KDS160-RTK/P			
D504-508	nsp	nsp	ESD PROTECTOR(6802)			
D509-516	nsp	nsp	AVRL161A1R1NTB			
D517-521	nsp	nsp	ESD PROTECTOR(6802)			
D522-529	nsp	nsp	AVRL161A1R1NTB			
D701	nsp	nsp	RB521S-30TE61 +REF			
D801-803	nsp	nsp	KDS160-RTK/P			
ZD501,502	nsp	nsp	UDZS5.18-TE17 +C			
RESISTORS GROUP						
R356,357	nsp	nsp	RM73B-103FT +1608			
R359,360	nsp	nsp	RM73B-103FT +1608			
R725,726	nsp	nsp	RM73B-102FT +1608			
R732,733	nsp	nsp	RM73B-102FT +1608			

NOTE :
When update Firmware, please confirm a last version in SDI. Use the service board after updating it.

	Ref. No.	Part No. (for EUR)	Part No.	Part Name	Remarks	Q'ty	New
	RA201-240	nsp	nsp	MNR04=330(1005X4)			
	RA601-606	nsp	nsp	MNR04=000(1005X4)			
	RA701-708	nsp	nsp	MNR04=000(1005X4)			
	RA709-714	nsp	nsp	MNR04=151(1005X4)			
	RE111	nsp	nsp	RM73B-103DT(1608) +1608			
	RE112	nsp	nsp	RM73B-334DT(1608)			
	RE115	nsp	nsp	RM73B-514DT(1608)			
	RE202,203	nsp	nsp	RM73B-103FT +1608			
	RE207,208	nsp	nsp	RM73B-103FT +1608			
	RE212,213	nsp	nsp	RM73B-103FT +1608			
	RE217,218	nsp	nsp	RM73B-103FT +1608			
	RE225,226	nsp	nsp	RM73B-103FT +1608			
	RE229,230	nsp	nsp	RM73B-103FT +1608			
	RE232,233	nsp	nsp	RM73B-103FT +1608			
	RE239,240	nsp	nsp	RM73B-103FT +1608			
	RE254	nsp	nsp	RM73B-301DT(1608)			
	RE255	nsp	nsp	RM73B-272DT(1608)			
	RE256	nsp	nsp	RM73B-102DT(1608)			
	RE257	nsp	nsp	RM73B-822DT(1608)			
	RE261,262	nsp	nsp	RM73B-102DT(1608)			
	RE267	nsp	nsp	RM73B-301DT(1608)			
	RE268	nsp	nsp	RM73B-272DT(1608)			
	RE269	nsp	nsp	RM73B-102DT(1608)			
	RE270	nsp	nsp	RM73B-822DT(1608)			
	RE274,275	nsp	nsp	RM73B-102DT(1608)			
	RE539	nsp	nsp	RM73B-303DT(1608)			
	RE540	nsp	nsp	RM73B-154DT(1608)			
	RE541	nsp	nsp	RM73B-203DT(1608)			
	RE921	nsp	nsp	RM73B-750DT(1608)			
	RE923	nsp	nsp	RM73B-750DT(1608)			
	RE925	nsp	nsp	RM73B-750DT(1608)			
	RE927	nsp	nsp	RM73B-750DT(1608)			
	RE929	nsp	nsp	RM73B-750DT(1608)			
	RE931	nsp	nsp	RM73B-750DT(1608)			
	RR285	nsp	nsp	RM73B-750FT			
	RR295	nsp	nsp	RM73B-331FT			
	RR296	nsp	nsp	RM73B-162FT			
	RR336	nsp	nsp	RM73B-750FT			
	RR337	nsp	nsp	RM73B-162FT			
	RR338	nsp	nsp	RM73B-331FT			
	RR359,360	nsp	nsp	RM73B-750FT			
	RR361	nsp	nsp	RM73B-162FT			
	RR362	nsp	nsp	RM73B-331FT			
	RR383,384	nsp	nsp	RM73B-750FT			
	RR611	nsp	nsp	RM73B-222DT(1608)			
	RR613	nsp	nsp	RM73B-510DT(1608)			
	RR647	nsp	nsp	RM73B-331DT(1608)			
	RR648	nsp	nsp	RM73B-272DT(1608)			
	RR649	nsp	nsp	RM73B-102FT +1608			
	RR652-654	nsp	nsp	RM73B-102FT +1608			
	RR814	nsp	nsp	RM73B-511DT(1608)			
	RR850	nsp	nsp	RM73B-750DT(1608)			
	RR852	nsp	nsp	RM73B-750DT(1608)			

	Ref. No.	Part No. (for EUR)	Part No.	Part Name	Remarks	Q'ty	New
	RR857	nsp	nsp	RM73B-750DT(1608)			
	RR859	nsp	nsp	RM73B-750DT(1608)			
	RR863,864	nsp	nsp	RM73B-750DT(1608)			
	RR865	nsp	nsp	RM73B-303DT(1608)			
	RR866	nsp	nsp	RM73B-154DT(1608)			
	RR867	nsp	nsp	RM73B-203DT(1608)			
	RR873	nsp	nsp	RM73B-303DT(1608)			
	RR874	nsp	nsp	RM73B-203DT(1608)			
	RR875	nsp	nsp	RM73B-823DT(1608)			
	RR876	nsp	nsp	RM73B-273DT(1608)			
	RR877	nsp	nsp	RM73B-153DT(1608)			
	RR878	nsp	nsp	RM73B-303DT(1608)			
	RS101-140	nsp	nsp	RM73B-0R0KT+1005			
	RS142	nsp	nsp	RM73B-0R0KT+1005			
	RS144	nsp	nsp	RM73B-0R0KT+1005			
	RS146	nsp	nsp	RM73B-0R0KT+1005			
	RS148,149	nsp	nsp	RM73B-0R0KT+1005			
	RS150,151	nsp	nsp	RM73B-101JT+1005			
	RS152	nsp	nsp	RM73B-0R0KT +1608			
	RS155-199	nsp	nsp	RM73B-220JT+1005			
	RS501-509	nsp	nsp	RM73B-0R0KT+1005			
	RS510,511	nsp	nsp	RM73B-472JT+1005			
	RS513	nsp	nsp	RM73B-132JT +1608			
	RS514	nsp	nsp	RM73B-152JT +1608			
	RS516	nsp	nsp	RM73B-0R0KT+1005			
	RS518,519	nsp	nsp	RM73B-0R0KT+1005			
	RS520	nsp	nsp	RM73B-101JT+1005			
	RS521	nsp	nsp	RM73B-102JT			
	RS522	nsp	nsp	RM73B-473JT+1005			
	RS523	nsp	nsp	RM73B-0R0KT+1005			
	RS524,525	nsp	nsp	RM73B-182JT			
	RS530-532	nsp	nsp	RM73B-0R0KT+1005			
	RS802,803	nsp	nsp	RM73B-0R0KT+1005			
	RS805	nsp	nsp	RM73B-472JT+1005			
	RS807,808	nsp	nsp	RM73B-0R0KT+1005			
	RS810,811	nsp	nsp	RM73B-0R0KT+1005			
	RS814	nsp	nsp	RM73B-511JT +1608			
	RS816	nsp	nsp	RM73B-0R0KT +1608			
	RS819,820	nsp	nsp	RM73B-221JT +1005			
	RS822	nsp	nsp	RM73B-472DT(1608)			
	RS823	nsp	nsp	RM73B-333DT(1608)			
	RS824	nsp	nsp	RM73B-221JT +1005			
	RS825	nsp	nsp	RM73B-221JT +1608			
	RS826,827	nsp	nsp	RM73B-0R0KT+1005			
	RS828,829	nsp	nsp	RM73B-331JT			
	RS830-839	nsp	nsp	RM73B-0R0KT +1608			
	RS840,841	nsp	nsp	RM73B-331JT			
	RS842	nsp	nsp	RM73B-0R0KT +1608			
	RS843	nsp	nsp	RM73B-301DT(1608)			
	RS845	nsp	nsp	RM73B-330JT +1608			
	RS846	nsp	nsp	RM73B-102JT +1608			
	RS847	nsp	nsp	RM73B-0R0KT +1608			
	RS848	nsp	nsp	RM73B-301DT(1608)			
	RS850	nsp	nsp	RM73B-330JT +1608			

	Ref. No.	Part No. (for EUR)	Part No.	Part Name	Remarks	Q'ty	New
	RS851	nsp	nsp	RM73B-102JT +1608			
	RS853	nsp	nsp	RM73B-0R0KT +1608			
	RS855	nsp	nsp	RM73B-0R0KT +1608			
CAPACITORS GROUP							
	C102	nsp	nsp	CK73B1A104KT +1005			
	C106	nsp	nsp	CK73B1H102KT +1005			
	C107	nsp	nsp	CK73B1A104KT +1005			
	C108	nsp	nsp	CS77B1A100MT(NOJ)			
	C109	nsp	nsp	CK73B1A104KT +1005			
	C110	nsp	nsp	CK73B1E103KT(1005)			
	C111	nsp	nsp	CK73B0J475KT(P) +1608			
	C112-117	nsp	nsp	CK73B1A104KT +1005			
	C118	nsp	nsp	CK73B1E103KT(1005)			
	C119	nsp	nsp	CK73B1A104KT +1005			
	C120	nsp	nsp	CK73B1E103KT(1005)			
	C121	nsp	nsp	CK73B1A104KT +1005			
	C122,123	nsp	nsp	CK73D0J226MT(3216)			
	C124	nsp	nsp	CK73B1A104KT +1005			
	C125	nsp	nsp	CK73B1E103KT(1005)			
	C126	nsp	nsp	CK73B1A104KT +1005			
	C127	nsp	nsp	CK73B1E103KT(1005)			
	C128	nsp	nsp	CK73B1A104KT +1005			
	C129,130	nsp	nsp	CK73D0J226MT(3216)			
	C131	nsp	nsp	CK73B1A104KT +1005			
	C132	nsp	nsp	CK73B1E103KT(1005)			
	C133	nsp	nsp	CK73B1A104KT +1005			
	C134	nsp	nsp	CK73B1E103KT(1005)			
	C135	nsp	nsp	CK73B1A104KT +1005			
	C136,137	nsp	nsp	CK73D0J226MT(3216)			
	C141,142	nsp	nsp	CK73B0J475KT(P) +1608			
	C143	nsp	nsp	CK73F1A105ZT +1608			
	C144,145	nsp	nsp	CK73B0J475KT(P) +1608			
	C146	nsp	nsp	CK73F1A105ZT +1608			
	C147-149	nsp	nsp	CK73B0J475KT(P) +1608			
	C160,161	nsp	nsp	CK73B0J475KT(P) +1608			
	C162	nsp	nsp	CK73B1H102KT +1005			
	C183	nsp	nsp	CS77B1A100MT(NOJ)			
	C184	nsp	nsp	CK73B1H102KT +1005			
	C185-187	nsp	nsp	CK73B1A104KT +1005			
	C188	nsp	nsp	CE67C1A471MT(PXA)			
	C190	nsp	nsp	CK73B1H102KT +1005			
	C191	nsp	nsp	CK73B1A104KT +1005			
	C192	nsp	nsp	CS77B1A100MT(NOJ)			
	C205	nsp	nsp	CK73B1E103KT(1005)			
	C206	nsp	nsp	CS77B1A100MT(NOJ)			
	C207	nsp	nsp	CK73B1A104KT +1005			
	C208	nsp	nsp	CK73B1E103KT(1005)			
	C209,210	nsp	nsp	CC73CH1H470JT			
	C217	nsp	nsp	CK73B1E103KT(1005)			
	C218	nsp	nsp	CC73CH1H101JT +1005			
	C222-224	nsp	nsp	CK73B1A106KT +2125			
	C225-227	nsp	nsp	CK73B1E103KT(1005)			
	C228	nsp	nsp	CK73B1A106KT +2125			

	Ref. No.	Part No. (for EUR)	Part No.	Part Name	Remarks	Q'ty	New
	C229,230	nsp	nsp	CK73B1E103KT(1005)			
	C231	nsp	nsp	CK73B1A106KT +2125			
	C232-284	nsp	nsp	CK73B1E103KT(1005)			
	C285,286	nsp	nsp	CK73D0J226MT(3216)			
	C287-297	nsp	nsp	CK73B1E103KT(1005)			
	C298	nsp	nsp	CK73D0J226MT(3216)			
	C315-350	nsp	nsp	CK73B1E103KT(1005)			
	C351,352	nsp	nsp	CK73D0J226MT(3216)			
	C353,354	nsp	nsp	CK73B1A106KT +2125			
	C355-367	nsp	nsp	CK73B1E103KT(1005)			
	C368	nsp	nsp	CK73D0J226MT(3216)			
	C369-384	nsp	nsp	CK73B1E103KT(1005)			
	C501,502	nsp	nsp	CK73B1A104KT +1005			
	C504,505	nsp	nsp	CK73B0J475KT(P) +1608			
	C506-513	nsp	nsp	CK73B1H102KT +1005			
	C514-521	nsp	nsp	CK73B1A104KT +1005			
	C524-528	nsp	nsp	CK73B1H102KT +1005			
	C529-531	nsp	nsp	CK73B1A104KT +1005			
	C532-534	nsp	nsp	CK73B1H102KT +1005			
	C535	nsp	nsp	CK73B1A104KT +1005			
	C536	nsp	nsp	CK73B1H102KT +1005			
	C537,538	nsp	nsp	CK73B1A104KT +1005			
	C539	nsp	nsp	CK73B1H102KT +1005			
	C540-542	nsp	nsp	CK73B1A104KT +1005			
	C543	nsp	nsp	CK73B1H102KT +1005			
	C544	nsp	nsp	CK73B1A104KT +1005			
	C549	nsp	nsp	CK73B1A104KT +1005			
	C550	nsp	nsp	CK73B1H102KT +1005			
	C551	nsp	nsp	CK73B1A104KT +1005			
	C552,553	nsp	nsp	CK73B0J475KT(P) +1608			
	C554	nsp	nsp	CK73B1H102KT +1005			
	C555	nsp	nsp	CK73B1A104KT +1005			
	C556,557	nsp	nsp	CK73B0J475KT(P) +1608			
	C558,559	nsp	nsp	CK73B1H102KT +1005			
	C560,561	nsp	nsp	CK73B1A104KT +1005			
	C562-565	nsp	nsp	CK73B0J475KT(P) +1608			
	C566	nsp	nsp	CK73B1A106KT +2125			
	C567	nsp	nsp	CK73B1H102KT +1005			
	C568	nsp	nsp	CK73B1A104KT +1005			
	C574	nsp	nsp	CK73D0J226MT(3216)			
	C575	nsp	nsp	CK73B1H102KT +1005			
	C576,577	nsp	nsp	CK73B1A104KT +1005			
	C578	nsp	nsp	CK73B1H102KT +1005			
	C579	nsp	nsp	CK73B1A104KT +1005			
	C580	nsp	nsp	CK73B1H102KT +1005			
	C606	nsp	nsp	CK73B1A104KT +1005			
	C607	nsp	nsp	CK73B1H102KT +1005			
	C608	nsp	nsp	CK73B1A104KT +1005			
	C609	nsp	nsp	CK73B1H102KT +1005			
	C610	nsp	nsp	CK73B1A104KT +1005			
	C611	nsp	nsp	CK73B1H102KT +1005			
	C612,613	nsp	nsp	CK73B1A104KT +1005			
	C614	nsp	nsp	CK73B1A106KT +2125			
	C615	nsp	nsp	CK73B1A104KT +1005			
	C616	nsp	nsp	CK73B1H102KT +1005			

	Ref. No.	Part No. (for EUR)	Part No.	Part Name	Remarks	Q'ty	New
	C617	nsp	nsp	CK73B1A104KT +1005			
	C618	nsp	nsp	CK73B1H102KT +1005			
	C619	nsp	nsp	CK73B1A106KT +2125			
	C620	nsp	nsp	CK73D0J226MT(3216)			
	C621-642	nsp	nsp	CK73B1A104KT +1005			
	C643	nsp	nsp	CK73B1E103KT(1005)			
	C644	nsp	nsp	CK73B1H102KT +1005			
	C645	nsp	nsp	CK73B1A106KT +2125			
	C646	nsp	nsp	CK73D0J226MT(3216)			
	C647-649	nsp	nsp	CK73B1A104KT +1005			
	C650	nsp	nsp	CK73B1A106KT +2125			
	C651	nsp	nsp	CK73D0J226MT(3216)			
	C652-680	nsp	nsp	CK73B1A104KT +1005			
	C701,702	nsp	nsp	CK73B1A104KT +1005			
	C703,704	nsp	nsp	CK73B1E103KT(1005)			
	C705	nsp	nsp	CK73B1A104KT +1005			
	C706,707	nsp	nsp	CK73D0J226MT(3216)			
	C708	nsp	nsp	CK73B1A104KT +1005			
	C709,710	nsp	nsp	CK73B0J475KT(P) +1608			
	C711	nsp	nsp	CK73F1A105ZT +1608			
	C712,713	nsp	nsp	CK73B1A106KT +2125			
	C714-722	nsp	nsp	CK73B1A104KT +1005			
	C723,724	nsp	nsp	CK73D0J476MT(3225)			
	C725,726	nsp	nsp	CK73B1A104KT +1005			
	C727	nsp	nsp	CK73B1E103KT(1005)			
	C728	nsp	nsp	CK73D0J226MT(3216)			
	C729-743	nsp	nsp	CK73B1A104KT +1005			
	C744	nsp	nsp	CC73CH1H470JT			
	C745	nsp	nsp	CK73B1A104KT +1005			
	C746	nsp	nsp	CK73B1E103KT(1005)			
	C747	nsp	nsp	CK73B1A104KT +1005			
	C748	nsp	nsp	CK73B1A106KT +2125			
	C749-766	nsp	nsp	CK73B1A104KT +1005			
	C767	nsp	nsp	CC73CH1H470JT			
	C768	nsp	nsp	CK73B1A104KT +1005			
	C769	nsp	nsp	CK73B1A106KT +2125			
	C770-785	nsp	nsp	CK73B1A104KT +1005			
	C786	nsp	nsp	CK73D0J226MT(3216)			
	C828	nsp	nsp	CK73B1A106KT +2125			
	C829	nsp	nsp	CK73B1E103KT(1005)			
	C830,831	nsp	nsp	CK73B1H102KT +1005			
	C832	nsp	nsp	CK73B1A104KT +1005			
	C833	nsp	nsp	CK73B1A106KT +2125			
	C834	nsp	nsp	CK73B1E103KT(1005)			
	C837	nsp	nsp	CK73B1A106KT +2125			
	C839	nsp	nsp	CK73B1H123KT +1608			
	C840	nsp	nsp	CK73B1H102KT +1005			
	C841,842	nsp	nsp	CK73B1A104KT +1005			
	C843	nsp	nsp	CK73B1H102KT +1005			
	C844	nsp	nsp	CK73B1A104KT +1005			
	C845-847	nsp	nsp	CK73B1E103KT(1005)			
	C848	nsp	nsp	CK73B1A104KT +1005			
	C849	nsp	nsp	CK73B1E103KT(1005)			
	C850	nsp	nsp	CK73B1H123KT +1608			
	C851	nsp	nsp	CK73B1A154KT +1608			

	Ref. No.	Part No. (for EUR)	Part No.	Part Name	Remarks	Q'ty	New
	C852	nsp	nsp	CK73B1A104KT +1005			
	C853	nsp	nsp	CK73B1H102KT +1005			
	C854,855	nsp	nsp	CK73B1A106KT +2125			
	C856,857	nsp	nsp	CK73B1H102KT +1005			
	C858	nsp	nsp	CK73B1A104KT +1005			
	C859	nsp	nsp	CK73B1E103KT(1005)			
	C860	nsp	nsp	CK73B1A106KT +2125			
	C861	nsp	nsp	CK73B1A104KT +1005			
	C862	nsp	nsp	CK73B1H102KT +1005			
	C863	nsp	nsp	CK73B1A154KT +1608			
	C864	nsp	nsp	CK73B1A106KT +2125			
	C865	nsp	nsp	CK73B1H102KT +1005			
	C866,867	nsp	nsp	CK73B1A104KT +1005			
	C870,871	nsp	nsp	CK73B1A104KT +1005			
	C873	nsp	nsp	CK73B1A104KT +1005			
	C874	nsp	nsp	CK73D0J226MT(3216)			
	C875	nsp	nsp	CK73B1H102KT +1005			
	C876	nsp	nsp	CK73B1A104KT +1005			
	C877	nsp	nsp	CK73B0J475KT(P) +1608			
	C878	nsp	nsp	CK73B1H102KT +1005			
	C879,880	nsp	nsp	CS77B1A100MT(NOJ)			
	C881	nsp	nsp	CK73B1A104KT +1005			
	C882	nsp	nsp	CK73B1A106KT +2125			
	C883	nsp	nsp	CK73B1H102KT +1005			
	C884,885	nsp	nsp	CK73B1A104KT +1005			
	C886	nsp	nsp	CK73B1A106KT +2125			
	C887	nsp	nsp	CK73B1H102KT +1005			
	C888-891	nsp	nsp	CK73B1A104KT +1005			
	C892	nsp	nsp	CK73B1H102KT +1005			
	C893	nsp	nsp	CK73B1A104KT +1005			
	C894	nsp	nsp	CK73B1A106KT +2125			
	C895	nsp	nsp	CK73B1E103KT(1005)			
	C896-900	nsp	nsp	CK73B1A104KT +1005			
	C901	nsp	nsp	CK73B1A106KT +2125			
	C902-907	nsp	nsp	CK73B1A104KT +1005			
	C908	nsp	nsp	CK73B1A106KT +2125			
	C909	nsp	nsp	CK73B1H102KT +1005			
	C910,911	nsp	nsp	CK73B1A104KT +1005			
	C912	nsp	nsp	CK73B1A106KT +2125			
	C913	nsp	nsp	CK73B1E103KT(1005)			
	C914,915	nsp	nsp	CK73B1H102KT +1005			
	C916	nsp	nsp	CK73B1A104KT +1005			
	C917	nsp	nsp	CK73B1A106KT +2125			
	C918	nsp	nsp	CK73B1E103KT(1005)			
	C921	nsp	nsp	CC73CH1H100DT +1005			
	C922-924	nsp	nsp	CK73B1E103KT(1005)			
	C925	nsp	nsp	CK73B1A104KT +1005			
	C926	nsp	nsp	CK73B1E103KT(1005)			
	C928	nsp	nsp	CK73B1H123KT +1608			
	C929	nsp	nsp	CK73B1A104KT +1005			
	C930	nsp	nsp	CK73B1H102KT +1005			
	C931	nsp	nsp	CK73B1A106KT +2125			
	C932	nsp	nsp	CK73B1A154KT +1608			
	C933	nsp	nsp	CK73B1H123KT +1608			
	C934	nsp	nsp	CK73B1A106KT +2125			

	Ref. No.	Part No. (for EUR)	Part No.	Part Name	Remarks	Q'ty	New
	C935	nsp	nsp	CK73B1A104KT +1005			
	C936	nsp	nsp	CK73B1H102KT +1005			
	C937	nsp	nsp	CK73B1A154KT +1608			
	CC127	nsp	nsp	CK73B1A104KT +1005			
	CC129,130	nsp	nsp	CK73B0J475KT(P) +1608			
	CC131-138	nsp	nsp	CK73B1A104KT +1005			
	CC139-146	nsp	nsp	CK73B1H102KT +1005			
	CC201-209	nsp	nsp	CK73B1E103KT(1005)			
	CC210	nsp	nsp	CK73D0J226MT(3216)			
	CC211,212	nsp	nsp	CK73B1A106KT +2125			
	CC213-225	nsp	nsp	CK73B1E103KT(1005)			
	CC226	nsp	nsp	CK73D0J226MT(3216)			
	CC227-249	nsp	nsp	CK73B1E103KT(1005)			
	CC250	nsp	nsp	CK73B1A106KT +2125			
	CC251	nsp	nsp	CK73B1E103KT(1005)			
	CC252	nsp	nsp	CK73B1A106KT +2125			
	CC253-263	nsp	nsp	CK73B1E103KT(1005)			
	CC264	nsp	nsp	CK73D0J476MT(3225)			
	CC265	nsp	nsp	CC73CH1H470JT			
	CC266	nsp	nsp	CK73D0J476MT(3225)			
	CC267	nsp	nsp	CC73CH1H470JT			
	CC268,269	nsp	nsp	CK73D0J476MT(3225)			
	CC270-281	nsp	nsp	CK73B1E103KT(1005)			
	CC282,283	nsp	nsp	CK73B1A106KT +2125			
	CC284-291	nsp	nsp	CK73B1E103KT(1005)			
	CC292-295	nsp	nsp	CK73B1A104KT +1005			
	CC296	nsp	nsp	CK73B1E103KT(1005)			
	CC297,298	nsp	nsp	CK73B1A104KT +1005			
	CC299	nsp	nsp	CK73B1E103KT(1005)			
	CC300-303	nsp	nsp	CK73B1A104KT +1005			
	CC304,305	nsp	nsp	CK73D0J226MT(3216)			
	CC306	nsp	nsp	CK73B1H153KT +1608			
	CC307	nsp	nsp	CK73D0J226MT(3216)			
	CC308	nsp	nsp	CK73B1A104KT +1005			
	CC309	nsp	nsp	CK73B1H153KT +1608			
	CC310	nsp	nsp	CK73D0J226MT(3216)			
	CC311	nsp	nsp	CK73B1A106KT +2125			
	CC312,313	nsp	nsp	CK73B1A104KT +1005			
	CC314	nsp	nsp	CK73D0J226MT(3216)			
	CC315	nsp	nsp	CK73B1A104KT +1005			
	CC316	nsp	nsp	CK73B1E103KT(1005)			
	CC317,318	nsp	nsp	CK73B1A104KT +1005			
	CC319	nsp	nsp	CK73B1E103KT(1005)			
	CC320	nsp	nsp	CK73B1A104KT +1005			
	CC321-323	nsp	nsp	CK73D0J226MT(3216)			
	CC401	nsp	nsp	CK73B1H102KT +1005			
	CC402	nsp	nsp	CK73B1A104KT +1005			
	CC403	nsp	nsp	CK73B1H102KT +1005			
	CC404	nsp	nsp	CK73B1A104KT +1005			
	CC407,408	nsp	nsp	CK73B1A104KT +1005			
	CC409	nsp	nsp	CK73B1H102KT +1005			
	CC410	nsp	nsp	CK73B1E103KT(1005)			
	CC411	nsp	nsp	CK73B1A104KT +1005			
	CC412	nsp	nsp	CK73B1A106KT +2125			

	Ref. No.	Part No. (for EUR)	Part No.	Part Name	Remarks	Q'ty	New
	CC501,502	nsp	nsp	CK73B0J475KT(P) +1608			
	CC503-506	nsp	nsp	CK73B1H102KT +1005			
	CC507-509	nsp	nsp	CK73B1A104KT +1005			
	CC510-512	nsp	nsp	CK73B1H102KT +1005			
	CC513	nsp	nsp	CK73B1A104KT +1005			
	CC514,515	nsp	nsp	CK73B1H102KT +1005			
	CC516,517	nsp	nsp	CK73B1A104KT +1005			
	CC518	nsp	nsp	CK73B1H102KT +1005			
	CC519-521	nsp	nsp	CK73B1A104KT +1005			
	CC522	nsp	nsp	CK73B1H102KT +1005			
	CC523	nsp	nsp	CK73B1A104KT +1005			
	CC528	nsp	nsp	CK73B1A104KT +1005			
	CC529	nsp	nsp	CK73B1H102KT +1005			
	CC530	nsp	nsp	CK73B1A104KT +1005			
	CC531,532	nsp	nsp	CK73B0J475KT(P) +1608			
	CC533	nsp	nsp	CK73B1H102KT +1005			
	CC534	nsp	nsp	CK73B1A104KT +1005			
	CC535,536	nsp	nsp	CK73B0J475KT(P) +1608			
	CC537,538	nsp	nsp	CK73B1H102KT +1005			
	CC539,540	nsp	nsp	CK73B1A104KT +1005			
	CC541-544	nsp	nsp	CK73B0J475KT(P) +1608			
	CC549-552	nsp	nsp	CK73B1A104KT +1005			
	CC802	nsp	nsp	CK73B1A104KT +1005			
	CC804	nsp	nsp	CK73B1A104KT +1005			
	CC805	nsp	nsp	CK73B0J475KT(P) +1608			
	CC806	nsp	nsp	CK73B1A104KT +1005			
	CC807,808	nsp	nsp	CS77B1A100MT(NOJ)			
	CC809	nsp	nsp	CK73B1A104KT +1005			
	CC956,957	nsp	nsp	CK73B1A104KT +1005			
	CC958	nsp	nsp	CK73B1E103KT(1005)			
	CC959	nsp	nsp	CK73B1A104KT +1005			
	CC960	nsp	nsp	CS77B1A100MT(NOJ)			
	CC961-964	nsp	nsp	CK73B1A106KT +2125			
	CC965	nsp	nsp	CK73B1A104KT +1005			
	CC972-974	nsp	nsp	CK73B1A104KT +1005			
	CC975	nsp	nsp	CE67C0J471MT (RV) +REF			
	CC980	nsp	nsp	CE67C0J471MT (RV) +REF			
	CC982	nsp	nsp	CE67C0J471MT (RV) +REF			
	CC984	nsp	nsp	CE67C0J471MT (RV) +REF			
	CC986	nsp	nsp	CE67C0J471MT (RV) +REF			
OTHERS PARTS GROUP							
	CX031	nsp	nsp	3P PH CON BASE SIDE			
	CX051	nsp	nsp	5P VH CONNECTOR BASE			
	CX079	nsp	nsp	7P FFC BASE(9610SC)			
	CX404	nsp	nsp	40P-FFC-BASE(6222_101)			
	CX801	nsp	nsp	80P-PLUG(404)			
	FB101	nsp	nsp	FBMJ1608HS280NT +1608			
	FB104,105	nsp	nsp	FBMJ1608HS280NT +1608			
	FB107	nsp	nsp	FBMJ1608HS280NT +1608			
	FB202-207	nsp	nsp	MPZ1608S221A			*
	FB208	nsp	nsp	FBMJ1608HS280NT +1608			
	FB501	nsp	nsp	FBMJ1608HS280NT +1608			

Ref. No.	Part No. (for EUR)	Part No.	Part Name	Remarks	Q'ty	New
FB502-517	nsp	nsp	MPZ1608S221A			*
FB601-608	nsp	nsp	MPZ1608S221A			*
FB701	nsp	nsp	MPZ1608S221A			*
FB702	nsp	nsp	FBMJ1608HS280NT +1608			
FB703	nsp	nsp	MPZ1608S221A			*
FB802-814	nsp	nsp	FBMJ1608HS280NT +1608			
FB888-890	nsp	nsp	FBMJ1608HS280NT +1608			
JK601	644010062702S	644010062702S	HDMI CONNECTOR			*
JK605	644010062702S	644010062702S	HDMI CONNECTOR			*
JK901-904	643010023605S	643010023605S	1P PIN JACK(AU,shield)			*
JK905	00D2051395005	00D2051395005	1P S-TERMINAL-LF			
L803	nsp	nsp	INDUCTOR(FLC32C220K)+3216			
L806	nsp	nsp	INDUCTOR(FLC32C220K)+3216			
L901	nsp	nsp	INDUCTOR(FLC32C220K)+3216			
RL501,502	nsp	nsp	RELAY(UB2-5NUN-L1)			
W102-104	nsp	nsp	M3 SCREW TERMINAL			
X201	nsp	nsp	FCXO-05(66.666MHz)			
X601	nsp	nsp	FCXO-05 (30.00MHz)			*
X801	nsp	nsp	FCXO-05 (27.00MHz)			*
	nsp	nsp	1P CONTACT ASSY 140&165mm			
	nsp	nsp	HEAT SHEET (GP1-2.0)			
	nsp	nsp	HEAT SINK(PUE-56)			
	nsp	nsp	HEAT SINK BRACKET			
	nsp	nsp	3X6 CFS-B			
	nsp	nsp	CUPPER TAPE(W=15)			

8U-310010A FE/SACD PWB UNIT ASSY

Ref. No.	Part No. (for EUR)	Part No.	Part Name	Remarks	Q'ty	New
SEMICONDUCTORS GROUP						
IC100	nsp	nsp	R8J32801AFPV			*
IC104	nsp	nsp	BA2904F-E2			*
IC106	nsp	nsp	AD8062ARMZ-R7			*
IC107	nsp	nsp	BA6846FV-E2			*
IC108	nsp	nsp	BA5961FV-E2			*
IC151	nsp	nsp	BD7956FS-E2			*
IC301	nsp	nsp	BH18MA3WHFV-TR			*
IC302	nsp	nsp	MM1661ZHBE			*
IC303	nsp	nsp	MM1687CFBE			*
IC304	nsp	nsp	MM1825YHBE			*
IC305	nsp	nsp	BU19502KV-SE2			*
IC306	nsp	nsp	MM1665AHBE			*
IC502	nsp	nsp	M12L16161A-7TG			
IC503	nsp	nsp	CXD2753R +C			
IC504	nsp	nsp	SN74LVC04APW-EL2			*
IC602	nsp	nsp	BA25BC0FP-E2			
IC603	nsp	nsp	BA00HC5FP			
IC605	nsp	nsp	W19B160BBT7H			
IC606	nsp	nsp	XC3S500E-4FTG256C			*
IC901	nsp	nsp	SN74LVC2G04DBVR			*
IC902	nsp	nsp	SN74CBTLV16210GR			*
IC903	nsp	nsp	SN74CBTLV16212GR			*
IC904	nsp	nsp	SN74CBTLV16210GR			*
IC905	nsp	nsp	SN74LV08APW-EL2 +REF			
IC906	nsp	nsp	SN74LV32APW-EL2 +C			
IC961	nsp	nsp	EN5311QI-T			*
TR501	nsp	nsp	DTC114EKT96 +C			
TR502	nsp	nsp	DTA114EKT96 +C			
TR503	nsp	nsp	DTC114EKT96 +C			
TR504	nsp	nsp	DTA114EKT96 +C			
D901,902	nsp	nsp	1SS355 TE-17 +C			
D903-905	nsp	nsp	1SR154-400TE25 +REF			
D906-910	nsp	nsp	1SS355 TE-17 +C			
RESISTORS GROUP						
R137	nsp	nsp	RS14B3A010JNBST(S)			
R159	nsp	nsp	RM73B-123FT +1608			
R253,254	nsp	nsp	RM73B-103DT_1005			*
R255	nsp	nsp	RM73B-332DT(1608)			
R273,274	nsp	nsp	RM73B-103DT_1005			*
R320	nsp	nsp	RM73B-123FT +1608			
R322	nsp	nsp	RM73B-224DT(1608)			
RR130	nsp	nsp	RS14B3A010JNBST(S)			
RR139-142	nsp	nsp	RM73B-103DT_1005			*
RR905-907	nsp	nsp	RM73B-102FT +1608			
RR917	nsp	nsp	RM73B2B0R0KT +3216			
RA401,402	nsp	nsp	MNR14=220JE0AB +C			

Ref. No.	Part No. (for EUR)	Part No.	Part Name	Remarks	Q'ty	New
CAPACITORS GROUP						
C101	nsp	nsp	CK73B1A105KT +1608			
C102	nsp	nsp	CE67C1C101MT (RV2) +REF			
C103-105	nsp	nsp	CK73B1A105KT +1608			
C106,107	nsp	nsp	CK73F1H103ZT +1005			
C108-110	nsp	nsp	CK73B1E103KT(1005)			
C111	nsp	nsp	CK73F1H103ZT +1005			
C112	nsp	nsp	CK73B1A106KT +2125			
C113	nsp	nsp	CK73F1H103ZT +1005			
C114	nsp	nsp	CK73B1A106KT +2125			
C115	nsp	nsp	CK73B1A105KT +1608			
C116	nsp	nsp	CK73F1C104ZT +1005			
C117,118	nsp	nsp	CK73B1A105KT +1608			
C119,120	nsp	nsp	CK73B1E223KT +1608			
C121,122	nsp	nsp	CK73F1C104ZT +1005			
C123,124	nsp	nsp	CK73B1A474KT			
C125	nsp	nsp	CK73B1E223KT +1608			
C126	nsp	nsp	CK73F1H103ZT +1005			
C127	nsp	nsp	CK73F1C104ZT +1005			
C129,130	nsp	nsp	CK73F1H103ZT +1005			
C131	nsp	nsp	CK73B1H222KT +1608			
C132	nsp	nsp	CK73B1E103KT(1005)			
C133	nsp	nsp	CC73CH1H471JT +1608			
C134	nsp	nsp	CK73F1H103ZT +1005			
C135-138	nsp	nsp	CK73B1E683KT(1608) +1608			
C139,140	nsp	nsp	CK73B1A104KT +1005			
C141	nsp	nsp	CK73F1C104ZT +1005			
C142	nsp	nsp	CK73B1A106KT +2125			
C143	nsp	nsp	CK73F1H103ZT +1005			
C144	nsp	nsp	CC73CH1H331JT +1608			
C145	nsp	nsp	CK73B1A106KT +2125			
C146-148	nsp	nsp	CC73CH1H471JT +1608			
C149	nsp	nsp	CK73B1A104KT +1005			
C150,151	nsp	nsp	CK73B1H102KT +1005			
C152	nsp	nsp	CC73CH1H471JT +1608			
C153	nsp	nsp	CK73B1A104KT +1005			
C154	nsp	nsp	CK73B1E103KT(1005)			
C155	nsp	nsp	CK73F1H103ZT +1005			
C156-158	nsp	nsp	CK73F1C104ZT +1005			
C159	nsp	nsp	CK73F1H103ZT +1005			
C160,161	nsp	nsp	CK73B1E103KT(1005)			
C162	nsp	nsp	CK73F1H103ZT +1005			
C163,164	nsp	nsp	CK73F1C104ZT +1005			
C165	nsp	nsp	CC73CH1H101JT +1005			
C166	nsp	nsp	CK73B1A106KT +2125			
C167-170	nsp	nsp	CK73F1C104ZT +1005			
C171,172	nsp	nsp	CK73F1H103ZT +1005			
C173	nsp	nsp	CK73F1C104ZT +1005			
C174	nsp	nsp	CE67C1C220MT (RV2) +REF			
C175-177	nsp	nsp	CK73F1C104ZT +1005			
C178	nsp	nsp	CK73F1H103ZT +1005			
C179	nsp	nsp	CK73F1C104ZT +1005			
C180,181	nsp	nsp	CK73F1H103ZT +1005			
C182	nsp	nsp	CK73B1E103KT(1005)			
C185-187	nsp	nsp	CK73F1H103ZT +1005			

	Ref. No.	Part No. (for EUR)	Part No.	Part Name	Remarks	Q'ty	New
	C188,189	nsp	nsp	CK73F1C104ZT +1005			
	C190	nsp	nsp	CK73F1H103ZT +1005			
	C191,192	nsp	nsp	CK73F1C104ZT +1005			
	C193-195	nsp	nsp	CK73B1A104KT +1005			
	C196-198	nsp	nsp	CK73F1C104ZT +1005			
	C199,200	nsp	nsp	CK73F1H103ZT +1005			
	C201-203	nsp	nsp	CK73F1C104ZT +1005			
	C204,205	nsp	nsp	CC73CH1H8R0DT +1608			
	C206,207	nsp	nsp	CK73B1E103KT(1005)			
	C208,209	nsp	nsp	CK73B1A104KT +1005			
	C210	nsp	nsp	RM73B-0R0KT+1005			
	C211,212	nsp	nsp	CK73B1E103KT(1005)			
	C213	nsp	nsp	CE67C1C220MT (RV2) +REF			
	C214	nsp	nsp	CE67C1C101MT (RV2) +REF			
	C215	nsp	nsp	CK73F1C104ZT +1005			
	C216	nsp	nsp	CK73B1H103KT (1608) +1608			
	C217	nsp	nsp	CE67C0J101MT (RV2) +REF			
	C218,219	nsp	nsp	CK73F1C104ZT +1005			
	C222	nsp	nsp	CE67C1C101MT (RV2) +REF			
	C223	nsp	nsp	CK73B1A106KT +2125			
	C224	nsp	nsp	CK73F1C104ZT +1005			
	C226	nsp	nsp	CK73F1C104ZT +1005			
	C227	nsp	nsp	CK73F1H103ZT +1005			
	C230	nsp	nsp	CK73F1C104ZT +1005			
	C231-234	nsp	nsp	CE67C0J220MT (RV2) +REF			
	C235	nsp	nsp	CE67C0J101MT (RV2) +REF			
	C301,302	nsp	nsp	CE67C0J101MT (RV2) +REF			
	C303	nsp	nsp	CK73F1C104ZT +1005			
	C304-308	nsp	nsp	CK73F1H103ZT +1005			
	C309,310	nsp	nsp	CK73B1E103KT(1005)			
	C311	nsp	nsp	CK73F1H103ZT +1005			
	C312,313	nsp	nsp	CK73B1E103KT(1005)			
	C314	nsp	nsp	CK73F1C104ZT +1005			
	C315	nsp	nsp	CK73F1H103ZT +1005			
	C316,317	nsp	nsp	CC73CH1H120JT +1005			
	C318	nsp	nsp	CK73F1C104ZT +1005			
	C319-323	nsp	nsp	CK73F1H103ZT +1005			
	C324-326	nsp	nsp	CK73F1C104ZT +1005			
	C401	nsp	nsp	CK73F1C104ZT +1005			
	C402	nsp	nsp	CE67C0J101MT (RV2) +REF			
	C403,404	nsp	nsp	CK73F1C104ZT +1005			
	C406-411	nsp	nsp	CK73F1C104ZT +1005			
	C412	nsp	nsp	CE67C0J220MT (RV2) +REF			
	C413	nsp	nsp	CK73B1H102KT +1005			
	C414,415	nsp	nsp	CK73F1C104ZT +1005			
	C418	nsp	nsp	CK73F1C104ZT +1005			
	C423-426	nsp	nsp	CK73F1C104ZT +1005			
	C427	nsp	nsp	CE67C0J101MT (RV2) +REF			
	C428-432	nsp	nsp	CK73F1C104ZT +1005			
	C433	nsp	nsp	CE67C0J101MT (RV2) +REF			
	C434	nsp	nsp	CK73F1H103ZT +1005			
	C435	nsp	nsp	CK73F1C104ZT +1005			
	C501	nsp	nsp	CK73F1C104ZT +1005			
	C502	nsp	nsp	CC73CH1H102JT +1608			
	C503	nsp	nsp	CK73F1C104ZT +1005			

	Ref. No.	Part No. (for EUR)	Part No.	Part Name	Remarks	Q'ty	New
	C504	nsp	nsp	CC73CH1H102JT +1608			
	C505	nsp	nsp	CK73F1C104ZT +1005			
	C506	nsp	nsp	CC73CH1H102JT +1608			
	C507	nsp	nsp	CK73F1C104ZT +1005			
	C508	nsp	nsp	CC73CH1H102JT +1608			
	C509	nsp	nsp	CS77B1A100MT(NOJ)			
	C510	nsp	nsp	CE67C0J101MT (RV2) +REF			
	C511	nsp	nsp	CK73F1C104ZT +1005			
	C512	nsp	nsp	CC73CH1H102JT +1608			
	C513	nsp	nsp	CK73F1C104ZT +1005			
	C514	nsp	nsp	CC73CH1H102JT +1608			
	C515	nsp	nsp	CK73F1C104ZT +1005			
	C516	nsp	nsp	CC73CH1H102JT +1608			
	C517	nsp	nsp	CK73F1C104ZT +1005			
	C518	nsp	nsp	CC73CH1H102JT +1608			
	C519	nsp	nsp	CS77B1A100MT(NOJ)			
	C520	nsp	nsp	CK73F1C104ZT +1005			
	C521	nsp	nsp	CC73CH1H102JT +1608			
	C522	nsp	nsp	CK73F1C104ZT +1005			
	C523	nsp	nsp	CC73CH1H102JT +1608			
	C524	nsp	nsp	CK73F1C104ZT +1005			
	C525	nsp	nsp	CC73CH1H102JT +1608			
	C526	nsp	nsp	CS77B1A100MT(NOJ)			
	C528	nsp	nsp	CK73F1C104ZT +1005			
	C530	nsp	nsp	CC73CH1H102JT +1608			
	C531	nsp	nsp	CS77B1A100MT(NOJ)			
	C533	nsp	nsp	CE67C1C101MT (RV2) +REF			
	C535	nsp	nsp	CK73F1H103ZT +1005			
	C536	nsp	nsp	CK73F1C104ZT +1005			
	C538	nsp	nsp	CK73B1H102KT +1005			
	C751-753	nsp	nsp	CK73F1C104ZT +1005			
	C754	nsp	nsp	CK73F1H103ZT +1005			
	C755	nsp	nsp	CK73F1C104ZT +1005			
	C756	nsp	nsp	CK73F1H103ZT +1005			
	C757	nsp	nsp	CK73F1C104ZT +1005			
	C758	nsp	nsp	CK73F1H103ZT +1005			
	C759	nsp	nsp	CK73F1C104ZT +1005			
	C901	nsp	nsp	CK73B1A105KT +1608			
	C902	nsp	nsp	CS77B1A100MT(NOJ)			
	C903,904	nsp	nsp	CK73B1A105KT +1608			
	C905	nsp	nsp	CE67C0J220MT (RV2) +REF			
	C906,907	nsp	nsp	CK73B1A105KT +1608			
	C908,909	nsp	nsp	CE67C0J101MT (RV2) +REF			
	C910	nsp	nsp	CS77B1A100MT(NOJ)			
	C911,912	nsp	nsp	CE67C0J101MT (RV2) +REF			
	C913	nsp	nsp	CK73B1A105KT +1608			
	C914	nsp	nsp	CE67C0J220MT (RV2) +REF			
	C915	nsp	nsp	CK73F1C104ZT +1005			
	C916	nsp	nsp	CK73B1H103KT (1608) +1608			
	C917	nsp	nsp	CK73F1H103ZT +1005			
	C918	nsp	nsp	CK73B1A106KT +2125			
	C919	nsp	nsp	CK73F1C104ZT +1005			
	C920	nsp	nsp	CK73F1H103ZT +1005			
	C921	nsp	nsp	CK73B1A106KT +2125			
	C922	nsp	nsp	CC73CH1H471JT +1608			

	Ref. No.	Part No. (for EUR)	Part No.	Part Name	Remarks	Q'ty	New
	C923,924	nsp	nsp	CK73F1C104ZT +1005			
	C925,926	nsp	nsp	CE67C0J220MT (RV2) +REF			
	C927,928	nsp	nsp	CK73B1A106KT +2125			
	C929	nsp	nsp	CK73B1E223KT +1608			
	C930	nsp	nsp	CK73F1C104ZT +1005			
	C931	nsp	nsp	CE67C0J220MT (RV2) +REF			
	C932	nsp	nsp	CK73F1C104ZT +1005			
	C933	nsp	nsp	CK73B1A105KT +1608			
	C934	nsp	nsp	CK73F1C104ZT +1005			
	C935	nsp	nsp	CE67C0J220MT (RV2) +REF			
	C937	nsp	nsp	CE67C1C101MT (RV2) +REF			
	C938	nsp	nsp	CK73F1C104ZT +1005			
	C940	nsp	nsp	CE67C0J101MT (RV2) +REF			
	C941	nsp	nsp	CE67C1C101MT (RV2) +REF			
	C942	nsp	nsp	CK73F1C104ZT +1005			
	C943	nsp	nsp	CK73B1A105KT +1608			
	C944	nsp	nsp	CK73B1A106KT +2125			
	C945	nsp	nsp	CK73B1H103KT (1608) +1608			
	C946,947	nsp	nsp	CE67C1C101MT (RV2) +REF			
	C948,949	nsp	nsp	CK73F1C104ZT +1005			
	C950	nsp	nsp	CK73B1A106KT +2125			
	C951	nsp	nsp	CE67C1C101MT (RV2) +REF			
	C952	nsp	nsp	CK73F1C104ZT +1005			
	C953	nsp	nsp	CE67C1C101MT (RV2) +REF			
	C954	nsp	nsp	CK73F1C104ZT +1005			
	C955	nsp	nsp	CE67C1C101MT (RV2) +REF			
	C956	nsp	nsp	CK73F1C104ZT +1005			
	C957	nsp	nsp	CK73B1A106KT +2125			
	C960	nsp	nsp	CK73B1A106KT +2125			
	C962	nsp	nsp	CK73F1E104ZT +1608			
	C963	nsp	nsp	CK73B1H103KT (1608) +1608			
	C964	nsp	nsp	CK73F1E104ZT +1608			
	C965	nsp	nsp	CK73B1H103KT (1608) +1608			
	C990,991	nsp	nsp	CK73F1C104ZT +1005			
	C992	nsp	nsp	CK73B1A106KT +2125			
	C993	nsp	nsp	CC73CH1H471JT +1608			
	C994	nsp	nsp	CK73B1A106KT +2125			
OTHERS PARTS GROUP							
	CX061	nsp	nsp	6P PH CON.BASE(L) +REF			
	CX063	nsp	nsp	6P VH CONNECTOR BASE			
	CX071	nsp	nsp	7P PH CON.BASE(L) +REF			
	CX182	nsp	nsp	18P-FFC-BASE(9617S)			*
	CX402	nsp	nsp	40P-FFC-BASE(FH12)			
	CX451,452	nsp	nsp	45P-FFC-BASE(9637SA)			*
	FB101-105	nsp	nsp	FBMJ1608HS280NT +1608			
	FB106,107	nsp	nsp	RM73B--0R0KT +1608			
	FB301,302	nsp	nsp	RM73B--0R0KT +1608			
	FB901,902	nsp	nsp	FBMJ1608HS280NT +1608			
	FB904-908	nsp	nsp	FBMJ1608HS280NT +1608			
	FB910,911	nsp	nsp	FBMJ1608HS280NT +1608			
	FB912,913	nsp	nsp	MMZ1608D241C			
	FB914-919	nsp	nsp	FBMJ1608HS280NT +1608			

	Ref. No.	Part No. (for EUR)	Part No.	Part Name	Remarks	Q'ty	New
	FB920-931	nsp	nsp	RM73B-0R0KT +1608			
	FB932	nsp	nsp	FBMJ1608HS280NT +1608			
	FB933-936	nsp	nsp	RM73B-0R0KT +1608			
	X100	nsp	nsp	FCX-03(33.8688MHZ)			*
	X301	nsp	nsp	FCX-03(25MHZ)			
		nsp	nsp	100mm UL1571AWG30			

8U-210075A FE REG PWB UNIT ASSY

	Ref. No.	Part No. (for EUR)	Part No.	Part Name	Remarks	Q'ty	New
SEMICONDUCTORS GROUP							
	IC101	231810059508S	231810059508S	BA50DD0WHFP-TR			*
	D101	00D2760717903	00D2760717903	1SS355 TE-17 +C			
CAPACITORS GROUP							
	C101	00D2544655906	00D2544655906	CE67C0J220MT (RV2) +REF			
	C102	nsp	nsp	CK73F1C104ZT +1005			
	C103	nsp	nsp	CK73F1H103ZT +1005			
	C104	nsp	nsp	CK73F1C104ZT +1005			
	C105	00D2574012917	00D2574012917	CE67C1C220MT (RV2) +REF			
	C106	00D2544655906	00D2544655906	CE67C0J220MT (RV2) +REF			
	C107,108	00D2574011905	00D2574011905	CE67C0J101MT (RV2) +REF			
OTHERS PARTS GROUP							
	CX059	nsp	nsp	5P PH CON.BASE(L) +REF			
	FB101,102	00D2350136907	00D2350136907	FBMJ1608HS280NT +1608			

1U-3791 FGCX P.W.B. UNIT ASS'Y

	Ref. No.	Part No. (for EUR)	Part No.	Part Name	Remarks	Q'ty	New
SEMICONDUCTORS GROUP							
	LD101,102	00D2690220007	00D2690220007	GP1S094HCZ(JP)			
CAPACITORS GROUP							
	C101-105	nsp	nsp	CK73B1E104KT +1608			
OTHERS PARTS GROUP							
	CX031	nsp	nsp	3P CONN.BASE(KR-PH)			
	CX032	nsp	nsp	3P CONN.BASE(KR-PH)			
	CX033	nsp	nsp	3P CONNE.BASE(BLK)			
	CX061	nsp	nsp	6P CONN.BASE(KR-PH)			
	CX071	nsp	nsp	7P CONN.BASE(KR-PH)			
	CY051	nsp	nsp	5P CONN.BASE(KR-PH)			
	S101	00D2121206008	00D2121206008	SPVF130100			

WIRING DIAGRAM

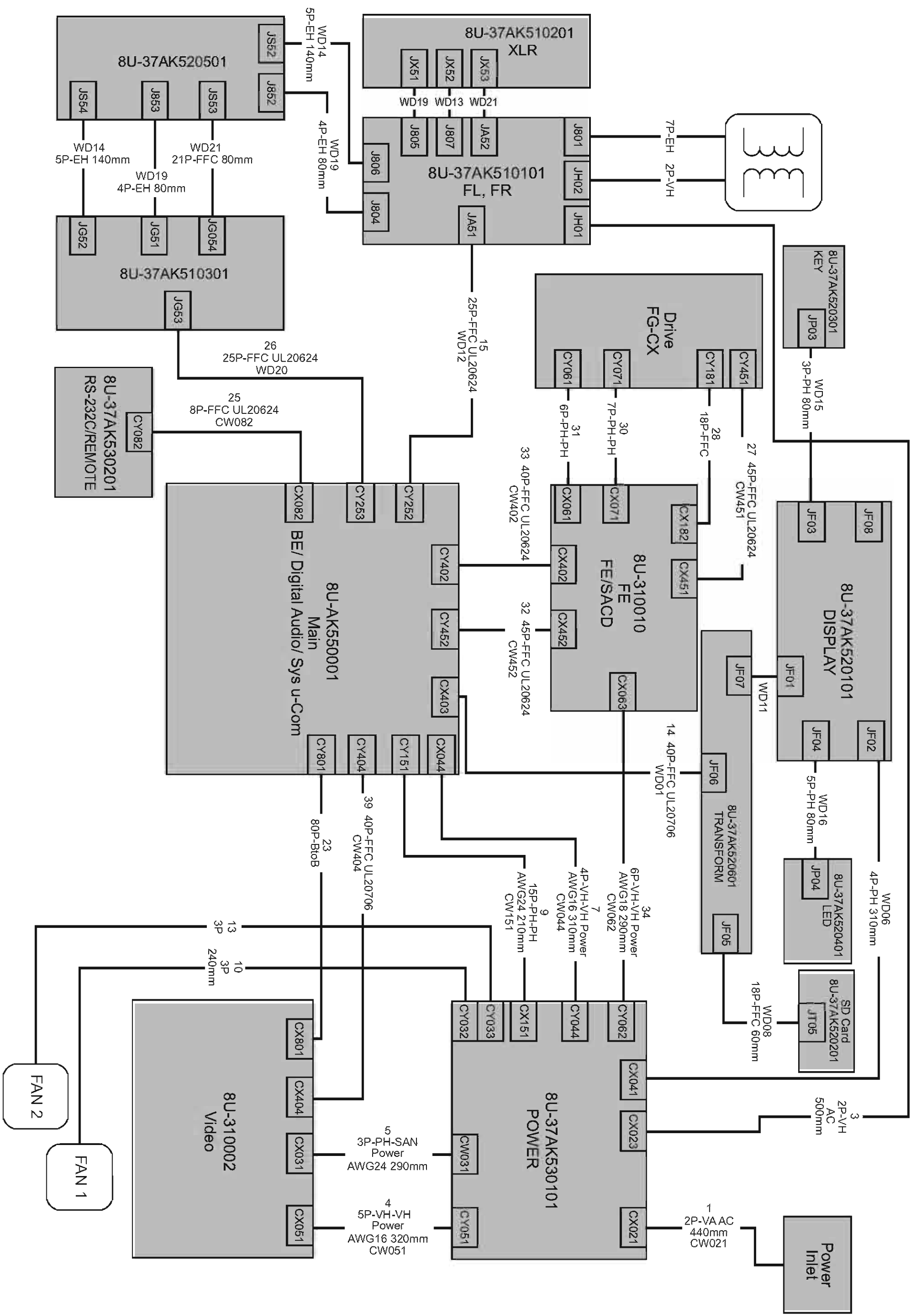

PARTS LIST OF EXPLODED VIEW

* Parts for which "nsp" is indicated on this table cannot be supplied.

* P.W.B. ASS'Y for which "nsp" is indicated on his table cannot be supplied. When repairing the P.W.B. ASS'Y, check the board parts table and order replacement parts.

* The parts listed below are for maintenance only, might differ from the parts used in the unit in appearances or dimensions.

* Part indicated with the mark "★" is not illustrated in the exploded view.

Note: The symbols in the column "Remarks" indicate the following destinations.

U : North America model

N : Europe model

S : Singapore model

R : Russia model

Ref. No.	Part No.	Part Name	Remarks	Q'ty	New
△	A	nsp	AUDIO PWB ASSY	1	*
	A-1	-	AUDIO FRONT L/R PWB		*
	A-2	-	AUDIO XLR PWB		*
	A-3	-	AUDIO SUR_BACK/S_W PWB		*
	B	nsp	FRONT/AUDIO PWB ASSY	1	*
	B-1	-	FRONT PWB		*
	B-2	-	SD CARD PWB		*
	B-3	-	KEY PWB		*
	B-4	-	STANDBY KEY LED PWB		*
	B-5	-	AUDIO SUR/CENTER PWB		*
	B-6	-	CONNECTOR PWB		*
	C	nsp	POWER PWB ASSY (8U-210048AZ)	1	*
△	C-1	-	POWR PWB ASSY		*
	C-2	-	RS232C/REMOTE PWB ASSY		*
	D	8U-310002AZ	VIDEO UNIT	1	
	E	8U-37AK550002	MAIN PWB ASSY	1	*
	E	8U-37AK550003	MAIN PWB ASSY	1	*
	E	8U-37AK550004	MAIN PWB ASSY	1	*
	E	8U-37AK550005	MAIN PWB ASSY	1	*
	F	8M3041000100M	BD MECHA UNIT FOR MARANTZ	1	*
	F-1	-	BD LORDING UNIT FOR MARANTZ		*
	F-2	-	FE/SACD UNIT0		
	★ F-3	-	FE REG PWB UNIT0		
	1	402410073003M	FRONT AL PANEL BL UD9004 37AK	1	*
	2	421410006004M	MARANTZ BADGE (AL) FOR M1 MODEL	1	
	3	421410011006M	BADGE BD UD9004 37AK	1	*
	4	441510036107M	FRONT MOLD CHASSIS BL UD9004 37AK	1	*
	5	416510029004M	WINDOW UD9004 37AK	1	*
	6	nsp	BUFFER DOOR UD9004 37AK	2	*
	7	422510030009M	ESCUTCHEON INNER DOOR UD9004 37AK	1	*
	8	00M271K305010	MAGNET	1	
	9	411510089001M	BUTTON AL CAP TRAY SIDE BL UD9004 37AK	4	*
	10	411510087005M	BUTTON TRAY UNDER BL UD9004 37AK	2	*
	11	411510088008M	BUTTON DOOR INNER BL UD9004 37AK	1	*
	12	415410013007M	DOOR AL PANEL BL UD9004 37AK	1	*
	13	417510011105M	HINGE DOOR L BL UD9004 37AK	1	*
	14	417510012108M	HINGE DOOR R BL UD9004 37AK	1	*
	15	nsp	BRACKET DOOR MAGNET UD9004 37AK	1	*
	16	nsp	SHAFT DOOR UD9004 37AK	2	*
	17	nsp	BRACKET DUMPER UD9004 37AK	1	*
	18	474510007017M	DAMPER NIFCO 001P E 3.9MN_M	1	*
	19	404510023102M	SIDE ESCUTCHEON L BL UD9004 37AK	1	*
	20	411510021005M	BUTTON BL	1	
	21	481510003006M	LENS	1	
	22	404510024105M	SIDE ESCUTCHEON R BL UD9004 37AK	1	*
	23	nsp	BUFFER	2	
	24	403310027004M	TOP COVER CENTER BL UD9004 37AK	1	*

	Ref. No.	Part No.	Part Name	Remarks	Q'ty	New
	25	403310028106M	TOP COVER L UD9004 37AK		1	*
	26	403310029109M	TOP COVER R UD9004 37AK		1	*
	27	nsp	BUFFER		4	
	29	nsp	BUFFER KITAGAWA SHSG-010050		4	
	32	nsp	BUFFER		2	
	38	407410013006M	LEG COPPER		4	*
	40	00M208J259010	BUSH		1	
	42	nsp	SHIELD CU-SHEET UD9004 37AK		1	*
	43	nsp	PUSH RIVET KOYO P3555 94V-2		3	
	44	nsp	SHEET UD9004 37AK		1	*
	48	0RD4737033003	3X32 CBTS-S (B)		8	
	49	nsp	LOCKING CARD SPACER		5	
	57	nsp	BUFFER		1	
	58	512350002006P	SCREW(2.9X8)		4	
	59	449010013004D	FAN(3110RL-04W-S29-C04_80X80X25)		2	
	62	422410031003M	ESCUTCHEON TRAY BL UD9004 37AK		1	*
	64	421410013002M	BADGE MECHA UD9004 37AK		2	*
	65	nsp	BRACKET MECHA FRONT UD9004 37AK		1	*
	66	nsp	LASER LABEL		1	
△	67	00D2033996008	AC INLET (2P)		1	
△	68	101010031010M	MAIN TRANSFORMER AC230V TOROIDAL	for N, S, R	1	
△	68	101010031027M	MAIN TRANSFORMER AC120V TOROIDAL	for U	1	
	★ 69	451510044105D	FFC HOLDER		1	
	★ 70	00D3420032024	FERRITE CLAMP(RFC-9)		1	
	★ 71	00MFC50250020	TFCK-25-15-12		1	
	★ 72	00MFC50230010	TFCK-23-11-14		1	
	★ 73	nsp	LABEL BD ZONE UD9004 (S) 37AK	for S	1	*
	★ 73	nsp	LABEL BD ZONE UD9004 (R) 37AK	for R	1	*
SCREWS						
	101	509350001007D	3X8 BBS		2	
WIRES						
	★ 301	nsp	15P/2P 210mm PH/ZH-PH		1	
	★ 302	nsp	2P 260MM PH-PH		1	*
	★ 303	nsp	2P 440mm VA		1	
	★ 304	nsp	2P 500MM VA-VA		1	*
	★ 305	nsp	3P 80MM PH-PH		1	*
	★ 306	nsp	4P 310mm PH-PH		1	
	★ 307	nsp	4P 310mm VH-VH		1	
	★ 308	nsp	4P 80MM EH-EH		3	*
	★ 309	nsp	5P 140MM EH-EH		2	*
	★ 310	nsp	5P 320mm VH-VH		1	
	★ 311	nsp	5P 80MM PH-PH		1	*
	★ 312	nsp	6P 190MM EH-EH		1	*
	★ 313	nsp	6P 290mm VH-VH		1	
	★ 314	606050054004S	FFC 18P 60mm 1mm BD		1	
	★ 315	606050096008S	FFC 21P 80MM 1.0MM BD		2	*
	★ 316	606050097001S	FFC 25P 60MM 1.0MM BD		1	*
	★ 317	606050049002S	FFC 25P 80mm 1mm BD PTAB		1	
	★ 318	606050053025S	FFC 40P 450mm 0.5mm BD		1	
	★ 319	606050053001S	FFC 40P 80mm 0.5mm BD		2	
	★ 320	606050051005S	FFC 8P 260mm 1mm BD		1	

EXPLODED VIEW OF SACD MECHANISM

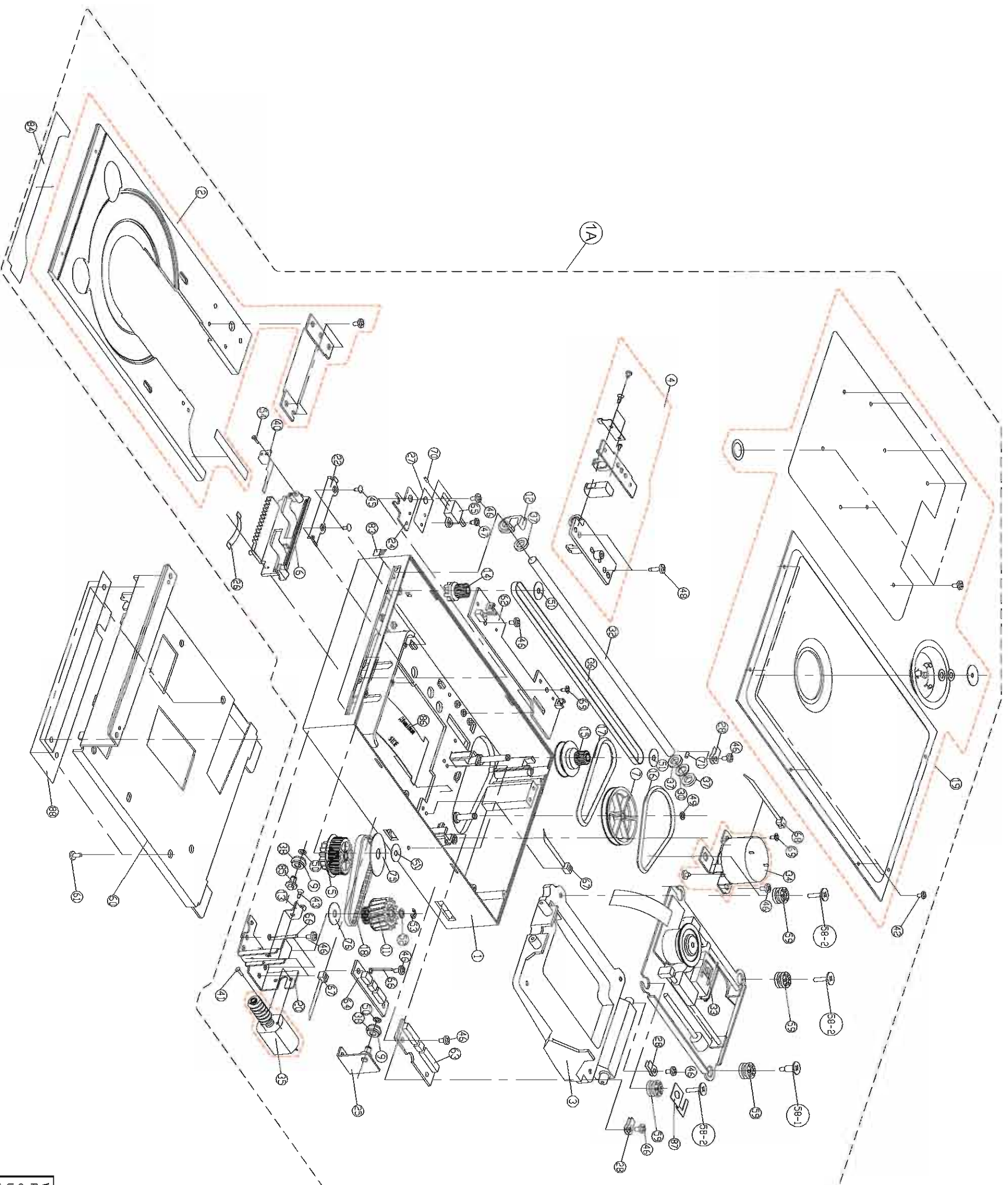

WARNING:
Parts marked with this symbol  have critical characteristics.
Use ONLY replacement parts recommended by the manufacturer.

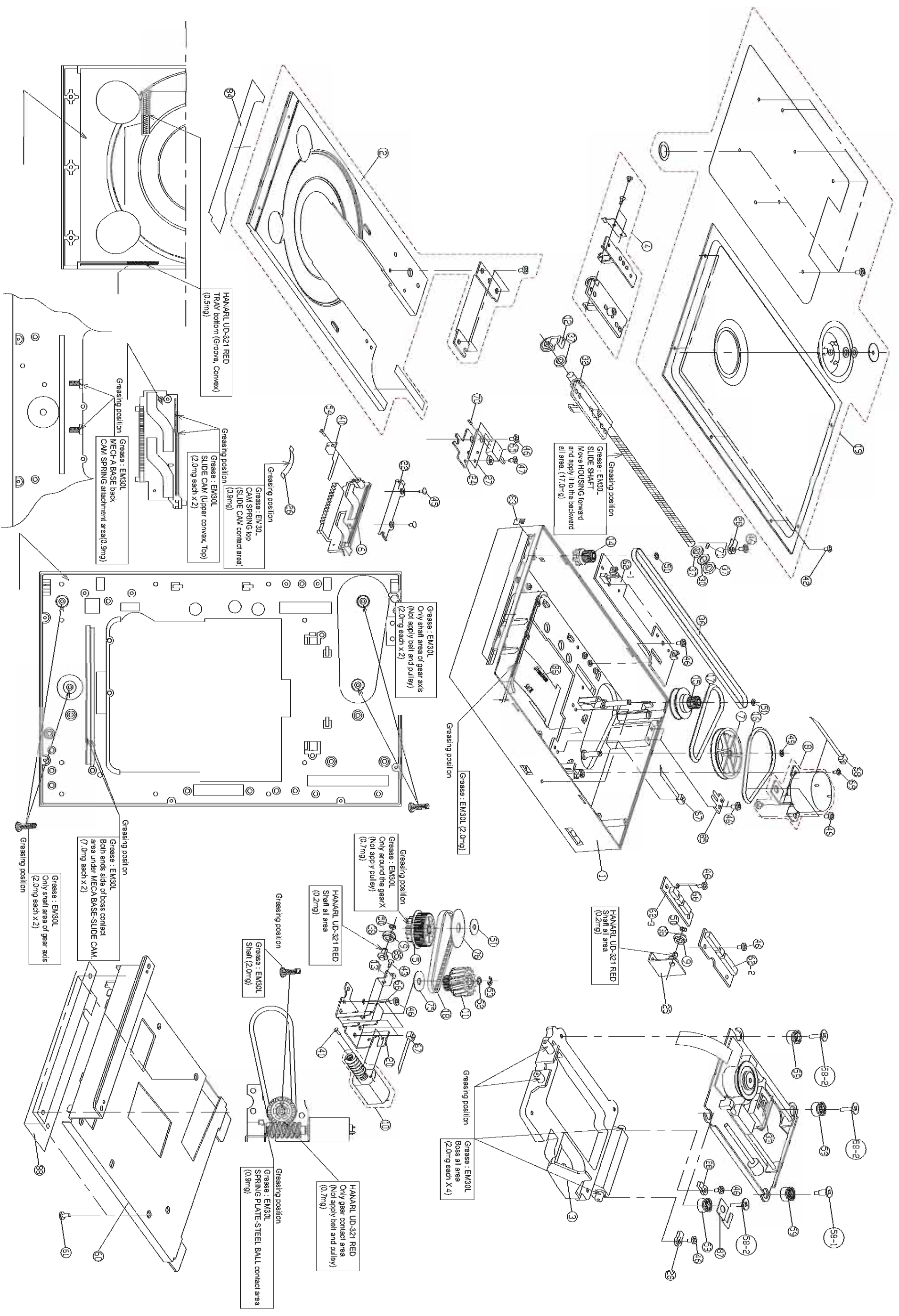

PARTS LIST OF EXPLODED VIEW

* Parts for which "nsp" is indicated on this table cannot be supplied.

* P.W.B. ASS'Y for which "nsp" is indicated on this table cannot be supplied. When repairing the P.W.B. ASS'Y, check the board parts table and order replacement parts.

* The parts listed below are for maintenance only, might differ from the parts used in the unit in appearances or dimensions.

Ref. No.	Part No.	Part Name	Remarks	Qty	New
1A	nsp	FE/SACD UNIT			
1	nsp	MECHA BASE ASS'Y		1	
2	8S3111000200M	TRAY SUB ASSY UD9004 37AK		1	*
	-	TRAY		1	
	-	TRAY BRACKET		1	
	-	3 × 5CBS-B		5	
	-	TRAY CUSHION		1	
3	nsp	TRAVERSE FRAME		1	
4	00D9KA2A761			1	
	-	HOUSING		1	
	-	BELT HOLDER		1	
	-	SHUTTER		1	
	-	2 × 4CBS-B		1	
	-	2 × 6CFS-B		1	
	-	BELT GUIDE		1	
	-	2 × 6CBTS(P)-Z		1	
5	463510006106D	TB CAM GEAR		1	
6	00D4240280505	SLIDE CAM		1	
7	00D9KA2G974	DOUBLE PULLY		1	
9	00D4210845006	ROLLER		2	
11	463510007000D	TB WORM WHEEL		1	
12	nsp	TRAY HOLDER L		1	
13	nsp	TRAY HOLDER R		1	
14	00D9KA2G969	BELT GEAR FRONT		1	
15	00D9KA2G970	BELT GEAR REAR		1	
16	00D9KA2G968	BELT FIRST		1	
17	00D9KA2G971	BELT SECOND		1	
18	466010001006D	TIMING BELT CAM		1	
19	8S4031001100M	TOP PLATE SUB ASSY UD9004 37AK		1	*
	-	TOP PLATE		1	
	-	CLAMPER MAGNET		2	
	-	BACK YOKE		1	
	-	CLAMPER BASE		1	
	-	3 × 5CBS-B		8	
	-	SUB TOP		1	
	-	DAMPER RING		8	
20	nsp	MOTOR BRACKET ASS'Y		1	
22	nsp	CAM HOLDER		1	
24	nsp	SW BRACKET		1	
25	nsp	REAR BRACKET ASS'Y		1	
26	00D4630973105	CAM SPRING		1	
27	nsp	SWITCH SHEET		1	
28	00D4630975006	SHAFT SPRING		6	
30	00D4751179011	WASHER		1	
32	nsp	SLIDE SHAFT		1	
33	nsp	BD TRAVERSE UNIT		1	
34	00D9KA2A762	LOADING MOTOR ASSY		1	
	-	MOTOR PULLY		1	
	-	LOADINGMOTOR BRACKET		1	
	-	LOADING MOTOR		1	
	-	2.6 × 3CBS-B		2	

Ref. No.	Part No.	Part Name	Remarks	Qty	New
35	00D9KA2A763	PU U/D MOTOR ASSY		1	
	-	WORM GEAR		1	
	-	PU U/D MOTOR		1	
36	00D4230084009	TIMING BELT		1	
37	00D4620184001	DAMPER		3	
38	00D4210846005	O RING		2	
40	00D4630976209	BOSS SPRING		1	
41	nsp	2 × 3CBS-B		2	
42	nsp	2 × 4CBS-B		4	
43	nsp	2 × 6CFS-B		1	
45	nsp	2.6 × 5CFS-B		2	
46	nsp	3 × 5CBS-B		10	
47	nsp	2.6 × 5CBTS(S)-Z		1	
48	ORD4737005002	3 × 10CBTS(S)-Z		2	
49	00D4751190016	SLIT WASHER 1.6 × 4.0 × 0.5		1	
50	00D4751157091	SLIT WASHER 3.1 × 5.4 × 0.5		2	
51	00D4751190003	SLIT WASHER 3.1 × 12.0 × 0.5		3	
52	00D4751161016	POLY WASHER 4.1 × 6.5 × 0.5		1	
53	ORD4761003009	3E RING		1	
58-1	519350004003D	2 × 4 CCAST OT-ZNB		1	
58-2	519350003000D	2 × 10 CCAST OT-ZN		3	
59	474510001019D	DAMPER		4	
62	nsp	LOADING SENS UNIT		1	
63	nsp	LOADING UNIT		1	
64	nsp	CHACKING UNIT		1	
65	00D2121207007	SSCF210300		1	
66	nsp	CORD HOLDER		2	
67	nsp	WIRE CLAMP BAND 100mm		5	
68	nsp	WIRE CLAMP BAND 160mm		1	
69	ORD4712801030	3 × 5CFS-B		2	
70	nsp	SUMI TUBE		3	
71	nsp	SHAFT SPACER		1	
75	451510026015D	RETAINING PLATE		1	
76	451510026008D	RETAINING PLATE		1	
★ 78	00D2043016004	7P SHS-SHS CONN.CORD		1	
★ 79	00D2040612003	6P SHS-SHS CONN.CORD		1	
★ 80	00D2035395005	3P SHS CONN.CORD		4	
★ 81	00D2038578007	5P SHS CONN.CORD		5	
★ 82	00D2035396004	3P SHS CONN.CORD		1	
83	448010009002D	SUS BRUSH		2	
84	451310070007D	ALUMINUM SHEET		1	
85	00D4220681001	ROLLER SHAFT		1	
86	451010041002D	SHIELD GUIDE		1	
87	445510069000D	FPC COVER		1	
60	nsp	MECHA BRACKET		1	
61	ORD4700009022	3 × 6CPS(SW.W)ZNP		4	
88	nsp	BOTTOM SHEET		1	

PACKING VIEW

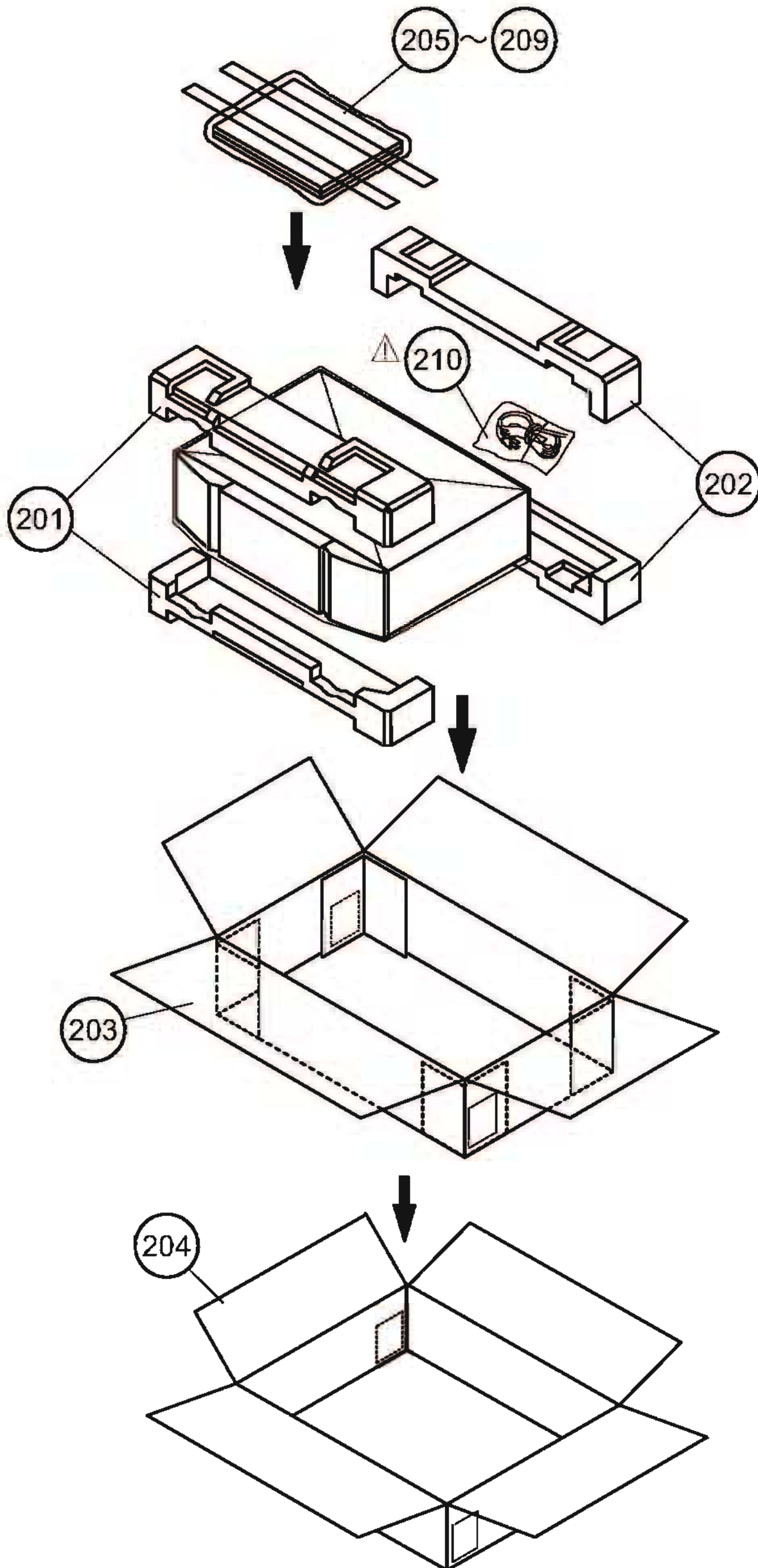

PARTS LIST OF PACKING & ACCESSORIES

* Parts for which "nsp" is indicated on this table cannot be supplied.

* The parts listed below are for maintenance only, might differ from the parts used in the unit in appearances or dimensions.

* Part indicated with the mark "★" is not illustrated in the exploded view.

Note: The symbols in the column "Remarks" indicate the following destinations.

U : North America model

N : Europe model

S : Singapore model

R : Russia model

Ref. No.	Part No.	Part Name	Remarks	Q'ty	New
201	533610045009M	CUSHION FRONT UD9004 37AK		1	*
202	533610046002M	CUSHION REAR UD9004 37AK		1	*
203	531210097008M	PACKING CASE UD9004 37AK		1	*
204	nsp	MASTER CARTON UD9004 37AK	for N, R	1	*
205	307010052037M	REMOTE CONTROLLER RC003UD (N)	for N, S, R	1	*
205	307010052020M	REMOTE CONTROLLER RC001UD (U)	for U	1	*
206	00D2032405008	2P PIN CORD		1	
207	00D2030701005	1P PIN CORD(VIDEO)		1	
208	nsp	FLY SHEET		1	*
209	541110297035M	USER MANUAL UD9004 (N) 37AK	for N, S, R	1	*
209	541110297028M	USER MANUAL UD9004 (U) 37AK	for U	1	*
210	00D2062215006	AC CORD-E1/10A/INLET	for N, S, R	1	
210	611050024005S	AC CORD SET(E3) V	for U	1	

MEASURING METHOD AND WAVEFORMS

Measuring Disc: CD/TCD-784
 DVD/VT502 or TDV-520A
 BD/ABD-520 or BLX-108

To check the waveforms on the FE/SACD UNIT, the GND (-) probe to "17VC" point.

① ~ ⑰ points have the certain test points shown below.

- The HF waveform (ATEST) is not normally output. The waveform can be output by setting the test mode. Cancel the test mode to play a disc. For details, see "5. Test mode" (page 19~26). Other signals are output.
 - When HF waveform (ATEST) is noisy or cannot discriminate the eye-pattern, replace the Travers Unit after measuring the IOP.
- ※When watching the HF waveform (ATEST), use the extending wire as short as possible.
 ※It is better to use wires for extending between the probe and test points.

1. MAIN UNIT : TEST POINT AND WAVEFORMS

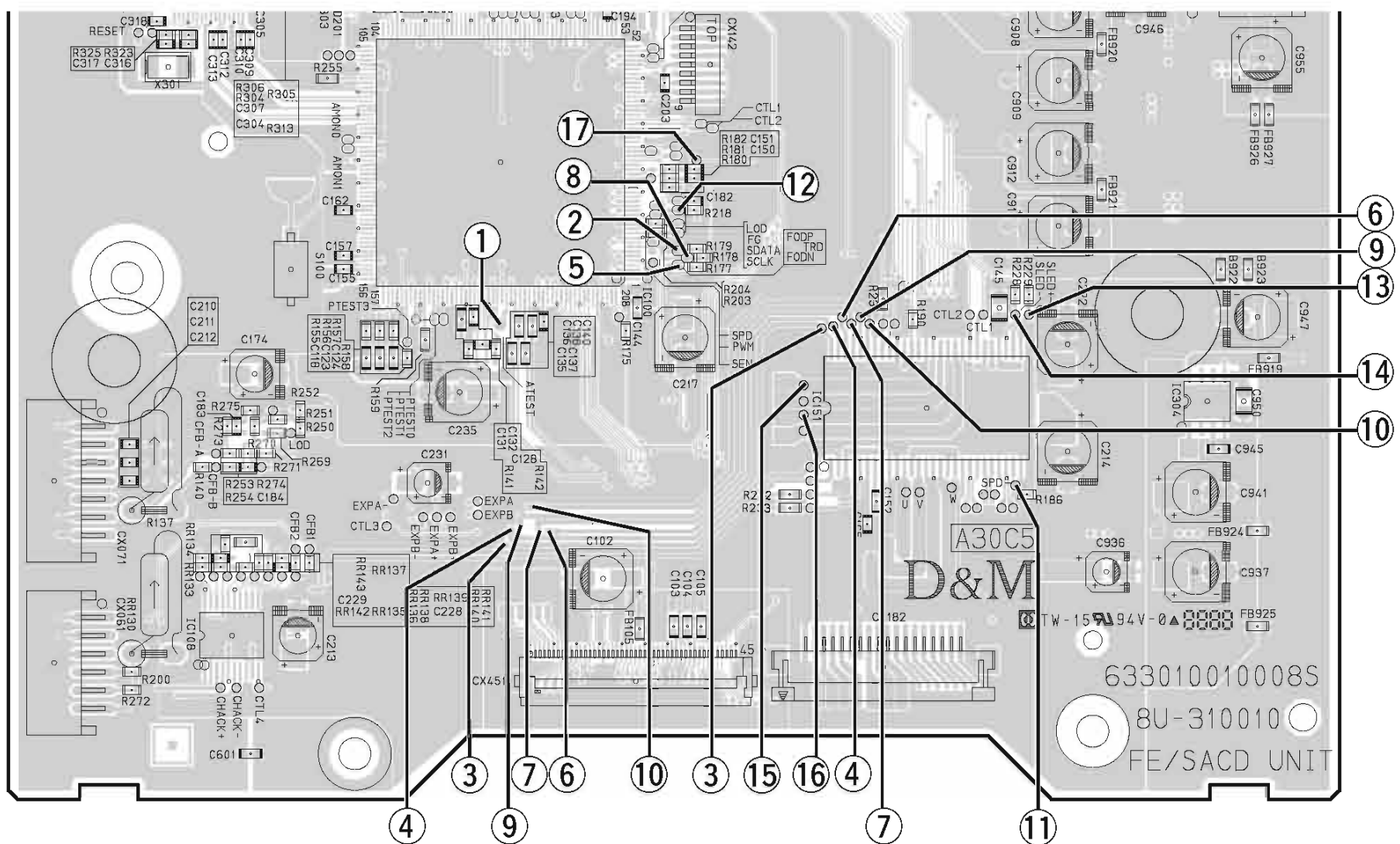

8U-310010 FE/SACD UNIT : Component Side

BD PLAY Disc : ABD-520

HF wave form

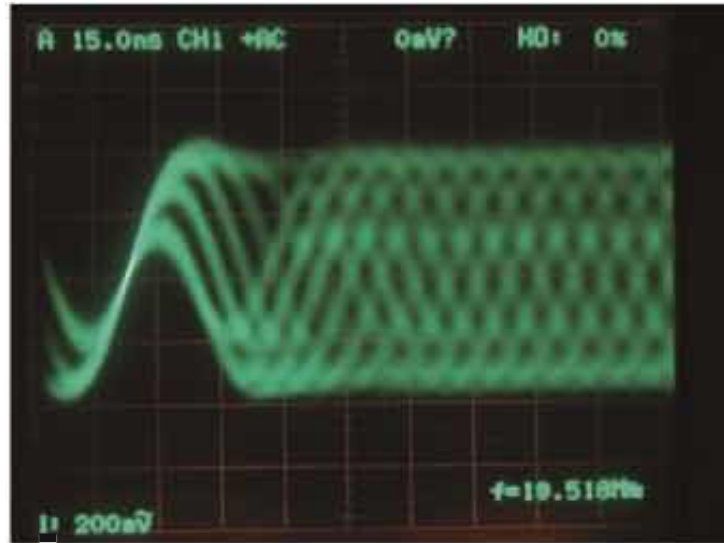

① ATEST

⑪ SPD
⑫ FG

BD PLAY (INNER)

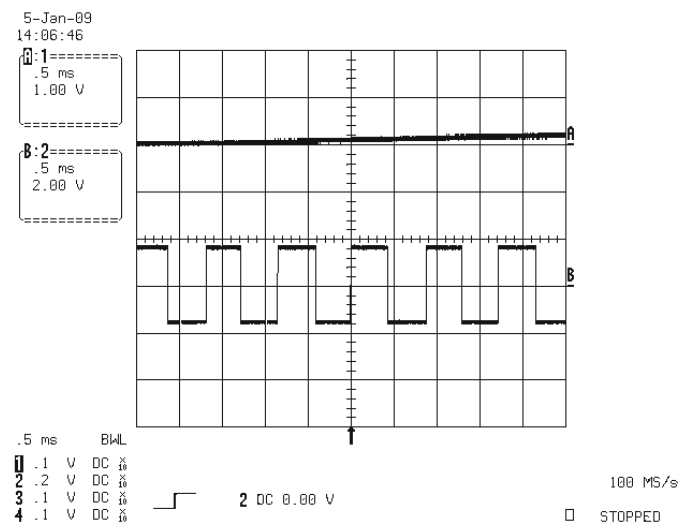

BD LOADING → PLAY

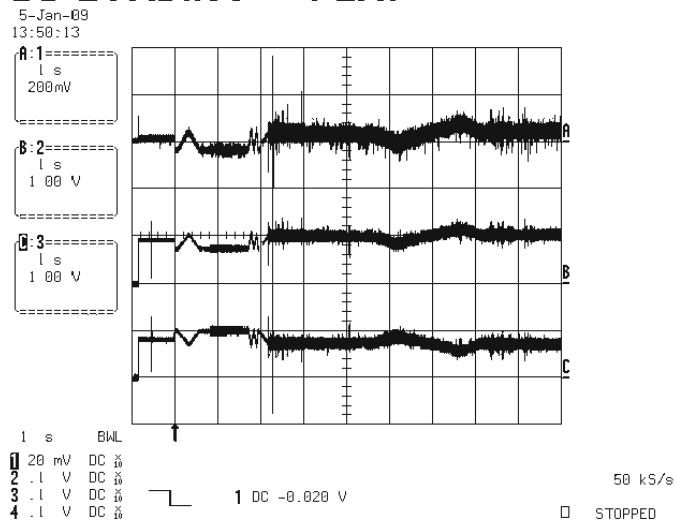

② FODP
③ FCS1+
④ FCS1-

⑬ SLED+
⑭ SLED-
⑮ SL1+
⑯ SL2-

BD SEARCH (INNER → OUTER)

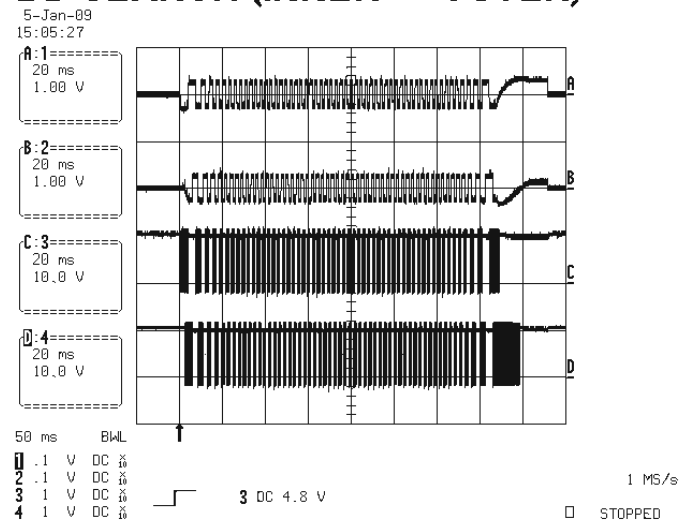

BD LOADING → PLAY

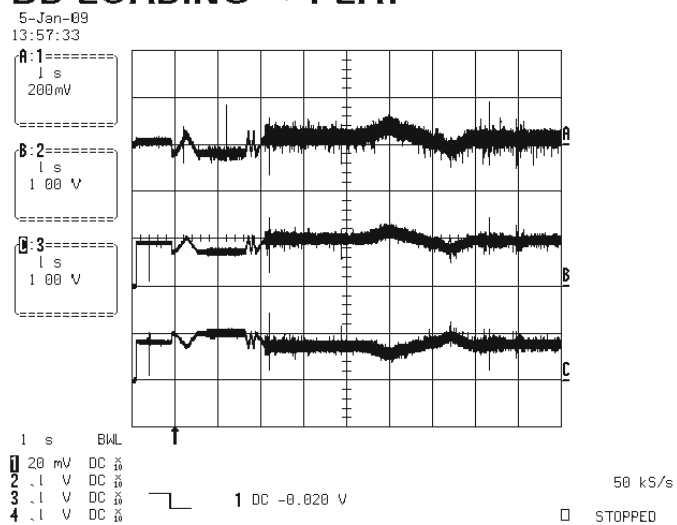

⑤ FODN
⑥ FCS2+
⑦ FCS2-

⑬ SLED+
⑭ SLED-
⑮ SL1+
⑯ SL2-

BD SEARCH (OUTER → INNER)

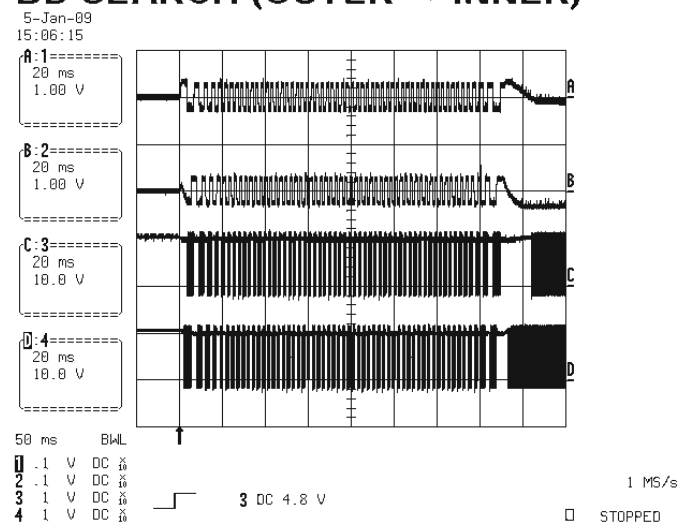

BD PLAY

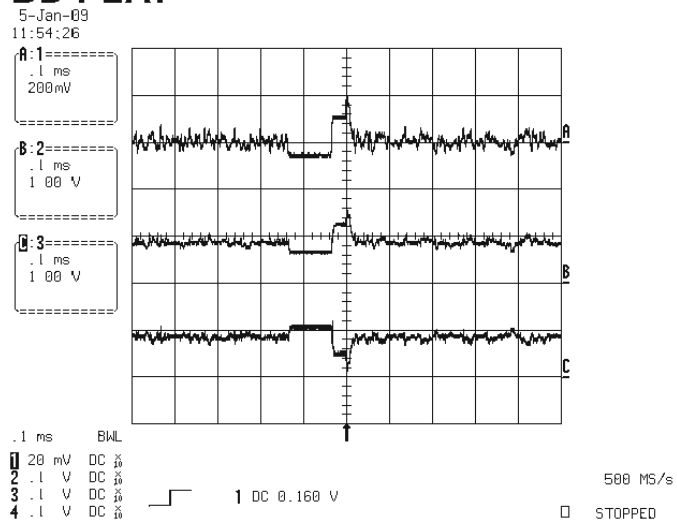

⑧ TRD
⑨ TRK+
⑩ TRK-

DVD PLAY Disc : TDV-520A

HF wave form

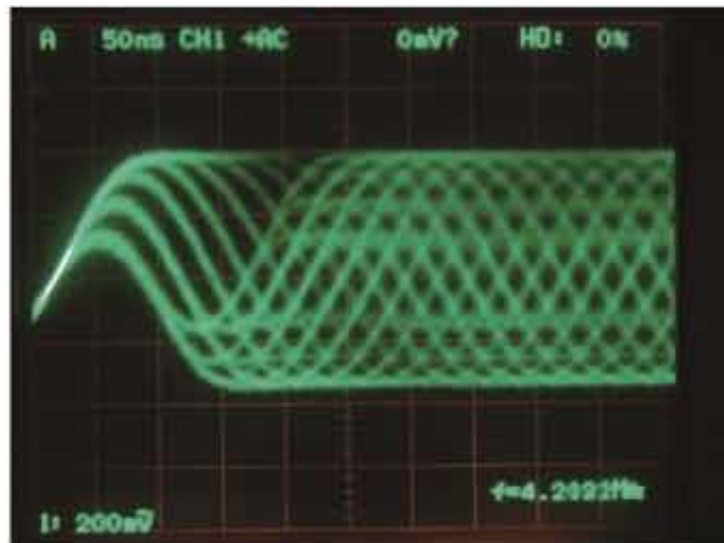

① ATEST

⑪ SPD
⑫ FG

DVD PLAY (INNER)

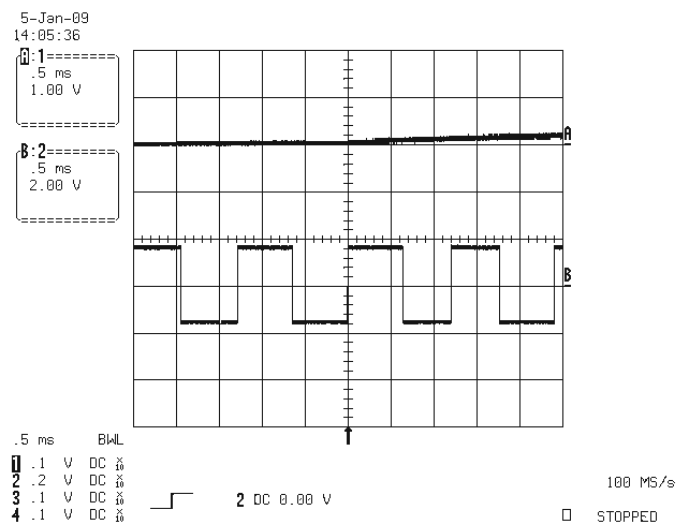

DVD LOADING → PLAY

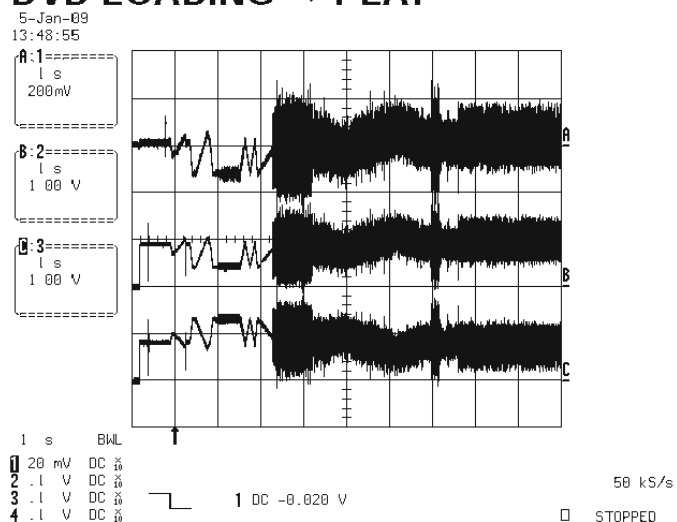

② FODP
③ FCS1+
④ FCS1-

⑬ SLED+
⑭ SLED-
⑮ SL1+
⑯ SL2-

DVD SEARCH (INNER → OUTER)

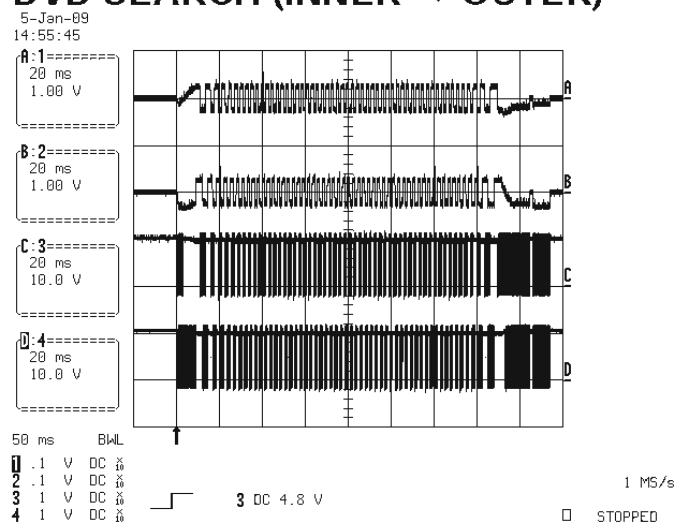

DVD LOADING → PLAY

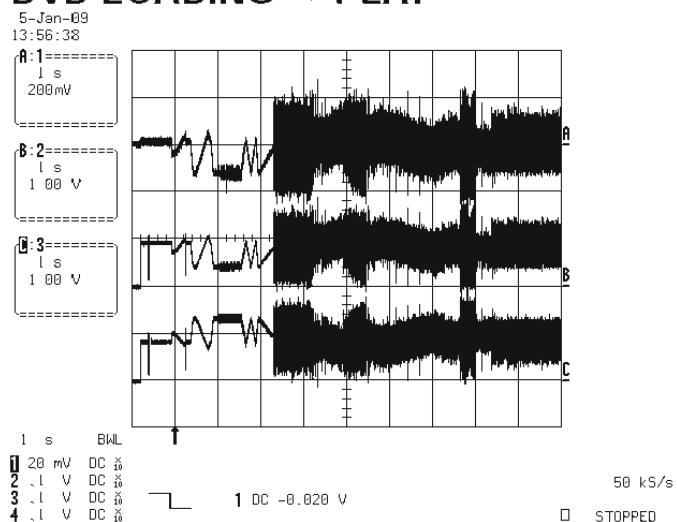

⑤ FODN
⑥ FCS2+
⑦ FCS2-

⑬ SLED+
⑭ SLED-
⑮ SL1+
⑯ SL2-

DVD SEARCH (OUTER → INNER)

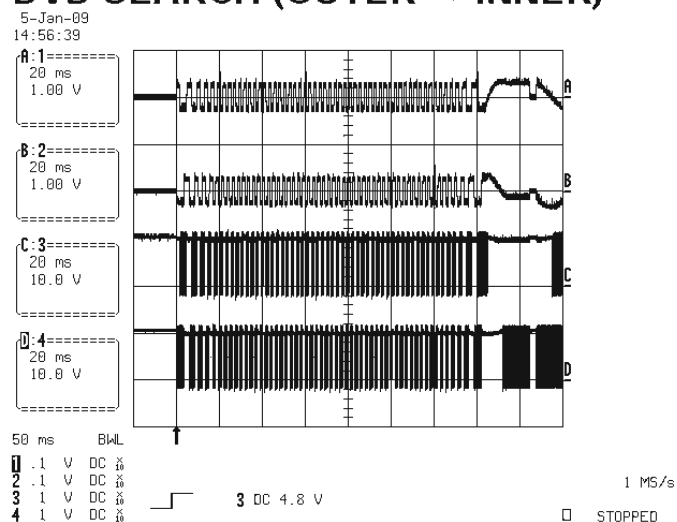

DVD PLAY

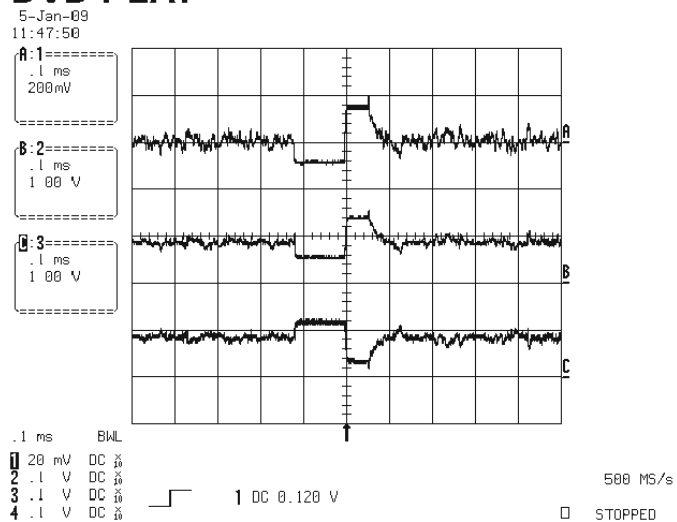

⑧ TRD
⑨ TRK+
⑩ TRK-

CD PLAY Disc: TCD-784

HF wave form

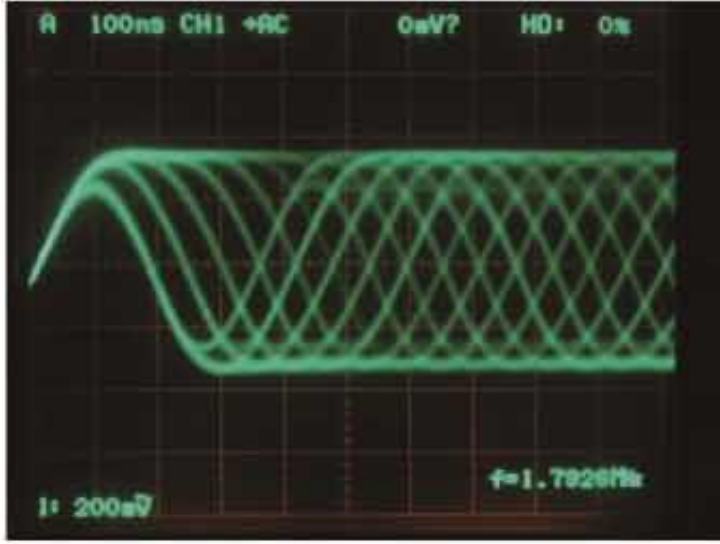

① ATEST

⑪ SPD
⑫ FG

CD PLAY (INNER)

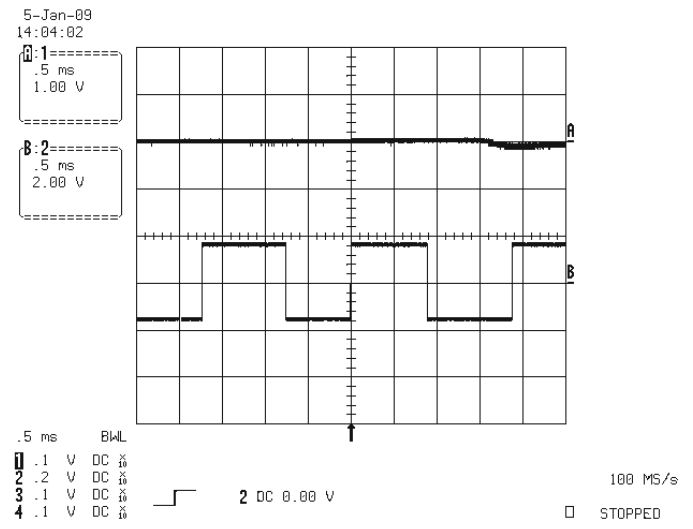

CD LOADING → PLAY

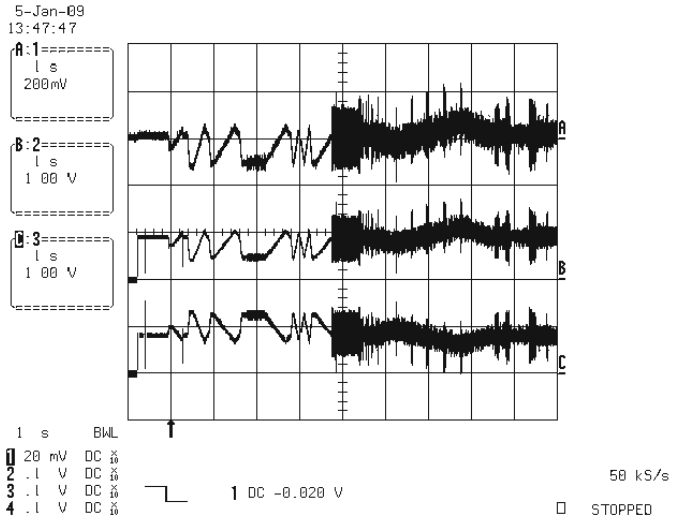

② FODP
③ FCS1+
④ FCS1-

⑬ SLED+
⑭ SLED-
⑮ SL1+
⑯ SL2-

CD SEARCH (INNER → OUTER)

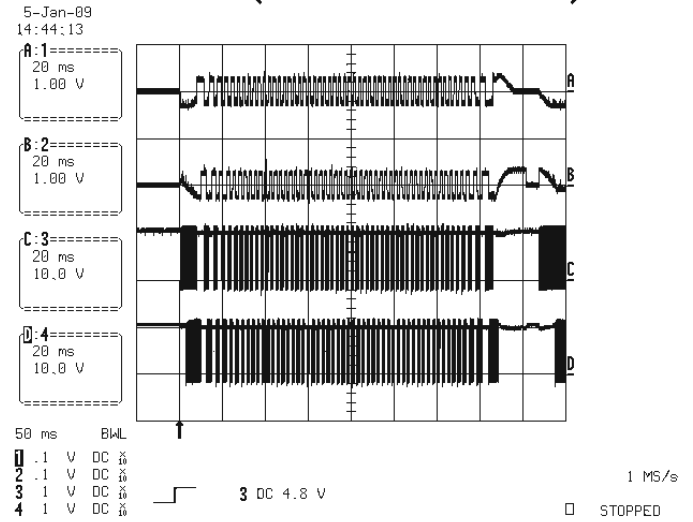

CD LOADING → PLAY

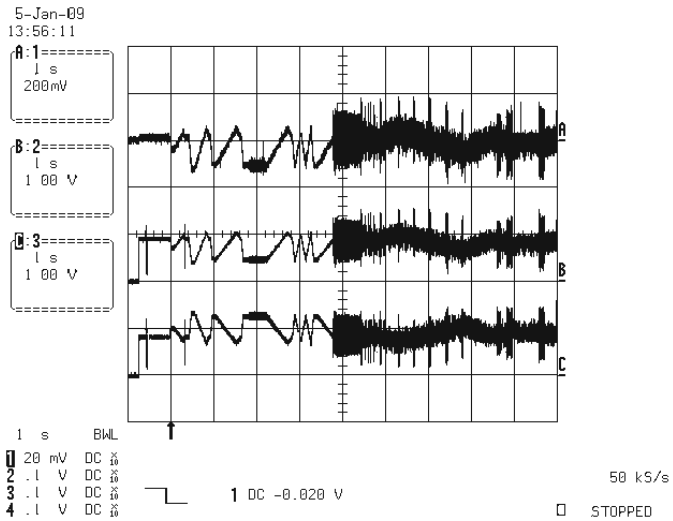

⑤ FODN
⑥ FCS2+
⑦ FCS2-

⑬ SLED+
⑭ SLED-
⑮ SL1+
⑯ SL2-

CD SEARCH (OUTER → INNER)

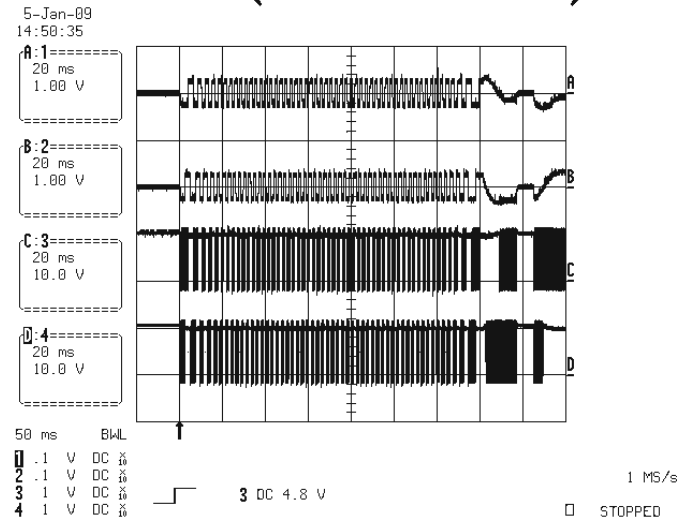

CD PLAY

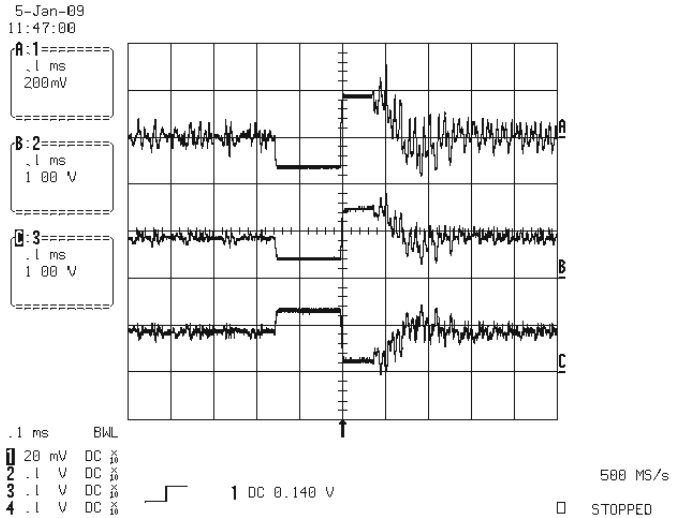

⑧ TRD
⑨ TRK+
⑩ TRK-

ANALOG VIDEO OUTPUT SIGNAL

Signal: Color Bar 100%

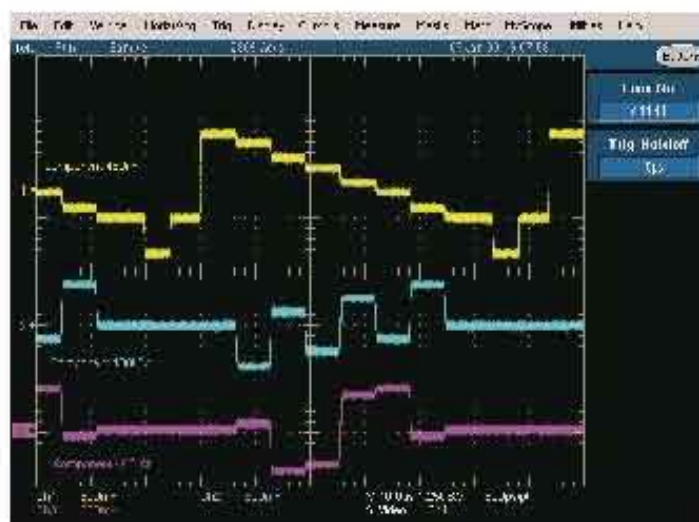
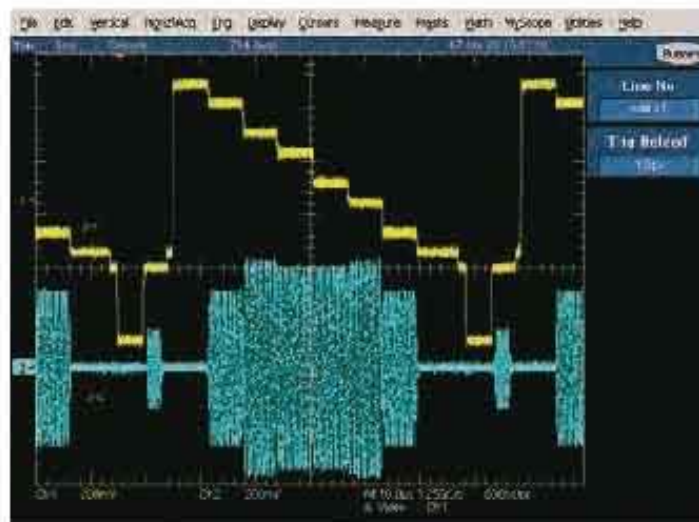
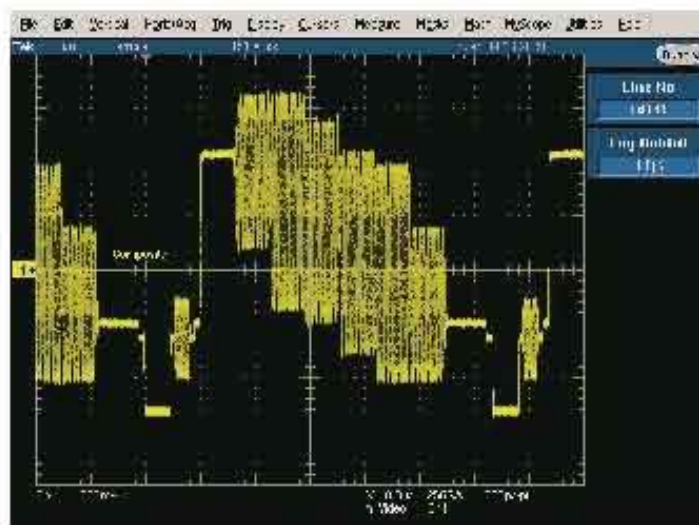
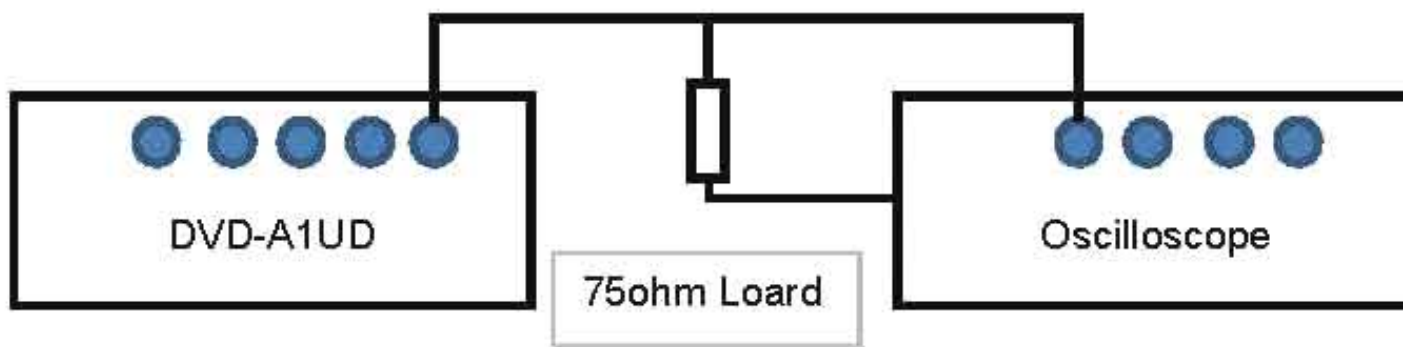

NOTE FOR SCHEMATIC DIAGRAM

WARNING:

Parts marked with this symbol \triangle have critical characteristics.
Use ONLY replacement parts recommended by the manufacturer.

CAUTION:

Before returning the unit to the customer, make sure you make either (1) a leakage current check or (2) a line to chassis resistance check. If the leakage current exceeds 0.5 milliamps, or if the resistance from chassis to either side of the power cord is less than 460 kohms, the unit is defective.

WARNING:

DO NOT return the unit to the customer until the problem is located and corrected.

NOTICE:

ALL RESISTANCE VALUES IN OHM. k=1,000 OHM
M=1,000,000 OHM
ALL CAPACITANCE VALUES IN MICRO FARAD.
P=MICRO-MICRO FARAD
EACH VOLTAGE AND CURRENT ARE MEASURED AT
NO SIGNAL INPUT CONDITION.
CIRCUIT AND PARTS ARE SUBJECT TO CHANGE
WITHOUT PRIOR NOTICE.

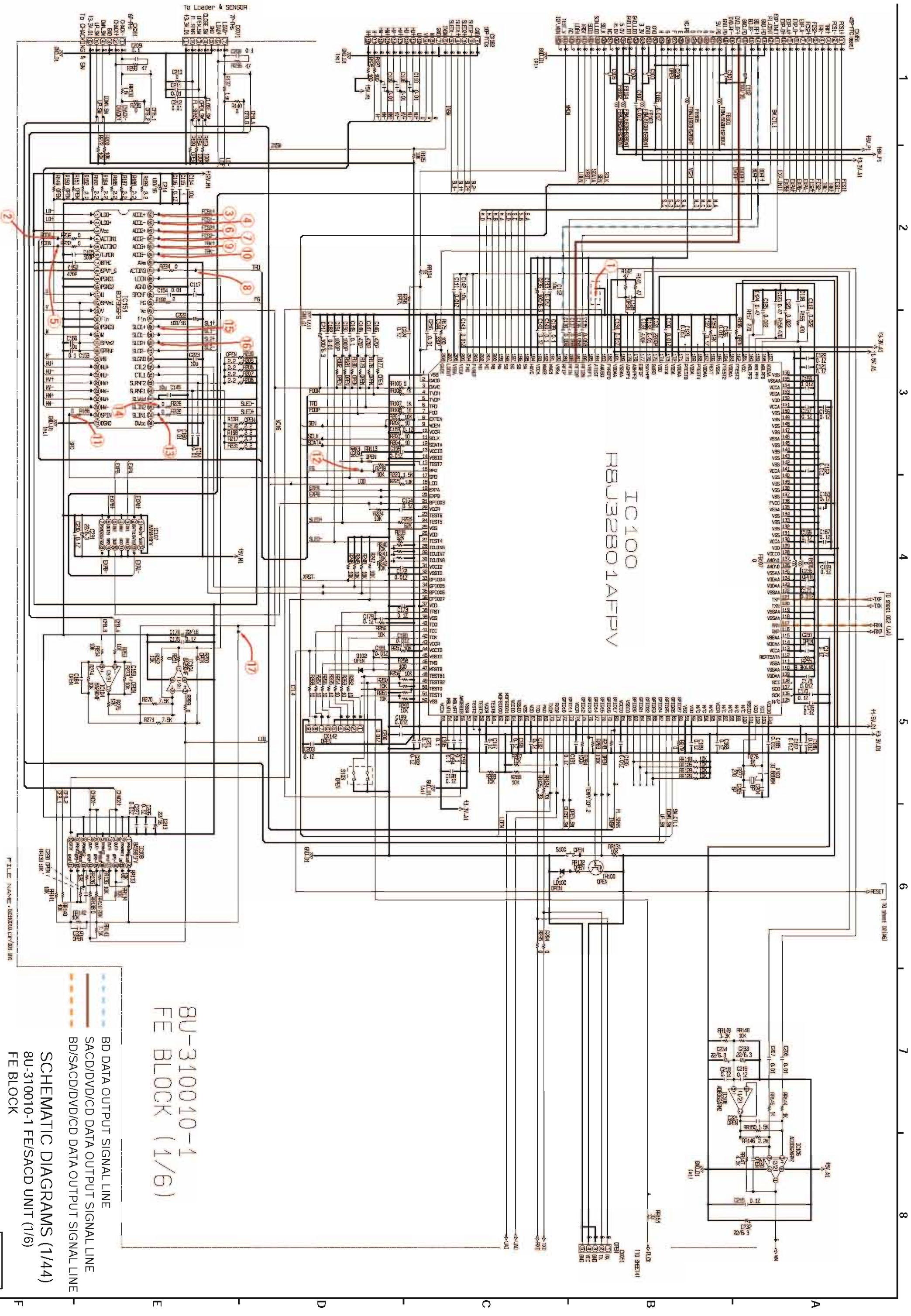

BU-310010-1
FE BLOCK (1/6)

- BD DATA OUTPUT SIGNAL LINE
- SACD/DVD/CD DATA OUTPUT SIGNAL LINE
- BD/SACD/DVD/CD DATA OUTPUT SIGNAL LINE

SCHEMATIC DIAGRAMS (1/44)
8U-310010-1 FE/SACD UNIT (1/6)
FE BLOCK

UD9004

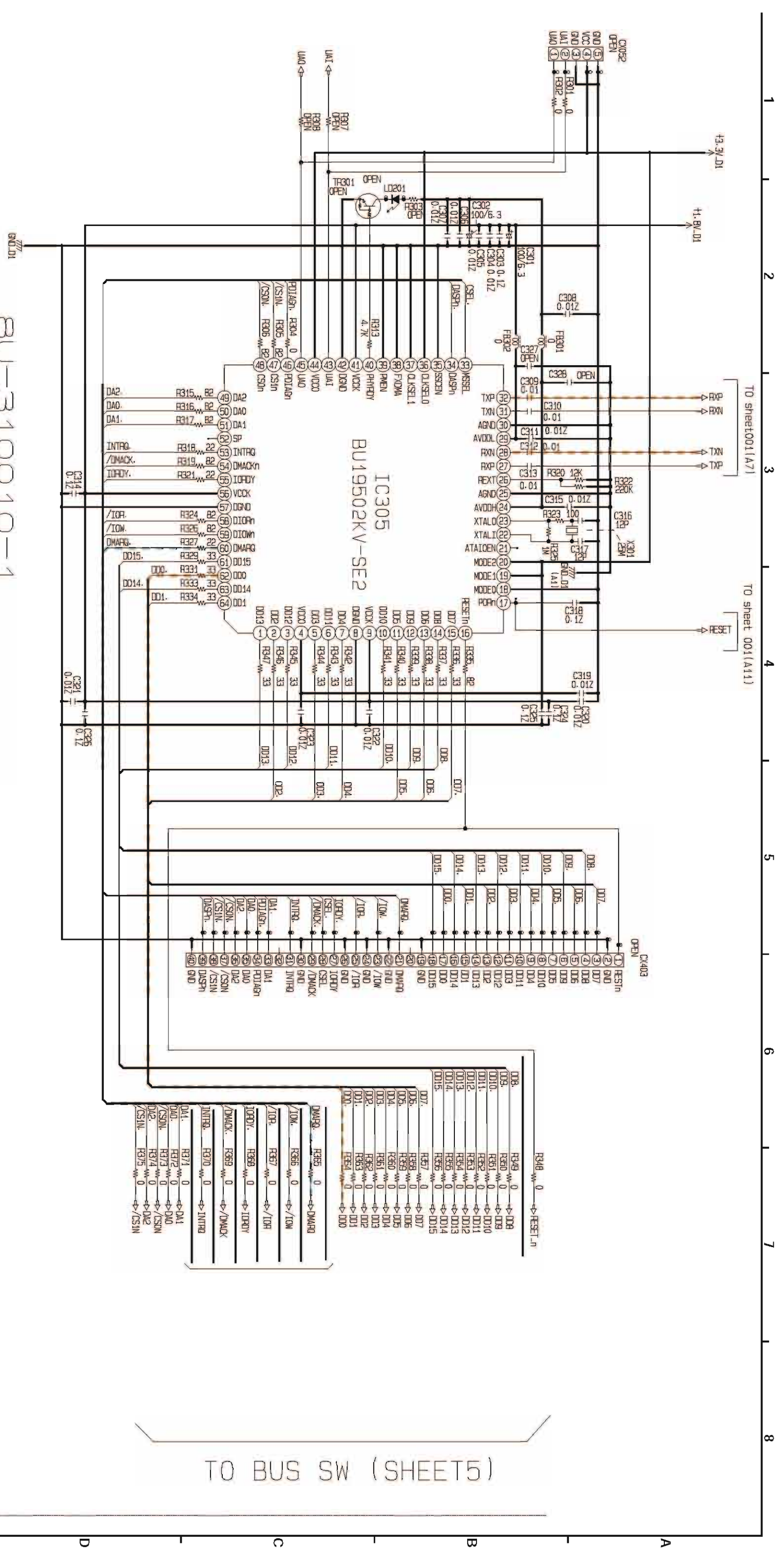

BU-310010-1
SATA-ATAPI BLOCK (2/6)

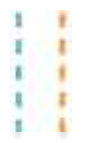

BD/SACD/DVD/CD PLAY DATA OUTPUT SIGNAL LINE
BD/SACD/DVD/CD CONTROL DATA OUTPUT SIGNAL LINE

SCHEMATIC DIAGRAMS (2/44)
8U-310010-1 FE/SACD UNIT (2/6)
SATA-ATAPI BLOCK

UD9004

FILE NAME: M310010.CNV/002.SHT

TO BUS SW (SHEET 5)

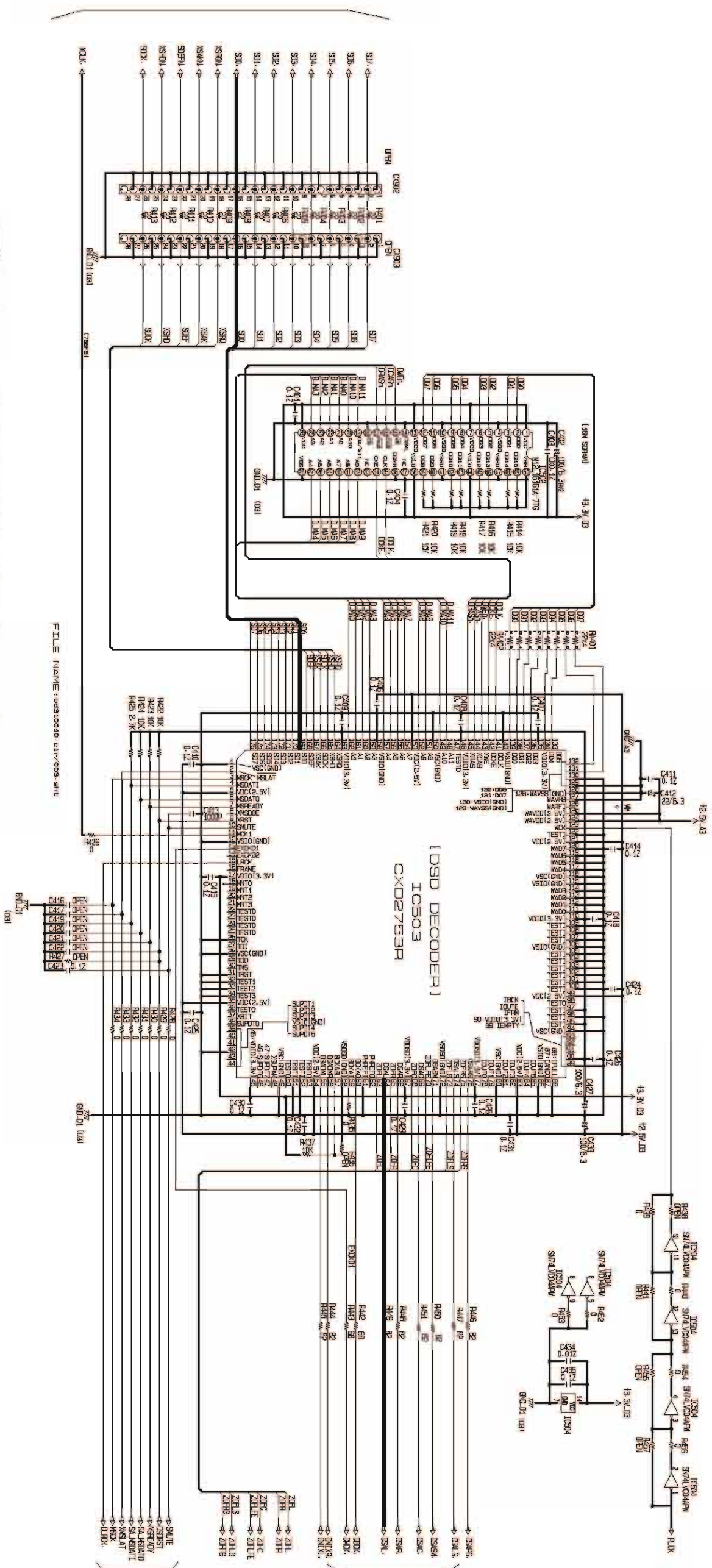

BU-310010-1
SACD DECODE BLOCK (3/6)

SACD PLAY DATA OUTPUT SIGNAL LINE

SCHEMATIC DIAGRAMS (3/44)

8U-310010-1 FE/SACD UNIT (3/6)

SACD DECODE BLOCK

Setting	Setting
[M.O.-2] EPF Up(0.1-0.1)	SA1ALDWR4
HSWAP Disable(H4-21)	SA1ALDWR3
CS1A Enable	SA1ALDWR2
FWR1A Write Enable	SA1ALDWR1
DONE active Drive	SA1ALDWR0

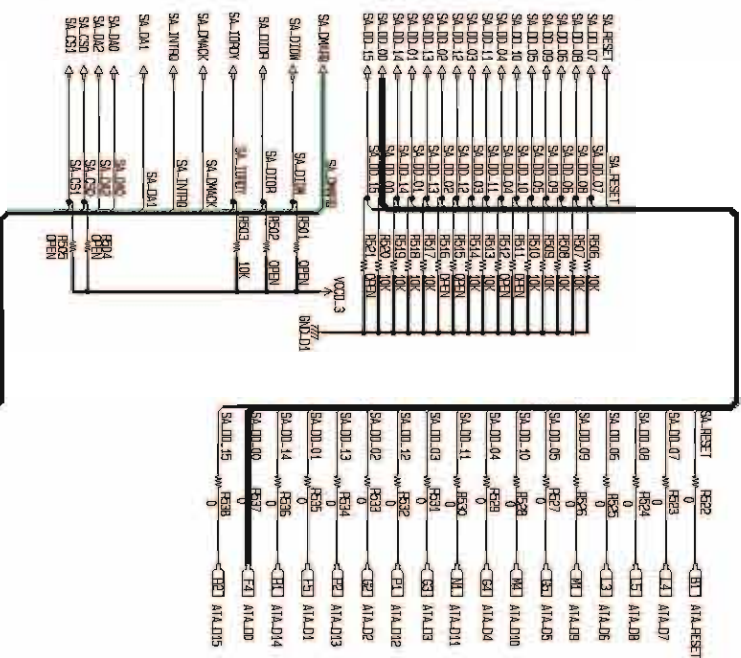

BU-310010-1
VSTEM-ATAPI BLOCK (4/6)

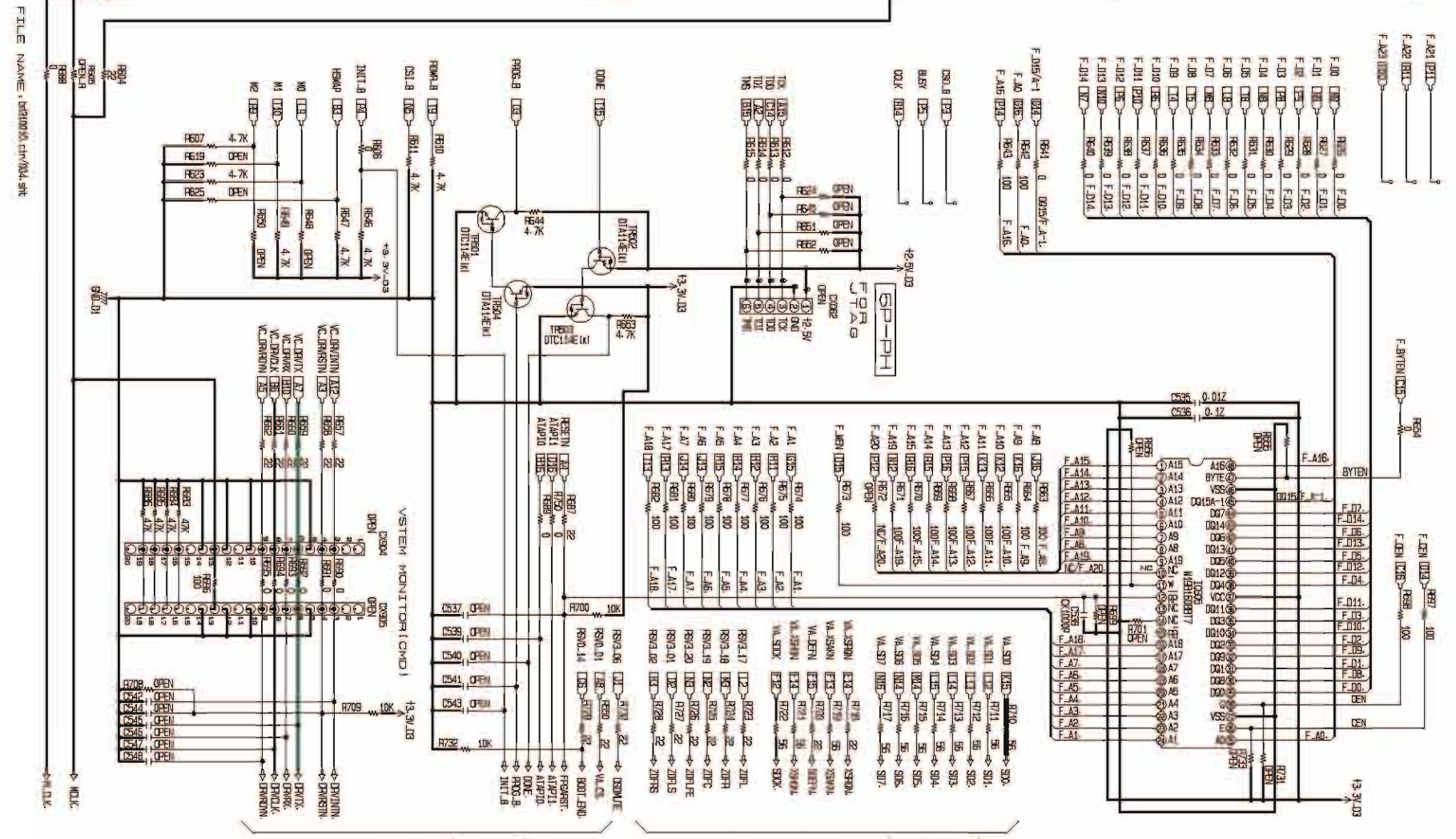
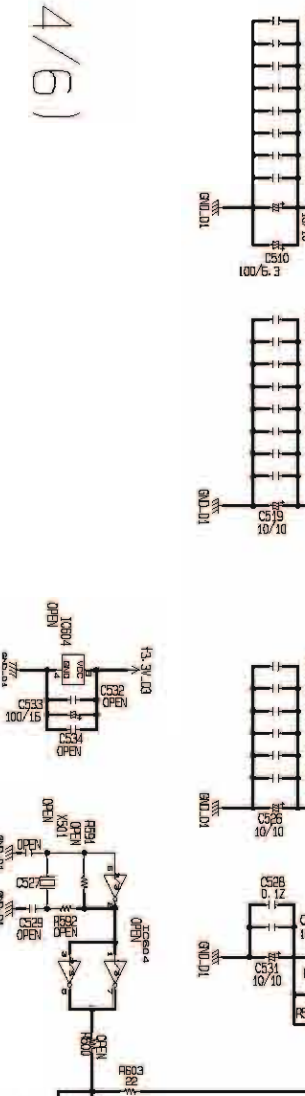
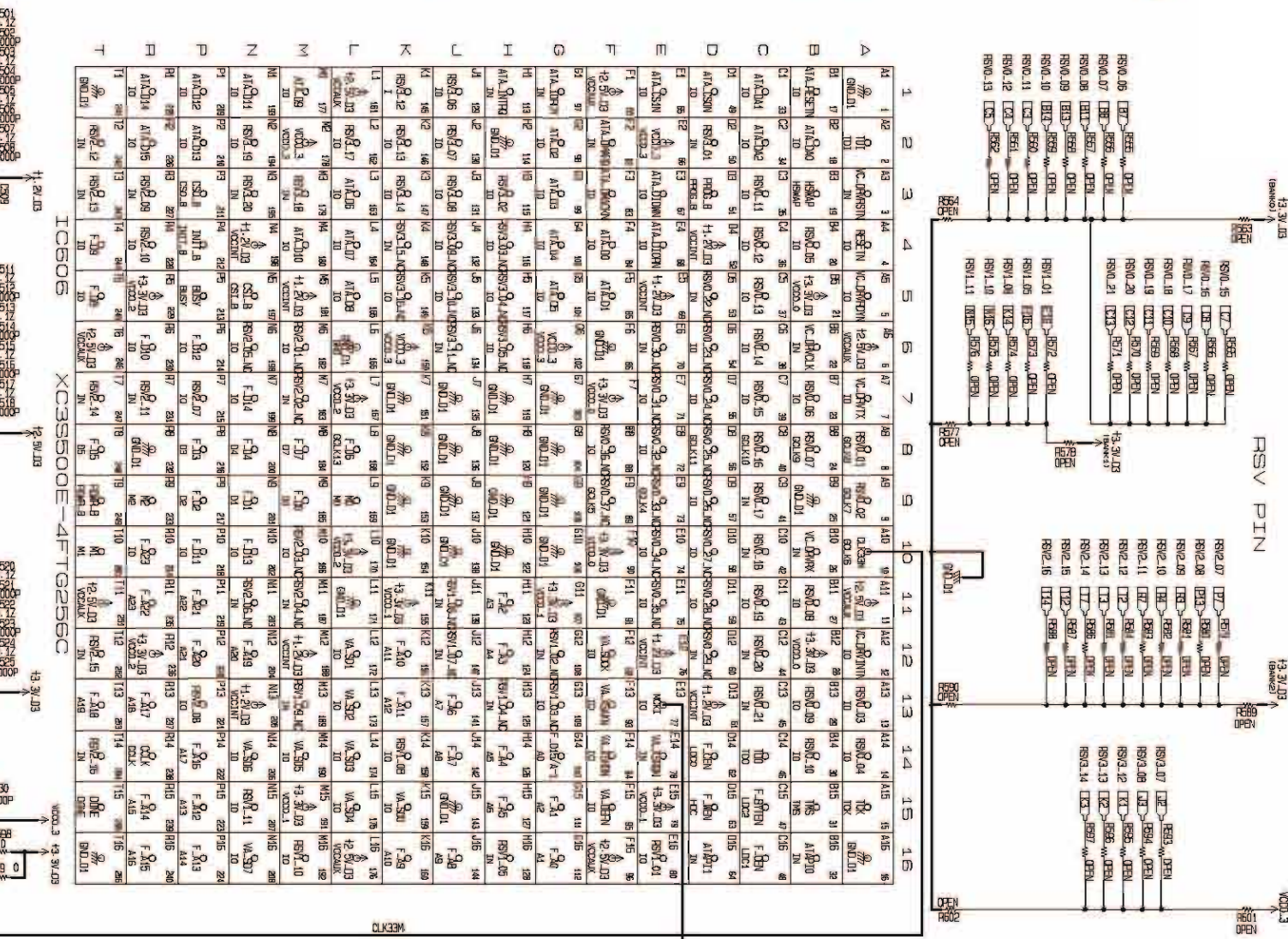

SACD PLAY DATA OUTPUT SIGNAL LINE
SACD CONTROL DATA OUTPUT SIGNAL LINE
SCHEMATIC DIAGRAMS (4/4)
8U-310010-1 FE/SACD UNIT (4/6)
VSTEM-ATAPI BLOCK

FILE I/F
ATAPI

TO FE (SHEET2)

TO SACD FPGA (SHEET4)

TO SACD CXD2753R (SHEET3)

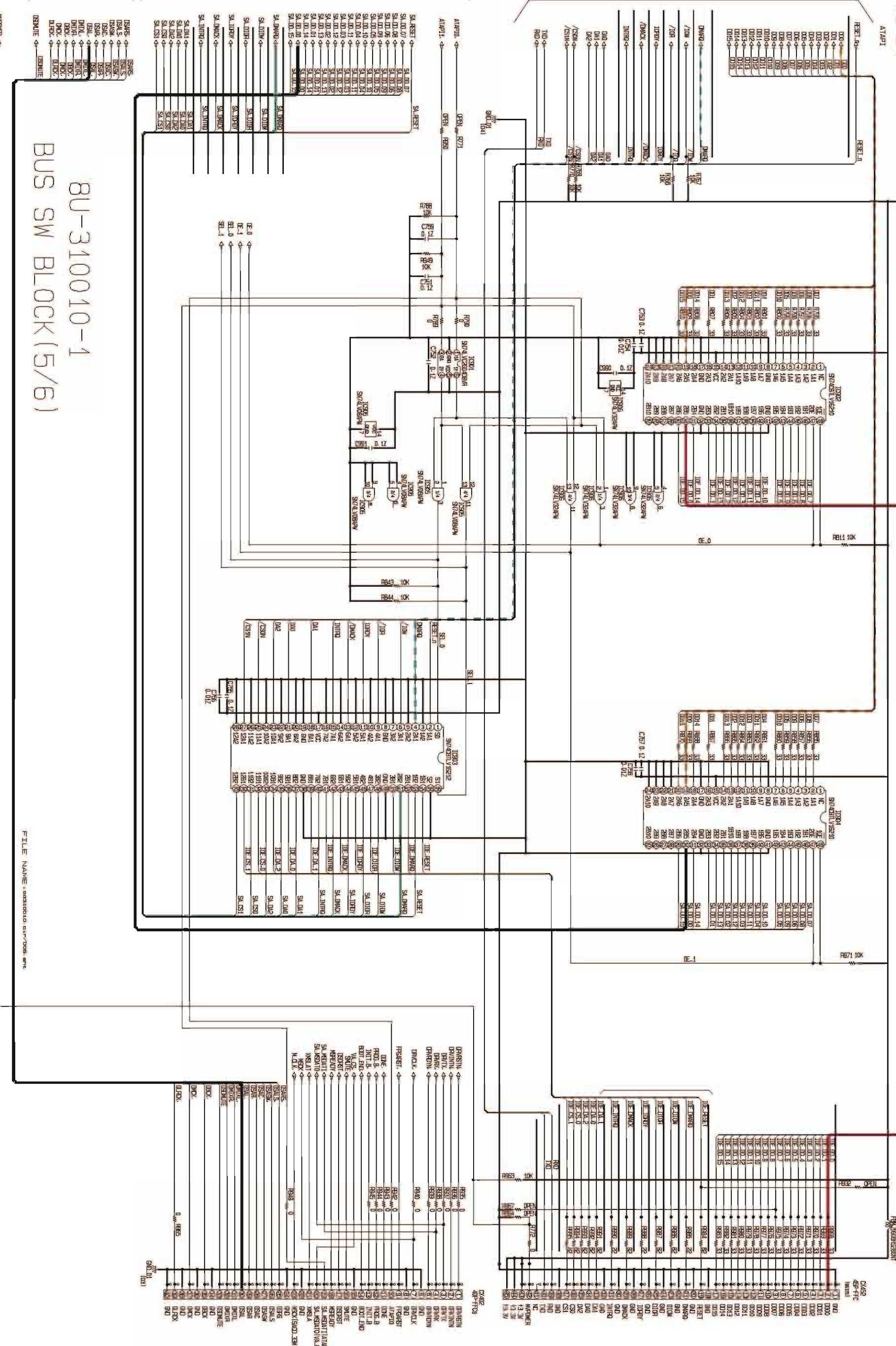

8U-310010-1
BUS SW BLOCK(5/6)

- BD/SACD/DVD/CD PLAY DATA OUTPUT SIGNAL LINE
- BD/DVD/CD PLAY DATA OUTPUT SIGNAL LINE
- BD/SACD/DVD/CD CONTROL DATA OUTPUT SIGNAL LINE
- SACD PLAY DATA OUTPUT SIGNAL LINE
- SACD CONTROL DATA OUTPUT SIGNAL LINE

FILE NAME : i:\sacdbld\cxd2753r\8u310010-1

SCHEMATIC DIAGRAMS (5/44)

8U-310010-1 FE/SACD UNIT (5/6)

UD9004

8U-310010-1 POWER BLOCK (6/6)

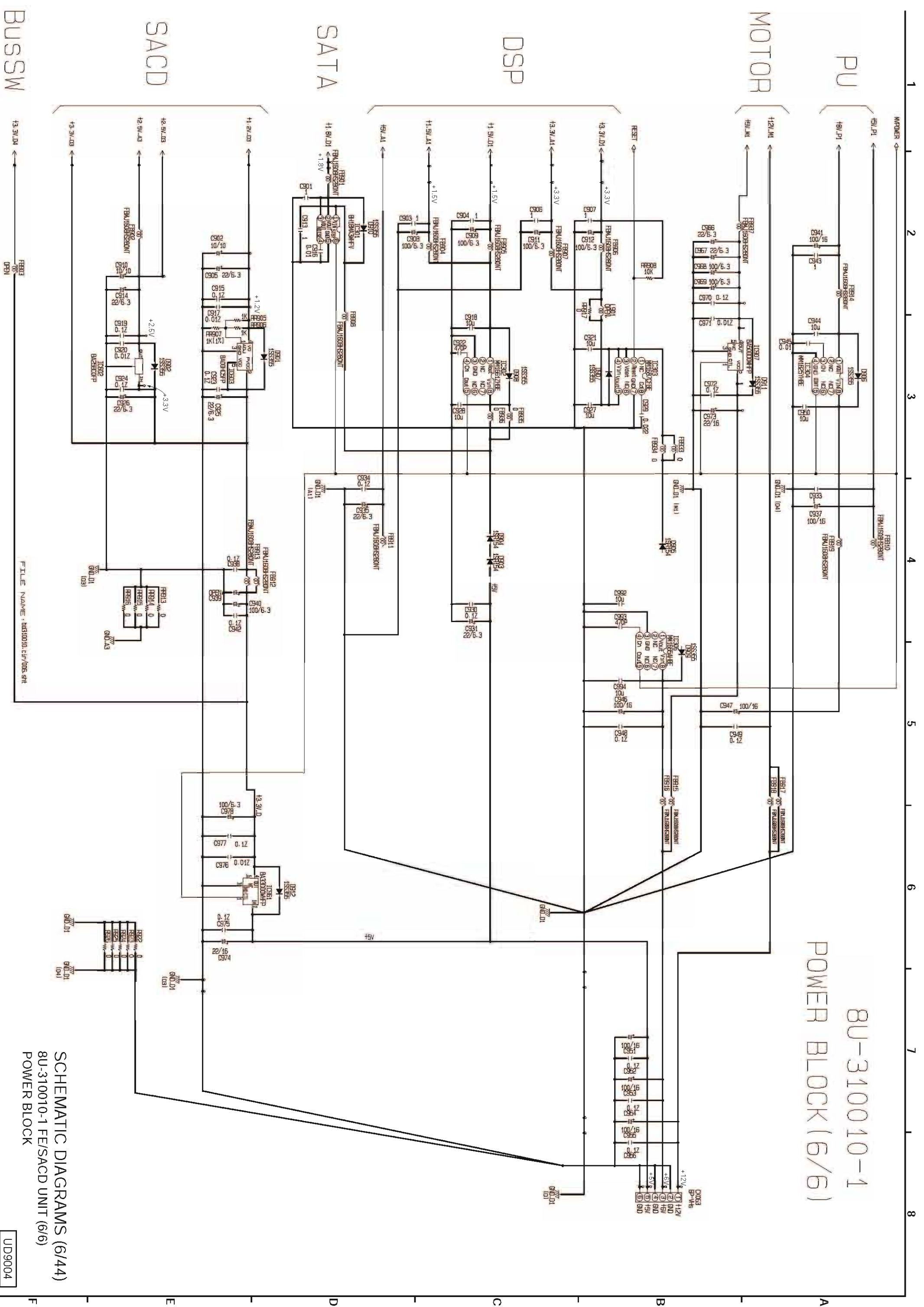

FILE NAME : 00310010_C17/005_9HT

SCHEMATIC DIAGRAMS (6/44)
8U-310010-1 FE/SACD UNIT (6/6)
POWER BLOCK

UD9004

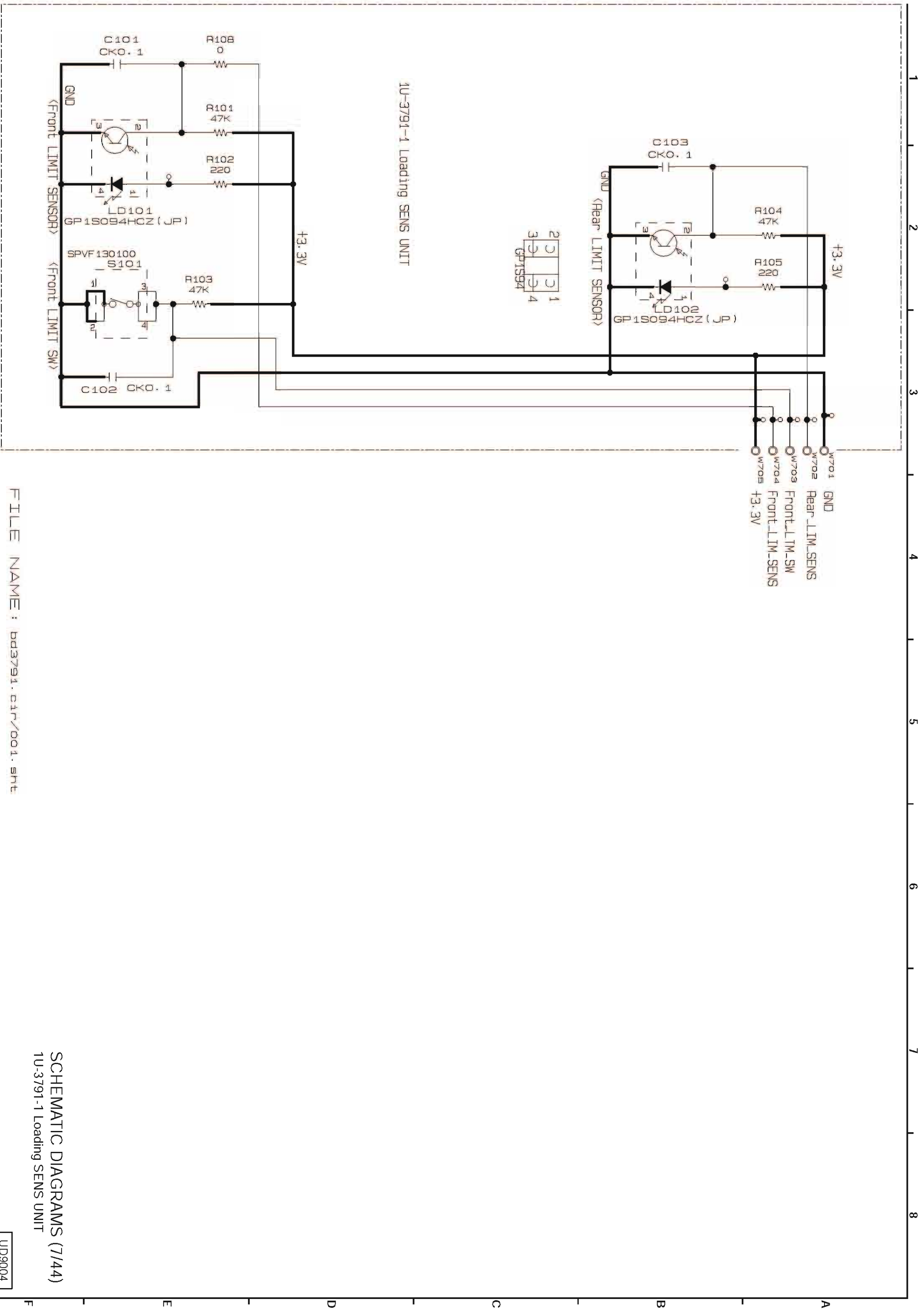

1U-3791-1 Loading SENS UNIT

- W701 GND
- W702 Rear_LIM_SENS
- W703 Front_LIM_SW
- W704 Front_LIM_SENS
- W705 +3.3V

FILE NAME : bd3791.cbr/001.sht

SCHEMATIC DIAGRAMS (7/44)
1U-3791-1 Loading SENS UNIT

UD9004

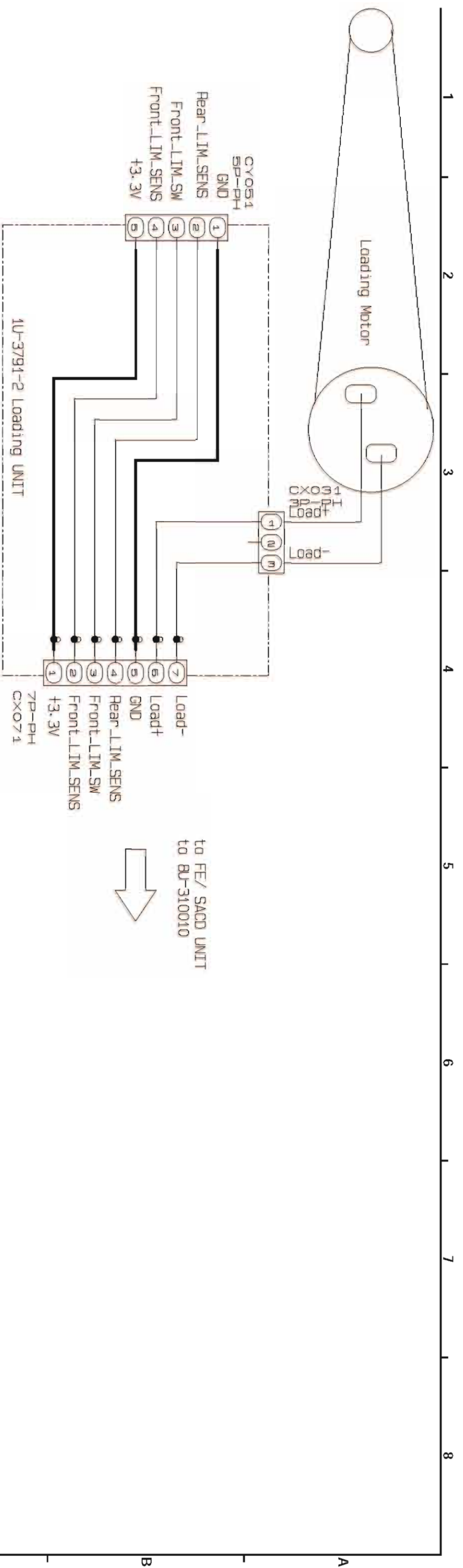

to FE/ SACD UNIT
to BU-310010

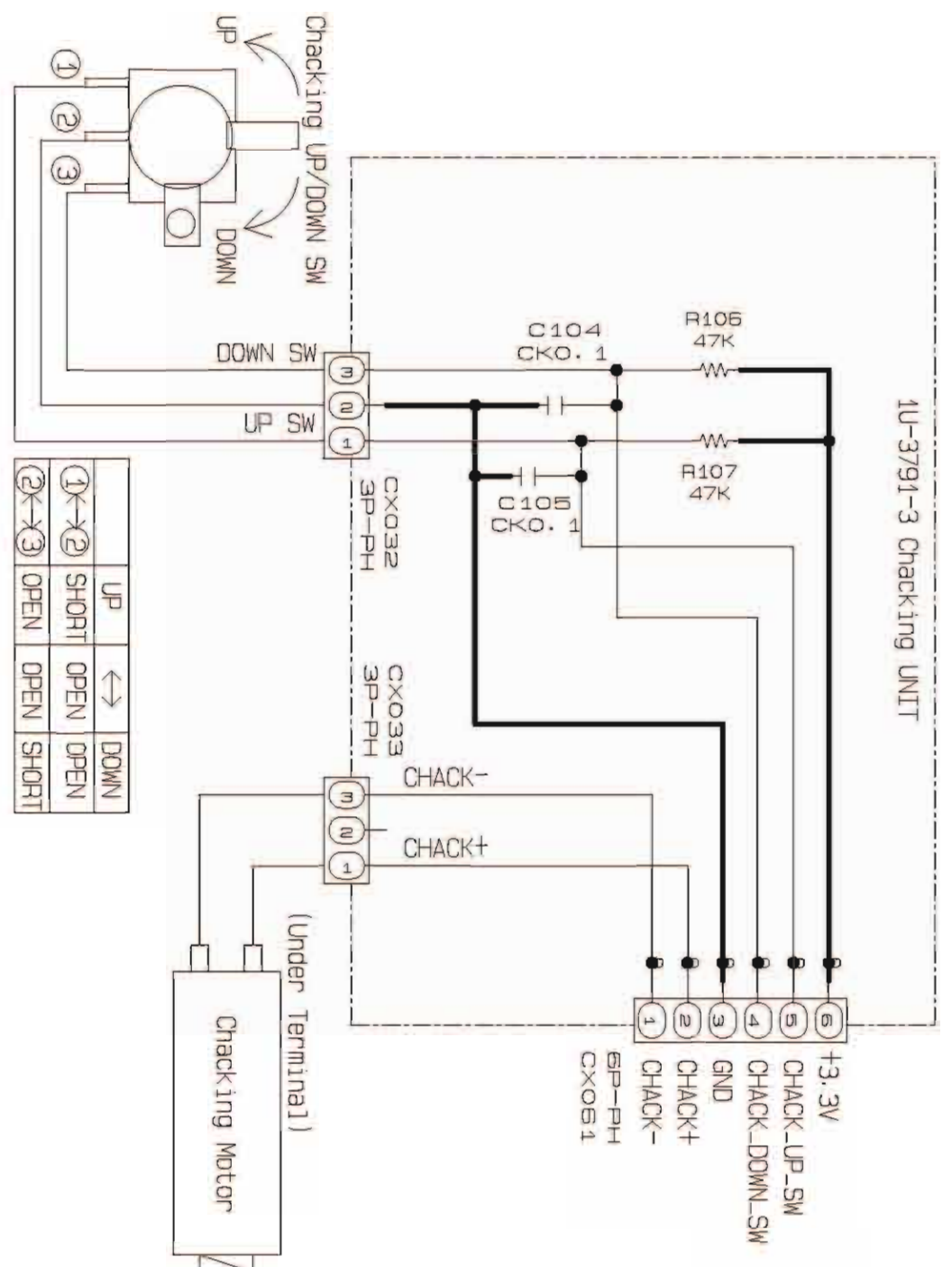

to FE/ SACD UNIT
to BU-310010

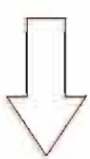

①-X②	UP	↔	DOWN
①-X③	SHORT	OPEN	OPEN
②-X③	OPEN	OPEN	SHORT

FILE NAME : bd3791.cir/002.sht

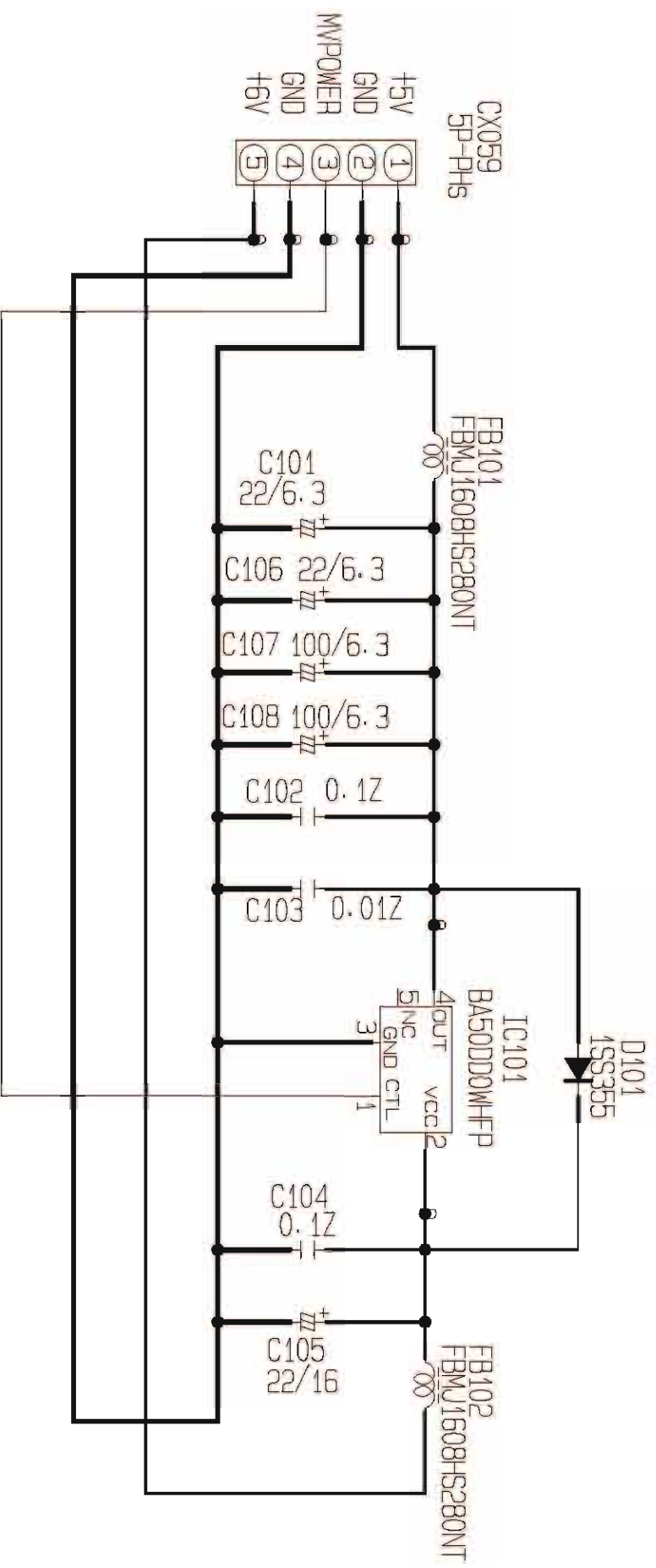

FILE NAME : bdd210075.cir/001.sht

1	2	3	4	5	6	7	8	9	10	11	12	13	14	15	16	17	18	19	20	21	22	23	24	25	26	27	28	29	30	31	32	33																																																																																																																																																																																																																																																																																																																																																																																																																																																																																																																																																																																																																																																																		
A	AA	AB	AC	AD	AE	AF	AG	AH	AI	AJ	AK	AL	AM	AN	AO	AP	AQ	AR	AS	AT	AU	AV	AW	AX	AY	AZ	BA	BB	BC	BD	BE	BF	BG	BH	BI	BJ	BK	BL	BM	BN	BO	BP	BQ	BR	BS	BT	BU	BV	BW	BX	BY	BZ	CA	CB	CC	CD	CE	CF	CG	CH	CI	CJ	CK	CL	CM	CN	CO	CP	CQ	CR	CS	CT	CU	CV	CW	CX	CY	CZ	DA	DB	DC	DD	DE	DF	DG	DH	DI	DJ	DK	DL	DM	DN	DO	DP	DQ	DR	DS	DT	DU	DV	DW	DX	DY	DZ	EA	EB	EC	ED	EE	EF	EG	EH	EI	EJ	EK	EL	EM	EN	EO	EP	EQ	ER	ES	ET	EU	EV	EW	EX	EY	EZ	FA	FB	FC	FD	FE	FF	FG	FH	FI	FJ	FK	FL	FM	FN	FO	FP	FQ	FR	FS	FT	FU	FV	FW	FX	FY	FZ	GA	GB	GC	GD	GE	GF	GG	GH	GI	GJ	GK	GL	GM	GN	GO	GP	GQ	GR	GS	GT	GU	GV	GW	GX	GY	GZ	HA	HB	HC	HD	HE	HF	HG	HH	HI	HJ	HK	HL	HM	HN	HO	HP	HQ	HR	HS	HT	HU	HV	HW	HX	HY	HZ	IA	IB	IC	ID	IE	IF	IG	IH	II	IJ	IK	IL	IM	IN	IO	IP	IQ	IR	IS	IT	IU	IV	IW	IX	IY	IZ	JA	JB	JC	JD	JE	JF	JG	JH	JI	JJ	JK	JL	JM	JN	JO	JP	JQ	JR	JS	JT	JU	JV	JW	JX	JY	JZ	KA	KB	KC	KD	KE	KF	KG	KH	KI	KJ	KK	KL	KM	KN	KO	KP	KQ	KR	KS	KT	KU	KV	KW	KX	KY	KZ	LA	LB	LC	LD	LE	LF	LG	LH	LI	LJ	LK	LL	LM	LN	LO	LP	LQ	LR	LS	LT	LU	LV	LW	LX	LY	LZ	MA	MB	MC	MD	ME	MF	MG	MH	MI	MJ	MK	ML	MM	MN	MO	MP	MQ	MR	MS	MT	MU	MV	MW	MX	MY	MZ	NA	NB	NC	ND	NE	NF	NG	NH	NI	NJ	NK	NL	NM	NO	NP	NQ	NR	NS	NT	NU	NV	NW	NX	NY	NZ	OA	OB	OC	OD	OE	OF	OG	OH	OI	OJ	OK	OL	OM	ON	OO	OP	OQ	OR	OS	OT	OU	OV	OW	OX	OY	OZ	PA	PB	PC	PD	PE	PF	PG	PH	PI	PJ	PK	PL	PM	PN	PO	PP	PQ	PR	PS	PT	PU	PV	PW	PX	PY	PZ	QA	QB	QC	QD	QE	QF	QG	QH	QI	QJ	QK	QL	QM	QN	QO	QP	QQ	QR	QS	QT	QU	QV	QW	QX	QY	QZ	RA	RB	RC	RD	RE	RF	RG	RH	RI	RJ	RK	RL	RM	RN	RO	RP	RQ	RR	RS	RT	RU	RV	RW	RX	RY	RZ	SA	SB	SC	SD	SE	SF	SG	SH	SI	SJ	SK	SL	SM	SN	SO	SP	SQ	SR	SS	ST	SU	SV	SW	SX	SY	SZ	TA	TB	TC	TD	TE	TF	TG	TH	TI	TJ	TK	TL	TM	TN	TO	TP	TQ	TR	TS	TT	TU	TV	TW	TX	TY	TZ	UA	UB	UC	UD	UE	UF	UG	UH	UI	UJ	UK	UL	UM	UN	UO	UP	UQ	UR	US	UT	UU	UV	UW	UX	UY	UZ	VA	VB	VC	VD	VE	VF	VG	VH	VI	VJ	VK	VL	VM	VN	VO	VP	VQ	VR	VS	VT	VU	VV	VW	VX	VY	VZ	WA	WB	WC	WD	WE	WF	WG	WH	WI	WJ	WK	WL	WM	WN	WO	WP	WQ	WR	WS	WT	WU	WV	WW	WX	WY	WZ	XA	XB	XC	XD	XE	XF	XG	XH	XI	XJ	XK	XL	XM	XN	XO	XP	XQ	XR	XS	XT	XU	XV	XW	XX	XY	XZ	YA	YB	YC	YD	YE	YF	YG	YH	YI	YJ	YK	YL	YM	YN	YO	YP	YQ	YR	YS	YT	YU	YV	YW	YX	YZ	ZA	ZB	ZC	ZD	ZE	ZF	ZG	ZH	ZI	ZJ	ZK	ZL	ZM	ZN	ZO	ZP	ZQ	ZR	ZS	ZT	ZU	ZV	ZW	ZX	ZY	ZZ

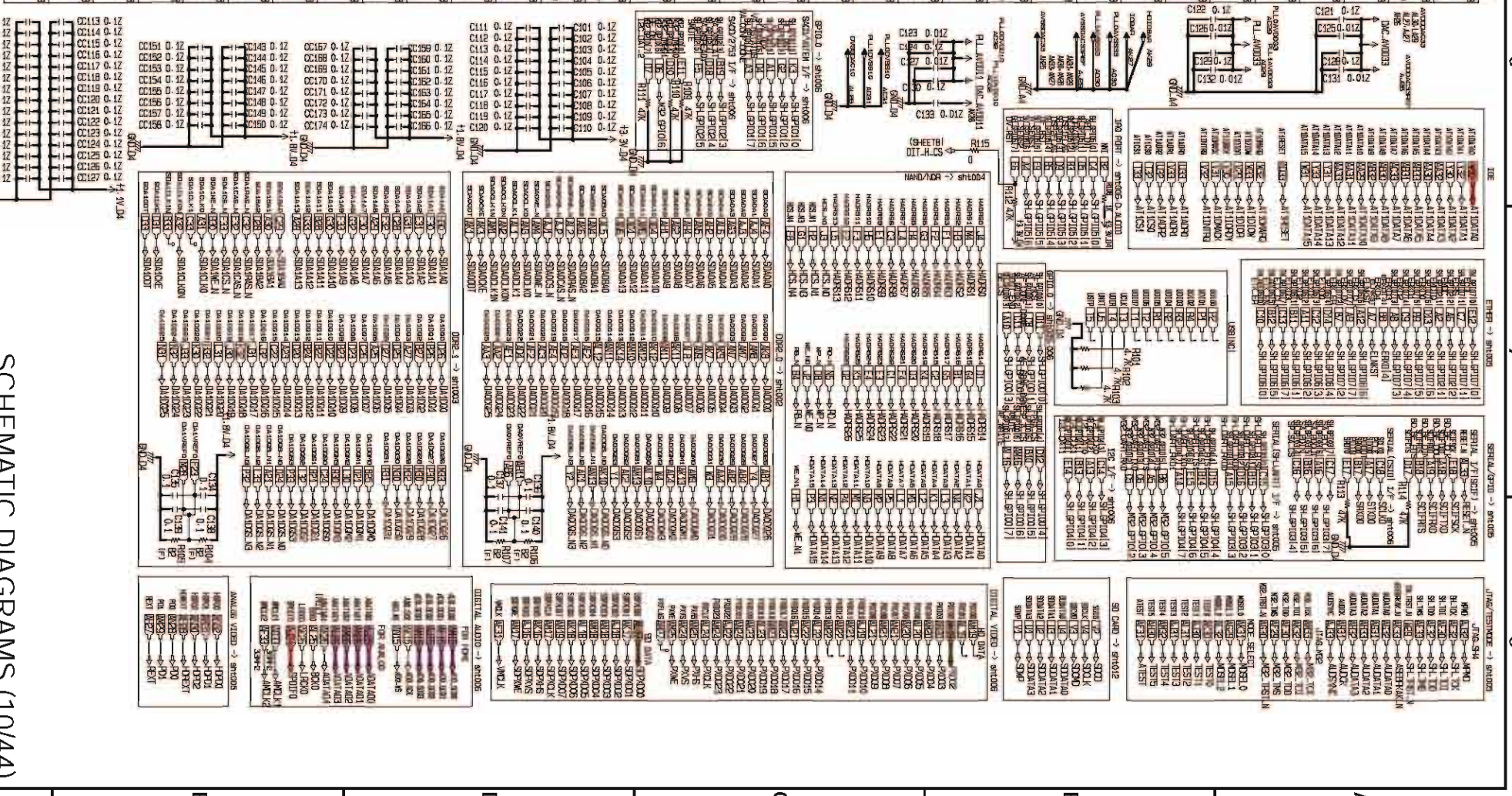

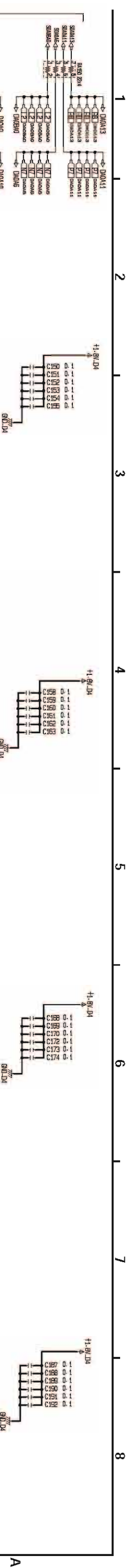

	1	2	3	4	5	6	7	8
A	1 AI2 OMC	2 E2 OMC	3 E3 OMC	4 E4 OMC	5 E5 OMC	6 E6 OMC	7 E7 OMC	8 E8 OMC
B	9 E9 OMC	10 E10 OMC	11 E11 OMC	12 E12 OMC	13 E13 OMC	14 E14 OMC	15 E15 OMC	16 E16 OMC
C	17 E17 OMC	18 E18 OMC	19 E19 OMC	20 E20 OMC	21 E21 OMC	22 E22 OMC	23 E23 OMC	24 E24 OMC
D	25 E25 OMC	26 E26 OMC	27 E27 OMC	28 E28 OMC	29 E29 OMC	30 E30 OMC	31 E31 OMC	32 E32 OMC
E	33 E33 OMC	34 E34 OMC	35 E35 OMC	36 E36 OMC	37 E37 OMC	38 E38 OMC	39 E39 OMC	40 E40 OMC
F	41 E41 OMC	42 E42 OMC	43 E43 OMC	44 E44 OMC	45 E45 OMC	46 E46 OMC	47 E47 OMC	48 E48 OMC
G	49 E49 OMC	50 E50 OMC	51 E51 OMC	52 E52 OMC	53 E53 OMC	54 E54 OMC	55 E55 OMC	56 E56 OMC
H	57 E57 OMC	58 E58 OMC	59 E59 OMC	60 E60 OMC	61 E61 OMC	62 E62 OMC	63 E63 OMC	64 E64 OMC
J	65 E65 OMC	66 E66 OMC	67 E67 OMC	68 E68 OMC	69 E69 OMC	70 E70 OMC	71 E71 OMC	72 E72 OMC
K	73 E73 OMC	74 E74 OMC	75 E75 OMC	76 E76 OMC	77 E77 OMC	78 E78 OMC	79 E79 OMC	80 E80 OMC
L	81 E81 OMC	82 E82 OMC	83 E83 OMC	84 E84 OMC	85 E85 OMC	86 E86 OMC	87 E87 OMC	88 E88 OMC
M	89 E89 OMC	90 E90 OMC	91 E91 OMC	92 E92 OMC	93 E93 OMC	94 E94 OMC	95 E95 OMC	96 E96 OMC
N	97 E97 OMC	98 E98 OMC	99 E99 OMC	100 E100 OMC	101 E101 OMC	102 E102 OMC	103 E103 OMC	104 E104 OMC
P	105 E105 OMC	106 E106 OMC	107 E107 OMC	108 E108 OMC	109 E109 OMC	110 E110 OMC	111 E111 OMC	112 E112 OMC
R	113 E113 OMC	114 E114 OMC	115 E115 OMC	116 E116 OMC	117 E117 OMC	118 E118 OMC	119 E119 OMC	120 E120 OMC
T	121 E121 OMC	122 E122 OMC	123 E123 OMC	124 E124 OMC	125 E125 OMC	126 E126 OMC	127 E127 OMC	128 E128 OMC
V	129 E129 OMC	130 E130 OMC	131 E131 OMC	132 E132 OMC	133 E133 OMC	134 E134 OMC	135 E135 OMC	136 E136 OMC
W	137 E137 OMC	138 E138 OMC	139 E139 OMC	140 E140 OMC	141 E141 OMC	142 E142 OMC	143 E143 OMC	144 E144 OMC

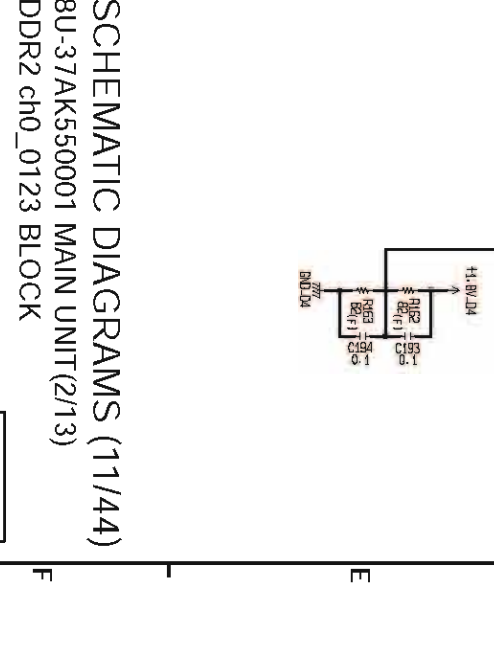
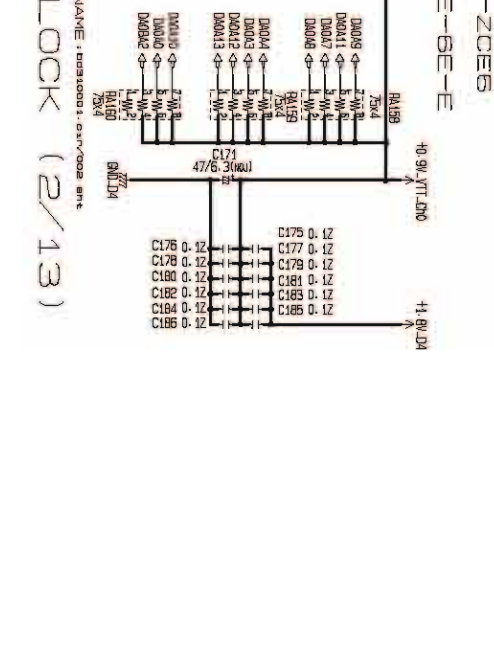
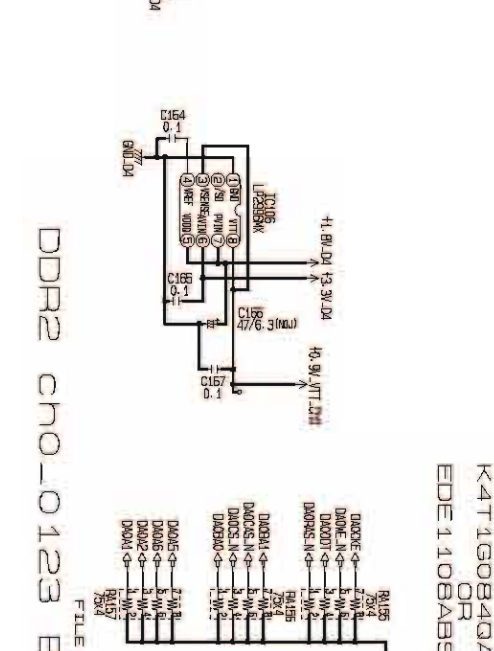
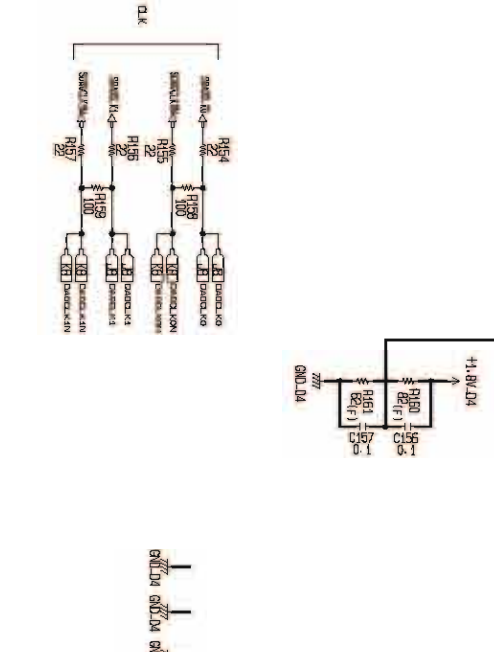
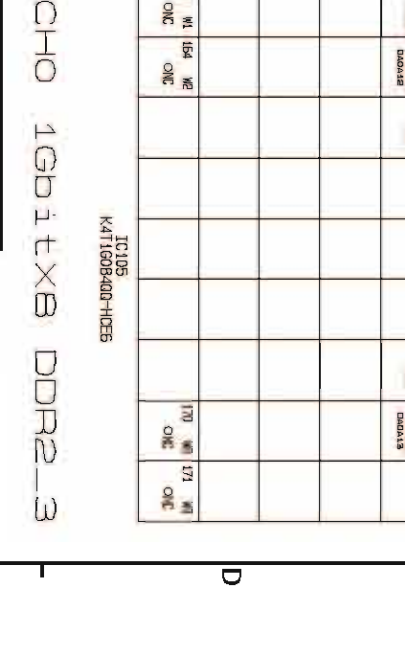
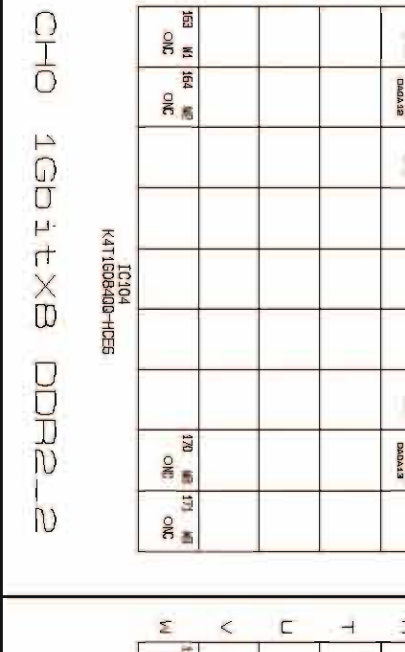
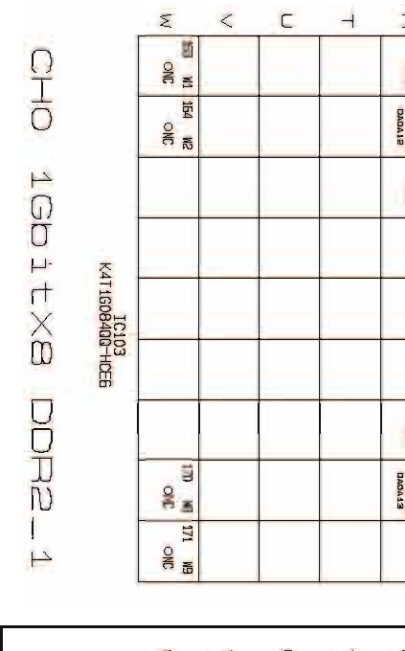

SCHEMATIC DIAGRAMS (11/44)
8U-37AK550001 MAIN UNIT(2/13)
DDR2 ch0_0123 BLOCK

UD9004

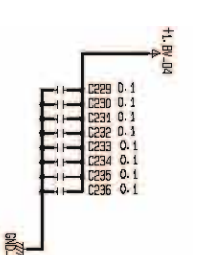
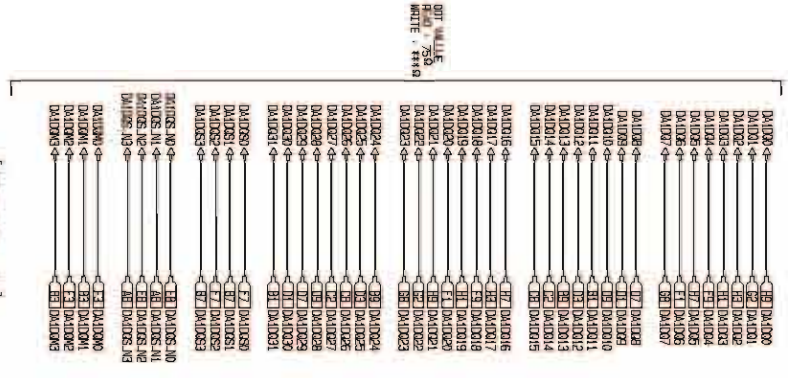
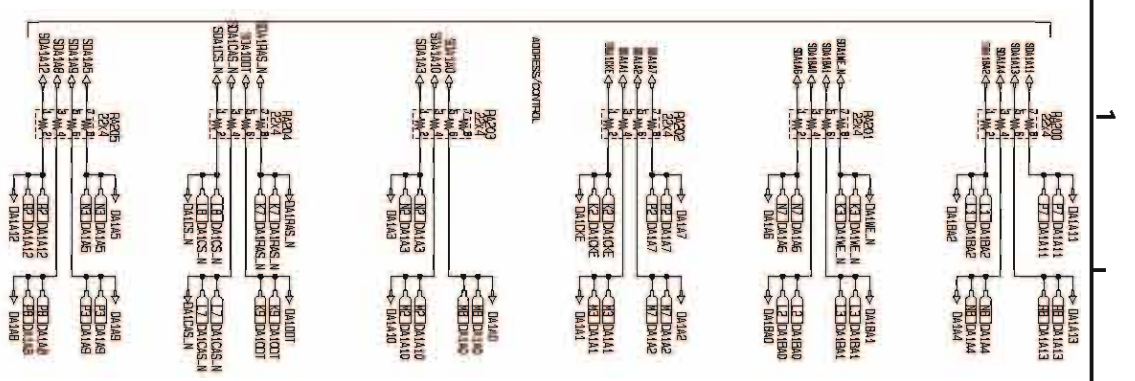
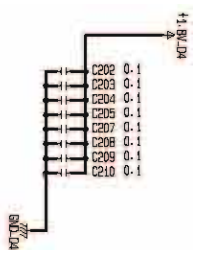

CH1 512MB 1x16 DDR2-4

IC107
K4T511630G-HCE6

	1	2	3	4	5	6	7	8	9
A	0100	0101	0102	0103	0104	0105	0106	0107	0108
B	0200	0201	0202	0203	0204	0205	0206	0207	0208
C	0300	0301	0302	0303	0304	0305	0306	0307	0308
D	0400	0401	0402	0403	0404	0405	0406	0407	0408
E	0500	0501	0502	0503	0504	0505	0506	0507	0508
F	0600	0601	0602	0603	0604	0605	0606	0607	0608
G	0700	0701	0702	0703	0704	0705	0706	0707	0708
H	0800	0801	0802	0803	0804	0805	0806	0807	0808
I	0900	0901	0902	0903	0904	0905	0906	0907	0908
J	1000	1001	1002	1003	1004	1005	1006	1007	1008
K	1100	1101	1102	1103	1104	1105	1106	1107	1108
L	1200	1201	1202	1203	1204	1205	1206	1207	1208
M	1300	1301	1302	1303	1304	1305	1306	1307	1308
N	1400	1401	1402	1403	1404	1405	1406	1407	1408
P	1500	1501	1502	1503	1504	1505	1506	1507	1508
R	1600	1601	1602	1603	1604	1605	1606	1607	1608

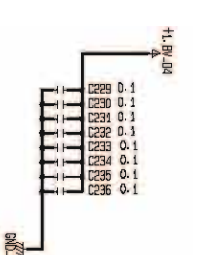
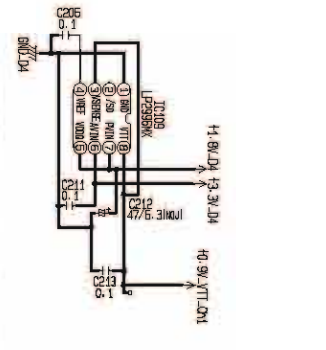
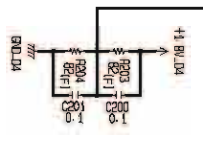

CH1 512MB 1x16 DDR2-5

IC108
K4T511630G-HCE6

	1	2	3	4	5	6	7	8	9
A	0100	0101	0102	0103	0104	0105	0106	0107	0108
B	0200	0201	0202	0203	0204	0205	0206	0207	0208
C	0300	0301	0302	0303	0304	0305	0306	0307	0308
D	0400	0401	0402	0403	0404	0405	0406	0407	0408
E	0500	0501	0502	0503	0504	0505	0506	0507	0508
F	0600	0601	0602	0603	0604	0605	0606	0607	0608
G	0700	0701	0702	0703	0704	0705	0706	0707	0708
H	0800	0801	0802	0803	0804	0805	0806	0807	0808
I	0900	0901	0902	0903	0904	0905	0906	0907	0908
J	1000	1001	1002	1003	1004	1005	1006	1007	1008
K	1100	1101	1102	1103	1104	1105	1106	1107	1108
L	1200	1201	1202	1203	1204	1205	1206	1207	1208
M	1300	1301	1302	1303	1304	1305	1306	1307	1308
N	1400	1401	1402	1403	1404	1405	1406	1407	1408
P	1500	1501	1502	1503	1504	1505	1506	1507	1508
R	1600	1601	1602	1603	1604	1605	1606	1607	1608

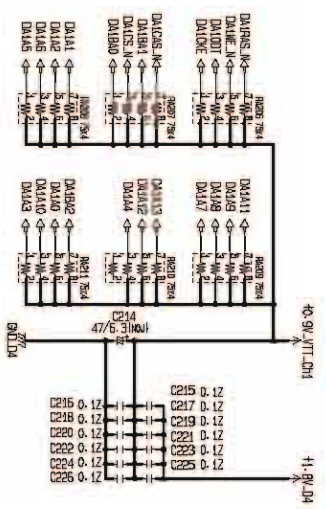
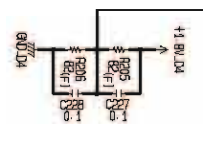

[Bank -1]

FILE NAME : D030001.DV003.SMT

DDR2 CH1-45 BLOCK (3/13)

SCHEMATIC DIAGRAMS (12/44)

8U-37AK550001 MAIN UNIT(3/13)

DDR2 ch1_45 BLOCK

UD9004

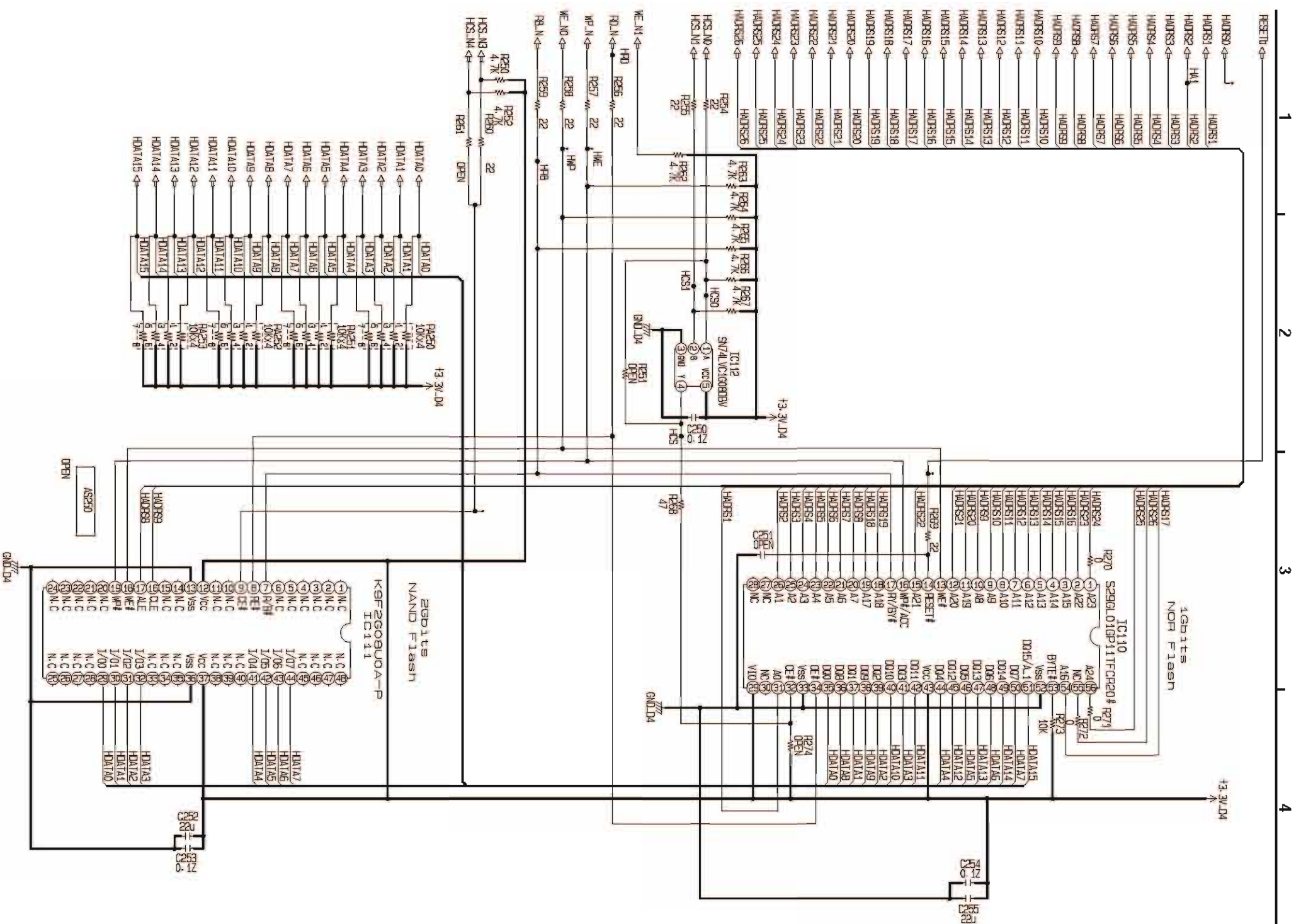

NOR/NAND BLOCK (4/13)

FILE NAME: r0030001.dlv/psal.dms

EBI_ADDR55	NAND
EBI_ADDR56	NAND
EBI_ADDR57	NAND
EBI_ADDR58	NAND
EBI_ADDR59	NAND
EBI_ADDR60	NAND
EBI_ADDR61	NAND
EBI_ADDR62	NAND
EBI_ADDR63	NAND
EBI_ADDR64	NAND
EBI_ADDR65	NAND
EBI_ADDR66	NAND
EBI_ADDR67	NAND
EBI_ADDR68	NAND
EBI_ADDR69	NAND
EBI_ADDR70	NAND
EBI_ADDR71	NAND
EBI_ADDR72	NAND
EBI_ADDR73	NAND
EBI_ADDR74	NAND
EBI_ADDR75	NAND
EBI_ADDR76	NAND
EBI_ADDR77	NAND
EBI_ADDR78	NAND
EBI_ADDR79	NAND
EBI_ADDR80	NAND
EBI_ADDR81	NAND
EBI_ADDR82	NAND
EBI_ADDR83	NAND
EBI_ADDR84	NAND
EBI_ADDR85	NAND
EBI_ADDR86	NAND
EBI_ADDR87	NAND
EBI_ADDR88	NAND
EBI_ADDR89	NAND
EBI_ADDR90	NAND
EBI_ADDR91	NAND
EBI_ADDR92	NAND
EBI_ADDR93	NAND
EBI_ADDR94	NAND
EBI_ADDR95	NAND
EBI_ADDR96	NAND
EBI_ADDR97	NAND
EBI_ADDR98	NAND
EBI_ADDR99	NAND
EBI_ADDR100	NAND
EBI_ADDR101	NAND
EBI_ADDR102	NAND
EBI_ADDR103	NAND
EBI_ADDR104	NAND
EBI_ADDR105	NAND
EBI_ADDR106	NAND
EBI_ADDR107	NAND
EBI_ADDR108	NAND
EBI_ADDR109	NAND
EBI_ADDR110	NAND
EBI_ADDR111	NAND
EBI_ADDR112	NAND
EBI_ADDR113	NAND
EBI_ADDR114	NAND
EBI_ADDR115	NAND
EBI_ADDR116	NAND
EBI_ADDR117	NAND
EBI_ADDR118	NAND
EBI_ADDR119	NAND
EBI_ADDR120	NAND
EBI_ADDR121	NAND
EBI_ADDR122	NAND
EBI_ADDR123	NAND
EBI_ADDR124	NAND
EBI_ADDR125	NAND
EBI_ADDR126	NAND
EBI_ADDR127	NAND
EBI_ADDR128	NAND
EBI_ADDR129	NAND
EBI_ADDR130	NAND
EBI_ADDR131	NAND
EBI_ADDR132	NAND
EBI_ADDR133	NAND
EBI_ADDR134	NAND
EBI_ADDR135	NAND
EBI_ADDR136	NAND
EBI_ADDR137	NAND
EBI_ADDR138	NAND
EBI_ADDR139	NAND
EBI_ADDR140	NAND
EBI_ADDR141	NAND
EBI_ADDR142	NAND
EBI_ADDR143	NAND
EBI_ADDR144	NAND
EBI_ADDR145	NAND
EBI_ADDR146	NAND
EBI_ADDR147	NAND
EBI_ADDR148	NAND
EBI_ADDR149	NAND
EBI_ADDR150	NAND
EBI_ADDR151	NAND
EBI_ADDR152	NAND
EBI_ADDR153	NAND
EBI_ADDR154	NAND
EBI_ADDR155	NAND
EBI_ADDR156	NAND
EBI_ADDR157	NAND
EBI_ADDR158	NAND
EBI_ADDR159	NAND
EBI_ADDR160	NAND
EBI_ADDR161	NAND
EBI_ADDR162	NAND
EBI_ADDR163	NAND
EBI_ADDR164	NAND
EBI_ADDR165	NAND
EBI_ADDR166	NAND
EBI_ADDR167	NAND
EBI_ADDR168	NAND
EBI_ADDR169	NAND
EBI_ADDR170	NAND
EBI_ADDR171	NAND
EBI_ADDR172	NAND
EBI_ADDR173	NAND
EBI_ADDR174	NAND
EBI_ADDR175	NAND
EBI_ADDR176	NAND
EBI_ADDR177	NAND
EBI_ADDR178	NAND
EBI_ADDR179	NAND
EBI_ADDR180	NAND
EBI_ADDR181	NAND
EBI_ADDR182	NAND
EBI_ADDR183	NAND
EBI_ADDR184	NAND
EBI_ADDR185	NAND
EBI_ADDR186	NAND
EBI_ADDR187	NAND
EBI_ADDR188	NAND
EBI_ADDR189	NAND
EBI_ADDR190	NAND
EBI_ADDR191	NAND
EBI_ADDR192	NAND
EBI_ADDR193	NAND
EBI_ADDR194	NAND
EBI_ADDR195	NAND
EBI_ADDR196	NAND
EBI_ADDR197	NAND
EBI_ADDR198	NAND
EBI_ADDR199	NAND
EBI_ADDR200	NAND

SCHEMATIC DIAGRAMS (13/44)
8U-37AK550001 MAIN UNIT(4/13)
NOR/NAND BLOCK

UD9004

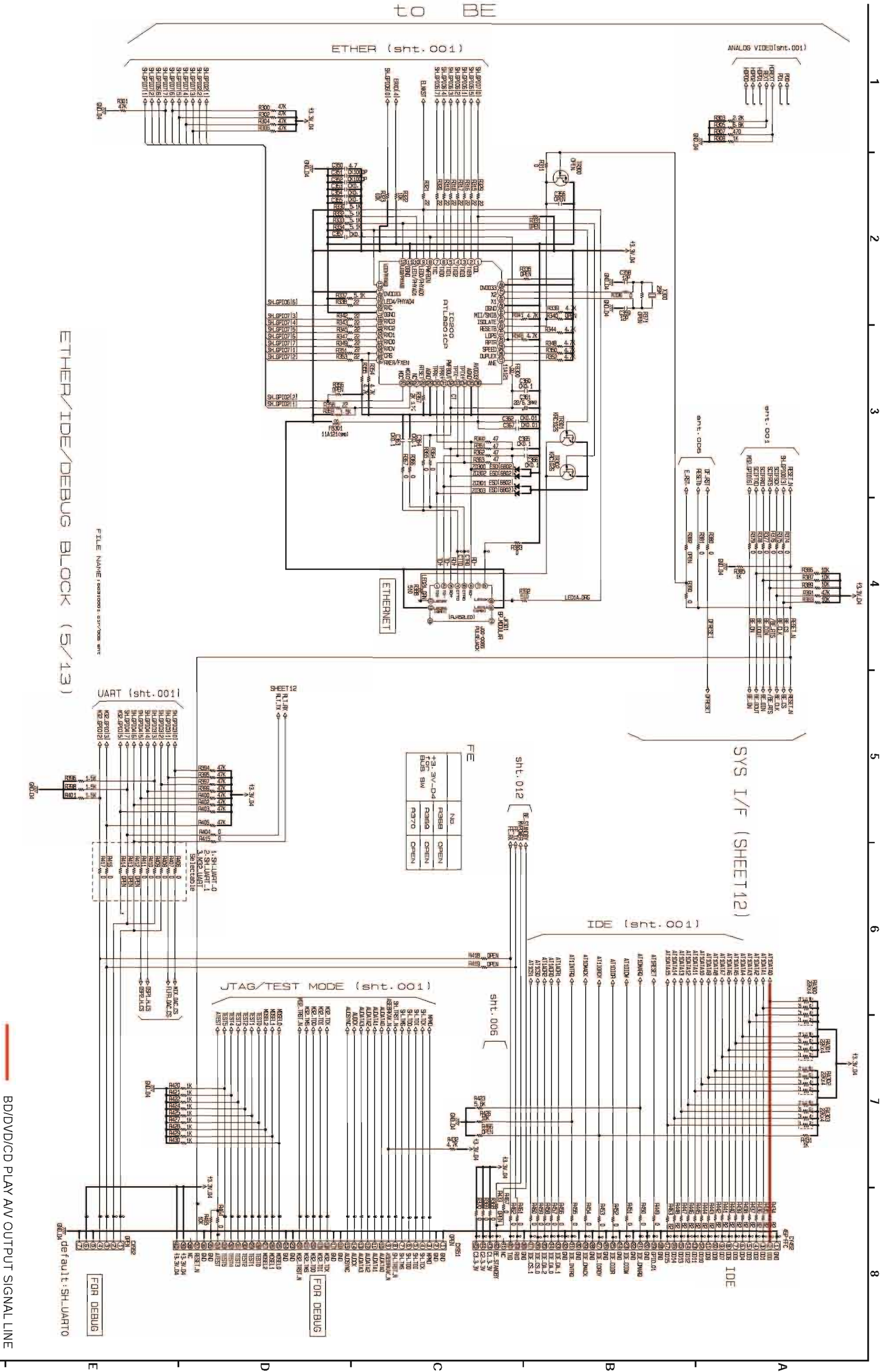

ETHER/IDE/DEBUG BLOCK (5/13)

BD/DVD/CD PLAY AV OUTPUT SIGNAL LINE

SCHEMATIC DIAGRAMS (14/44)
 8U-37AK550001 MAIN UNIT(5/13)
 ETHER/IDE/DEBUG BLOCK

UD9004

to BE

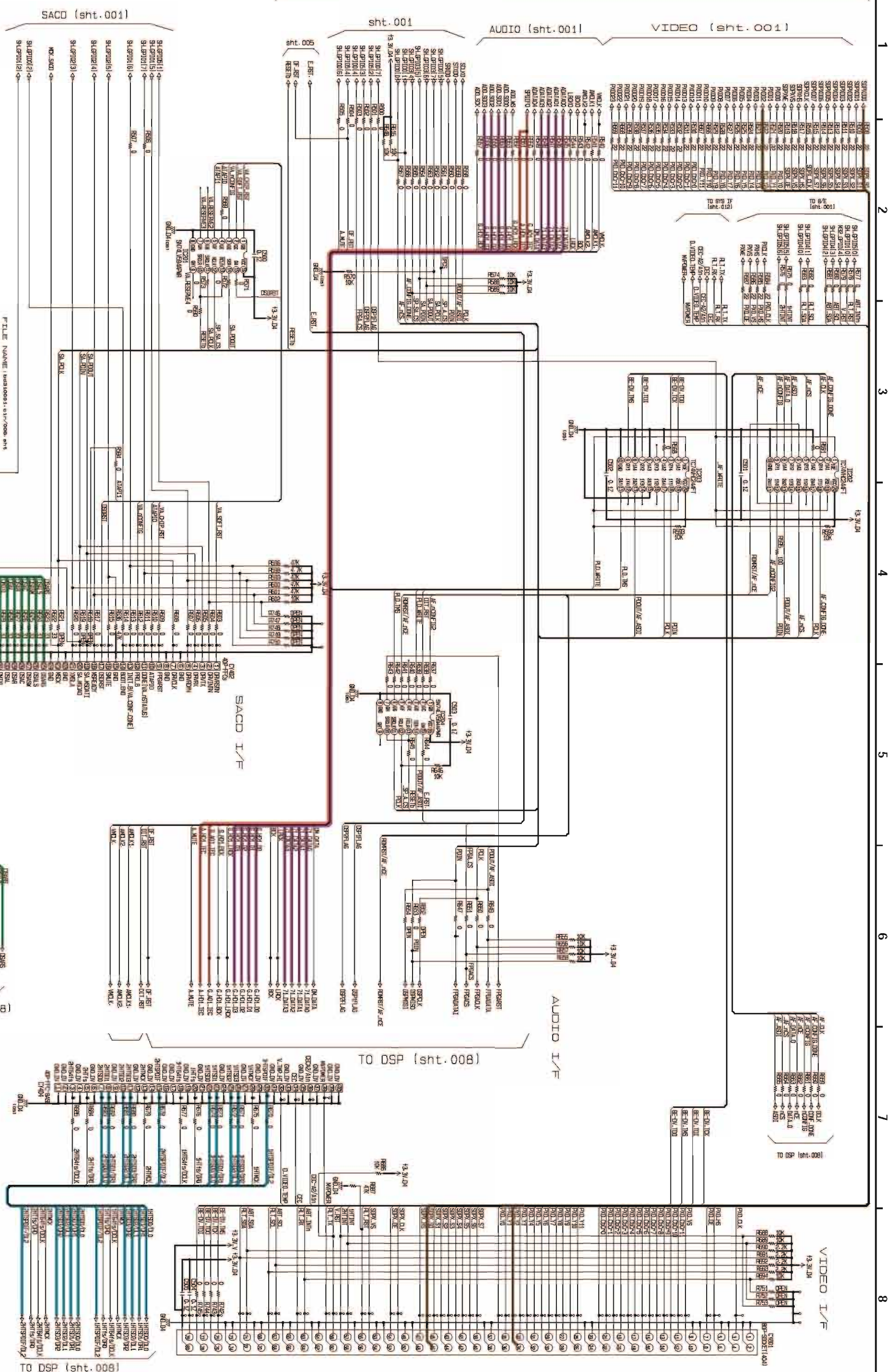

FILE NAME I:\s10001\c1r\006.sht

DIGITAL AV BLOCK (6/13)

BD/DVD PLAY VIDEO OUTPUT SIGNAL LINE

BD/DVD/CD PLAY AUDIO OUTPUT SIGNAL LINE

BD/DVD/CD PLAY SPDIF OUTPUT SIGNAL LINE

HDMI AUDIO OUTPUT SIGNAL LINE

SACD PLAY AUDIO OUTPUT SIGNAL LINE

TO DSP (sht.008)

TO DSP (sht.008)

TO DSP (sht.008)

SCHEMATIC DIAGRAMS (15/44)

8U-37AK550001 MAIN UNIT(6/13)

UD9004

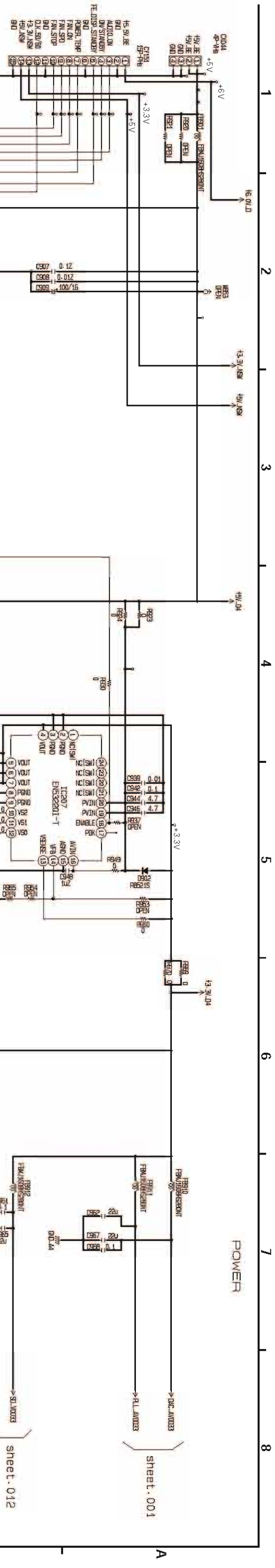

sheet.001

sheet.012

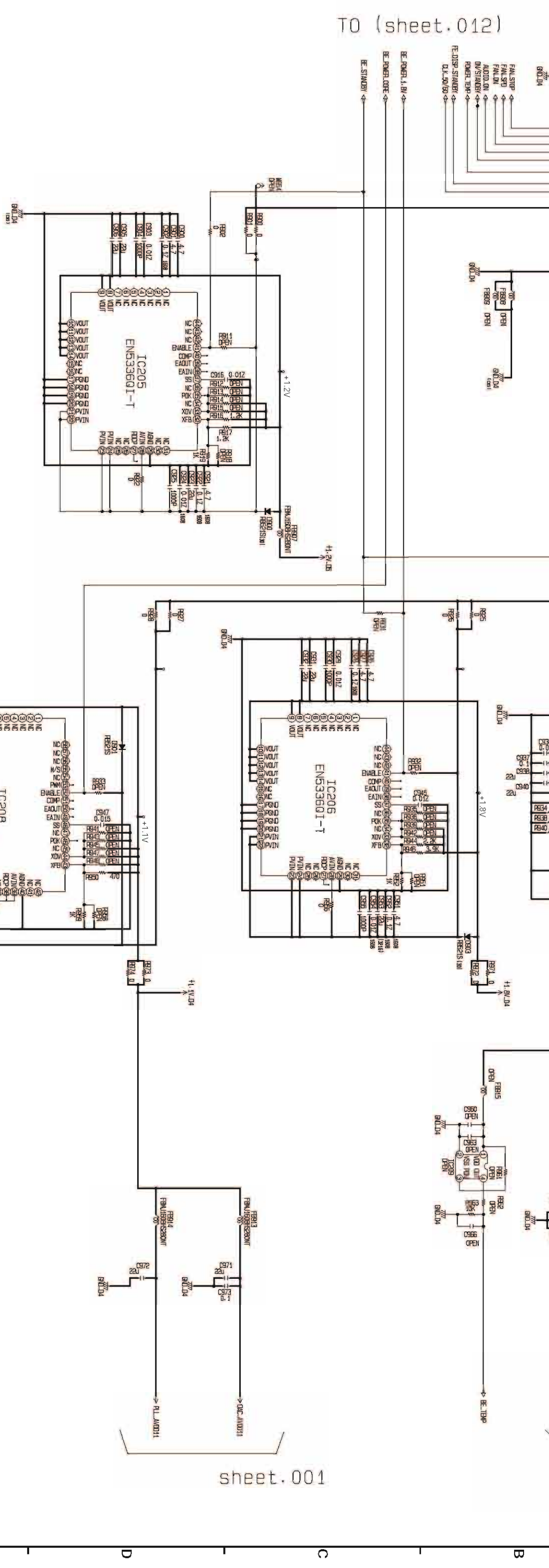

sheet.001

FILE NAME : D8A80001.CNV*007.BMS

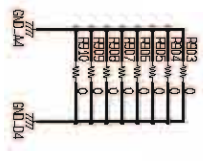

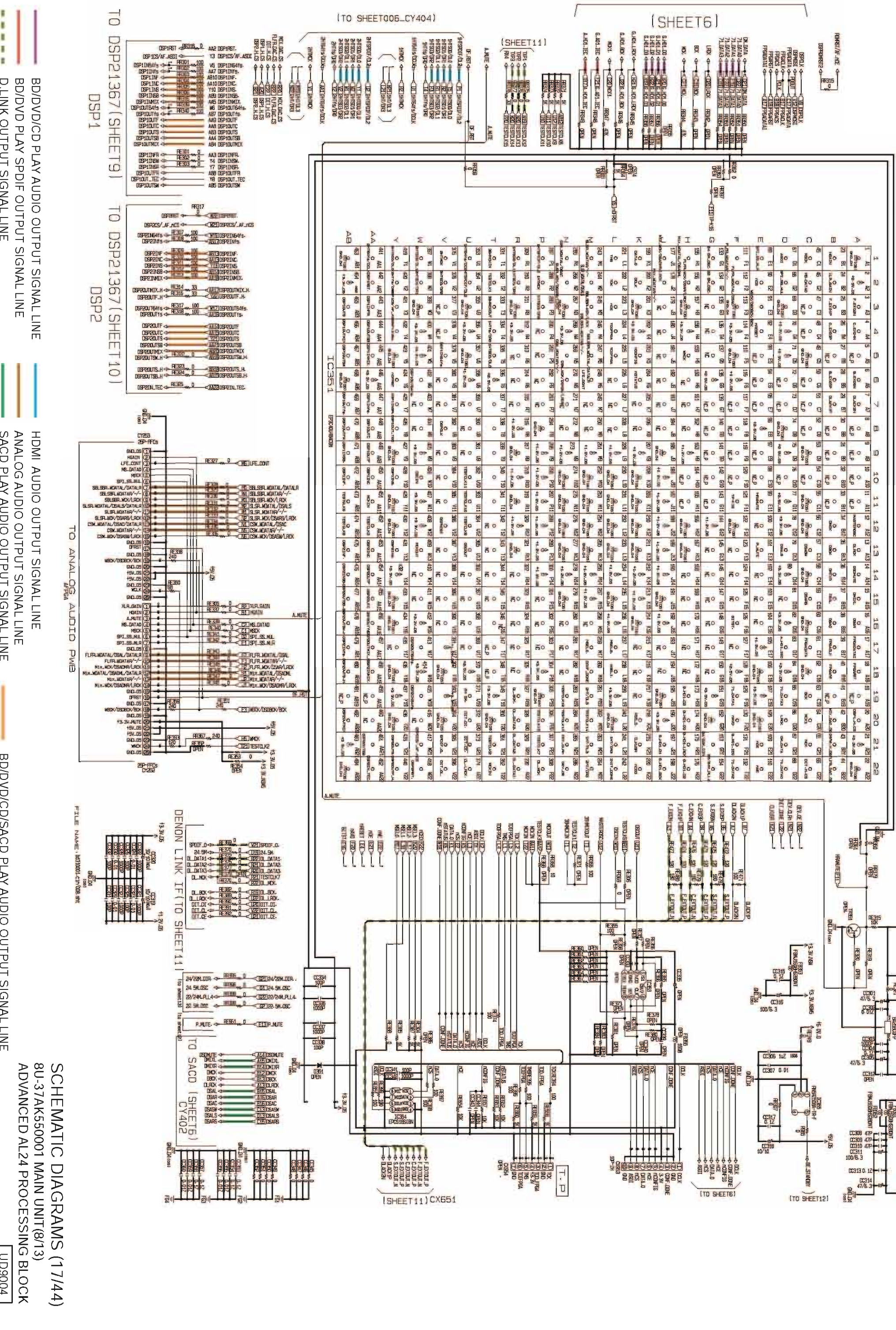

SCHEMATIC DIAGRAMS (1/7/4)

8U-37AK50001 MAIN UNIT(8/13)

ADVANCED AL24 PROCESSING BLOCK

UD9004

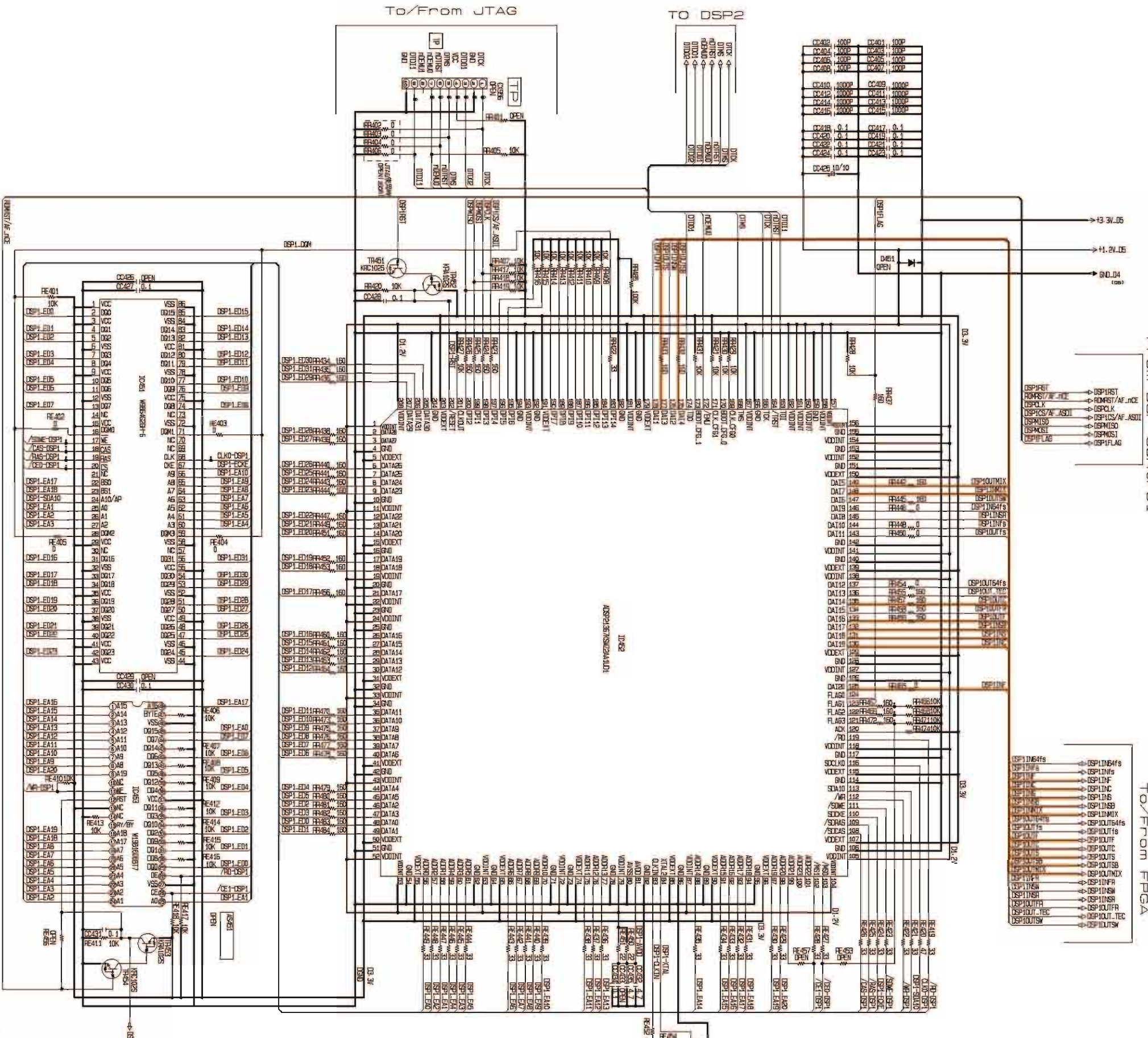

DSP1 BLOCK (9/13)

UD1-DSP1
Dolby true-HD Decoder
ADSP21367

BD/DVD/CD/SACD PLAY AUDIO OUTPUT SIGNAL LINE

SCHEMATIC DIAGRAMS (18/44)
8U-37AK550001 MAIN UNIT(9/13)
DSP1 BLOCK

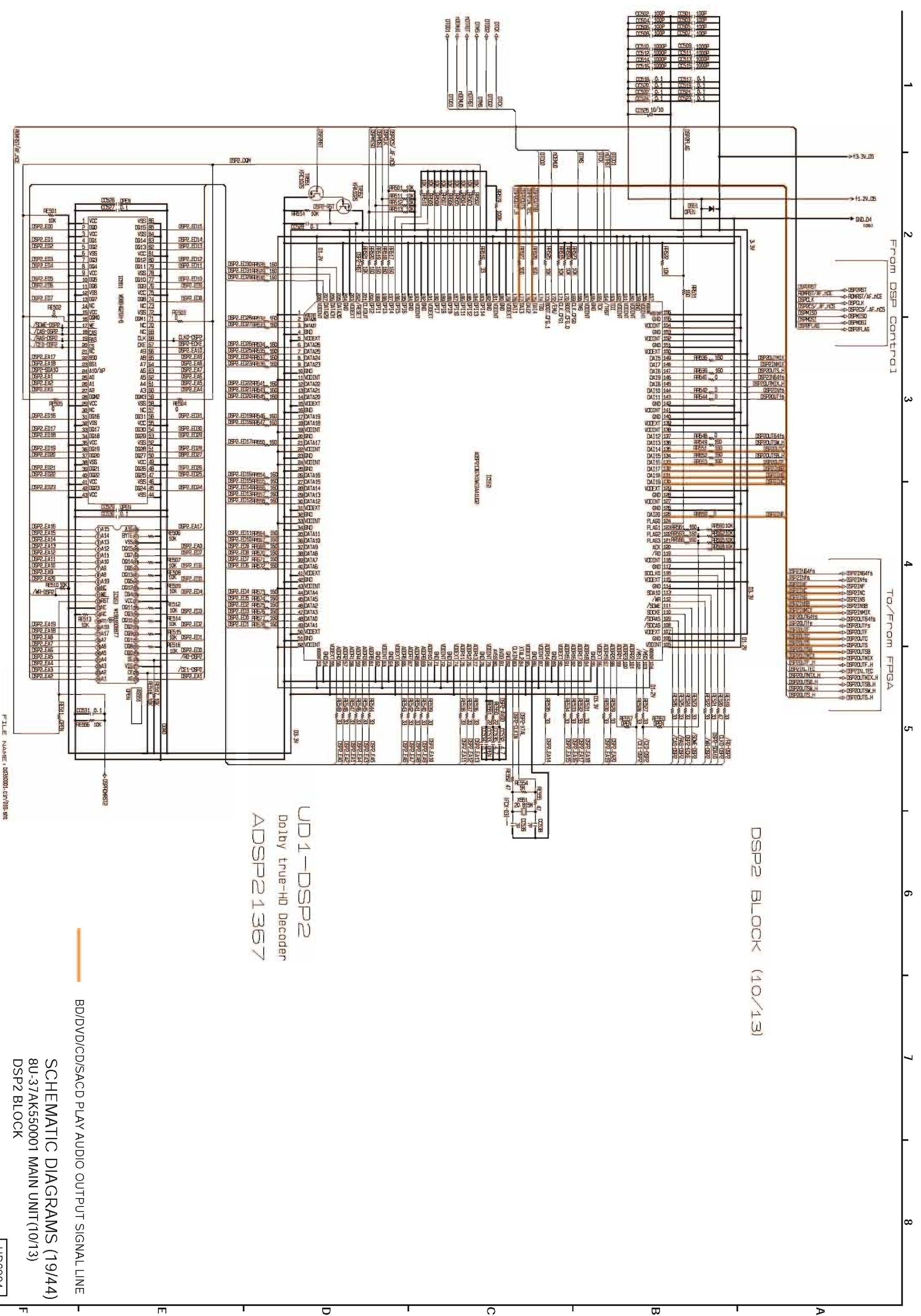

From DSP control1

To/From FPGA

DSP2 BLOCK (10/13)

UD1-DSP2
Dolby True-HD Decoder
ADSP21367

BD/DVD/CD/SACD PLAY AUDIO OUTPUT SIGNAL LINE

SCHEMATIC DIAGRAMS (19/44)
8U-37AK550001 MAIN UNIT(10/13)
DSP2 BLOCK

UD9004

FILE NAME : 0230001_037/006_91E

DENON LINK IF (TO SHEET 14)

(SHEET8)

(SHEET8)

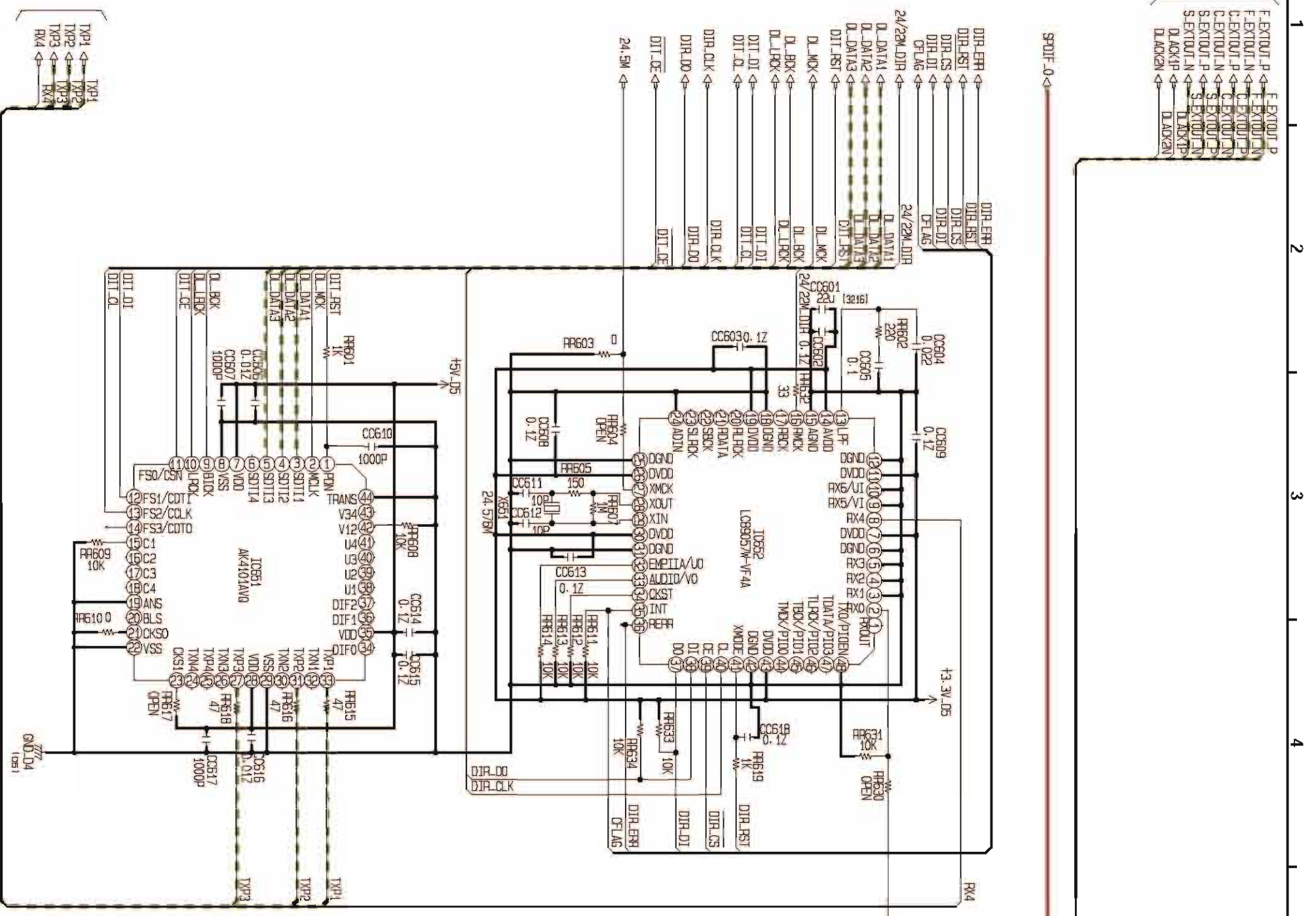

FILE NAME : DD310001.CIF/011.SHT

D.Lin(DIT/DIR) BLOCK (11/13)

DIGITALOUT UNIT

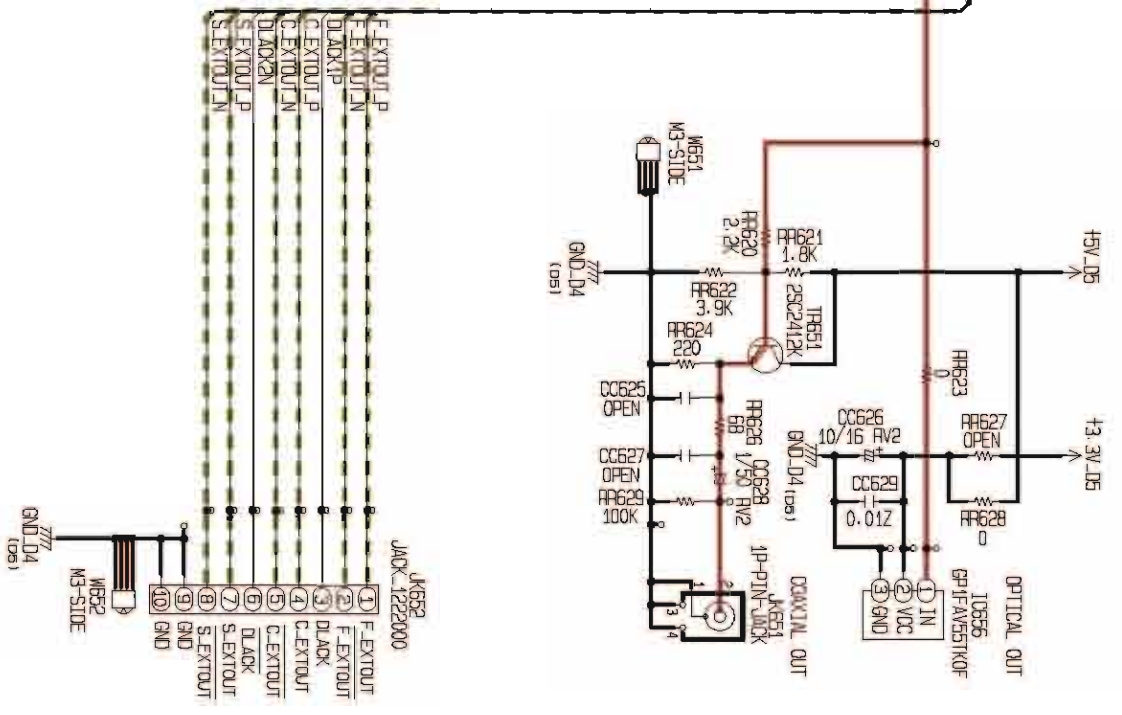

— BD/DVD/CD PLAY SPDIF OUTPUT SIGNAL LINE
- - - D.LINK OUTPUT SIGNAL LINE

SCHEMATIC DIAGRAMS (20/44)
 8U-37AK550001 MAIN UNIT(11/13)
 D.Lin(DIT/DIR) BLOCK

UD9004

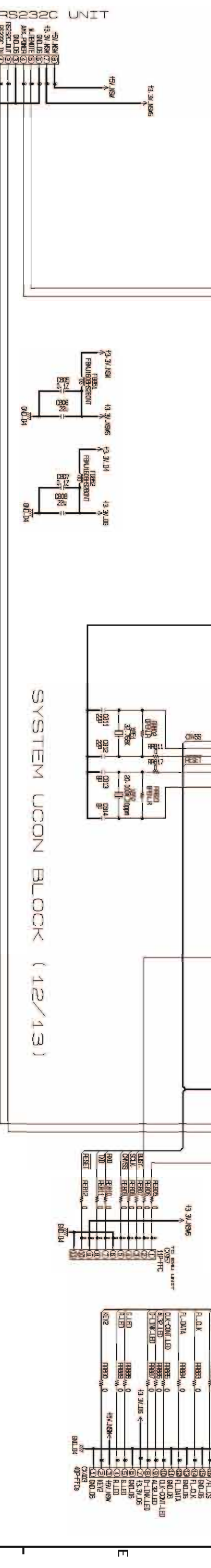
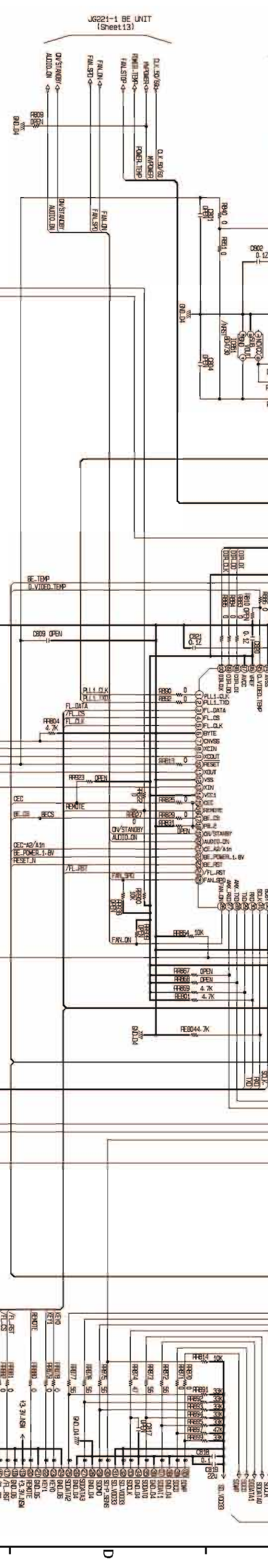
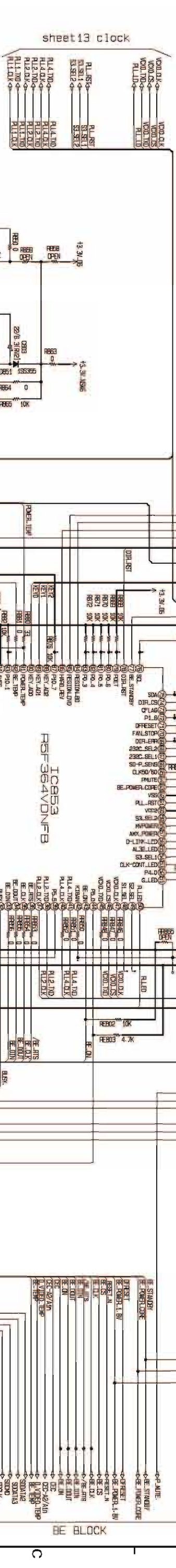
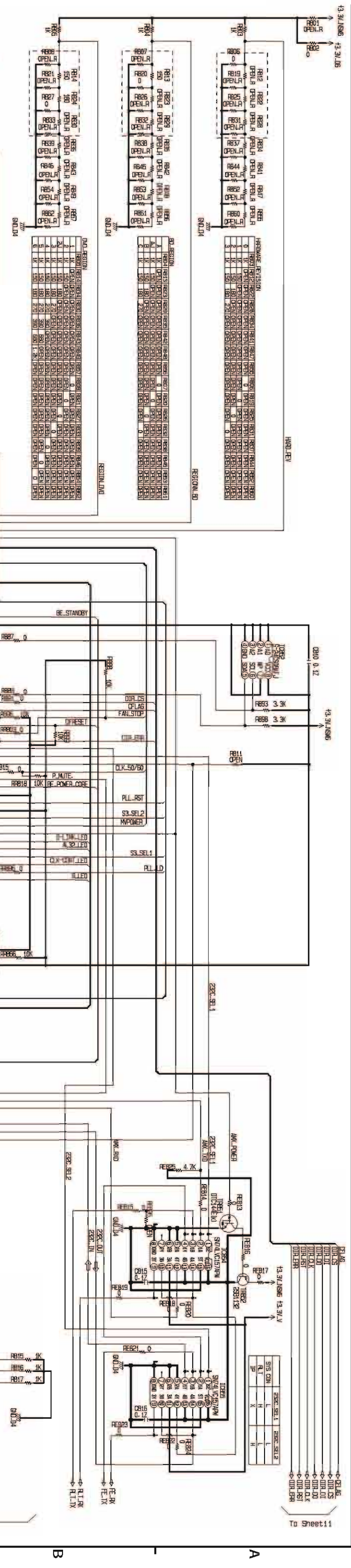

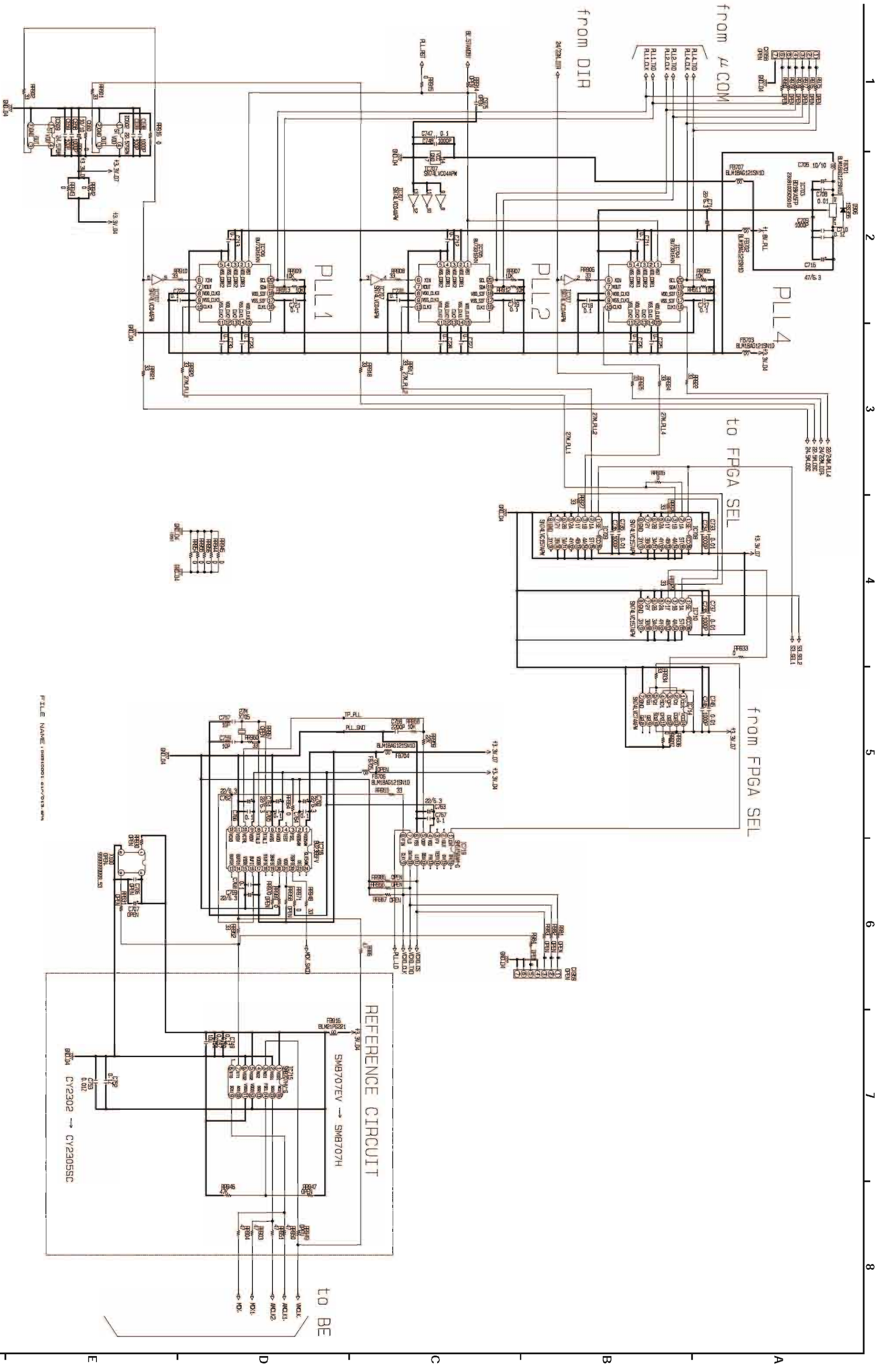

FILE NAME: D851001.SUP/V013.BIT

SCHEMATIC DIAGRAMS (22/44)
8U-37AK550001 MAIN UNIT(13/13)

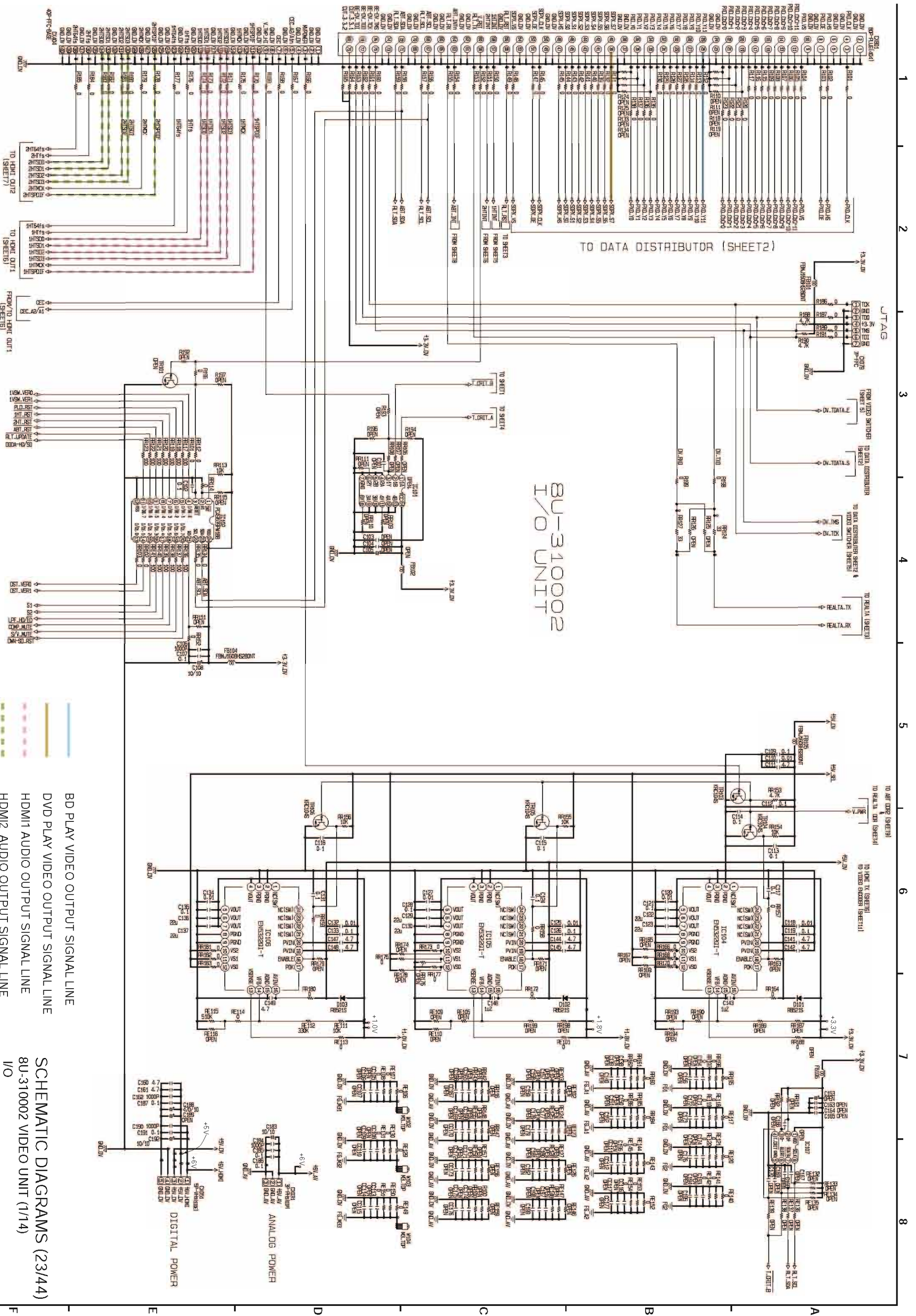

**BU-310002
I/O UNIT**

BD PLAY VIDEO OUTPUT SIGNAL LINE
 DVD PLAY VIDEO OUTPUT SIGNAL LINE
 HDMI1 AUDIO OUTPUT SIGNAL LINE
 HDMI2 AUDIO OUTPUT SIGNAL LINE

SCHEMATIC DIAGRAMS (23/44)
 8U-310002 VIDEO UNIT (1/14)
 I/O

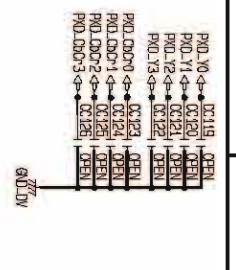

FROM I/O (SHEET1)

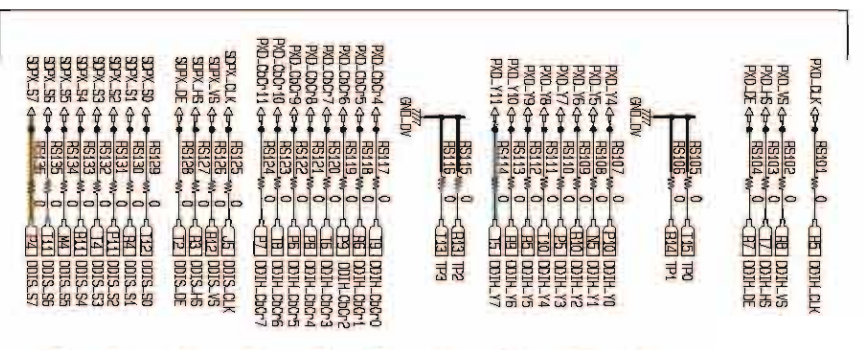

A	B	C	D	E	F	G	H	J	K	L	M	N	P	R	T
A1	A2	A3	A4	A5	A6	A7	A8	A9	A10	A11	A12	A13	A14	A15	A16
B1	B2	B3	B4	B5	B6	B7	B8	B9	B10	B11	B12	B13	B14	B15	B16
C1	C2	C3	C4	C5	C6	C7	C8	C9	C10	C11	C12	C13	C14	C15	C16
D1	D2	D3	D4	D5	D6	D7	D8	D9	D10	D11	D12	D13	D14	D15	D16
E1	E2	E3	E4	E5	E6	E7	E8	E9	E10	E11	E12	E13	E14	E15	E16
F1	F2	F3	F4	F5	F6	F7	F8	F9	F10	F11	F12	F13	F14	F15	F16
G1	G2	G3	G4	G5	G6	G7	G8	G9	G10	G11	G12	G13	G14	G15	G16
H1	H2	H3	H4	H5	H6	H7	H8	H9	H10	H11	H12	H13	H14	H15	H16
J1	J2	J3	J4	J5	J6	J7	J8	J9	J10	J11	J12	J13	J14	J15	J16
K1	K2	K3	K4	K5	K6	K7	K8	K9	K10	K11	K12	K13	K14	K15	K16
L1	L2	L3	L4	L5	L6	L7	L8	L9	L10	L11	L12	L13	L14	L15	L16
M1	M2	M3	M4	M5	M6	M7	M8	M9	M10	M11	M12	M13	M14	M15	M16
N1	N2	N3	N4	N5	N6	N7	N8	N9	N10	N11	N12	N13	N14	N15	N16
P1	P2	P3	P4	P5	P6	P7	P8	P9	P10	P11	P12	P13	P14	P15	P16
R1	R2	R3	R4	R5	R6	R7	R8	R9	R10	R11	R12	R13	R14	R15	R16
T1	T2	T3	T4	T5	T6	T7	T8	T9	T10	T11	T12	T13	T14	T15	T16

IC108 EPM570F25BCSN

FROM/TO I/O (SHEET1)

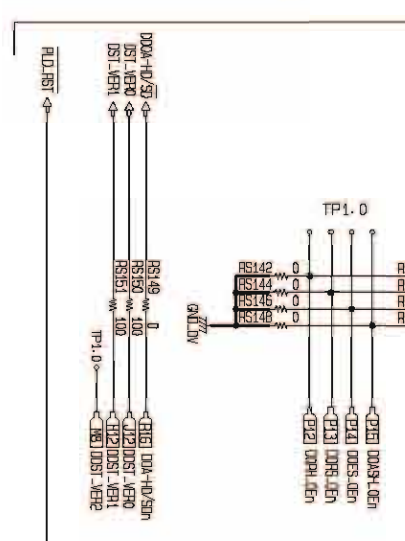

TO VIDEO, ENCODER FOR Y/C (SHEET13)

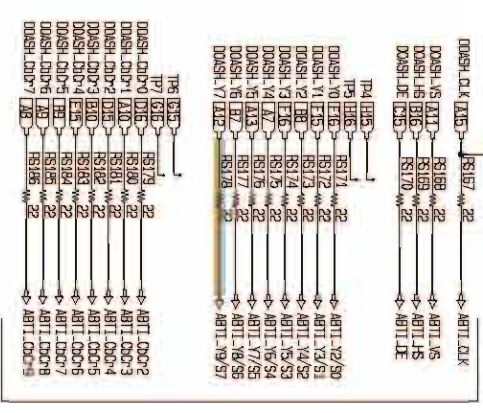

TO ABT2010 (SHEET8)

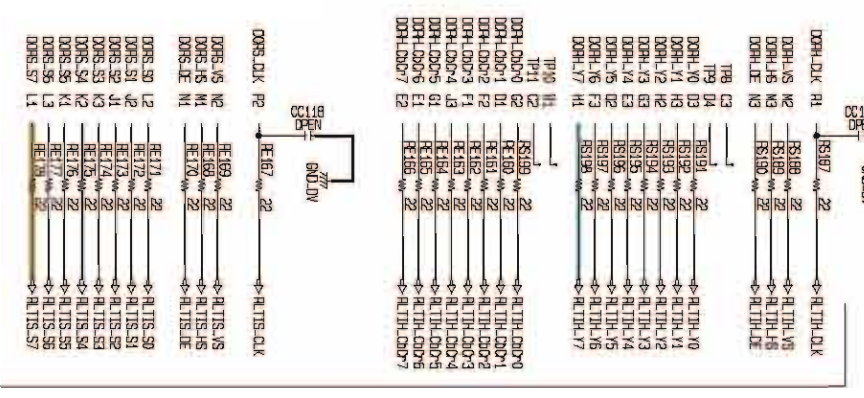

TO REALTA (SHEET3)

BU-310002
DATA DISTRIBUTOR
BD PLAY VIDEO OUTPUT SIGNAL LINE
DVD PLAY VIDEO OUTPUT SIGNAL LINE

SCHEMATIC DIAGRAMS (24/44)
8U-310002 VIDEO UNIT (2/14)
DATA DISTRIBUTOR

UD9004

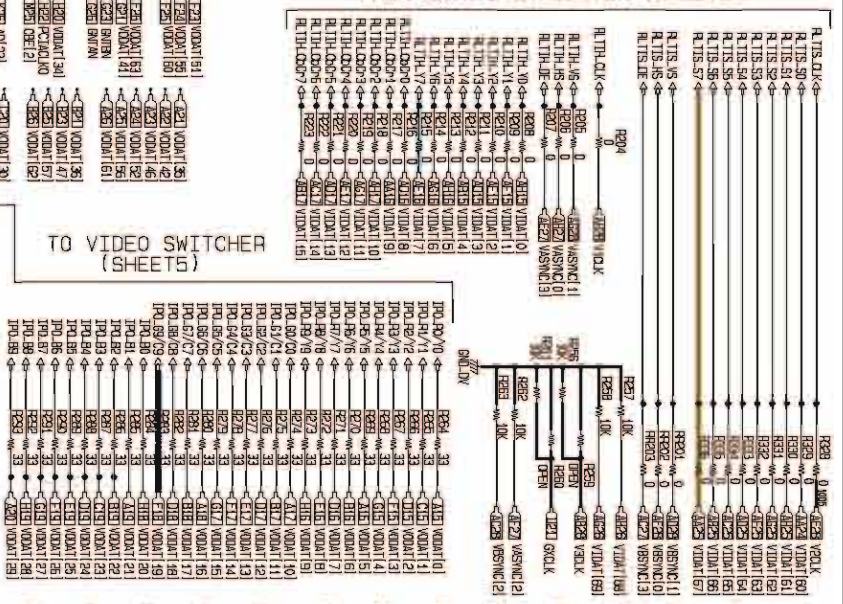

TO VIDEO SWITCHER (SHEET 5)

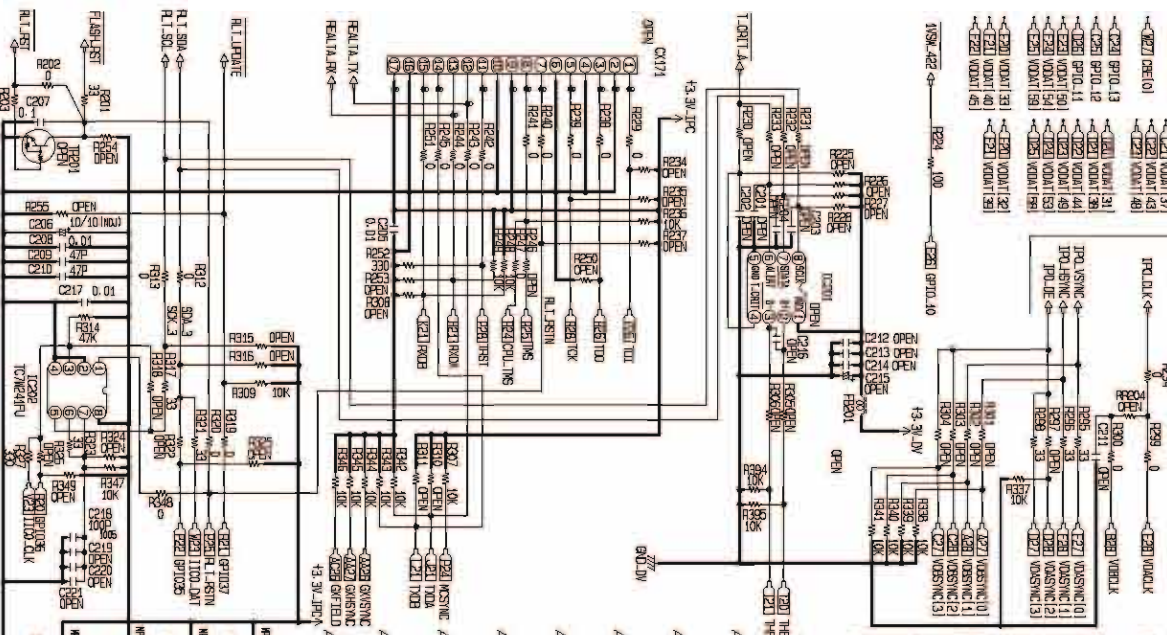

IC203 SXT2LF-400 (RealT2a) (Top View)

	1	2	3	4	5	6	7	8	9	10	11	12	13	14	15	16	17	18	19	20	21	22	23	24	25	26	27	28
A	1	2	3	4	5	6	7	8	9	10	11	12	13	14	15	16	17	18	19	20	21	22	23	24	25	26	27	28
B
C
D
E
F
G
H
I
J
K
L
M
N
O
P
Q
R
S
T
U
V
W
X
Y
Z
AA
AB
AC
AD
AE
AF
AG
AH
AI

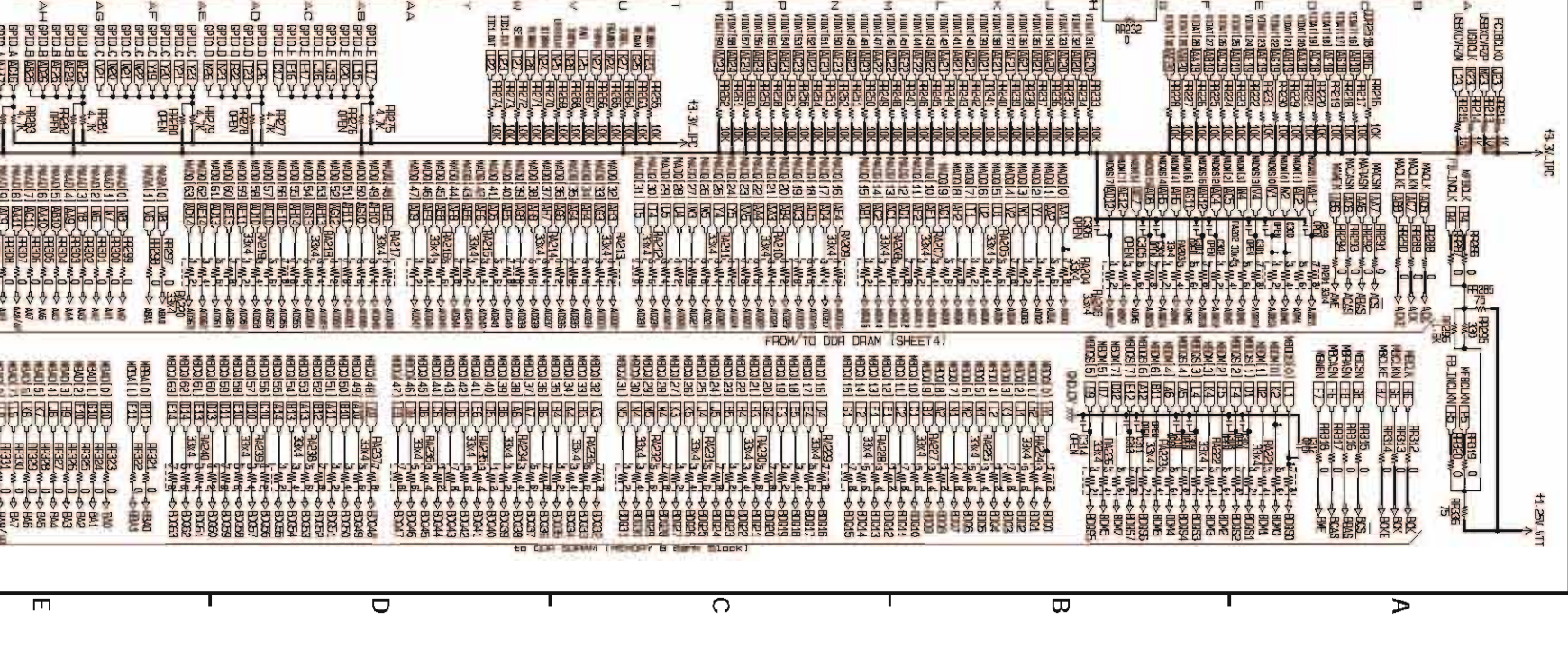

SCHEMATIC DIAGRAMS (25/44) 8U-310002 VIDEO UNIT (3/14)

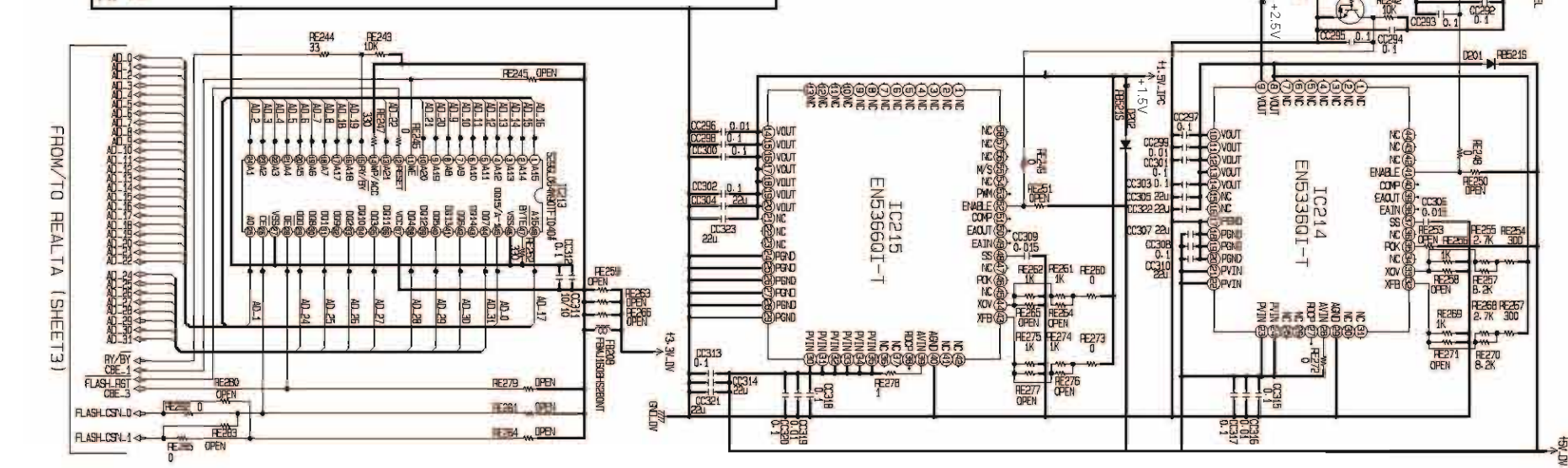
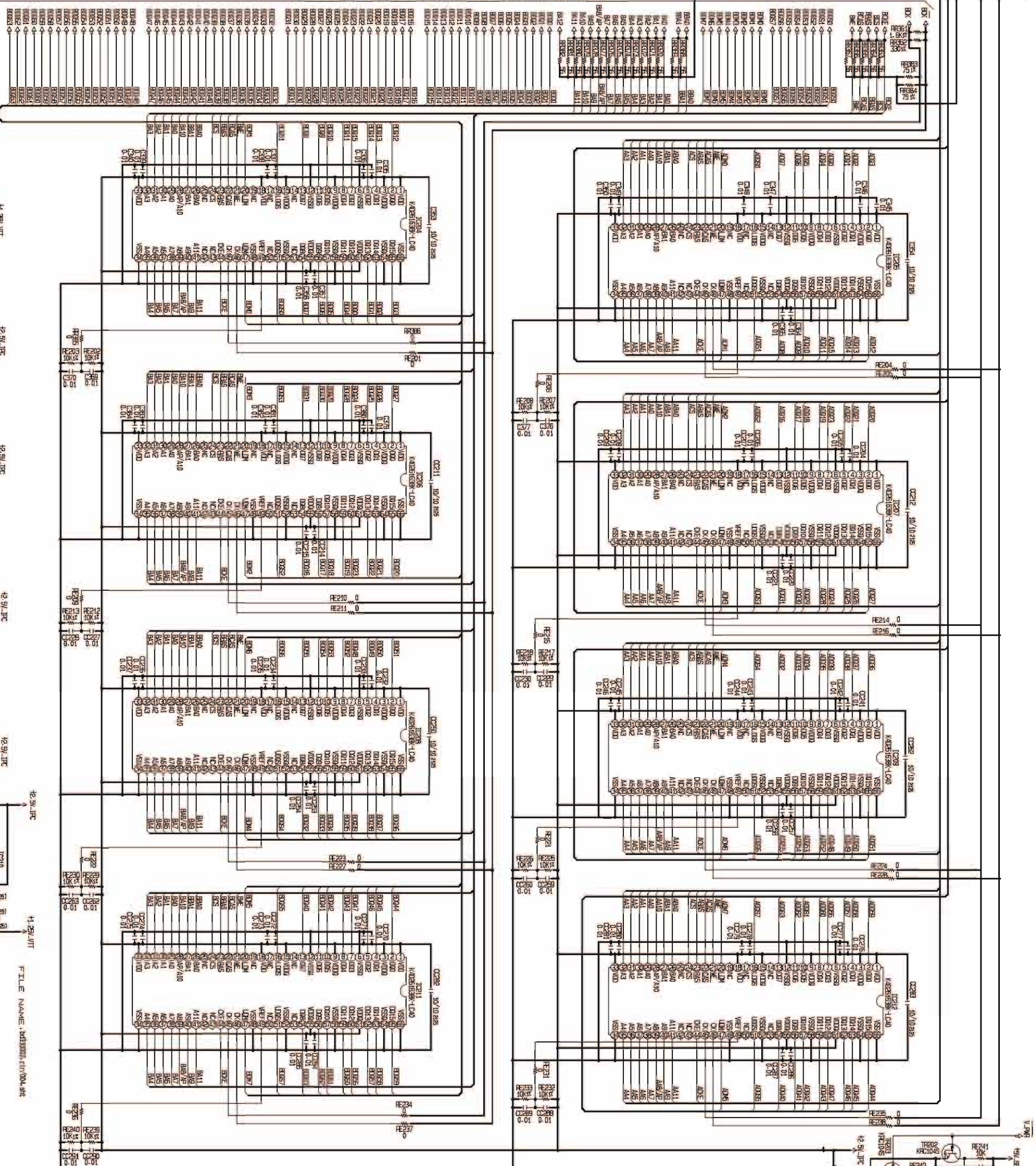
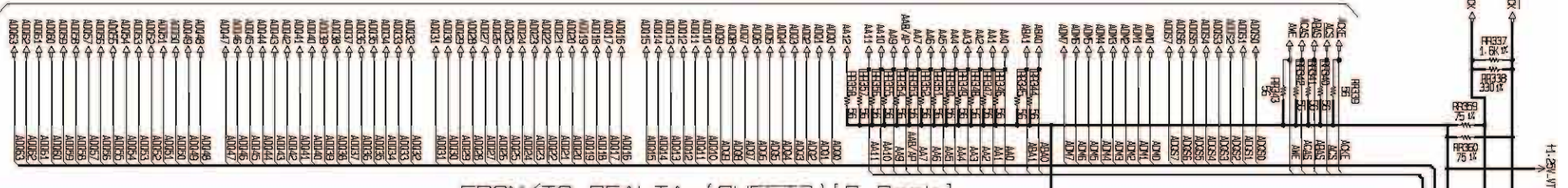

FROM/TO REALTA (SHEET3)

FILE NAME: D830002.C1004.SHT

SCHEMATIC DIAGRAMS (26/44)
8U-310002 VIDEO UNIT (4/14)

UD9004

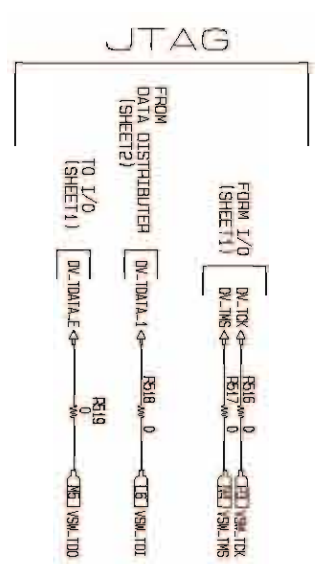
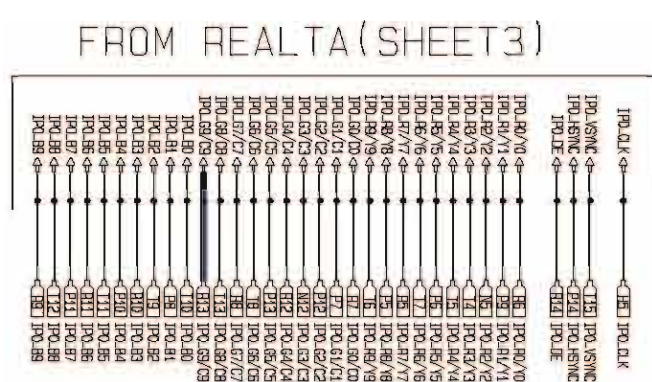
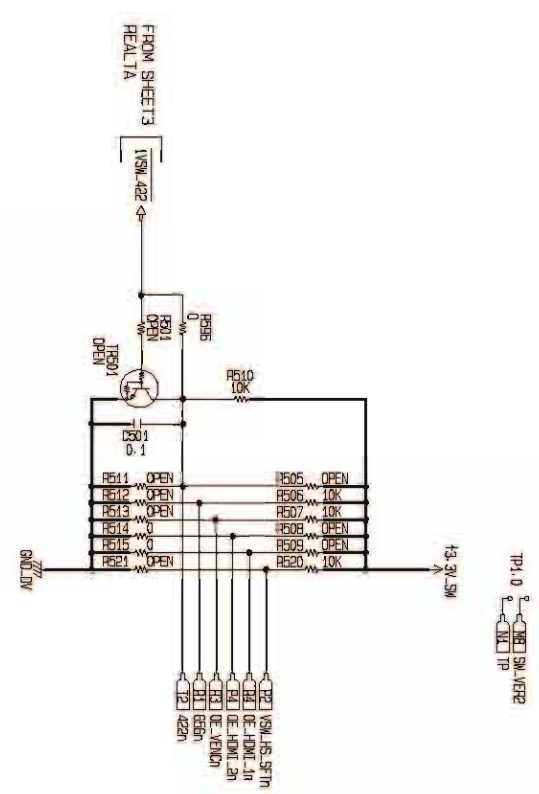
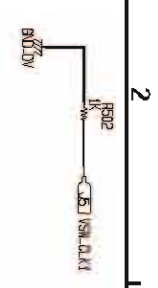

A	B	C	D	E	F	G	H	I	J	K	L	M	N	P	R	T
1	1	2	3	4	5	6	7	8	9	10	11	12	13	14	15	16
2	17	18	19	20	21	22	23	24	25	26	27	28	29	30	31	32
3	33	34	35	36	37	38	39	40	41	42	43	44	45	46	47	48
4	49	50	51	52	53	54	55	56	57	58	59	60	61	62	63	64
5	65	66	67	68	69	70	71	72	73	74	75	76	77	78	79	80
6	81	82	83	84	85	86	87	88	89	90	91	92	93	94	95	96
7	97	98	99	100	101	102	103	104	105	106	107	108	109	110	111	112
8	113	114	115	116	117	118	119	120	121	122	123	124	125	126	127	128
9	129	130	131	132	133	134	135	136	137	138	139	140	141	142	143	144
10	145	146	147	148	149	150	151	152	153	154	155	156	157	158	159	160
11	161	162	163	164	165	166	167	168	169	170	171	172	173	174	175	176
12	177	178	179	180	181	182	183	184	185	186	187	188	189	190	191	192
13	193	194	195	196	197	198	199	200	201	202	203	204	205	206	207	208
14	209	210	211	212	213	214	215	216	217	218	219	220	221	222	223	224
15	225	226	227	228	229	230	231	232	233	234	235	236	237	238	239	240
16	241	242	243	244	245	246	247	248	249	250	251	252	253	254	255	256

IC50 1
EPM570F256CSN

BU-310002
V1 VIDEO SWITCHER

- HDMI VIDEO OUTPUT SIGNAL LINE
- HDMI1 VIDEO OUTPUT SIGNAL LINE
- HDMI2 VIDEO OUTPUT SIGNAL LINE

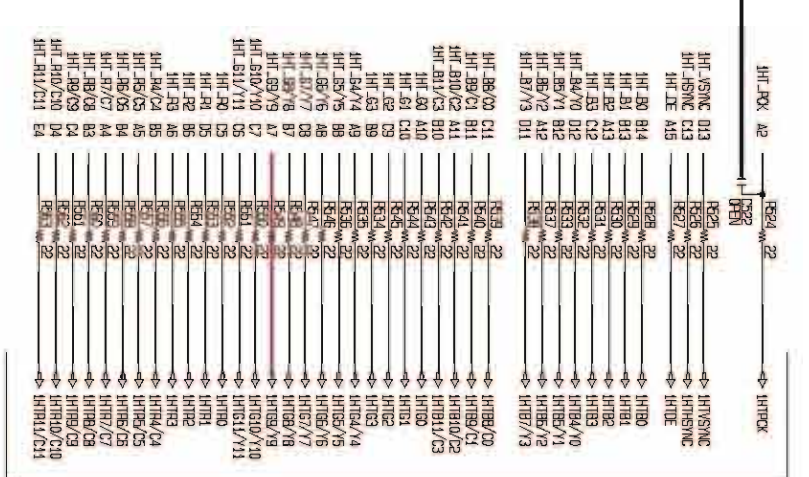
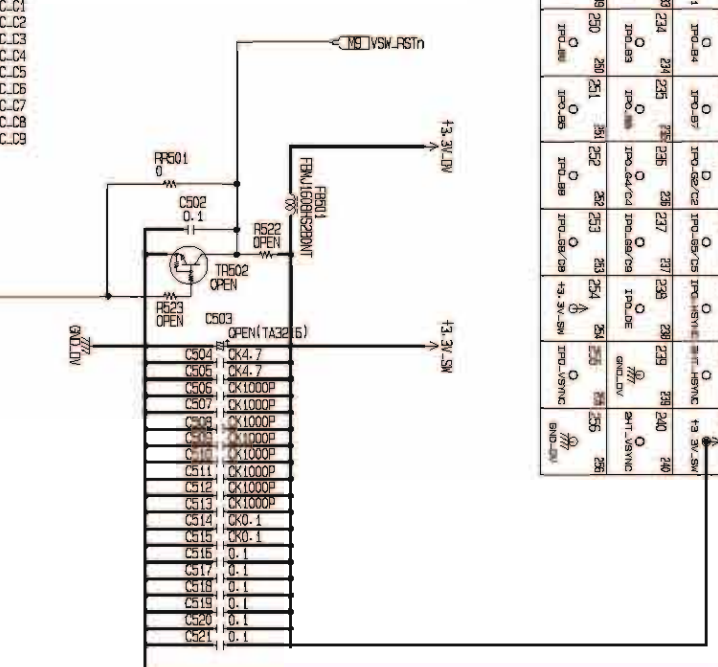
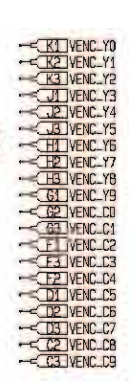

TO HDMI TX1 (SHEET 6)

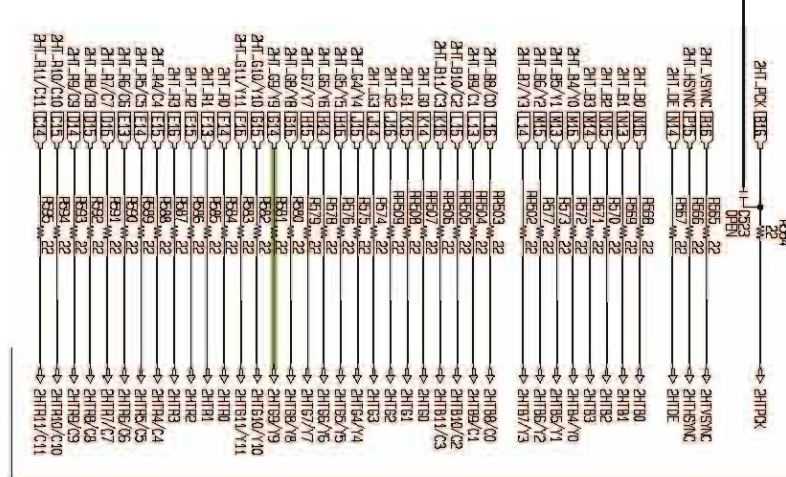

TO HDMI TX2 (SHEET 7)

SCHEMATIC DIAGRAMS (27/44)
BU-310002 VIDEO UNIT (5/14)
V1 VIDEO SWITCHER

FROM/TO HDMI2 (SHEET7)

FROM I/O (SHEET1)

FROM VIDEO SWITCHER (SHEET5)

FROM/TO I/O (SHEET1)

8U-310002
HDMI OUT1

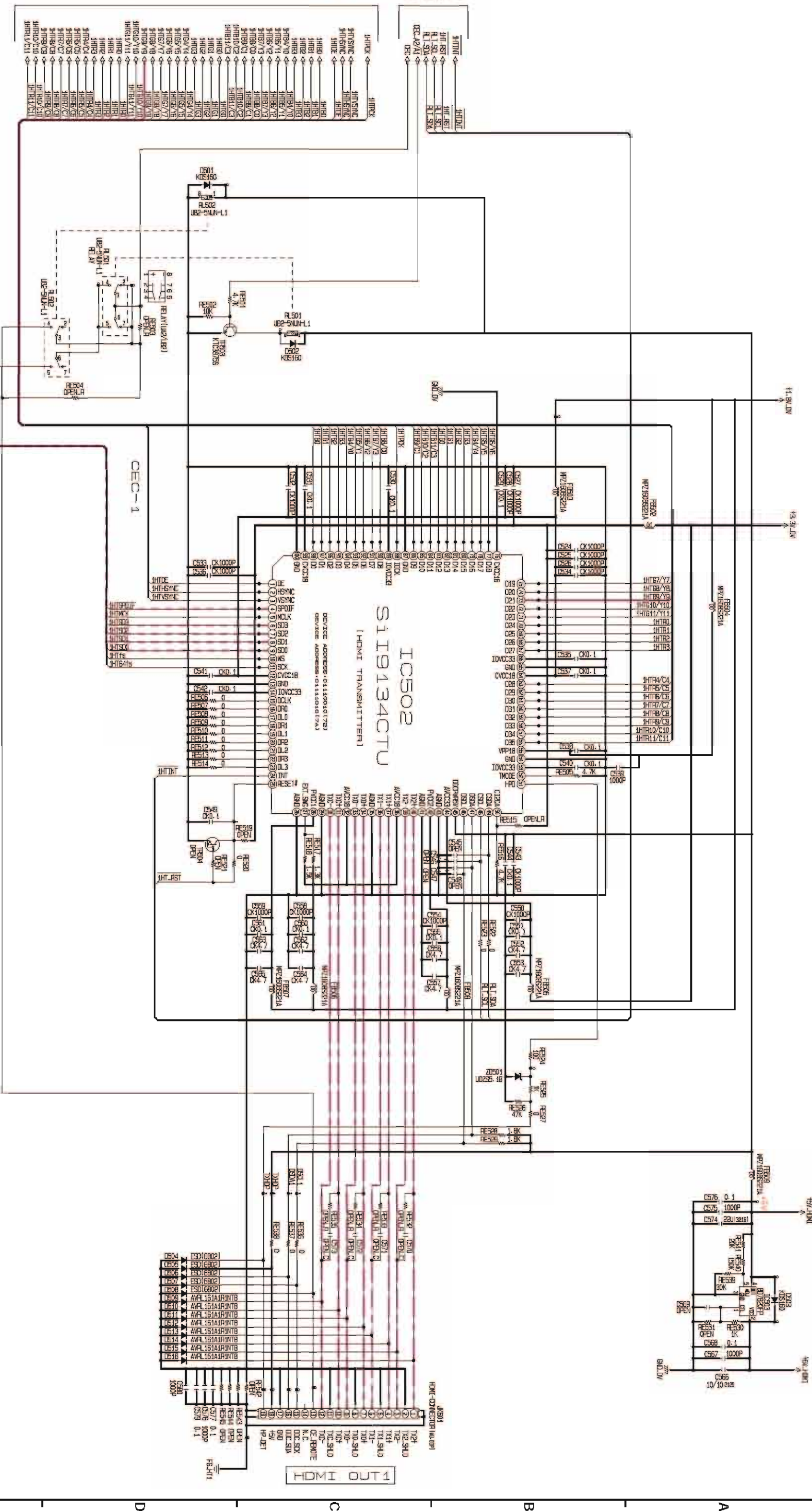

HDMI1 VIDEO OUTPUT SIGNAL LINE
HDMI1 AUDIO OUTPUT SIGNAL LINE
HDMI1 AV OUTPUT SIGNAL LINE
SCHEMATIC DIAGRAMS (28/44)
8U-310002 BIDEO UNIT (6/14)
HDMI OUT 1

UD9004

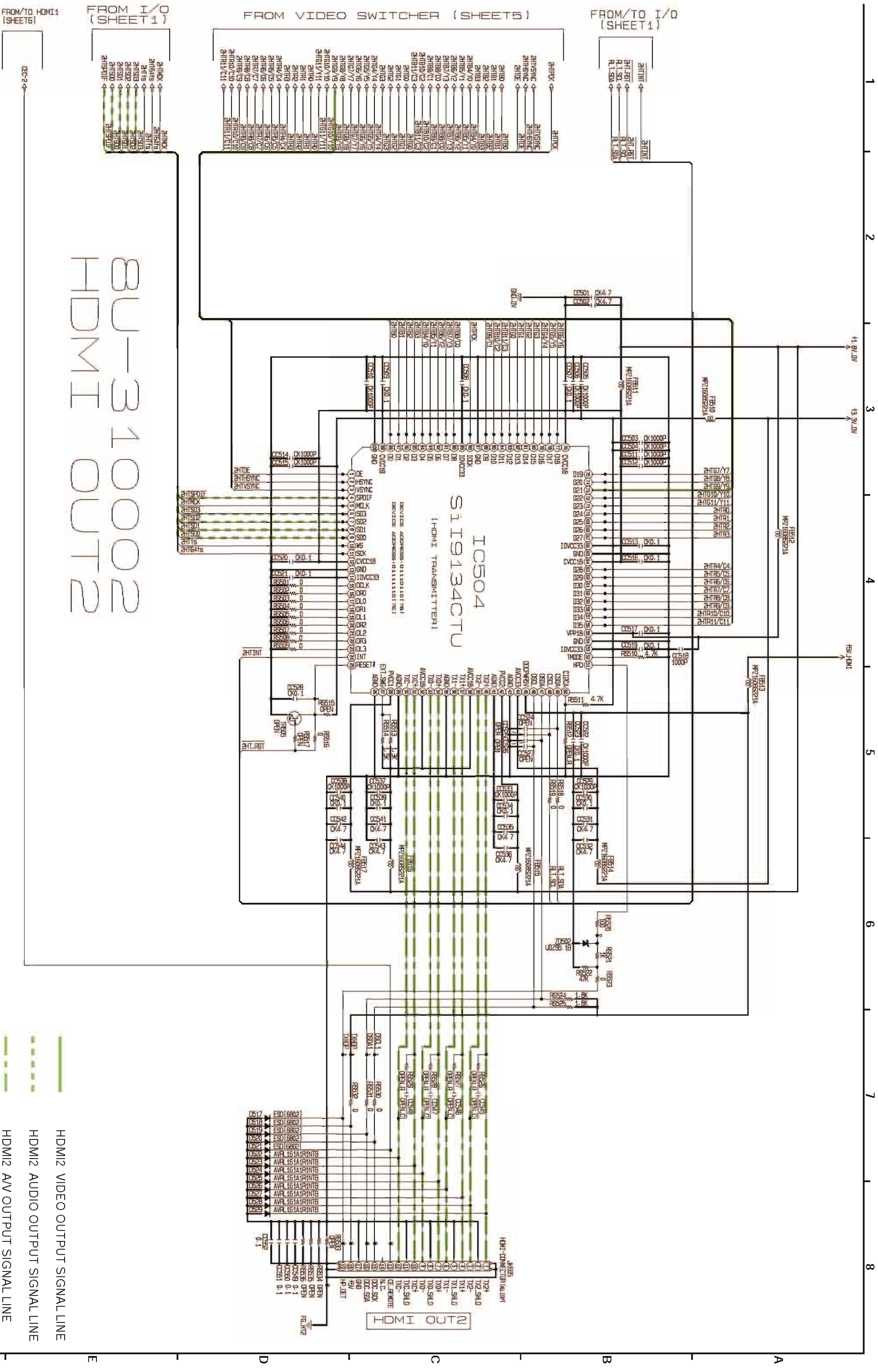

8U-310002 HDMI OUT2

——— HDMI2 VIDEO OUTPUT SIGNAL LINE
- - - - HDMI2 AUDIO OUTPUT SIGNAL LINE
- · - · - HDMI2 AV OUTPUT SIGNAL LINE

SCHEMATIC DIAGRAMS (29/44)
 8U-310002 VIDEO UNIT (7/14)
 HDMI OUT 2

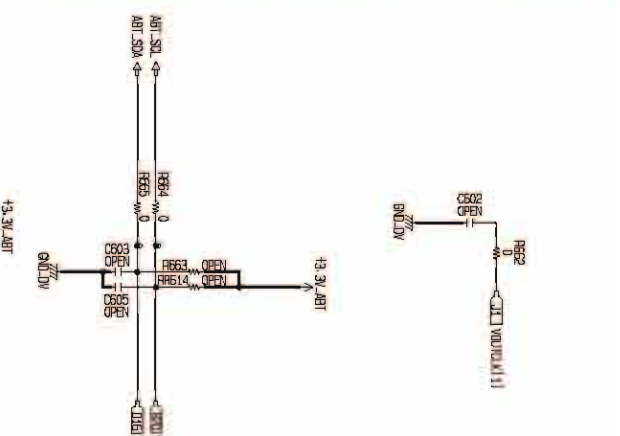
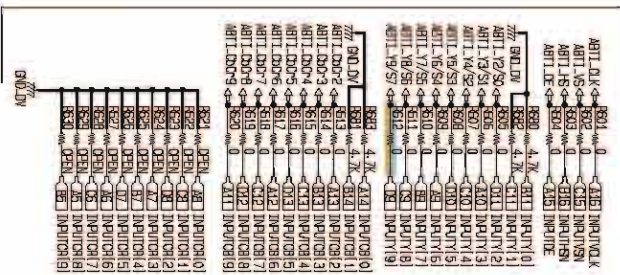

	1	2	3	4	5	6	7	8	9	10	11	12	13	14	15	16	17	18	19	20
A	1	2	3	4	5	6	7	8	9	10	11	12	13	14	15	16	17	18	19	20
B	21	22	23	24	25	26	27	28	29	30	31	32	33	34	35	36	37	38	39	40
C	41	42	43	44	45	46	47	48	49	50	51	52	53	54	55	56	57	58	59	60
D	61	62	63	64	65	66	67	68	69	70	71	72	73	74	75	76	77	78	79	80
E	81	82	83	84	85	86	87	88	89	90	91	92	93	94	95	96	97	98	99	100
F	101	102	103	104	105	106	107	108	109	110	111	112	113	114	115	116	117	118	119	120
G	121	122	123	124	125	126	127	128	129	130	131	132	133	134	135	136	137	138	139	140
H	141	142	143	144	145	146	147	148	149	150	151	152	153	154	155	156	157	158	159	160
I	161	162	163	164	165	166	167	168	169	170	171	172	173	174	175	176	177	178	179	180
J	181	182	183	184	185	186	187	188	189	190	191	192	193	194	195	196	197	198	199	200
K	201	202	203	204	205	206	207	208	209	210	211	212	213	214	215	216	217	218	219	220
L	221	222	223	224	225	226	227	228	229	230	231	232	233	234	235	236	237	238	239	240
M	241	242	243	244	245	246	247	248	249	250	251	252	253	254	255	256	257	258	259	260
N	261	262	263	264	265	266	267	268	269	270	271	272	273	274	275	276	277	278	279	280
P	281	282	283	284	285	286	287	288	289	290	291	292	293	294	295	296	297	298	299	300
Q	301	302	303	304	305	306	307	308	309	310	311	312	313	314	315	316	317	318	319	320
R	321	322	323	324	325	326	327	328	329	330	331	332	333	334	335	336	337	338	339	340
S	341	342	343	344	345	346	347	348	349	350	351	352	353	354	355	356	357	358	359	360
T	361	362	363	364	365	366	367	368	369	370	371	372	373	374	375	376	377	378	379	380
U	381	382	383	384	385	386	387	388	389	390	391	392	393	394	395	396	397	398	399	400
V	401	402	403	404	405	406	407	408	409	410	411	412	413	414	415	416	417	418	419	420
W	421	422	423	424	425	426	427	428	429	430	431	432	433	434	435	436	437	438	439	440
X	441	442	443	444	445	446	447	448	449	450	451	452	453	454	455	456	457	458	459	460
Y	461	462	463	464	465	466	467	468	469	470	471	472	473	474	475	476	477	478	479	480
Z	481	482	483	484	485	486	487	488	489	490	491	492	493	494	495	496	497	498	499	500

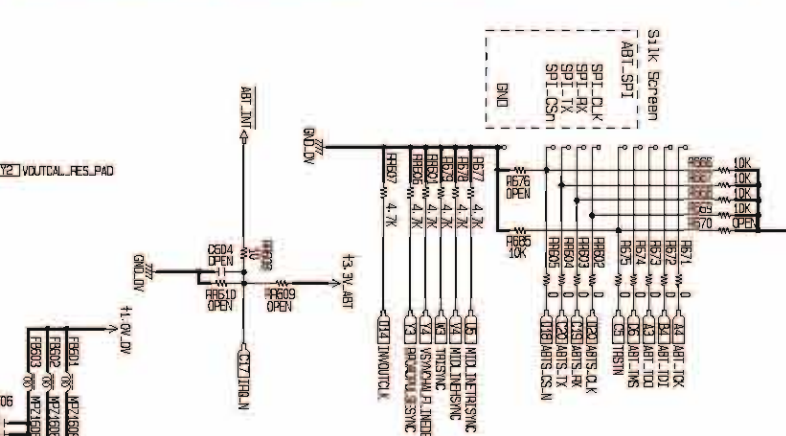
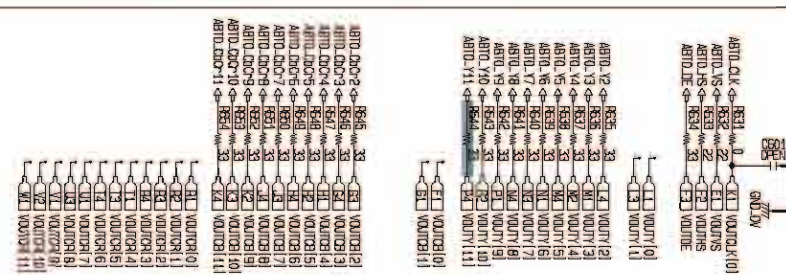

IC601
ABT2010

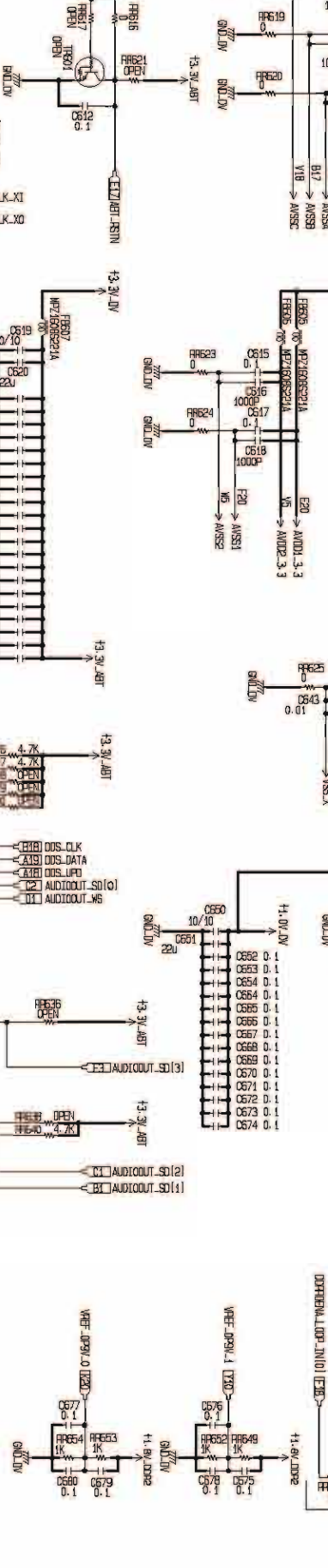
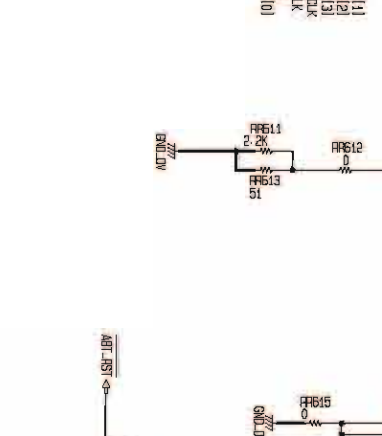
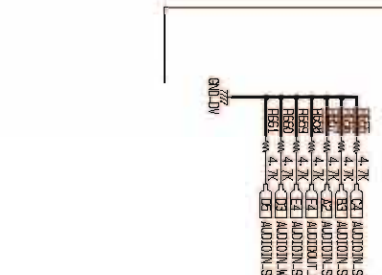

BD PLAY VIDEO OUTPUT SIGNAL LINE
 DVD PLAY VIDEO OUTPUT SIGNAL LINE
 V/C VIDEO OUTPUT SIGNAL LINE
 COMPONENT VIDEO OUTPUT SIGNAL LINE

SCHEMATIC DIAGRAMS (30/44)
 8U-310002 VIDEO UNIT (8/14)
 I/P & SCALAEER for Analog Component

UD9004

FROM/TO DDR2 (SHEET9)

From Length for DDR Length 0.8 to 1m
 On C.L Length for DDR Length

FILE NAME: bd30002.cir/008.sch

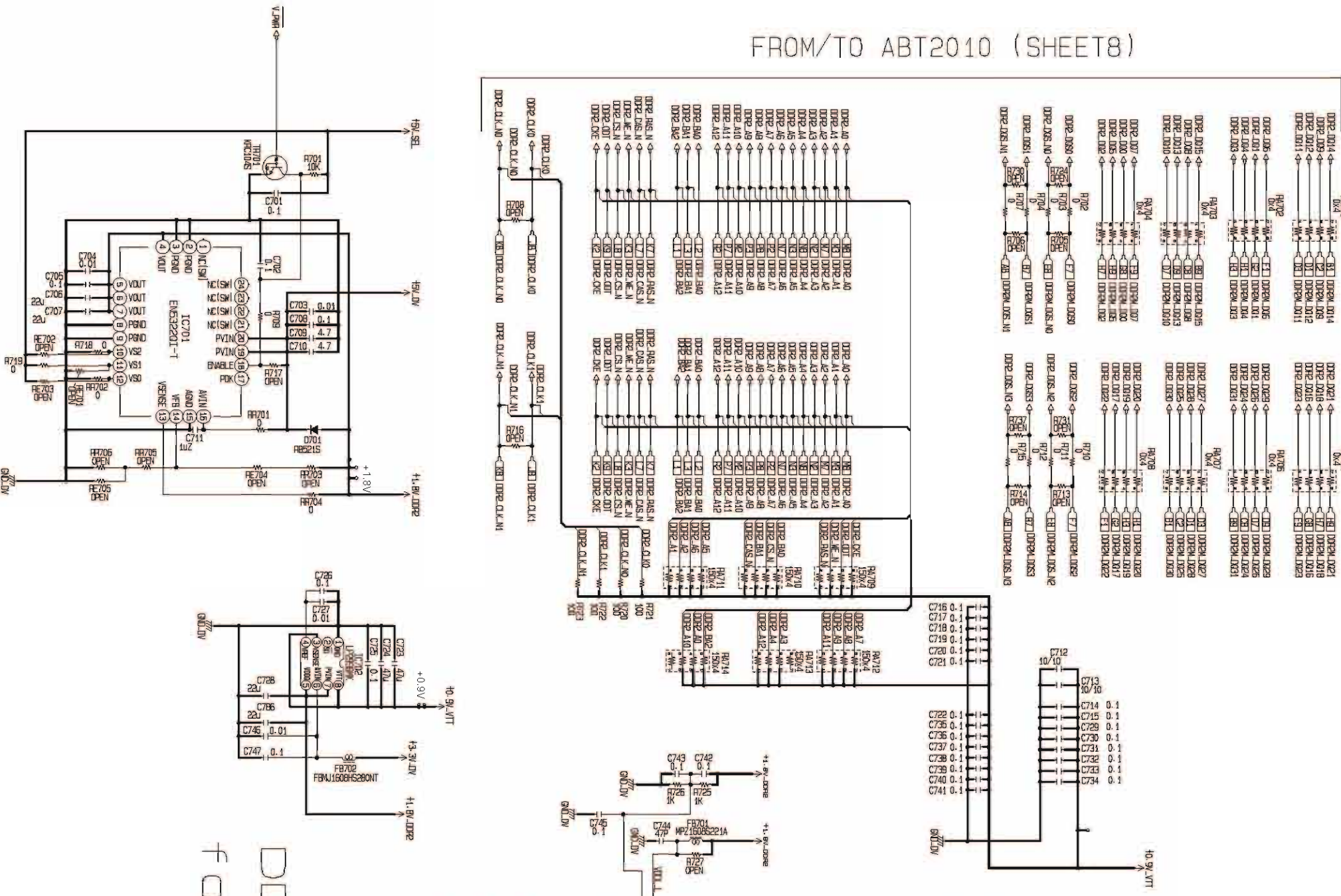

DDR2 X 2
for IC701 ABT2010

IC703
K4T511630G-HCE7

	1	2	3	4	5	6	7	8	9
A	01	02	03	04	05	06	07	08	09
B	10	11	12	13	14	15	16	17	18
C	19	20	21	22	23	24	25	26	27
D	28	29	30	31	32	33	34	35	36
E	37	38	39	40	41	42	43	44	45
F	46	47	48	49	50	51	52	53	54
G	55	56	57	58	59	60	61	62	63
H	64	65	66	67	68	69	70	71	72
I	73	74	75	76	77	78	79	80	81
J	82	83	84	85	86	87	88	89	90
K	91	92	93	94	95	96	97	98	99
L	100	101	102	103	104	105	106	107	108
M	109	110	111	112	113	114	115	116	117
N	118	119	120	121	122	123	124	125	126
P	127	128	129	130	131	132	133	134	135
R	136	137	138	139	140	141	142	143	144

IC704
K4T511630G-HCE7

	1	2	3	4	5	6	7	8	9
A	01	02	03	04	05	06	07	08	09
B	10	11	12	13	14	15	16	17	18
C	19	20	21	22	23	24	25	26	27
D	28	29	30	31	32	33	34	35	36
E	37	38	39	40	41	42	43	44	45
F	46	47	48	49	50	51	52	53	54
G	55	56	57	58	59	60	61	62	63
H	64	65	66	67	68	69	70	71	72
I	73	74	75	76	77	78	79	80	81
J	82	83	84	85	86	87	88	89	90
K	91	92	93	94	95	96	97	98	99
L	100	101	102	103	104	105	106	107	108
M	109	110	111	112	113	114	115	116	117
N	118	119	120	121	122	123	124	125	126
P	127	128	129	130	131	132	133	134	135
R	136	137	138	139	140	141	142	143	144

SCHEMATIC DIAGRAMS (31/44)
8U-310002 VIDEO UNIT (9/14)
DDR2 X 2 for IC701 ABT 2010

8U-310002 VIDEO SIGNAL DIVIDER

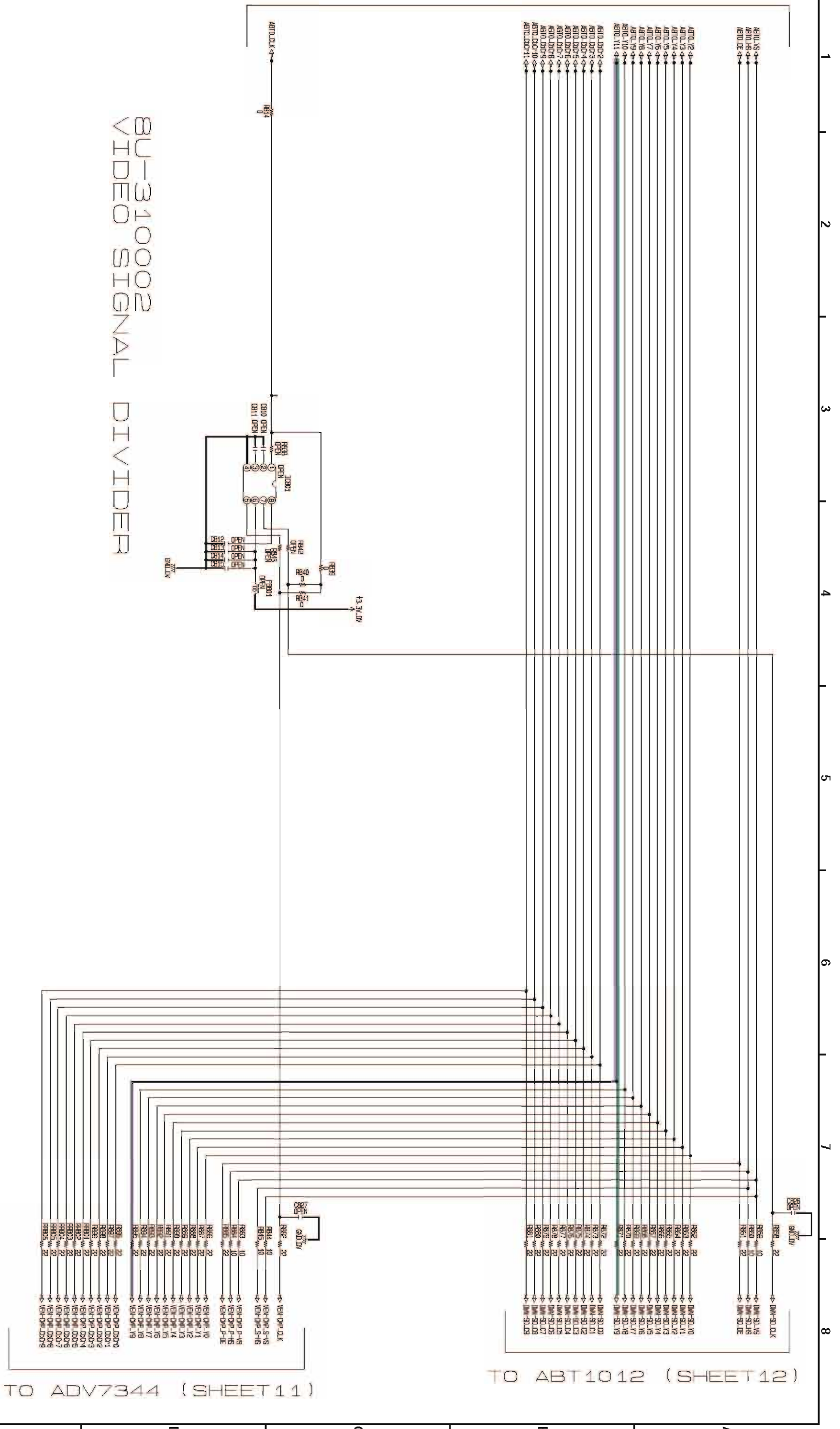

Y/C VIDEO OUTPUT SIGNAL LINE

COMPONENT VIDEO OUTPUT SIGNAL LINE

SCHEMATIC DIAGRAMS (32/44)
8U-310002 VIDEO UNIT (10/14)
VIDEO SIGNAL DIVIDER

UD9004

8U-310002 VIDEO ENCODER for COMPONENT

- COMPONENT VIDEO OUTPUT SIGNAL LINE
- COMPONENT-Y VIDEO OUTPUT SIGNAL LINE
- COMPONENT-Cb VIDEO OUTPUT SIGNAL LINE
- COMPONENT-Cr VIDEO OUTPUT SIGNAL LINE

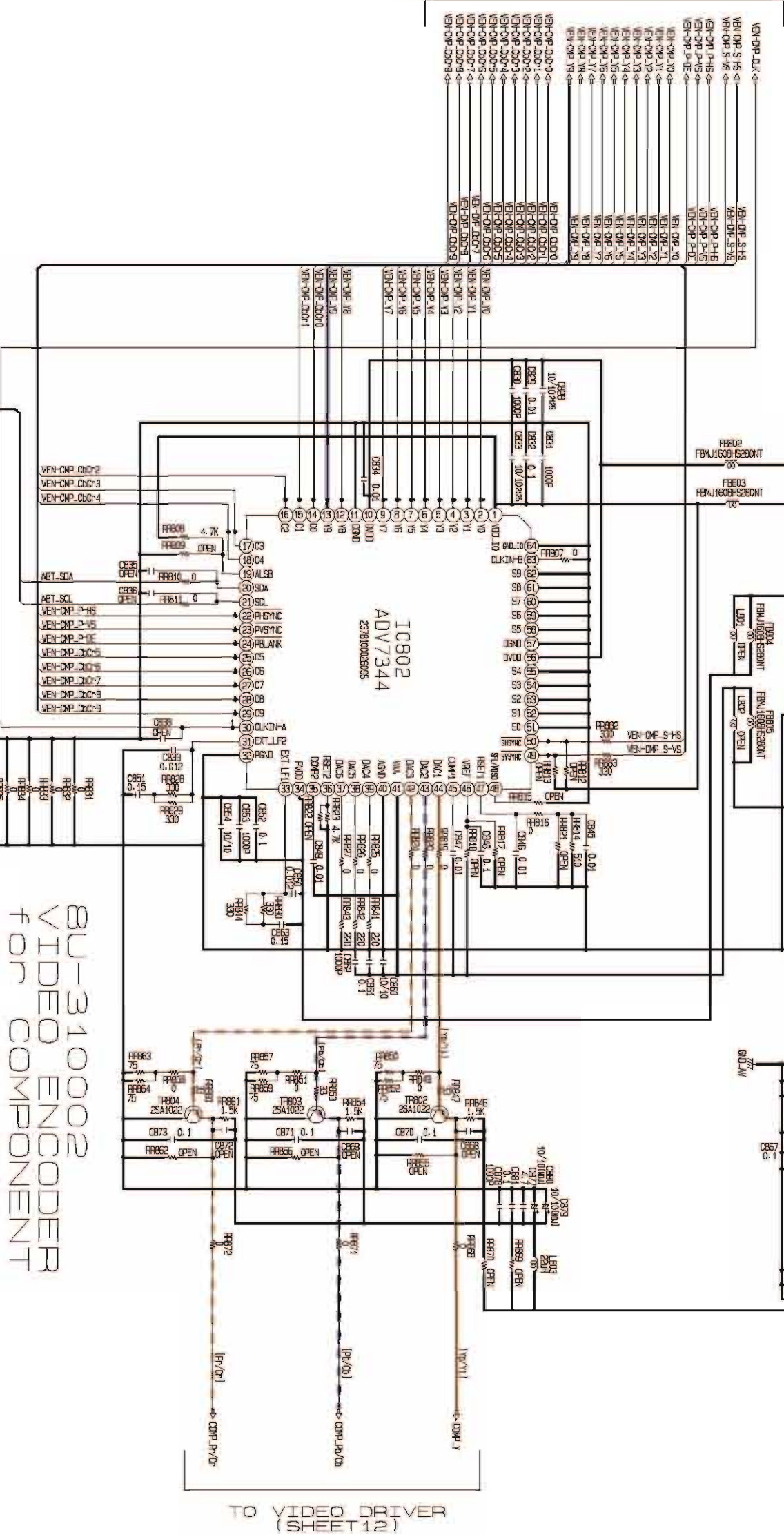

TO VIDEO DRIVER (SHEET 12)

ABT1012 I/P & SCALER for S(Y/C) and CVBS

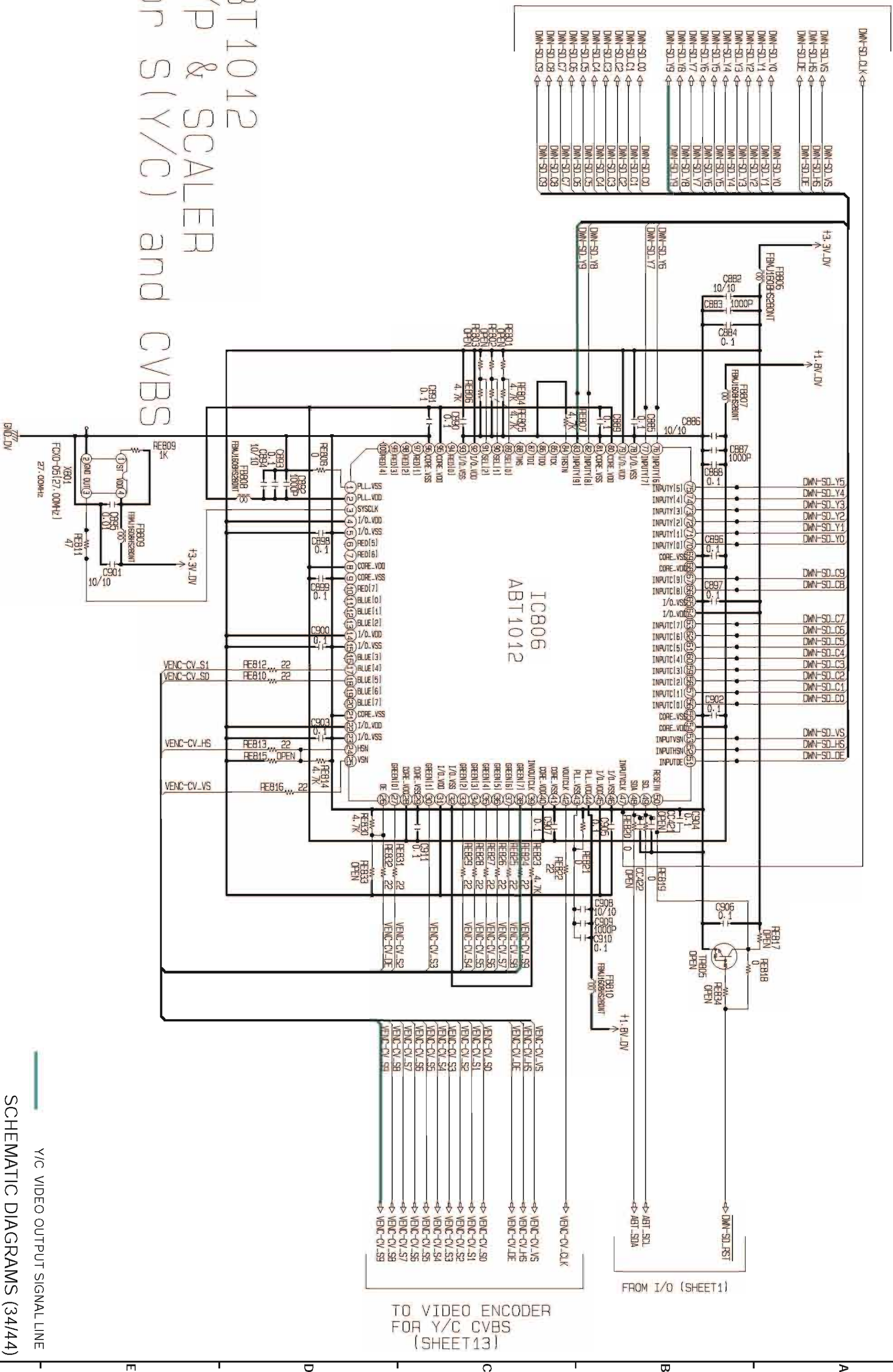

TO VIDEO ENCODER
FOR Y/C CVBS
(SHEET 13)

FROM I/O (SHEET 1)

Y/C VIDEO OUTPUT SIGNAL LINE

SCHEMATIC DIAGRAMS (34/44)

8U-310002 VIDEO UNIT (12/14)

I/P & SCALER for S(Y/C) & CVBS

UD9004



FROM DATA DISTRIBUTOR (SHEET1)

FROM ABT1012 (SHEET12)

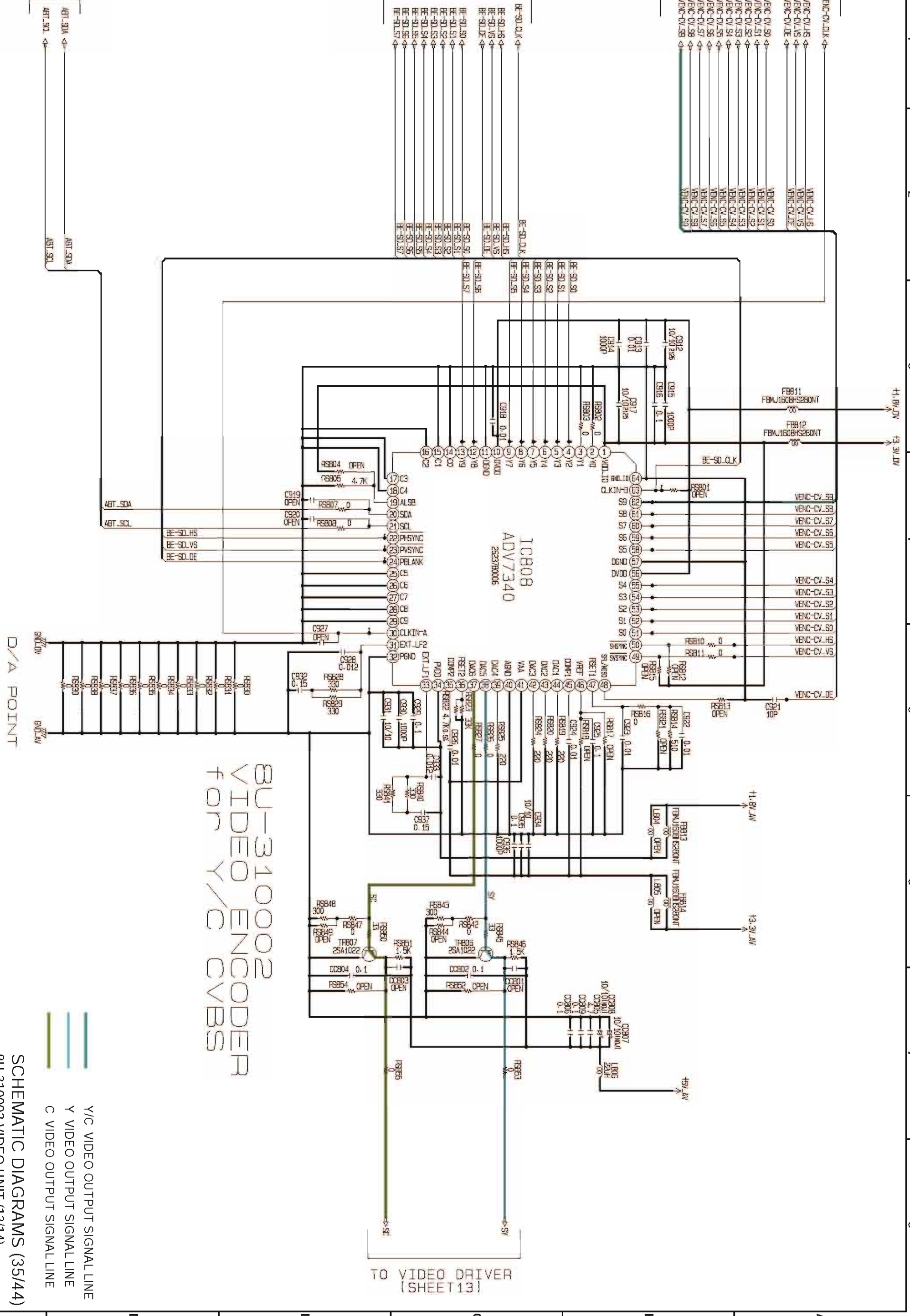
TO I/P (SHEET 1)



BU-310002 VIDEO ENCODER for Y/C CVBS

 Y/C VIDEO OUTPUT SIGNAL LINE
 Y VIDEO OUTPUT SIGNAL LINE
 C VIDEO OUTPUT SIGNAL LINE

SCHEMATIC DIAGRAMS (35/44)
 8U-310002 VIDEO UNIT (13/14)
 VIDEO ENCODER for Y/C CVBS

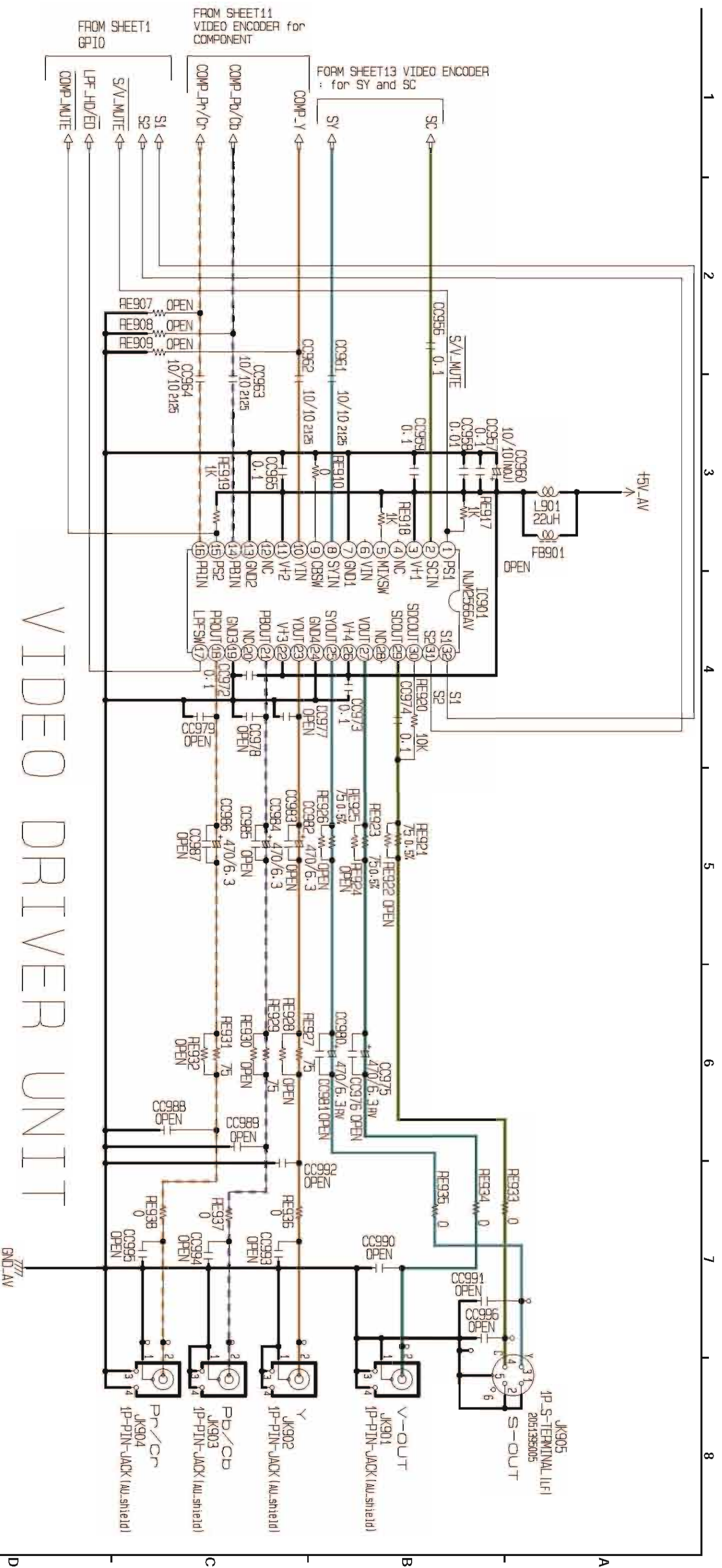

- C VIDEO OUTPUT SIGNAL LINE
- Y VIDEO OUTPUT SIGNAL LINE
- Y/C VIDEO OUTPUT SIGNAL LINE
- COMPONENT-Y VIDEO OUTPUT SIGNAL LINE
- COMPONENT-Cb VIDEO OUTPUT SIGNAL LINE
- - - COMPONENT-Cr VIDEO OUTPUT SIGNAL LINE

SCHEMATIC DIAGRAMS (36/44)
8U-310002 VIDEO UNIT (14/14)
VIDEO DRIVER

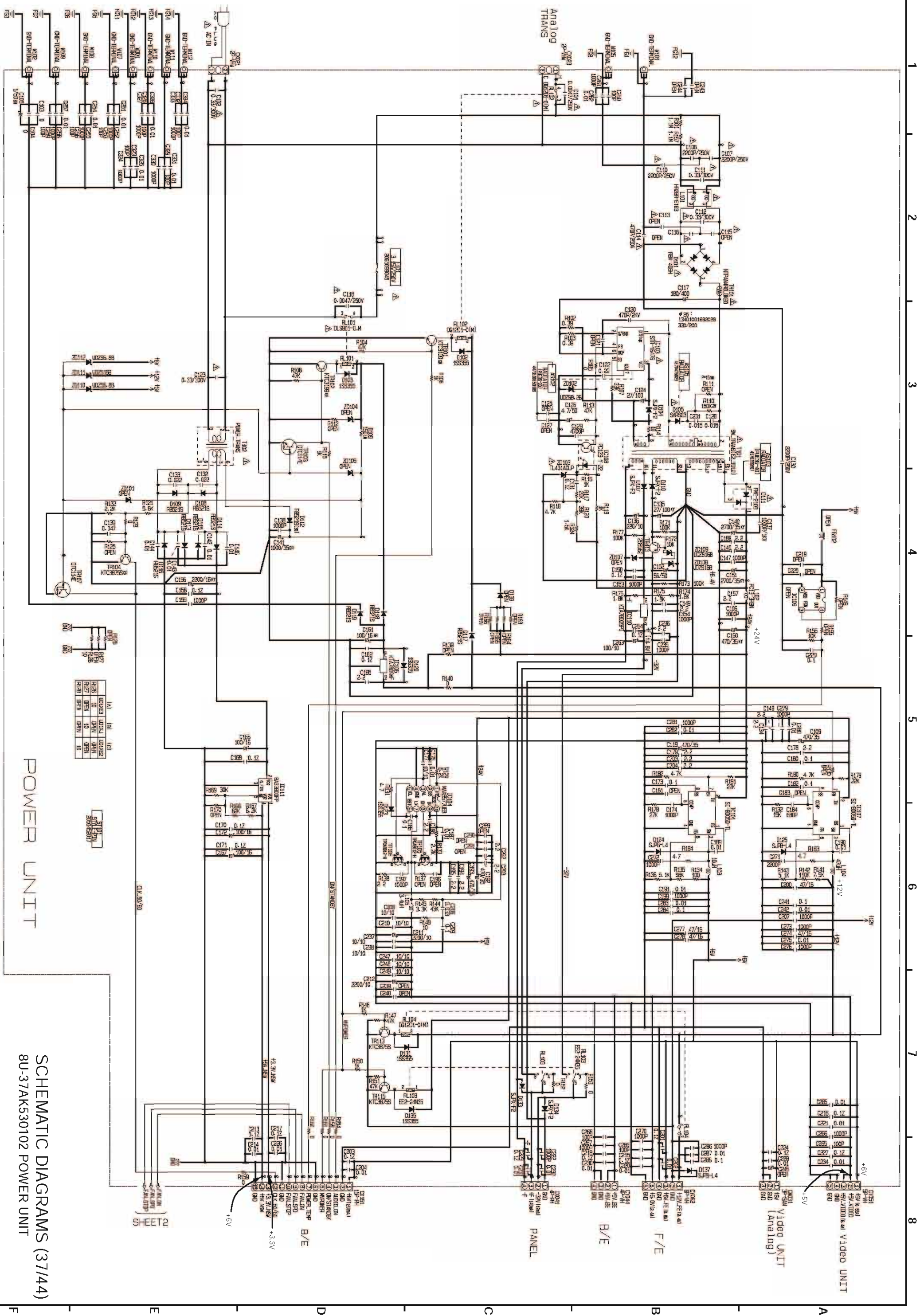

POWER UNIT

SCHEMATIC DIAGRAMS (37/44)
8U-37AK530102 POWER UNIT

FILE NAME: I:\BSPROD\8U-37AK530102.PRT

UD9004

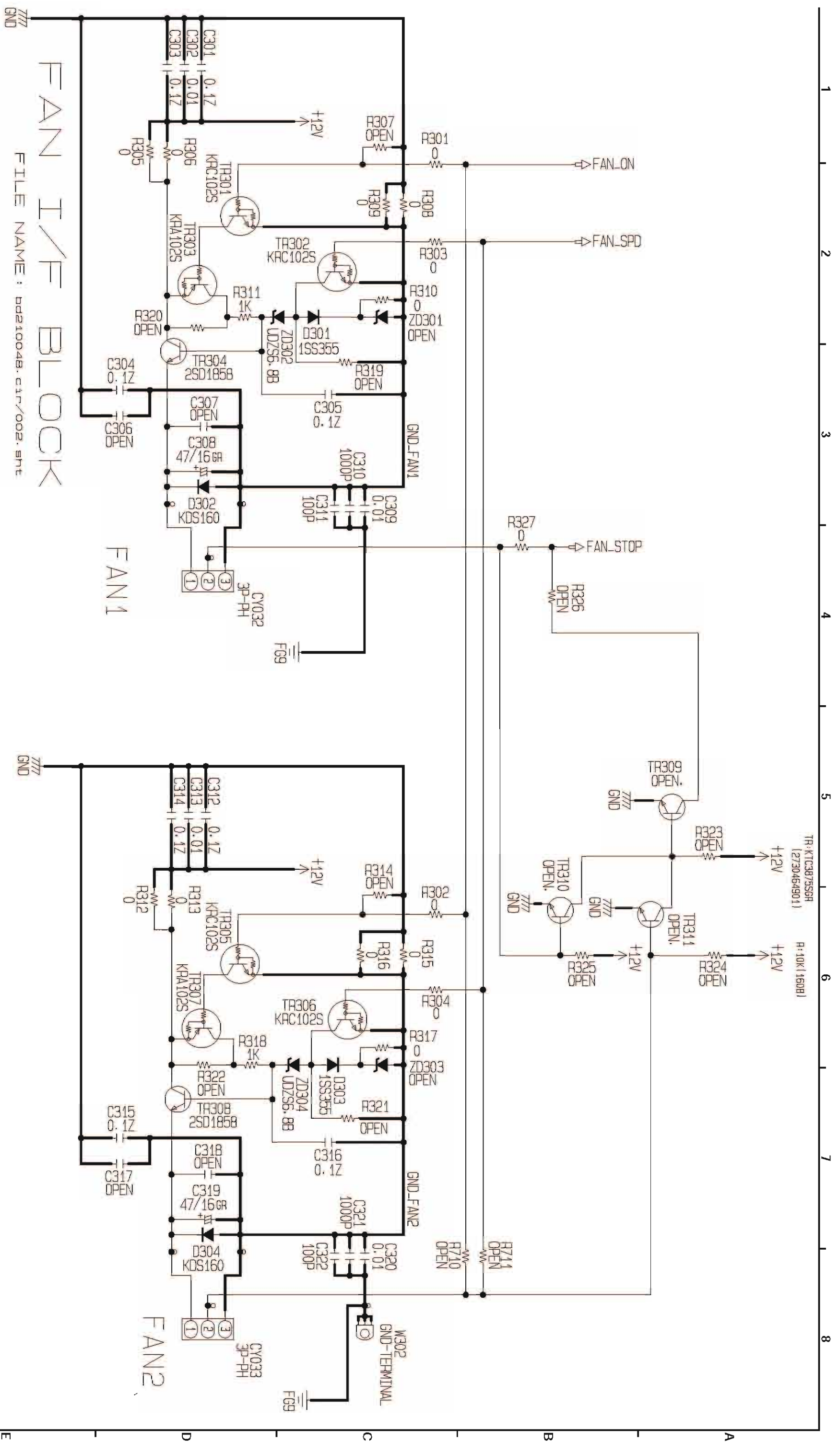

FAN I/F BLOCK

FILE NAME : dd21004B.cir/002.sht

FAN1

FAN2

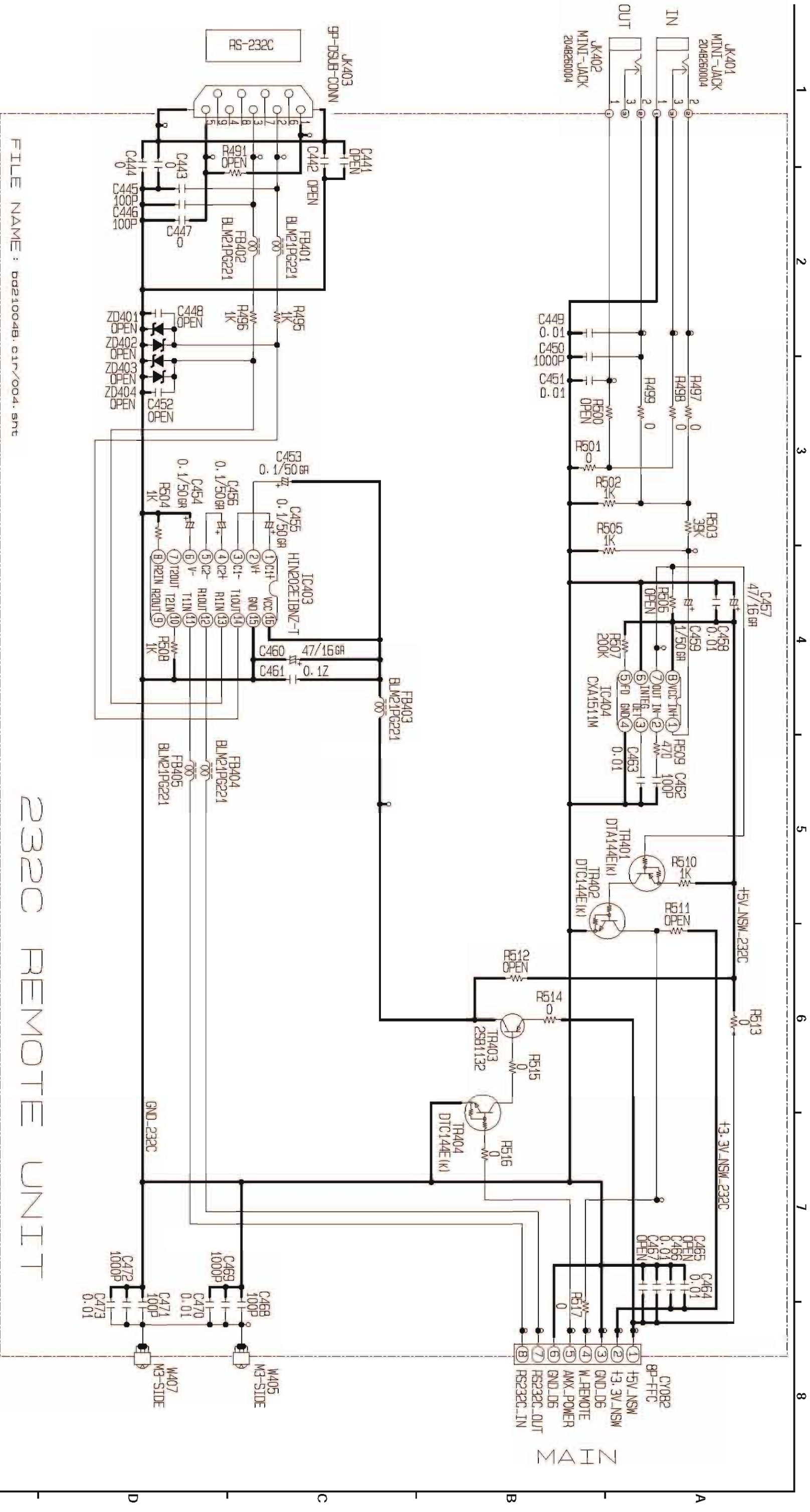

FILE NAME : bd21004B.cbr/004.snt

232C REMOTE UNIT

SCHEMATIC DIAGRAMS (39/44)
 8U-37AK530202 232C REMOTE UNIT

00MMG37AK1020

5102

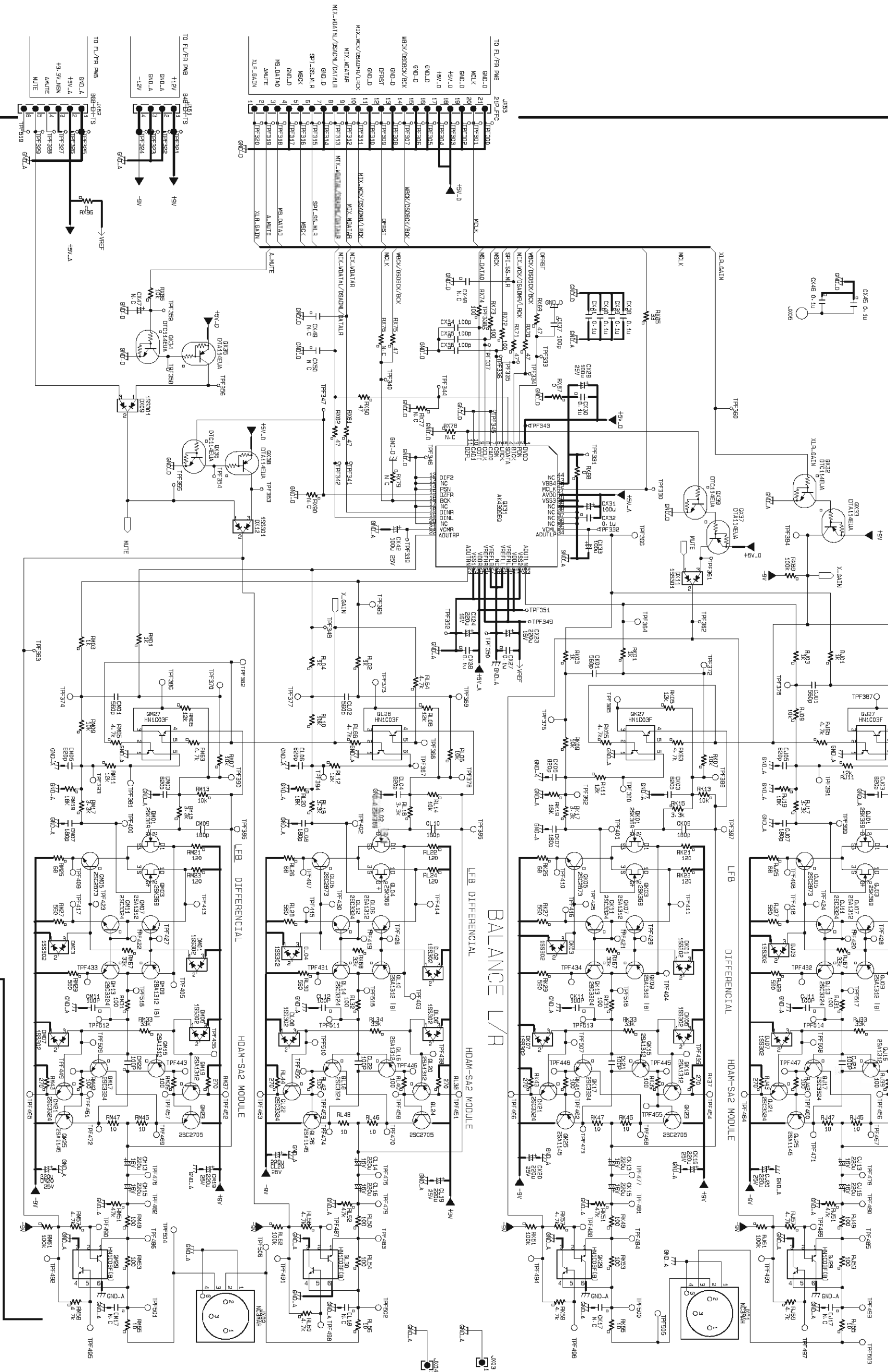

SCHEMATIC DIAGRAMS (41/44)
00MMG37AK1020 AUDIO XLR UNIT

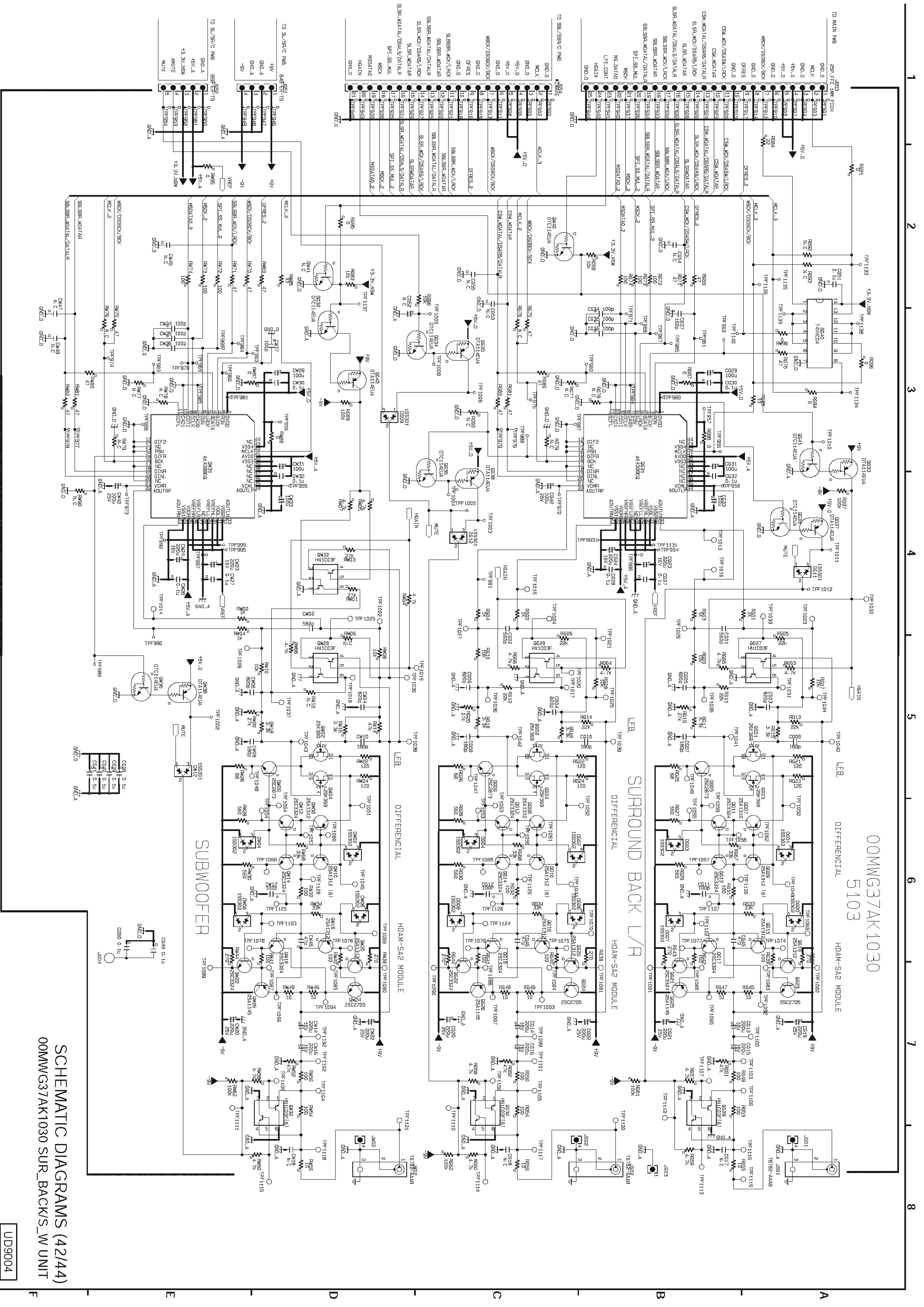

SCHEMATIC DIAGRAMS (42/44)
00MWG37AK1030 SUR- BACKS_ W UNIT

UD9004

00MWG37AK2010 5201 FL-DISPLAY (15-BT-114GNK) DISPLAY/KEY PWB

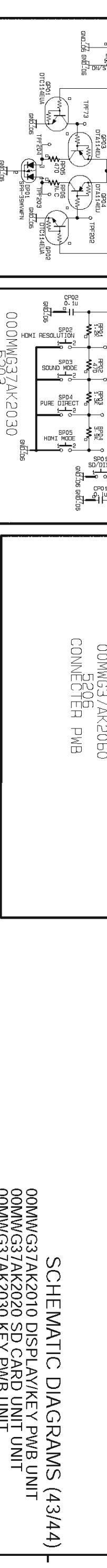
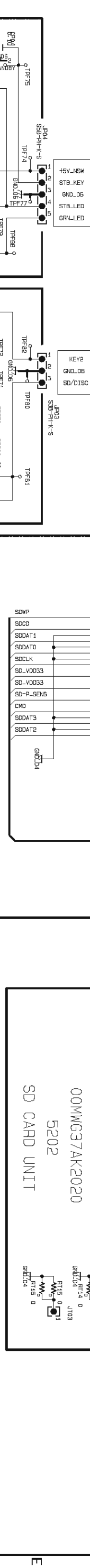
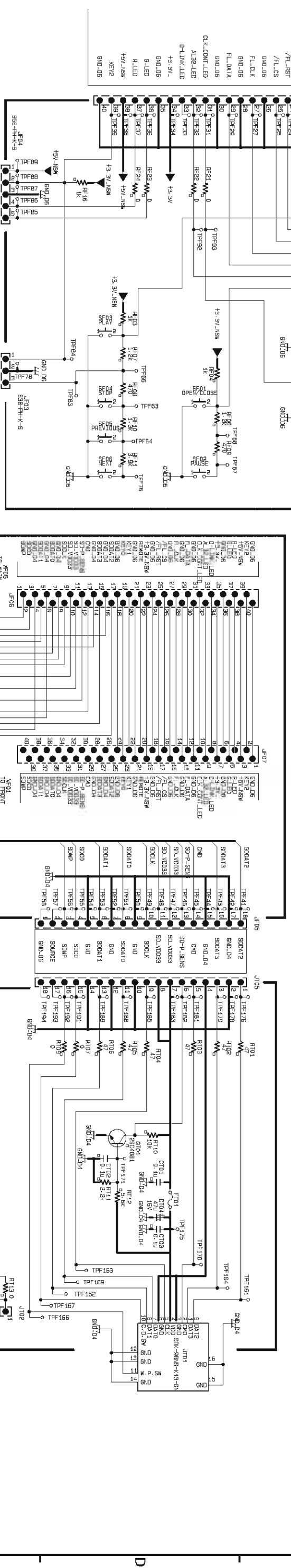
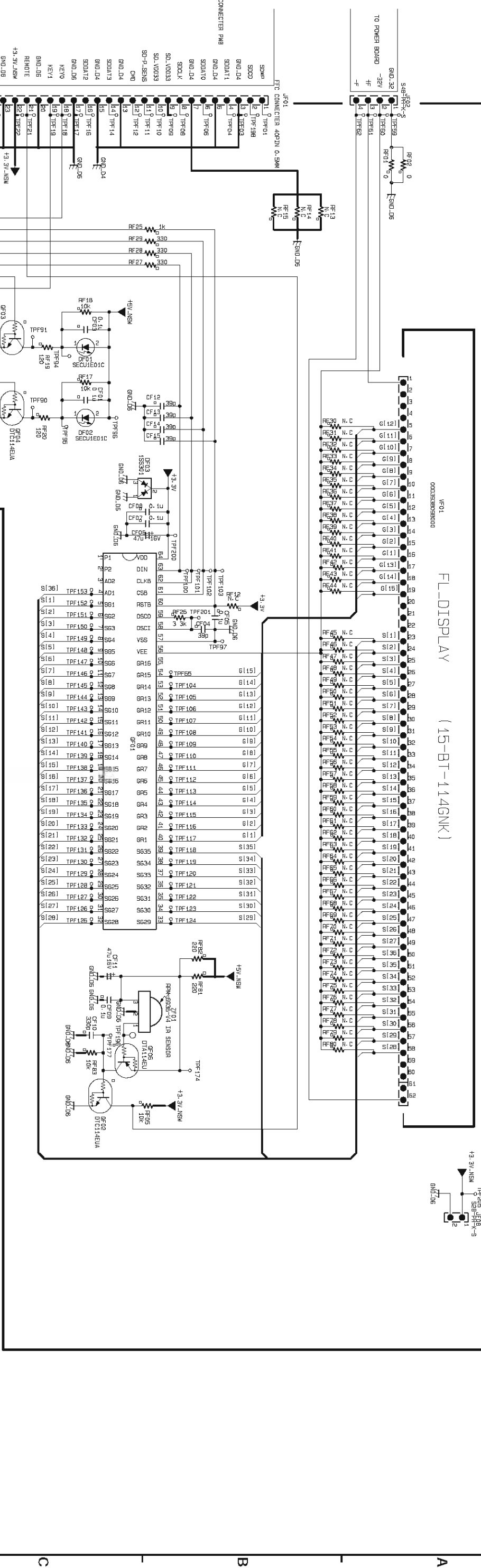

SCHEMATIC DIAGRAMS (4/3/4)

- 00MWG37AK2010 DISPLAY/KEY PWB UNIT
- 00MWG37AK2020 SD CARD UNIT UNIT
- 00MWG37AK2030 KEY PWB UNIT
- 00MWG37AK2040 STANDBY KEY/LED PWB UNIT
- 00MWG37AK2060 CONNECTER PWB UNIT

00MWG37AK2050

5205

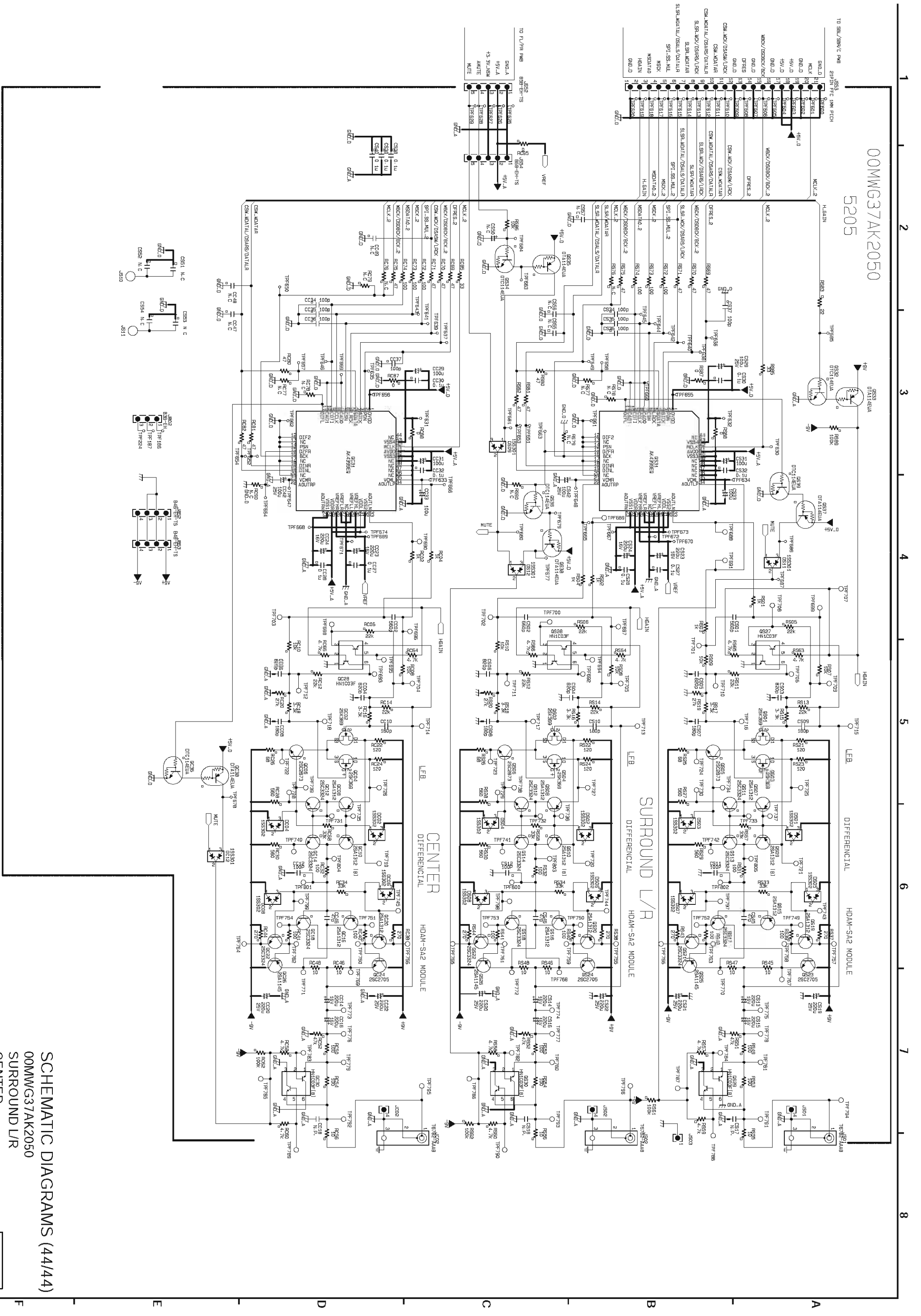

SCHEMATIC DIAGRAMS (4/4/4)

00MWG37AK2050
SURROUND L/R
CENTER

UD9004