

# SERVICE MANUAL

**106/1000S  
PREAMPLIFIER**

**106/1000S  
PREAMPLIFIER**

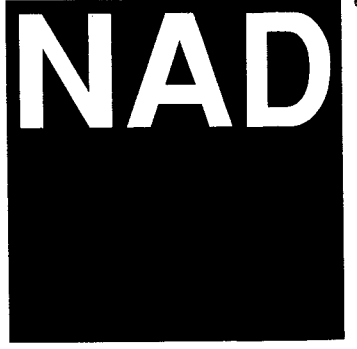

# CONTENTS

DESCRIPTION	PAGE
SPECIFICATIONS.....	3
REAR PANEL /FRONT PANEL VIEW.....	4
BLOCK DIAGRAM.....	5
WIRING DIAGRAM.....	6
DISASSEMBLY INSTRUCTIONS.....	7
TROUBLE SHOOTING GUIDE.....	8
SCHEMATIC DIAGRAM.....	9-10
PCB LAYOUT (PARTS SIDE).....	11-12
EXPLODED VIEW.....	13
EXPLODED VIEW PARTS LIST.....	14
PARTS LIST.....	15-17
PACKING DIAGRAM.....	18
NOTES.....	19

# SPECIFICATIONS

Measured in accordance with EIA Standard RS-490 (IHF T-202).

## PHONO INPUT

Input impedance (R and C)	MM and MC:.....	47K ohm + 200pF
Input sensitivity ref. 0.5V 1KHz	MM:.....	1.5mV
ref. 0.5V,	MC:.....	0.1mV
Input overload	MM:.....	20mV/200mV/1700mV
at 20Hz/1KHz/20KHz	MC:.....	1.3mV/13mV/110mV
Signal/Noise ratio	MM:.....	76dB ref. 5mV
(A-weighted with cartridge connected)	MC:.....	76dB ref. 0.5mV
THD (20Hz-20KHz) and IM dist.....		<0.02%
RIAA accuracy	MM:.....	+/-0.2dB 20Hz-20KHz
	MC:.....	+/-0.2dB 50Hz-20KHz
		.....-0.5dB at 20Hz

## LINE LEVEL INPUTS (CD, Video, Tuner, Tape1, Tape2)

Input impedance (R and C).....	20K ohm + 450pF
Input sensitivity ref. 0.5V.....	80mV
Maximum input signal.....	>10V
Signal/Noise ratio, A-weighted.....	98dB ref. 0.5V
Frequency response (20Hz-20KHz in tone defeat mode).....	+/-0.2dB
THD.....	0.01%

## LINE LEVEL OUTPUTS

Output impedance	Pre-amp.....	220 ohms
	XLR.....	220 ohms
	Tape.....	Source Z + 2K ohms
	Phones.....	120 ohms
Maximum output level	Pre-amp.....	>12V
	XLR.....	>12V
	Tape.....	>10V
	Phones.....	>8V into 600 ohms
		.....>250mV into 8 ohms

## CONTROLS

Treble.....	+/-7dB at 10KHz
Bass.....	+/-10dB at 50Hz

## PHYSICAL SPECIFICATIONS

Dimensions (W x D x H).....	435 x 263 x 81mm
Net Weight.....	3.7Kg (8 lb 1 oz.)
Shipping Weight.....	4.4Kg (9 lb 11 oz.)
Power Consumption.....	17W at 120, 220, or 240 VAC 50/60Hz

# REAR PANEL /FRONT PANEL VIEW

## REAR PANEL

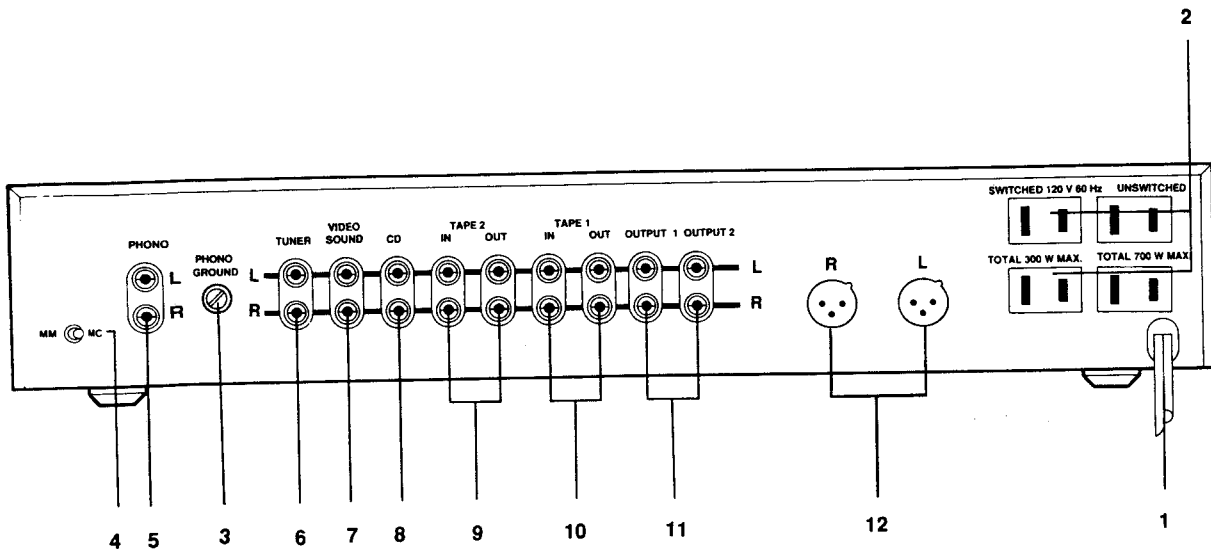

- 1. AC LINE CORD
- 2. AC CONVENIENCE OUTLETS  
(120V model only)
- 3. PHONO GROUND
- 4. MM/MC SELECTOR
- 5. PHONO INPUT
- 6. TUNER INPUT

- 7. VIDEO SOUND INPUT
- 8. CD INPUT
- 9. TAPE 2 INPUT/OUTPUT
- 10. TAPE 1 INPUT/OUTPUT
- 11. PREAMP OUTPUTS
- 12. XLR OUTPUTS

## FRONT PANEL

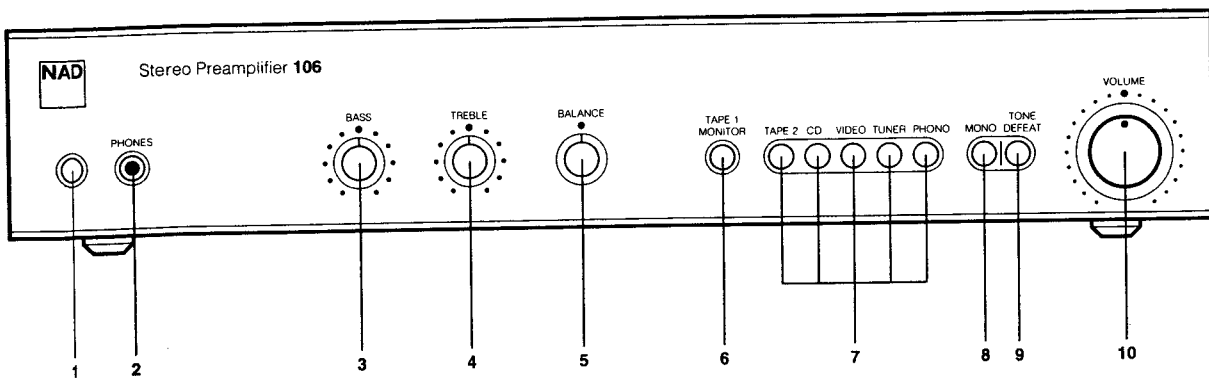

- 1. POWER
- 2. PHONES
- 3. BASS
- 4. TREBLE
- 5. BALANCE
- 6. TAPE 1 MONITOR

- 7. INPUT SELECTOR (TAPE 2, CD, VIDEO  
SOUND, TUNER, PHONO.)
- 8. MONO
- 9. TONE DEFEAT
- 10. VOLUME

# BLOCK DIAGRAM

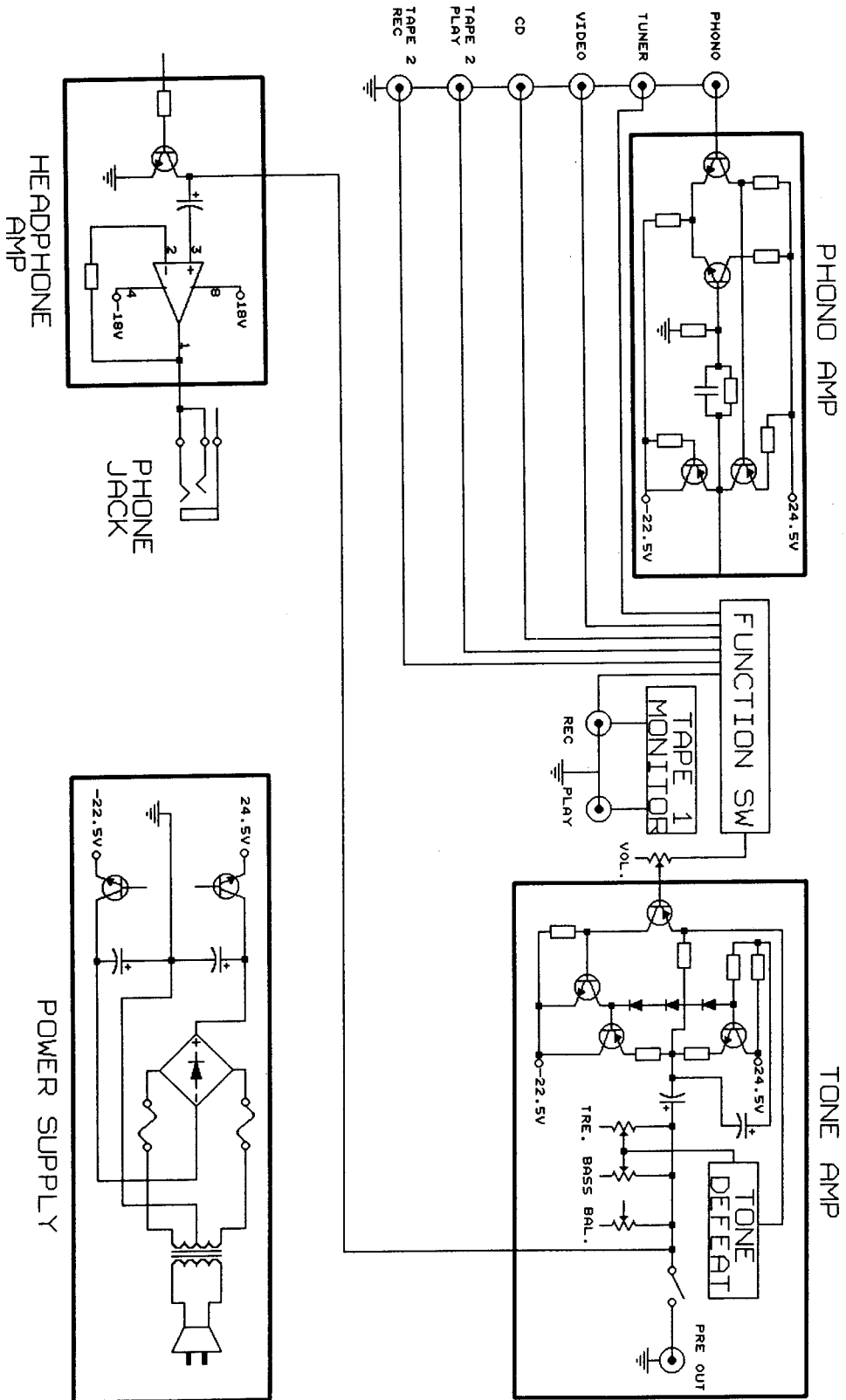

# WIRING DIAGRAM

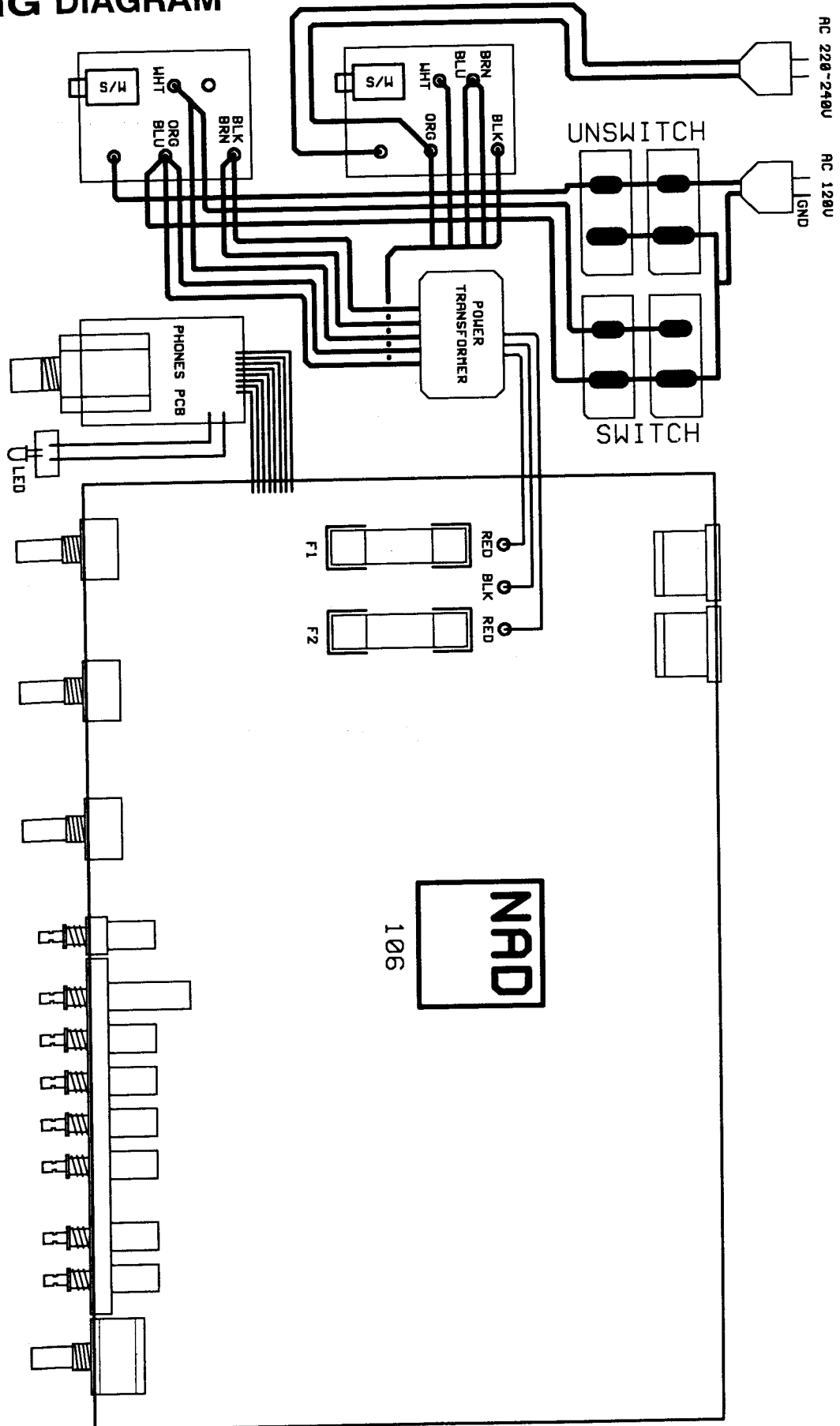



# SCHEMATIC DIAGRAM

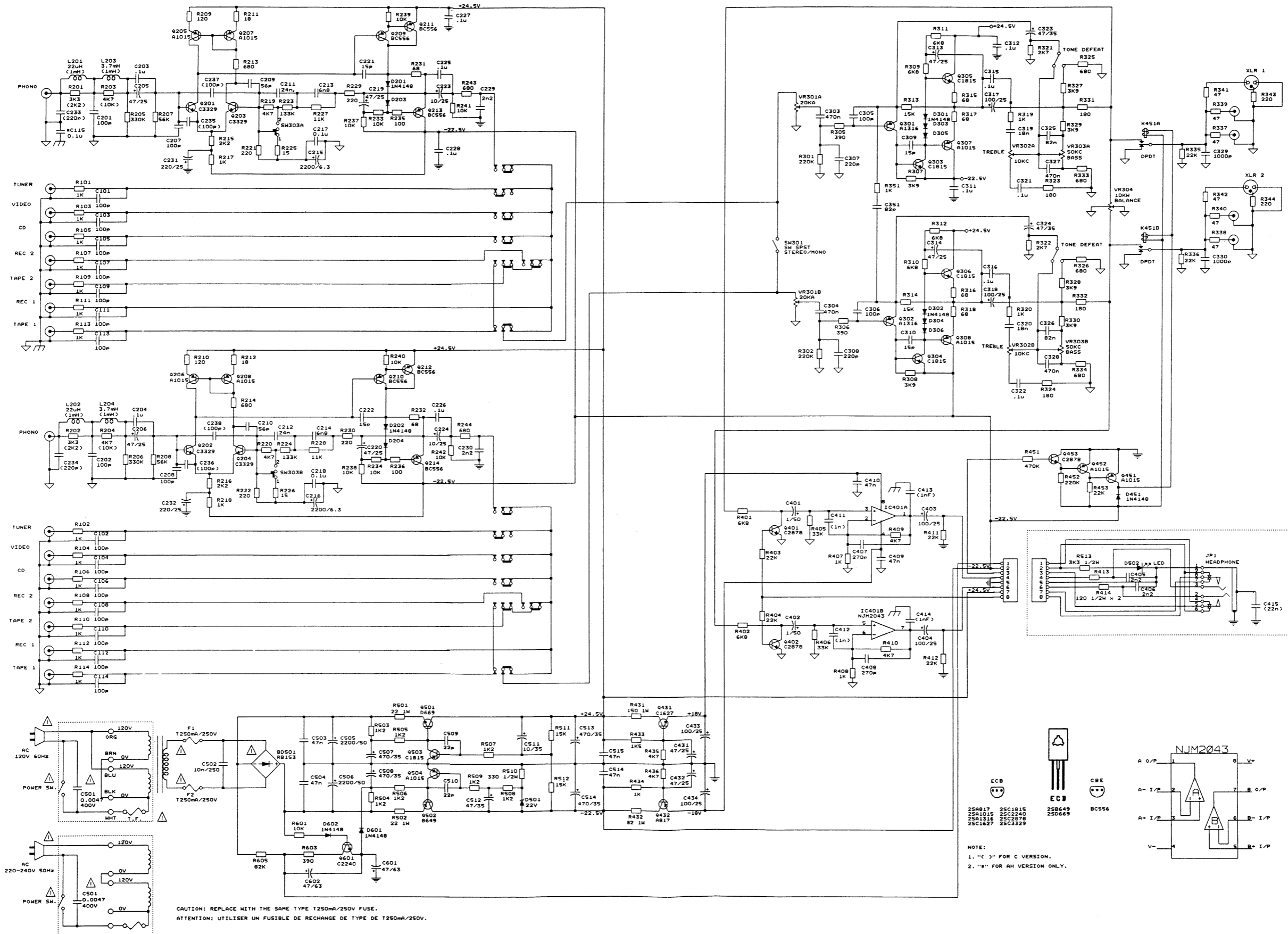



PCB LAYOUT (PARTS SIDE)

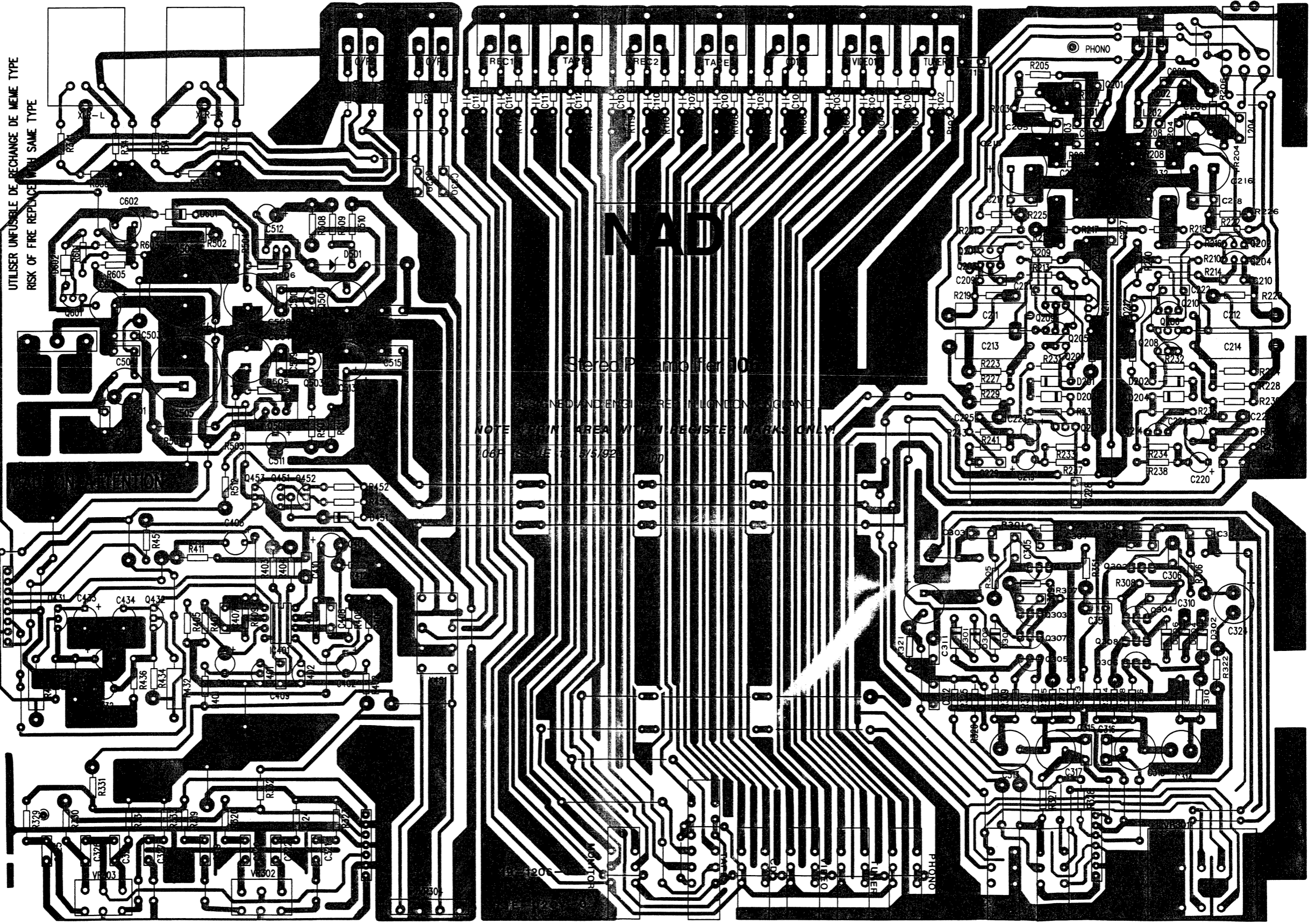
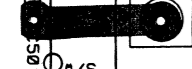
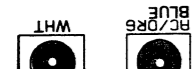
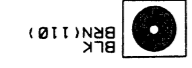
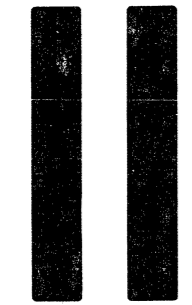
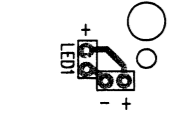
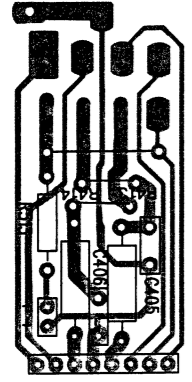

UTILISER UNFUSIBLE DE RECHANGE DE MEME TYPE  
RISK OF FIRE REPLACEMENT WITH SAME TYPE

NAD

Stereo Preamplifier

NOTE: IN AREA WITH REVERSE MARKS ONLY

18-1508 01-083 1.20

# EXPLODED VIEW

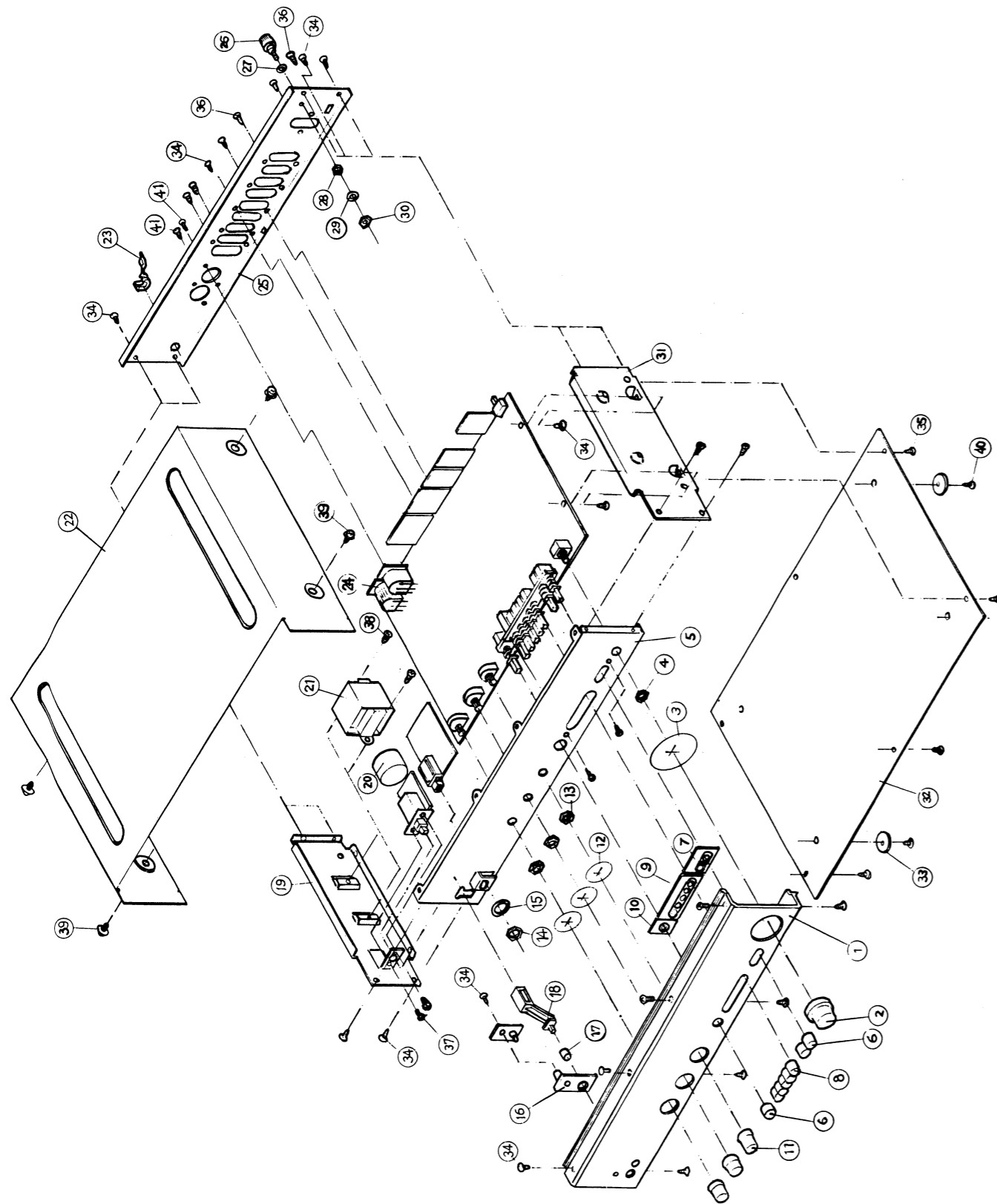

# EXPLODED VIEW PARTS LIST

ITEM	PART NO.	DESCRIPTION	Q'TY
1-A	11-8377-2	FRONT PANEL NAD-106	1
1-B	11-8377-1	FRONT PANEL NAD-1000S	1
2	12-3113	KNOB VOLUME	1
3	12-9003	FELT RING 50 x 0.5mm	1
4	29-4162-N	NUT, POT	1
5	11-6116	FRONT CHASSIS	1
6	12-3110	BUTTON BLACK MONO,TONE DEF, MONITOR	3
7	13-8221-3	BEZEL 2 HOLE	1
8	12-3110	BUTTON BLACK	5
9	13-8224	BEZEL 5 HOLE	1
10	13-8221-2	BEZEL 1 HOLE	1
11	12-3129	KNOB BASS,TREBLE,BALANCE	3
12	12-9002	FELT RING 30 x 0.5mm	3
13	29-4141-N	NUT, POTS	3
14	12-2128G-1	NUT, PHONES	1
15	12-2128G-2	WASHER, PHONES	1
16	13-8221-1	BEZEL POWER	1
17	12-3148	BUTTON GREEN	1
18	12-1083	POWER LINK	1
19	11-6117	FRAME L	1
20	12-7103	TUBE/SVGS-UL	1
21	29-2132	TRANSFORMER	1
22	50-1034	TOP COVER	1
23	14-5003	BUSHINGS	1
24	12-1000S	XLR MALE CHASSIS	2
25-A*US/CN	11-8378-7	REAR PANEL US CN/120V NAD-106	1
25-A*WG/EU/SA	11-8378-8	REAR PANEL WG,EU,SA/220-240V NAD-106	1
25-B*US/CN	11-8378-4	REAR PANEL US CN/120V NAD-1000S	1
25-B*WG/EU/SA	11-8378-5	REAR PANEL WG,EU,SA/220-240V NAD-1000S	1
26-1	15-2037	GND BOLT	1
26-2	15-2037-1	GND NUT	1
27	15-2037-3	STOP WASHER	1
28	15-2037-5	GEAR WASHER	1
29	15-2037-4	CONNECT WASHER	1
30	15-2037-2	BOLT NUT M3.5	1
31	11-6118	FRAME R	1
32	11-6119	COVER BOTTOM	1
33	28-1044	A562 RUBBER-FOOT	4
34	S2B03+I06SL	TAPPING SCREW T3x6 BLK	21
35	S2B03+I06SZ	TAPPING SCREW T3x6 COLOR	6
36	S6B03+I08SL	TAPPING SCREW T3x8 BLACK	5
37	S1B03+I06SL	MACHINE SCREW M3x6 BLK	4
38	S1K04+I06SL	TAPPING SCREW T4x6 W/W BLK	2
39	S1K04+I06SL	TAPPING SCREW T4x6 W/W BLK	4
40	S1B04+I08SL	MACHINE SCREW M4x8 BLK	4
41	S1B03+I08SL	MACHINE SCREW M3x8 BLK	4

# PARTS LIST

## NAD-106 PARTS LIST

LOCATION	REF. NO.	PARTS NO.	DESCRIPTION	Q'TY
SELECT-CKT		(19-1206-1)	NAD-106	1
1000S PCB		(19-1206)	FR4	1
TU, TV, TA2(O), TA1(1)	12-2092G	12-2092G	RCA JACK, 4P/G GOLD PLATE	3
TA1(O), O/P(1,2)	12-2093G	12-2093G	RCA JACK, 6P/G GOLD PLATE	1
RESISTORS				
R101-R114	16-1/4MA102F	16-1/4MA102F	RES. M.F., 1K, 1/4W, +/-1%	14
CAPACITORS				
C115 * AH	17-5DR104M	17-5DR104M	CAP. M.CER. 0.1uF/50V, +/-20%	1
C101-C114	17-5SR101J	17-5SR101J	CAP. E.P.S., 100pF/50V, +/-5%	14
SWITCHES				
tone DEFEAT & MONO	31-1209	31-1209	SW-SEL SPUN21K006-EK	1
PH/TU/VI/CD/TA2	31-1210	31-1210	SW-SEL SPUN51K004-EK	1
SW301	31-1211	31-1211	SW-PUSH SPUN12K801-EK MONITOR	1
PHONO CKT		(19-1206-2)	NAD-106	1
PHONO	12-2123-1	12-2123-1	RCA JACK, 2P/G GOLD PLATE	1
RESISTORS				
R235, R236	16-1/4MA101F	16-1/4MA101F	RES. M.F., 100, 1/4W, +/-1%	2
R217, R218	16-1/4MA102F	16-1/4MA102F	RES. M.F., 1K, 1/4W, +/-1%	2
R233, R234, R237-242	16-1/4MA103F	16-1/4MA103F	RES. M.F., 10K, 1/4W, +/-1%	8
R227, R228	16-1/4MA113F	16-1/4MA113F	RES. M.F., 11K, 1/4W, +/-1%	2
R209, R210	16-1/4MA121F	16-1/4MA121F	RES. M.F., 120, 1/4W, +/-1%	2
R223, R224	16-1/4MA1333F	16-1/4MA1333F	RES. M.F., 133K, 1/4W, +/-1%	2
R225, R226	16-1/4MA150F	16-1/4MA150F	RES. M.F., 15, 1/4W, +/-1%	2
R212, R211	16-1/4MA180F	16-1/4MA180F	RES. M.F., 18, 1/4W, +/-1%	2
R221, R222, R229, R230	16-1/4MA221F	16-1/4MA221F	RES. M.F., 220, 1/4W, +/-1%	4
R215, R216	16-1/4MA222F	16-1/4MA222F	RES. M.F., 2K2, 1/4W, +/-1%	2
R201, R202 * AH	16-1/4MA332F	16-1/4MA332F	RES. M.F., 3K3, 1/4W, +/-1%	2
R201, R202 * C	16-1/4MA222F	16-1/4MA222F	RES. M.F., 2K2, 1/4W, +/-1%	2
R205, R206	16-1/4MA334F	16-1/4MA334F	RES. M.F., 330K, 1/4W, +/-1%	2
R203, R204 * AH	16-1/4MA472F	16-1/4MA472F	RES. M.F., 4K7, 1/4W, +/-1%	2
R203, R204 * C	16-1/4MA103F	16-1/4MA103F	RES. M.F., 10K, 1/4W, +/-1%	2
R219, R220	16-1/4MA472F	16-1/4MA472F	RES. M.F., 4K7, 1/4W, +/-1%	2
R207, R208	16-1/4MA563F	16-1/4MA563F	RES. M.F., 56K, 1/4W, +/-1%	2
R231, R232	16-1/4MA680F	16-1/4MA680F	RES. M.F., 68, 1/4W, +/-1%	2
R213, R214, R243, R244	16-1/4MA681F	16-1/4MA681F	RES. M.F., 680, 1/4W, +/-1%	4
CAPACITORS				
C215, C216	17-0.63ER228M	17-0.63ER228M	CAP. ELE., 220uF/6V3, +/-20%	2
C223, C224	17-2.5ER106M	17-2.5ER106M	CAP. ELE., 10uF/25V, +/-20%	2
C231, C232	17-2.5ER227M	17-2.5ER227M	CAP. ELE., 220uF/25V, +/-20%	2
C205, C206, C219, C220	17-2.5ER476M	17-2.5ER476M	CAP. ELE., 47uF/25V, +/-20%	4
C221, C222	17-5DR150J	17-5DR150J	CAP. M.CER., 15pF/50V, +/-5%	2
C209, C210	17-5DR560J	17-5DR560J	CAP. M.CER., 56pF/50V, +/-5%	2
C235-C238 * C	17-5DR101J	17-5DR101J	CAP. M.CER., 100pF/50V, +/-5%	4
C233, C234 * C	17-5DR221J	17-5DR221J	CAP. M.CER., 220pF/50V, +/-5%	4
C203, C204, C217, C218, C225-C228	17-5FR104J	17-5FR104J	CAP. M.P.E. 0.1uF/50V, +/-5%	8
C229, C230	17-5PR222J	17-5PR222J	CAP. P.P., 2n2F/50V, +/-5%	2
C211, C212	17-5SR243J	17-5SR243J	CAP. E.P.S., 24nF/50V, +/-1%	2
C213, C214	17-5SR682J	17-5SR682J	CAP. E.P.S., 6n8F/50V, +/-1%	2
C201, C202, C207, C208	17-5SR101J	17-5SR101J	CAP. E.P.S., 100pF/50V, +/-5%	4
COILS				
L201, L202 * AH	29-1089	29-1089	COIL Troid coil, 22uH	2
L203, L204 * AH	29-1091	29-1091	COIL Troid coil, 3.7mH	2
L201-L204 * C	29-1109	29-1109	COIL Troid coil, 1mH	4
DIODES				
D201-D204	1N4148	30-1N4148	DIODE DIODE 1N4148	4
TRANSISTORS				
Q205-Q208	2SA1015GR	30-2SA1015	TR. 2SA1015GR, Toshiba	4
Q201-Q204	2SC3329BL	30-2SC3329	TR. 2SC3329BL, Toshiba	4
Q209-Q214	BC556	30-BC556	TR. BC556, Philips	6
SWITCH				
SW303	31-1000S	31-1000S	TOGGLE SW 8021 MM/MC	1
PREAMP CKT		(19-1206-3)	NAD-106	1
RESISTORS				
R319, R320, R351	16-1/4MA102F	16-1/4MA102F	RES. M.F., 1K, 1/4W, +/-1%	3
R313, R314	16-1/4MA153F	16-1/4MA153F	RES. M.F., 15K, 1/4W, +/-1%	2
R323, R324, R331, R332	16-1/4MA181F	16-1/4MA181F	RES. M.F., 180, 1/4W, +/-1%	4
R343, R344	16-1/4MA221F	16-1/4MA221F	RES. M.F., 220, 1/4W, +/-1%	2
R301, R302	16-1/4MA224F	16-1/4MA224F	RES. M.F., 220K, 1/4W, +/-1%	2
R321, R322	16-1/4MA272F	16-1/4MA272F	RES. M.F., 2K7, 1/4W, +/-1%	2
R305, R306	16-1/4MA391F	16-1/4MA391F	RES. M.F., 390, 1/4W, +/-1%	2
R307, R308, R327-R330	16-1/4MA392F	16-1/4MA392F	RES. M.F., 3K9, 1/4W, +/-1%	6
R315-R318	16-1/4MA680F	16-1/4MA680F	RES. M.F., 68, 1/4W, +/-1%	4

NAD-106 PARTS LIST

LOCATION	REF. NO.	PARTS NO.	DESCRIPTION	Q'TY
R325, R326, R333, R334	16-1/4MA681F	16-1/4MA681F	RES. M.F., 680, 1/4W, +/-1%	4
R335, R336	16-1/4MA223F	16-1/4MA223F	RES. M.F., 22K, 1/4W, +/-1%	2
R309-R312	16-1/4MA682F	16-1/4MA682F	RES. M.F., 6K8, 1/4W, +/-1%	4
R337-R342	16-1/4MA470F	16-1/4MA470F	RES. M.F., 47, 1/4W, +/-1%	6
<b>CAPACITORS</b>				
C317, C318	17-2.5ER107ML	17-2.5ER107ML	CAP. ELE., 100uF/25V, +/-20%, L.L.	2
C313, C314	17-2.5ER476ML	17-2.5ER476ML	CAP. ELE., 47uF/25V, +/-20%, L.L.	2
C323, C324	17-3.5ER476ML	17-3.5ER476ML	CAP. ELE., 47uF/35V, +/-20%, L.L.	2
C309, C310	17-5DR150J	17-5DR150J	CAP. M.CER., 15pF/50V, +/-5%	2
C311, C312, C315, C316, C321, C322	17-5FR104J	17-5FR104J	CAP. M.PE., 0.1uF/50V, +/-5%	6
C319, C320	17-5FR183J	17-5FR183J	CAP. M.PE., 18nF/50V, +/-5%	2
C303, C304, C327, C328	17-5FR474J	17-5FR474J	CAP. M.PE., 0.47uF/50V, +/-5%	4
C325, C326	17-5FR823J	17-5FR823J	CAP. M.PE., 82nF/50V, +/-5%	2
C329, C330	17-5SR102J	17-5SR102J	CAP. E.P.S., 1nF/50V, +/-5%	2
C305, C306	17-5SR101J	17-5SR101J	CAP. E.P.S., 100pF/50V, +/-5%	2
C307, C308	17-5SR221J	17-5SR221J	CAP. E.P.S., 220pF/50V, +/-5%	2
C351	17-5SR820J	17-5SR820J	CAP. E.P.S., 82pF/50V, +/-5%	1
<b>VAR.</b>				
VR302	29-4136	29-4136	VAR. TREBLE RK163121A106-10KC*2-EK	1
VR303	29-4140	29-4140	VAR. BASS RK163121A155-50KC*2-EK	1
VR304	29-4141	29-4141	VAR. BAL RK163111E291-10KW-EK	1
VR301	29-4162	29-4162	VAR. VOL RK27112A0-20KAx2	1
<b>DIODES</b>				
D301-D306	1N4148	30-1N4148	DIODE DIODE 1N4148	6
<b>TRANSISTORS</b>				
Q307, Q308	2SA1015GR	30-2SA1015	TRAN. 2SA1015GR, Toshiba	2
Q301, Q302	2SA1316GR	30-2SA1316	TRAN. 2SA1316GR, Toshiba	2
Q303-Q306	2SC1815GR	30-2SC1815	TRAN. 2SC1815GR, Toshiba	4
<b>POWER CKT (19-1206-5) NAD-106</b>				
<b>RESISTORS</b>				
R501, R502	16-1XK220J	16-1XK220J	RES. M.X.22, 1W, +/-5%, KINK	2
R513	16-1/2CA332J	16-1/2CA332J	RES. C.F., 3K3, 1/2W, +/-5%, TAPE	1
R601	16-1/4MA103F	16-1/4MA103F	RES. M.F., 10K, 1/4W, +/-1%	1
R503-R509	16-1/4MA122F	16-1/4MA122F	RES. M.F., 1K2, 1/4W, +/-1%	7
R511, R512	16-1/4MA153F	16-1/4MA153F	RES. M.F., 15K, 1/4W, +/-1%	2
R510	16-1/4MA331F	16-1/4MA331F	RES. M.F., 330, 1/4W, +/-1%	1
R603	16-1/4MA391F	16-1/4MA391F	RES. M.F., 390, 1/4W, +/-1%	1
R605	16-1/4MA823F	16-1/4MA823F	RES. M.F., 82K, 1/4W, +/-1%	1
<b>CAPACITORS</b>				
C502	17-25FR103K	17-25FR103K	CAP. M.PE., 10nF/250V, +/-10%	1
C511	17-3.5ER106M	17-3.5ER106M	CAP. ELE., 10uF/35V, +/-20%	1
C507, C508, C513, C514	17-3.5ER477M	17-3.5ER477M	CAP. ELE., 470uF/35V, +/-20%	4
C512	17-3.5ER476M	17-3.5ER476M	CAP. ELE., 47uF/35V, +/-20%	1
C501	17-40CR472M	17-40CR472M	CAP. CER., 4n7F/400V, +/-20%	1
C509, C510	17-5DR220J	17-5DR220J	CAP. M.CER., 22pF/50V, +/-5%	2
C601, C602	17-5ER476M	17-5ER476M	CAP. ELE., 47uF/63V, +/-20%	2
C505, C506	17-5ER228M	17-5ER228M	CAP. ELE., 220uF/50V, +/-20%	2
C503, C504, C515, C516	17-5FR473J	17-5FR473J	CAP. M.PE., 47nF/50V, +/-5%	4
<b>DIODES</b>				
D501	30-HZ22-2	30-HZ22-2	ZENER DIODE ZD 22V 1/2W +/-5%	1
D601, D602	1N4148	30-1N4148	DIODE DIODE 1N4148	2
BD501	RB153	30-RB153	BRIDGE DIODE RB153	1
<b>TRANSISTORS</b>				
Q502	2SB649A or C	30-2SB649A	TRAN. 2SB649A or C, Hitachi	1
Q501	2SD669A or C	30-2SD669A	TRAN. 2SD669A or C, Hitachi	1
Q504	2SA1015GR	30-2SA1015	TRAN. 2SA1015GR, Toshiba	1
Q503	2SC1815GR	30-2SC1815	TRAN. 2SC1815GR, Toshiba	1
Q601	2SC2240GR	30-2SC2240	TRAN. 2SC2240GR, Toshiba	1
<b>FUSES</b>				
F01, F02	32S2014	32S2014	CLAMPER FUSE CLAMPER, CPF-011	4
F1, F2 *C	32S1250250TS	32S1250250TS	218.250 250mA/250V, 5x20mmT, SEMKO	2
F1, F2 *B1	32S1250250TS	32S1250250TS	218.250 250mA/250V, 5x20mmT, SEMKO	2
F1, F2 *AH	32S1250250TU	32S1250250TU	SGCO.25 250mA/250V, 5x20mmT, SGC, UL	2
T501	29-2132	29-2132	TRANSFORMER Universal/LX-0136	1
S501	31-1213	31-1213	SW-POWER SDDL B1007U-EK TV-3	1
<b>FOR LED</b>				
D502	30-SE2021	(19-1206-6) 30-SE2021	NAD-106 L.E.D.IODE LED/SE2021, GRN	1
<b>HEADPHONE CKT</b>				
J401	12-2128G	(19-1206-4) 12-2128G	NAD-106 HEADPHONE JACK CPJ-061-9G with clipper	1

NAD-106 PARTS LIST

LOCATION	REF. NO.	PARTS NO.	DESCRIPTION	Q'TY
<b>RESISTORS</b>				
R431	16-1MK151J	16-1MK151J	RES. M.F., 150, 1W, +/-5%, KINK	1
R432	16-1MK820J	16-1MK820J	RES. M.F., 82, 1W, +/-5%, KINK	1
R413, R414	16-1/2CA121J	16-1/2CA121J	RES. C.F., 120, 1/2W, +/-5%	2
R407, R408, R434	16-1/4MA102F	16-1/4MA102F	RES. M.F., 1K, 1/4W, +/-1%	3
R433	16-1/4MA152F	16-1/4MA152F	RES. M.F., 1K5, 1/4W, +/-1%	1
R403, R404, R411, R412, R453	16-1/4MA223F	16-1/4MA223F	RES. M.F., 22K, 1/4W, +/-1%	5
R452	16-1/4MA224F	16-1/4MA224F	RES. M.F., 220K, 1/4W, +/-1%	1
R405, R406	16-1/4MA333F	16-1/4MA333F	RES. M.F., 33K, 1/4W, +/-1%	2
R409, R410, R435, R436	16-1/4MA472F	16-1/4MA472F	RES. M.F., 4K7, 1/4W, +/-1%	4
R451	16-1/4MA474F	16-1/4MA474F	RES. M.F., 470K, 1/4W, +/-1%	1
R401, R402	16-1/4MA682F	16-1/4MA682F	RES. M.F., 6K8, 1/4W, +/-1%	2
<b>CAPACITORS</b>				
C403, C404, C433, C434	17-2.5ER107M	17-2.5ER107M	CAP. ELE., 100uF/25V, +/-20%	4
C431, C432	17-2.5ER476M	17-2.5ER476M	CAP. ELE., 47uF/25V, +/-20%	2
C407, C408	17-5DR271J	17-5DR271J	CAP. M.CER., 270pF/50V, +/-5%	2
C401, C402	17-5ER105M	17-5ER105M	CAP. ELE., 1uF/50V, +/-20%	2
C405, C406	17-5FR222J	17-5FR222J	CAP. M.PE., 2n2F/50V, +/-5%	2
C409, C410	17-5FR473J	17-5FR473J	CAP. M.PE., 47nF/50V, +/-5%	2
C411-C414 * C	17-5FR102J	17-5FR102J	CAP. M.PE., 1nF/50V, +/-5%	4
<b>RELAY</b>				
K451	29-1000S	29-1000S	RELAY DS2Y-S-DC-24V	1
<b>DIODE</b>				
D451	1N4148	30-1N4148	DIODE 1N4148	1
<b>TRANSISTORS</b>				
Q451, Q452	2SA1015GR	30-2SA1015	TRAN. 2SA1015GR, Toshiba	2
Q432	2SA817Y	30-2SA817	TRAN. 2SA817Y, Toshiba	1
Q431	2SC1627Y	30-2SC1627	TRAN. 2SC1627Y, Toshiba	1
Q401, Q402, Q453	2SC2878A	30-2SC2878	TRAN. 2SC2878A, Toshiba	3
<b>IC.</b>				
IC401	NJM2043(D)	30-NJM2043	IC. NJM2043(D), JRC	1

# PACKING DIAGRAM

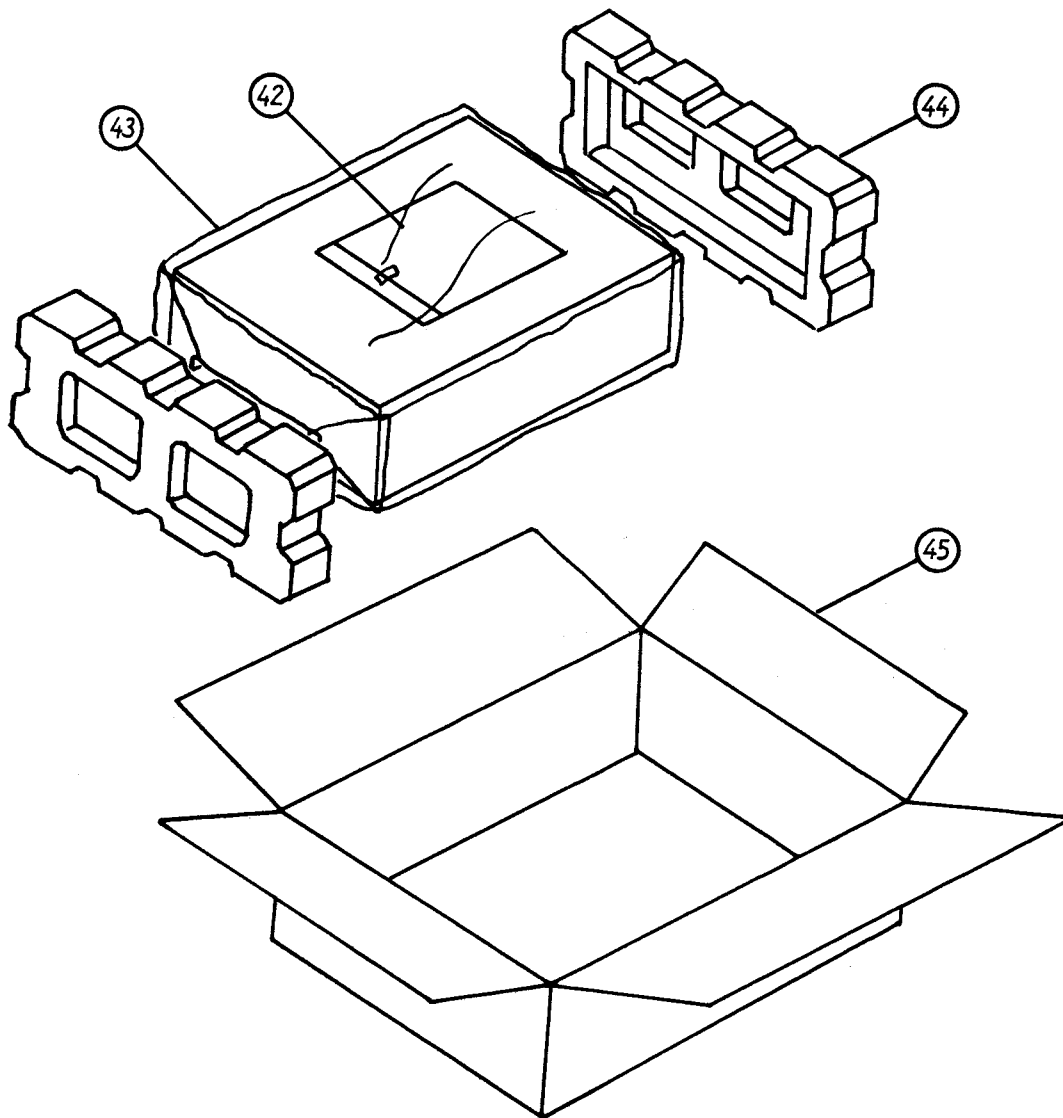

ITEM	PARTS NO.	DESCRIPTION	Q'TY
42	21-4054	OWNER'S MANUAL	1
43	26-0716	PE - BAG	1
44	34-1059	POLYLON	2
45	CT-5193-2	GIFT - BOX	1