

SERVICE MANUAL

NAD

For Service Manuals Contact
MAURITRON TECHNICAL SERVICES
8 Cherry Tree Rd, Chinnor
Oxon OX9 4QY
Tel:- 01844-351694 Fax:- 01844-352554
Email:- enquiries@mauritron.co.uk

304

INTEGRATED
AMPLIFIER

304

INTEGRATED
AMPLIFIER

TABLE OF CONTENTS

SPECIFICATIONS	3-4
REAR PANEL CONNECTIONS	5
FRONT PANEL FUNCTIONS	6
ALIGNMENT PROCEDURE	7
EXPLODED VIEW PARTS LIST	8 and 13
WIRING DIAGRAM	9
SCHEMATIC DIAGRAM	10
PCB LAY-OUT	11
EXPLODED VIEW	12
ELECTRICAL PARTS LIST	14-18
PACKING DIAGRAM	19

SERVICE SAFETY PRECAUTIONS

For Service Manuals Contact
MAURITRON TECHNICAL SERVICES
8 Cherry Tree Rd, Chinnor
Oxon OX9 4QY
Tel:- 01844-351694 Fax:- 01844-352554
Email:- enquiries@mauritron.co.uk

1. Use exact replacement parts for critical locations, marked "  " on parts list.
2. Return lead dress to original position, and re-install protective covers.
3. Before returning to customer, test for shock hazard; use either method A or B:
 - A. Leakage test, "cold":**
 1. Unplug AC cord, turn power switch ON.
 2. Connect one lead of High Voltage Insulation Tester to both prongs of AC plug.
 3. Touch other lead to all exposed metal parts.
 4. Impedance measurement must be 0.3 – 5.0 Megohms.
 - B. Leakage test, "live":**
 1. Plug unit directly into AC outlet; do not use isolation transformer.
 2. Connect one lead of Leakage Current Tester to earth ground.
 3. Touch other lead to all exposed metal parts.
 4. Leakage measurement must be less than 0.5 milliamps.

SPECIFICATIONS

POWER AMPLIFIER SECTION STEREO MODE

**CONTINUOUS AVERAGE POWER
OUTPUT INTO 8 OHMS** **35 W (15.5 dBW)**

(Min. power per channel, 20 Hz – 20 kHz, both channels driven, with no more than rated distortion)

Rated Distortion
(THD 20 Hz – 20 kHz) **0.03%**

Clipping power
(maximum continuous power per channel). **42 W**

IHF dynamic headroom at 8 ohms **+ 5.5 dB**

IHF dynamic power
(maximum short term power per channel)

8 ohms:	120 W (21 dBW)
4 ohms:	160 W (22 dBW)
2 ohms:	200 W (23 dBW)

Slew rate **> 20 V / μ sec**

Damping factor
(ref. 8 ohms 50 Hz) **> 100**

Input Impedance **R = 18 kohms
C = 560 pF**

For Service Manuals Contact
MAURITRON TECHNICAL SERVICES
8 Cherry Tree Rd, Chinnor
Oxon OX9 4QY
Tel: 01844-351694 Fax: 01844-352554
Email: enquiries@mauritron.co.uk

Input sensitivity (for rated output into 8 ohms) **1 V**

Voltage gain **x17 (24.6 dB)**

Frequency response 20 Hz – 20 kHz **\pm 0.3 dB
– 3 dB at 3 Hz / 70 kHz**

Signal / Noise ratio, A-weighted **102 dB ref. 1 W
117 dB ref. 35 W**

THD
(Total Harmonic Distortion, 20 Hz – 20 kHz,
from 250 mW to rated output) **< 0.03%**

SMPTE I.M.
(Intermodulation Distortion, 60 Hz + 7 kHz, 4:1,
from 250 mW to rated output) **< 0.03%**

IHF I.M.
(CCIF IM Distortion, 19 + 20 kHz at rated output) **< 0.03%**

PREAMPLIFIER SECTION

PHONO INPUT

Input impedance (R and C)	MM: 47 kohms + 200 pF
Input sensitivity (ref. rated power, 1 kHz)	MM: 2.5 mV
Input overload at 20 Hz / 1 kHz / 20 kHz	MM: 22 mV / 220 mV / 2.0V
THD (20 Hz – 20 kHz) and IM dist.	< 0.1% at +30 dB level
RIAA accuracy	± 0.5 dB
Signal / Noise ratio (A-weighted with cartridge connected)	MM: 77 dB ref. 5 mV

LINE LEVEL INPUTS

(CD, Video, Auxiliary, Tuner, Tape)

Input impedance (R and C)	20 kohms + 500 pF
Input sensitivity (ref. rated power)	165 mV
Maximum input signal	> 10V
Signal / Noise ratio, A-weighted	91 dB ref. 1 W 106 dB ref. rated power
Frequency response, 20 Hz – 20 kHz	+ 0/-0.3 dB (tone defeat) ± 0.5 dB (tone flat)
THD, SMPTE IM, IHF IM and TIM	< 0.01% at 5 V out

For Service Manuals Contact
MAURITRON TECHNICAL SERVICES
8 Cherry Tree Rd, Chinnor
Oxon OX9 4QY
Tel:- 01844-351694 Fax:- 01844-352554
Email:- enquiries@mauritron.co.uk

LINE LEVEL OUTPUTS

Preamp output impedance	220 ohms
Tape output impedance	Source Z + 2 kohms
Headphones output impedance	220 ohms
Maximum output level	preamp-out : > 12 V tape-out : > 10 V headphones-out : > 10 V into 600 ohms > 500 mV into 8 ohms

CONTROLS

Treble	± 7 dB at 10 kHz
Bass	± 10 dB at 50 Hz
Infrasonic filter (fixed)	- 3 dB at 10 Hz 12 dB / octave

REAR PANEL CONNECTIONS

1. AC LINE CORD
2. AC OUTLET (AH ONLY)
3. SPEAKER A TERMINAL
4. SPEAKER B TERMINAL
5. SOFT CLIPPING
6. PRE AMP OUT/MAIN IN
7. TAPE 1 INPUT/OUTPUT
8. TAPE 2 INPUT/OUTPUT
9. TUNER
10. AUXILIARY
11. VIDEO SOUND
12. CD
13. PHONO
14. PHONO GROUND

For Service Manuals Contact
MAURITRON TECHNICAL SERVICES
 8 Cherry Tree Rd, Chinnor
 Oxon OX9 4QY
 Tel:- 01844-351694 Fax:- 01844-352554
 Email:- enquiries@maurtron.co.uk

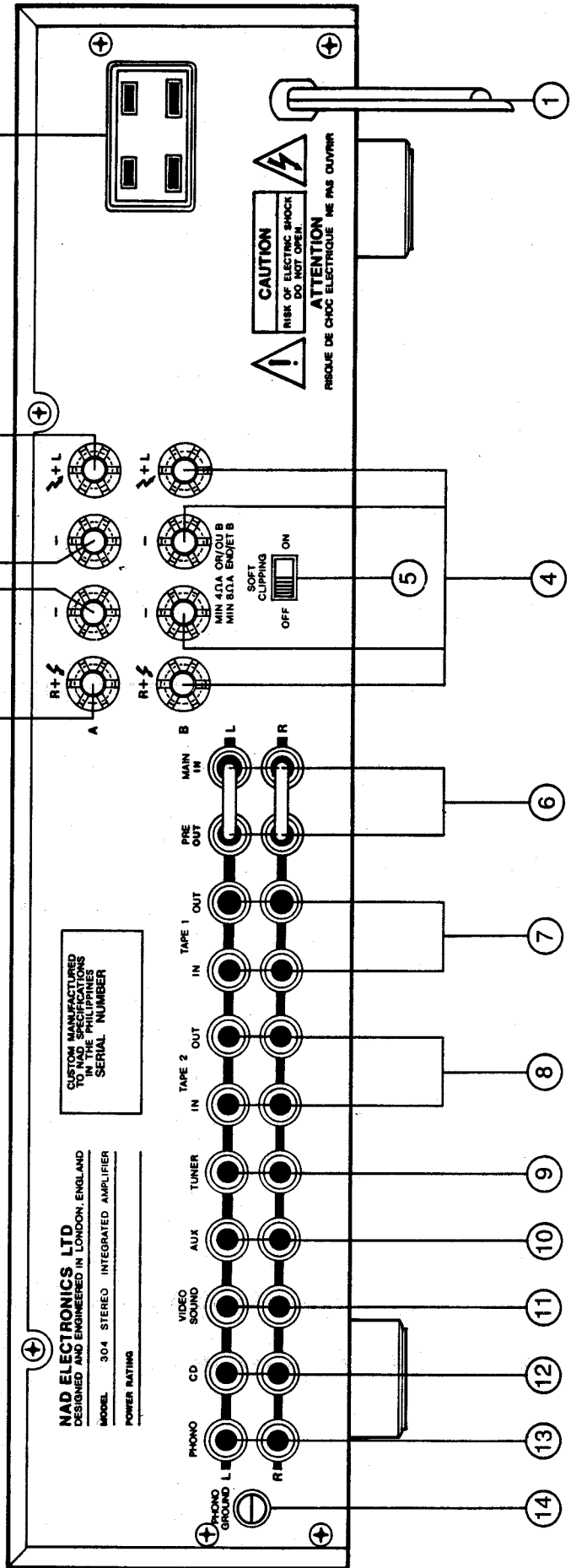

FRONT PANEL FUNCTIONS

- 15. PHONES
- 16. POWER
- 17. EXTRA SPEAKERS
- 18. BASS
- 19. TONE DEFEAT
- 20. TREBLE
- 21. BALANCE
- 22. SOFT CLIPPING INDICATOR
- 23. POWER INDICATOR
- 24. TAPE 1 MONITOR
- 25. INPUT SELECTOR
- 26. VOLUME

For Service Manuals Contact
MAURITRON TECHNICAL SERVICES
 8 Cherry Tree Rd, Chinnor
 Oxon OX9 4QY
 Tel:- 01844-351694 Fax:- 01844-352554
 Email:- enquiries@mauritron.co.uk

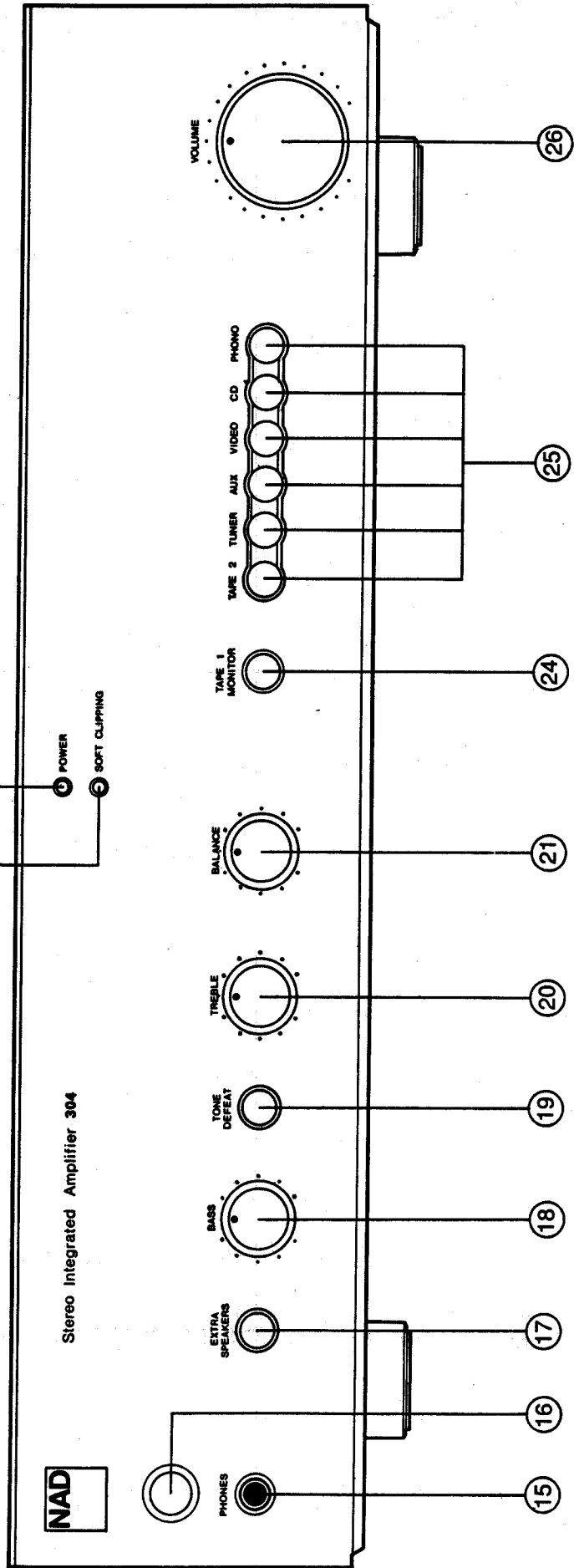

ALIGNMENT PROCEDURE

I. INITIAL ADJUSTMENT (No load connected)

A. OUTPUT OFFSET VOLTAGE

1. Connect a DC Millivoltmeter to L Channel speaker output terminals.
2. Turn unit "ON" and adjust RV301 (10 kohms) to get a reading of $0V \pm 10\text{ mV}$.
3. Connect the DC Millivoltmeter to R Channel speaker output terminals and adjust RV 302 (10 kohms) to get a reading of $0V \pm 10\text{ mV}$.

B. IDLING CURRENT

1. Connect a DC Millivoltmeter to TP301 and TP303 and adjust VR303 (1 kohms) for 5.7 – 6.4 mV reading on meter.
2. Connect the DC Millivoltmeter to TP302 and TP304 and adjust VR304 (1 kohms) for 5.7 – 6.4 mV reading on meter.
3. Leave power "ON" for minimum of 5 minutes.

For Service Manuals Contact
MAURITRON TECHNICAL SERVICES
8 Cherry Tree Rd, Chinnor
Oxon OX9 4QY
Tel:- 01844-351694 Fax:- 01844-352554
Email:- enquiries@mauritron.co.uk

II. FINAL ADJUSTMENT

Repeat procedure A and B for offset voltage and idling current alignment respectively.

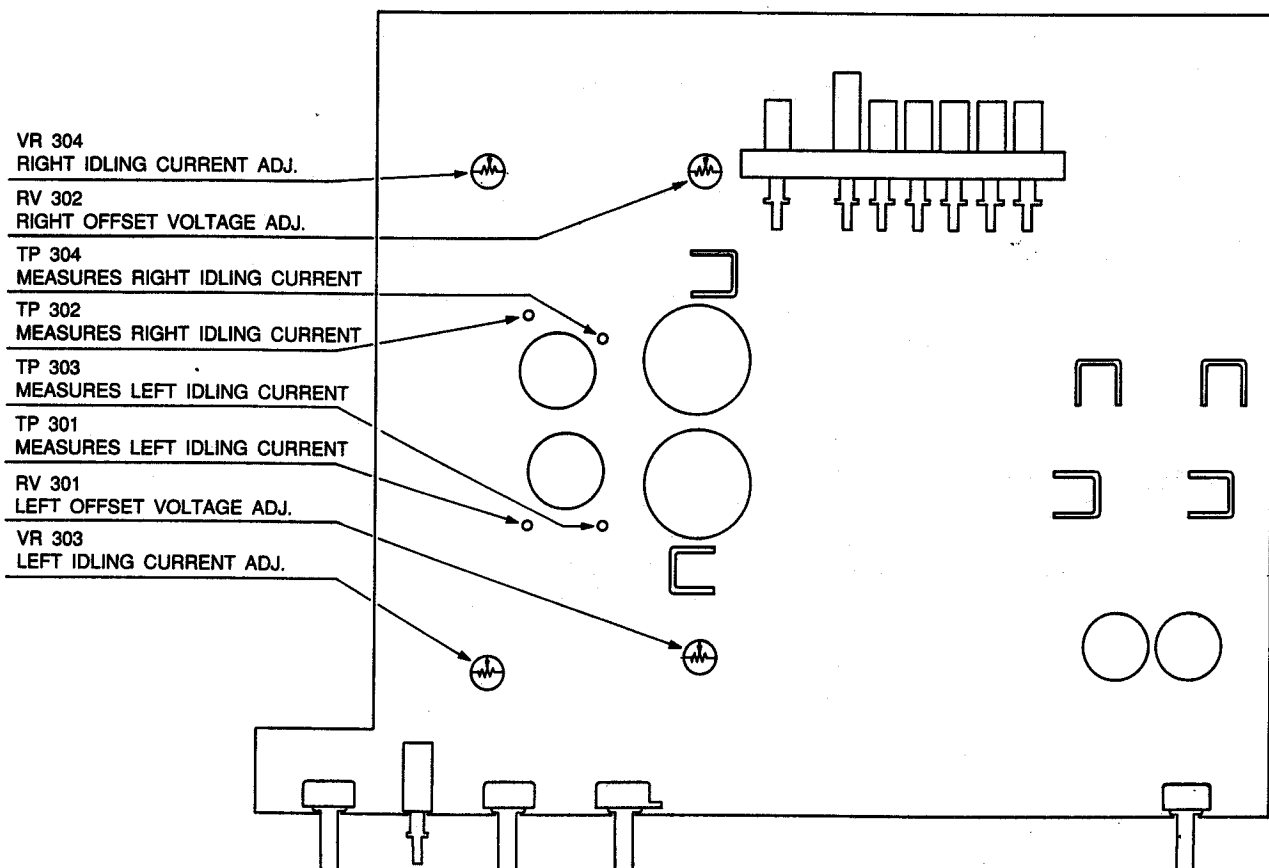

EXPLODED VIEW PARTS LIST

ITEM	PART NUMBER	DESCRIPTION	QTY/UNIT
1	061-00001	Fascia	1 pc
2	062-00001	Knob 35.0mm (Volume)	1 pc
3	062-00002	Knob 18.5mm (Bass, Treble, Balance)	3 pcs
4	062-00003	Long Button 9.5mm (Power)	1 pc
5	063-00002	Power Button Extender	1 pc
6	062-00004	Long Button 8.0mm (Input Select)	9 pcs
7	063-00001	Button Extender (Input Select)	7 pcs
8	064-00001	Plastic Foot	4 pcs
9	065-00001	Pointer	4 pcs
10	136-00650	Nut 6.5mm	4 pcs
11	134-00712	Washer 7x12mm	4 pcs
12	134-00315	Washer 3x15mm	1 pc
13	134-00307	Washer 3x7mm	4 pcs
14	101-00001	Subfascia	1 pc
15	101-00005	Right Side Panel	1 pc
16 * AH	101-00002	Rear Panel * AH only	1 pc
16 * C,B1	101-00003	Rear Panel * C & B1 only	1 pc
17	101-00004	Left Side Panel	1 pc
18	101-00006	Top Cover PVC Coated	1 pc
19	101-00007	Base	1 pc
20	102-00001	Heatsink Extrusion (NAD 001)	2 pcs
21	102-00002	Heatsink Mounting Bar Extrusion (NAD 002)	1 pc
22	102-00003	Commutation Transistor Heatsink A	2 pcs
23	102-00004	60V Regulator Transistor Heatsink B	2 pcs
24	102-00005	28V Regulator Transistor Heatsink C	2 pcs
25	060-00001A	Mains PCB Assy. (Part of PCB 060-00001)	1 pc
26	060-00001B	Speaker PCB Assy. (Part of PCB 060-00001)	1 pc
27	060-00001C	LED PCB Assy. (Part of PCB 060-00001)	1 pc
28	060-00001D	Headphone Assy. (Part of PCB 060-00001)	1 pc
29	060-00001E	Extra Spkr. Switch PCB Assy. (Part of PCB 060-00001)	1 pc
30	060-00001F	Amp. PCB Assy. (Part of PCB 060-00001)	1 pc
31	092-10001	See page 19 TX1	1 pc
32	072-19320	See page 18 RV101	1 pc
33	075-49310	See page 18 RV201	1 pc
34	073-39310	See page 18 RV103	1 pc
35	073-39350	See page 18 RV105	1 pc
36	081-00002	See page 18 SW1	1 pc
37	081-00003	See page 18 SW3	1 pc
38	081-00004	See page 18 SW4	1 pc
39	081-00001	See page 18 SW1A-F / SW2A	1 pc
40	081-00005	See page 18 SW701	1 pc
41	082-00007	See page 19 J501, J502	2 pcs
42	082-00002	See page 19 J101	1 pc
43	082-00003	See page 19 J102, J103, J104	3 pcs
44	082-00008	See page 19 J601	1 pc
45	140-00001	Sleeve, Big (D = 30mm, L = 77mm)	1 pc
46	140-00007	Silicone Sheet, Small	8 pcs
47	140-00008	Mica Insulator, Big	4 pcs

For Service Manuals Contact
MAURITRON TECHNICAL SERVICES
 8 Cherry Tree Rd, Chinnor
 Oxon OX9 4QY
 Tel:- 01844-351694 Fax:- 01844-352554
 Email:- enquiries@mauritron.co.uk

WIRING DIAGRAM

FOR C. & B1-VERSION

For Service Manuals Contact
MAURITRON TECHNICAL SERVICES
 8 Cherry Tree Rd, Chinnor
 Oxon OX9 4QY
 Tel:- 01844-351694 Fax:- 01844-352554
 Email:- enquiries@mauritron.co.uk

FOR A4 VERSION

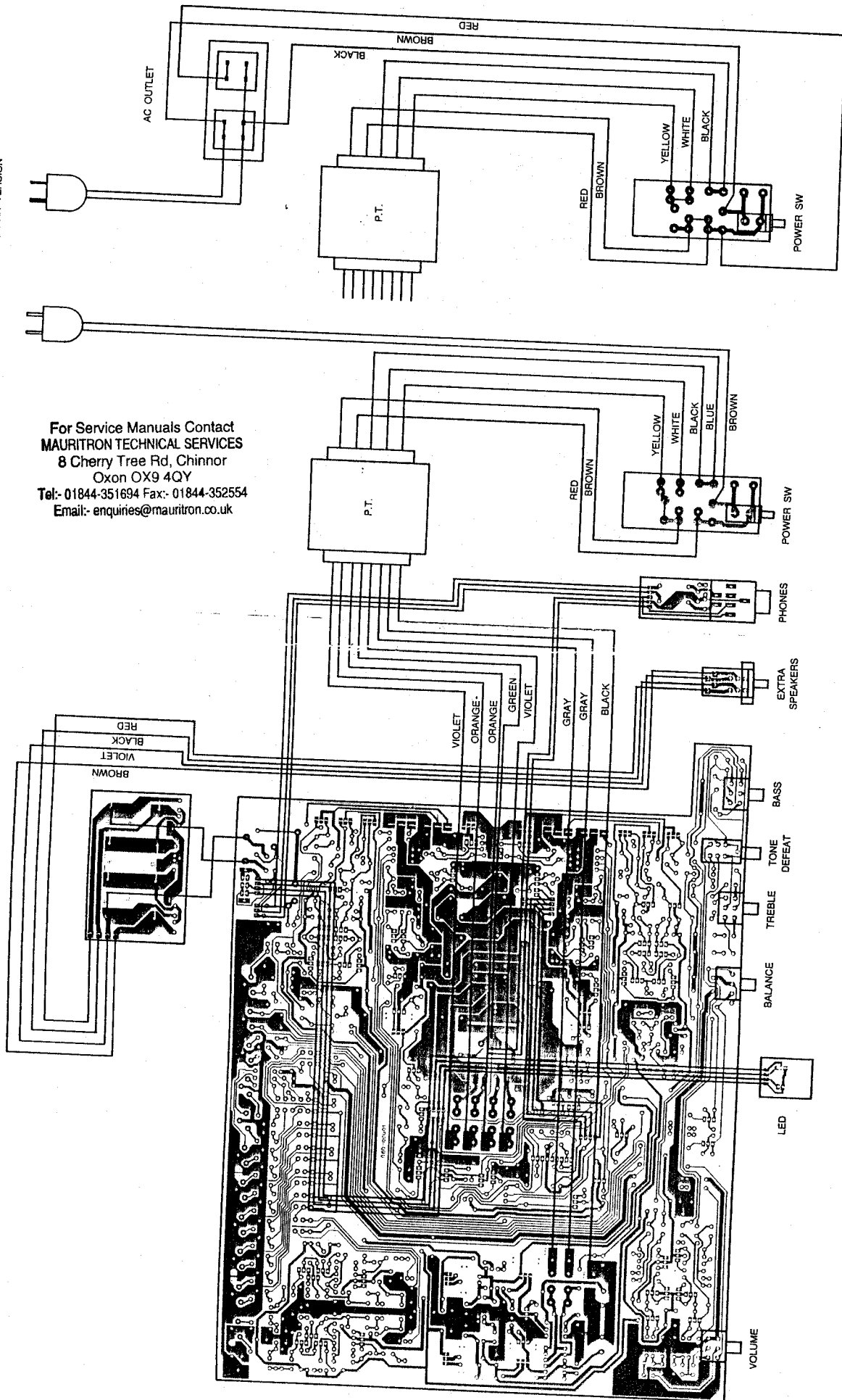

SCHEMATIC DIAGRAM

For Service Manuals Contact
MAURITRON TECHNICAL SERVICES
 8 Cherry Tree Rd, Chinnor
 Oxon OX9 4QY
 Tel:- 01844-351694 Fax:- 01844-352554
 Email:- enquiries@mauritron.co.uk

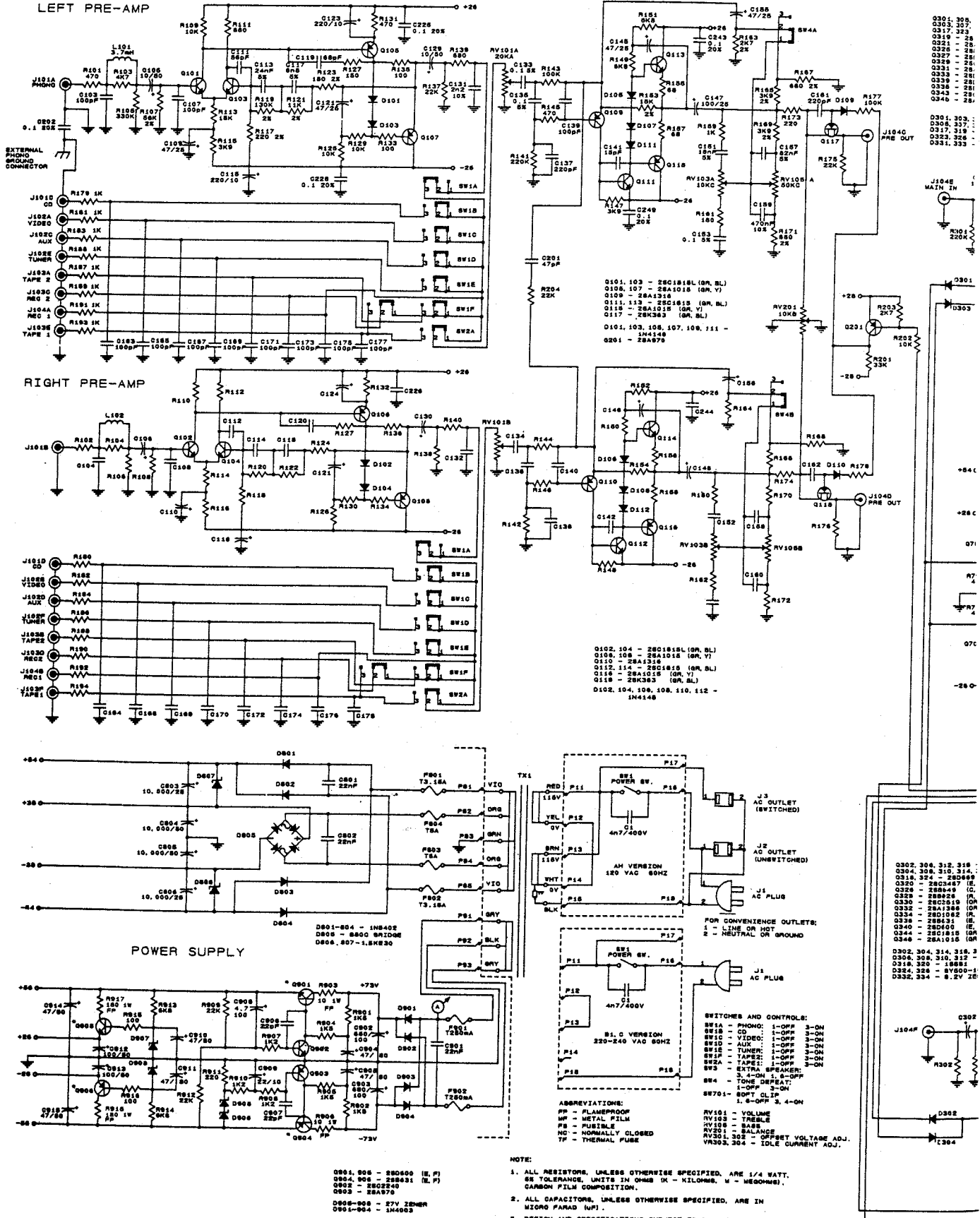

For Service Manuals Contact
MAURITRON TECHNICAL SERVICES
 8 Cherry Tree Rd, Chinnor
 Oxon OX9 4QY
 Tel: 01844-351694 Fax: 01844-352554
 Email: enquiries@mauritron.co.uk

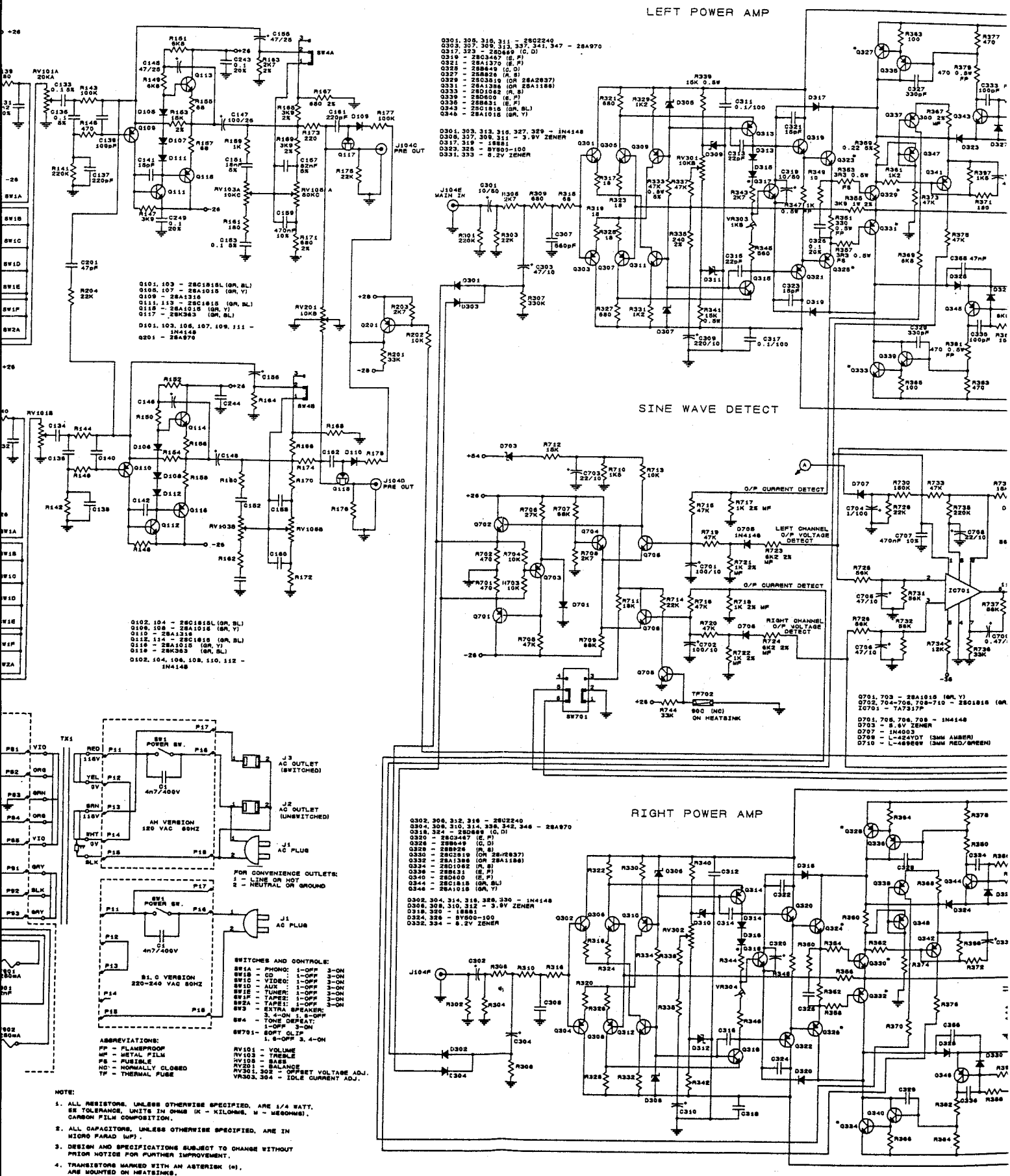

For Service Manuals Contact
MAURITRON TECHNICAL SERVICES
8 Cherry Tree Rd, Chinnor
Oxon OX9 4QY
Tel: 01844-351694 Fax: 01844-352554
Email: enquiries@mauritron.co.uk

LEFT POWER AMP

SINE WAVE DETECT

PROTECTION

RIGHT POWER AMP

311 - 28C2240
312, 317, 341, 347 - 28A970
0649 (C, D)
(E, F)
(G, H)
(I, J)
(K, L)
(M, N)
(O, P)
(Q, R)
(S, T)
(U, V)
(W, X)
(Y, Z)
316, 327, 329 - 1N4148
331 - 3.0V ZENER
301 - 100
3V ZENER

3305 R305 22K
3306 R306 22K
3307 R307 22K
3308 R308 22K
3309 R309 22K
3310 R310 22K
3311 R311 22K
3312 R312 22K
3313 R313 22K
3314 R314 22K
3315 R315 22K
3316 R316 22K
3317 R317 22K
3318 R318 22K
3319 R319 22K
3320 R320 22K
3321 R321 22K
3322 R322 22K
3323 R323 22K
3324 R324 22K
3325 R325 22K
3326 R326 22K
3327 R327 22K
3328 R328 22K
3329 R329 22K
3330 R330 22K
3331 R331 22K
3332 R332 22K
3333 R333 22K
3334 R334 22K
3335 R335 22K
3336 R336 22K
3337 R337 22K
3338 R338 22K
3339 R339 22K
3340 R340 22K
3341 R341 22K
3342 R342 22K
3343 R343 22K
3344 R344 22K
3345 R345 22K
3346 R346 22K
3347 R347 22K
3348 R348 22K
3349 R349 22K
3350 R350 22K
3351 R351 22K
3352 R352 22K
3353 R353 22K
3354 R354 22K
3355 R355 22K
3356 R356 22K
3357 R357 22K
3358 R358 22K
3359 R359 22K
3360 R360 22K
3361 R361 22K
3362 R362 22K
3363 R363 22K
3364 R364 22K
3365 R365 22K
3366 R366 22K
3367 R367 22K
3368 R368 22K
3369 R369 22K
3370 R370 22K
3371 R371 22K
3372 R372 22K
3373 R373 22K
3374 R374 22K
3375 R375 22K
3376 R376 22K
3377 R377 22K
3378 R378 22K
3379 R379 22K
3380 R380 22K
3381 R381 22K
3382 R382 22K
3383 R383 22K
3384 R384 22K
3385 R385 22K
3386 R386 22K
3387 R387 22K
3388 R388 22K
3389 R389 22K
3390 R390 22K
3391 R391 22K
3392 R392 22K
3393 R393 22K
3394 R394 22K
3395 R395 22K
3396 R396 22K
3397 R397 22K
3398 R398 22K
3399 R399 22K
3400 R400 22K

BU2240
342, 348 - 28A970
(D)
(E)
(F)
(G)
(H)
(I)
(J)
(K)
(L)
(M)
(N)
(O)
(P)
(Q)
(R)
(S)
(T)
(U)
(V)
(W)
(X)
(Y)
(Z)
330 - 1N4148
3V ZENER

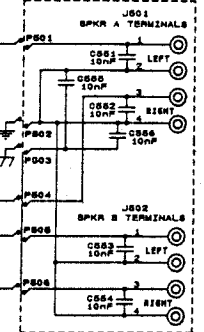
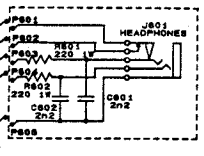

0701, 703 - 28A1018 (OR, V)
0702, 704-708, 708-710 - 28G1818 (OR, M)
I0701 - TA7517P
0701, 708, 708, 708 - 1N4148
0703 - 8.6V ZENER
0707 - 1N4003
0709 - L-424VDT (3MM AMBER)
0710 - L-488EOW (3MM RED/GREEN)

- 29C3519
- 28A1386
- 25D1062
- 25B426
- 1N4148
- 18581
- 28A1015
- 25C7815
- 28A1319
- 28C2240
- 28A970
- B24 (3.0V)
- A24 (8.2V)
- B16 (5.6V)
- 272 (27 V)
- 29C3467
- 28A1370
- TA7517P
- 29K363
- B90C
- L-488EOW
- L-424VDT
- 25D889
- 25B848
- 25D3000
- 25B831

SCHEMATIC DIAGRAM

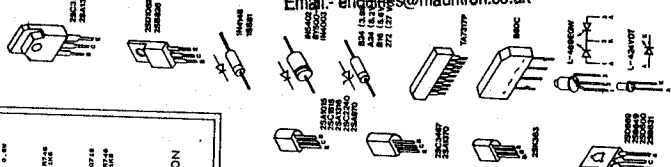
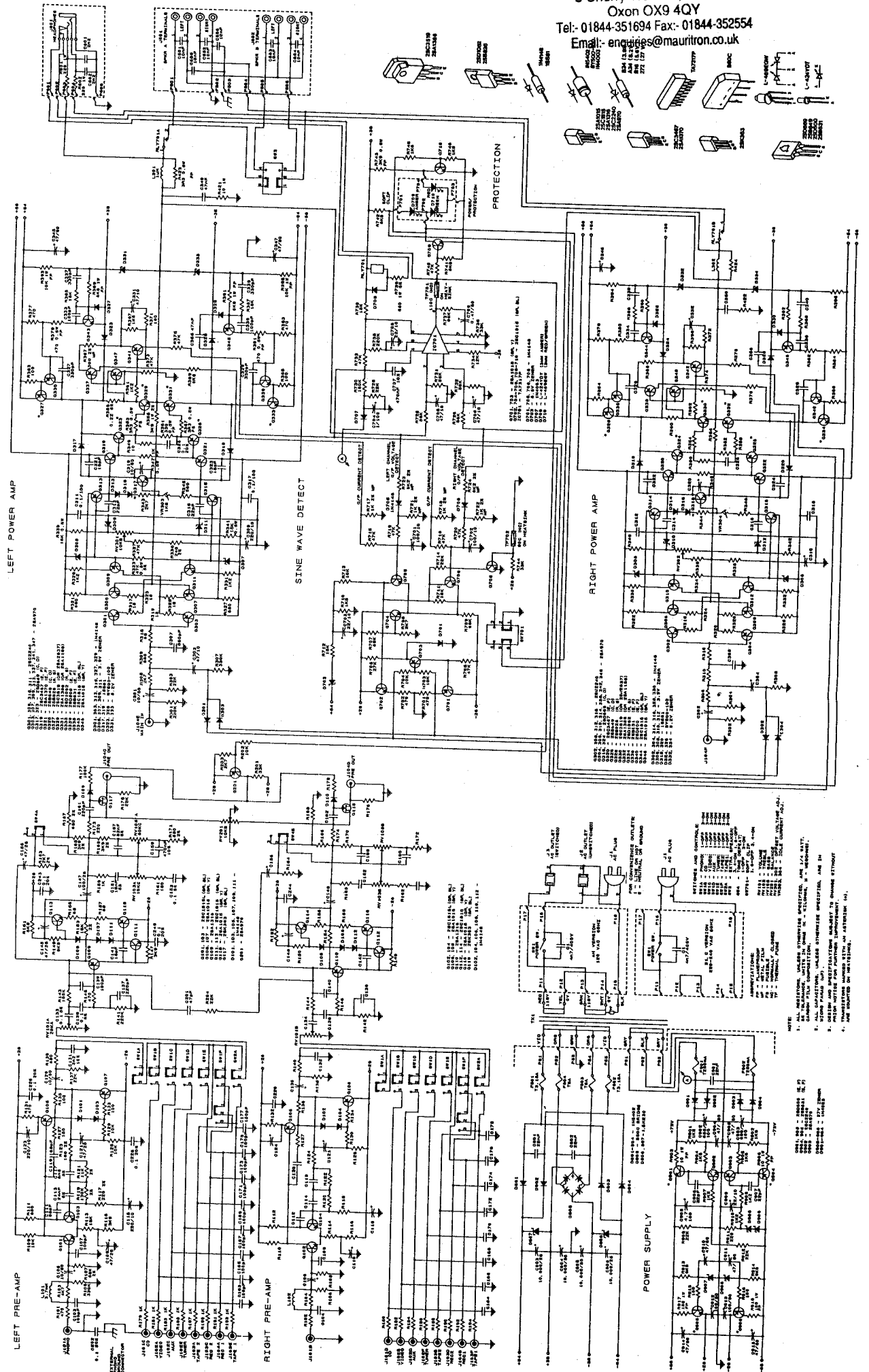

PCB LAY-OUT

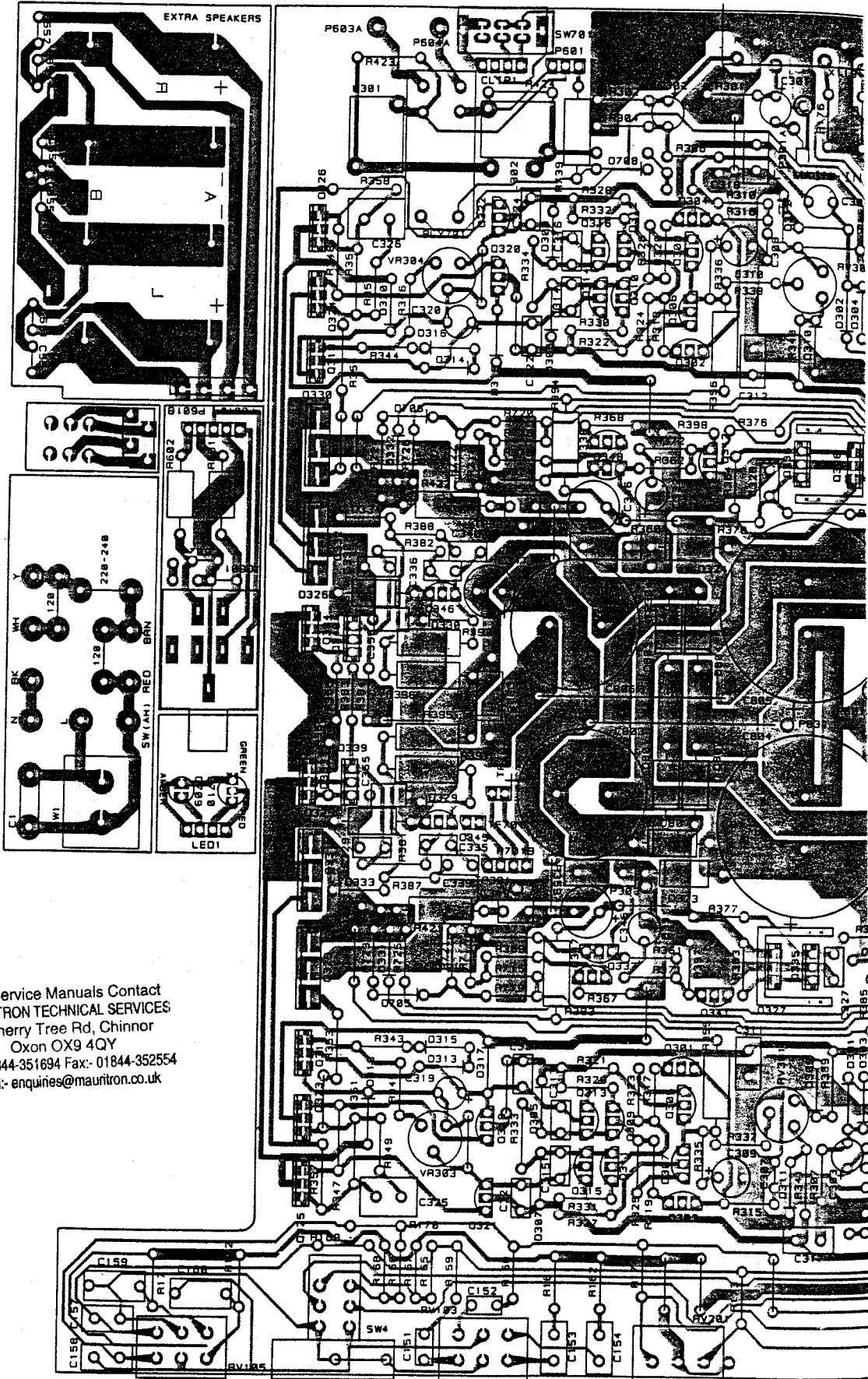

For Service Manuals Contact
MAURITRON TECHNICAL SERVICES
8 Cherry Tree Rd, Chinnor
Oxon OX9 4QY
Tel:- 01844-351694 Fax:- 01844-352554
Email:- enquiries@mauritron.co.uk

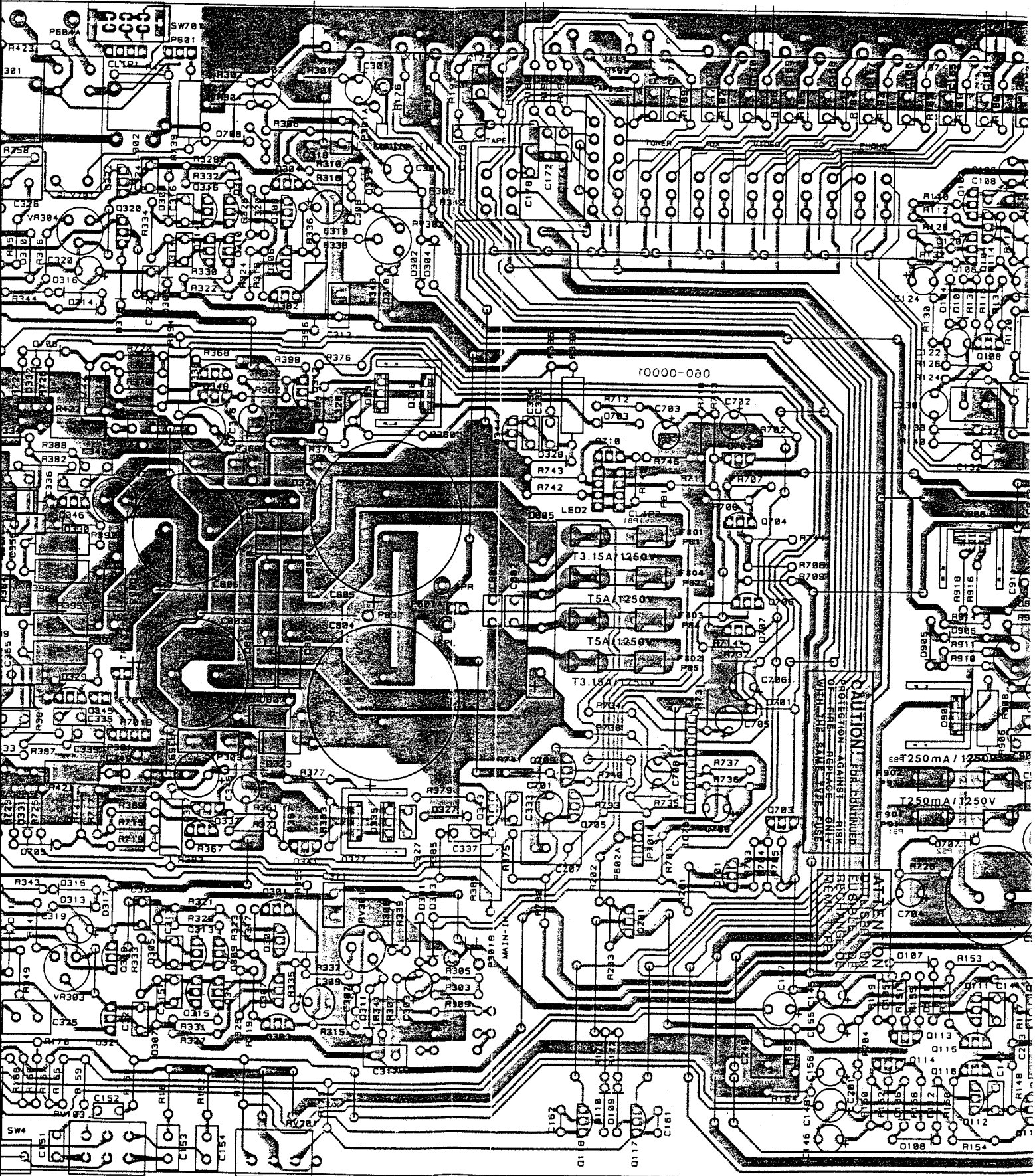

CAUTION! FOR CONTAINER
PROTECTION - AGAINST RISK
OF FIRE - REFRIGERANT ONLY
NEVER RECHARGE OR
WASH THE SAULT VALVE - FUSE

ATTENTION
NE PAS RECHARGER
NI LAVER LA VANNETTE
SANS LA PROTECTION
CONTRE LE FEU

68T250mA / 1250V
T250mA / 1250V

68T250mA / 1250V
T250mA / 1250V

68T250mA / 1250V
T250mA / 1250V

68T250mA / 1250V
T250mA / 1250V

68T250mA / 1250V
T250mA / 1250V

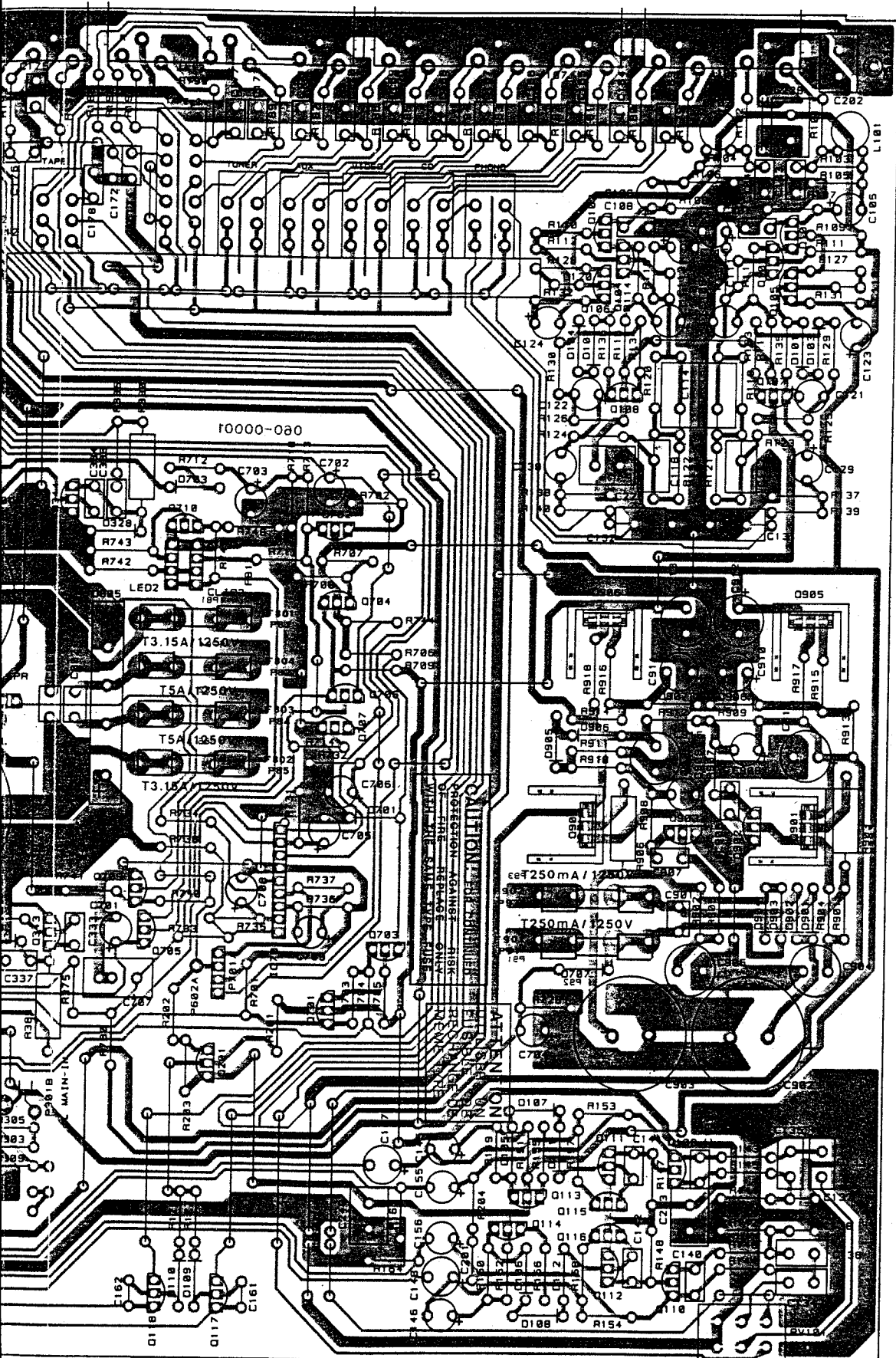

For Service Manuals Contact
MAURITRON TECHNICAL SERVICES
 8 Cherry Tree Rd, Chinnor
 Oxon OX9 4QY
 Tel: 01844-351694 Fax: 01844-352554
 Email: enquiries@mauritron.co.uk

PCB LAY-OUT

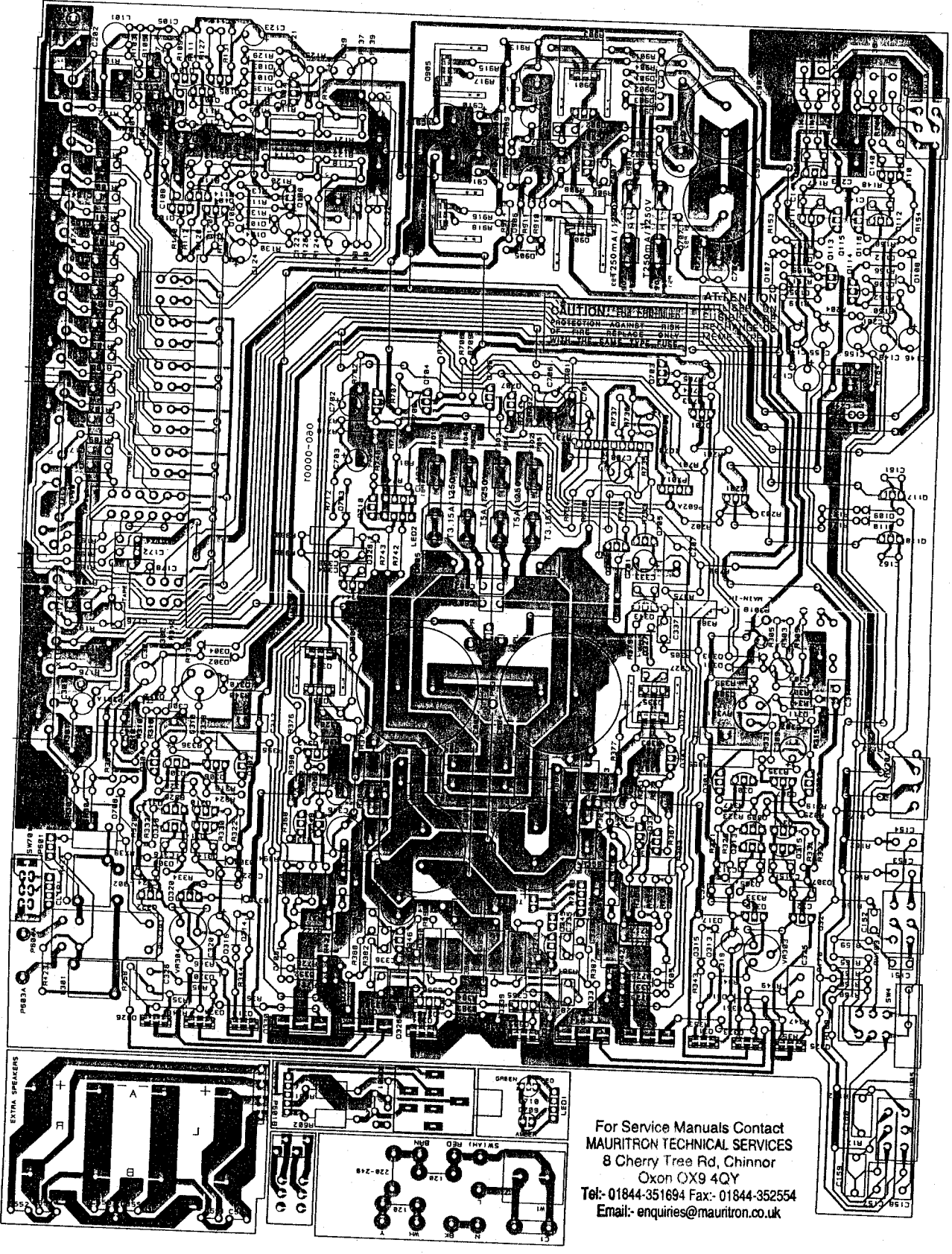

For Service Manuals Contact
MAURITRON TECHNICAL SERVICES
8 Cherry Tree Rd, Chinnor
Oxon OX9 4QY
Tel:- 01844-351694 Fax:- 01844-352554
Email:- enquiries@mauritron.co.uk

For Service Manuals Contact
MAURITRON TECHNICAL SERVICES
8 Cherry Tree Rd, Chinnor
Oxon OX9 4QY
Tel:- 01844-351694 Fax:- 01844-352554
Email:- enquiries@mauritron.co.uk

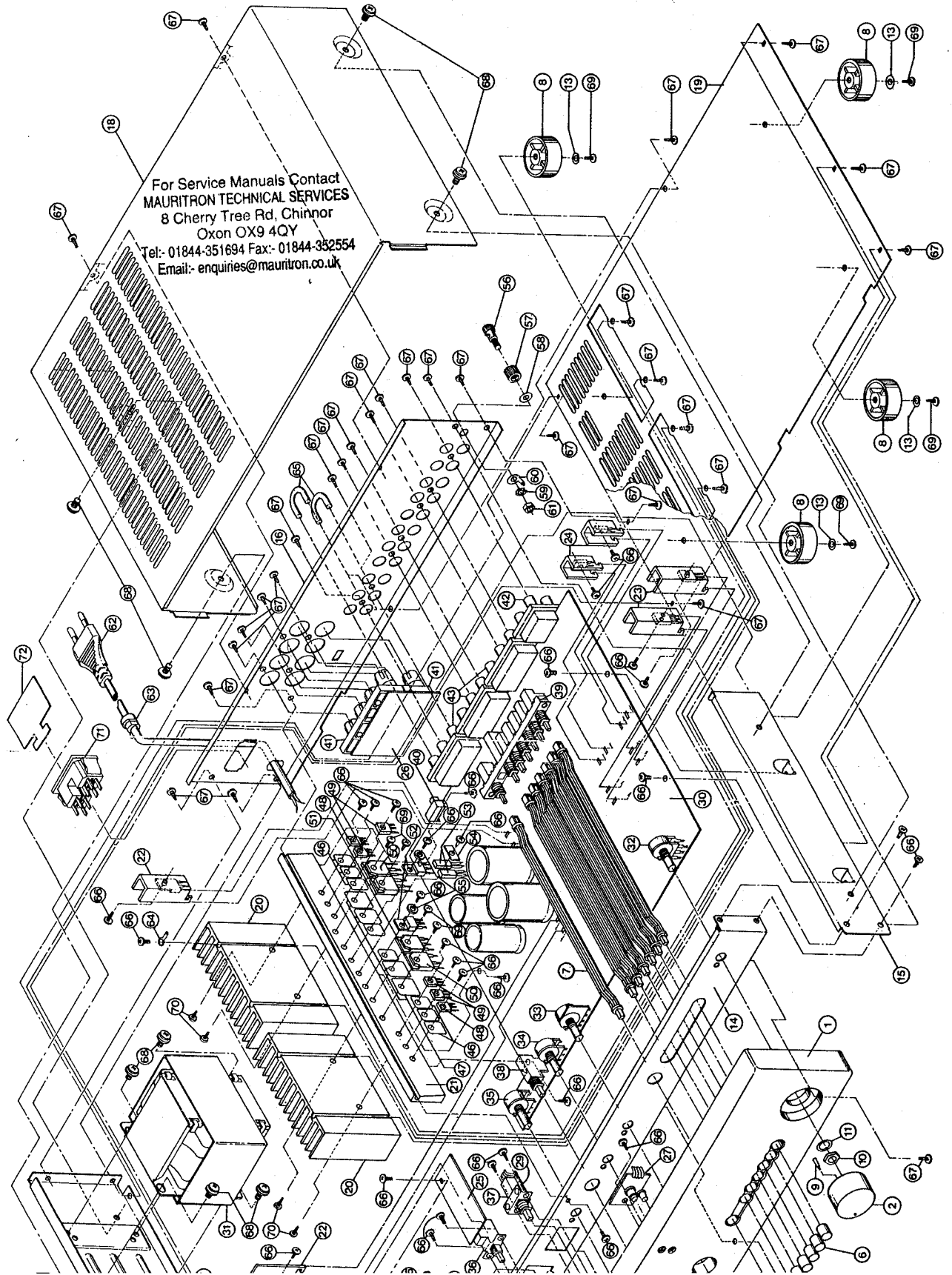

VIEW

EXPLODED VIEW PARTS LIST (CONTINUATION)

ITEM	PART NUMBER	DESCRIPTION	QTY/UNIT
48	042-2SB649	See page 18 Q325, Q324	2 pcs
49	042-2SD669	See page 18 Q317, Q318, Q323, Q324	4 pcs
50	042-2SC3519	See page 18 Q329, Q330	2 pcs
51	042-2SA1386	See page 18 Q331, Q332	2 pcs
52	042-2SD1062R	See page 18 Q333, Q334	2 pcs
53	081-00006/7	See page 18 TF701, TF702	2 pcs
54	101-00008	Thermal Switch Clip	1 pc
55	140-00010	Transistor Bushing	2 pcs
56	082-00010A	Stud (Part of Thumb Screw 082-00010)	1 pc
57	082-00010B	Bushing (Part of Thumb Screw 082-00010)	1 pc
58	082-00010C	Washer (Part of Thumb Screw 082-00010)	1 pc
59	082-00010D	External Tooth Washer (Part of Thumb Screw 082-00010)	1 pc
60	082-00010E	Solder Lug (Part of Thumb Screw 082-00010)	1 pc
61	082-00010F	Nut 3.0mm (Part of Thumb Screw 082-00010)	1 pc
62 * AH	082-00004	See page 19 J1 * AH	1 pc
62 * C	082-00005	See page 19 J1 * C	1 pc
62 * B1	082-00006	See page 19 J1 * B1	1 pc
63	140-00006	Strain Relief	1 pc
64	133-00307	Solder Lug 3x7mm	1 pc
65	103-00001	Shorting Bar (Pre Out/Main In)	2 pcs
66	131-41308	ST 3x8mm, Binding Head (Zinc)	34 pcs
67	131-42308	ST 3x8mm, Binding Head (Black)	32 pcs
68	135-12406	M 4x6mm, Panhead (Black) w/built-in Washer	8 pcs
69	132-40308	M 3x8mm, Binding Head (Zinc)	8 pcs
70	131-11308	ST 3x8mm, 5.2 dia. Head (Panhead), Zinc	4 pcs
71	082-00001	See page 19 J2, J3	1 pc
72	066-00001	AC Outlet Cover Plate (AH Only)	1 pc

For Service Manuals Contact
MAURITRON TECHNICAL SERVICES
 8 Cherry Tree Rd, Chinnor
 Oxon OX9 4QY
 Tel: 01844-351694 Fax: 01844-352554
 Email: enquiries@mauritron.co.uk

ELECTRICAL PARTS LIST

For Service Manuals Contact
MAURITRON TECHNICAL SERVICES
 8 Cherry Tree Rd, Chinnor
 Oxon OX9 4QY
 Tel:- 01844-351694 Fax:- 01844-352554
 Email:- enquiries@mauritron.co.uk

SYMBOL NUMBER	REFERENCE NUMBER	PART NUMBER	DESCRIPTION			
RESISTORS						
R349, R350	011-29010	011-29010	10	0.25W	±5%	Carbon Film Resistor
R317, R318, R319, R320, R323, R324, R325, R326	011-29018	011-29018	18	0.25W	±5%	Carbon Film Resistor
R155, R156, R157, R158, R315, R316	011-29068	011-29068	68	0.25W	±5%	Carbon Film Resistor
R133, R134, R135, R136, R363, R364, R365, R366, R915, R916	011-29110	011-29110	100	0.25W	±5%	Carbon Film Resistor
R127, R128	011-29115	011-29115	150	0.25W	±5%	Carbon Film Resistor
R161, R162, R371, R372	011-29118	011-29118	180	0.25W	±5%	Carbon Film Resistor
R173, R174, R911	011-29122	011-29122	220	0.25W	±5%	Carbon Film Resistor
R101, R102, R131, R132, R145, R146, R377, R378, R383, R384, R701, R702	011-29147	011-29147	470	0.25W	±5%	Carbon Film Resistor
R345, R346	011-29156	011-29156	560	0.25W	±5%	Carbon Film Resistor
R111, R112, R139, R140, R309, R310, R321, R322, R327, R328	011-29168	011-29168	680	0.25W	±5%	Carbon Film Resistor
R159, R160, R179, R180, R181, R182, R183, R184, R185, R186, R187, R188, R189, R190, R191, R192, R193, R194	011-29210	011-29210	1K	0.25W	±5%	Carbon Film Resistor
R329, R330, R331, R332, R361, R362, R907, R908, R910	011-29212	011-29212	1K2	0.25W	±5%	Carbon Film Resistor
R397, R398, R710, R745, R746, R901, R902, R904, R905	011-29215	011-29215	1K5	0.25W	±5%	Carbon Film Resistor
R203, R305, R306, R343, R344, R708	011-29227	011-29227	2K7	0.25W	±5%	Carbon Film Resistor
R115, R116, R147, R148	011-29239	011-29239	3K9	0.25W	±5%	Carbon Film Resistor
R103, R104	011-29247	011-29247	4K7	0.25W	±5%	Carbon Film Resistor
R149, R150, R151, R152, R369, R370, R741, R742, R913, R914	011-29268	011-29268	6K8	0.25W	±5%	Carbon Film Resistor
R109, R110, R125, R126, R129, R130, R202, R703, R704, R713	011-29310	011-29310	10K	0.25W	±5%	Carbon Film Resistor
R734	011-29312	011-29312	12K	0.25W	±5%	Carbon Film Resistor
R113, R114, R385, R386, R387, R388, R712, R738	011-29315	011-29315	15K	0.25W	±5%	Carbon Film Resistor
R711	011-29318	011-29318	18K	0.25W	±5%	Carbon Film Resistor
R137, R138, R175, R176, R204, R303, R304, R714, R728, R909, R912	011-29322	011-29322	22K	0.25W	±5%	Carbon Film Resistor
R706	011-29327	011-29327	27K	0.25W	±5%	Carbon Film Resistor
R201, R736, R744	011-29333	011-29333	33K	0.25W	±5%	Carbon Film Resistor
R337, R338, R373, R374, R375, R376, R705, R715, R716, R719, R720, R733, R740	011-29347	011-29347	47K	0.25W	±5%	Carbon Film Resistor
R725, R726, R731, R732, R737	011-29356	011-29356	56K	0.25W	±5%	Carbon Film Resistor
R707, R709	011-29368	011-29368	68K	0.25W	±5%	Carbon Film Resistor
R143, R144, R177, R178	011-29410	011-29410	100K	0.25W	±5%	Carbon Film Resistor
R730	011-29415	011-29415	150K	0.25W	±5%	Carbon Film Resistor
R141, R142, R301, R302, R735	011-29422	011-29422	220K	0.25W	±5%	Carbon Film Resistor
R105, R106, R307, R308	011-29433	011-29433	330K	0.25W	±5%	Carbon Film Resistor
R339, R340, R341, R342	011-39315	011-39315	15K	0.5W	±5%	Carbon Film Resistor
R333, R334	011-39347	011-39347	47K	0.5W	±5%	Carbon Film Resistor

ELECTRICAL PARTS LIST (CONTINUATION)

SYMBOL NUMBER	REFERENCE NUMBER	PART NUMBER	DESCRIPTION			
R739	011-49156	011-49156	560	1W	±5%	Carbon Film Resistor
R601, R602	011-49122	011-49122	220	1W	±5%	Carbon Film Resistor
R123, R124	012-29118	012-29118	180	0.25W	±2%	Metal Film Resistor
R117, R118	012-29122	012-29122	220	0.25W	±2%	Metal Film Resistor
R335, R336	012-29124	012-29124	240	0.25W	±2%	Metal Film Resistor
R367, R368	012-29130	012-29130	300	0.25W	±2%	Metal Film Resistor
R167, R168, R171, R172	012-29168	012-29168	680	0.25W	±2%	Metal Film Resistor
R717, R718, R721, R722	012-29210	012-29210	1K	0.25W	±2%	Metal Film Resistor
R163, R164	012-29227	012-29227	2K7	0.25W	±2%	Metal Film Resistor
R165, R166, R169, R170	012-29239	012-29239	3K9	0.25W	±2%	Metal Film Resistor
R723, R724	012-29262	012-29262	6K2	0.25W	±2%	Metal Film Resistor
R121, R122	012-29311	012-29311	11K	0.25W	±2%	Metal Film Resistor
R153, R154	012-29315	012-29315	15K	0.25W	±2%	Metal Film Resistor
R107, R108	012-29356	012-29356	56K	0.25W	±2%	Metal Film Resistor
R119, R120	012-29413	012-29413	130K	0.25W	±2%	Metal Film Resistor
R355, R356	012-49239	012-49239	3K9	1W	±2%	Metal Film Resistor
R423, R424	013-38233	013-38233	3R3	0.5W	±5%	Flame Proof Resistor
R351, R352	013-39133	013-39133	330	0.5W	±5%	Flame Proof Resistor
R379, R380, R381, R382	013-39147	013-39147	470	0.5W	±5%	Flame Proof Resistor
R347, R348	013-39210	013-39210	1K	0.5W	±5%	Flame Proof Resistor
R743	013-39239	013-39239	3K9	0.5W	±5%	Flame Proof Resistor
R903, R906	013-49010	013-49010	10	1W	±5%	Flame Proof Resistor
R917, R918	013-49118	013-49118	180	1W	±5%	Flame Proof Resistor
R389, R390, R391, R392	013-49268	013-49268	6K8	1W	±5%	Flame Proof Resistor
R393, R394, R395, R396	013-49310	013-49310	10K	1W	±5%	Flame Proof Resistor
R353, R354, R357, R358	014-48233	014-48233	3R3	1W	±5%	Fusible Resistor
R421, R422	014-49010	014-49010	10	1W	±5%	Fusible Resistor
R359, R360	015-58122	015-58122	0.22	2W	±5%	Wirewound Ceramic Resistor
CAPACITORS						
C141, C142, C321, C322, C323, C324	022-47015M	022-47015M	15pF	500V		Ceramic Disk Capacitor
C313, C314, C315, C316, C906, C907	022-47022M	022-47022M	22pF	500V		Ceramic Disk Capacitor
C201	021-77047M	021-77047M	47pF	50V		Ceramic Disk Capacitor
C111, C112	021-77056M	021-77056M	56pF	50V		Ceramic Disk Capacitor
C119, C120	021-77068M	021-77068M	68pF	50V		Ceramic Disk Capacitor
C103, C104, C107, C108, C139	021-77110M	021-77110M	100pF	50V		Ceramic Disk Capacitor
C140, C163, C164, C165, C166, C167, C168, C169, C170, C171, C172, C173, C174, C175, C176, C177, C178						
C333, C334, C335, C336	022-47110M	022-47110M	100pF	500V		Ceramic Disk Capacitor
C137, C138, C161, C162	021-77122M	021-77122M	220pF	50V		Ceramic Disk Capacitor
C327, C328, C329, C330, C337, C338, C339, C340	022-47133M	022-47133M	330pF	500V		Ceramic Disk Capacitor
C307, C308	021-77156M	021-77156M	560pF	50V		Ceramic Disk Capacitor
C601, C602	021-77222M	021-77222M	2.2nF	50V		Ceramic Disk Capacitor
C551, C552, C553, C554, C555, C556	022-08010M	022-08010M	10nF	100V		Ceramic Disk Capacitor
C1	022-37247M	022-37247M	4.7nF	400V		UL, CSA, VDE Ceramic Disk Capacitor
C151, C152	023-78018J	023-78018J	18nF	50V	±5%	Polyester Film Capacitor
C801, C802, C901	024-28022M	024-28022M	22nF	250V	±20%	Polyester Film Capacitor

ELECTRICAL PARTS LIST (CONTINUATION)

SYMBOL NUMBER	REFERENCE NUMBER	PART NUMBER	DESCRIPTION
C349, C350, C355, C356	024-08047M	024-08047M	47nF 100V ±20% Polyester Film Capacitor
C157, C158	023-78082J	023-78082J	82nF 50V ±5% Polyester Film Capacitor
C133, C134, C135, C136, C153, C154	023-78110J	023-78110J	100nF 50V ±5% Polyester Film Capacitor
C202, C225, C228, C243, C249, C325, C326	023-78110M	023-78110M	100nF 50V ±20% Polyester Film Capacitor
C311, C312, C317, C318	024-08110M	024-08110M	100nF 100V ±20% Polyester Film Capacitor
C159, C160, C707	023-78147K	023-78147K	470nF 50V ±10% Polyester Film Capacitor
C131, C132	025-77222K	025-77222K	2.2nF 50V ±10% Polypropylene Film Capacitor
C117, C118	025-77268J	025-77268J	6.8nF 50V ±5% Polypropylene Film Capacitor
C113, C114	025-78024J	025-78024J	24nF 50V ±5% Polypropylene Film Capacitor
C709	027-78147M	027-78147M	0.47uF 50V Electrolytic Capacitor
C704	028-08210M	028-08210M	1uF 100V Electrolytic Capacitor
C908	028-08247M	028-08247M	4.7uF 100V Electrolytic Capacitor
C105, C106, C129, C130, C301, C302, C319, C320	027-79010M	027-79010M	10uF 50V Electrolytic Capacitor
C703, C708, C909	027-29022M	027-29022M	22uF 10V Electrolytic Capacitor
C303, C304, C331, C332, C705, C706	027-29047M	027-29047M	47uF 10V Electrolytic Capacitor
C109, C110, C121, C122, C145, C146, C155, C156	027-59047M	027-59047M	47uF 25V Electrolytic Capacitor
C345, C346, C347, C904, C905, C910, C911, C914, C915	027-99047M	027-99047M	47uF 80V Electrolytic Capacitor
C701, C702	027-29110M	027-29110M	100uF 10V Electrolytic Capacitor
C147, C148	027-59110M	027-59110M	100uF 25V Electrolytic Capacitor
C912, C913	027-79110M	027-79110M	100uF 50V Electrolytic Capacitor
C115, C116, C123, C124, C309, C310	027-29122M	027-29122M	220uF 10V Electrolytic Capacitor
C902, C903	028-09168M	028-09168M	680uF 100V Electrolytic Capacitor
C803, C806	027-59310M	027-59310M	10000uF 25V Electrolytic Capacitor
C804, C805	027-79310M	027-79310M	10000uF 50V Electrolytic Capacitor
DIODES			
D101, D102, D103, D104, D105, D106, D107, D108, D109, D110, D111, D112, D301, D302, D303, D304, D313, D314, D315, D316, D327, D328, D329, D330, D701, D705, D706, D708	1N4148	031-1N4148	1N4148 Signal Diode
D707, D901, D902, D903, D904	1N4003	032-1N4003	1N4003 Power Diode
D801, D802, D803, D804	1N5402	032-1N5402	1N5402 Power Diode
D317, D318, D319, D320	1SS81	031-1SS81	1SS81 Signal Diode
D323, D324, D325, D326	BY500-100	032-BY500100	BY500-100 (G.I.) Power Diode
D805	B80C	035-B80C	100 PIV 5A (G.I. B80C) Bridge
D305, D306, D307, D308, D309, D310, D311, D312	B24	033-B24	B24, 3V9, 0.4W Zener Diode
D703	B1G	033-B1G	B1G, 5V6, 0.4W Zener Diode
D331, D332, D333, D334	A29	033-A29	A29, 8V2, 0.4W Zener Diode
D905, D906, D907, D908	27Z	033-27Z	27Z, 27V, 0.4W Zener Diode
D806, D807	1.5KE30	033-1.5KE30	1.5KE30 Transient Voltage Suppressor
D709	L-424YDT	034-L424YDT	3mm AMBER LED (L-424YDT)
D710	L-469EGW	034-L469EGW	3mm RED/GREEN LED (L-469EGW)

ELECTRICAL PARTS LIST (CONTINUATION)

For Service Manuals Contact
MAURITRON TECHNICAL SERVICES
 8 Cherry Tree Rd, Chinnor
 Oxon OX9 4QY
 Tel: 01844-351694 Fax: 01844-352554
 Email: enquiries@mauritron.co.uk

SYMBOL NUMBER	REFERENCE NUMBER	PART NUMBER	DESCRIPTION
TRANSISTORS			
Q201, Q303, Q304, Q307, Q308, Q309, Q310, Q313, Q314, Q337, Q338, Q341, Q342, Q347, Q348, Q903	2SA970 GR	041-2SA970 GR	2SA970 GR Toshiba Signal Transistor
Q105, Q106, Q107, Q108, Q115, Q116, Q345, Q346, Q701, Q703 Q109, Q110	2SA1015 GR	041-2SA1015 GR	2SA1015 GR Toshiba Signal Transistor
Q321, Q322	2SA1316 BL	041-2SA1316 BL	2SA1316 BL Toshiba Signal Transistor
Q331, Q332	2SA1370 E	041-2SA1370 E	2SA1370 E Sanyo Signal Transistor
Q335, Q336, Q904, Q906	2SA1386	042-2SA1386	2SA1386 Sanken Power Transistor
Q325, Q326	2SB631 E	042-2SB631 E	2SB631 E Sanyo Power Transistor
Q327, Q328	2SB649	042-2SB649	2SB649 Hitachi Power Transistor
Q111, Q112, Q113, Q114, Q343, Q344, Q702, Q704, Q705, Q706, Q708, Q709, Q710	2SB826 R	042-2SB826 R	2SB826 R Sanyo Power Transistor
Q101, Q102, Q103, Q104	2SC1815 GR	041-2SC1815 GR	2SC1815 GR Toshiba Signal Transistor
Q301, Q302, Q305, Q306, Q311, Q312, Q315, Q316, Q902	2SC1815 LGR	041-2SC1815 LGR	2SC1815 LGR Toshiba Signal Transistor
Q319, Q320	2SC2240 GR	041-2SC2240 GR	2SC2240 GR Toshiba Signal Transistor
Q329, Q330	2SC3467 E	041-2SC3467 E	2SC3467 E Sanyo Signal Transistor
Q339, Q340, Q901, Q905	2SC3519	042-2SC3519	2SC3519 Sanken Power Transistor
Q317, Q318, Q323, Q324	2SD600 E	042-2SD600 E	2SD600 E Sanyo Power Transistor
Q333, Q334	2SD669	042-2SD669	2SD669 Hitachi Power Transistor
Q117, Q118	2SD1062 R	042-2SD1062 R	2SD1062 R Sanyo Power Transistor
	2SK363 BL	043-2SK363 BL	2SK363 BL Toshiba FET
IC			
IC701	TA7317 P	051-TA7317 P	TA7317 P Toshiba (Prot) IC
POTENTIOMETERS			
VR303, VR304	071-29210	071-29210	1KB Trimmer Pot ALPS RH1051C, Idle Current Adj.
RV301, RV302	071-29310	071-29310	10KB Trimmer Pot ALPS RH1051C, DC Offset Voltage Adj.
RV103	073-39310	073-39310	2x10KC ALPS RK16312, Treble Pot.
RV201	075-49310	075-49310	1x10KW ALPS RK16311, Balance Pot.
RV101	072-19320	072-19320	2x20KA ALPS RK16312, Volume Pot.
RV105	073-39350	073-39350	2x50KC ALPS RK16312, Bass Pot.
SWITCHES			
SW1A-F/SW2A	081-00001	081-00001	7Key ALPS SPUN, Input Select Switch
SW1	081-00002	081-00002	1P1T w/o Screw Tap SMK JU-3066 or ALPS SDDL B, Power Switch
SW3	081-00003	081-00003	2P2T ALPS SPUN, 1A, 24V, w/o Screw Tap, Extra Spkr. Switch
SW4	081-00004	081-00004	2P2T ALPS SPUN w/o Frame, Tone Defeat Switch
SW701	081-00005	081-00005	2P2T Highly HSK-2210, Soft Clip Switch
TF701	081-00006	081-00006	110C NC Uchiya UP-62, Thermal Switch
TF702	081-00007	081-00007	90C NC Uchiya UP-62, Thermal Switch

ELECTRICAL PARTS LIST (CONTINUATION)

SYMBOL NUMBER	REFERENCE NUMBER	PART NUMBER	DESCRIPTION
JACKS			
J101	082-00002	082-00002	4P Gold RJ-1019-020AG, RCA Jack; Phono, CD
J102, J103, J104	082-00003	082-00003	6P Standard RJ-1017-02, RCA Jack; Video, Aux, Tuner, Tape 2 In/Out, Tape 1 In/Out, Pre Out, Main In
J601	082-00008	082-00008	JYE TAI JY-6312, Headphone Jack
FUSES			
F803, F804 * AH	084-00001	084-00001	5A, UL/CSA GTE, AH Only
F803, F804 * C & B1	084-00002	084-00002	5A, HBC, C & B1 Only
F801, F802 * AH	084-00003	084-00003	3.15A, UL/CSA, AH Only
F801, F802 * C & B1	084-00004	084-00004	3.15A, HBC, C & B1 Only
F901, F902 * AH	084-00005	084-00005	250mA, UL/CSA GTE, AH Only
F901, F902 * C & B1	084-00006	084-00006	250mA, HBC, C & B1 Only
OTHERS			
J2, J3	082-00001	082-00001	AC Outlet (AH Only)
J501, J502	082-00007	082-00007	Speaker Terminal Block, Nanjing
	082-00009	082-00009	Fuse Holder CQ-203S CQ
RLY701	083-00001	083-00001	Spkr Relay 2P1T Taiko DGX2-24M
L101, L102	091-20001	091-20001	3.7mH Toroid Coil
L301, L302	091-10002	091-10002	1 uH Air Cored Coil
TX1	092-10001	092-10001	Power Transformer
J1 * AH	082-00004	082-00004	AC Cord, AH Only
J1 * C	082-00005	082-00005	AC Cord, C Only
J1 * B1	082-00006	082-00006	AC Cord, B1 Only

For Service Manuals Contact
MAURITRON TECHNICAL SERVICES
 8 Cherry Tree Rd, Chinnor
 Oxon OX9 4QY
 Tel:- 01844-351694 Fax:- 01844-352554
 Email:- enquiries@mauritron.co.uk

SERVICE MANUAL

NAD

For Service Manuals Contact
MAURITRON TECHNICAL SERVICES
8 Cherry Tree Rd, Chinnor
Oxon OX9 4QY
Tel:- 01844-351694 Fax:- 01844-352554
Email:- enquiries@mauritron.co.uk

304

INTEGRATED
AMPLIFIER

304

INTEGRATED
AMPLIFIER

TABLE OF CONTENTS

SPECIFICATIONS	3-4
REAR PANEL CONNECTIONS	5
FRONT PANEL FUNCTIONS	6
ALIGNMENT PROCEDURE	7
EXPLODED VIEW PARTS LIST	8 and 13
WIRING DIAGRAM	9
SCHEMATIC DIAGRAM	10
PCB LAY-OUT	11
EXPLODED VIEW	12
ELECTRICAL PARTS LIST	14-18
PACKING DIAGRAM	19

SERVICE SAFETY PRECAUTIONS

For Service Manuals Contact
MAURITRON TECHNICAL SERVICES
8 Cherry Tree Rd, Chinnor
Oxon OX9 4QY
Tel:- 01844-351694 Fax:- 01844-352554
Email:- enquiries@mauritron.co.uk

1. Use exact replacement parts for critical locations, marked "  " on parts list.
2. Return lead dress to original position, and re-install protective covers.
3. Before returning to customer, test for shock hazard; use either method A or B:
 - A. Leakage test, "cold":**
 1. Unplug AC cord, turn power switch ON.
 2. Connect one lead of High Voltage Insulation Tester to both prongs of AC plug.
 3. Touch other lead to all exposed metal parts.
 4. Impedance measurement must be 0.3 – 5.0 Megohms.
 - B. Leakage test, "live":**
 1. Plug unit directly into AC outlet; do not use isolation transformer.
 2. Connect one lead of Leakage Current Tester to earth ground.
 3. Touch other lead to all exposed metal parts.
 4. Leakage measurement must be less than 0.5 milliamps.

SPECIFICATIONS

POWER AMPLIFIER SECTION STEREO MODE

**CONTINUOUS AVERAGE POWER
OUTPUT INTO 8 OHMS** **35 W (15.5 dBW)**

(Min. power per channel, 20 Hz – 20 kHz, both channels driven, with no more than rated distortion)

Rated Distortion
(THD 20 Hz – 20 kHz) **0.03%**

Clipping power
(maximum continuous power per channel). **42 W**

IHF dynamic headroom at 8 ohms **+ 5.5 dB**

IHF dynamic power
(maximum short term power per channel)

8 ohms:	120 W (21 dBW)
4 ohms:	160 W (22 dBW)
2 ohms:	200 W (23 dBW)

Slew rate **> 20 V / μ sec**

Damping factor
(ref. 8 ohms 50 Hz) **> 100**

Input Impedance **R = 18 kohms
C = 560 pF**

For Service Manuals Contact
MAURITRON TECHNICAL SERVICES
8 Cherry Tree Rd, Chinnor
Oxon OX9 4QY
Tel: 01844-351694 Fax: 01844-352554
Email: enquiries@mauritron.co.uk

Input sensitivity (for rated output into 8 ohms) **1 V**

Voltage gain **x17 (24.6 dB)**

Frequency response 20 Hz – 20 kHz **\pm 0.3 dB
– 3 dB at 3 Hz / 70 kHz**

Signal / Noise ratio, A-weighted **102 dB ref. 1 W
117 dB ref. 35 W**

THD
(Total Harmonic Distortion, 20 Hz – 20 kHz,
from 250 mW to rated output) **< 0.03%**

SMPTE I.M.
(Intermodulation Distortion, 60 Hz + 7 kHz, 4:1,
from 250 mW to rated output) **< 0.03%**

IHF I.M.
(CCIF IM Distortion, 19 + 20 kHz at rated output) **< 0.03%**

PREAMPLIFIER SECTION

PHONO INPUT

Input impedance (R and C)	MM: 47 kohms + 200 pF
Input sensitivity (ref. rated power, 1 kHz)	MM: 2.5 mV
Input overload at 20 Hz / 1 kHz / 20 kHz	MM: 22 mV / 220 mV / 2.0V
THD (20 Hz – 20 kHz) and IM dist.	< 0.1% at +30 dB level
RIAA accuracy	± 0.5 dB
Signal / Noise ratio (A-weighted with cartridge connected)	MM: 77 dB ref. 5 mV

LINE LEVEL INPUTS

(CD, Video, Auxiliary, Tuner, Tape)

Input impedance (R and C)	20 kohms + 500 pF
Input sensitivity (ref. rated power)	165 mV
Maximum input signal	> 10V
Signal / Noise ratio, A-weighted	91 dB ref. 1 W 106 dB ref. rated power
Frequency response, 20 Hz – 20 kHz	+ 0/-0.3 dB (tone defeat) ± 0.5 dB (tone flat)
THD, SMPTE IM, IHF IM and TIM	< 0.01% at 5 V out

For Service Manuals Contact
MAURITRON TECHNICAL SERVICES
8 Cherry Tree Rd, Chinnor
Oxon OX9 4QY
Tel:- 01844-351694 Fax:- 01844-352554
Email:- enquiries@mauritron.co.uk

LINE LEVEL OUTPUTS

Preamp output impedance	220 ohms
Tape output impedance	Source Z + 2 kohms
Headphones output impedance	220 ohms
Maximum output level	preamp-out : > 12 V tape-out : > 10 V headphones-out : > 10 V into 600 ohms > 500 mV into 8 ohms

CONTROLS

Treble	± 7 dB at 10 kHz
Bass	± 10 dB at 50 Hz
Infrasonic filter (fixed)	- 3 dB at 10 Hz 12 dB / octave

REAR PANEL CONNECTIONS

1. AC LINE CORD
2. AC OUTLET (AH ONLY)
3. SPEAKER A TERMINAL
4. SPEAKER B TERMINAL
5. SOFT CLIPPING
6. PRE AMP OUT/MAIN IN
7. TAPE 1 INPUT/OUTPUT
8. TAPE 2 INPUT/OUTPUT
9. TUNER
10. AUXILIARY
11. VIDEO SOUND
12. CD
13. PHONO
14. PHONO GROUND

For Service Manuals Contact
MAURITRON TECHNICAL SERVICES
 8 Cherry Tree Rd, Chinnor
 Oxon OX9 4QY
 Tel:- 01844-351694 Fax:- 01844-352554
 Email:- enquiries@maurtron.co.uk

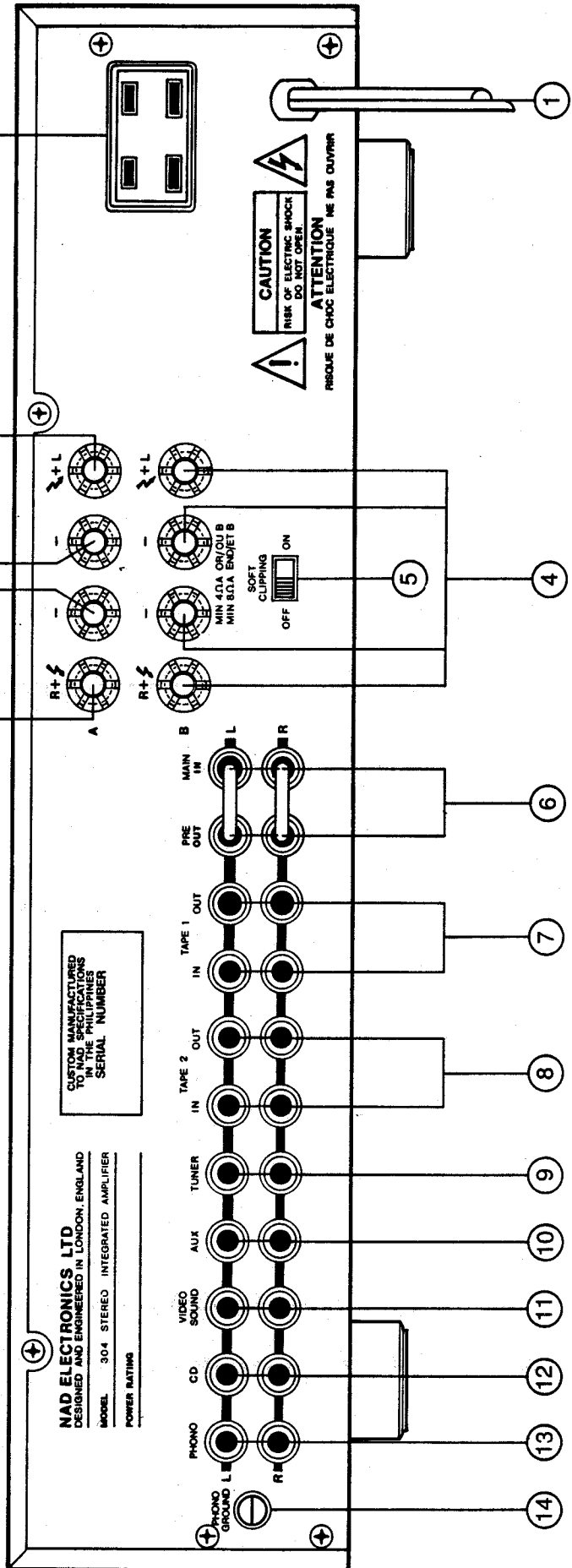

FRONT PANEL FUNCTIONS

- 15. PHONES
- 16. POWER
- 17. EXTRA SPEAKERS
- 18. BASS
- 19. TONE DEFEAT
- 20. TREBLE
- 21. BALANCE
- 22. SOFT CLIPPING INDICATOR
- 23. POWER INDICATOR
- 24. TAPE 1 MONITOR
- 25. INPUT SELECTOR
- 26. VOLUME

For Service Manuals Contact
MAURITRON TECHNICAL SERVICES
 8 Cherry Tree Rd, Chinnor
 Oxon OX9 4QY
 Tel:- 01844-351694 Fax:- 01844-352554
 Email:- enquiries@mauritron.co.uk

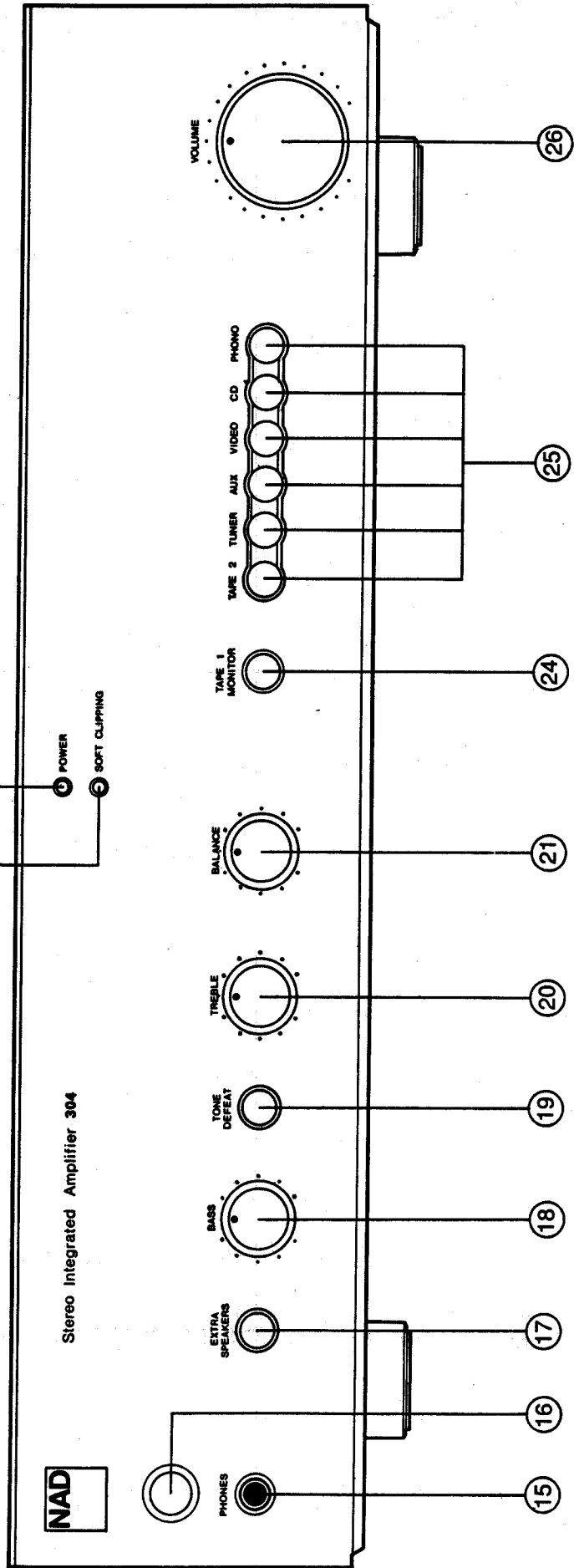

ALIGNMENT PROCEDURE

I. INITIAL ADJUSTMENT (No load connected)

A. OUTPUT OFFSET VOLTAGE

1. Connect a DC Millivoltmeter to L Channel speaker output terminals.
2. Turn unit "ON" and adjust RV301 (10 kohms) to get a reading of $0V \pm 10$ mV.
3. Connect the DC Millivoltmeter to R Channel speaker output terminals and adjust RV 302 (10 kohms) to get a reading of $0V \pm 10$ mV.

B. IDLING CURRENT

1. Connect a DC Millivoltmeter to TP301 and TP303 and adjust VR303 (1 kohms) for 5.7 – 6.4 mV reading on meter.
2. Connect the DC Millivoltmeter to TP302 and TP304 and adjust VR304 (1 kohms) for 5.7 – 6.4 mV reading on meter.
3. Leave power "ON" for minimum of 5 minutes.

For Service Manuals Contact
MAURITRON TECHNICAL SERVICES
8 Cherry Tree Rd, Chinnor
Oxon OX9 4QY
Tel:- 01844-351694 Fax:- 01844-352554
Email:- enquiries@mauritron.co.uk

II. FINAL ADJUSTMENT

Repeat procedure A and B for offset voltage and idling current alignment respectively.

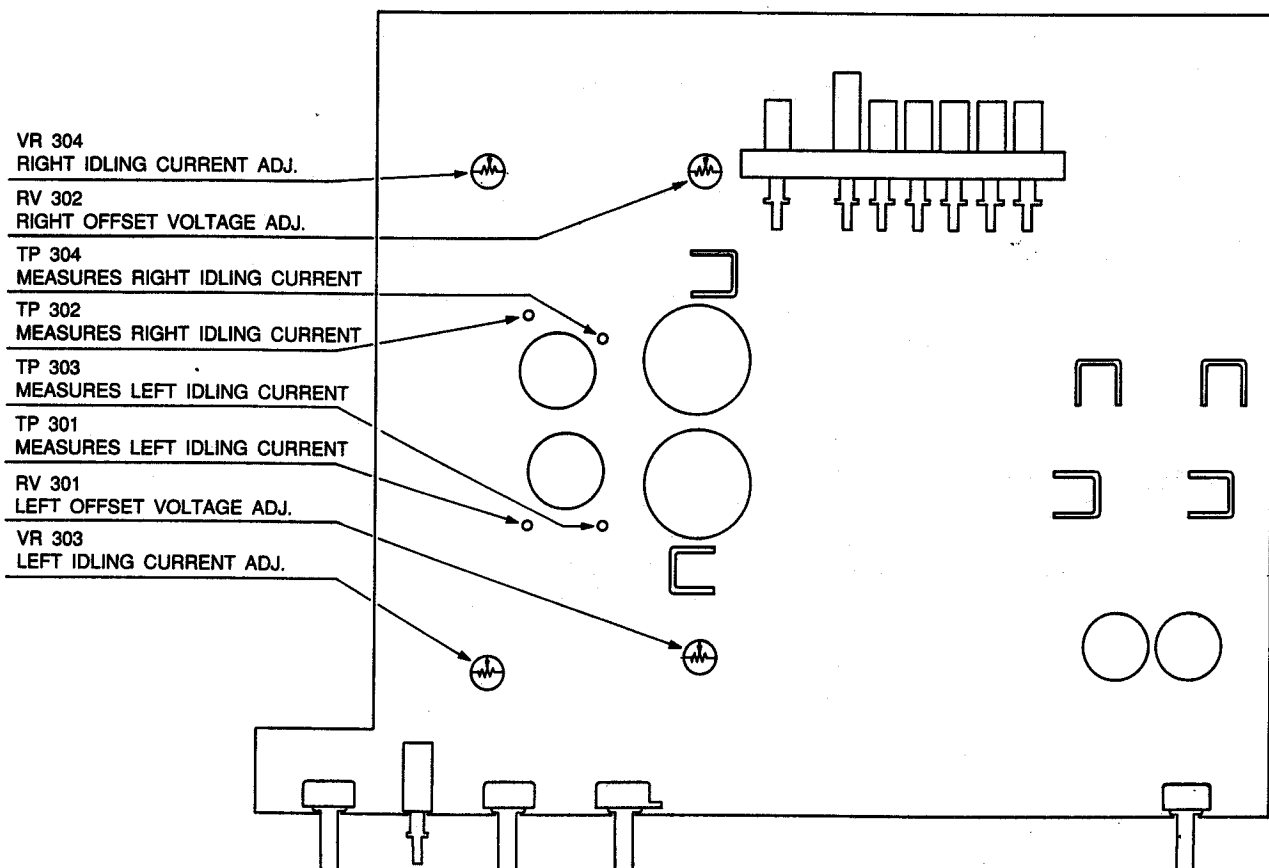

EXPLODED VIEW PARTS LIST

ITEM	PART NUMBER	DESCRIPTION	QTY/UNIT
1	061-00001	Fascia	1 pc
2	062-00001	Knob 35.0mm (Volume)	1 pc
3	062-00002	Knob 18.5mm (Bass, Treble, Balance)	3 pcs
4	062-00003	Long Button 9.5mm (Power)	1 pc
5	063-00002	Power Button Extender	1 pc
6	062-00004	Long Button 8.0mm (Input Select)	9 pcs
7	063-00001	Button Extender (Input Select)	7 pcs
8	064-00001	Plastic Foot	4 pcs
9	065-00001	Pointer	4 pcs
10	136-00650	Nut 6.5mm	4 pcs
11	134-00712	Washer 7x12mm	4 pcs
12	134-00315	Washer 3x15mm	1 pc
13	134-00307	Washer 3x7mm	4 pcs
14	101-00001	Subfascia	1 pc
15	101-00005	Right Side Panel	1 pc
16 * AH	101-00002	Rear Panel * AH only	1 pc
16 * C,B1	101-00003	Rear Panel * C & B1 only	1 pc
17	101-00004	Left Side Panel	1 pc
18	101-00006	Top Cover PVC Coated	1 pc
19	101-00007	Base	1 pc
20	102-00001	Heatsink Extrusion (NAD 001)	2 pcs
21	102-00002	Heatsink Mounting Bar Extrusion (NAD 002)	1 pc
22	102-00003	Commutation Transistor Heatsink A	2 pcs
23	102-00004	60V Regulator Transistor Heatsink B	2 pcs
24	102-00005	28V Regulator Transistor Heatsink C	2 pcs
25	060-00001A	Mains PCB Assy. (Part of PCB 060-00001)	1 pc
26	060-00001B	Speaker PCB Assy. (Part of PCB 060-00001)	1 pc
27	060-00001C	LED PCB Assy. (Part of PCB 060-00001)	1 pc
28	060-00001D	Headphone Assy. (Part of PCB 060-00001)	1 pc
29	060-00001E	Extra Spkr. Switch PCB Assy. (Part of PCB 060-00001)	1 pc
30	060-00001F	Amp. PCB Assy. (Part of PCB 060-00001)	1 pc
31	092-10001	See page 19 TX1	1 pc
32	072-19320	See page 18 RV101	1 pc
33	075-49310	See page 18 RV201	1 pc
34	073-39310	See page 18 RV103	1 pc
35	073-39350	See page 18 RV105	1 pc
36	081-00002	See page 18 SW1	1 pc
37	081-00003	See page 18 SW3	1 pc
38	081-00004	See page 18 SW4	1 pc
39	081-00001	See page 18 SW1A-F / SW2A	1 pc
40	081-00005	See page 18 SW701	1 pc
41	082-00007	See page 19 J501, J502	2 pcs
42	082-00002	See page 19 J101	1 pc
43	082-00003	See page 19 J102, J103, J104	3 pcs
44	082-00008	See page 19 J601	1 pc
45	140-00001	Sleeve, Big (D = 30mm, L = 77mm)	1 pc
46	140-00007	Silicone Sheet, Small	8 pcs
47	140-00008	Mica Insulator, Big	4 pcs

For Service Manuals Contact
MAURITRON TECHNICAL SERVICES
 8 Cherry Tree Rd, Chinnor
 Oxon OX9 4QY
 Tel:- 01844-351694 Fax:- 01844-352554
 Email:- enquiries@mauritron.co.uk

WIRING DIAGRAM

FOR C. & B1-VERSION

For Service Manuals Contact
MAURITRON TECHNICAL SERVICES
 8 Cherry Tree Rd, Chinnor
 Oxon OX9 4QY
 Tel:- 01844-351694 Fax:- 01844-352554
 Email:- enquiries@mauritron.co.uk

FOR A4 VERSION

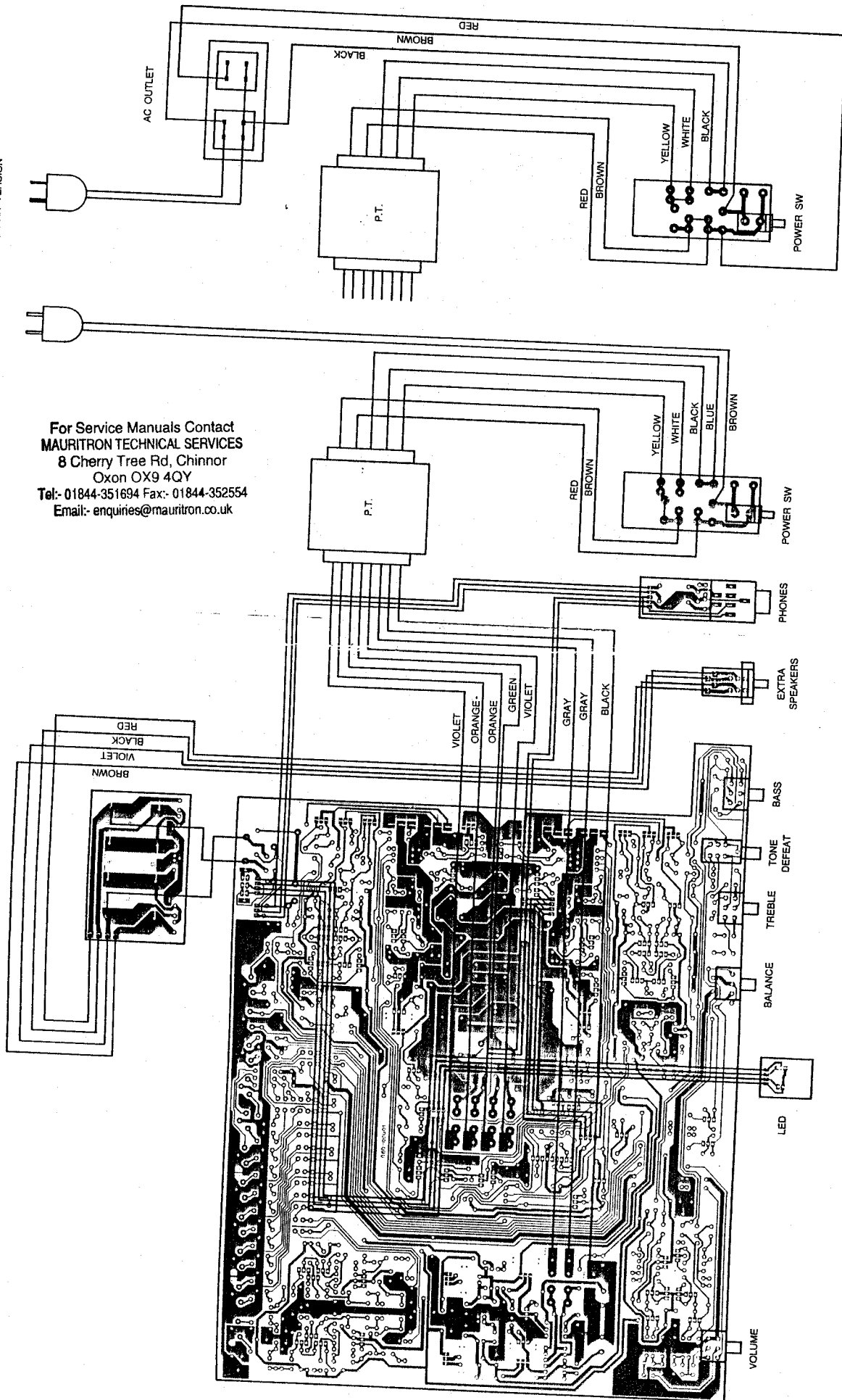

SCHEMATIC DIAGRAM

For Service Manuals Contact
MAURITRON TECHNICAL SERVICES
8 Cherry Tree Rd, Chinnor
Oxon OX9 4QY
Tel:- 01844-351694 Fax:- 01844-352554
Email:- enquiries@mauritron.co.uk

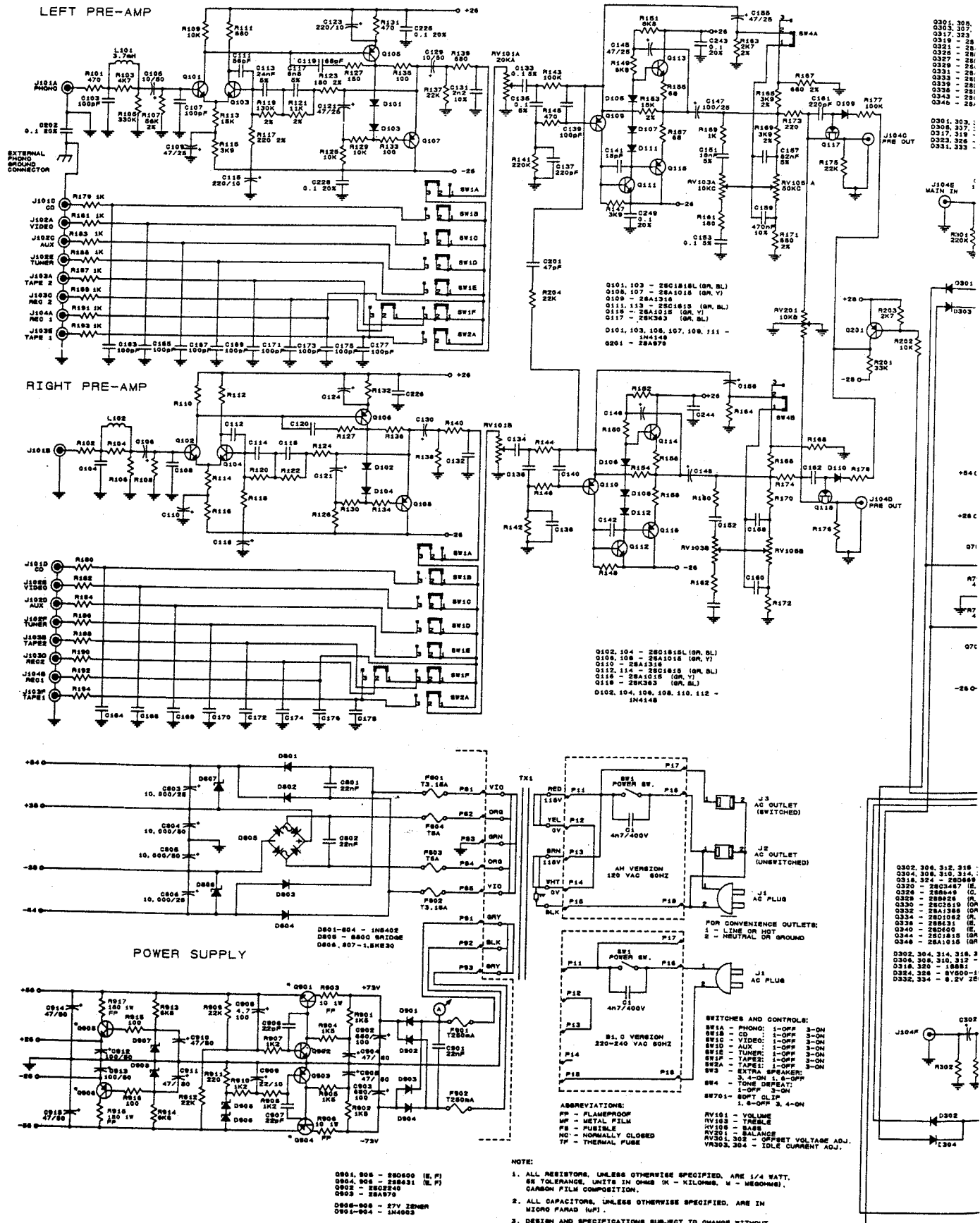

For Service Manuals Contact
MAURITRON TECHNICAL SERVICES
 8 Cherry Tree Rd, Chinnor
 Oxon OX9 4QY
 Tel: 01844-351694 Fax: 01844-352554
 Email: enquiries@mauritron.co.uk

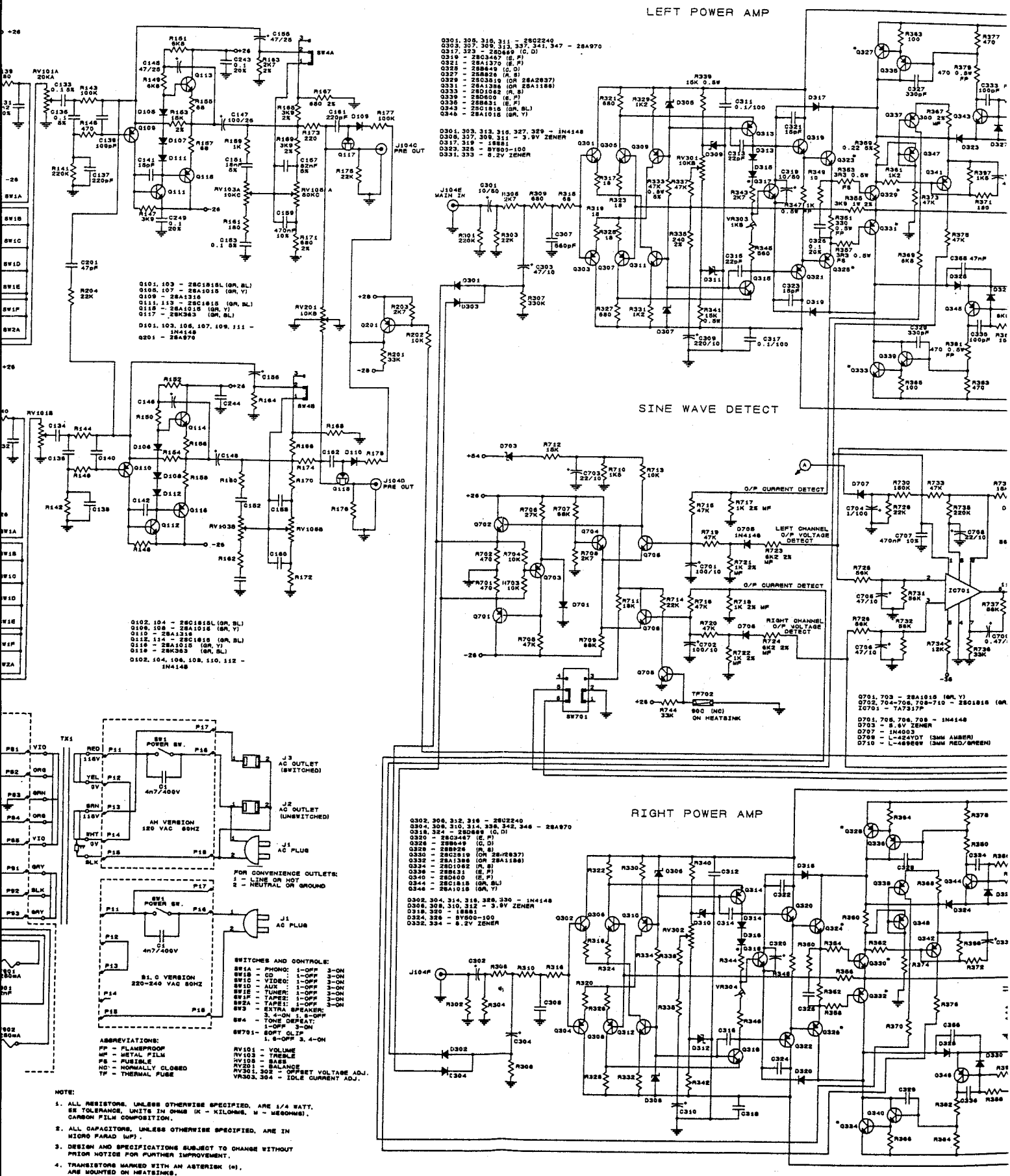

For Service Manuals Contact
MAURITRON TECHNICAL SERVICES
 8 Cherry Tree Rd, Chinnor
 Oxon OX9 4QY
 Tel: 01844-351694 Fax: 01844-352554
 Email: enquires@mauritron.co.uk

LEFT POWER AMP

SINE WAVE DETECT

PROTECTION

RIGHT POWER AMP

311 - 28C2240
 312, 317, 341, 347 - 28A970
 349 (C, D)
 350 (E, F)
 351 (G, H)
 352 (I, J)
 353 (K, L)
 354 (M, N)
 355 (O, P)
 356 (Q, R)
 357 (S, T)
 358 (U, V)
 359 (W, X)
 360 (Y, Z)

316, 327, 329 - 1N4148
 331 - 3.0V ZENER
 332 - 100
 333 - 2V ZENER

370 - 27K
 371 - 68K
 372 - 10K
 373 - 10K
 374 - 10K
 375 - 10K
 376 - 10K
 377 - 10K
 378 - 10K
 379 - 10K
 380 - 10K
 381 - 10K
 382 - 10K
 383 - 10K
 384 - 10K
 385 - 10K
 386 - 10K
 387 - 10K
 388 - 10K
 389 - 10K
 390 - 10K
 391 - 10K
 392 - 10K
 393 - 10K
 394 - 10K
 395 - 10K
 396 - 10K
 397 - 10K
 398 - 10K
 399 - 10K
 400 - 10K

302240
 342, 348 - 28A970
 349 (C, D)
 350 (E, F)
 351 (G, H)
 352 (I, J)
 353 (K, L)
 354 (M, N)
 355 (O, P)
 356 (Q, R)
 357 (S, T)
 358 (U, V)
 359 (W, X)
 360 (Y, Z)

330 - 1N4148
 3V ZENER

308
 310
 311
 312
 313
 314
 315
 316
 317
 318
 319
 320
 321
 322
 323
 324
 325
 326
 327
 328
 329
 330
 331
 332
 333
 334
 335
 336
 337
 338
 339
 340
 341
 342
 343
 344
 345
 346
 347
 348
 349
 350
 351
 352
 353
 354
 355
 356
 357
 358
 359
 360
 361
 362
 363
 364
 365
 366
 367
 368
 369
 370
 371
 372
 373
 374
 375
 376
 377
 378
 379
 380
 381
 382
 383
 384
 385
 386
 387
 388
 389
 390
 391
 392
 393
 394
 395
 396
 397
 398
 399
 400

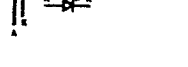
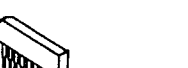
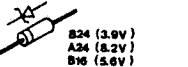
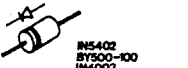
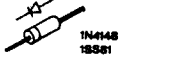
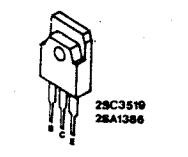
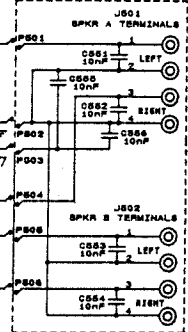
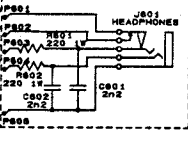

0701, 703 - 28A1015 (OR, V)
 0702, 704-706, 708-710 - 28G1815 (OR, M, L)
 0701 - TA7317P
 0701, 706, 708, 709 - 1N4148
 0703 - 8.6V ZENER
 0707 - 1N4003
 0709 - L-424YDT (3MM AMBER)
 0710 - L-488EQW (3MM RED/GREEN)

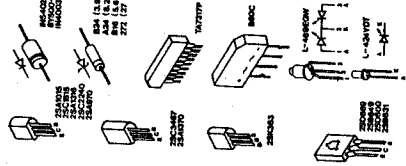

SCHEMATIC DIAGRAM

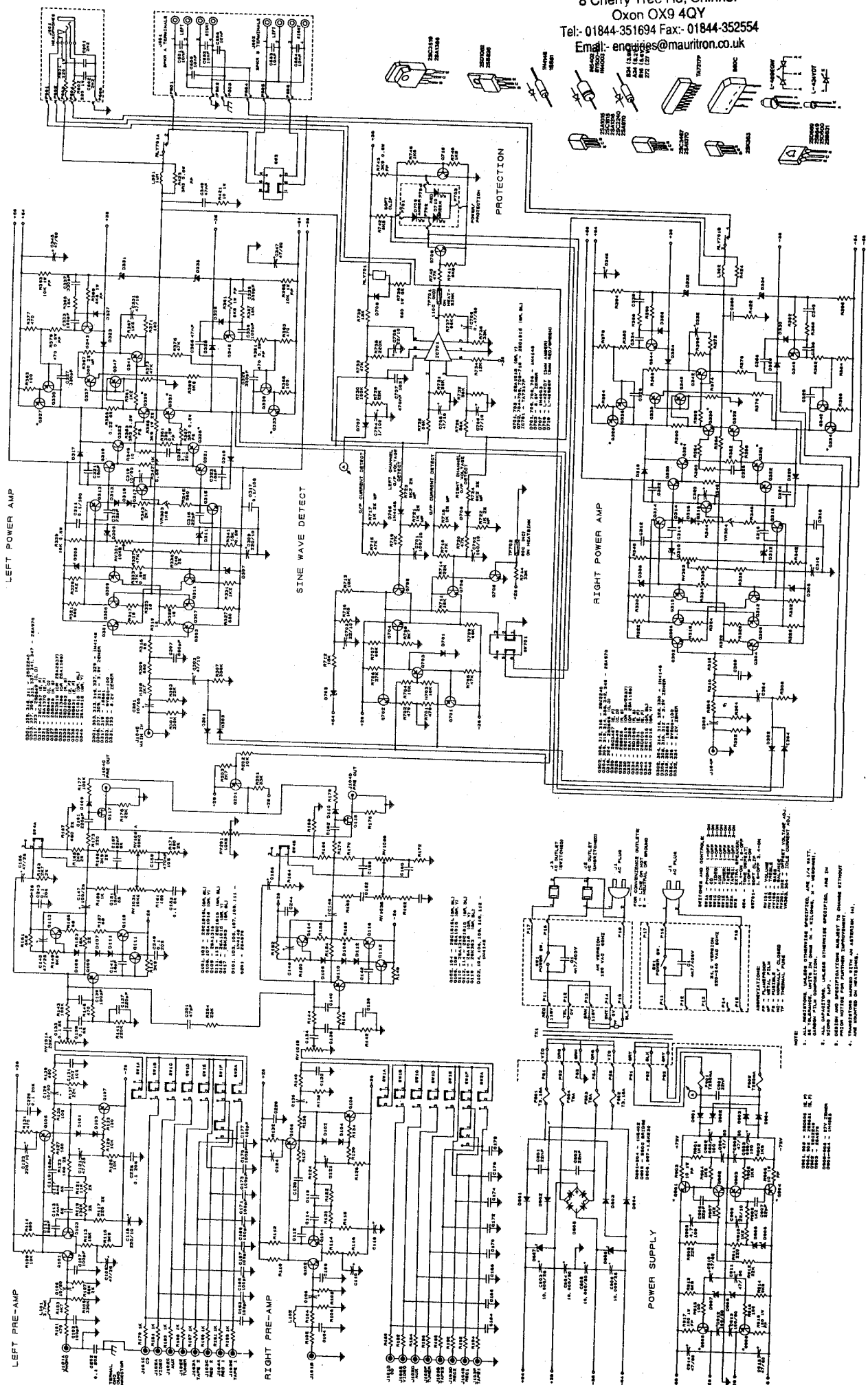

NOTE:
 1. ALL RESISTORS UNLESS OTHERWISE SPECIFIED ARE 1/4W. 5% TOL.
 2. CAPACITORS UNLESS OTHERWISE SPECIFIED ARE POLYPROPYLENE.
 3. 100K = 100,000 OHMS.
 4. 100K = 100,000 OHMS.
 5. 100K = 100,000 OHMS.
 6. 100K = 100,000 OHMS.
 7. 100K = 100,000 OHMS.
 8. 100K = 100,000 OHMS.
 9. 100K = 100,000 OHMS.
 10. 100K = 100,000 OHMS.
 11. 100K = 100,000 OHMS.
 12. 100K = 100,000 OHMS.
 13. 100K = 100,000 OHMS.
 14. 100K = 100,000 OHMS.
 15. 100K = 100,000 OHMS.
 16. 100K = 100,000 OHMS.
 17. 100K = 100,000 OHMS.
 18. 100K = 100,000 OHMS.
 19. 100K = 100,000 OHMS.
 20. 100K = 100,000 OHMS.
 21. 100K = 100,000 OHMS.
 22. 100K = 100,000 OHMS.
 23. 100K = 100,000 OHMS.
 24. 100K = 100,000 OHMS.
 25. 100K = 100,000 OHMS.
 26. 100K = 100,000 OHMS.
 27. 100K = 100,000 OHMS.
 28. 100K = 100,000 OHMS.
 29. 100K = 100,000 OHMS.
 30. 100K = 100,000 OHMS.
 31. 100K = 100,000 OHMS.
 32. 100K = 100,000 OHMS.
 33. 100K = 100,000 OHMS.
 34. 100K = 100,000 OHMS.
 35. 100K = 100,000 OHMS.
 36. 100K = 100,000 OHMS.
 37. 100K = 100,000 OHMS.
 38. 100K = 100,000 OHMS.
 39. 100K = 100,000 OHMS.
 40. 100K = 100,000 OHMS.
 41. 100K = 100,000 OHMS.
 42. 100K = 100,000 OHMS.
 43. 100K = 100,000 OHMS.
 44. 100K = 100,000 OHMS.
 45. 100K = 100,000 OHMS.
 46. 100K = 100,000 OHMS.
 47. 100K = 100,000 OHMS.
 48. 100K = 100,000 OHMS.
 49. 100K = 100,000 OHMS.
 50. 100K = 100,000 OHMS.
 51. 100K = 100,000 OHMS.
 52. 100K = 100,000 OHMS.
 53. 100K = 100,000 OHMS.
 54. 100K = 100,000 OHMS.
 55. 100K = 100,000 OHMS.
 56. 100K = 100,000 OHMS.
 57. 100K = 100,000 OHMS.
 58. 100K = 100,000 OHMS.
 59. 100K = 100,000 OHMS.
 60. 100K = 100,000 OHMS.
 61. 100K = 100,000 OHMS.
 62. 100K = 100,000 OHMS.
 63. 100K = 100,000 OHMS.
 64. 100K = 100,000 OHMS.
 65. 100K = 100,000 OHMS.
 66. 100K = 100,000 OHMS.
 67. 100K = 100,000 OHMS.
 68. 100K = 100,000 OHMS.
 69. 100K = 100,000 OHMS.
 70. 100K = 100,000 OHMS.
 71. 100K = 100,000 OHMS.
 72. 100K = 100,000 OHMS.
 73. 100K = 100,000 OHMS.
 74. 100K = 100,000 OHMS.
 75. 100K = 100,000 OHMS.
 76. 100K = 100,000 OHMS.
 77. 100K = 100,000 OHMS.
 78. 100K = 100,000 OHMS.
 79. 100K = 100,000 OHMS.
 80. 100K = 100,000 OHMS.
 81. 100K = 100,000 OHMS.
 82. 100K = 100,000 OHMS.
 83. 100K = 100,000 OHMS.
 84. 100K = 100,000 OHMS.
 85. 100K = 100,000 OHMS.
 86. 100K = 100,000 OHMS.
 87. 100K = 100,000 OHMS.
 88. 100K = 100,000 OHMS.
 89. 100K = 100,000 OHMS.
 90. 100K = 100,000 OHMS.
 91. 100K = 100,000 OHMS.
 92. 100K = 100,000 OHMS.
 93. 100K = 100,000 OHMS.
 94. 100K = 100,000 OHMS.
 95. 100K = 100,000 OHMS.
 96. 100K = 100,000 OHMS.
 97. 100K = 100,000 OHMS.
 98. 100K = 100,000 OHMS.
 99. 100K = 100,000 OHMS.
 100. 100K = 100,000 OHMS.

PCB LAY-OUT

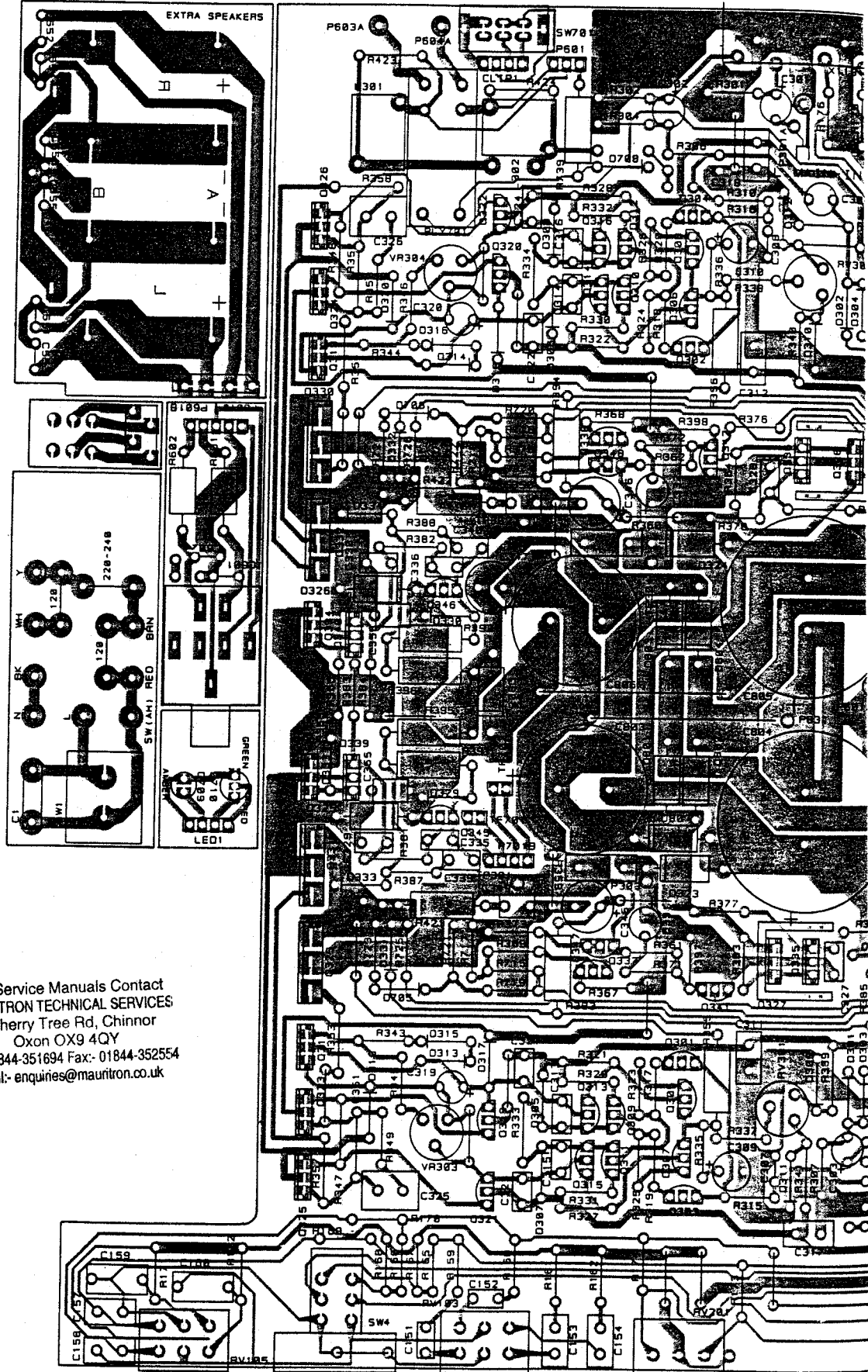

For Service Manuals Contact
MAURITRON TECHNICAL SERVICES
8 Cherry Tree Rd, Chinnor
Oxon OX9 4QY
Tel: 01844-351694 Fax: 01844-352554
Email: enquiries@mauritron.co.uk

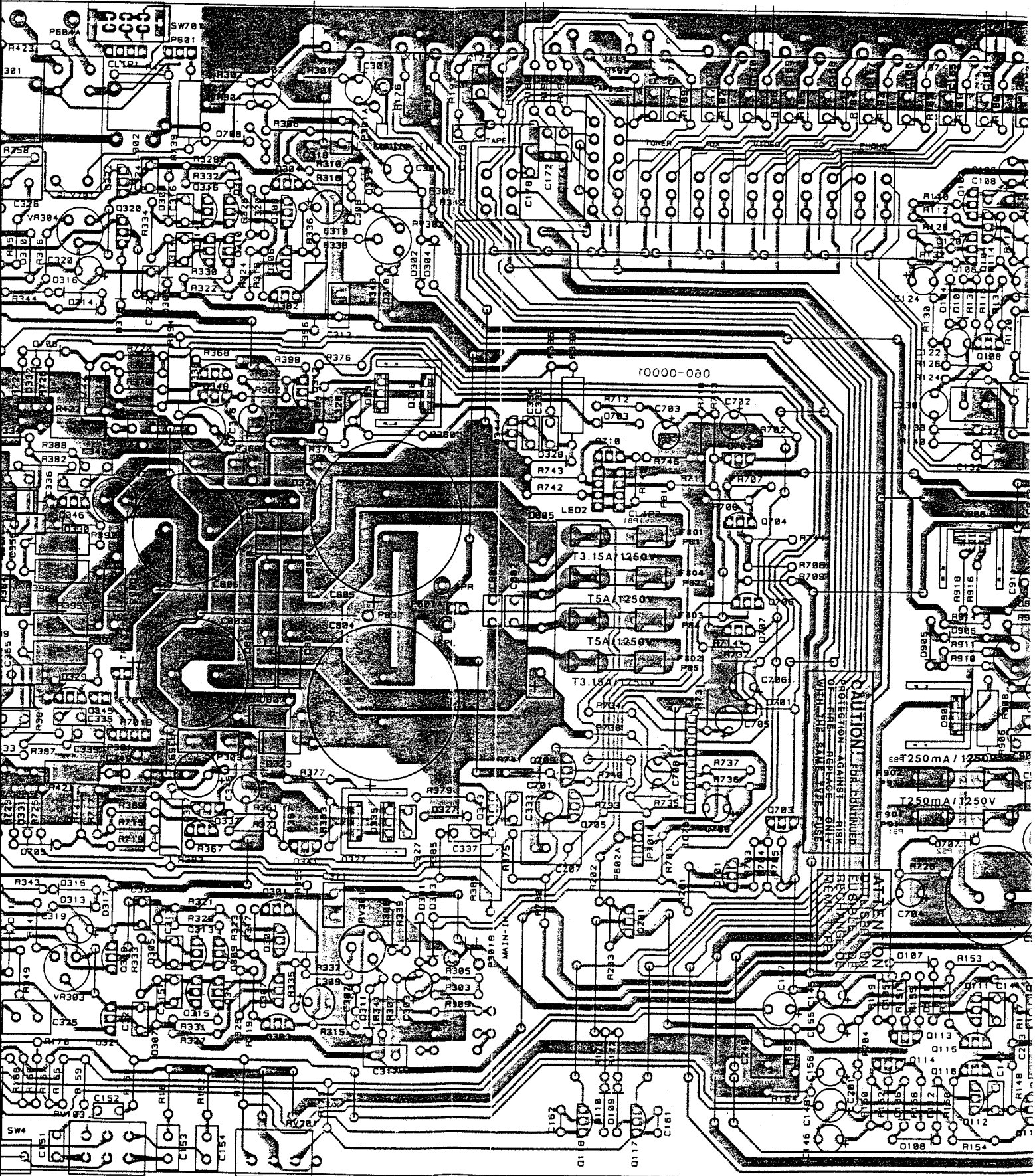

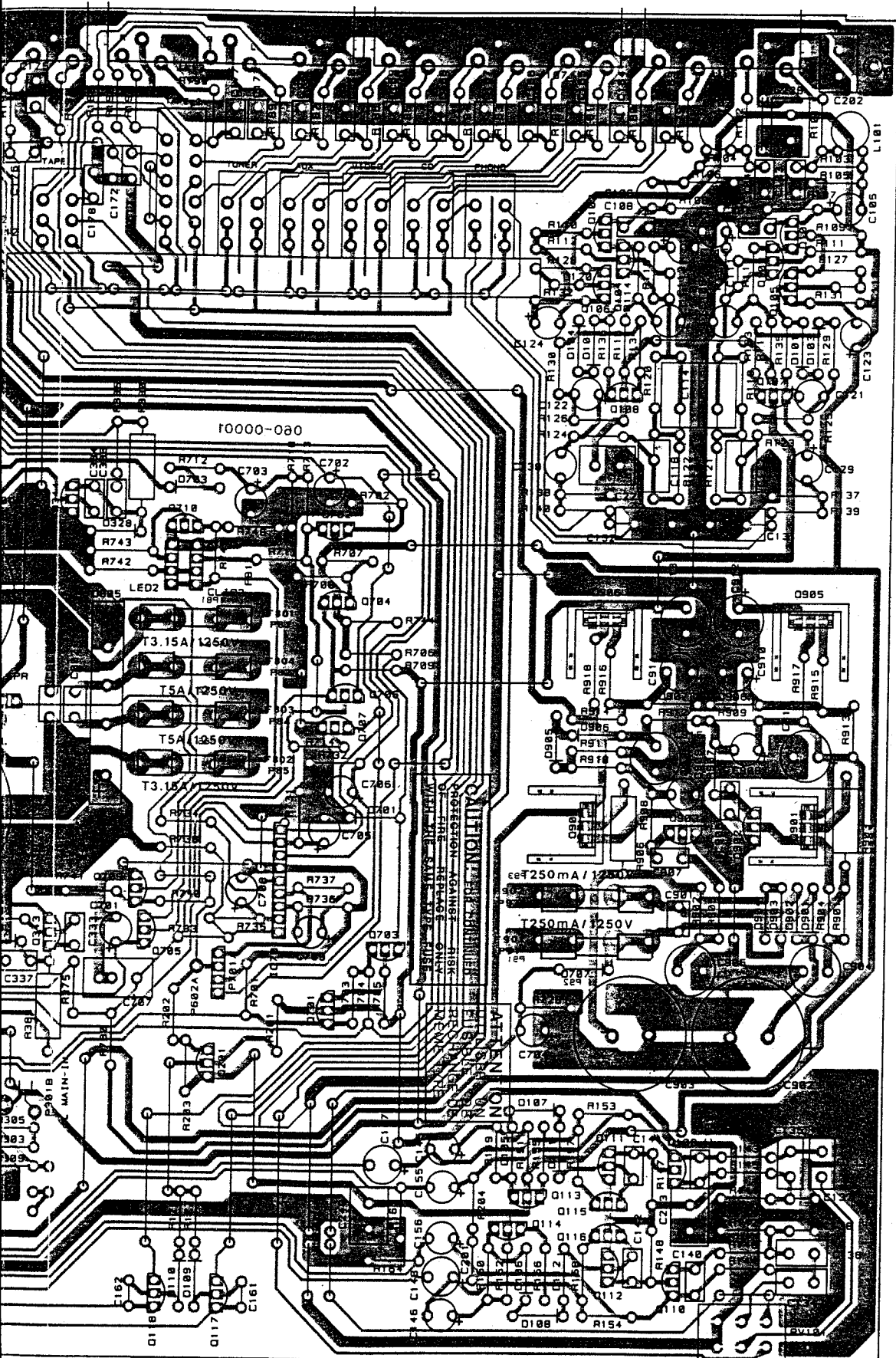

For Service Manuals Contact
MAURITRON TECHNICAL SERVICES
 8 Cherry Tree Rd, Chinnor
 Oxon OX9 4QY
 Tel: 01844-351694 Fax: 01844-352554
 Email: enquiries@mauritron.co.uk

PCB LAY-OUT

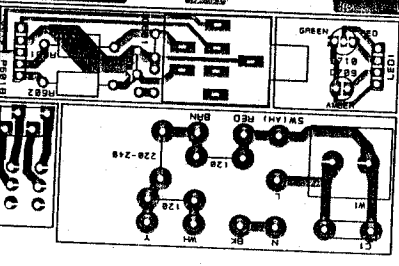
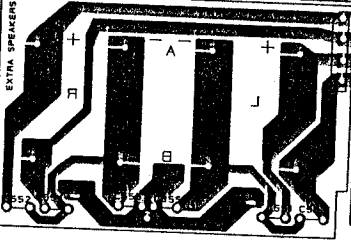
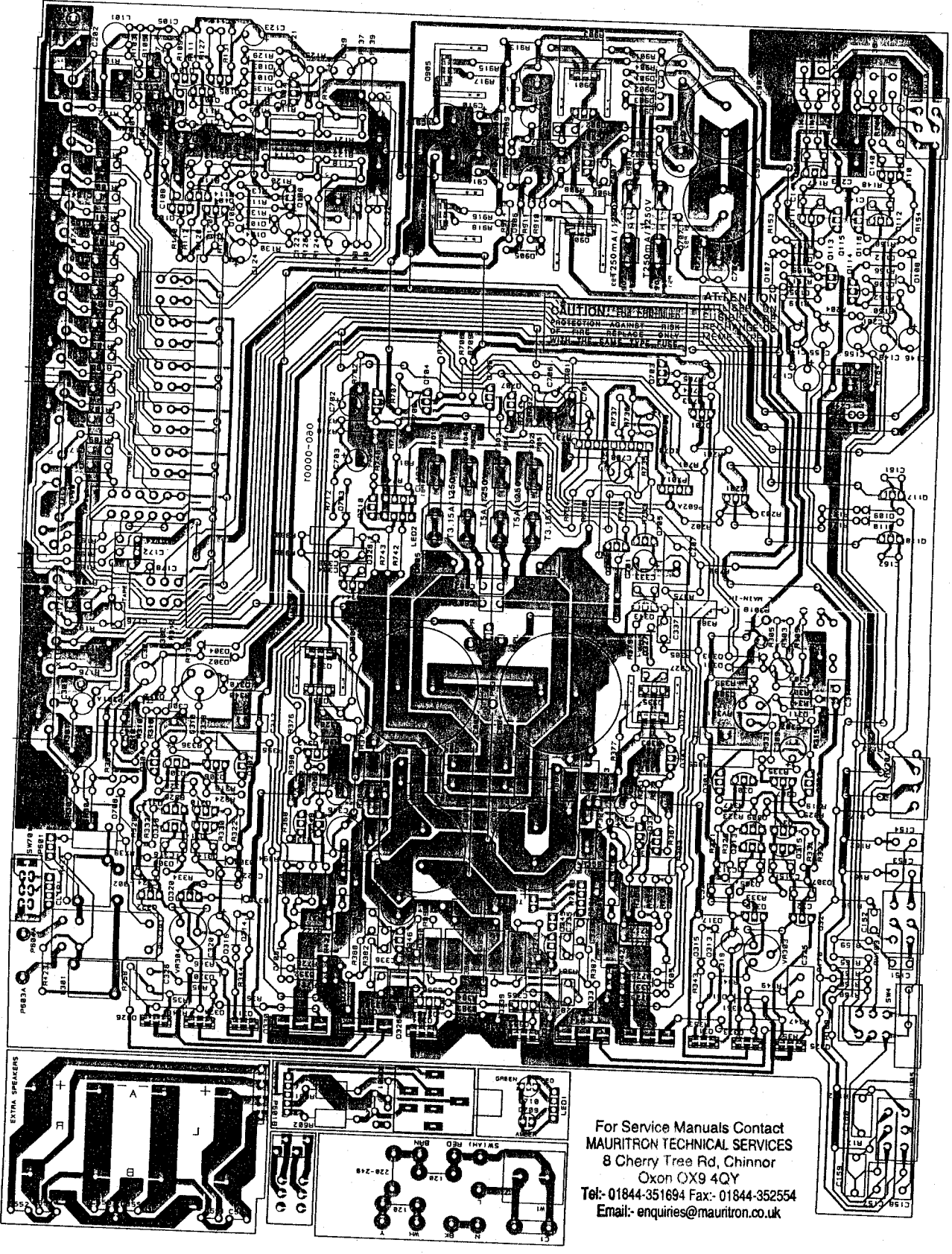

For Service Manuals Contact
MAURITRON TECHNICAL SERVICES
8 Cherry Tree Rd, Chinnor
Oxon OX9 4QY
Tel:- 01844-351694 Fax:- 01844-352554
Email:- enquiries@mauritron.co.uk

EXPLODED VIEW

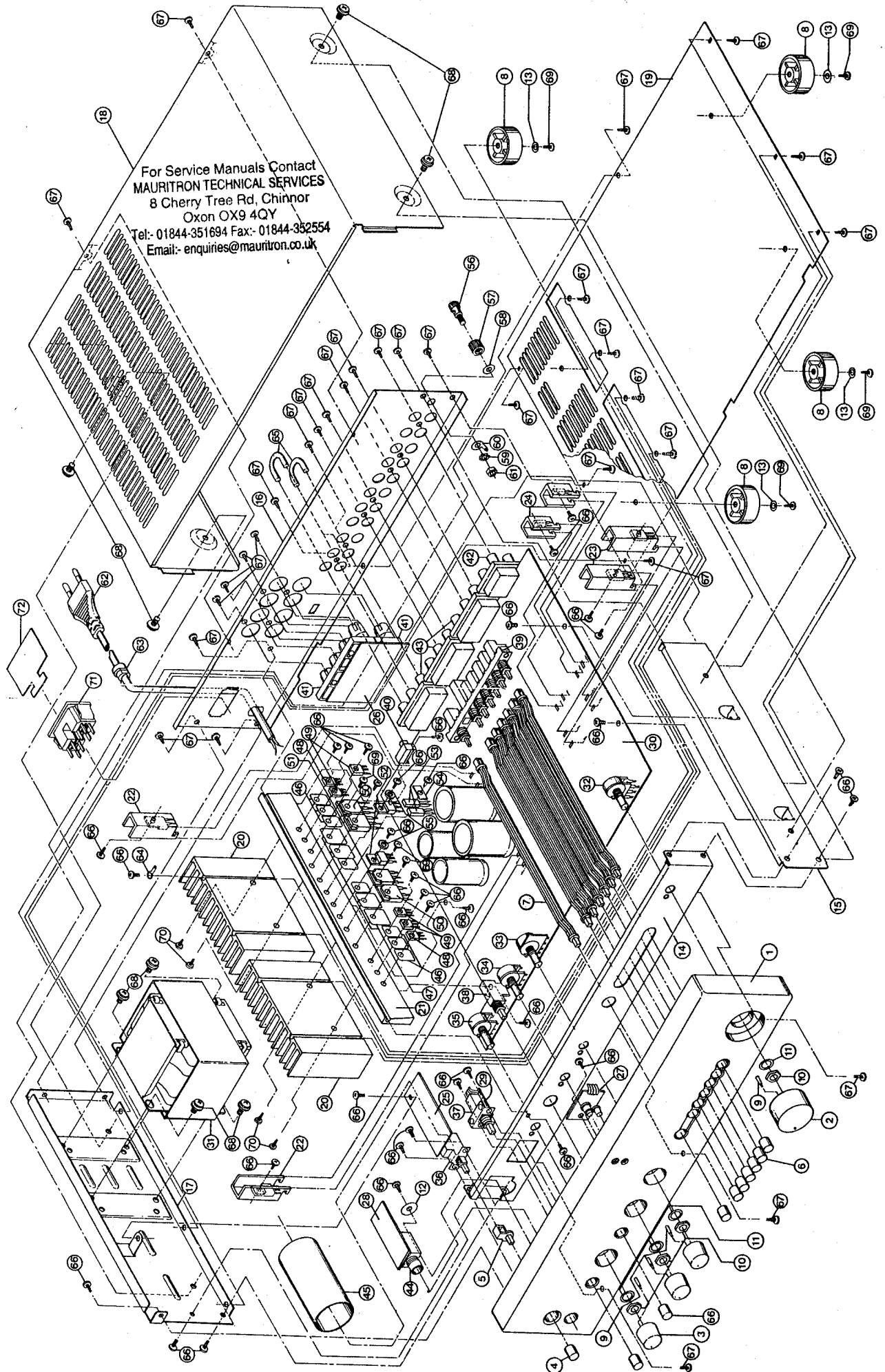

EXPLODED VIEW PARTS LIST (CONTINUATION)

ITEM	PART NUMBER	DESCRIPTION	QTY/UNIT
48	042-2SB649	See page 18 Q325, Q324	2 pcs
49	042-2SD669	See page 18 Q317, Q318, Q323, Q324	4 pcs
50	042-2SC3519	See page 18 Q329, Q330	2 pcs
51	042-2SA1386	See page 18 Q331, Q332	2 pcs
52	042-2SD1062R	See page 18 Q333, Q334	2 pcs
53	081-00006/7	See page 18 TF701, TF702	2 pcs
54	101-00008	Thermal Switch Clip	1 pc
55	140-00010	Transistor Bushing	2 pcs
56	082-00010A	Stud (Part of Thumb Screw 082-00010)	1 pc
57	082-00010B	Bushing (Part of Thumb Screw 082-00010)	1 pc
58	082-00010C	Washer (Part of Thumb Screw 082-00010)	1 pc
59	082-00010D	External Tooth Washer (Part of Thumb Screw 082-00010)	1 pc
60	082-00010E	Solder Lug (Part of Thumb Screw 082-00010)	1 pc
61	082-00010F	Nut 3.0mm (Part of Thumb Screw 082-00010)	1 pc
62 * AH	082-00004	See page 19 J1 * AH	1 pc
62 * C	082-00005	See page 19 J1 * C	1 pc
62 * B1	082-00006	See page 19 J1 * B1	1 pc
63	140-00006	Strain Relief	1 pc
64	133-00307	Solder Lug 3x7mm	1 pc
65	103-00001	Shorting Bar (Pre Out/Main In)	2 pcs
66	131-41308	ST 3x8mm, Binding Head (Zinc)	34 pcs
67	131-42308	ST 3x8mm, Binding Head (Black)	32 pcs
68	135-12406	M 4x6mm, Panhead (Black) w/built-in Washer	8 pcs
69	132-40308	M 3x8mm, Binding Head (Zinc)	8 pcs
70	131-11308	ST 3x8mm, 5.2 dia. Head (Panhead), Zinc	4 pcs
71	082-00001	See page 19 J2, J3	1 pc
72	066-00001	AC Outlet Cover Plate (AH Only)	1 pc

For Service Manuals Contact
MAURITRON TECHNICAL SERVICES
 8 Cherry Tree Rd, Chinnor
 Oxon OX9 4QY
 Tel: 01844-351694 Fax: 01844-352554
 Email: enquiries@mauritron.co.uk

ELECTRICAL PARTS LIST

For Service Manuals Contact
MAURITRON TECHNICAL SERVICES
 8 Cherry Tree Rd, Chinnor
 Oxon OX9 4QY
 Tel:- 01844-351694 Fax:- 01844-352554
 Email:- enquiries@mauritron.co.uk

SYMBOL NUMBER	REFERENCE NUMBER	PART NUMBER	DESCRIPTION			
RESISTORS						
R349, R350	011-29010	011-29010	10	0.25W	±5%	Carbon Film Resistor
R317, R318, R319, R320, R323, R324, R325, R326	011-29018	011-29018	18	0.25W	±5%	Carbon Film Resistor
R155, R156, R157, R158, R315, R316	011-29068	011-29068	68	0.25W	±5%	Carbon Film Resistor
R133, R134, R135, R136, R363, R364, R365, R366, R915, R916	011-29110	011-29110	100	0.25W	±5%	Carbon Film Resistor
R127, R128	011-29115	011-29115	150	0.25W	±5%	Carbon Film Resistor
R161, R162, R371, R372	011-29118	011-29118	180	0.25W	±5%	Carbon Film Resistor
R173, R174, R911	011-29122	011-29122	220	0.25W	±5%	Carbon Film Resistor
R101, R102, R131, R132, R145, R146, R377, R378, R383, R384, R701, R702	011-29147	011-29147	470	0.25W	±5%	Carbon Film Resistor
R345, R346	011-29156	011-29156	560	0.25W	±5%	Carbon Film Resistor
R111, R112, R139, R140, R309, R310, R321, R322, R327, R328	011-29168	011-29168	680	0.25W	±5%	Carbon Film Resistor
R159, R160, R179, R180, R181, R182, R183, R184, R185, R186, R187, R188, R189, R190, R191, R192, R193, R194	011-29210	011-29210	1K	0.25W	±5%	Carbon Film Resistor
R329, R330, R331, R332, R361, R362, R907, R908, R910	011-29212	011-29212	1K2	0.25W	±5%	Carbon Film Resistor
R397, R398, R710, R745, R746, R901, R902, R904, R905	011-29215	011-29215	1K5	0.25W	±5%	Carbon Film Resistor
R203, R305, R306, R343, R344, R708	011-29227	011-29227	2K7	0.25W	±5%	Carbon Film Resistor
R115, R116, R147, R148	011-29239	011-29239	3K9	0.25W	±5%	Carbon Film Resistor
R103, R104	011-29247	011-29247	4K7	0.25W	±5%	Carbon Film Resistor
R149, R150, R151, R152, R369, R370, R741, R742, R913, R914	011-29268	011-29268	6K8	0.25W	±5%	Carbon Film Resistor
R109, R110, R125, R126, R129, R130, R202, R703, R704, R713	011-29310	011-29310	10K	0.25W	±5%	Carbon Film Resistor
R734	011-29312	011-29312	12K	0.25W	±5%	Carbon Film Resistor
R113, R114, R385, R386, R387, R388, R712, R738	011-29315	011-29315	15K	0.25W	±5%	Carbon Film Resistor
R711	011-29318	011-29318	18K	0.25W	±5%	Carbon Film Resistor
R137, R138, R175, R176, R204, R303, R304, R714, R728, R909, R912	011-29322	011-29322	22K	0.25W	±5%	Carbon Film Resistor
R706	011-29327	011-29327	27K	0.25W	±5%	Carbon Film Resistor
R201, R736, R744	011-29333	011-29333	33K	0.25W	±5%	Carbon Film Resistor
R337, R338, R373, R374, R375, R376, R705, R715, R716, R719, R720, R733, R740	011-29347	011-29347	47K	0.25W	±5%	Carbon Film Resistor
R725, R726, R731, R732, R737	011-29356	011-29356	56K	0.25W	±5%	Carbon Film Resistor
R707, R709	011-29368	011-29368	68K	0.25W	±5%	Carbon Film Resistor
R143, R144, R177, R178	011-29410	011-29410	100K	0.25W	±5%	Carbon Film Resistor
R730	011-29415	011-29415	150K	0.25W	±5%	Carbon Film Resistor
R141, R142, R301, R302, R735	011-29422	011-29422	220K	0.25W	±5%	Carbon Film Resistor
R105, R106, R307, R308	011-29433	011-29433	330K	0.25W	±5%	Carbon Film Resistor
R339, R340, R341, R342	011-39315	011-39315	15K	0.5W	±5%	Carbon Film Resistor
R333, R334	011-39347	011-39347	47K	0.5W	±5%	Carbon Film Resistor

ELECTRICAL PARTS LIST (CONTINUATION)

SYMBOL NUMBER	REFERENCE NUMBER	PART NUMBER	DESCRIPTION			
R739	011-49156	011-49156	560	1W	±5%	Carbon Film Resistor
R601, R602	011-49122	011-49122	220	1W	±5%	Carbon Film Resistor
R123, R124	012-29118	012-29118	180	0.25W	±2%	Metal Film Resistor
R117, R118	012-29122	012-29122	220	0.25W	±2%	Metal Film Resistor
R335, R336	012-29124	012-29124	240	0.25W	±2%	Metal Film Resistor
R367, R368	012-29130	012-29130	300	0.25W	±2%	Metal Film Resistor
R167, R168, R171, R172	012-29168	012-29168	680	0.25W	±2%	Metal Film Resistor
R717, R718, R721, R722	012-29210	012-29210	1K	0.25W	±2%	Metal Film Resistor
R163, R164	012-29227	012-29227	2K7	0.25W	±2%	Metal Film Resistor
R165, R166, R169, R170	012-29239	012-29239	3K9	0.25W	±2%	Metal Film Resistor
R723, R724	012-29262	012-29262	6K2	0.25W	±2%	Metal Film Resistor
R121, R122	012-29311	012-29311	11K	0.25W	±2%	Metal Film Resistor
R153, R154	012-29315	012-29315	15K	0.25W	±2%	Metal Film Resistor
R107, R108	012-29356	012-29356	56K	0.25W	±2%	Metal Film Resistor
R119, R120	012-29413	012-29413	130K	0.25W	±2%	Metal Film Resistor
R355, R356	012-49239	012-49239	3K9	1W	±2%	Metal Film Resistor
R423, R424	013-38233	013-38233	3R3	0.5W	±5%	Flame Proof Resistor
R351, R352	013-39133	013-39133	330	0.5W	±5%	Flame Proof Resistor
R379, R380, R381, R382	013-39147	013-39147	470	0.5W	±5%	Flame Proof Resistor
R347, R348	013-39210	013-39210	1K	0.5W	±5%	Flame Proof Resistor
R743	013-39239	013-39239	3K9	0.5W	±5%	Flame Proof Resistor
R903, R906	013-49010	013-49010	10	1W	±5%	Flame Proof Resistor
R917, R918	013-49118	013-49118	180	1W	±5%	Flame Proof Resistor
R389, R390, R391, R392	013-49268	013-49268	6K8	1W	±5%	Flame Proof Resistor
R393, R394, R395, R396	013-49310	013-49310	10K	1W	±5%	Flame Proof Resistor
R353, R354, R357, R358	014-48233	014-48233	3R3	1W	±5%	Fusible Resistor
R421, R422	014-49010	014-49010	10	1W	±5%	Fusible Resistor
R359, R360	015-58122	015-58122	0.22	2W	±5%	Wirewound Ceramic Resistor
CAPACITORS						
C141, C142, C321, C322, C323, C324	022-47015M	022-47015M	15pF	500V		Ceramic Disk Capacitor
C313, C314, C315, C316, C906, C907	022-47022M	022-47022M	22pF	500V		Ceramic Disk Capacitor
C201	021-77047M	021-77047M	47pF	50V		Ceramic Disk Capacitor
C111, C112	021-77056M	021-77056M	56pF	50V		Ceramic Disk Capacitor
C119, C120	021-77068M	021-77068M	68pF	50V		Ceramic Disk Capacitor
C103, C104, C107, C108, C139	021-77110M	021-77110M	100pF	50V		Ceramic Disk Capacitor
C140, C163, C164, C165, C166, C167, C168, C169, C170, C171, C172, C173, C174, C175, C176, C177, C178						
C333, C334, C335, C336	022-47110M	022-47110M	100pF	500V		Ceramic Disk Capacitor
C137, C138, C161, C162	021-77122M	021-77122M	220pF	50V		Ceramic Disk Capacitor
C327, C328, C329, C330, C337, C338, C339, C340	022-47133M	022-47133M	330pF	500V		Ceramic Disk Capacitor
C307, C308	021-77156M	021-77156M	560pF	50V		Ceramic Disk Capacitor
C601, C602	021-77222M	021-77222M	2.2nF	50V		Ceramic Disk Capacitor
C551, C552, C553, C554, C555, C556	022-08010M	022-08010M	10nF	100V		Ceramic Disk Capacitor
C1	022-37247M	022-37247M	4.7nF	400V		UL, CSA, VDE Ceramic Disk Capacitor
C151, C152	023-78018J	023-78018J	18nF	50V	±5%	Polyester Film Capacitor
C801, C802, C901	024-28022M	024-28022M	22nF	250V	±20%	Polyester Film Capacitor

ELECTRICAL PARTS LIST (CONTINUATION)

SYMBOL NUMBER	REFERENCE NUMBER	PART NUMBER	DESCRIPTION
C349, C350, C355, C356	024-08047M	024-08047M	47nF 100V ±20% Polyester Film Capacitor
C157, C158	023-78082J	023-78082J	82nF 50V ±5% Polyester Film Capacitor
C133, C134, C135, C136, C153, C154	023-78110J	023-78110J	100nF 50V ±5% Polyester Film Capacitor
C202, C225, C228, C243, C249, C325, C326	023-78110M	023-78110M	100nF 50V ±20% Polyester Film Capacitor
C311, C312, C317, C318	024-08110M	024-08110M	100nF 100V ±20% Polyester Film Capacitor
C159, C160, C707	023-78147K	023-78147K	470nF 50V ±10% Polyester Film Capacitor
C131, C132	025-77222K	025-77222K	2.2nF 50V ±10% Polypropylene Film Capacitor
C117, C118	025-77268J	025-77268J	6.8nF 50V ±5% Polypropylene Film Capacitor
C113, C114	025-78024J	025-78024J	24nF 50V ±5% Polypropylene Film Capacitor
C709	027-78147M	027-78147M	0.47uF 50V Electrolytic Capacitor
C704	028-08210M	028-08210M	1uF 100V Electrolytic Capacitor
C908	028-08247M	028-08247M	4.7uF 100V Electrolytic Capacitor
C105, C106, C129, C130, C301, C302, C319, C320	027-79010M	027-79010M	10uF 50V Electrolytic Capacitor
C703, C708, C909	027-29022M	027-29022M	22uF 10V Electrolytic Capacitor
C303, C304, C331, C332, C705, C706	027-29047M	027-29047M	47uF 10V Electrolytic Capacitor
C109, C110, C121, C122, C145, C146, C155, C156	027-59047M	027-59047M	47uF 25V Electrolytic Capacitor
C345, C346, C347, C904, C905, C910, C911, C914, C915	027-99047M	027-99047M	47uF 80V Electrolytic Capacitor
C701, C702	027-29110M	027-29110M	100uF 10V Electrolytic Capacitor
C147, C148	027-59110M	027-59110M	100uF 25V Electrolytic Capacitor
C912, C913	027-79110M	027-79110M	100uF 50V Electrolytic Capacitor
C115, C116, C123, C124, C309, C310	027-29122M	027-29122M	220uF 10V Electrolytic Capacitor
C902, C903	028-09168M	028-09168M	680uF 100V Electrolytic Capacitor
C803, C806	027-59310M	027-59310M	10000uF 25V Electrolytic Capacitor
C804, C805	027-79310M	027-79310M	10000uF 50V Electrolytic Capacitor
DIODES			
D101, D102, D103, D104, D105, D106, D107, D108, D109, D110, D111, D112, D301, D302, D303, D304, D313, D314, D315, D316, D327, D328, D329, D330, D701, D705, D706, D708	1N4148	031-1N4148	1N4148 Signal Diode
D707, D901, D902, D903, D904	1N4003	032-1N4003	1N4003 Power Diode
D801, D802, D803, D804	1N5402	032-1N5402	1N5402 Power Diode
D317, D318, D319, D320	1SS81	031-1SS81	1SS81 Signal Diode
D323, D324, D325, D326	BY500-100	032-BY500100	BY500-100 (G.I.) Power Diode
D805	B80C	035-B80C	100 PIV 5A (G.I. B80C) Bridge
D305, D306, D307, D308, D309, D310, D311, D312	B24	033-B24	B24, 3V9, 0.4W Zener Diode
D703	B1G	033-B1G	B1G, 5V6, 0.4W Zener Diode
D331, D332, D333, D334	A29	033-A29	A29, 8V2, 0.4W Zener Diode
D905, D906, D907, D908	27Z	033-27Z	27Z, 27V, 0.4W Zener Diode
D806, D807	1.5KE30	033-1.5KE30	1.5KE30 Transient Voltage Suppressor
D709	L-424YDT	034-L424YDT	3mm AMBER LED (L-424YDT)
D710	L-469EGW	034-L469EGW	3mm RED/GREEN LED (L-469EGW)

ELECTRICAL PARTS LIST (CONTINUATION)

For Service Manuals Contact
MAURITRON TECHNICAL SERVICES
 8 Cherry Tree Rd, Chinnor
 Oxon OX9 4QY
 Tel:- 01844-351694 Fax:- 01844-352554
 Email:- enquiries@mauritron.co.uk

SYMBOL NUMBER	REFERENCE NUMBER	PART NUMBER	DESCRIPTION
TRANSISTORS			
Q201, Q303, Q304, Q307, Q308, Q309, Q310, Q313, Q314, Q337, Q338, Q341, Q342, Q347, Q348, Q903	2SA970 GR	041-2SA970 GR	2SA970 GR Toshiba Signal Transistor
Q105, Q106, Q107, Q108, Q115, Q116, Q345, Q346, Q701, Q703 Q109, Q110	2SA1015 GR	041-2SA1015 GR	2SA1015 GR Toshiba Signal Transistor
Q321, Q322	2SA1316 BL	041-2SA1316 BL	2SA1316 BL Toshiba Signal Transistor
Q331, Q332	2SA1370 E	041-2SA1370 E	2SA1370 E Sanyo Signal Transistor
Q335, Q336, Q904, Q906	2SA1386	042-2SA1386	2SA1386 Sanken Power Transistor
Q325, Q326	2SB631 E	042-2SB631 E	2SB631 E Sanyo Power Transistor
Q327, Q328	2SB649	042-2SB649	2SB649 Hitachi Power Transistor
Q111, Q112, Q113, Q114, Q343, Q344, Q702, Q704, Q705, Q706, Q708, Q709, Q710	2SB826 R	042-2SB826 R	2SB826 R Sanyo Power Transistor
Q101, Q102, Q103, Q104	2SC1815 GR	041-2SC1815 GR	2SC1815 GR Toshiba Signal Transistor
Q301, Q302, Q305, Q306, Q311, Q312, Q315, Q316, Q902	2SC1815 LGR	041-2SC1815 LGR	2SC1815 LGR Toshiba Signal Transistor
Q319, Q320	2SC2240 GR	041-2SC2240 GR	2SC2240 GR Toshiba Signal Transistor
Q329, Q330	2SC3467 E	041-2SC3467 E	2SC3467 E Sanyo Signal Transistor
Q339, Q340, Q901, Q905	2SC3519	042-2SC3519	2SC3519 Sanken Power Transistor
Q317, Q318, Q323, Q324	2SD600 E	042-2SD600 E	2SD600 E Sanyo Power Transistor
Q333, Q334	2SD669	042-2SD669	2SD669 Hitachi Power Transistor
Q117, Q118	2SD1062 R	042-2SD1062 R	2SD1062 R Sanyo Power Transistor
	2SK363 BL	043-2SK363 BL	2SK363 BL Toshiba FET
IC			
IC701	TA7317 P	051-TA7317 P	TA7317 P Toshiba (Prot) IC
POTENTIOMETERS			
VR303, VR304	071-29210	071-29210	1KB Trimmer Pot ALPS RH1051C, Idle Current Adj.
RV301, RV302	071-29310	071-29310	10KB Trimmer Pot ALPS RH1051C, DC Offset Voltage Adj.
RV103	073-39310	073-39310	2x10KC ALPS RK16312, Treble Pot.
RV201	075-49310	075-49310	1x10KW ALPS RK16311, Balance Pot.
RV101	072-19320	072-19320	2x20KA ALPS RK16312, Volume Pot.
RV105	073-39350	073-39350	2x50KC ALPS RK16312, Bass Pot.
SWITCHES			
SW1A-F/SW2A	081-00001	081-00001	7Key ALPS SPUN, Input Select Switch
SW1	081-00002	081-00002	1P1T w/o Screw Tap SMK JU-3066 or ALPS SDDL B, Power Switch
SW3	081-00003	081-00003	2P2T ALPS SPUN, 1A, 24V, w/o Screw Tap, Extra Spkr. Switch
SW4	081-00004	081-00004	2P2T ALPS SPUN w/o Frame, Tone Defeat Switch
SW701	081-00005	081-00005	2P2T Highly HSK-2210, Soft Clip Switch
TF701	081-00006	081-00006	110C NC Uchiya UP-62, Thermal Switch
TF702	081-00007	081-00007	90C NC Uchiya UP-62, Thermal Switch

ELECTRICAL PARTS LIST (CONTINUATION)

SYMBOL NUMBER	REFERENCE NUMBER	PART NUMBER	DESCRIPTION
JACKS			
J101	082-0002	082-0002	4P Gold RJ-1019-020AG, RCA Jack; Phono, CD
J102, J103, J104	082-0003	082-0003	6P Standard RJ-1017-02, RCA Jack; Video, Aux, Tuner, Tape 2 In/Out, Tape 1 In/Out, Pre Out, Main In
J601	082-0008	082-0008	JYE TAI JY-6312, Headphone Jack
FUSES			
F803, F804 * AH	084-0001	084-0001	5A, UL/CSA GTE, AH Only
F803, F804 * C & B1	084-0002	084-0002	5A, HBC, C & B1 Only
F801, F802 * AH	084-0003	084-0003	3.15A, UL/CSA, AH Only
F801, F802 * C & B1	084-0004	084-0004	3.15A, HBC, C & B1 Only
F901, F902 * AH	084-0005	084-0005	250mA, UL/CSA GTE, AH Only
F901, F902 * C & B1	084-0006	084-0006	250mA, HBC, C & B1 Only
OTHERS			
J2, J3	082-0001	082-0001	AC Outlet (AH Only)
J501, J502	082-0007	082-0007	Speaker Terminal Block, Nanjing
	082-0009	082-0009	Fuse Holder CQ-203S CQ
RLY701	083-0001	083-0001	Spkr Relay 2P1T Taiko DGX2-24M
L101, L102	091-20001	091-20001	3.7mH Toroid Coil
L301, L302	091-10002	091-10002	1 uH Air Cored Coil
TX1	092-10001	092-10001	Power Transformer
J1 * AH	082-0004	082-0004	AC Cord, AH Only
J1 * C	082-0005	082-0005	AC Cord, C Only
J1 * B1	082-0006	082-0006	AC Cord, B1 Only

For Service Manuals Contact
MAURITRON TECHNICAL SERVICES
 8 Cherry Tree Rd, Chinnor
 Oxon OX9 4QY
 Tel:- 01844-351694 Fax:- 01844-352554
 Email:- enquiries@mauritron.co.uk