



SERVICE MANUAL

MONITOR SERIES

3400

**INTEGRATED
AMPLIFIER**

NAD 3400 SERVICE MANUAL

CONTENTS

2. Safety Notice
3. Rear/Front View
4. Specifications
7. Remote Control Transmitter
8. Main Amp, Preamp Alignment
9. Schematics, Foil Diagrams
15. Wiring Diagram
17. Exploded View
18. Exploded View Parts List
23. Electrical Parts List

Version	Voltage	Country
A	120	USA
A1	120	Canada
B	240	UK
B1	240	Australia
C	220	Europe, others
C1	220	W. Germany
C/S	220	Scandinavia

SERVICE SAFETY PRECAUTIONS (UL)

1. Use exact replacement parts for critical locations, marked "Δ" on parts list.
2. Return lead dress to original position, and re-install protective covers.
3. Before returning to customer, test for shock hazard; use either method A or B:
 - A. Leakage test, "cold":
 1. Unplug AC cord, turn power switch ON.
 2. Connect one lead of High Voltage Insulation Tester to both prongs of AC plug.
 3. Touch other lead to all exposed metal parts.
 4. Impedance measurement must be 0.3 - 5.0 Megohms.
 - B. Leakage test, "live":
 1. Plug unit directly into AC outlet; do not use isolation transformer.
 2. Connect one lead of Leakage Current Tester to earth ground.
 3. Touch other lead to all exposed metal parts.
 4. Leakage measurement must be less than 0.5 milliamps.

REAR PANEL CONNECTIONS

- | | | |
|--------------------|--------------------------|------------------------|
| 1. AC LINE CORD. | 8. CAPACITANCE SELECTOR. | 15. INFRASONIC FILTER. |
| 2. AC OUTLETS. | 9. TUNER INPUT. | 16. SOFT CLIPPING. |
| 3. SPEAKERS A. | 10. VIDEO SOUND INPUT. | 17. BRIDGING. |
| 4. SPEAKERS B. | 11. CD INPUT. | 18. SPEAKER IMPEDANCE. |
| 5. GROUND. | 12. TAPE 1 INPUT/OUTPUT. | |
| 6. PHONO INPUT. | 13. TAPE 2 INPUT/OUTPUT. | |
| 7. MM/MC SELECTOR. | 14. PREAMP OUT, MAIN IN. | |

ATTENTION:
 ET LES CONSÉQUENCES
 D'UNES OUVRES QUI POURRAIENT
 EN RÉSULTER NE TENTEZ
 PAS D'OUVRIR L'APPAREIL
 ET DE TOUCHER AUX
 COMPOSANTS INTERNES
 SANS LA PRÉSENCE D'UNE
 PERSONNE QUALIFIÉE

CAUTION
 CAUTION TO REDUCE
 THE RISK OF ELECTRIC
 SHOCK, DO NOT REMOVE
 COVER OR BACK.
 NO USER-SERVICEABLE
 PARTS INSIDE. REFER
 SERVICING TO QUALIFIED
 SERVICE PERSONNEL.

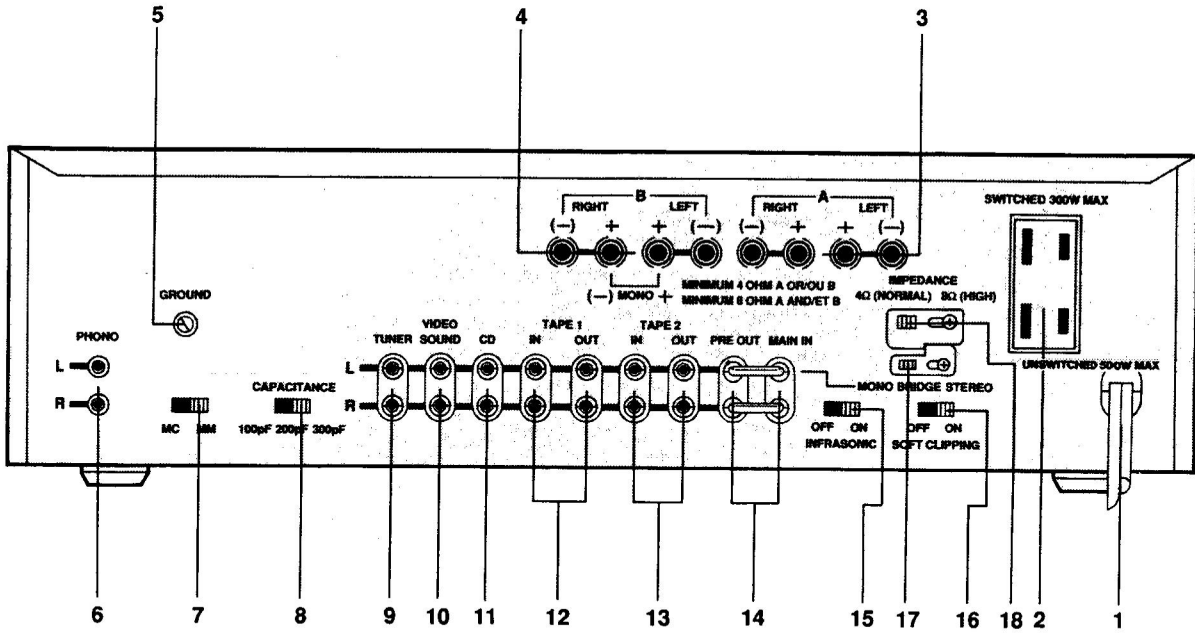

 The lightning flash with arrowhead, within an equilateral triangle, is intended to alert the user of the presence of uninsulated "dangerous voltage" within the product's enclosure; that may be of sufficient magnitude to constitute a risk of electric shock to persons.

 The exclamation point within an equilateral triangle is intended to alert the user of the presence of important operating and maintenance (servicing) instructions in the literature accompanying the appliance.

FRONT PANEL CONTROLS

- | | | |
|-------------------------|---------------------|------------------------|
| 1. POWER. | 8. TREBLE. | 15. BALANCE. |
| 2. PHONES. | 9. TREBLE RANGE. | 16. VOLUME. |
| 3. SPEAKERS A/B. | 10. TAPE COPY. | 17. STATUS INDICATORS. |
| 4. BASS EQ. | 11. TAPE 1, TAPE 2. | |
| 5. BASS RANGE. | 12. INPUT SELECTOR. | |
| 6. BASS. | 13. MONO. | |
| 7. TONE CONTROL BYPASS. | 14. LOW LEVEL. | |

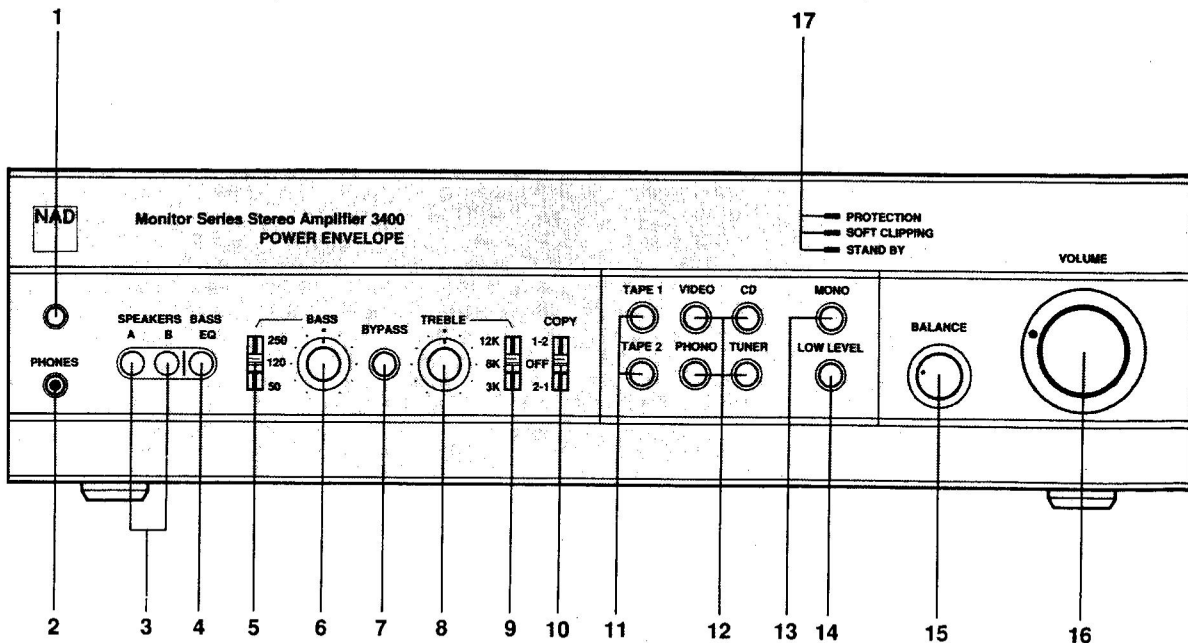

SPECIFICATIONS

Note: Specifications are measured in accordance with EIA Standard RS-490 (IHF A-202). Measurements referenced to 8Ω are taken with the Speaker Impedance Selector set to "8Ω (High)." Measurements for 4 and 2 ohms are taken with the Impedance Selector at "4Ω (Normal)."

POWER AMPLIFIER SECTION

STEREO MODE

CONTINUOUS AVERAGE POWER

OUTPUT INTO 8 OHMS

100 W (20 dBW)

(Min. RMS power per channel, 20Hz-20kHz, both channels driven, with no more than the rated distortion)

Rated Distortion (THD, 20Hz-20kHz)

0.03%

Clipping power (maximum continuous power per channel)

8 ohms

130 W

IHF Dynamic Headroom at 8 ohms

+5.7 dB

IHF Dynamic Power (maximum short-term power per channel)

8 ohms

370 W

4 ohms

400 W

2 ohms

440 W

Slew Factor

>50

Slew Rate

>30 V/μsec

Damping Factor (ref. 8 ohms, 50 Hz)

>100

THD (Total Harmonic Distortion, 20Hz-20kHz, from 250mW to rated output)

<0.03%

SMPTE I.M. (Intermodulation Distortion, 60Hz & 7kHz, 4:1, from 250mW to rated output)

<0.03%

IHF I.M. (CCIF IM Distortion, 19 & 20kHz at rated output)

<0.03%

Input Impedance

R = 20kΩ

C = 600 pF

Input Sensitivity for 1W out/for rated power

100mV/1.0V

Voltage Gain

X28 (29 dB)

Frequency Response Lab Input

3 Hz to 100 kHz

+0, -3 dB

Signal/Noise Ratio, A-weighted

98 dB ref. 1W

118 dB ref. 100W

BRIDGED (MONOPHONIC) MODE

CONTINUOUS AVERAGE POWER

OUTPUT INTO 8 OHMS

300 W (24.7 dBW)*

(Min. RMS power, 20Hz-20kHz, with no more than the rated distortion)

IHF Dynamic Headroom at 8 ohms

+4.3 dB

IHF Dynamic Power (maximum short-term power)

8 ohms 800 W (29 dBW)
4 ohms 880 W (29.4 dBW)

PREAMPLIFIER SECTION

PHONO INPUT

Input Impedance

MM: R = 47 k Ω , C = 100/200/300 pF
MC: R = 100 Ω , C = 1000 pF

Input Sensitivity (1 kHz)

MM: 0.22 mV
MC: 0.011 mV

Input Overload at 20 Hz/1kHz/20kHz

MM: 20 mV/180 mV/1.6 mV
MC: 0.8 mV/8 mV/80 mV

Signal/Noise Ratio, IHF A-weighted, with cartridge connected

MM: 80 dB ref. 5 mV
MC: 78 dB ref. 0.5 mV

THD (20Hz-20kHz) and IM distortion at +30dB level

<0.04%

RIAA Response Accuracy

± 0.5 dB

LINE LEVEL INPUTS (Tuner, CD, Video, Tape)

Input Impedance

R = 50 k Ω
C = 250 pF

Input Sensitivity ref. 1W/rated output

15 mV/150 mV

Maximum Input Signal

10 V

Signal/Noise Ratio, A-weighted

96 dB ref. 1W
116 dB ref. 100W

Frequency Response, 20Hz-20kHz

± 0.3 dB

OUTPUTS

Preamp Output Impedance

600 Ω

Tape Output Impedance

1000 Ω (buffered)

Maximum Output Level

10 V

Tape Output Infrasonic Filter

-3 dB at 14 Hz

12 dB/octave

CONTROLS

Treble	± 12 dB at 3, 6 or 12 kHz
Bass	± 12 dB at 50, 100 or 250 Hz
Bass Equalization	+3 dB at 60 Hz +6 dB at 36 Hz
Infrasonic Filter (switchable)	-3 dB at 12 Hz 12 dB/octave
Audio Muting (low level)	-20 dB

PHYSICAL SPECIFICATIONS

Width \times Height \times Depth	43.5 \times 12 \times 38.5 cm (17.1 \times 4.75 \times 15.2 in.)
Net Weight	11 kg (24.25 lb)
Shipping Weight	12.6 kg. (27.75 lb)
Power Consumption	50/60 Hz at 110, 220, or 240 V. 390 VA

Specifications are those in effect at the time of printing. NAD reserves the right to change specifications or design at any time without notice.

* In some countries local regulations require that bridged 8 ohm power be measured with the speaker impedance switch in the 4 ohm position resulting in a bridged RMS output of 200W(23dBW).

MAIN AMPLIFIER ALIGNMENT

IMPORTANT NOTES

1. Before adjusting, remove input signal and load, and set speaker impedance switch to 8Ω (HIGH); reset to 4Ω (NORMAL) when finished.
2. These adjustments are always necessary after repair to main amplifier.
3. After repair, it is recommended to use current limiter (200-250W lightbulb) in mains line, for initial turn-on.

A. CENTER VOLTAGE CHECK

1. Connect DVM from R836, L chan (R886, R chan).
2. Turn power on, and check for reading of 0V ± 100mVDC.

B. IDLE CURRENT ADJUSTMENT

1. Connect DVM from TP801 to TP802, L chan (TP851, TP852 R chan).
2. Adjust R818, L chan (R868, R chan) for reading of 14mV ± 1mVDC.

C. FINAL ADJUSTMENT

1. Leave power on minimum 5 minutes.
2. Repeat center voltage check and idle current adjustment.

PREAMPLIFIER ALIGNMENT

CHANNEL BALANCE

1. Feed 1kHz, 100mV to CD input; connect AC VTVM's to Pre Out.
2. Set volume to maximum, balance to center, low level off.
3. Adjust R758 so that both channels have same output level ± 0.25dB.

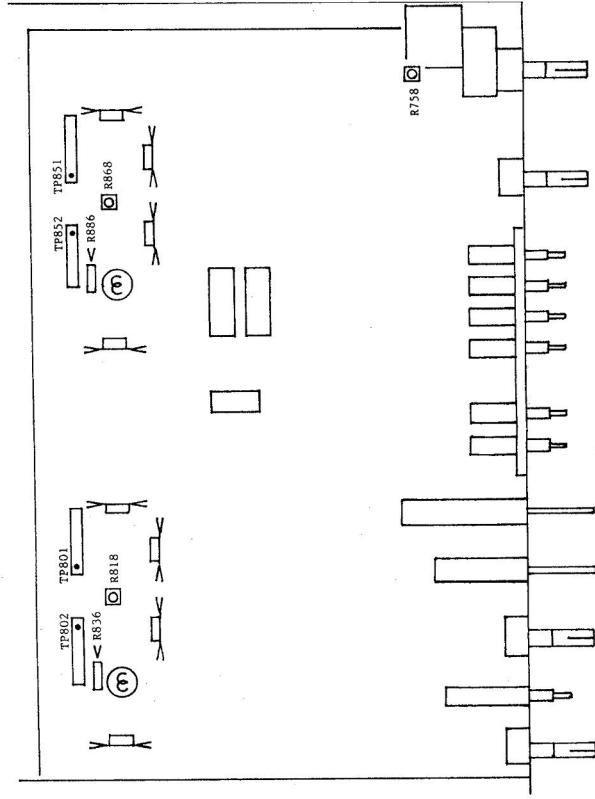

REMOTE CONTROL TRANSMITTER

STATION SELECTION
CD TRACKS
TAPE LOCATIONS

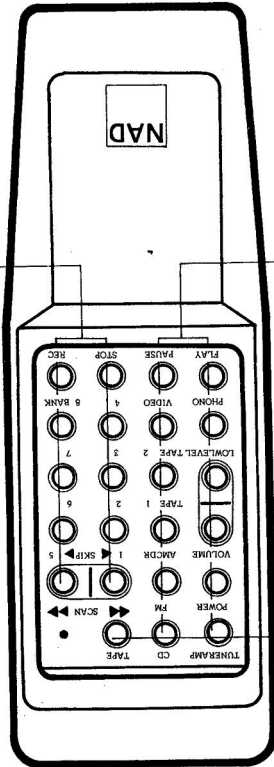

SIGNAL SOURCE SELECTION
VOLUME
PLAYBACK CONTROLS

MODE SELECTION

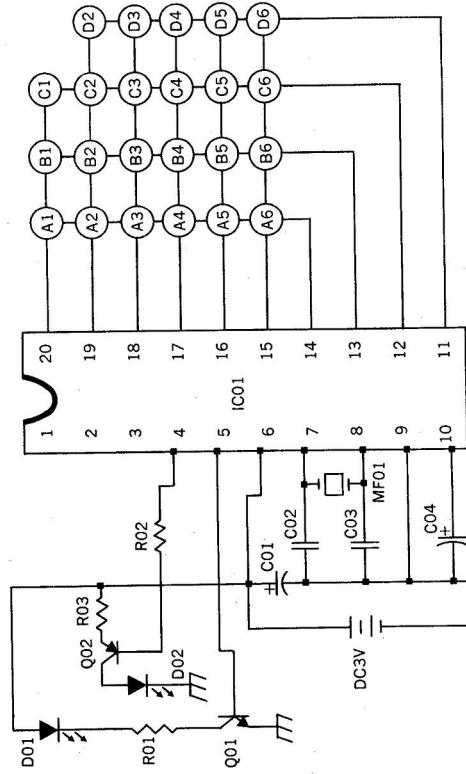

SCHEMATIC FOR REFERENCE ONLY.
TRANSMITTER NON-REPAIRABLE.

P.C.B. LAYOUT

INPUT/OUTPUT P.C.B. ASSY (J030A)

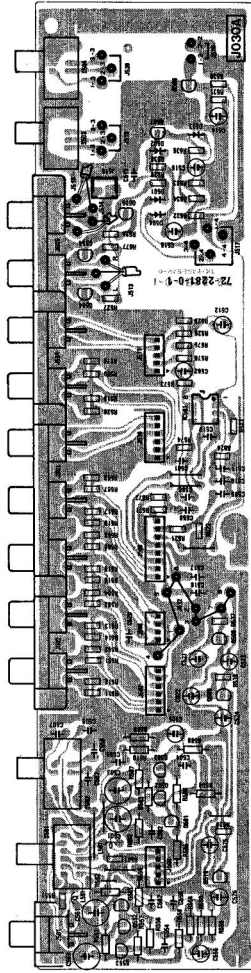

MAINS INPUT P.C.B. ASSY (P034C)

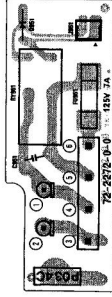

MAIN/CONTROL/SUPPLY P.C.B. ASSY (J029A)

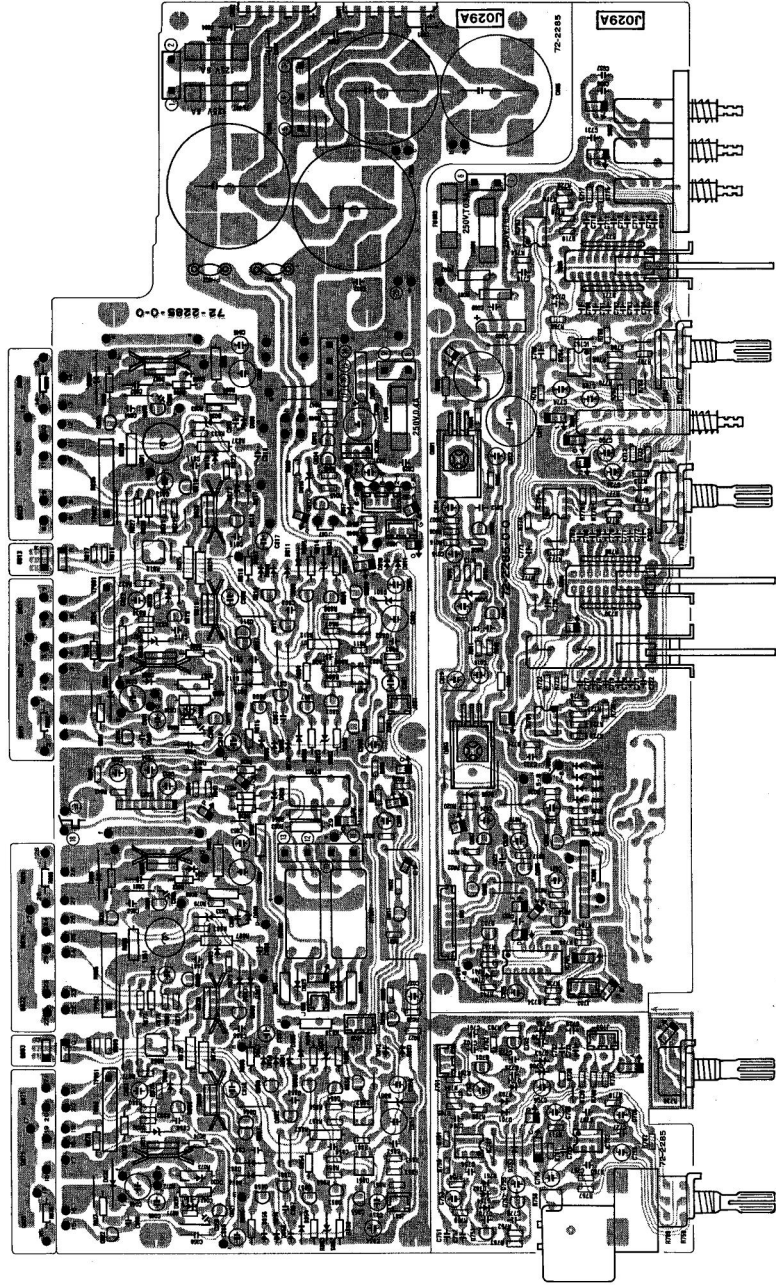

HEADPHONE CONNECTOR ASS'Y (H006B)



POWER SWITCH ASSY (S104B)

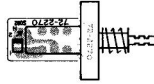

BRIDGE SWITCH ASSY (S103B)



SCHEMATIC/P.C.B. LAYOUT, SELECTOR/ μ COM

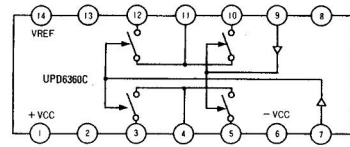
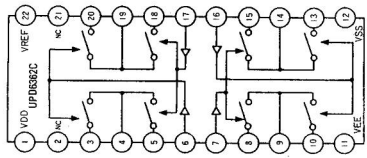
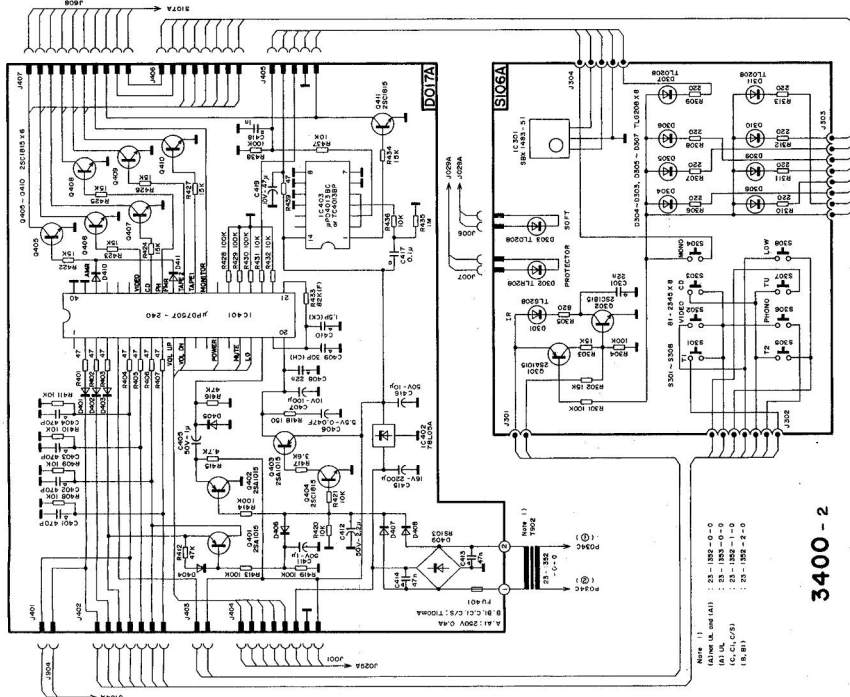
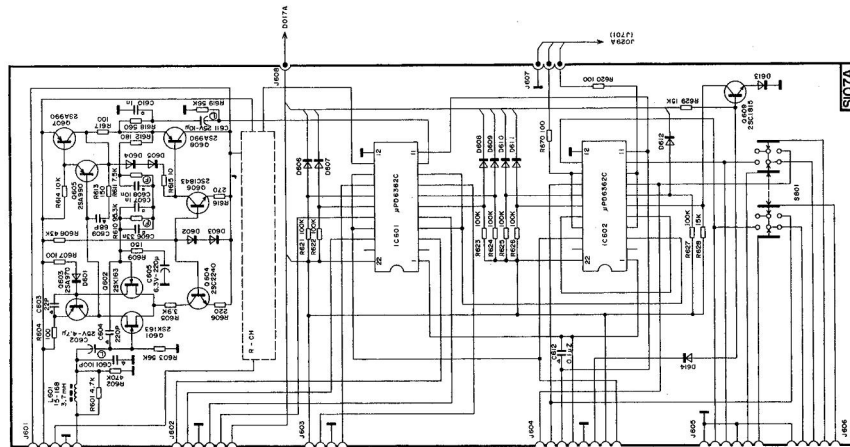

3400 - 2

Rev. 11 : 33-1382-0-0
 (A) U.L. : 33-1383-0-0
 (S, C, I, S, I) : 33-1382-2-0
 (A, S, I)

SELECTOR P.C.B. ASS'Y (S107A)

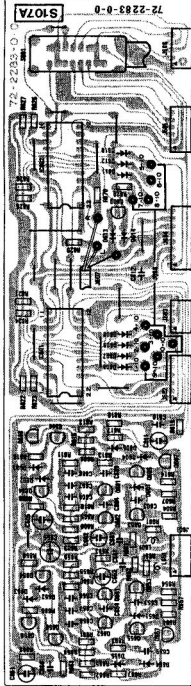

μ COM P.C.B. ASS'Y (D017A)

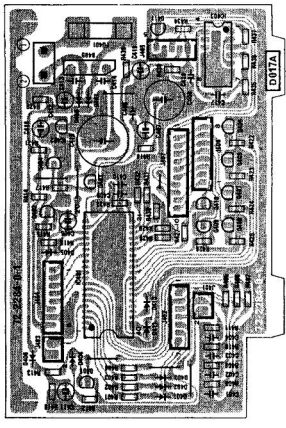

TACTILE SWITCH ASSY (S016A)

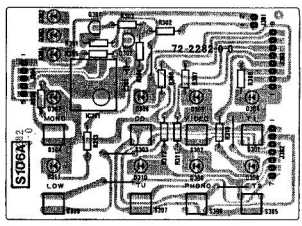

WIRING DIAGRAM

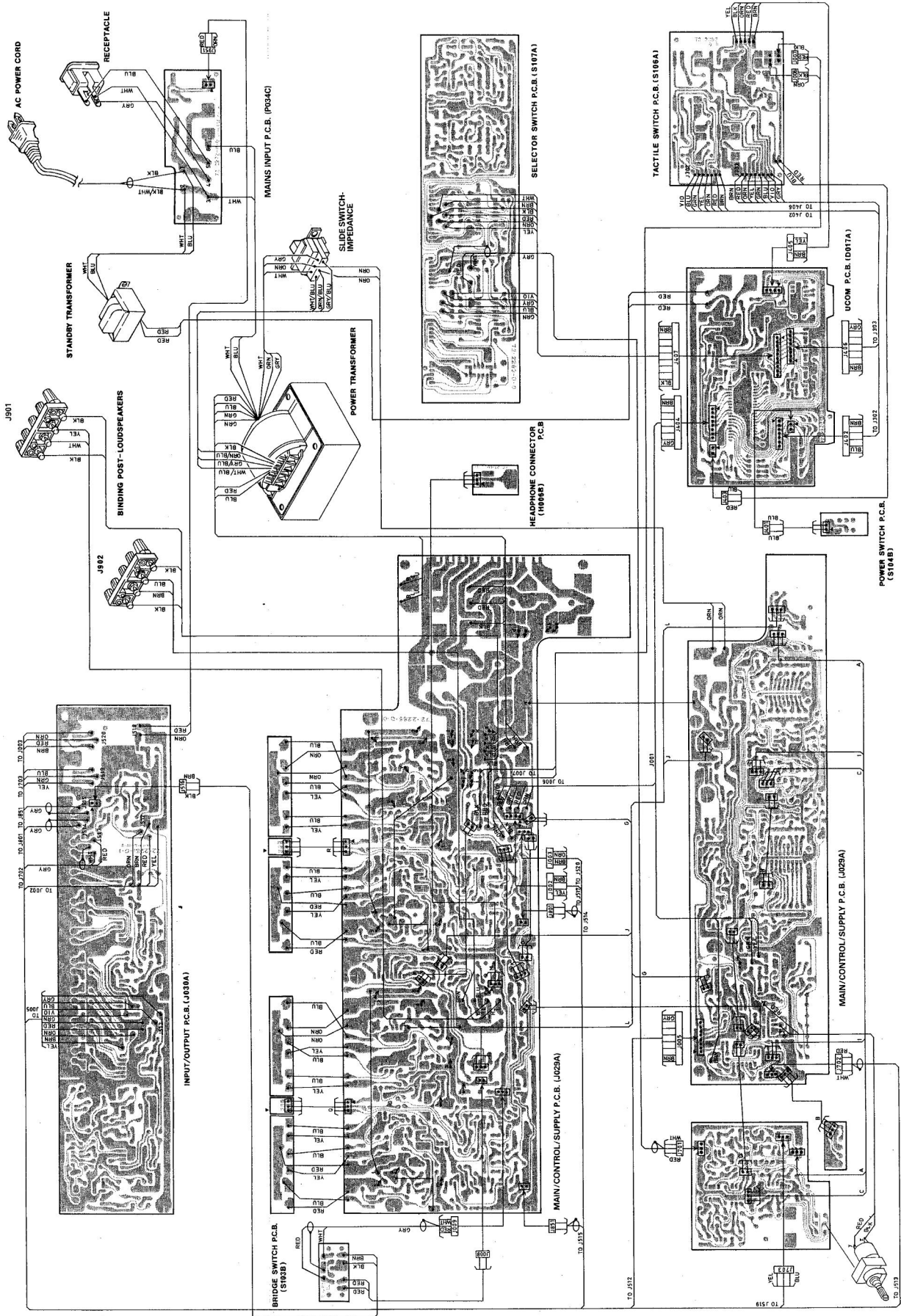

EXPLODED VIEW PARTS LIST

Index No.	Parts No.	Description
1	63-6300-0-0	Front Panel
2	62-1111-0-0	Push Button(Black)-Selectors
3	62-1111-1-0	Push Button(Green)-On/Off
4	N4957-BK	Push Button(Black)-Selectors
5	62-3480-0-0	Push Button Frame, Single
6	62-3500-0-0	Push Button Frame, Triple
7	62-2332-0-0	Lever Knob
8	62-3501-0-0	Lever Frame
9	62-2331-0-0	Rotary Knob-Tone Control
10	62-2350-0-0	Rotary Knob-Balance
11	62-2320-1-0	Volume Knob
12	63-5180-0-0	Window
13	88-171-0-0	Spring-Push Button Return
14	62-409-0-0	Sub Panel
15	92-2116-0-0	Foot
20	71-2685-0-0	Front Chassis
21	71-2682-0-0	Side Chassis (L)
22	71-2683-0-0	Side Chassis (R)
23	71-2686-0-0	Sub Chassis-Front to Rear Support
24	71-2647-1-1	Sub Chassis-Left to Right Support
25	71-2689-0-0	Sub Chassis-Left to Right Support
26	71-1966-0-0	Trans. Chassis
27	71-1968-0-0	Switch Stand
28	71-1972-0-0	Bracket-PCB Support
29	71-1935-0-0	Wire Holder
30	71-1973-0-0	Bracket-Heatsink
31	71-1967-0-0	L Bracket-PCB Support
32	71-1971-0-0	PCB Support
33	71-1970-0-0	L Bracket-PCB Support
34	92-1262-0-0	Lock Plate-Bridge Switch
35	92-1263-0-0	Lock Plate-Impedance Switch
36	71-2687-0-0	Rear Panel (A, A1)
	71-2696-0-0	Rear Panel (B, C, C1, C/S)
	71-2693-0-0	Rear Panel (B1)
37	71-3136-0-0	Top Cover
38	71-3135-0-0	Bottom Cover
39		Washer (Plain 3.5-8-0.5)
40	81-452-0-0	Slide Switch-Impedance Selector
41	81-509-0-0	Flex Linkage, Copy SW
42	HLJ0999-01-480	Locking Clip-Head Phone
43	74-3124-0-0	Heatsink, Main
44	74-3125-0-0	Heatsink, Rectifier
45	87-3242-0-0	Ground Terminal
46	62-3332-0-0	Bushing-AC Power Cord
47	23-1348-0-0	Power Transformer (UL)
	23-1348-1-0	Power Transformer (C, C1, C/S)
	23-1348-2-0	Power Transformer (B, B1)
	23-1348-3-0	Power Transformer (A)
	23-1348-4-0	Power Transformer (A1)
48	23-1352-0-0	Standby Transformer (A, A1)

EXPLODED VIEW

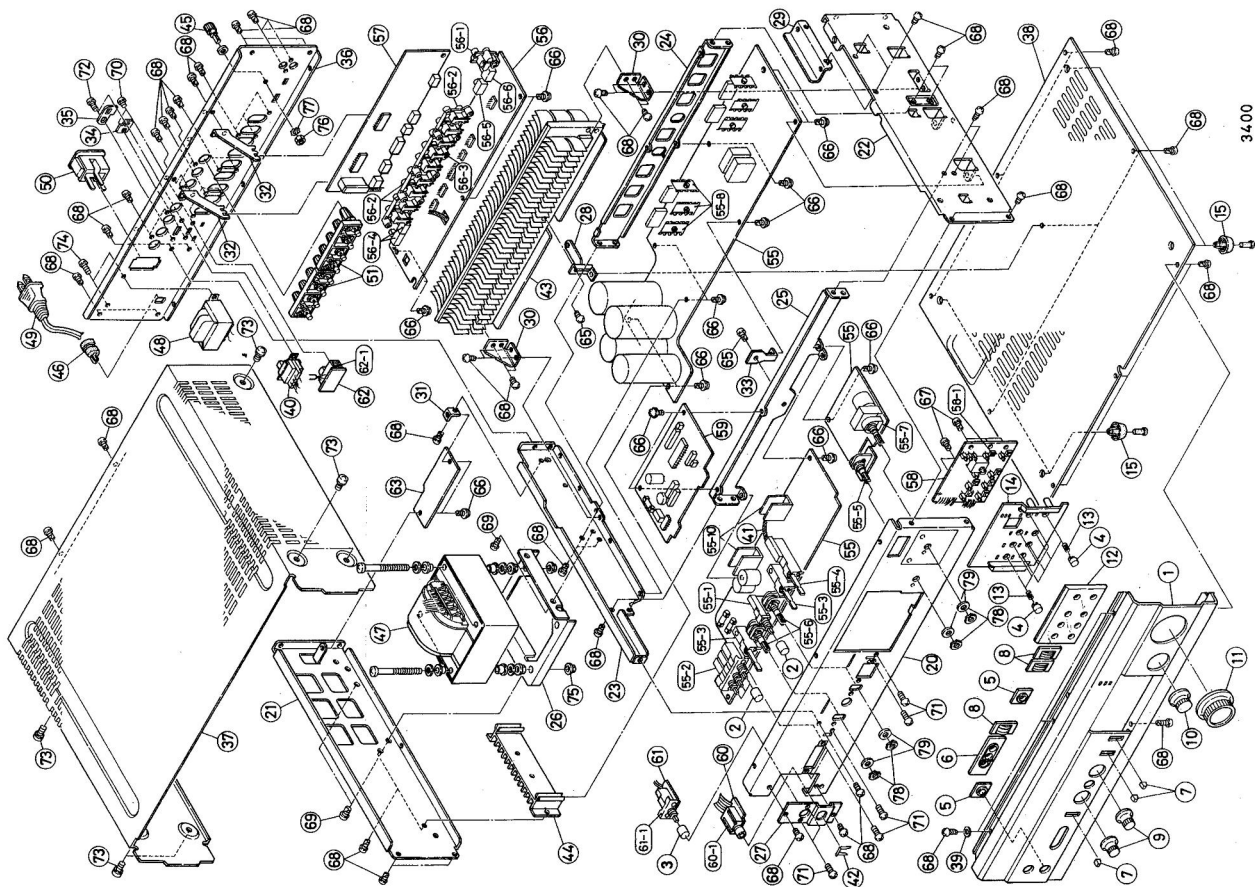

Index No.	Parts No.	Description
74		Machine Screw S (Philips Head 3 × 6 Blk)
75		Hexagon Flange Nut (M4 Cr)
76		Nut with Toothed Lock Washer (M4 Cr)
77		Washer (Plain 4-10-0.8 Ni)
78		Volume Control Nut (Hexagon 7-11-2 Ni)
79		Washer (Plain 7-12-0.5 Ni)

Index No.	Parts No.	Description
48	23-1352-1-0	Standby Transformer (C,C1,C/S)
	23-1352-2-0	Standby Transformer (B,B1)
	23-1353-0-0	Standby Transformer (UL)
49	85- 267-0-0	AC Power Cord (A,A1)
	85- 235-0-0	AC Power Cord (C,C1,C/S)
	85- 240-0-0	AC Power Cord (B)
	85- 259-0-0	AC Power Cord (B1)
50	82-2207-0-0	Receptacle (A,A1)
	82-2127-0-1	Receptacle (B,C,C1,C/S)
51	86- 216-0-0	Speaker Terminal (A,A1,B,B1,C,C1)
51	86- 217-0-0	Speaker Terminal (C/S)
55	J029A	Main/Control/Supply Pcb Assembly
55-1	81-2351-0-0	Push Switch-Bypass
55-2	81-2363-0-0	Push Switch Bank (3 Switches)
55-3	81- 317-0-0	Lever Switch-Turnover
55-4	81- 318-0-0	Lever Switch-Copy
55-5	41- 136-0-0	Rotary Potentiometer-Balance
55-6	41- 694-0-0	Rotary Potentiometer-Tone Control
55-7	41-8002-0-0	Rotary Potentiometer-Volume (Motor Driven)
55-8	74-3118-0-0	Heatsink, Driver
55-10	74- 388-0-0	Heatsink, Regulator
56	J030A	Input/Output Pcb Assembly
56-1	82-2130-0-0	RCA Connector (Single)
56-2	82-2157-0-0	RCA Connector (Double)
56-3	82-2159-0-0	RCA Connector (Triple)
56-4	81- 447-0-0	Slide Switch-Infrasonic ON/OFF
		Slide Switch-Soft Clipping ON/OFF
56-5	81- 448-0-0	Slide Switch-Phono Capacitance Selector
56-6	81- 464-0-0	Slide Switch-Phono MM/MC Selector
57	S107A	Selector Pcb Assembly
58	S106A	Tactile Switch Assembly
58-1	81-2345-0-0	Tactile Switch
59	D017A	μ Com Pcb Assembly
60	H006B	Headphone Connector Assembly
60-1	82-2185-0-0	Headphone Jack
61	S104B	Power Switch Assembly
61-1	81-2350-0-0	Push Switch
62	S103B	Bridge Switch Assembly
62-1	81- 463-0-0	Slide Switch-Bridge Mono/Stereo
63	P034C	Mains Input Pcb Assembly
65		Tapping Screw (Philips Head 3 \times 6 Cr)
66		Tapping Screw (Washer Head 3 \times 6 Cr)
67		Tapping Screw (Pan 3 \times 8 Cr)
68		Tapping Screw (Philips Head 3 \times 8 Blk)
69		Tapping Screw (Philips Head 4 \times 6 Cr)
70		Machine Screw (Philips Head 2.6 \times 4 Blk)
71		Machine Screw (Pan 3 \times 6 Cr)
72		Machine Screw (Philips Head 3 \times 8 Blk)
73		Cabinet Screw with Washer (4 \times 6 Blk)

PARTS NO.	SYMBOL NO.	DESCRIPTION
△ 10Ω, 1/4W	R003, 009.	FUSIBLE RESISTOR (ERD2FC)
△ 5.6Ω, 1/4W	R826-829, 876-879.	FUSIBLE RESISTOR (ERD2FC)
100Ω, 1/4W	R058, 066, 074, 082.	FUSIBLE RESISTOR (ERD2FCG)
41-7110	R758	VARIABLE RESISTOR (EVN-D4A, 1KΩ)
41-7116	R818, 868.	VARIABLE RESISTOR (EVN-D4A, 300Ω)
3.3Ω, 1W	R001, 002.	OXIDE METAL RESISTOR (RS1FS)
680Ω, 1W	R050, 051, 052.	OXIDE METAL RESISTOR (RS1FSM)
470Ω, 1W	R053, 054.	OXIDE METAL RESISTOR (RS1FSM)
15KΩ, 2W	R056, 065, 072, 081.	OXIDE METAL RESISTOR (RS2FSM)
8.2KΩ, 2W	R057, 064, 073, 080.	OXIDE METAL RESISTOR (RS2FSM)
3.3KΩ, 1/6W	R713, 714, 763, 764.	METAL FILM RESISTOR (RNK1/6TA21)
225Ω, 1/8W	R721, 730, 771, 780.	RESISTOR ARRAY (RRS1/8 8M)
6.2KΩ, 1W	R812, 838, 862.	OXIDE METAL RESISTOR (RS1FSM)
820Ω, 1W	R824, 874.	OXIDE METAL RESISTOR (RS1FSM)
330Ω, 1W	R825, 875.	OXIDE METAL RESISTOR (RS1FSM)
0.22+0.22Ω	R834, 835, 884, 885.	CEMENTED RESISTOR (MPC725)
2.2Ω, 2W	R836, 886.	OXIDE METAL RESISTOR (RS2FSM)
10Ω, 2W	R837, 887.	OXIDE METAL RESISTOR (RS2FSM)
△ 81-622-1-0	RY001, 002.	RELAY, MR72, SPEAKER
△ 81-628-0-0	RY003	RELAY, MR62SR, PHONES
△ RDE185A	PH001, 002.	P.T.C. (POLYSWITCH)
△ 81-7011-0-0	18-19	THERMOSTAT (90°C), UP-62
△ 5MF6	FU001, 002. (A, A1)	FUSE (125V, 6A)
EAK5	" , " (B, B1, C, C1, C/S)	FUSE (250V, T5A)
△ 5TT500	FU003, 004. (A, A1)	FUSE (250V, 0.5A)
EAWK400	" , " (B, B1, C, C1, C/S)	FUSE (250V, T400mA)
△ 5MF400	FU005 (A,A1)	FUSE (250V, 400mA)
EAWK200	" (B, B1, C, C1, C/S)	FUSE (250V, T200mA)

2) INPUT/OUTPUT PCB ASSEMBLY; J030A (EXPLODED VIEW INDEX No.56)

PARTS NO.	SYMBOL NO.	DESCRIPTION
NJM2068DD	IC501	IC, DUAL AMP
2SC3329	Q501, 551.	TRANSISTOR
2SA1015	Q502, 505, 509, 552.	TRANSISTOR
2SA1015L	Q503, 553.	TRANSISTOR
2SC2878	Q504, 554.	TRANSISTOR
2SC1815	Q506, 507, 508, 510.	TRANSISTOR
1SS178	D501, 502, 504.	DIODE
MA723	D503	DIODE
25V, 10μF	C505, 555.	ELECT. CAPACITOR, LOW LEAKAGE

3) SELECTOR PCB ASSEMBLY; S107A (EXPLODED VIEW INDEX No.57)

PARTS NO.	SYMBOL NO.	DESCRIPTION
μPC6362C	IC601, 602.	IC, FET SW
2SK163	Q601, 602, 651, 652.	TRANSISTOR
2SA970	Q603, 653.	TRANSISTOR
2SC2240	Q604, 654.	TRANSISTOR

ELECTRICAL PARTS LIST

NOTE: This is not a complete electrical parts list.

1) MAIN/CONTROL/SUPPLY PCB ASSEMBLY: J029A (EXPLODED VIEW INDEX No.55)

PARTS NO.	SYMBOL NO.	DESCRIPTION
LB1642B	IC001	IC, MOTOR DRIVE
NJM78M05FA	IC002	IC, REG, 5V, 0.5A
μ PC1237H or HA	IC003	IC, PROTECT
NJM2043DD	IC701, 702.	IC, DUAL AMP
NJM2068DD	IC703, 704, 753, 754.	IC, DUAL AMP
μ PD6360C	IC705	IC, FET SW
2SC3421	Q001	TRANSISTOR
2SC1815	Q002, 007, 010, 012-014. 703, 804, 810, 814, 854, 860, 864.	TRANSISTOR TRANSISTOR TRANSISTOR
2SA1358	Q003	TRANSISTOR
2SA1015	Q004, 009, 011, 803, 809, 853, 859.	TRANSISTOR
2SC2655	Q005	TRANSISTOR
2SA1020	Q006	TRANSISTOR
2SB1116	Q008	TRANSISTOR
2SC2240	Q015, 021, 805, 808, 815, 855, 858, 865.	TRANSISTOR
2SB985	Q016, 022.	TRANSISTOR
2SA970	Q018, 024, 806, 807, 816, 856, 857, 866.	TRANSISTOR
2SD1347	Q019, 025.	TRANSISTOR
2SK363	Q701, 702, 751, 752.	TRANSISTOR
2SC3066	Q801, 851.	TRANSISTOR
2SA1239	Q802, 852.	TRANSISTOR
2SA1370	Q811, 818, 861, 868.	TRANSISTOR
2SC3467	Q812, 817, 862, 867.	TRANSISTOR
2SD1264	Q819, 869.	TRANSISTOR
2SB940	Q820, 870.	TRANSISTOR
RS103	D003, 014.	DIODE
GZA22Z	D004	ZENER DIODE
1N4002	D015, 018-020.	DIODE
GZA30Y	D016	ZENER DIODE
GZA6.8Z	D021, 025, 029, 033.	ZENER DIODE
5BL41	D023, 027, 031, 035.	DIODE
GFB30C	D024, 028, 032, 036.	DIODE
1S1588	D753	DIODE
GZA5.1Z	D801, 851.	ZENER DIODE
GZA5.6Y	D802, 803, 852, 853.	ZENER DIODE
1SS81	D804, 805, 812, 813, 816, 807, 854, 855, 862, 863, 866, 867.	DIODE
1SS178	OTHERS	DIODE
15-147	L801, 851.	CHOKE COIL (1.6 μ H)
80V, 10000 μ F	C005, 006.	ELECT. CAPACITOR, LGS-4
100V, 10000 μ F	C007, 008.	ELECT. CAPACITOR, LGS-4
Δ 10V, 22 μ F	C035	ELECT. CAPACITOR, LOW LEAKAGE
Δ 25V, 10 μ F	C706, 756.	ELECT. CAPACITOR, LOW LEAKAGE

7) CHASSIS-MOUNTED COMPONENTS: 24821

PARTS NO.	SYMBOL NO.	DESCRIPTION
△ 2SB1155	Q017, 023.	TRANSISTOR
△ 2SD1706	Q020, 026.	TRANSISTOR
△ 2SC3423	Q813, 863.	TRANSISTOR
△ 2SC3907	Q821, 823, 871, 873.	TRANSISTOR
△ 2SA1516	Q822, 824, 872, 874.	TRANSISTOR
△ DBF60C	D001	DIODE
△ DBF40E	D002	DIODE

PARTS NO.	SYMBOL NO.	DESCRIPTION
2SA990	Q605, 607, 608, 655, 657, 658.	TRANSISTOR
2SC1843	Q606, 656.	TRANSISTOR
2SC1815	Q609	TRANSISTOR
1SS178	D601-614, 651-655.	DIODE
15-168	L601, 651.	CHOKE COIL (3.7 μ H)
1/6W, 95.3K Ω	R610, 660.	METAL FILM RESISTOR
1/6W, 7.5K Ω	R611, 661	METAL FILM RESISTOR

4) MAINS INPUT PCB ASSEMBLY; P034C (EXPLODED VIEW INDEX No.63)

PARTS NO.	SYMBOL NO.	DESCRIPTION
1N4002	D951	DIODE
△ ECK-DNS472ZV(4700p)	C951 (A, A1)	CERAMIC CAPACITOR
ECK-DNS472MEX(4700p)	" (B, B1, C, C1, C/S)	CERAMIC CAPACITOR
△ 5MF7	FU951 (A, A1)	125V, 7A
EAK3.15A	" (B, B1, C, C1, C/S)	250V, T3.15A
△ 81-625-0-0	RY951	RELAY, VS-12MB-NR, POWER

5) TACTILE SWITCH ASSEMBLY; S106A (EXPLODED VIEW INDEX No.58)

PARTS NO.	SYMBOL NO.	DESCRIPTION
SBX1483-51	IC301	IR RECEIVER
2SA1015	Q301	TRANSISTOR
2SC1815	Q302	TRANSISTOR
TLG208	D301, 304-306, 308-310.	LED (GREEN)
TLR208	D302	LED (RED)
TLO208	D303, 307, 311.	LED (ORANGE)

6) μ -COM PCB ASSEMBLY; D017A (EXPLODED VIEW INDEX No.59)

PARTS NO.	SYMBOL NO.	DESCRIPTION
μ PD7507-240	IC401	IC, μ COM
78L05A	IC402	IC, REG 5V, 0.5A
TC4013BAP	IC403	IC, LATCH
2SA1015	Q401-403.	TRANSISTOR
2SC1815	Q404-411.	TRANSISTOR
1SS178	D401-408, 410-411.	DIODE
RS103	D409	DIODE
5.5V, 0.047F	C406	MEMORY BACKUP CAPACITOR
1/6W, 82K Ω	R433	METAL FILM RESISTOR
△ 5TT400	FU401 (A, A1)	FUSE (250V, 400mA)
5ST400	" (B, B1, C, C1, C/S)	FUSE (250V, T400mA)