



SERVICE MANUAL

6155

STEREO CASSETTE DECI

SPECIFICATIONS

Speed Accuracy	±1%
Wow & Flutter	< 0.06% JIS wtd. RMS < 0.10% DIN wtd. RMS
Frequency Response, 3 dB (MPX filter off)	30 Hz - 20 kHz
MPX filter response	Flat within 1 dB to 15 kHz
Harmonic Distortion	Varies with recording level; typically < 0.3% at -10 dB.
THD at 0 dB	< 0.5% (Normal) < 1.5% (CrO ₂ , Metal)
Signal-to-Noise Ratio re 3% THD at 333 Hz, CCIR or A weighting	Dolby Dolby Dolby OFF B C 59 dB 68 dB 77 dB
Channel Separation	45 dB at 1 kHz 40 dB broadband
Erase	> 70 dB
Input Sensitivity / Impedance	110mV / 47kΩ
Maximum input level before overload	25V
Output Level at 0 dB	580 mV
Output Impedance	1000Ω
Dimensions	
Width	42 cm (16.5 in.)
Height	12 cm (4.75 in.)
Depth	25 cm (10.75 in.)
Net Weight	4.75 kg (10 lbs. 8 oz)
Shipping Weight	5.6 kg (12 lbs. 4 oz)

REAR PANEL

- 1. Input
- 2. Output
- 3. AC Power Cord

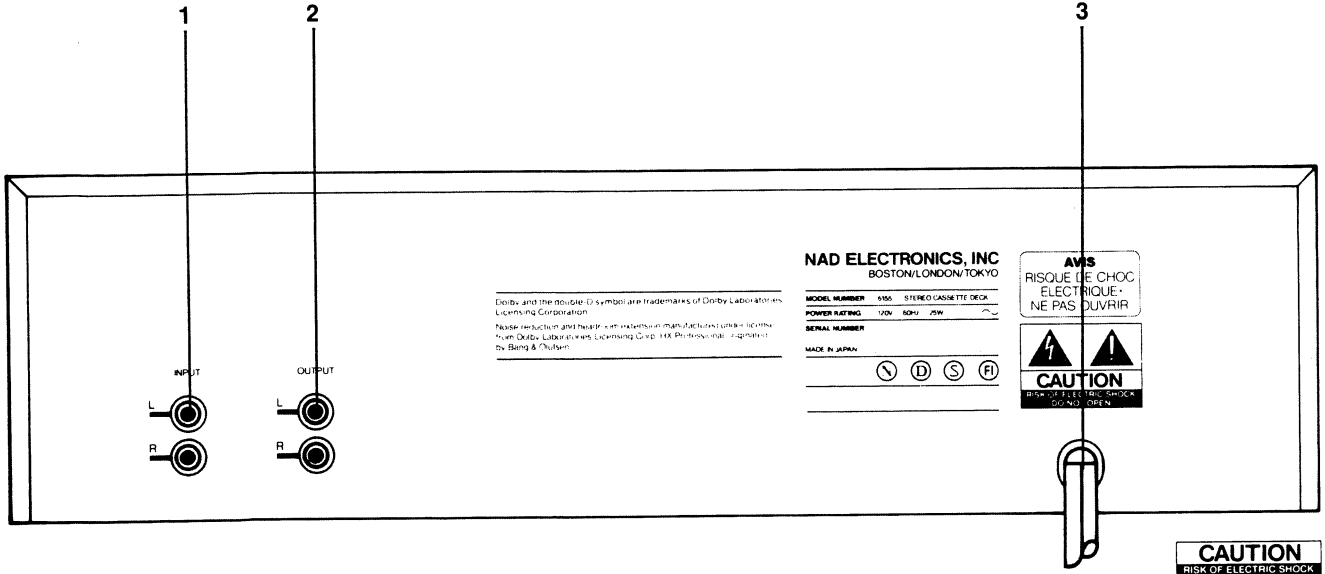

CAUTION
RISK OF ELECTRIC SHOCK
DO NOT OPEN

CAUTION TO REDUCE
THE RISK OF ELECTRIC
SHOCK, DO NOT REMOVE
COVER (OR BACK).
NO USER-SERVICEABLE
PARTS INSIDE. REFER
SERVICING TO QUALIFIED
SERVICE PERSONNEL.

FRONT PANEL

- 1. Power
- 2. Open
- 3. Cassette Compartment
- 4. Record
- 5. Play
- 6. Rewind
- 7. Fast Forward
- 8. Stop
- 9. Pause
- 10. Play Trim
- 11. Bias Trim
- 12. Tape Selector
- 13. Dolby NR
- 14. MPX Filter
- 15. Recording Level/Balance
- 16. Recording Level Display
- 17. Recording Indicator
- 18. Tape Counter

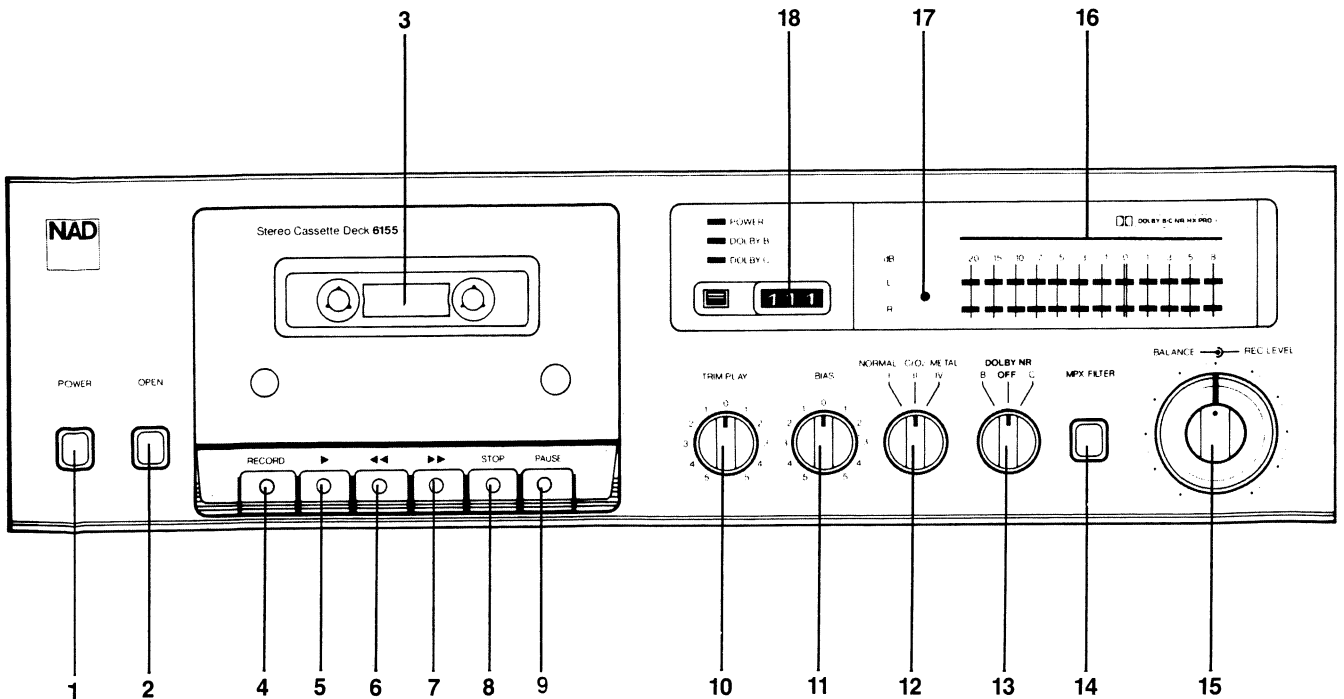

ALIGNMENT

IMPORTANT

The tape head should be correctly adjusted and the tape path (heads, tape guides, capstan and pinch roller) should be cleaned and degaussed before alignments.

The NAD 6155 is designed to work well with a variety of tapes. However, maximum performance will be obtained with the following recommended tapes:

RECOMMENDED TAPES

TYPE I	MAXELL UD XL-I or XL-I
TYPE II	MAXELL UD XL-II or XL-II
TYPE IV	MAXELL MX

Before beginning adjustments set DOLBY NR off, MPX FILTER off, PLAY TRIM and BIAS control to center position.

1. TAPE SPEED

Connect one of the outputs to a wow and flutter meter or frequency counter. Play speed test tape (TEAC MTT-111) and adjust semi-fixed resistor accessible through hole in motor casing for correct reading.

Tolerance: +/- 0.5%

2. AZIMUTH

Play azimuth tape (TEAC MTT-114) and observe outputs on VTVMs or oscilloscope. Rotate azimuth adjust screw to maximum output. Reseal adjustment screw with nail polish or similar (do not use glue).

3. PLAYBACK LEVEL

Connect outputs to VTVMs and/or oscilloscope with no load connected. Play Dolby level tape 200 nWb/m (TEAC MTT-150) and adjust VR101 left channel and VR201 right channel for 580mV at outputs.

Tolerance: +/- 5mV

4. LED DISPLAY AND PLAYBACK

Play Dolby level tape (TEAC MTT-150) and adjust VR107 left channel and VR207 right channel for 0dB reading on the meters. LED should just turn on.

5. BIAS OSCILLATOR FREQUENCY

Adjustments are not normally required. Insert TYPE I tape and engage RECORD and PAUSE mode. Connect frequency counter to resistor R301 and adjust L301 to 105kHz.

Tolerance: +/- 3kHz

6. BIAS TRANSFORMER ADJUSTMENTS

Turn tape selector to TYPE IV position, engage RECORD and PAUSE. Connect oscilloscope to base Q112 and adjust L107 left channel for minimum. Connect oscilloscope to base Q212 and adjust L207 right channel for minimum.

7. BIAS TRAP

Adjustments are not normally required. Engage RECORD and PAUSE. Connect VTVM or oscilloscope to TP14 left channel and adjust L106 to minimum. Connect VTVM or oscilloscope to TP24 right channel and adjust L206 to minimum.

Tolerance: Less than 40mV RMS.

8. INITIAL CHECKING AND ADJUSTMENT OF BIAS

Engage RECORD and PAUSE. Connect VTVM between TP11 and TP12 left channel and TP21 and TP22 right channel. Connect and adjust as follows:

<u>TAPE TYPE</u>	<u>TAPE SELECTOR</u>	<u>ADJUSTMENT CONTROL</u>	<u>ADJUST FOR:</u>
TYPE I	TYPE I	VR110, VR210	2mV RMS
TYPE II	TYPE II	VR109, VR209	3mV RMS
TYPE IV	TYPE IV	VR108, VR208	4mV RMS

Be aware that these levels are approximate. If measured level is close to desired level, do not adjust.

9. RECORD LEVEL

Connect audio signal generator to both inputs and VTVMs and/or oscilloscope to outputs. Use TYPE I tape and switch selector to TYPE I. Engage RECORD and PAUSE. Turn input level to maximum. Set audio signal generator to 400Hz and adjust output level so that output from cassette deck reads approximately -22dB from 580mV (-25dBm) on VTVMs. Reset counter to 0 and release PAUSE to record onto tape. Record for approximately 5 seconds, rewind to 0 on counter and play back while observing the VTVMs. The level should be the same as when the unit was in record. Adjust VR102 left channel and VR202 right channel if necessary and repeat the record/play procedure until the readings are the same.

Tolerance: +/- 0.5dB from record level. Less than 0.5dB difference between the channels.

10. FREQUENCY RESPONSE

Adjust audio generator frequency to 1200Hz without changing output level. Reset counter to 0 and start recording. After 5 seconds change audio generator frequency to 12000Hz (do not stop machine) and continue recording for another 5 seconds. Stop and rewind to 0 on the counter. Play back while observing VTVMs. There should be no level difference between the 1200Hz and 12000Hz tones when played back. If 12000Hz is different in level from 1200Hz, adjust VR110 left channel and VR210 right channel and repeat the record/playback procedure until both levels are the same.

Tolerance: +/- 0.5dB

Warning: Greater tolerance will grossly affect the Dolby tracking, especially the Dolby C tracking.

11. PEAKING CIRCUIT

Adjust audio signal generator to 18kHz while maintaining the same output level. Record and play back the 18kHz tone and adjust VR103 left channel and VR203 right channel so that 18kHz playback is the same level as the 1200Hz and 12000Hz signals.

Tolerance: +/- 1dB

Warning : If the R/P head is worn, the tape may not have adequate contact with the head, resulting in severe dropouts. A worn head will make this adjustment very difficult or impossible. Do not try to adjust a worn R/P head. Leave VR103, VR203 in the factory preset condition, or if they have already been adjusted, readjust them to their approximate midposition.

12. ADJUST RECORD METER

Adjust audio signal generator to 400Hz and output to 580mV on the VTVMs. Engage RECORD and PAUSE and adjust VR106 left channel and VR206 right channel for the 0dB LEDs to barely turn on.

13. CHECK THD

Connect THD meter to left channel. Reset counter to 0 and release PAUSE to record the 400Hz signal on the tape. Record for 10-20 seconds, rewind to 0 on the counter and play back while measuring distortion. Connect THD meter to right channel and repeat the recording/playback process while measuring the distortion.

Tolerance: Less than 2%

14. FREQUENCY RESPONSE TYPE II AND TYPE IV TAPES

Insert a TYPE II tape and switch selector to the TYPE II position. Engage RECORD and PAUSE and adjust audio generator frequency to 1200Hz, and the generator output level so that the VTVMs read approximately -22dB from Dolby level 580mV (-25dBm). Repeat the procedure as described in step 10 adjusting VR109 left channel and VR209 right channel. Continue with adjustment as described in step 11 using VR104 left channel and VR204 right channel. Insert a TYPE IV tape and switch selector to TYPE IV position. Repeat the procedure as described in step 10 and 11 using VR108 left and VR208 right channel for 12000Hz adjustment and VR105 left channel and VR205 right channel for the peaking circuit adjustment.

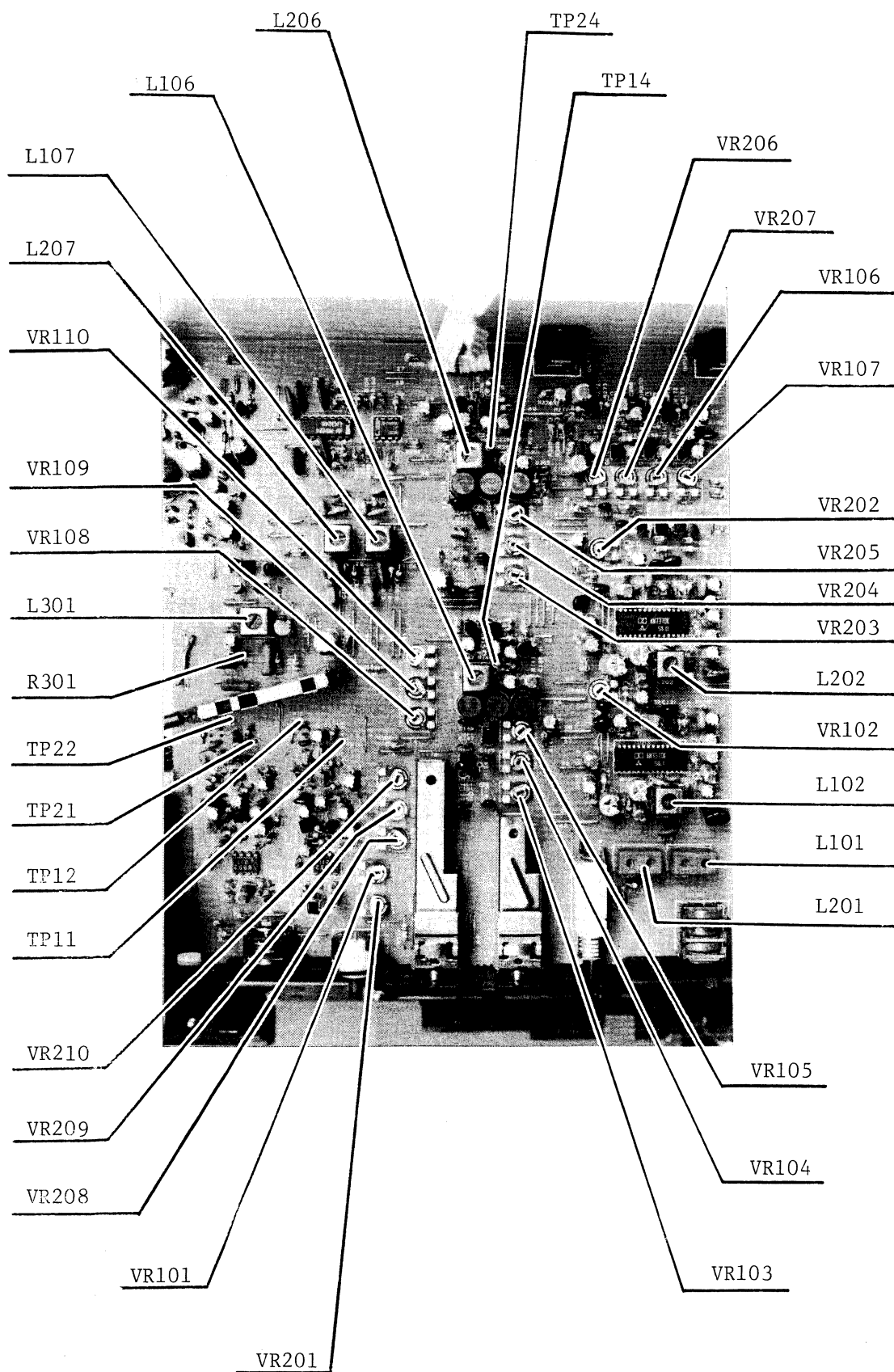

WIRING DIAGRAM

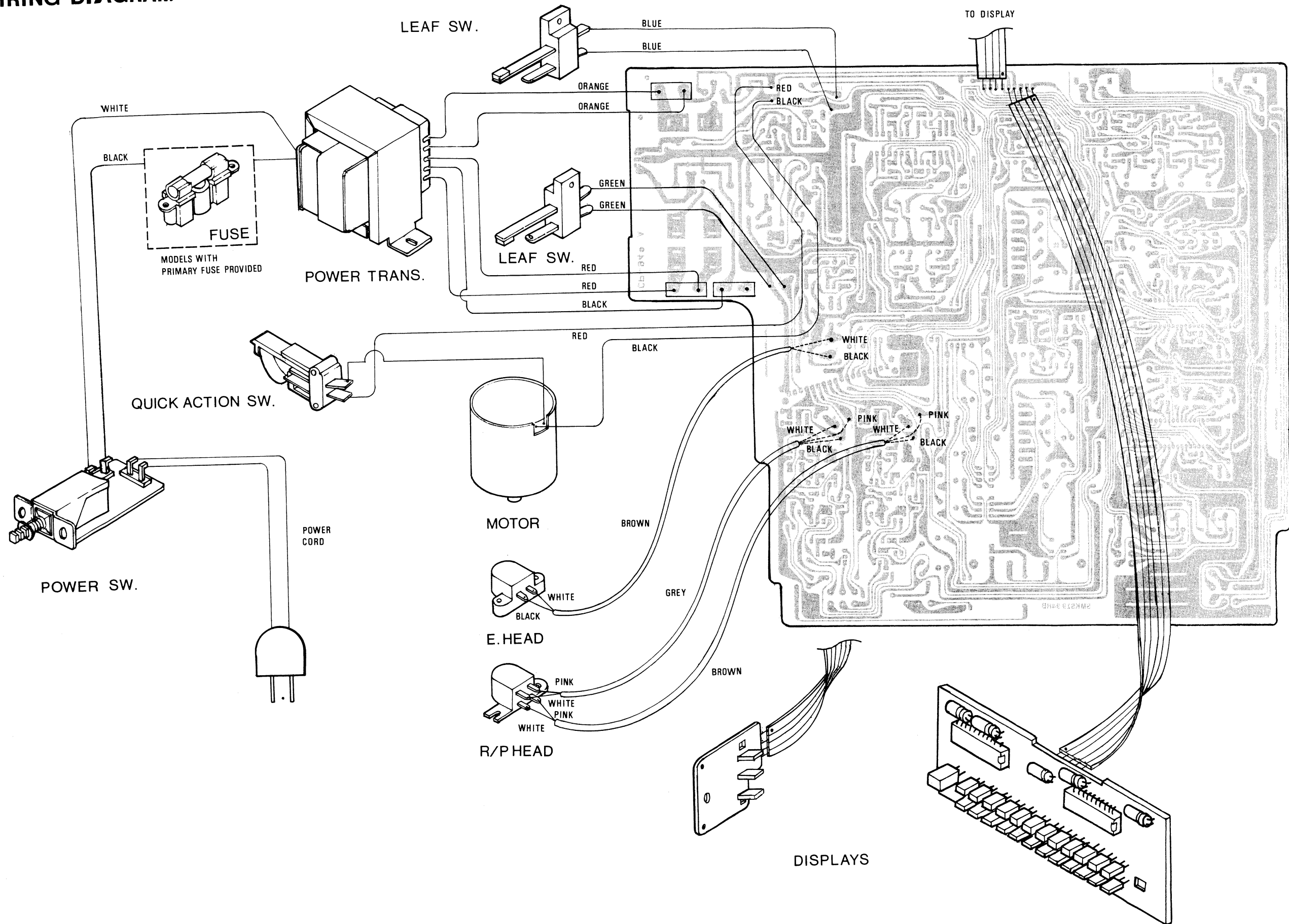

MAIN PCB

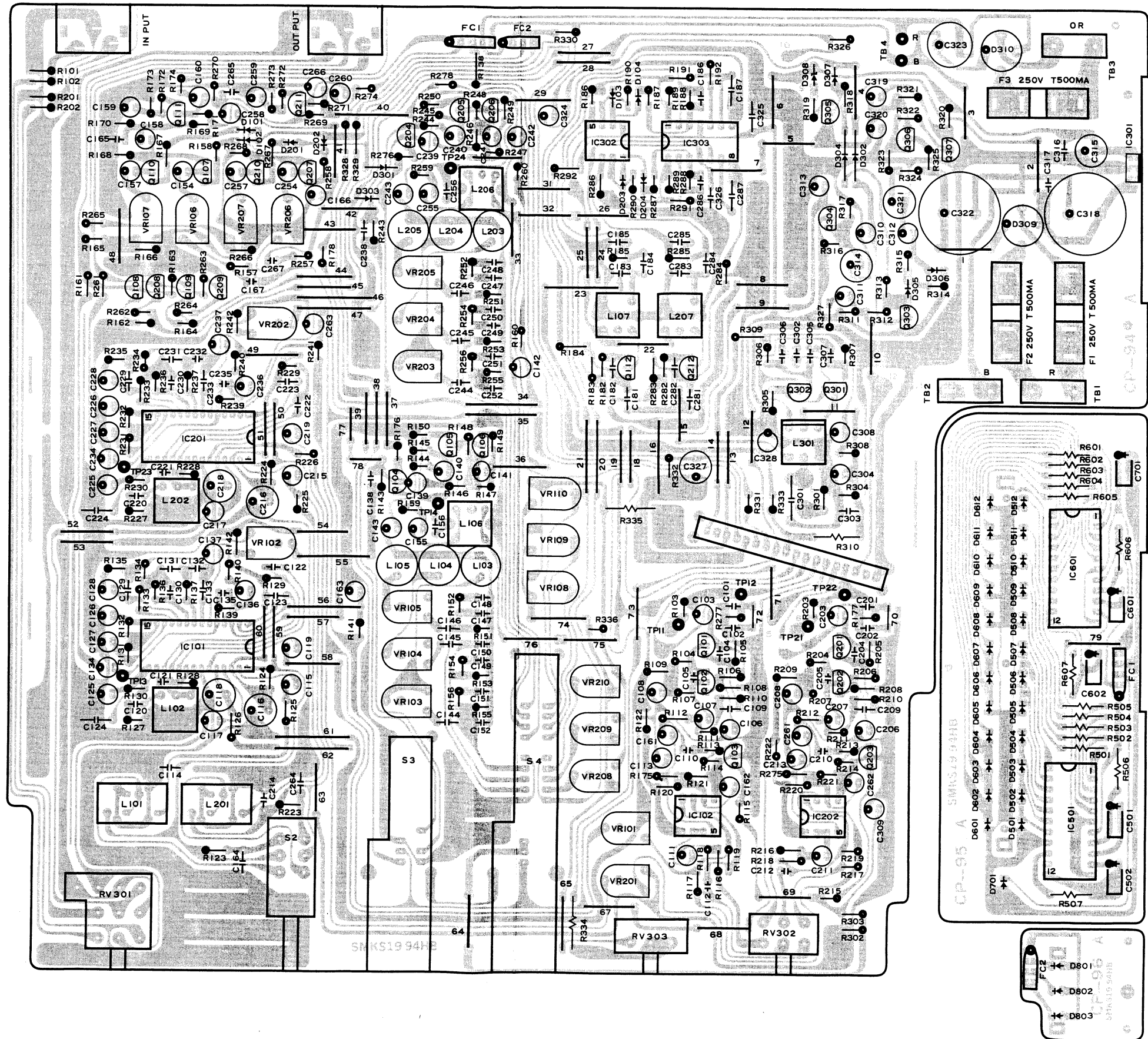

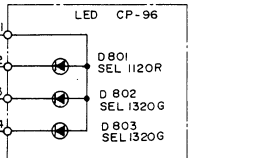
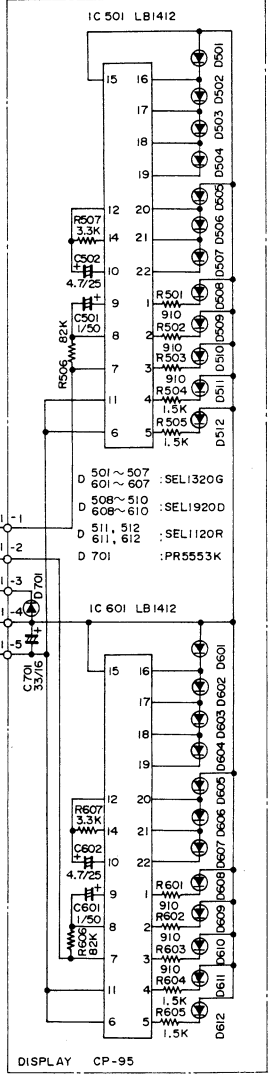
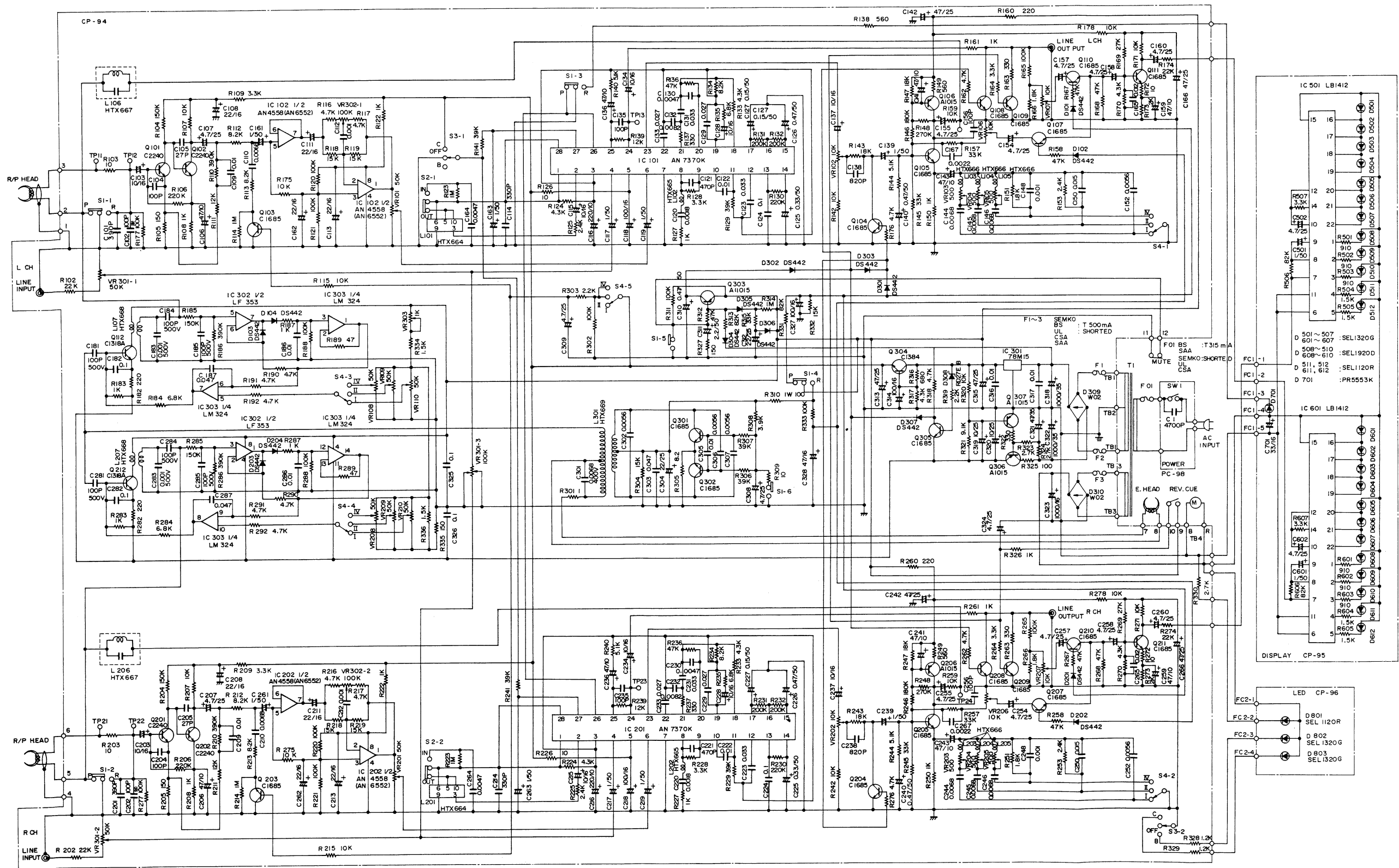

- | | | | | |
|--------|------------------------|------------|--------------------|---|
| SWITCH | | VOLUME | | * C 102 CAPACITOR FOR ADJUSTMENT
202 |
| S1-1~6 | REC / PB (P.B) | RV301-1~3 | REC LEVEL, BALANCE | |
| S2-1~2 | MPX FILTER (OUT) | VR 302-1~2 | PLAY TRIM | |
| S3-1~2 | DOLBY NR (OFF) | VR 303 | BIAS | |
| S4-1~5 | TAPE SELECTOR (TYPE I) | | | |

PARTS LIST

Ref. No.	Description	Type No.
P 1	Top Cover	SN-210028B
P 2	Transport Mechanism Cover	SN-230379B
P 3	Power Cord	UL, CSA (120V) SDS-20 SEMKO (220V) SP-204 BS (240V) BS SAA (240V) SAA
P 4	Power Switch	ESB-8213V
P 5	Eject Knob	SN-23038E
P 6	Key Knob, RECORD Key Knob, PAUSE Key Knob, STOP PLAY FF REW	SN-241181B (RED) SN-241181B (BROWN) SN-241181B (BLACK)
P 7	Transport Mechanism DC Motor R/P Head Erase Head	KBD-5101F MMI-6A2LK AUDCASM RP42-119 H4322-0201
P 8	LED Display (Level Meter)	
P 9	Tape Counter Belt	SN-241206
P10	Tape Counter	T3SG100-065B1-839
P11	Counter Intermediate Pulley	215YT2222-00
P12	Dial String	L = 320 0.7 ϕ
P13	Main P.C.B.	CP-94 (with 95A, 96A)
P14	Slide Switch For Recording	00620594
P15	2P RCA Socket	YKC21-0061
P16	Cassette Window	SN-241182B
P17	Rotary Volume, PLAY TRIM	V113G-5193
P18	Rotary Volume, BIAS	113-9252
P19	Rotary Slide Switch, TAPE SELECT.	SRSY1-6-3K15 - 7x6N
P20	Rotary Slide Switch, DOLBY MODE	SRSY1-2-3K15 - 7x6N
P21	Push Switch, MPX-FILTER	PSC 00-C2L
P22	Rotary Volume, REC LEVEL	R113D-B4049
P23	Sub-Front Panel	SN-210030E
P24	LED Display (Power, Dolby mode)	
P25	LED Window	SN-230382C
P26	Power Transformer	UL, CSA (120V) PTX-263F SEMKO (220V) PTX-263E BS, SAA (240V) PTX-263BS
P27	Power Switch Knob	SN-230343B KG-10F (GREEN)
P28	MPX Filter Knob	SN-230343B KB-10F (BLACK)
P29	Control Knob	62-2317-0-0
P30	P.C.B. Spacer	SN-241191B

Ref. No.	Description	Type No.
P31	Cassette Cushion	SN-241198B
P32	Frame Cushion	SN-240841A
P33	Double Round Knob, BALANCE	62-2318-0-0
P34	Double Round Knob, REC LEVEL	62-2319-0-0
P35	Cassette Door	SN-230381D
P36	Cord Stopper	UL, CSA SR-3P-4 SEMKO, BS, SAA W-5116
P37	Chassis with Rear Panel	UL, CSA SN-210029C (BE) SEMKO SN-210029C (BF) BS, SAA SN-210029C (BG)
P38	Adjuster	SN-240899B
P39	Bottom Plate	SN-230377B
P40	Rubber Foot	2299-1-9-086-02
P41	Aluminum Front Panel	SN-220301C
S 1	S tight pan screw	2.6 x 4
S 2	S tight binding screw	4.0 x 6
S 3	B tight binding screw	4.0 x 8
S 4	S tight pan screw	3.0 x 12
S 5	B tight binding screw	3.0 x 8
S 6	Pan screw	M3 x 6
S 7	B tight pan screw	3.0 x 8
S 8	B tight binding screw	2.6 x 8
S 9	Hexagon socket head tap bolt	M3 x 5
S10	S tight pan screw	3.0 x 5
S11	Pan screw	M3 x 45
S12	Pan Screw w/sprint washer	M4 x 10
S13	B tight pan screw	3.0 x 6
S14	S tight pan screw	3.0 x 5
S15	B tight flat screw	3.0 x 8
S16	Spring lock washer for S4	
S17	Hexagon nut for S4	
	Time Lag Fuse (Primary)	250V T 315mA (BS/SAA)
	Time Lag Fuse (Secondary)	250V T 500mA (BS/SAA/SEMKO)

Major Electrical Parts

Description	Type No.	Description	Type No.
DISPLAY SECTION			
PCBs for Display	CP-95A/96A	LED	SEL 1920D
IC for Display	LB 1412	LED	SEL 1120R
LED	SEL 1320G	LED	PR 5553K
MAIN CIRCUIT			
PCB	CP-94A	Silicon Diode	DS 442
IC for Dolby	AN7370K	Zener Diode	RD27EB2 or 3
IC for HX-PRO	AN4558 or AN6552	Silicon Stuck	W02RL
IC for HX-PRO	LF353N	MPX Filter	HTX 664
IC for HX-PRO	LM324N	Filter Coil	HTX 665
IC, Regulator	AN78M15	Peaking Coil	HTX 666
Transistor	2SC2240BL	Trap Coil	HTX 667
Transistor	2SC1685Q	Bias Coil	HTX 668
Transistor	2SA1015Y	OSC Coil	HTX 669
Transistor	2SC1318AR	Semi-Fixed Resist.	EVN-K4A A00B54(50K)
Transistor	2SC1384R	Semi-Fixed Resist.	EVN-K4A A00B14(10K)
		Semi-Fixed Resist.	EVN-K4A A00B52(500)

Other capacitors and resistors : cf. Circuit Diagrams

Note :
 UL for USA market
 CSA for Canadian market
 BS for UK market
 SAA for Australian market
 SEMKO for Europe and others

EXPLODED VIEW

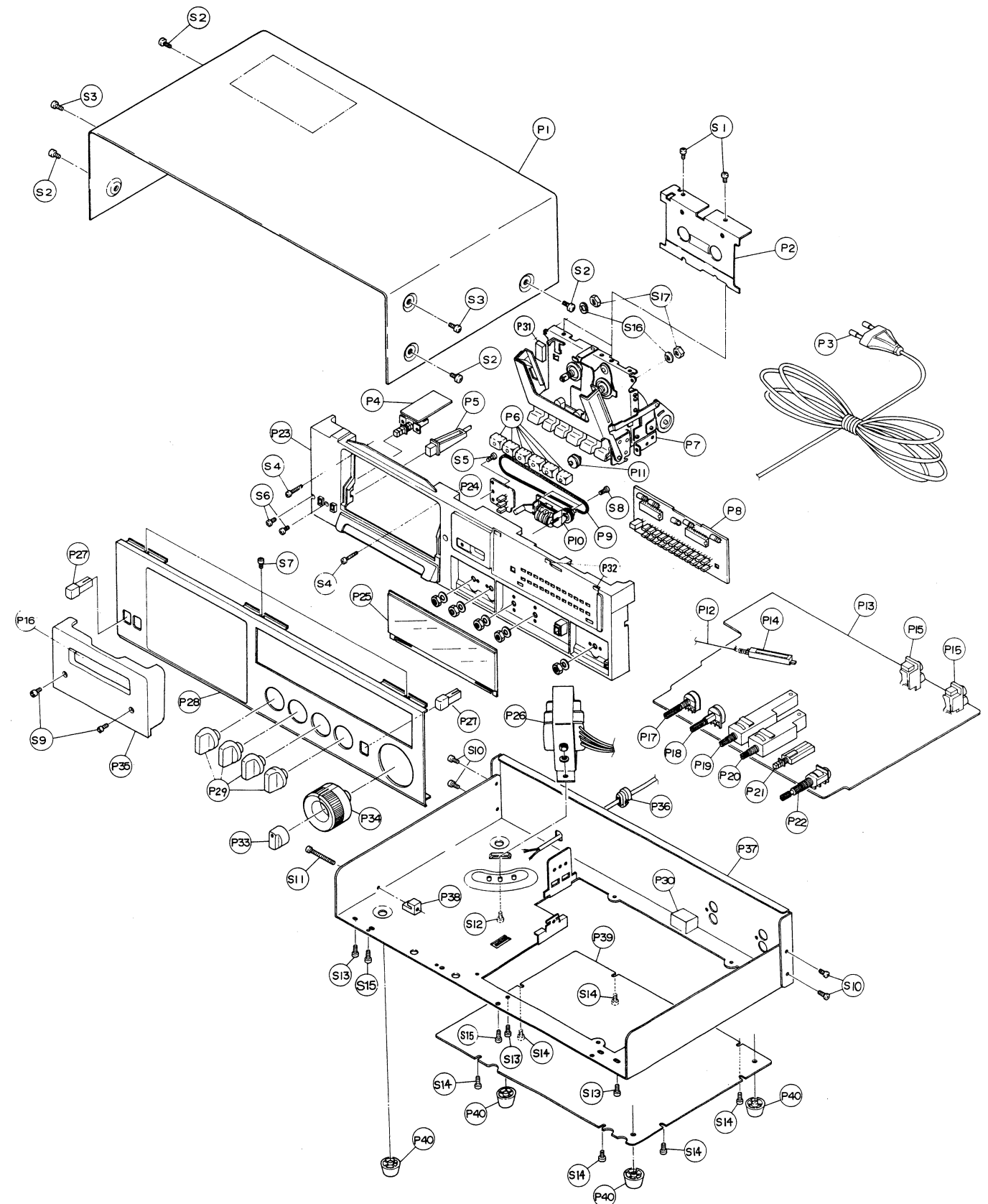

TRANSPORT MECHANISM MODEL KBD-5101F

Ref. No.	Parts No.	Description	Qty/unit
1	KB 1204	Chassis ass'y	1
2	KD 1012	Rec Lever	1
3	KD 1011	Play Lever	1
4	KD 1026	Rew Lever ass'y	1
5	KD 1014	FF Lever	1
6	KD 1008	Stop Lever	1
7	KD 1027	Pause Lever ass'y	1
8	KD 6001	Rec Lever Spring	1
9	KD 6019	Lever Spring (B)	1
10	KD 6035	Lever Spring (C)	1
11	KD 6007	Pause Lever Spring	1
12	KD 3014	Rec Lever (B)	1
13	KD 3063	Shift Arm (A)	1
14	KD 3158	Shift Arm (B) ass'y	1
15	KC 3015	Gear (A)	1
16	KC 3011	Gear (B)	1
17	KD 3084	Gear Lock Arm (A)	1
18	KD 3009	Gear Lock Arm (B)	1
19	KD 6006	Shift Arm (A) Spring	1
20	KD 6011	Lock Arm (B) Spring	1
21	KD 1013	Brake Lever	1
22	KD 4001	Brake Shoe	2
23	KD 3048	FF Idler Arm ass'y	1
24	KD 3026	FF Gear	1
25	KD 6045	FF Gear Spring	1
26	KC 3142	Reel Base ass'y	1
27	94019001	Quick Action Switch	1
28	KD 3019	Auto Gear	1
29	KD 3059	Sensor Arm	1
30	KD 3099	Auto Arm	1
31	KD 6048	Pause Lever Spring	1
32	KD 6068	Auto Arm Spring	1
33	KD 3038	Auto Clutch ass'y	1
34	KD 6043	Tension Spring	1
35	KD 3052	Bush	2
36	KD 3062	Play Arm	1
37	KD 3138	Play Idler	1
38	KD 6023	Play Arm Spring	1
39	KD 3033	T Reel ass'y	1
40	KD 3032	S Reel ass'y	1
41	KD 6049	Back Tension Spring	1
42	KD 3035	FR Pulley Arm ass'y (D)	1
43	KD 3037	Rew Arm	1
44	KD 6028	FR Pulley Arm Spring (A)	1
45	KD 6029	FR Pulley Arm Spring (B)	1
46	KD 6012	Shift Arm (B) Spring	1
47	KD 1005	Auto Lock Arm	1
48	KD 6065	Auto Lock Arm Spring	1
49	KD 1004	FR Lock Arm (N)	1
50	KC 1110	Head Chassis	1
51	KC 3001	Head Base	1
52	KD 6041	Head Base Spring	1

Ref. No.	Parts No.	Description	Qty/unit
53	KD 6009	Head Spring	1
54	G 46084	Head Spring	1
55	KD 1003	Head Chassis Spring	1
56	KC 3039	Cassette Guide (R)	1
57	KC 3040	Cassette Guide (L)	1
58	KD 6026	FR Lock Arm Spring	1
59	KD 6021	Brake Spring	1
60	KC 3103	Pause Cam	1
61	KD 6057	Pause Cam Spring	1
62	KD 3046	Pinch Roller Arm ass'y	1
63	KD 6002	Pinch Roller Spring	1
64	KD 1025	Pack Spring (F)	1
65	KD 3007	Rec Sensor	1
66	KD 6013	Rec Sensor Spring	1
67	KC 1030	Motor Bracket (D)	1
68	KD 2028	Motor Pulley (C)	1
69	KD 5002	Flywheel	1
70	KD 4004	Belt	1
71	KD 4007	Belt	1
72	KD 4008	Belt, Drive	1
73	G 43076	Capstan Screw	1
74	KC 1207	Button Holder	1
75	KD 2076	Button Shaft	1
76	SN-230375A	Button Lever (Black)	6
77	KC 3044	Lock Cam (F)	1
78	KD 6025	Lock Cam Spring	1
79	KD 1038	Rec Arm	1
80	KC 1227	Cassette Case	1
81	KD 3049	Cassette Pocket (L)	1
82	KD 3050	Cassette Pocket (R)	1
83	KD 1041	Damper Link ass'y	1
84	KD 2034	Case Collar	1
85	KD 1032	Damper Bracket	1
86	JD 3089	Damper ass'y	1
87	KD 1042	Case Bracket ass'y	1
88	KD 3051	Case Lock Arm	1
89	KCS 1265	Eject Lever	1
90	JD 6015	Pause Lever Spring	1
91	KD 6022	Case Spring	1

Ref.	Description	Ref.	Description
93	Steel Ball SB-2	110	Tap Tight Screw 2.6 x 4
94	Polyslider washer	111	Tap Tight Screw 2.6 x 6
95	Polyslider washer	112	Bind Tap Tight Screw (BL) 2.6x8
96	Polyslider washer	113	Tap Tight Screw 2.6 x 8
98	Reel washer KD8016	114	Tapping Screw 2 x 6
99	Nylon washer	115	Tapping Screw 2 x 12
100	Nylon washer KD8009	116	Tapping Screw 2.6 x 6
101	Plain washer (S) 2Ø	117	E Ring 2Ø
102	Plain washer (L) 3Ø	118	E Ring 2.5Ø
103	Binding Screw 2 x 8	119	E Ring 4Ø
104	Binding Screw 2 x 9.5	120	Pan Screw 2.6 x 3
105	Washer Head Screw 2x9	125	Leaf Switch LSB-1123
109	Tap Tight Screw 2.6 x 4	126	Leaf Switch LSA-1123-4

MECHANISM EXPLODED VIEW

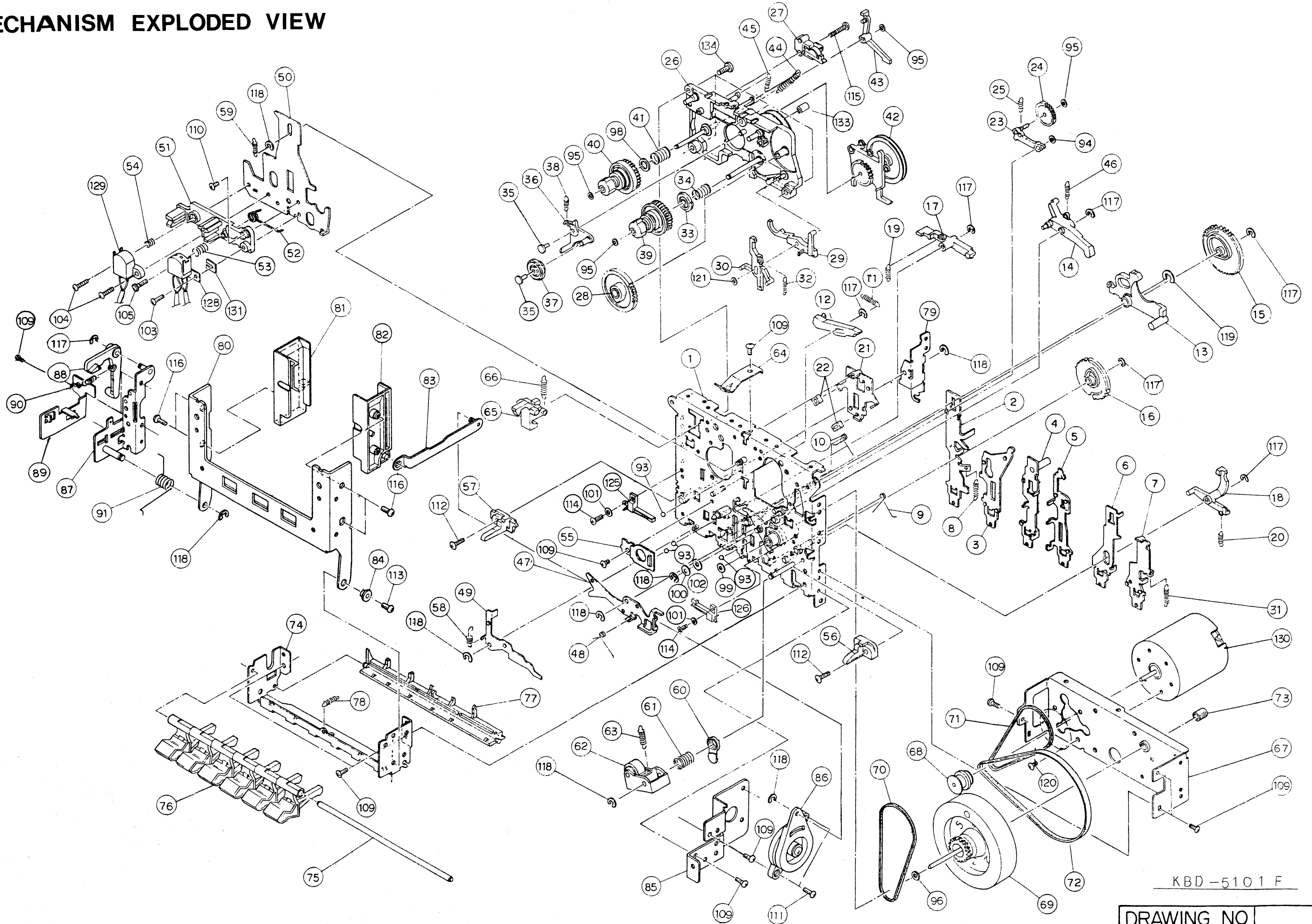

KBD-5101 F

DRAWING NO